

# MAN GROUP



Engine and Transmission Group .....	: 2 - 45
Steering Group .....	: 46 - 52
Suspension Group .....	: 53 - 113
Cab Group .....	: 114 - 142
Axle / Differential ve Shaft Group.....	: 143 - 162
Clutch and Brake Group.....	: 163 - 180

	ŞEM NO.	REF. NO.	Type / Model
		7330	81962100242
81962100227			19.281
<b>Description</b>			20.240
Engine Mounting			26.240
			26.280
			26.281
			26.321
			30.240
			32.231

M 16x1.5

	ŞEM NO.	REF. NO.	Type / Model
		7340	81962100142
81962100141			
81962100106			
<b>Description</b>			
Engine Mounting			

M 16x1.5

	ŞEM NO.	REF. NO.	Type / Model
		7350	81962100238
81962100198			16.168
<b>Description</b>			22.240
Engine Mounting			26.240
			30.240
			32.240

M 16x1.5

	ŞEM NO.	REF. NO.	Type / Model
		7370	81962100245
81962100139			NG232
<b>Description</b>			SG220
Engine Mounting			SG242
			SL200
			SR240
			Sr280

M 14x1.5







	ŞEM NO.	REF. NO.	Type / Model
		7380	81962100302
81962100193			NL 232
<b>Description</b>			SL 200
Engine Mounting			SR 240
			SG 220
			SR 280R
			SL 202

M14x1.5

	ŞEM NO.	REF. NO.	Type / Model
		7390	81962100293
81962100034			SG 220
<b>Description</b>			SG 242
Engine Mounting			SL 200
			SR 240
			SR 280

M 14x1.5

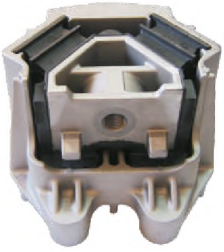

<b>Type / Model</b>	<b>REF. NO.</b>	<b>SEM NO.</b>	
	81962100326	8227	
		<b>Description</b>	
		Engine Mounting	M 14x1,5
<b>Type / Model</b>	<b>REF. NO.</b>	<b>SEM NO.</b>	
	81962100323	8228	
		<b>Description</b>	
		Engine Mounting	M 14x1,5
<b>Type / Model</b>	<b>REF. NO.</b>	<b>SEM NO.</b>	
	81962100381	8229	
		<b>Description</b>	
		Engine Mounting	M 14x1,5
<b>Type / Model</b>	<b>REF. NO.</b>	<b>SEM NO.</b>	
	81962100553	7854	
	81962100525		
	81962100574		
		<b>Description</b>	
		Engine Mounting	
<b>Type / Model</b>	<b>REF. NO.</b>	<b>SEM NO.</b>	
	81962106072	7855	
	81962106065		
	81962106071		
		<b>Description</b>	
		Engine Mounting	
<b>Type / Model</b>	<b>REF. NO.</b>	<b>SEM NO.</b>	
	81962100597	7890	
	81962100592		
	81962100572		
		<b>Description</b>	
		Engine Mounting	

	SEM NO.	REF. NO.	Type / Model
	7891	81962100571 81962100577 81962100588	
	<b>Description</b> Engine Mounting		

	SEM NO.	REF. NO.	Type / Model
	7932	81415066195	
	<b>Description</b> Engine Mounting		

	SEM NO.	REF. NO.	Type / Model
	9514	81962100620	
	<b>Description</b> Engine Mounting		

	SEM NO.	REF. NO.	Type / Model
	9515	81962100593	
	<b>Description</b> Engine Mounting		

h=148 M18x1,5

	SEM NO.	REF. NO.	Type / Model
	10234	81962100405	
	<b>Description</b> Engine Mounting		

60 Shore A

	SEM NO.	REF. NO.	Type / Model
	10235	81962100406	
	<b>Description</b> Engine Mounting		

65 Shore A

<b>Type / Model</b>	<b>REF. NO.</b>	<b>SEM NO.</b>	
	81962100011 81962100022	<b>7237</b>	
			<p><b>Description</b> Engine Mounting - Front</p> <p>D=Ø85 h=60 M12</p>
<b>Type / Model</b>	<b>REF. NO.</b>	<b>SEM NO.</b>	
520 590 16.240 19.240	81962100023 81962100167 81962100179	<b>7239</b>	
			<p><b>Description</b> Engine Mounting</p> <p>M 16x1,5</p>
<b>Type / Model</b>	<b>REF. NO.</b>	<b>SEM NO.</b>	
19.190 20.190 22.190	83962100001	<b>7320</b>	
			<p><b>Description</b> Engine Mounting</p> <p>M 16x1,5</p>
<b>Type / Model</b>	<b>REF. NO.</b>	<b>SEM NO.</b>	
12.153 L 1232 SR 232	81415060096	<b>7626</b>	
			<p><b>Description</b> Engine Mounting</p>
<b>Type / Model</b>	<b>REF. NO.</b>	<b>SEM NO.</b>	
	81962100440 81962100420	<b>7693</b>	
			<p><b>Description</b> Engine Mounting</p>
<b>Type / Model</b>	<b>REF. NO.</b>	<b>SEM NO.</b>	
	81962100441 81962100421	<b>7694</b>	
			<p><b>Description</b> Engine Mounting</p>

	SEM NO.	REF. NO.	Type / Model
	7487	81960200205 83962100510 81960200235	26.230 26.270 SL 232
<b>Description</b> Engine Mounting			
D=Ø72 h=84			

	SEM NO.	REF. NO.	Type / Model
	7488	81960200239 83962100509 81962100202	26.230 26.270
<b>Description</b> Engine Mounting			
D=Ø59 h=56.5			

	SEM NO.	REF. NO.	Type / Model
	7539	81960200340 81960200372	19.240 19.372 19.422 24.242 26.242 33.272 33.372 41.422 S2000
<b>Description</b> Engine Mounting			
D=Ø 70 h=72			

	SEM NO.	REF. NO.	Type / Model
	7540	81960200341 81960200385 81960200418 81960200373 81960200408	19.242 19.372 19.422 19.462 24.242 33.272 33.372 41.322 S 2000
<b>Description</b> Engine Mounting			
D=Ø70 h=85			

	SEM NO.	REF. NO.	Type / Model
	7666	81960200382 88962100004	
<b>Description</b> Engine Mounting			
D=Ø 72 h= 84 SHORE A55			

	SEM NO.	REF. NO.	Type / Model
	7667	81960200403 81960200391	
<b>Description</b> Engine Mounting			
D=Ø 72 h= 84 SHORE A45			

<b>Type / Model</b>	<b>REF. NO.</b>	<b>SEM NO.</b>	
	81960200386	7677	
		<b>Description</b>	
		Engine Mounting	
			D=Ø70 h=72 SHORE A55
<b>Type / Model</b>	<b>REF. NO.</b>	<b>SEM NO.</b>	
	81960200384 N1011004579	7678	
		<b>Description</b>	
		Engine Mounting	
			D=Ø70 h=85 SHORE A45
<b>Type / Model</b>	<b>REF. NO.</b>	<b>SEM NO.</b>	
	81960200402	7711	
		<b>Description</b>	
		Engine Mounting	
			D=Ø70 h=105
<b>Type / Model</b>	<b>REF. NO.</b>	<b>SEM NO.</b>	
16.240	81962100184	7331	
19.281	81962100149		
22.280	81962100129		
26.280	81962100371		
26.281			
26.321			
30.281			
32.281			
		<b>Description</b>	
		Transmission Mounting	
			A=140 B=65 h=55 M10
<b>Type / Model</b>	<b>REF. NO.</b>	<b>SEM NO.</b>	
11.192	81962100213	7355	
15.192			
16.168			
16.102			
22.190			
		<b>Description</b>	
		Transmission Mounting	
			A=140 B=55 h=55 M10
<b>Type / Model</b>	<b>REF. NO.</b>	<b>SEM NO.</b>	
16.292	81962100089	7387	
16.332			
19.292			
19.332			
19.462			
26.280			
		<b>Description</b>	
		Transmission Mounting	
			D=Ø100 h=75 M16x1.5









A=140 B=65 h=40 M10

SEM NO.	REF. NO.	Type / Model
7411	81962100267	16.240 19.240 22.240 26.240 26.280 32.240
<b>Description</b>		
Transmission Mounting		



D=Ø100 h=73 M16x1.5

SEM NO.	REF. NO.	Type / Model
7580	81962100388 81962100494 81962100495	19.372 19.422
<b>Description</b>		
Transmission Mounting		

<b>Type / Model</b>	<b>REF. NO.</b>	<b>SEM NO.</b>	
	51968200317	<b>11672</b>	
		<b>Description</b>	
		V Ribbed Belt	
			4PK1390
<b>Type / Model</b>	<b>REF. NO.</b>	<b>SEM NO.</b>	
	51968200271	<b>11676</b>	
		<b>Description</b>	
		V Ribbed Belt	
			5PK1482
<b>Type / Model</b>	<b>REF. NO.</b>	<b>SEM NO.</b>	
	51968200332	<b>12889</b>	
		<b>Description</b>	
		V Ribbed Belt	
			5PK1525
<b>Type / Model</b>	<b>REF. NO.</b>	<b>SEM NO.</b>	
	51968200238	<b>10312</b>	
		<b>Description</b>	
		V Ribbed Belt	
			8PK880
<b>Type / Model</b>	<b>REF. NO.</b>	<b>SEM NO.</b>	
	51968200322	<b>11682</b>	
		<b>Description</b>	
		V Ribbed Belt	
			8PK1158
<b>Type / Model</b>	<b>REF. NO.</b>	<b>SEM NO.</b>	
	51968200243 51968200277	<b>10326</b>	
		<b>Description</b>	
		V Ribbed Belt	
			8PK1275



SEM NO.	REF. NO.	Type / Model
<b>11685</b>	51968200280	
<b>Description</b>		
V Ribbed Belt		

8PK1325

SEM NO.	REF. NO.	Type / Model
<b>10330</b>	51968200239	
<b>Description</b>		
V Ribbed Belt		

8PK1376

SEM NO.	REF. NO.	Type / Model
<b>12893</b>	06580490038 06580490044	
<b>Description</b>		
V Ribbed Belt		

8PK1495

SEM NO.	REF. NO.	Type / Model
<b>10346</b>	51968200272 51968200344 51968200336	
<b>Description</b>		
V Ribbed Belt		

8PK1635





SEM NO.	REF. NO.	Type / Model
<b>12895</b>	51968200324	
<b>Description</b>		
V Ribbed Belt		



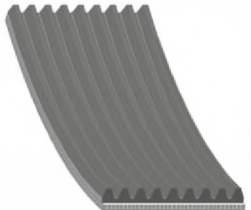
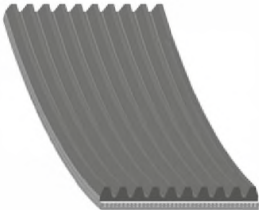
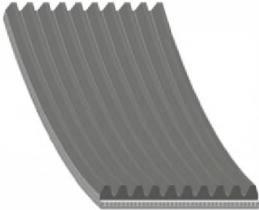
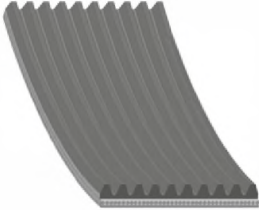
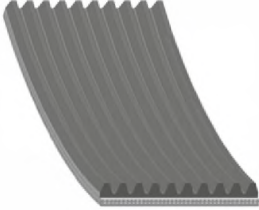
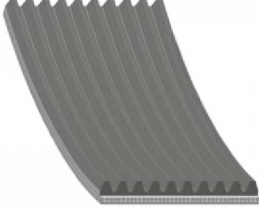

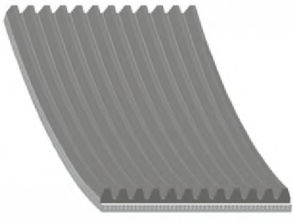
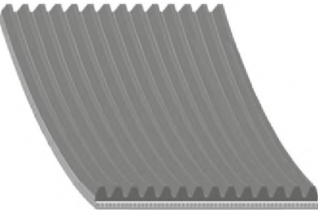
8PK1875







SEM NO.	REF. NO.	Type / Model
<b>10358</b>	51968200273 51968200345	
<b>Description</b>		
V Ribbed Belt		







8PK1920

<b>Type / Model</b>	<b>REF. NO.</b>	<b>SEM NO.</b>	
	51968200308	10377	
		<b>Description</b>	
		V Ribbed Belt	
9PK1725			
<b>Type / Model</b>	<b>REF. NO.</b>	<b>SEM NO.</b>	
	51968200330 51968200325	10401	
		<b>Description</b>	
		V Ribbed Belt	
10PK1688			
<b>Type / Model</b>	<b>REF. NO.</b>	<b>SEM NO.</b>	
	51968200242	(10407)10406	
		<b>Description</b>	
		V Ribbed Belt	
10PK1860			
<b>Type / Model</b>	<b>REF. NO.</b>	<b>SEM NO.</b>	
	06580490035 06580490052	12905	
		<b>Description</b>	
		V Ribbed Belt	
10PK2108			
<b>Type / Model</b>	<b>REF. NO.</b>	<b>SEM NO.</b>	
	51968200339 51968200333	12900	
		<b>Description</b>	
		V Ribbed Belt	
10PK2335			
<b>Type / Model</b>	<b>REF. NO.</b>	<b>SEM NO.</b>	
	51968200253	11705	
		<b>Description</b>	
		V Ribbed Belt	
12PK1300			

 <p>12PK1515</p>	<table border="1"> <thead> <tr> <th>SEM NO.</th> <th>REF. NO.</th> <th>Type / Model</th> </tr> </thead> <tbody> <tr> <td>10410</td> <td>51968200250</td> <td></td> </tr> <tr> <td colspan="3"><b>Description</b></td> </tr> <tr> <td colspan="3">V Ribbed Belt</td> </tr> </tbody> </table>	SEM NO.	REF. NO.	Type / Model	10410	51968200250		<b>Description</b>			V Ribbed Belt			
SEM NO.	REF. NO.	Type / Model												
10410	51968200250													
<b>Description</b>														
V Ribbed Belt														
 <p>14PK1306</p>	<table border="1"> <thead> <tr> <th>SEM NO.</th> <th>REF. NO.</th> <th>Type / Model</th> </tr> </thead> <tbody> <tr> <td>11706</td> <td>51968200270</td> <td></td> </tr> <tr> <td colspan="3"><b>Description</b></td> </tr> <tr> <td colspan="3">V Ribbed Belt</td> </tr> </tbody> </table>	SEM NO.	REF. NO.	Type / Model	11706	51968200270		<b>Description</b>			V Ribbed Belt			
SEM NO.	REF. NO.	Type / Model												
11706	51968200270													
<b>Description</b>														
V Ribbed Belt														
 <p>2 AVX 10 x 1415</p>	<table border="1"> <thead> <tr> <th>SEM NO.</th> <th>REF. NO.</th> <th>Type / Model</th> </tr> </thead> <tbody> <tr> <td>12904</td> <td>81968200054</td> <td></td> </tr> <tr> <td colspan="3"><b>Description</b></td> </tr> <tr> <td colspan="3">V Ribbed Belt</td> </tr> </tbody> </table>	SEM NO.	REF. NO.	Type / Model	12904	81968200054		<b>Description</b>			V Ribbed Belt			<p><i>new product</i></p>
SEM NO.	REF. NO.	Type / Model												
12904	81968200054													
<b>Description</b>														
V Ribbed Belt														
 <p>2 AVX 10 x 1640</p>	<table border="1"> <thead> <tr> <th>SEM NO.</th> <th>REF. NO.</th> <th>Type / Model</th> </tr> </thead> <tbody> <tr> <td>12903</td> <td>81968200053</td> <td></td> </tr> <tr> <td colspan="3"><b>Description</b></td> </tr> <tr> <td colspan="3">V Ribbed Belt</td> </tr> </tbody> </table>	SEM NO.	REF. NO.	Type / Model	12903	81968200053		<b>Description</b>			V Ribbed Belt			<p><i>new product</i></p>
SEM NO.	REF. NO.	Type / Model												
12903	81968200053													
<b>Description</b>														
V Ribbed Belt														
 <p>2XAVX13X1025</p>	<table border="1"> <thead> <tr> <th>SEM NO.</th> <th>REF. NO.</th> <th>Type / Model</th> </tr> </thead> <tbody> <tr> <td>12901</td> <td>06580722222 06580732222</td> <td></td> </tr> <tr> <td colspan="3"><b>Description</b></td> </tr> <tr> <td colspan="3">V Ribbed Belt</td> </tr> </tbody> </table>	SEM NO.	REF. NO.	Type / Model	12901	06580722222 06580732222		<b>Description</b>			V Ribbed Belt			<p><i>new product</i></p>
SEM NO.	REF. NO.	Type / Model												
12901	06580722222 06580732222													
<b>Description</b>														
V Ribbed Belt														

<b>Type / Model</b>	<b>REF. NO.</b>		<b>SEM NO.</b>	
	51066010256		12135	
			<b>Description</b>	
			Blade,Fan	
<b>Type / Model</b>	<b>REF. NO.</b>		<b>SEM NO.</b>	
	51066010266		12137	
			<b>Description</b>	
			Blade,Fan	
<b>Type / Model</b>	<b>REF. NO.</b>		<b>SEM NO.</b>	
	51066010177		12139	
			<b>Description</b>	
			Blade,Fan	
<b>Type / Model</b>	<b>REF. NO.</b>		<b>SEM NO.</b>	
	51066010268		13028	
			<b>Description</b>	
			Blade,Fan	
<b>Type / Model</b>	<b>REF. NO.</b>		<b>SEM NO.</b>	
	51066300060		12134	
			<b>Description</b>	
			Visco Drive,Fan	
<b>Type / Model</b>	<b>REF. NO.</b>		<b>SEM NO.</b>	
	51066300071		12136	
			<b>Description</b>	
			Visco Drive,Fan	

	<b>SEM NO.</b> 12138		<b>REF. NO.</b> 51066300037	<b>Type / Model</b>
<b>Description</b> Visco Drive, Fan				
	<b>SEM NO.</b> 10034	<b>REF. NO.</b> 51958006076 51958006099		<b>Type / Model</b> TGA
6304 NSK - FAG C3 Bearing h = 34 mm Q = 74 mm	<b>Description</b> Guide Pulley - Welded			
	<b>SEM NO.</b> 011	<b>REF. NO.</b> 81961010382		<b>Type / Model</b>
<b>Description</b> Rubber Strip				
	<b>SEM NO.</b> 048	<b>REF. NO.</b> 81961010659		<b>Type / Model</b> 19.422 19.423 19.463
<b>Description</b> Rubber Strip				
	<b>SEM NO.</b> 055	<b>REF. NO.</b> 81961010527		<b>Type / Model</b> 26.270
<b>Description</b> Rubber Strip				

Type / Model	REF. NO.	SEM NO.	
26.281	81963010401	7383	 <p><b>Description</b> Hose Connection</p> <p>Ø 150x120</p>
26.281 26.321	04274051100	7412	 <p><b>Description</b> Hose Connection</p> <p>Ø 90x120</p>
19.372 19.422 26.230 26.270 26.281 26.321 33.372		7413	 <p><b>Description</b> Hose Connection</p> <p>Ø 100x120</p>
(Alternatively-8855) SR 240	51963300190	7423	 <p><b>Description</b> Hose Connection</p> <p>Ø 75x120</p>
26.280	81963010323	7346	 <p><b>Description</b> Hose</p> <p>Ø 50-Ø 55</p>
26.280	81963010321	7347	 <p><b>Description</b> Hose</p> <p>Ø 50-Ø 55</p>

	ŞEM NO.	REF. NO.	Type / Model
	7381	81963010458	26.281 26.231
	<b>Description</b> Hose		
Ø60 Ø55			

	ŞEM NO.	REF. NO.	Type / Model
	7382	83963010001	26.281 26.231
	<b>Description</b> Hose		
Ø 60			







	ŞEM NO.	REF. NO.	Type / Model
	8408	81963010677	TGA
	<b>Description</b> Upper Hose		
d=Ø60 d=Ø60 h=430			







	ŞEM NO.	REF. NO.	Type / Model
	8409	81963050166	TGA
	<b>Description</b> Upper Hose		
d=Ø22 d=Ø22 h=880			







	ŞEM NO.	REF. NO.	Type / Model
	8410	04274059502	TGA
	<b>Description</b> Water Hose		
d=Ø10 d=Ø10 h=1030			







	ŞEM NO.	REF. NO.	Type / Model
	8411	81963010898 82963010006	TGA
	<b>Description</b> Radiator Lower Hose		
d=Ø60 d=Ø60 h=620			





Type / Model	REF. NO.	SEM NO.	
TGA	04271991010	8509	 <p><b>Description</b> Radiator Hose</p> <p>10x10x1130</p>
TGA	04274059550 04274050050 04274059250 85900012826 86271300050	8510	 <p><b>Description</b> Radiator Hose</p> <p>50x50x1000</p>
TGA	04274059560 04274050060 04274059260 85900012813 85900012828 86271290060 04274059860	8511 (11057)	 <p><b>Description</b> Radiator Hose</p> <p>60x60x1000</p>
TGA	81963050300 81963050261	8540	 <p><b>Description</b> Heating Hose</p> <p>18x18x380</p>
TGA	81963050217 81963050211	8580	 <p><b>Description</b> Heating Air Hose</p> <p>18x18x630</p>
TGA	81963050262 81963050371 82963050018	8581	 <p><b>Description</b> Heating Air Hose</p> <p>18x18x520</p>

	<b>ŞEM NO.</b> 8582	<b>REF. NO.</b> 81963050272 81963050263	<b>Type / Model</b> TGA
	<b>Description</b> Heating Air Hose		
18x18x510			
	<b>ŞEM NO.</b> 8706	<b>REF. NO.</b> 81963010622	<b>Type / Model</b> 19T
	<b>Description</b> Radiator Lower Hose		
50x50x570x375			
	<b>ŞEM NO.</b> 8728	<b>REF. NO.</b> 81963050304 81963050303	<b>Type / Model</b> TGL
	<b>Description</b> Heating Hose		
18x18x960			
	<b>ŞEM NO.</b> 8729	<b>REF. NO.</b> 81963010904	<b>Type / Model</b> TGL
	<b>Description</b> Radiator Lower Hose		
50x50x565			
	<b>ŞEM NO.</b> 8730	<b>REF. NO.</b> 81963010906	<b>Type / Model</b> TGL
	<b>Description</b> Radiator Hose		
50x50x485			
	<b>ŞEM NO.</b> 8731	<b>REF. NO.</b> 81963010895	<b>Type / Model</b> TGA TGL TGM
	<b>Description</b> Heating Hose		
18x18x460			

Type / Model	REF. NO.	ŞEM NO.	
TGA TGL TGM	81963010896	8732	 <p><b>Description</b> Heating Hose</p> <p>18x18x18</p>
TGA TGL TGM	81963010894	8733	 <p><b>Description</b> Heating Hose</p> <p>18x18x280</p>
F2000	81963010659 81963010496	8734	 <p><b>Description</b> Radiator Hose</p> <p>60x60x460</p>
F2000	81963050088	8735	 <p><b>Description</b> Radiator Hose</p> <p>60x60x615</p>
F2000	81963050129	8736	 <p><b>Description</b> Radiator Hose</p> <p>60x60x630</p>
TGA	81963050192	8748	 <p><b>Description</b> Heating Hose</p>

	<b>ŞEM NO.</b>	<b>REF. NO.</b>	<b>Type / Model</b>
	8749 (9518)	81963050194	TGA
	<b>Description</b> Heating Hose		
	<b>ŞEM NO.</b>	<b>REF. NO.</b>	<b>Type / Model</b>
	8750	81963050193	TGA
	<b>Description</b> Heating Hose		
	<b>ŞEM NO.</b>	<b>REF. NO.</b>	<b>Type / Model</b>
	8751	81963050197	TGA
	<b>Description</b> Heating Hose		
	<b>ŞEM NO.</b>	<b>REF. NO.</b>	<b>Type / Model</b>
	9519	81963050285 82963050025	TGA
	<b>Description</b> Heating Hose		
18x18x400			
	<b>ŞEM NO.</b>	<b>REF. NO.</b>	<b>Type / Model</b>
	9520	81963050286	TGA
	<b>Description</b> Heating Hose		
18x18x400			
	<b>ŞEM NO.</b>	<b>REF. NO.</b>	<b>Type / Model</b>
	9521	81963050234	TGA TGM TGL TGS TGX
	<b>Description</b> Heating Hose		
18x18x180			

Type / Model	REF. NO.	SEM NO.	
TGA TGM TGL TGS TGX	81963050235	9522	 <b>Description</b> Heating Hose 18x18x295
TGA TGM TGL TGS TGX	81963300164	9523	
TGA TGM TGL TGS TGX	81963050203	9524	 <b>Description</b> Heating Hose 18x18x133
TGA TGM TGL TGS TGX	81963050169 81963050130	9592	
TGS TGX	81963050354	9694	 <b>Description</b> Heating Air Hose 18x18x525
TGS TGX	81963050360	9695	

	ŞEM NO.	REF. NO.	Type / Model
	9696	81963050361	TGS TGX
	<b>Description</b>		
	Heating Air Hose		
18x18x460			







	ŞEM NO.	REF. NO.	Type / Model
	9697	81963050365	TGS TGX
	<b>Description</b>		
	Heating Air Hose		
18x18x495			

	ŞEM NO.	REF. NO.	Type / Model
	9698	81963050366	TGS TGX
	<b>Description</b>		
	Heating Air Hose		
18x18x475			







	ŞEM NO.	REF. NO.	Type / Model
	9699	81963010889	TGS TGX
	<b>Description</b>		
	Cooling Water Lower Hose		
60x60x710			







	ŞEM NO.	REF. NO.	Type / Model
	9700	81963010893	TGS
	<b>Description</b>		
	Cooling Water Lower Hose		
60x60x720			







	ŞEM NO.	REF. NO.	Type / Model
	9701	81963010892	TGX
	<b>Description</b>		
	Cooling Water Lower Hose		
60x60x590			









Type / Model	REF. NO.	SEM NO.	
SL 18.220	81963050383	9702	 <p><b>Description</b> Cooling Water Elbow Hose</p> <p>60x60x235</p>
N4516 CENTROLINER	81963050389	9703	 <p><b>Description</b> Cooling Water Elbow Hose</p> <p>38x38x165</p>
FE 26T	81963010633	9704	 <p><b>Description</b> Oil Hose</p> <p>40x38x1300</p>
TGX	81963010678	9705	 <p><b>Description</b> Cooling Water Hose</p> <p>60x60x600</p>
18220	83963050003	10544	 <p><b>Description</b> Cooling Water Hose</p> <p>50x38x500</p>
TGA	81963010680	10545	 <p><b>Description</b> Cooling Water Hose</p> <p>60x60x530</p>



 50x50x450	<b>SEM NO.</b> 10546	<b>REF. NO.</b> 81963010907	<b>Type / Model</b> TGL TGM
	<b>Description</b> Cooling Water Hose		
 22x22x120	<b>SEM NO.</b> 10547	<b>REF. NO.</b> 81963050167	<b>Type / Model</b> TGX TGS
	<b>Description</b> Water Hose		
 50x50x490	<b>SEM NO.</b> 10548	<b>REF. NO.</b> 81963010905	<b>Type / Model</b> TGL TGM
	<b>Description</b> Cooling Water Hose		
 50x50x480	<b>SEM NO.</b> 10549	<b>REF. NO.</b> 81963010908	<b>Type / Model</b> TGL TGM
	<b>Description</b> Cooling Water Hose		
 60x60x550	<b>SEM NO.</b> 10550	<b>REF. NO.</b> 81963010679	<b>Type / Model</b> TGA
	<b>Description</b> Cooling Water Hose		
 18x20x770	<b>SEM NO.</b> 10551	<b>REF. NO.</b> 81963050255	<b>Type / Model</b> FE 26T
	<b>Description</b> Heating Air Hose		

<b>Type / Model</b>	<b>REF. NO.</b>	<b>SEM NO.</b>	
TGM	85963050016	10552	
			<b>Description</b>
			Steering Box Hose
			22x22x1200
<b>Type / Model</b>	<b>REF. NO.</b>	<b>SEM NO.</b>	
TGL	81963010917	10553	
			<b>Description</b>
			Heating Air Hose
			18x18x700
<b>Type / Model</b>	<b>REF. NO.</b>	<b>SEM NO.</b>	
FE 26T	81963050269	10554	
			<b>Description</b>
			Heating Air Hose
			18x18x570
<b>Type / Model</b>	<b>REF. NO.</b>	<b>SEM NO.</b>	
TGS TGX	81963050264	10555	
			<b>Description</b>
			Heating Air Hose
			18x18x195
<b>Type / Model</b>	<b>REF. NO.</b>	<b>SEM NO.</b>	
TGS TGX	81963050280 81963050218	11056	
			<b>Description</b>
			Heating Air Hose
			18x18x625
<b>Type / Model</b>	<b>REF. NO.</b>	<b>SEM NO.</b>	
TOURLINER FORTUNA	04274059538	11058	
			<b>Description</b>
			Cooling Water Hose
			38x38x1000

 22x22x250	<table border="1"> <thead> <tr> <th>ŞEM NO.</th> <th>REF. NO.</th> <th>Type / Model</th> </tr> </thead> <tbody> <tr> <td>11059</td> <td>81963010631</td> <td>FE 26T</td> </tr> <tr> <td colspan="3"><b>Description</b></td> </tr> <tr> <td colspan="3">Heating Air Hose</td> </tr> </tbody> </table>	ŞEM NO.	REF. NO.	Type / Model	11059	81963010631	FE 26T	<b>Description</b>			Heating Air Hose		
ŞEM NO.	REF. NO.	Type / Model											
11059	81963010631	FE 26T											
<b>Description</b>													
Heating Air Hose													
 22x22x415	<table border="1"> <thead> <tr> <th>ŞEM NO.</th> <th>REF. NO.</th> <th>Type / Model</th> </tr> </thead> <tbody> <tr> <td>11707</td> <td>81963050145</td> <td>FE 26T</td> </tr> <tr> <td colspan="3"><b>Description</b></td> </tr> <tr> <td colspan="3">Heating Hose</td> </tr> </tbody> </table>	ŞEM NO.	REF. NO.	Type / Model	11707	81963050145	FE 26T	<b>Description</b>			Heating Hose		
ŞEM NO.	REF. NO.	Type / Model											
11707	81963050145	FE 26T											
<b>Description</b>													
Heating Hose													
 22x22x380	<table border="1"> <thead> <tr> <th>ŞEM NO.</th> <th>REF. NO.</th> <th>Type / Model</th> </tr> </thead> <tbody> <tr> <td>11708</td> <td>81963050143</td> <td>FE 26T</td> </tr> <tr> <td colspan="3"><b>Description</b></td> </tr> <tr> <td colspan="3">Heating Hose</td> </tr> </tbody> </table>	ŞEM NO.	REF. NO.	Type / Model	11708	81963050143	FE 26T	<b>Description</b>			Heating Hose		
ŞEM NO.	REF. NO.	Type / Model											
11708	81963050143	FE 26T											
<b>Description</b>													
Heating Hose													
 60x60x260	<table border="1"> <thead> <tr> <th>ŞEM NO.</th> <th>REF. NO.</th> <th>Type / Model</th> </tr> </thead> <tbody> <tr> <td>11709</td> <td>81963050227</td> <td>TGX TGA</td> </tr> <tr> <td colspan="3"><b>Description</b></td> </tr> <tr> <td colspan="3">Cooling Water Hose</td> </tr> </tbody> </table>	ŞEM NO.	REF. NO.	Type / Model	11709	81963050227	TGX TGA	<b>Description</b>			Cooling Water Hose		
ŞEM NO.	REF. NO.	Type / Model											
11709	81963050227	TGX TGA											
<b>Description</b>													
Cooling Water Hose													
 18x18x500x100	<table border="1"> <thead> <tr> <th>ŞEM NO.</th> <th>REF. NO.</th> <th>Type / Model</th> </tr> </thead> <tbody> <tr> <td>11710</td> <td>81963010918</td> <td>TGL TGM</td> </tr> <tr> <td colspan="3"><b>Description</b></td> </tr> <tr> <td colspan="3">Heating Hose</td> </tr> </tbody> </table>	ŞEM NO.	REF. NO.	Type / Model	11710	81963010918	TGL TGM	<b>Description</b>			Heating Hose		
ŞEM NO.	REF. NO.	Type / Model											
11710	81963010918	TGL TGM											
<b>Description</b>													
Heating Hose													
 15x15x550	<table border="1"> <thead> <tr> <th>ŞEM NO.</th> <th>REF. NO.</th> <th>Type / Model</th> </tr> </thead> <tbody> <tr> <td>11842</td> <td>85963050010</td> <td></td> </tr> <tr> <td colspan="3"><b>Description</b></td> </tr> <tr> <td colspan="3">Suction Oil Hose</td> </tr> </tbody> </table>	ŞEM NO.	REF. NO.	Type / Model	11842	85963050010		<b>Description</b>			Suction Oil Hose		
ŞEM NO.	REF. NO.	Type / Model											
11842	85963050010												
<b>Description</b>													
Suction Oil Hose													

<b>Type / Model</b>	<b>REF. NO.</b>		<b>SEM NO.</b>	
	81963050258		11843	
			<b>Description</b>	
			Heating Air Hose	
				18x20x760
<b>Type / Model</b>	<b>REF. NO.</b>		<b>SEM NO.</b>	
	81963050353		11844	
			<b>Description</b>	
			Heating Air Hose	
				18x18x260
<b>Type / Model</b>	<b>REF. NO.</b>		<b>SEM NO.</b>	
	81963050352		11845	
			<b>Description</b>	
			Heating Air Hose	
				18x18x220
<b>Type / Model</b>	<b>REF. NO.</b>		<b>SEM NO.</b>	
	81963010962		11846	
			<b>Description</b>	
			Cooling Water Hose	
				60x60x270

	SEM NO.	REF. NO.	Type / Model
	8842	81963200175	BLACK
		81963200115	RED
<b>Description</b> Silicon Hose			
D:Ø65 mm L:180 mm 4 HUMP			







	SEM NO.	REF. NO.	Type / Model
	8843	81963010587	BLACK
		81963010543	RED
		81963010591	
		81963010592	
<b>Description</b> Silicon Hose			
D:Ø100 mm L:240 mm 5 HUMP			







	SEM NO.	REF. NO.	Type / Model
	8844	81963010668	BLUE
		<b>Description</b> Silicon Hose	
D:Ø90 mm L:290 mm 7 HUMP			

	SEM NO.	REF. NO.	Type / Model
	8845	81963010900	BLACK
			RED
<b>Description</b> Silicon Hose			
D:Ø90 mm L:285 mm 7 HUMP			







	SEM NO.	REF. NO.	Type / Model
	8846	81963200168	BLACK
			RED
<b>Description</b> Silicon Hose			
D:Ø65 mm D:Ø50 mm L:190 mm 3 HUMP			

	SEM NO.	REF. NO.	Type / Model
	8847	81963010594	BLACK
			RED
<b>Description</b> Silicon Hose			
D:Ø90 mm L:120 mm			

Type / Model	REF. NO.	ŞEM NO.	
BLUE	81963010639 81963010551	8848	 <p><b>Description</b> Silicon Hose</p> <p>D:Ø60 mm D:Ø70 mm L:90 mm</p>
BLUE	81963050134 51963050018 81963050095 51963050021 81963050223 81963050226	8849	 <p><b>Description</b> Silicon Hose</p> <p>D:Ø60 mm L:85X85 mm</p>
BLACK RED	81963010600	8850	 <p><b>Description</b> Silicon Hose</p> <p>D:Ø100 mm L:130 mm</p>
BLACK RED	81963200132	8851	 <p><b>Description</b> Silicon Hose</p> <p>D:Ø100 mm L:180 mm</p>
BLACK RED	81963200170	8852	 <p><b>Description</b> Silicon Hose</p> <p>D:Ø65 mm L:110 mm</p>
BLACK RED	81963010624	8853	 <p><b>Description</b> Silicon Hose</p> <p>D:Ø100 mm L:80 mm</p>

 D:Ø50 mm L:110 mm	<table border="1"> <thead> <tr> <th>ŞEM NO.</th> <th>REF. NO.</th> <th>Type / Model</th> </tr> </thead> <tbody> <tr> <td>8854</td> <td>81963300300</td> <td>BLACK RED</td> </tr> <tr> <td colspan="3"><b>Description</b></td> </tr> <tr> <td colspan="3">Silicon Hose</td> </tr> </tbody> </table>	ŞEM NO.	REF. NO.	Type / Model	8854	81963300300	BLACK RED	<b>Description</b>			Silicon Hose		
ŞEM NO.	REF. NO.	Type / Model											
8854	81963300300	BLACK RED											
<b>Description</b>													
Silicon Hose													
 D:Ø75 mm L:120 mm	<table border="1"> <thead> <tr> <th>ŞEM NO.</th> <th>REF. NO.</th> <th>Type / Model</th> </tr> </thead> <tbody> <tr> <td>8855</td> <td>51963300190</td> <td>BLACK RED</td> </tr> <tr> <td colspan="3"><b>Description</b></td> </tr> <tr> <td colspan="3">Silicon Hose</td> </tr> </tbody> </table>	ŞEM NO.	REF. NO.	Type / Model	8855	51963300190	BLACK RED	<b>Description</b>			Silicon Hose		
ŞEM NO.	REF. NO.	Type / Model											
8855	51963300190	BLACK RED											
<b>Description</b>													
Silicon Hose													
 D:Ø50 mm L:80 mm	<table border="1"> <thead> <tr> <th>ŞEM NO.</th> <th>REF. NO.</th> <th>Type / Model</th> </tr> </thead> <tbody> <tr> <td>8856</td> <td>51963300359</td> <td>BLACK RED</td> </tr> <tr> <td colspan="3"><b>Description</b></td> </tr> <tr> <td colspan="3">Silicon Hose</td> </tr> </tbody> </table>	ŞEM NO.	REF. NO.	Type / Model	8856	51963300359	BLACK RED	<b>Description</b>			Silicon Hose		
ŞEM NO.	REF. NO.	Type / Model											
8856	51963300359	BLACK RED											
<b>Description</b>													
Silicon Hose													
 D:Ø70mm L:100mm	<table border="1"> <thead> <tr> <th>ŞEM NO.</th> <th>REF. NO.</th> <th>Type / Model</th> </tr> </thead> <tbody> <tr> <td>8857</td> <td>81963010602</td> <td>BLACK RED</td> </tr> <tr> <td colspan="3"><b>Description</b></td> </tr> <tr> <td colspan="3">Silicon Hose</td> </tr> </tbody> </table>	ŞEM NO.	REF. NO.	Type / Model	8857	81963010602	BLACK RED	<b>Description</b>			Silicon Hose		
ŞEM NO.	REF. NO.	Type / Model											
8857	81963010602	BLACK RED											
<b>Description</b>													
Silicon Hose													
 D:Ø90 mm L:205 mm 4 HUMP	<table border="1"> <thead> <tr> <th>ŞEM NO.</th> <th>REF. NO.</th> <th>Type / Model</th> </tr> </thead> <tbody> <tr> <td>10304</td> <td>81963010590</td> <td>BLACK RED</td> </tr> <tr> <td colspan="3"><b>Description</b></td> </tr> <tr> <td colspan="3">Silicon Hose</td> </tr> </tbody> </table>	ŞEM NO.	REF. NO.	Type / Model	10304	81963010590	BLACK RED	<b>Description</b>			Silicon Hose		
ŞEM NO.	REF. NO.	Type / Model											
10304	81963010590	BLACK RED											
<b>Description</b>													
Silicon Hose													
 d=Ø58 L=160	<table border="1"> <thead> <tr> <th>ŞEM NO.</th> <th>REF. NO.</th> <th>Type / Model</th> </tr> </thead> <tbody> <tr> <td>10921</td> <td>81863050312</td> <td>BLUE</td> </tr> <tr> <td colspan="3"><b>Description</b></td> </tr> <tr> <td colspan="3">Silicon Hose</td> </tr> </tbody> </table>	ŞEM NO.	REF. NO.	Type / Model	10921	81863050312	BLUE	<b>Description</b>			Silicon Hose		
ŞEM NO.	REF. NO.	Type / Model											
10921	81863050312	BLUE											
<b>Description</b>													
Silicon Hose													



Type / Model	REF. NO.	SEM NO.	
BLACK	81963010901 81963010902 81963010903 81963010883	<b>11148</b>	 <b>Description</b> Silicon Hose Ø90X290 7 hump
BLACK RED	81963200159	<b>11149</b>	 <b>Description</b> Silicon Hose Ø50X160 3 hump
BLACK RED	81964200506	<b>11150</b>	 <b>Description</b> Silicon Hose Ø120X135 2 hump
BLACK RED	81963010648	<b>11151</b>	 <b>Description</b> Silicon Hose Ø100X190 3 hump
BLACK RED	51964200121 51963300315	<b>11152</b>	 <b>Description</b> Silicon Hose Ø90x160 3 hump
BLACK RED	51963300300 51963300427 51963010108	<b>11153</b>	 <b>Description</b> Silicon Hose Ø50X110

	ŞEM NO.	REF. NO.	Type / Model
	11154	51963300352	BLACK
	<b>Description</b>		
	Silicon Hose		
Ø90x90 mm			



	ŞEM NO.	REF. NO.	Type / Model
	11155	81963050312	BLUE
	<b>Description</b>		
	Silicon Hose		
Ø60x80x165			

	ŞEM NO.	REF. NO.	Type / Model
	11156	81963050207	BLUE
	<b>Description</b>		
	Silicon Hose		
Ø60x90x120			

	ŞEM NO.	REF. NO.	Type / Model
	11157	81963050196	BLUE
	<b>Description</b>		
	Silicon Hose		
Ø50xØ60x75x70			

	ŞEM NO.	REF. NO.	Type / Model
	11158	81963050135 81963010399 81963050144 81963050298	BLUE
	<b>Description</b>		
	Silicon Hose		
Ø60x80x80			

	ŞEM NO.	REF. NO.	Type / Model
	11159	81963050206 81963050202	BLUE
	<b>Description</b>		
	Silicon Hose		
Ø60x170x120			

Type / Model	REF. NO.	SEM NO.	
BLUE	81963010387 81963010523	11160	 <b>Description</b> Silicon Hose Ø38x90x90
BLUE	81963010140	11161	
BLUE	81963010140	11161	 <b>Description</b> Silicon Hose Ø60x70x70
RED	81963010082	11162	
RED	81963010082	11162	 <b>Description</b> Silicon Hose Ø30x45x92

SEM NO.	REF. NO.	Type / Model
9590	81062250005	TGA
<b>Description</b>		
Rubber Metal Mounting		



LEFT

SEM NO.	REF. NO.	Type / Model
9591	81062250006	TGA
<b>Description</b>		
Rubber Metal Mounting		



RIGHT

SEM NO.	REF. NO.	Type / Model
7333	81962100121 81962100196	26.280 26.281 26.321 SL 200 SR 240
<b>Description</b>		
Rubber Metal Mounting		



A=82.5 h=51

SEM NO.	REF. NO.	Type / Model
7359	81962100123 81962100295	22.280 26.281 26.321 SL200 SR220 SR240
<b>Description</b>		
Rubber Metal Mounting		



A=73 h=34

SEM NO.	REF. NO.	Type / Model
7217	81960200056 81960207000 51962100002	520 19.190 20.190 22.190
<b>Description</b>		
Rubber Metal Buffer		













D=Ø40 h=30 M8x47 M8x23 SHORE A 70







SEM NO.	REF. NO.	Type / Model
7218	81962100052	575 590 26.230 26.270
<b>Description</b>		
Rubber Metal Buffer		



D=Ø40 h=30 M8x23 SHORE A 55

<b>Type / Model</b>	<b>REF. NO.</b>	<b>SEM NO.</b>	
	81962100026	7731	
			<b>Description</b> Rubber Metal Mounting
			D=Ø40 h=30 L=22 Shore A 55
<b>Type / Model</b>	<b>REF. NO.</b>	<b>SEM NO.</b>	
	81962100042	8014	
			<b>Description</b> Transmiss Mounting
			D=Ø50 d=Ø30 M 10
<b>Type / Model</b>	<b>REF. NO.</b>	<b>SEM NO.</b>	
	81962100615	8220	
			<b>Description</b> Rubber Metal Mounting
			D=Ø40 h=30 M 8x23
<b>Type / Model</b>	<b>REF. NO.</b>	<b>SEM NO.</b>	
26.210	81962100248	7447	
26.240			
26.321			
32.281			
32.321			
SL 232			
			<b>Description</b> Rubber Metal Mounting
			D=Ø68 d=Ø13 h=20
<b>Type / Model</b>	<b>REF. NO.</b>	<b>SEM NO.</b>	
SL 232 S 2000	81962100247	7497	
			<b>Description</b> Rubber Metal Mounting
			D=Ø50 d=Ø13 h=11.5 SHORE A 65
<b>Type / Model</b>	<b>REF. NO.</b>	<b>SEM NO.</b>	
	81962100240 81437060006	7646	
			<b>Description</b> Rubber Metal Mounting
			D=Ø56 d=Ø22 h=19

	<b>SEM NO.</b>	<b>REF. NO.</b>	<b>Type / Model</b>
	7917	81962100426	
<b>Description</b>			
Rubber Metal Monting			
D=Ø38 d=Ø13 h=44			
	<b>SEM NO.</b>	<b>REF. NO.</b>	<b>Type / Model</b>
	7491	83960200500	26.230 26.270
<b>Description</b>			
Rubber Buffer			
32x38			
	<b>SEM NO.</b>	<b>REF. NO.</b>	<b>Type / Model</b>
	7460	83062312512	
<b>Description</b>			
Rubber Packing			
560x50 3			
	<b>SEM NO.</b>	<b>REF. NO.</b>	<b>Type / Model</b>
	7543	81961010540	
<b>Description</b>			
Rubber Packing			
A=150 B=73 h=3			

<b>Type / Model</b>	<b>REF. NO.</b>	<b>SEM NO.</b>	
19.190 20.190 22.190 26.321 30.240 32.281	81962100101	<b>7294</b>	
		<b>Description</b>	
		Rubber Metal Buffer	
			D=Ø50 h=40 M10x25 Shore A 55
<b>Type / Model</b>	<b>REF. NO.</b>	<b>SEM NO.</b>	
19.372 19.422 33.372	81962100127	<b>7507</b>	
		<b>Description</b>	
		Rubber Metal Buffer	
			D=Ø 50 h=Ø 30 M 10x22
<b>Type / Model</b>	<b>REF. NO.</b>	<b>SEM NO.</b>	
13.192 15.168 16.168 16.192	81962100153	<b>7513</b>	
		<b>Description</b>	
		Rubber Metal Buffer	
			D=Ø50 h=Ø30 M10x25
<b>Type / Model</b>	<b>REF. NO.</b>	<b>SEM NO.</b>	
	81962100610	<b>8138</b>	
		<b>Description</b>	
		Rubber Mounting	
			D=Ø50 h=30 M10x20
<b>Type / Model</b>	<b>REF. NO.</b>	<b>SEM NO.</b>	
26.230 26.270	81962100100	<b>7489</b>	
		<b>Description</b>	
		Rubber Metal Buffer	
			D=Ø50 h=45 M10x34
<b>Type / Model</b>	<b>REF. NO.</b>	<b>SEM NO.</b>	
19.240 26.240	81962100130	<b>7514</b>	
		<b>Description</b>	
		Rubber Metal Buffer	
			D=Ø 50 h= 45 M10x34 Shore A70



SEM NO.	REF. NO.	Type / Model
7547	81962100119	19.422
<b>Description</b>		
Metal Buffer		



D=Ø50 h=30 M10x25

SEM NO.	REF. NO.	Type / Model
8399	81962100220	
<b>Description</b>		
Rubber Metal		



D=Ø30 h=15 M 8x22

SEM NO.	REF. NO.	Type / Model
7559	83779900003	
<b>Description</b>		
Rubber Packing		









140x50x5

SEM NO.	REF. NO.	Type / Model
7560	83779900004	
<b>Description</b>		
Rubber Packing		

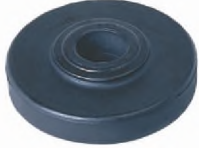

A=200 B=50 h=5

<b>Type / Model</b>	<b>REF. NO.</b>	<b>SEM NO.</b>	
26.280	81964200170	7336	
			<b>Description</b> Bellows
			D=Ø120 h=110
<b>Type / Model</b>	<b>REF. NO.</b>	<b>SEM NO.</b>	
26.281 26.321	81964200156	7395	
			<b>Description</b> Bellows
			D=Ø130 d=Ø120 h=100
<b>Type / Model</b>	<b>REF. NO.</b>	<b>SEM NO.</b>	
	81964200374 83964200502	7721	
			<b>Description</b> Bellows
<b>Type / Model</b>	<b>REF. NO.</b>	<b>SEM NO.</b>	
	83083010002	7567	
			<b>Description</b> Gasket
<b>Type / Model</b>	<b>REF. NO.</b>	<b>SEM NO.</b>	
26.281 SL 200	81962100270 81962100244	7496	
			<b>Description</b> Rubber Metal Mounting
			D=Ø50 d=Ø13 h=11.5 SHORE A70
<b>Type / Model</b>	<b>REF. NO.</b>	<b>SEM NO.</b>	
19.372 19.422 26.270 33.372	81962100289 83962100508	7548	
			<b>Description</b> Rubber Metal Buffer
			D=Ø30 h=20 M8x23

	ŞEM NO.	REF. NO.	Type / Model
	7484	81965010831 0039976948	
	<b>Description</b> Toric Seal		
D=Ø30 d=Ø4.5			

	ŞEM NO.	REF. NO.	Type / Model
	7544	81965010585	
	<b>Description</b> Gasket		
Ø 127.5    Ø 145.5    12.3			

	ŞEM NO.	REF. NO.	Type / Model
	7810	81083040084	
	<b>Description</b> Gasket		
D=Ø 355			

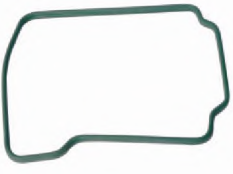
	ŞEM NO.	REF. NO.	Type / Model
	7354	51961010048	26.280 26.281 SL 200 SR 240
	<b>Description</b> Gasket (Q. Silicone)		

	ŞEM NO.	REF. NO.	Type / Model
	7435		26.281
	<b>Description</b> Repair Kit (Q. Silicone)		

	ŞEM NO.	REF. NO.	Type / Model
	7557	83966010005	
	<b>Description</b> Gasket		
240x160			

Type / Model	REF. NO.	SEM NO.	
SG 220	81962100230	7591	
			
			<b>Description</b> Rubber Metal Buffer
			Ø 75x25 M12x37



ŞEM NO.	REF. NO.	Type / Model
9958	51065007066S	TGA 18.310 TGA 18.360 TGA 18.410

**Description**  
Water Pump Repair Kit



Q 135 mm

ŞEM NO.	REF. NO.	Type / Model
9964	51065996081	26.230 26.270 32.270

**Description**  
Water Pump Repair Kit



Q 135 mm

ŞEM NO.	REF. NO.	Type / Model
9965	51065996013	S 2000 FORTUNA

**Description**  
Water Pump Repair Kit



Q 135 mm

ŞEM NO.	REF. NO.	Type / Model
9966	51065996033	19.422 SL 283

**Description**  
Water Pump Repair Kit



ŞEM NO.	REF. NO.	Type / Model
9967	51065007066S1	TGA 18.310 TGA 18.360 TGA 18.410



**Description**  
Seal



ŞEM NO.	REF. NO.	Type / Model
10806	51065007049S 51065996086	TGA

**Description**  
Repair Kit for Water Pump

Type / Model	REF. NO.	SEM NO.	
	51065200037	11347	
		<b>Description</b>	
		Seal With Thrust Ring And Boat	
			Q. 16 mm

	SEM NO.	REF. NO.	Type / Model
 115x120x21	11339	51021300013	
	<b>Description</b> Intermediate Ring / Rear		
 100x105x18	11341	51021300012 51021300032	
	<b>Description</b> Intermediate Ring / Front		



Type / Model	REF. NO.	SEM NO.	
19.372 19.422 26.270 33.372	81964200324	7602	 <b>Description</b> Bellows D=Ø230 d=Ø32
	81964200529 81964200440	7735	 <b>Description</b> Bellows
	81326160007 81326160002 81326160005 81326160006	7640	 <b>Description</b> insul Material Elemente D=Ø242 h=80
	81326160008 81326160004 81326160011 81326160013	7695	 <b>Description</b> Insul Material Elemente
19.422 19.423 26.270	81326706199	10023	 <b>Description</b> Gear Shift Repair Kit

ŞEM NO.	REF. NO.	Type / Model
<b>8328</b>	81466106725	
	85466106102	
	85466106201	
	85466106030	
<b>Description</b>		
Tie Rod		
L 826 mm M16x1,5 M24x1,5 K 20		







ŞEM NO.	REF. NO.	Type / Model
<b>8329</b>	81467106112	81467116725
	81467106163	81467116849
	81467106354	
	81467106353	
	81467106198	
	81467106165	
	81467106361	
	81467116820	
<b>Description</b>		
Tie Rod		
L 1652 mm M30x1,5 M24x1,5 K 30		

ŞEM NO.	REF. NO.	Type / Model
<b>9335</b>	81466106722	81466106216
	81466106360	81466106723
	81466106334	81466116216
	81466106333	
	81466106354	
	81466106361	
	81466106355	
	81466106721	
<b>Description</b>		
Tie Rod		
L=1040 koni=38 boru=48		

ŞEM NO.	REF. NO.	Type / Model
<b>9338</b>	81467116860	81467116882
	81467116859	81467116863
	81467116921	
	81467116883	
	81467116861	
	81467116858	
	81467116773	
	81467116920	
<b>Description</b>		
Tie Rod		
L=1679 koni=30 boru=52		







ŞEM NO.	REF. NO.	Type / Model
<b>10132</b>	81467106122	81467106195
	81467106379	81467106912
	81467116736	81467106378
	81467106380	81467106953
	81467106167	81467116830
	81467106830	81467116747
	81467106194	81467106911
	81467106836	81467106134
<b>Description</b>		
Tie Rod		
L 1588 mm		







ŞEM NO.	REF. NO.	Type / Model
<b>10134</b>	81467106865	
	81467106866	
	81467116717	
	81467116728	
<b>Description</b>		
Tie Rod		
L 1670 mm		

Type / Model	REF. NO.	SEM NO.	
	81466106779 81466106782 81466106780	10135	 <b>Description</b> Tie Rod L 1045 mm
Type / Model	REF. NO.	SEM NO.	
	81467106994 81467116726	10136	 <b>Description</b> Tie Rod L 1664 mm
Type / Model	REF. NO.	SEM NO.	
	81466116133 81466116097 81466116132 81466116087 81466116197 81466116096 81466116198	10137	 <b>Description</b> Tie Rod L 995 mm
Type / Model	REF. NO.	SEM NO.	
LEMFORDER	81466106790 82466106191 81466106791	10869	 <b>Description</b> Tie Rod
Type / Model	REF. NO.	SEM NO.	
LEMFORDER	81466106798 81466106876 81466106578 81466106704 81466106705 81466106799	10870	 <b>Description</b> Tie Rod
Type / Model	REF. NO.	SEM NO.	
	81466116202 81466116138 81466116139 81466116145 81466116201 81466116203	11558	 <b>Description</b> Tie Rod







SEM NO.	REF. NO.	Type / Model
11559	81466106708	
	81466116067	
 <p><b>Description</b> Tie Rod</p>		
SEM NO.	REF. NO.	Type / Model
11953	85466106246	
	85466106160	
 <p><b>Description</b> Tie Rod</p>		
L=864	1- 8633	Page 488

Type / Model	REF. NO.	REF. NO.		SEM NO.	Description	Image
F2000 / M2000	81953010016	81953016149	81953016352	<b>8631</b>		
F90 / M90	81953010084	81953016108	81953016278			
TGA	81953016048	81953016154	81953010075			
SG / SL	81953016112	81953016194	81953010088			
SR / SU	81953016049	81953016156	81953016206			
	81953016126	81953016224	81953016242			
	81953016053	81953016178	81953016308			
	81953016143	81953016234	81953016350			
	81953016090	81953016274	81953016312			
M30Xx1.5 RHT L=120						
Type / Model	REF. NO.	REF. NO.		SEM NO.	Description	Image
F2000 / M2000	81953016237	81953016091	81953016155	<b>8632</b>		
F90 / M90	81953016087	81953016107	81953016223			
TGA	81953010015	81953016120	81953016157			
SG / SL	81953016030	81953016279	81953016351			
SR / SU	81953016043	81953016125	81953016168			
	81953010083	81953016158	81953016275			
	81953016050	81953016152				
	81953016054	81953016179				
M30Xx1.5 RHT L=120						
Type / Model	REF. NO.	REF. NO.		SEM NO.	Description	Image
L2000	81953016060			<b>8633</b>		
G90	81953016240					
M2000	81953016140					
	81953016135					
	81953016249					
M28x1.5 RHT L=105						
Type / Model	REF. NO.	REF. NO.		SEM NO.	Description	Image
EM / NM	81953010079			<b>8634</b>		
L2000	81953016139					
M2000	81953016222					
F2000						
M28x1.5 RHT L=105						
Type / Model	REF. NO.	REF. NO.		SEM NO.	Description	Image
EM / NM	81953010014	81953010068		<b>8635</b>		
L2000 / M2000	81953010064	82953016014				
F2000	81953016067					
G90	81953016162					
	81953016239					
	90804153111					
	81953016360					
	81953010042					
M30x1.5 RHT L=115						
Type / Model	REF. NO.	REF. NO.		SEM NO.	Description	Image
EM / NM	81953010013			<b>8636</b>		
L2000	81953010074					
M2000 / F2000	81953016068					
G90	81953013107					
	90804153113					
	81953016361					
	81953016163					
M30x1.5 LHT L=115						





	SEM NO.	REF. NO.	Type / Model
 M24x1.5 RHT L=95	<b>8637</b>	81953010077 81953016134 81953016303 81953016142 81953016321	L2000
	<b>Description</b>		
 M24x1.5 LHT L=95	<b>8638</b>	81953010078 81953016304 81953016141	L2000
	<b>Description</b>		
 M30x1.5 RHT L=120	<b>8639</b>	81953010025 90804154117	
	<b>Description</b>		
 M30x1.5 LHT L=120	<b>8640</b>	81953016070 81953016261	
	<b>Description</b>		
 M38x1.5 RHT L=135	<b>10140</b>	81953016295	
	<b>Description</b>		
 M30x1.5 RHT L=160	<b>10150</b>	81953016263	
	<b>Description</b>		





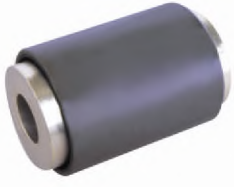

Type / Model	REF. NO.	ŞEM NO.	
	81953016225 81953016219 81953016267 81953016226 81953016291	<b>10871</b>	 <b>Description</b> Rot End
Type / Model	REF. NO.	ŞEM NO.	
	81953016064 81953016130 81953016170 81953016173	<b>10931 (10933)</b>	 <b>Description</b> Rot End
Type / Model	REF. NO.	ŞEM NO.	
	81953016063 81953016131 81953016171 81953016174	<b>10937 (10939)</b>	 <b>Description</b> Rot End
Type / Model	REF. NO.	ŞEM NO.	
	81953010038 81953010045 81953016016 81953016169 81953016172 81953016176	<b>10943 (10945)</b>	 <b>Description</b> Rot End
Type / Model	REF. NO.	ŞEM NO.	
	81953016202	<b>11257</b>	 <b>Description</b> Tie Rod
Type / Model	REF. NO.	ŞEM NO.	
	81953016184	<b>11560</b>	 <b>Description</b> Rod End









	SEM NO.	REF. NO.	Type / Model
	11563	81953016288	
	<b>Description</b>		
	Rod End		
	SEM NO.	REF. NO.	Type / Model
	11575	81953016095 81953016071	
	<b>Description</b>		
	Rod End		
	SEM NO.	REF. NO.	Type / Model
	11579	81953016286	
	<b>Description</b>		
	Rod End		
	SEM NO.	REF. NO.	Type / Model
	11580	81953016270	
	<b>Description</b>		
	Rod End		
	SEM NO.	REF. NO.	Type / Model
	12912	 81953016271 81953016325	
	<b>Description</b>		
	Rod End		

L=150

<b>Type / Model</b>	<b>REF. NO.</b>	<b>SEM NO.</b>	
	81437220044 81437220061 83437220001	<b>1015</b>	
			<b>Description</b> Spring Eye Bushing
			D=70 d=24 h=95
<b>Type / Model</b>	<b>REF. NO.</b>	<b>SEM NO.</b>	
	81437220062	<b>1026</b>	
			<b>Description</b> Spring Eye Bushing
			D=70 d=24 h=105
<b>Type / Model</b>	<b>REF. NO.</b>	<b>SEM NO.</b>	
	81437220070 81962100616 81962100617	<b>7920</b>	
			<b>Description</b> Spring Eye Bushing
			D=Ø65 d=Ø24 h=95
<b>Type / Model</b>	<b>REF. NO.</b>	<b>SEM NO.</b>	
	81437220087 81962100634	<b>9232</b>	
			<b>Description</b> Spring Eye Bushing
			D=Ø65 d=Ø24 h=100
<b>Type / Model</b>	<b>REF. NO.</b>	<b>SEM NO.</b>	
	81437220060	<b>9233</b>	
			<b>Description</b> Spring Eye Bushing
			D=Ø57 d=Ø20 h=84
<b>Type / Model</b>	<b>REF. NO.</b>	<b>SEM NO.</b>	
	85437220011	<b>9234</b>	
			<b>Description</b> Spring Eye Bushing
			D=Ø57 d=Ø20 h=86

 <p>D=Ø57 d=Ø18 h=86</p>	<table border="1"> <thead> <tr> <th>SEM NO.</th> <th>REF. NO.</th> </tr> </thead> <tbody> <tr> <td>9235</td> <td>85437220009 81962100557</td> </tr> </tbody> </table> <p><b>Description</b> Spring Eye Bushing</p>	SEM NO.	REF. NO.	9235	85437220009 81962100557	<table border="1"> <thead> <tr> <th>Type / Model</th> </tr> </thead> </table>	Type / Model
SEM NO.	REF. NO.						
9235	85437220009 81962100557						
Type / Model							
 <p>D=Ø62 d=Ø24 h=95</p>	<table border="1"> <thead> <tr> <th>SEM NO.</th> <th>REF. NO.</th> </tr> </thead> <tbody> <tr> <td>9236</td> <td>81437220091</td> </tr> </tbody> </table> <p><b>Description</b> Spring Eye Bushing</p>	SEM NO.	REF. NO.	9236	81437220091	<table border="1"> <thead> <tr> <th>Type / Model</th> </tr> </thead> </table>	Type / Model
SEM NO.	REF. NO.						
9236	81437220091						
Type / Model							
 <p>D=Ø62 d=Ø20 h=95</p>	<table border="1"> <thead> <tr> <th>SEM NO.</th> <th>REF. NO.</th> </tr> </thead> <tbody> <tr> <td>9237</td> <td>81437220092</td> </tr> </tbody> </table> <p><b>Description</b> Spring Eye Bushing</p>	SEM NO.	REF. NO.	9237	81437220092	<table border="1"> <thead> <tr> <th>Type / Model</th> </tr> </thead> </table>	Type / Model
SEM NO.	REF. NO.						
9237	81437220092						
Type / Model							
 <p>D=Ø60,5 d=Ø18 h=86</p>	<table border="1"> <thead> <tr> <th>SEM NO.</th> <th>REF. NO.</th> </tr> </thead> <tbody> <tr> <td>10810</td> <td>85437220010 85437220008</td> </tr> </tbody> </table> <p><b>Description</b> Spring Bushing</p>	SEM NO.	REF. NO.	10810	85437220010 85437220008	<table border="1"> <thead> <tr> <th>Type / Model</th> </tr> </thead> </table>	Type / Model
SEM NO.	REF. NO.						
10810	85437220010 85437220008						
Type / Model							
 <p>D=Ø57 d=Ø20 h=84</p>	<table border="1"> <thead> <tr> <th>SEM NO.</th> <th>REF. NO.</th> </tr> </thead> <tbody> <tr> <td>7856</td> <td>81437220051 81437220078 81437220079</td> </tr> </tbody> </table> <p><b>Description</b> Spring Eye Bushing</p>	SEM NO.	REF. NO.	7856	81437220051 81437220078 81437220079	<table border="1"> <thead> <tr> <th>Type / Model</th> </tr> </thead> </table>	Type / Model
SEM NO.	REF. NO.						
7856	81437220051 81437220078 81437220079						
Type / Model							
 <p>D=Ø50 d=Ø16 h=95</p>	<table border="1"> <thead> <tr> <th>SEM NO.</th> <th>REF. NO.</th> </tr> </thead> <tbody> <tr> <td>7725</td> <td>81960200250 81960200231 81960200252</td> </tr> </tbody> </table> <p><b>Description</b> Rubber Buffer</p>	SEM NO.	REF. NO.	7725	81960200250 81960200231 81960200252	<table border="1"> <thead> <tr> <th>Type / Model</th> </tr> </thead> </table>	Type / Model
SEM NO.	REF. NO.						
7725	81960200250 81960200231 81960200252						
Type / Model							

<b>Type / Model</b>	<b>REF. NO.</b>	<b>SEM NO.</b>	
	81413040043 81413040008 81434200014	<b>11596</b>	
		<b>Description</b>	
		Spring Bushing	
			D = Ø30 d = Ø25 L = 77
<b>Type / Model</b>	<b>REF. NO.</b>	<b>SEM NO.</b>	
	81413040042 81434200000	<b>11597</b>	
		<b>Description</b>	
		Spring Bushing	
			D = Ø30 d = Ø25 L = 87
<b>Type / Model</b>	<b>REF. NO.</b>	<b>SEM NO.</b>	
	81413040041 81413040032	<b>11598</b>	
		<b>Description</b>	
		Spring Bushing	
			D = Ø36 d = Ø30 L = 77
<b>Type / Model</b>	<b>REF. NO.</b>	<b>SEM NO.</b>	
	81413040044 81413040052	<b>11599</b>	
		<b>Description</b>	
		Spring Bushing	
			D = Ø36 d = Ø30 L = 87
<b>Type / Model</b>	<b>REF. NO.</b>	<b>SEM NO.</b>	
	81413040040 81413040038 81434200012	<b>11600</b>	
		<b>Description</b>	
		Spring Bushing	
			D = Ø36 d = Ø30 L = 97
<b>Type / Model</b>	<b>REF. NO.</b>	<b>SEM NO.</b>	
	81413040037 81413040031	<b>11601</b>	
		<b>Description</b>	
		Spring Bushing	
			D = Ø46 d = Ø40 L = 97

	SEM NO.	REF. NO.	Type / Model
 D = Ø48 d = Ø42 L = 95	11602	81413040020	
	<b>Description</b> Spring Bushing		

	SEM NO.	REF. NO.	Type / Model
 D = Ø48 d = Ø44 L = 95	11603	81413040050 81413040035 81413040029	
	<b>Description</b> Spring Bushing		

	SEM NO.	REF. NO.	Type / Model
 M20x2x280 mm	10041	06014934937	33.372
	<b>Description</b> Screw- Steel		

	SEM NO.	REF. NO.	Type / Model
 M 20x2x210 mm	10042	06014934930	33.372
	<b>Description</b> Screw- Steel		

	SEM NO.	REF. NO.	Type / Model
 M20x2x250 mm	10047	06014990218	26.321
	<b>Description</b> Screw		

	SEM NO.	REF. NO.	Type / Model
 M20x2x320 mm	10048	06014990179	19.422
	<b>Description</b> Screw		

Type / Model	REF. NO.	SEM NO.	
	81440500123	<b>10308</b>	
	81455030026		
	81455030049		
	81455030056		
	N1011057266		
	N1011057267		
		<b>Description</b>	
		Nut	
			M22x1,5

Type / Model	REF. NO.	SEM NO.	
	06112140127	<b>10416</b>	
	06112400130		
	06112402130		
	06112410130		
		<b>Description</b>	
		Nut	
			M24x2

	SEM NO.	REF. NO.	Type / Model
 D=Ø96 d=Ø19 h=96	7281	81960206006	19.190
		81960200110	19.372
		81960200172	19.472
		81907110192	26.281
	<b>Description</b>	81960200136	
	Rubber Buffer	81960206013	







	SEM NO.	REF. NO.	Type / Model
 Ø 104x50	7325	81960200091	SL 200
			SR 240
<b>Description</b>			
Hollow Rubber Spring			

	SEM NO.	REF. NO.	Type / Model
 D=Ø 110 d=Ø 30 h= 45	7515	81960200186	19.422
			52.232
	<b>Description</b>		
Rubber Buffer			

	SEM NO.	REF. NO.	Type / Model
 D=Ø123 h=45	7569	81962100479	S 2000
	<b>Description</b>		
Rubber Metal Buffer			

	SEM NO.	REF. NO.	Type / Model
 D=Ø100 h=130	7571	81960206008	19.422
		81960200266	33.372
		83960200501	
		83960206501	
	<b>Description</b>		
Rubber Buffer			

	SEM NO.	REF. NO.	Type / Model
 95x70x86 d=Ø15	7464	81962100194	19.372
		81962100361	26.270
	<b>Description</b>		
Rubber Metal Plate			

<b>Type / Model</b>	<b>REF. NO.</b>	<b>SEM NO.</b>	
	81414010055 81414010050	<b>8130</b>	
			<b>Description</b> Spring Mounting
<b>Type / Model</b>	<b>REF. NO.</b>	<b>SEM NO.</b>	
19.422	81962100402	<b>7525</b>	
			<b>Description</b> Rubber Metal Mounting
			84,5x74,5x41 M12x1.5
<b>Type / Model</b>	<b>REF. NO.</b>	<b>SEM NO.</b>	
	81960200042	<b>7542</b>	
			<b>Description</b> Rubber Buffer
			A=60 B=35 h=20
<b>Type / Model</b>	<b>REF. NO.</b>	<b>SEM NO.</b>	
SI222 SL232	83960200008	<b>7552</b>	
			<b>Description</b> Rubber Buffer
			A=135 B=110 h=50
<b>Type / Model</b>	<b>REF. NO.</b>	<b>SEM NO.</b>	
33.372	81962100379	<b>7558</b>	
			<b>Description</b> Rubber Metal Plate
			170x78x42
<b>Type / Model</b>	<b>REF. NO.</b>	<b>SEM NO.</b>	
26.281 26.321	81414010036	<b>7634</b>	
			<b>Description</b> Rubber Metal Plate



	SEM NO.	REF. NO.	Type / Model
	<b>7734</b>	81434070109 83434070509 81434075003 81434070110	
	<b>Description</b>		
			Spring Mounting
A=110 B=84 h=13			







	SEM NO.	REF. NO.	Type / Model
	<b>7815</b>	81434006484 83960200506	
	<b>Description</b>		
			Spring Bushing
A=80 B=105 h=13			







	SEM NO.	REF. NO.	Type / Model
	<b>7858</b>	81434070102	
	<b>Description</b>		
			Spring Mounting
A=100 B=140 h=17.5			



	SEM NO.	REF. NO.	Type / Model
	<b>8004</b>	81434070132	
	<b>Description</b>		
			Spring Mounting
A=127 B=110 H=35			







	SEM NO.	REF. NO.	Type / Model
	<b>8604</b>	81961010695	
	<b>Description</b>		
			Spring Mounting
120x85 h=19 M10x37			

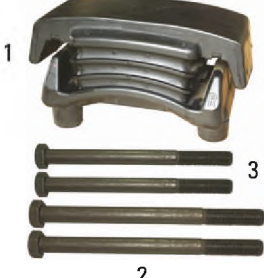



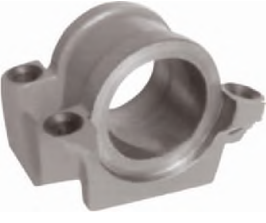

	SEM NO.	REF. NO.	Type / Model
	<b>8623</b>	85434070004	
	<b>Description</b>		
			Rubber Metal Plate
A=90 B=70 h=12			

<b>Type / Model</b>	<b>REF. NO.</b>	<b>SEM NO.</b>	
	85434070003	8624	
			<b>Description</b> Rubber Metal Plate
			A=90 B=66 h=12
<b>Type / Model</b>	<b>REF. NO.</b>	<b>SEM NO.</b>	
	81960200230	11003	
			<b>Description</b> Rubber Buffer
			080.190 D=Ø70 L=80
<b>Type / Model</b>	<b>REF. NO.</b>	<b>SEM NO.</b>	
	81962100552 81962100551 81962100541	9043	
			<b>Description</b> Pur Mounting
			D=Ø100 D=Ø120 d=Ø15 h=85 M12x1,5
<b>Type / Model</b>	<b>REF. NO.</b>	<b>SEM NO.</b>	
	81962100540 81962100539	9246	
			<b>Description</b> Pur Mounting
			D=Ø100 h=85
<b>Type / Model</b>	<b>REF. NO.</b>	<b>SEM NO.</b>	
	85962100025 85962100038	9247	
			<b>Description</b> Pur Mounting
			D=Ø68 d=Ø17 h=72
<b>Type / Model</b>	<b>REF. NO.</b>	<b>SEM NO.</b>	
	85962100039	11585	
			<b>Description</b> Pur Mounting
			h=85

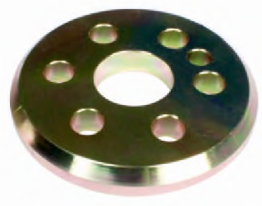
	<b>SEM NO.</b>  7934	<b>REF. NO.</b> 81962105022 81962105021 81962105023	<b>Type / Model</b>	
	<b>Description</b> Spring Bushing			
	<b>SEM NO.</b>  8180	<b>REF. NO.</b> 81962100554 81962100547	<b>Type / Model</b>	
	<b>Description</b> Spring Mounting (Right)			
	<b>SEM NO.</b>  8181	<b>REF. NO.</b> 81962100555 81962100548	<b>Type / Model</b>	
	<b>Description</b> Spring Mounting (Left)			
	<b>SEM NO.</b>  10930	<b>REF. NO.</b> 81962100550	<b>Type / Model</b>	
	<b>Description</b> Spring Mounting			
<p>M20x2 Ax=182x125 L=127</p>				
	<b>SEM NO.</b>  11778		<b>REF. NO.</b> 81962105025 81962105026 81962105027	<b>Type / Model</b>
	<b>Description</b> Spring Mounting			
<p>M20x2 Ax1=182/125 d=Ø17 Ax2=170/60 h=139</p>				
	<b>SEM NO.</b>  8446	<b>REF. NO.</b> 06014944935	<b>Type / Model</b>	
	<b>Description</b> Spring Bolt			
<p>M.20x2 h=260 10,9</p>				







Type / Model	REF. NO.	SEM NO.	
	06014944933	8447	
		<b>Description</b>	
		Spring Bolt	
			M20x2 h=240 10,9
Type / Model	REF. NO.	SEM NO.	
26.281	06014934932	8611 (10046)	
		<b>Description</b>	
		Bolt	
			M20x2 h=230
Type / Model	REF. NO.	SEM NO.	
	81962100554S 06014944935S 060149449332S 81962100547S	8448	
1-8180 2-8447 3-8446		<b>Description</b>	
		Repair Kit for Spring - Right	
Type / Model	REF. NO.	SEM NO.	
	81962100555S 060149449352S1 060149449332S1 81962100548S	8449	
1-8181 2-8447 3-8446		<b>Description</b>	
		Repair Kit for Spring - Left	

	<table border="1"> <thead> <tr> <th>SEM NO.</th> <th>REF. NO.</th> </tr> </thead> <tbody> <tr> <td>9484</td> <td>81413500009</td> </tr> </tbody> </table>	SEM NO.	REF. NO.	9484	81413500009	<table border="1"> <thead> <tr> <th>Type / Model</th> </tr> </thead> <tbody> <tr> <td>26.281 33.321</td> </tr> </tbody> </table>	Type / Model	26.281 33.321
SEM NO.	REF. NO.							
9484	81413500009							
Type / Model								
26.281 33.321								
<p><b>Description</b> Leaf Spring Bearing</p>								
	<table border="1"> <thead> <tr> <th>SEM NO.</th> <th>REF. NO.</th> </tr> </thead> <tbody> <tr> <td>9485</td> <td>81413500018</td> </tr> </tbody> </table>	SEM NO.	REF. NO.	9485	81413500018	<table border="1"> <thead> <tr> <th>Type / Model</th> </tr> </thead> <tbody> <tr> <td>33.372</td> </tr> </tbody> </table>	Type / Model	33.372
SEM NO.	REF. NO.							
9485	81413500018							
Type / Model								
33.372								
<p><b>Description</b> Leaf Spring Bearing</p>								
	<table border="1"> <thead> <tr> <th>SEM NO.</th> <th>REF. NO.</th> </tr> </thead> <tbody> <tr> <td>9503</td> <td>81413500017</td> </tr> </tbody> </table>	SEM NO.	REF. NO.	9503	81413500017	<table border="1"> <thead> <tr> <th>Type / Model</th> </tr> </thead> <tbody> <tr> <td>TGA</td> </tr> </tbody> </table>	Type / Model	TGA
SEM NO.	REF. NO.							
9503	81413500017							
Type / Model								
TGA								
<p><b>Description</b> Leaf Spring Bearing</p>								
<p>d=150</p>								
	<table border="1"> <thead> <tr> <th>SEM NO.</th> <th>REF. NO.</th> </tr> </thead> <tbody> <tr> <td>9486</td> <td>81413520009</td> </tr> </tbody> </table>	SEM NO.	REF. NO.	9486	81413520009	<table border="1"> <thead> <tr> <th>Type / Model</th> </tr> </thead> <tbody> <tr> <td>33.372</td> </tr> </tbody> </table>	Type / Model	33.372
SEM NO.	REF. NO.							
9486	81413520009							
Type / Model								
33.372								
<p><b>Description</b> Cover for Leaf Spring</p>								
	<table border="1"> <thead> <tr> <th>SEM NO.</th> <th>REF. NO.</th> </tr> </thead> <tbody> <tr> <td>9487</td> <td>81413520002</td> </tr> </tbody> </table>	SEM NO.	REF. NO.	9487	81413520002	<table border="1"> <thead> <tr> <th>Type / Model</th> </tr> </thead> <tbody> <tr> <td>26.281 26.321</td> </tr> </tbody> </table>	Type / Model	26.281 26.321
SEM NO.	REF. NO.							
9487	81413520002							
Type / Model								
26.281 26.321								
<p><b>Description</b> Cover for Leaf Spring</p>								
	<table border="1"> <thead> <tr> <th>SEM NO.</th> <th>REF. NO.</th> </tr> </thead> <tbody> <tr> <td>10028</td> <td>81413020030</td> </tr> </tbody> </table>	SEM NO.	REF. NO.	10028	81413020030	<table border="1"> <thead> <tr> <th>Type / Model</th> </tr> </thead> <tbody> <tr> <td>TGA</td> </tr> </tbody> </table>	Type / Model	TGA
SEM NO.	REF. NO.							
10028	81413020030							
Type / Model								
TGA								
<p><b>Description</b> Cover</p>								









Type / Model	REF. NO.	SEM NO.	
33.372	81413020021	10807	 <p><b>Description</b> Pull for Saddle Shaft</p>
26.281 26.321	81917100125	9488	 <p><b>Description</b> Cover for Leaf Spring</p> <p>d=Ø128 D=Ø145 h=10</p>
26.281 26.321	81907100057	9489	 <p><b>Description</b> Cover for Leaf Spring</p>
26.281 26.321	81413550001	9490	 <p><b>Description</b> Nut</p>
26.281	81354010059	9491	 <p><b>Description</b> Metal Pin</p>
33.372	81354010089	9492	 <p><b>Description</b> Metal Pin</p>







	<table border="1"> <thead> <tr> <th>SEM NO.</th> <th>REF. NO.</th> <th>Type / Model</th> </tr> </thead> <tbody> <tr> <td>10015</td> <td>06324890011</td> <td>26.281</td> </tr> </tbody> </table>	SEM NO.	REF. NO.	Type / Model	10015	06324890011	26.281	<table border="1"> <thead> <tr> <th>Type / Model</th> </tr> </thead> <tbody> <tr> <td>26.281</td> </tr> </tbody> </table>	Type / Model	26.281
SEM NO.	REF. NO.	Type / Model								
10015	06324890011	26.281								
Type / Model										
26.281										
60 ROKVEL Ø90x140	<p><b>Description</b> Tapared Roller Bearing (Steel)</p>									
	<table border="1"> <thead> <tr> <th>SEM NO.</th> <th>REF. NO.</th> <th>Type / Model</th> </tr> </thead> <tbody> <tr> <td>10016</td> <td>06369590027</td> <td>33.372</td> </tr> </tbody> </table>	SEM NO.	REF. NO.	Type / Model	10016	06369590027	33.372	<table border="1"> <thead> <tr> <th>Type / Model</th> </tr> </thead> <tbody> <tr> <td>33.372</td> </tr> </tbody> </table>	Type / Model	33.372
SEM NO.	REF. NO.	Type / Model								
10016	06369590027	33.372								
Type / Model										
33.372										
60 ROKVEL Ø95x145	<p><b>Description</b> Tapared Roller Bearing (Steel)</p>									
	<table border="1"> <thead> <tr> <th>SEM NO.</th> <th>REF. NO.</th> <th>Type / Model</th> </tr> </thead> <tbody> <tr> <td>10013</td> <td>81413015054</td> <td>26.281 26.321</td> </tr> </tbody> </table>	SEM NO.	REF. NO.	Type / Model	10013	81413015054	26.281 26.321	<table border="1"> <thead> <tr> <th>Type / Model</th> </tr> </thead> <tbody> <tr> <td>26.281 26.321</td> </tr> </tbody> </table>	Type / Model	26.281 26.321
SEM NO.	REF. NO.	Type / Model								
10013	81413015054	26.281 26.321								
Type / Model										
26.281 26.321										
<p><b>Description</b> Console</p>										
	<table border="1"> <thead> <tr> <th>SEM NO.</th> <th>REF. NO.</th> <th>Type / Model</th> </tr> </thead> <tbody> <tr> <td>10014</td> <td>81413015106</td> <td>33.372</td> </tr> </tbody> </table>	SEM NO.	REF. NO.	Type / Model	10014	81413015106	33.372	<table border="1"> <thead> <tr> <th>Type / Model</th> </tr> </thead> <tbody> <tr> <td>33.372</td> </tr> </tbody> </table>	Type / Model	33.372
SEM NO.	REF. NO.	Type / Model								
10014	81413015106	33.372								
Type / Model										
33.372										
<p><b>Description</b> Console</p>										
	<table border="1"> <thead> <tr> <th>SEM NO.</th> <th>REF. NO.</th> <th>Type / Model</th> </tr> </thead> <tbody> <tr> <td>10024</td> <td>81413010241</td> <td>TGA</td> </tr> </tbody> </table>	SEM NO.	REF. NO.	Type / Model	10024	81413010241	TGA	<table border="1"> <thead> <tr> <th>Type / Model</th> </tr> </thead> <tbody> <tr> <td>TGA</td> </tr> </tbody> </table>	Type / Model	TGA
SEM NO.	REF. NO.	Type / Model								
10024	81413010241	TGA								
Type / Model										
TGA										
<p><b>Description</b> Console</p>										
	<table border="1"> <thead> <tr> <th>SEM NO.</th> <th>REF. NO.</th> <th>Type / Model</th> </tr> </thead> <tbody> <tr> <td>10009</td> <td>81413200092</td> <td>33.372</td> </tr> </tbody> </table>	SEM NO.	REF. NO.	Type / Model	10009	81413200092	33.372	<table border="1"> <thead> <tr> <th>Type / Model</th> </tr> </thead> <tbody> <tr> <td>33.372</td> </tr> </tbody> </table>	Type / Model	33.372
SEM NO.	REF. NO.	Type / Model								
10009	81413200092	33.372								
Type / Model										
33.372										
<p><b>Description</b> Spring Seat (Thick)</p>										



<b>Type / Model</b>	<b>REF. NO.</b>	<b>SEM NO.</b>	
33.372	81413200089	<b>10010</b>	
			<b>Description</b> Spring Seat (Thin)
<b>Type / Model</b>	<b>REF. NO.</b>	<b>SEM NO.</b>	
26.321	81422400099 83432400500	<b>10011</b>	
			<b>Description</b> Spring Seat
<b>Type / Model</b>	<b>REF. NO.</b>	<b>SEM NO.</b>	
26.281 26.321	81413200065	<b>10012</b>	
			<b>Description</b> Spring Seat
<b>Type / Model</b>	<b>REF. NO.</b>	<b>SEM NO.</b>	
26.281	81414050012	<b>10017</b>	
			<b>Description</b> Plate
<b>Type / Model</b>	<b>REF. NO.</b>	<b>SEM NO.</b>	
26.281 26.321	81414050004	<b>10018</b>	
			<b>Description</b> Plate - Thin
			Q= 12 mm
<b>Type / Model</b>	<b>REF. NO.</b>	<b>SEM NO.</b>	
26.281 26.321	81414050004S	<b>10019</b>	
			<b>Description</b> Plate - Thick
			Q= 20 mm



	<b>SEM NO.</b>	<b>REF. NO.</b>	<b>Type / Model</b>
	10020	81434110010	26.281 26.321
<b>Description</b>			
Plate L - R			
	<b>SEM NO.</b>	<b>REF. NO.</b>	<b>Type / Model</b>
	11393	81413120081	
<b>Description</b>			
Spring Bolt (U)			
M24x101x365			
	<b>SEM NO.</b>	<b>REF. NO.</b>	<b>Type / Model</b>
	11394	81413120100	
<b>Description</b>			
Spring Bolt (U)			
M18x91x220			
	<b>SEM NO.</b>	<b>REF. NO.</b>	<b>Type / Model</b>
	11768	 06151400107	
<b>Description</b>			
Metal Washer			
D=Ø44 d=Ø25 h=8			
	<b>SEM NO.</b>	<b>REF. NO.</b>	<b>Type / Model</b>
	11769	 06110640222	
<b>Description</b>			
Nut			
M24x2			
	<b>SEM NO.</b>	<b>REF. NO.</b>	<b>Type / Model</b>
	11770	 06112890003	
<b>Description</b>			
Nut			
M18x2			

Type / Model	REF. NO.	SEM NO.	
SL 200 SR 240	81432710033	7388	 <p><b>Description</b> Bush</p> <p>D=Ø75 d=Ø55 h=83</p>
SL 200 SR 240	81432710074 81432710056	7389	 <p><b>Description</b> Bush</p> <p>D=Ø68 d=Ø42 h=69</p>
SG 220 S2000	81442040020 81442040021	7439	 <p><b>Description</b> Bush</p> <p>D=Ø68 d=Ø58 h=80</p>
	81442040012 81442040004	7521	 <p><b>Description</b> Bush</p> <p>D=Ø68 d=Ø42 h=68</p>
SL 200	81433160021	7617	 <p><b>Description</b> Bush</p> <p>D=Ø74.5 d=Ø55 h=84.5</p>
TGA TGX TGS	81962100508 81962100507 81962100535	9087	 <p><b>Description</b> Bush</p> <p>D=Ø201 d=Ø120 L=99</p>

SEM NO.	REF. NO.	Type / Model
7437	81432710027S	Alternative Design
	81432710082S	
<b>Description</b>		
Stabilizer Bush		16.280 19.280 26.280 26.321

Ø65-Ø21 Ax=125

SEM NO.	REF. NO.	Type / Model
7500	81991648844	
<b>Description</b>		
Stabilizer Bush		

D=Ø 45 d=Ø 19 Ax=100

SEM NO.	REF. NO.	Type / Model
7501	81432710028S	Alternative Design
	81432710087S	
<b>Description</b>		
Stabilizer Bush		

D=Ø 65 d=Ø 19 Ax=130

SEM NO.	REF. NO.	Type / Model
7511	81432710082	26.270 33.372
	81432710027	
<b>Description</b>		
Stabilizer Bush		

D=Ø 65 d=Ø 21 Ax=125

SEM NO.	REF. NO.	Type / Model
7512	81432710083	33.372
	81432710046	
	81432710079	
<b>Description</b>		
Stabilizer Bush		





D=Ø 75 d=Ø 21 Ax=125





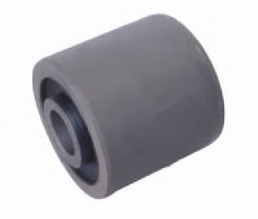

SEM NO.	REF. NO.	Type / Model
7526	81432710028	19.422
	81432710087	
<b>Description</b>		
Stabilizer Bush		

D=Ø65 d=Ø19 130







Type / Model	REF. NO.	SEM NO.	
16.281	81432710078	7530	 <b>Description</b> Ball Joint D=Ø75 d=Ø19 Ax=130
19.281	81432710032		
19.321			
Type / Model	REF. NO.	SEM NO.	
	81962100452 81991648844S	7576	 <b>Description</b> Stabilizer Bush D=Ø47 d=Ø19 Ax=99
Type / Model	REF. NO.	SEM NO.	
	81432710080	7603	 <b>Description</b> Stabilizer Bush D=Ø65 d=Ø15 Ax=100
Type / Model	REF. NO.	SEM NO.	
	81432206177S1 81432206179S1 81432206224S1	7708	 <b>Description</b> Stabilizer Bush D=Ø 67 Cone=Ø 36 L=83
Type / Model	REF. NO.	SEM NO.	
	81432206177S 81432206179S 81432206224S 81432206178S 81432206225S 81432206335S1 81432206164S 81432206165S	81432206166S 81432206215S 81432206227S 81432206228S 81432206180S	7709 (10894) <b>Description</b> Stabilizer Bush D=Ø67 d=Ø15 Ax=80
Type / Model	REF. NO.	SEM NO.	
	81962100511	7837	 <b>Description</b> Stabilizer Bush D=Ø47 d=Ø21 Ax=101

 D=Ø73 d=Ø19 Ax=100	<b>ŞEM NO.</b> <b>7964 (8498)</b>	<b>REF. NO.</b> 81436350003	<b>Type / Model</b>
 D=Ø53 d=Ø17 Ax=88	<b>ŞEM NO.</b> <b>10058</b>	<b>REF. NO.</b> 81962100609	<b>Type / Model</b>
 D=Ø67 M14x1,5 AX=80	<b>ŞEM NO.</b> <b>10895</b>	<b>REF. NO.</b> 81432206335S2 81432206180S1	<b>Type / Model</b>
 D=Ø 76 L= 194 M 14x1.5	<b>ŞEM NO.</b> <b>7505</b>	<b>REF. NO.</b> 81432710085 81432710035	<b>Type / Model</b>
 D=Ø83,5 d=Ø56 h=174	<b>ŞEM NO.</b> <b>7922</b>	<b>REF. NO.</b> 81433160027	<b>Type / Model</b>
 D=Ø64 d=Ø19 B=86 Ax=124	<b>ŞEM NO.</b> <b>7633 (10823)</b>	<b>REF. NO.</b> 36962100006	<b>Type / Model</b>
 D=Ø45 d=Ø16 h=42	<b>ŞEM NO.</b> <b>7436</b>	<b>REF. NO.</b> 81432710029 81432710008	<b>Type / Model</b> 16.280 19.280 26.230 26.280



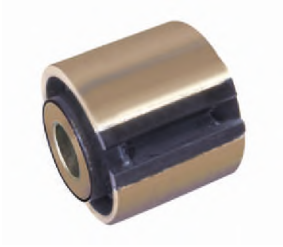



<b>Type / Model</b>	<b>REF. NO.</b>	<b>SEM NO.</b>	
19.422	81437220019 81437226051	<b>7527</b>	
			<b>Description</b> Stabilizer Bush
			Ø 75-Ø 22 h=62
<b>Type / Model</b>	<b>REF. NO.</b>	<b>SEM NO.</b>	
19.422	81437220021 81437220046	<b>7528</b>	
			<b>Description</b> Stabilizer Bush
			Ø 65-Ø 22 h=62
<b>Type / Model</b>	<b>REF. NO.</b>	<b>SEM NO.</b>	
19.372	81437220022	<b>7529</b>	
19.422	81962100469		
22.360	81437220038		
33.372			
			<b>Description</b> Stabilizer Bush
			D=Ø45 d=Ø16 h=47
<b>Type / Model</b>	<b>REF. NO.</b>	<b>SEM NO.</b>	
	81432710022	<b>7546</b>	
	81432710021		
	81432710011		
			<b>Description</b> Stabilizer Bush
			D=Ø55 d=Ø18 h=55
<b>Type / Model</b>	<b>REF. NO.</b>	<b>SEM NO.</b>	
	85437220007	<b>10212</b>	
			<b>Description</b> Rubber Metal Bush
			D=Ø42,5 d=Ø14 h=35
<b>Type / Model</b>	<b>REF. NO.</b>	<b>SEM NO.</b>	
	81437186824S	<b>10908</b>	
			<b>Description</b> Stabilizer Bush
			D=Ø43 d=Ø18 h=47





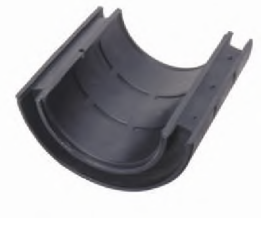

	<b>SEM NO.</b>	<b>REF. NO.</b>	<b>Type / Model</b>
	7248	81962100063	520 19.190 20.190 22.190
D=Ø34.5 d=Ø16 h= 43	<p><b>Description</b> Rubber Metal Buffer</p>		
	<b>SEM NO.</b>	<b>REF. NO.</b>	<b>Type / Model</b>
	7933 (10824)	36962100007	
D=Ø78 d=Ø30 h=78	<p><b>Description</b> Silent Block</p>		
	<b>SEM NO.</b>	<b>REF. NO.</b>	<b>Type / Model</b>
	11991	 81437185133S 82437185028S	
D=Ø70 d=Ø30 L=62	<p><b>Description</b> Rubber Metal Bush</p>		
	<b>SEM NO.</b>	<b>REF. NO.</b>	<b>Type / Model</b>
	7545	81962100450	22.360 33.372 S 2000
D=Ø47 d=Ø16 h=47	<p><b>Description</b> Stabilizer Bush</p>		
	<b>SEM NO.</b>	<b>REF. NO.</b>	<b>Type / Model</b>
	7622	81437220039	19.422 19.423 33.423
D=Ø67 d=Ø22 L=62	<p><b>Description</b> Stabilizer Bush</p>		
	<b>SEM NO.</b>	<b>REF. NO.</b>	<b>Type / Model</b>
	7673	81437220047	
D=Ø64 d=Ø24 h=44	<p><b>Description</b> Stabilizer Bush</p>		















<b>Type / Model</b>	<b>REF. NO.</b>	<b>SEM NO.</b>	
	81437220063 81437220082	<b>7689</b>	
		<b>Description</b>	
		Stabilizer Bush	D=Ø68 d=Ø22 h=62
<b>Type / Model</b>	<b>REF. NO.</b>	<b>SEM NO.</b>	
	81437220059	<b>7702</b>	
		<b>Description</b>	
		Stabilizer Bush	D=Ø50 d=Ø16 h=47
<b>Type / Model</b>	<b>REF. NO.</b>	<b>SEM NO.</b>	
	81962100618	<b>10425</b>	
		<b>Description</b>	
		Stabilizer Bush	D=Ø47 d=Ø18 h=47
<b>Type / Model</b>	<b>REF. NO.</b>	<b>SEM NO.</b>	
	81962100448	<b>7700</b>	
		<b>Description</b>	
		Ball Joint	D=Ø95 d=Ø26 h=75 M=24x2
<b>Type / Model</b>	<b>REF. NO.</b>	<b>SEM NO.</b>	
	81437220085	<b>9628</b>	
		<b>Description</b>	
		Stabilizer Mounting	D=Ø96 d=Ø24 L=95
<b>Type / Model</b>	<b>REF. NO.</b>	<b>SEM NO.</b>	
19.422 33.372 S 2000	81437040057	<b>7502</b>	
		<b>Description</b>	
		Stabilizer Bush (Half)	D=Ø 67 d=Ø 44 h= 60



	<b>SEM NO.</b> 7503	<b>REF. NO.</b> 81437040061 81437220020	<b>Type / Model</b> 19.422 19.463
	<b>Description</b> Stabilizer Bush (Half)		
D=Ø 78 d=Ø 60 h= 60			
	<b>SEM NO.</b> 7504	<b>REF. NO.</b> 81432710081	<b>Type / Model</b> 19.372
	<b>Description</b> Stabilizer Bush (Half)		
D=Ø 93 d=Ø 56 h= 70			
	<b>SEM NO.</b> 7531	<b>REF. NO.</b> 81437040045 81437040028	<b>Type / Model</b> 19.422
	<b>Description</b> Stabilizer Bush (Half)		
D=Ø87 d=Ø55 h=80			
	<b>SEM NO.</b> 7532	<b>REF. NO.</b> 81437040060	<b>Type / Model</b>
	<b>Description</b> Stabilizer Bush (Half)		
D=Ø77 d=Ø55 h=60			
	<b>SEM NO.</b> 7621	<b>REF. NO.</b> 81437040044 81437040042	<b>Type / Model</b>
	<b>Description</b> Stabilizer Bush (Half)		
D=Ø82 d=Ø55 h=70			
	<b>SEM NO.</b> 7620	<b>REF. NO.</b> 81437220040 81437220042 81437220041	<b>Type / Model</b> 33.372
	<b>Description</b> Stabilizer Bush		
D=Ø82 d=Ø55 h=70			

<b>Type / Model</b>	<b>REF. NO.</b>	<b>SEM NO.</b>	 Description Stabilizer Bush D=Ø64 d=Ø45 h=51
	81437040074	7808	
<b>Type / Model</b>	<b>REF. NO.</b>	<b>SEM NO.</b>	 Description Stabilizer Bush D=Ø84 d=Ø50 h=72
	81437220068 81437220069 81437220080	7824	
<b>Type / Model</b>	<b>REF. NO.</b>	<b>SEM NO.</b>	 Description Stabilizer Bushing D=Ø76 d=Ø52 h=50
	81437040077	7865	
<b>Type / Model</b>	<b>REF. NO.</b>	<b>SEM NO.</b>	 Description Stabilizer Bush D=Ø76 d=Ø46 h=50
	81437040078	7953	
<b>Type / Model</b>	<b>REF. NO.</b>	<b>SEM NO.</b>	 Description Stabilizer Bush D=Ø76 d=Ø43 h=50
	81437040079	8015	
<b>Type / Model</b>	<b>REF. NO.</b>	<b>SEM NO.</b>	 Description Stabilizer Bushing D=Ø88 d=Ø60 h=60
	81437220083	8146	

	<p><b>SEM NO.</b> <b>10787</b></p> <p><b>Description</b> Torsion Bar to Shackle</p>	<p><b>REF. NO.</b> 81437180043</p>	<p><b>Type / Model</b> TGA</p>
	<p><b>SEM NO.</b> <b>10788</b></p> <p><b>Description</b> Torsion Bar to Shackle</p>	<p><b>REF. NO.</b> 81437180044</p>	<p><b>Type / Model</b> TGA</p>
 <p>D=Ø110 d=Ø40 h=23</p>	<p><b>SEM NO.</b> <b>7516</b></p> <p><b>Description</b> Bearing Cap</p>	<p><b>REF. NO.</b> 81432710038 81432710086</p>	<p><b>Type / Model</b></p>
 <p>D=Ø100 d=Ø40 h=14</p>	<p><b>SEM NO.</b> <b>7517</b></p> <p><b>Description</b> Bearing Cap</p>	<p><b>REF. NO.</b> 81432710040</p>	<p><b>Type / Model</b> SL 200</p>
 <p>D=Ø37,5 d=Ø14 h=51</p>	<p><b>SEM NO.</b> <b>7704</b></p> <p><b>Description</b> Stabilizer Bush</p>	<p><b>REF. NO.</b> 81960200286 81437040039 81942992220</p>	<p><b>Type / Model</b></p>
 <p>D=Ø34 d=Ø12 h=32</p>	<p><b>SEM NO.</b> <b>8503</b></p> <p><b>Description</b> Rubber Buffer</p>	<p><b>REF. NO.</b> 81962100294</p>	<p><b>Type / Model</b></p>

<b>Type / Model</b>	<b>REF. NO.</b>	<b>SEM NO.</b>	
	81962100278	<b>8212</b>	
		<b>Description</b>	
		Stabilizer Bush	
			D=27 h=50,5
<b>Type / Model</b>	<b>REF. NO.</b>	<b>SEM NO.</b>	
	85437040005	<b>10259</b>	
		<b>Description</b>	
		Stabilizer Bushing	
<b>Type / Model</b>	<b>REF. NO.</b>	<b>SEM NO.</b>	
	81437220053 81437220053	<b>7723</b>	
		<b>Description</b>	
		Stabilizer Bush	
			D=Ø56 d=Ø39 h=60
<b>Type / Model</b>	<b>REF. NO.</b>	<b>SEM NO.</b>	
	81437220052	<b>8188</b>	
		<b>Description</b>	
		Stabilizer Bush	
			D=Ø56 d=Ø34 h=60
<b>Type / Model</b>	<b>REF. NO.</b>	<b>SEM NO.</b>	
	81437040094 81437220081	<b>10426</b>	
		<b>Description</b>	
		Stabilizer Rubber	
			D=Ø55 d=Ø35 h=51
<b>Type / Model</b>	<b>REF. NO.</b>	<b>SEM NO.</b>	
TGL 8 TGL 12	85437040002	<b>10427</b>	
		<b>Description</b>	
		Stabilizer Rubber	
			D=Ø55 d=Ø32 h=46

	SEM NO.	REF. NO.	Type / Model
	10438	85437040004	
	<b>Description</b>		
	Stabilizer Rubber		
D=Ø52 d=Ø38 L=46			







	SEM NO.	REF. NO.	Type / Model
	8504	81437040053	
	<b>Description</b>		
	Rubber Buffer		
D=Ø57 d=Ø36 h=65			

	SEM NO.	REF. NO.	Type / Model
	8505	81437040038	
	<b>Description</b>		
	Rubber Buffer		
D=Ø55 d=Ø40 h=52			





	SEM NO.	REF. NO.	Type / Model
	8528	81437040052	
	<b>Description</b>		
	Rubber Bushing		
D=Ø56 d=Ø32 h=51			

	SEM NO.	REF. NO.	Type / Model
	9128	81962100278S 81962100294S	
	<b>Description</b>		
	Stabilizer Repair Kit		



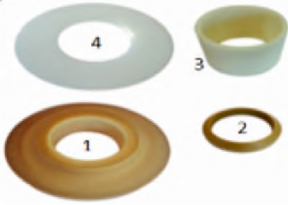



	SEM NO.	REF. NO.	Type / Model
	7573	81437040025	
	<b>Description</b>		
	Burcu Stabilizer Bush		
D=Ø80 d=Ø55 h=80			

<b>Type / Model</b>	<b>REF. NO.</b>	<b>SEM NO.</b>	
	81437040029	7574	
		<b>Description</b>	
		Stabilizer Bush	
			D=Ø71 d=Ø46 h=80
<b>Type / Model</b>	<b>REF. NO.</b>	<b>SEM NO.</b>	
	81437040026	7575	
		<b>Description</b>	
		Stabilizer Bush	
			D=Ø66 d=Ø39 h=75
<b>Type / Model</b>	<b>REF. NO.</b>	<b>SEM NO.</b>	
	81437040032	8032	
		<b>Description</b>	
		Stabilizer Bush	
			D=Ø70 d=Ø60 h=80
<b>Type / Model</b>	<b>REF. NO.</b>	<b>SEM NO.</b>	
	36960220000	11588	
		<b>Description</b>	
		Plastic Bushing	
<b>Type / Model</b>	<b>REF. NO.</b>	<b>SEM NO.</b>	
	36432400003	11589	
		<b>Description</b>	
		Plastic Pad	
<b>Type / Model</b>	<b>REF. NO.</b>	<b>SEM NO.</b>	
	36432400006	11806	
		<b>Description</b>	
		Pur Mounting	













	<p><b>ŞEM NO.</b> 11807</p>	<p><i>new product</i></p>	<p><b>REF. NO.</b> 36960220001</p>	<p><b>Type / Model</b></p>
<p><b>Description</b> Plastic Pad</p>				
	<p><b>ŞEM NO.</b> 11808</p>	<p><i>new product</i></p>	<p><b>REF. NO.</b> 36432400006S 36960220001S 36960220000S 36432400003S</p>	<p><b>Type / Model</b></p>
<p><b>Description</b> Pur Kit</p>				<p>1-11806 2-11807 3-11588 4-11589</p>
	<p><b>ŞEM NO.</b> 10260</p>	<p><b>REF. NO.</b> 81432206177 81432206224 81432206179</p>	<p><b>Type / Model</b></p>	<p>S 2000</p>
<p><b>Description</b> Stabilizer Rod</p>				<p>1- 7708 Page 71 2- 7709 Page 71</p>
<p>L=330 Cone=Ø 36 d=15 Ax=80</p>				
	<p><b>ŞEM NO.</b> 10842</p>	<p><b>REF. NO.</b> 81432206294</p>	<p><b>Type / Model</b></p>	
<p><b>Description</b> Axle Rod</p>				<p>1- 7708 Page 71</p>
<p>L=330 Cone=Ø 36</p>				
	<p><b>ŞEM NO.</b> 10893</p>	<p><b>REF. NO.</b> 81432206335 81432206180</p>	<p><b>Type / Model</b></p>	
<p><b>Description</b> Stabilizer Rod</p>				<p>1 - 7709 Page 71 2 - 10895 Page 72</p>
<p>M14x1,5 d=Ø15 AX=80 L=470</p>				
	<p><b>ŞEM NO.</b> 11817</p>	<p><i>new product</i></p>	<p><b>REF. NO.</b> 81432206215    81432206227 81432206164    81432206228 81432206165    81432206215 81432206166</p>	<p><b>Type / Model</b></p>
<p><b>Description</b> Axle Rod</p>				<p>1- 7709 Page 71</p>
<p>L=413 d=15/15 Ax=80/80</p>				



Type / Model	REF. NO.	SEM NO.	
	81432206178 81432206225	<b>11992</b>	
			<b>Description</b> Axle Rod
	1 - 7709 Page 71		L=470 d=Ø15/15 Ax=80/80
			
	81437186821	<b>10670</b>	<b>Description</b> Stabilizer Rod
	1 - 7545 Page 74 2 - 10425 Page 75		L=390
			
	81437186823 81437186824	<b>10671</b>	<b>Description</b> Stabilizer Rod
	1 - 10425 Page 75		L=430
			
	81437186825	<b>10672</b>	<b>Description</b> Stabilizer Rod
	1 - 10425 Page 75		L=390
			
	85437186014	<b>10673</b>	<b>Description</b> Stabilizer Rod
	1 - 10212 Page 73		L=345
			
	85437186015	<b>10674</b>	<b>Description</b> Stabilizer Rod
	1 - 10212 Page 73		L=345



	SEM NO.		REF. NO.	Type / Model
 1	11989		81437185133	
	<b>Description</b> Stabilizer Rod		1 - 11991 Page 74	
	SEM NO.		REF. NO.	Type / Model
 1	11990		82437185028	
	<b>Description</b> Stabilizer Rod		1 - 11991 Page 74	

<b>Type / Model</b>	<b>REF. NO.</b>	<b>SEM NO.</b>	
	81432206202	<b>8036</b>	 <p><b>Description</b> Ball Joint (Kit)</p> <p>D=Ø67 d=Ø17 Ax=100</p>
<b>Type / Model</b>	<b>REF. NO.</b>	<b>SEM NO.</b>	
	81432206197	<b>8527 (9209)</b>	 <p><b>Description</b> Ball Joint (Kit)</p> <p>D=Ø67 d=Ø15 Ax=100</p>
<b>Type / Model</b>	<b>REF. NO.</b>	<b>SEM NO.</b>	
	81432706089	<b>9077</b>	 <p><b>Description</b> Ball Joint (Kit)</p> <p>D=Ø67 d=Ø19 Ax=115</p>
<b>Type / Model</b>	<b>REF. NO.</b>	<b>SEM NO.</b>	
	81953020038 81953020057	<b>9081</b>	 <p><b>Description</b> Ball Joint (Kit)</p> <p>D=Ø67 d=Ø15 Ax=100</p>
<b>Type / Model</b>	<b>REF. NO.</b>	<b>SEM NO.</b>	
	81432206315	<b>9595</b>	 <p><b>Description</b> Ball Joint (Kit)</p> <p>D=Ø67 d=Ø19 Ax=130</p>
<b>Type / Model</b>	<b>REF. NO.</b>	<b>SEM NO.</b>	
	85432206004S	<b>11972</b>	  <p><b>Description</b> Ball Joint (Kit)</p> <p>D=Ø67 d=Ø17 Ax=100</p>





	ŞEM NO.	REF. NO.	Type / Model
 <p>D=Ø72 d=Ø19 Ax=130</p>	<b>8035</b>	81432206108S 81432206132S 81432206109S 81432206290S	
	<b>Description</b>		Ball Joint (Kit)
 <p>D=Ø75 d=Ø17 Ax=115</p>	<b>7595 (7754)</b>	81432306051 81432306068 81432706064 81432306072	
	<b>Description</b>		Ball Joint (Kit)
 <p>D=Ø75 d=Ø19 Ax=130</p>	<b>7635 (7763)</b>	81432306061	
	<b>Description</b>		Ball Joint (Kit)
 <p>D=Ø75 d=Ø19 Ax=115</p>	<b>7949 (9206)</b>	81432706091	
	<b>Description</b>		Ball Joint (Kit)
 <p>D=Ø75 d=Ø17 Ax=115</p>	<b>8213</b>	81432206244	
	<b>Description</b>		Ball Joint (Kit)
 <p>D=Ø75 d=Ø23 Ax=152</p>	<b>8313</b>	81432706100	
	<b>Description</b>		Ball Joint (Kit)







<b>Type / Model</b>	<b>REF. NO.</b>	<b>SEM NO.</b>	
	81432706119	8465 (8612)	
			<b>Description</b> Ball Joint (Kit) D=Ø75 d=Ø19 Ax=115
<b>Type / Model</b>	<b>REF. NO.</b>	<b>SEM NO.</b>	
	85432206002	9083 (9084)	
			<b>Description</b> Ball Joint (Kit) D=Ø75 d=Ø19 Ax=130
<b>Type / Model</b>	<b>REF. NO.</b>	<b>SEM NO.</b>	
	81432706097S	9613	
			<b>Description</b> Ball Joint (Kit) D=Ø75 d=Ø23 Ax=130
<b>Type / Model</b>	<b>REF. NO.</b>	<b>SEM NO.</b>	
Alternatively Rubber 19.422	81432306043S	7506	
			<b>Description</b> Ball Joint (Kit) D=Ø 80 d=Ø 19 Ax= 130
<b>Type / Model</b>	<b>REF. NO.</b>	<b>SEM NO.</b>	
26.280	81432206055	7335	
26.281	81953020037		
26.321	81953020059		
33.372	81432206073		
S2000	81953100009 06290200206		
			<b>Description</b> Ball Joint (Kit) D=Ø85 d=Ø19 Ax=130
<b>Type / Model</b>	<b>REF. NO.</b>	<b>SEM NO.</b>	
S 2000	81432206203	7565	
			<b>Description</b> Ball Joint (Kit) D=Ø85 d=Ø21 Ax=130

 <p>D=Ø85 d=Ø20x26 Ax=130</p>	<table border="1"> <thead> <tr> <th>ŞEM NO.</th> <th>REF. NO.</th> <th>Type / Model</th> </tr> </thead> <tbody> <tr> <td>7607</td> <td>81953020077</td> <td>S 2000</td> </tr> </tbody> </table> <p><b>Description</b> Ball Joint (Kit)</p>	ŞEM NO.	REF. NO.	Type / Model	7607	81953020077	S 2000	
ŞEM NO.	REF. NO.	Type / Model						
7607	81953020077	S 2000						
 <p>D=Ø85 d=Ø25 Ax=130</p>	<table border="1"> <thead> <tr> <th>ŞEM NO.</th> <th>REF. NO.</th> <th>Type / Model</th> </tr> </thead> <tbody> <tr> <td>7850 (11802)</td> <td>81432706105 81432706124 81432706150S2</td> <td></td> </tr> </tbody> </table> <p><b>Description</b> Ball Joint (Kit)</p>	ŞEM NO.	REF. NO.	Type / Model	7850 (11802)	81432706105 81432706124 81432706150S2		
ŞEM NO.	REF. NO.	Type / Model						
7850 (11802)	81432706105 81432706124 81432706150S2							
 <p>D=Ø85 d=Ø19 Ax=130</p>	<table border="1"> <thead> <tr> <th>ŞEM NO.</th> <th>REF. NO.</th> <th>Type / Model</th> </tr> </thead> <tbody> <tr> <td>7919</td> <td>81432206250 81432206369</td> <td></td> </tr> </tbody> </table> <p><b>Description</b> Ball Joint (Kit)</p>	ŞEM NO.	REF. NO.	Type / Model	7919	81432206250 81432206369		
ŞEM NO.	REF. NO.	Type / Model						
7919	81432206250 81432206369							
 <p>D=Ø85 d=Ø25 Ax=152</p>	<table border="1"> <thead> <tr> <th>ŞEM NO.</th> <th>REF. NO.</th> <th>Type / Model</th> </tr> </thead> <tbody> <tr> <td>7954</td> <td>81432706101 81432706139 81432706109</td> <td></td> </tr> </tbody> </table> <p><b>Description</b> Ball Joint (Kit)</p>	ŞEM NO.	REF. NO.	Type / Model	7954	81432706101 81432706139 81432706109		
ŞEM NO.	REF. NO.	Type / Model						
7954	81432706101 81432706139 81432706109							
 <p>D=Ø85 d=Ø23 Ax=130</p>	<table border="1"> <thead> <tr> <th>ŞEM NO.</th> <th>REF. NO.</th> <th>Type / Model</th> </tr> </thead> <tbody> <tr> <td>7959 (9000)</td> <td>81432706126</td> <td></td> </tr> </tbody> </table> <p><b>Description</b> Ball Joint (Kit)</p>	ŞEM NO.	REF. NO.	Type / Model	7959 (9000)	81432706126		
ŞEM NO.	REF. NO.	Type / Model						
7959 (9000)	81432706126							
 <p>D=Ø85 d=Ø19 Ax=130</p>	<table border="1"> <thead> <tr> <th>ŞEM NO.</th> <th>REF. NO.</th> <th>Type / Model</th> </tr> </thead> <tbody> <tr> <td>8216 (8815-9442)</td> <td>81432706127 81432206104 81432206107</td> <td></td> </tr> </tbody> </table> <p><b>Description</b> Ball Joint (Kit)</p>	ŞEM NO.	REF. NO.	Type / Model	8216 (8815-9442)	81432706127 81432206104 81432206107		
ŞEM NO.	REF. NO.	Type / Model						
8216 (8815-9442)	81432706127 81432206104 81432206107							

<b>Type / Model</b>	<b>REF. NO.</b>	<b>SEM NO.</b>	
	81432706133 81953020041 81953020042	<b>8222 (9097)</b>	
			<b>Description</b> Ball Joint (Kit) D=Ø85 d=Ø21 Ax=130
<b>Type / Model</b>	<b>REF. NO.</b>	<b>SEM NO.</b>	
	81432206285	<b>8970</b>	
			<b>Description</b> Ball Joint (Kit) D=Ø85 d=Ø25 Ax=130
<b>Type / Model</b>	<b>REF. NO.</b>	<b>SEM NO.</b>	
	81432706057S	<b>9045</b>	
			<b>Description</b> Ball Joint (Kit) D=Ø85 d=Ø23 Ax=152
<b>Type / Model</b>	<b>REF. NO.</b>	<b>SEM NO.</b>	
Alternatively Rubber Type	81953016133S	<b>8174</b>	
			<b>Description</b> Ball Joint (Kit) D=Ø90 d=Ø23 Ax=152
<b>Type / Model</b>	<b>REF. NO.</b>	<b>SEM NO.</b>	
	81432706040 81432706045 81432706069	<b>7550 (7747)</b>	
			<b>Description</b> Ball Joint (Kit) D=Ø95 d=Ø21 Ax=152
<b>Type / Model</b>	<b>REF. NO.</b>	<b>SEM NO.</b>	
	81433150009 S 81433156040 S	<b>7698</b>	
			<b>Description</b> Ball Joint (Kit) D=Ø95 d=Ø19 Ax=145



 <p>D=Ø95 d=Ø23 Ax=152</p>	<p><b>SEM NO.</b> <b>7879</b></p> <p><b>Description</b> Ball Joint (Kit)</p>	<p><b>REF. NO.</b> 81432706079</p>	<p><b>Type / Model</b></p>
 <p>D=Ø95 d=Ø19 Ax=130</p>	<p><b>SEM NO.</b> <b>7888</b></p> <p><b>Description</b> Ball Joint (Kit)</p>	<p><b>REF. NO.</b> 81964010152</p>	<p><b>Type / Model</b></p>
 <p>D=Ø95 d=Ø21 Ax=130</p>	<p><b>SEM NO.</b> <b>8616 (9619)</b></p> <p><b>Description</b> Ball Joint (Kit)</p>	<p><b>REF. NO.</b> 81432206241</p>	<p><b>Type / Model</b></p>
 <p>D=Ø95 d=Ø25 Ax=152</p>	<p><b>SEM NO.</b> <b>11801</b></p> <p><b>Description</b> Ball Joint (Kit)</p>	<p><b>REF. NO.</b> 81432706150S1</p> <p><i>new product</i></p>	<p><b>Type / Model</b></p>
 <p>D=Ø100 d=Ø25 Ax=152</p>	<p><b>SEM NO.</b> <b>7682</b></p> <p><b>Description</b> Ball Joint (Kit)</p>	<p><b>REF. NO.</b> 81432706110</p>	<p><b>Type / Model</b></p>
 <p>D=Ø94 d=Ø19 Ax=130</p>	<p><b>SEM NO.</b> <b>7604</b></p> <p><b>Description</b> Ball Joint</p>	<p><b>REF. NO.</b> 81962100447</p>	<p><b>Type / Model</b> S 2000</p>

<b>Type / Model</b>	<b>REF. NO.</b>	<b>SEM NO.</b>	<b>Description</b>	
	81432506017	<b>11940</b>	Ball Joint (Kit)	D=Ø55 d=Ø20 L=60
				
<b>Type / Model</b>	<b>REF. NO.</b>	<b>SEM NO.</b>	<b>Description</b>	
S 2000	81432206204	<b>7597</b>	Ball Joint (Kit)	D=Ø 95 B=53,5 L=73
<b>Type / Model</b>	<b>REF. NO.</b>	<b>SEM NO.</b>	<b>Description</b>	
	81432206263	<b>9095</b>	Ball Joint (Kit)	D=Ø67 L=95
<b>Type / Model</b>	<b>REF. NO.</b>	<b>SEM NO.</b>	<b>Description</b>	
	81432306060	<b>9098</b>	Ball Joint (Kit)	D=Ø85 L=250 Cone=48
<b>Type / Model</b>	<b>REF. NO.</b>	<b>SEM NO.</b>	<b>Description</b>	
	81864200227	<b>7912</b>	Dust Cover	









Description / Ball Joint (Repair Kit)	SEM NO.	Model:
	<p><b>7727</b></p> <p>REF. NO: 81432506009</p> <p>Ø90</p>	

Description / Ball Joint (Repair Kit)	SEM NO.	Model:
	<p><b>11819</b></p> <p>REF. NO: 81432206140S1</p>	<p><i>new</i> product</p>

Model:	SEM NO.	Description / Ball Joint (Repair Kit)
	<b>7736</b>	
	<b>REF. NO:</b> 81432206108 81432206132 81432206109 81432206290	
	D=Ø72 d=Ø19 Ax=130	
	<b>7829</b>	
	<b>REF. NO:</b> 81432706065	
	Ø72	
	<b>9578</b>	
TGA TGX TGS	<b>REF. NO:</b> 81432206322	
	D=Ø72 d=Ø23 Ax=130	
	<b>7783</b>	
	<b>REF. NO:</b> 81432306043	
	D=Ø 80	

Description / Ball Joint (Repair Kit)	SEM NO.	Model:
	<p><b>7827</b></p> <p>REF. NO: 81953016132 81432706122</p> <p>Ø90</p>	
	<p><b>7851</b></p> <p>REF. NO: 81432706080</p> <p>D=Ø90</p>	
	<p><b>7852</b></p> <p>REF. NO: 81953016133</p> <p>D=Ø90</p>	
	<p><b>9092 (9093)</b></p> <p>REF. NO: 81432706047</p> <p>D=Ø90</p>	

Type / Model	REF. NO.	SEM NO.	
1- 7736 Page 93	81432206129	<b>8043</b>	
	81432206096		
	81432206097		
	81432206098		
	81432306014		
	81432306030		
	81432209096		
	81432209129		L=571 d=Ø19/19 Ax=130/130
		<b>Description</b>	Axle Rod
Type / Model	REF. NO.	SEM NO.	
1- 7635 Page 86	81432206129S	<b>8044</b>	
	81432206096S		
	81432206097S		
	81432206098S		
	81432306014S		
	81432306030S		
	81432209096S		
	81432209129S		L=577 d=Ø19/19 Ax=130/130
		<b>Description</b>	Axle Rod Alternative Rubber
Type / Model	REF. NO.	SEM NO.	
1- 7783 Page 93	81432306037	<b>8045</b>	
	81432309037		
		<b>Description</b>	Axle Rod
			L=500 d=Ø19/19 Ax=130/130
Type / Model	REF. NO.	SEM NO.	
Alternatively Rubber Type 1- 7506 Page 87	81432306037S	<b>8046</b>	
	81432309037S		
		<b>Description</b>	Axle Rod Alternative Rubber
			L=500 d=Ø19/19 Ax=130/130
Type / Model	REF. NO.	SEM NO.	
1- 7335 Page 87	81432206042	<b>8053</b>	
		<b>Description</b>	Axle Rod
			L=762 d=Ø19/19 Ax=130/130
Type / Model	REF. NO.	SEM NO.	
1- 7335 Page 87	81432206052	<b>8059</b>	
	81432206028		
	81432206020		
	81432206035		
	81432206013		
	81432206040		
	81432206012		
	81432206041		
	81432206056		
	81432306018		
		<b>Description</b>	Axle Rod
			L=565 d=Ø19/19 Ax=130/130



L=590 d=Ø19/19 Ax=130/130

SEM NO.	REF. NO.	Type / Model
<b>8060</b>	81432206090 81432209092 81432206067 81432206068 81432206092	
<b>Description</b>		
Axle Rod Alternative Rubber		1- 7335 Page 87



L=455 d=Ø19/19 Ax=130/130

SEM NO.	REF. NO.	Type / Model
<b>8061</b>	81432206025	
<b>Description</b>		
Axle Rod		1- 7335 Page 87



L=585 d=Ø21/21 Ax=130/130

SEM NO.	REF. NO.	Type / Model
<b>8067</b>	81432206070 81432206071 81432206072 81432206091 81432206093 81432206119	
<b>Description</b>		
Axle Rod		1- 8616 Page 90



L=740 d=Ø17/17 Ax=115/115

SEM NO.	REF. NO.	Type / Model
<b>8921</b>	81432306000 83432306501 36432306001	
<b>Description</b>		
Axle Rod		1- 7595 Page 86



L=630 d=Ø19 Ax=130







SEM NO.	REF. NO.	Type / Model
<b>8922 (9354)</b>	81432206220 83432206502 81432206125 81432206112 81432206127 81432206123	
<b>Description</b>		
Axle Rod		1- 7335 87 2- 7597 91



L=622 d=Ø19/19 Ax=130/130

SEM NO.	REF. NO.	Type / Model
<b>8948</b>	81432206275 81432206258 81432206264 81432206279 81432206278	
<b>Description</b>		
Axle Rod		1- 8216 Page 88



Type / Model	REF. NO.	ŞEM NO.	
1- 7335 Page 87	81432206185	<b>8951</b>	
	81432206100		
	81432206099		
	81432206103		
	81432206113		
	81432206114		
	81432206143		
81432206173			L=750 d=Ø19/19 Ax=130/ 130
Type / Model	REF. NO.	ŞEM NO.	
1- 7335 Page 87	81432206183	<b>8954</b>	
	81432206276		
	81432206151		
	81432206277		
	81432206139		
Type / Model	REF. NO.	ŞEM NO.	
1- 7736 Page 93 2- 11819 Page 92	81432206140	<b>9353</b>	
	81432209140		
			L=596 d=Ø19/18,5 Ax=130/110
Type / Model	REF. NO.	ŞEM NO.	
1- 8036 Page 85	81432206216	<b>9355</b>	
			L=540 d=Ø17/17 Ax=100/100
Type / Model	REF. NO.	ŞEM NO.	
1- 9083 Page 87	81432206268	<b>9356</b>	
	81432206291		
	81432206274		
	81432206292		
	81432206268		
			L=572 d=Ø19/19 Ax=130/130
Type / Model	REF. NO.	ŞEM NO.	
1- 7736 Page 93	81432206272	<b>9357</b>	
	81432209272		
	81432206236		
	81432209236		
	81432206267		
	81432209267		
			L=566 d=Ø19/19 Ax=130/130

	ŞEM NO.	REF. NO.	Type / Model
 <p><b>9358</b></p> <p><b>Description</b> Axle Rod</p> <p>L=572 d=Ø19/19 Ax=130/130</p>		81432206229 81432206304 81432206305	
			1- 9083 Page 87







	ŞEM NO.	REF. NO.	Type / Model
 <p><b>9359</b></p> <p><b>Description</b> Axle Rod Alternative Rubber</p> <p>L=531 d=Ø19/19 Ax=130/130</p>		81432206161 81432206190 81432206358 81432206359	
			1- 7335 Page 87

	ŞEM NO.	REF. NO.	Type / Model
 <p><b>9360</b></p> <p><b>Description</b> Axle Rod Alternative Rubber</p> <p>L=614 d=Ø19/19 Ax=130/130</p>		81432206189 81432206144	
			1- 7335 Page 87

	ŞEM NO.	REF. NO.	Type / Model
 <p><b>9361</b></p> <p><b>Description</b> Axle Rod Alternative Rubber</p> <p>L=941 d=Ø17/17 Ax=115/115</p>		81432206222 81432206284	
			1- 8213 Page 86

	ŞEM NO.	REF. NO.	Type / Model
 <p><b>9362</b></p> <p><b>Description</b> Axle Rod</p> <p>L=755 d=Ø19/19 Ax=130/130</p>		81432306038 81432306039	
			1- 7736 Page 93

	ŞEM NO.	REF. NO.	Type / Model
 <p><b>9437</b></p> <p><b>Description</b> Axle Rod ( V )</p> <p>L=414 d=Ø23/23 Ax=130/130</p>		81432206247 81432206341 81432206342	
			1- 9578 Page 93

<b>Type / Model</b>	<b>REF. NO.</b>	<b>SEM NO.</b>	
	81432206037	10161	
		<b>Description</b>	
		Axle Rod	
1- 7335 Page 87			
<b>Type / Model</b>	<b>REF. NO.</b>	<b>SEM NO.</b>	
	81432206319 81432206325	10162	
		<b>Description</b>	
		Axle Rod	
1- 9595 Page 85			L=661 d=Ø/19/19 Ax=130/130
<b>Type / Model</b>	<b>REF. NO.</b>	<b>SEM NO.</b>	
	81432206187	10163	
		<b>Description</b>	
		Axle Rod	
1- 7335 Page 87 2- 7597 Page 91			L=633 d=Ø/19 Ax=130
<b>Type / Model</b>	<b>REF. NO.</b>	<b>SEM NO.</b>	
	81432206251 81432206254 81432206256 81432206248	10164	
		<b>Description</b>	
		Axle Rod	
1- 9083 Page 87			L=470 d=Ø/19/19 Ax=130/130
<b>Type / Model</b>	<b>REF. NO.</b>	<b>SEM NO.</b>	
F 2000 SERIES	81432206196 81432206232 81432206233	10456	
		<b>Description</b>	
		Axle Rod	
1- 7919 Page 88			L=596 d=Ø19/19 Ax=130/130
<b>Type / Model</b>	<b>REF. NO.</b>	<b>SEM NO.</b>	
	81432206115 81432206117 81432206116 81432206118	12914	
		<b>Description</b>	
		Axle Rod	
1- 7595 Page 85			L=620 d=Ø17/17 Ax=115/115











SEM NO.	REF. NO.	Type / Model
12917	81432206265	
 <p><b>Description</b> Axle Rod</p>		
<p>L=694 d=Ø19/19 Ax=130/130</p>		
1- 7736 Page 93		

SEM NO.	REF. NO.	Type / Model
12921	81432206213	
 <p><b>Description</b> Axle Rod</p>		
<p>L=660 d=Ø15/15 Ax=100/115</p>		
1- 7610 Page 353 2- 8527 Page 85		

SEM NO.	REF. NO.	Type / Model
12939	81432206145 81432206208 81432206160 81432206209 81432206162	
 <p><b>Description</b> Axle Rod</p>		
<p>L=531 d=Ø19/19 Ax=130/130</p>		
1- 8216 Page 88		

SEM NO.	REF. NO.	Type / Model
12941	82432206008 82432209008	
 <p><b>Description</b> Axle Rod</p>		
<p>L=585 d=Ø21/21 Ax=130/130</p>		
1- 8616 Page 90		

<p><b>Type / Model</b></p> <p>1- 7682 Page 90 2- 7850 Page 88</p>	<p><b>REF. NO.</b></p> <p>81432706087 81432706088 81432706094 81432706095</p> <p><b>SEM NO.</b></p> <p><b>8184</b></p> <p><b>Description</b></p> <p>Axle Rod ( V )</p>	 <p>L=627 Ax=152/130/130 d=Ø25/25/25</p>
<p><b>Type / Model</b></p> <p>1- 7827 Page 94 2- 7959 Page 88</p>	<p><b>REF. NO.</b></p> <p>81432706096 81432706114 81432206221 81432706121</p> <p><b>SEM NO.</b></p> <p><b>8185 (10155)</b></p> <p><b>Description</b></p> <p>Axle Rod ( V )</p>	 <p>L=627 Ax=130/130 d=Ø23/23</p>
<p><b>Type / Model</b></p> <p>1- 7827 Page 94 2- 7850 Page 88</p>	<p><b>REF. NO.</b></p> <p>81432706117 81432706152</p> <p><b>SEM NO.</b></p> <p><b>8187</b></p> <p><b>Description</b></p> <p>Axle Rod ( V )</p>	 <p>L=627 Ax=130/130 d=Ø25/25</p>
<p><b>Type / Model</b></p> <p>TRW PIPE Ø58</p> <p>1- 7827 Page 94 2- 7852 Page 94</p>	<p><b>REF. NO.</b></p> <p>81432706078 81432706057 81432706055 81432706054 81432706034 81432706030 81432706074 81432709078</p> <p>81432709076 81432706076</p> <p><b>SEM NO.</b></p> <p><b>8303</b></p> <p><b>Description</b></p> <p>Axle Rod ( V )</p>	 <p>L=621 Ax=152/152 d=23/23</p>
<p><b>Type / Model</b></p> <p>F 2000 F90</p> <p>1- 7827 Page 94 2- 7879 Page 90</p>	<p><b>REF. NO.</b></p> <p>81432706056 81432706067 81432706075 81432709056 81432706081</p> <p><b>SEM NO.</b></p> <p><b>8957</b></p> <p><b>Description</b></p> <p>V-Torque Rod</p>	 <p>L=627 d=Ø23/23 Ax=152/152</p>
<p><b>Type / Model</b></p> <p>LEMFORDER PIPE Ø50</p> <p>1- 7827 Page 94 2- 9045 Page 89</p>	<p><b>REF. NO.</b></p> <p>81432706078 81432706057 81432706055 81432706054 81432706034 81432706030 81432706074 8143270907</p> <p>81432709076 81432706076</p> <p><b>SEM NO.</b></p> <p><b>9311</b></p> <p><b>Description</b></p> <p>Axle Rod ( V )</p>	 <p>L=627 Ax=152/152 d=23/23</p>



L=693,5 Ax=115/115 d=Ø19/19

ŞEM NO.	REF. NO.	Type / Model
9313	81432709053 81432706053	

**Description**

Axle Rod ( V )

1- 7829 Page 93  
2- 8465 Page 87



L=627 Ax=152/130/130 d=Ø25/23/23

ŞEM NO.	REF. NO.	Type / Model
9434	81432706097 81432706113 81432706135	

**Description**

Axle Rod ( V )

1- 7627 Page 358  
2- 9613 Page 87



L=627 Ax=152/130/130 d=Ø25/25/25

ŞEM NO.	REF. NO.	Type / Model
9435	81432706116 81432706137 81432706151	LEMFORDER

**Description**

Axle Rod ( V )

1- 7682 Page 90  
2- 7850 Page 88

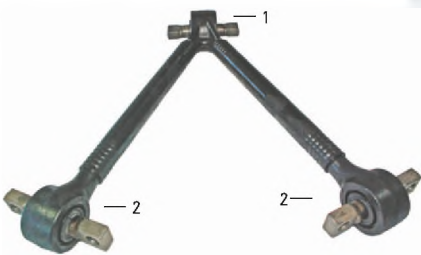

L=627 d=Ø25/23/23 Ax=152/152/152

ŞEM NO.	REF. NO.	Type / Model
10153	85432706001	

**Description**

Axle Rod ( V )

1- 7954 Page 88  
2- 8313 Page 86



L=642,7 d=Ø25/19/19 Ax=152/115/115

ŞEM NO.	REF. NO.	Type / Model
10980	81432706136 81432706140 81432706141	

**Description**

Axle Rod ( V )

1- 7627 Page 358  
2- 9077 Page 85









L=642,7 d=Ø25/19/19 Ax=152/115/115

ŞEM NO.	REF. NO.	Type / Model
10986	81432706129 81432706130 81432706131	

**Description**

Axle Rod ( V )

1- 7627 Page 358  
2- 9077 Page 85

Type / Model	REF. NO.		SEM NO.
TRW	81432706150		<b>11836</b>
<p>1- 11801 Page 90 2- 7850 Page 88</p>			
<p><b>Description</b> Axle Rod ( V )</p>  <p>L=627 d=25/25/25 Ax=152/130/130</p>			
Type / Model	REF. NO.		SEM NO.
	81432706145 82432706005 81432706146 82432706007 82432701601		<b>12943</b>
<p><b>Description</b> Axle Rod ( V )</p>  <p>L=622 d=Ø24/24 Ax=130/130</p>			
Type / Model	REF. NO.		SEM NO.
	81433156037		<b>12944</b>
<p>1- 7698 Page 89 2- 8222 Page 89</p>			
<p><b>Description</b> Axle Rod ( V )</p>  <p>L=782 d=Ø21/21 Ax=130/130</p>			

SEM NO.	REF. NO.	Type / Model
9598	81437016564	OPEN LENGTH=650
	81437016620	CLOSED LENGTH=424
<b>Description</b>	SACHS 112853	UPPER MOUNT
	81437016584	DIMENSION=20x62
	MONROE T5048	LOWER MOUNT
		DIMENSION=30x62
Shock Absorber		

SEM NO.	REF. NO.	Type / Model
9599	81437016597	MONROET1073
	81437016598	MONROET5080
<b>Description</b>	81437016600	MONROET1093
	81437016612	UPPER MOUNT
	81437016632	DIMENSION=M14x80
	81437016633	LOWER MOUNT
	SACHS112859	DIMENSION=M16x78
Shock Absorber		

SEM NO.	REF. NO.	Type / Model
9608	81437016442	81437016490
	81437016644	81437016595
<b>Description</b>	81437016444	SACHS112869
	81437016695	SACHS112323
	81437016456	MONROET1028
	81437016699	UPPER MOUNT
	81437016457	DIMENSION=M14x78
	81437016491	LOWER MOUNT
Shock Absorber		

SEM NO.	REF. NO.	Type / Model
9609	81417226009	81417226033
	81417226038	SACHS112211
<b>Description</b>	81417226012	SACHS112855
	81417226042	SACHS112884
	81417226014	MONROECB0106
	81417226050	UPPER MOUNT
	81417226016	DIMENSION=14x45
	81417226037	LOWER MOUNT
Shock Absorber		





SEM NO.	REF. NO.	Type / Model
9611	81437016793	81437016793
	SACHS125148	MONROET1189
<b>Description</b>	SACHS125963	UPPER MOUNT
		DIMENSION=M14x80
		LOWER MOUNT
		DIMENSION=M16x50
Shock Absorber		

SEM NO.	REF. NO.	Type / Model
10228	81437016905	81437016905
	MONROET5263	SACHS131696
<b>Description</b>		UPPER MOUNT
		DIMENSION=20x62
		LOWER MOUNT
		DIMENSION=30x62
Shock Absorber		

Type / Model	REF. NO.	SEM NO.	
OPEN LENGTH=299	81417226015	<b>10232</b>	
CLOSED LENGTH=249	81417226013		
UPPER MOUNT	81417226017		
DIMENSION=14x40	81417226045		
LOWER MOUNT	81417226010		
DIMENSION=14x40	SACHS112212 SACHS112856 MONROECB0105		
		<b>Description</b>	Shock Absorber
Type / Model	REF. NO.	SEM NO.	
OPEN LENGTH=517	83437016393	<b>11444</b>	
CLOSED LENGTH=317			
UPPER MOUNT			
DIMENSION=M16x92			
LOWER MOUNT			
DIMENSION=M16x92			
		<b>Description</b>	Shock Absorber
Type / Model	REF. NO.	SEM NO.	
OPEN LENGTH=689	81437016573	<b>11445</b>	
CLOSED LENGTH=398	81437016450		
UPPER MOUNT	81437016388		
DIMENSION=M16x85	81437016578		
LOWER MOUNT	SACHS106885		
DIMENSION=M16x85			
		<b>Description</b>	Shock Absorber
Type / Model	REF. NO.	SEM NO.	
OPEN LENGTH=672	81437016902	<b>11450</b>	
CLOSED LENGTH=407	81437016964		
UPPER MOUNT	SACHS131750		
DIMENSION=M14x80	SACHS280930		
LOWER MOUNT	MONROET1266		
DIMENSION=24x55			
		<b>Description</b>	Shock Absorber
Type / Model	REF. NO.	SEM NO.	
OPEN LENGTH=246	81437016304	<b>11476</b>	
CLOSED LENGTH=179	83437016007		
UPPER MOUNT			
DIMENSION=12x32			
LOWER MOUNT			
DIMENSION=12x32			
		<b>Description</b>	Shock Absorber
Type / Model	REF. NO.	SEM NO.	
OPEN LENGTH=231	81437016143	<b>11486</b>	
CLOSED LENGTH=166	81437016375		
UPPER MOUNT	SACHS101751		
DIMENSION=M10x58			
LOWER MOUNT			
DIMENSION=12x32			
		<b>Description</b>	Shock Absorber

	<b>SEM NO.</b>	<b>REF. NO.</b>	<b>Type / Model</b>
	11495	81437016878 SACHS131339	OPEN LENGTH=443 CLOSED LENGTH=273 UPPER MOUNT DIMENSION=M14x75 LOWER MOUNT DIMENSION=M14x75
	<b>Description</b>		
	Shock Absorber		
	<b>SEM NO.</b>	<b>REF. NO.</b>	<b>Type / Model</b>
	11496	81437016672 81437016830 81437016689 81437016892 81437016706 81437016924 81437016714 81437016787	81437016730 81437016768 SACHS131273 SACHS112913 MONROEB1278
	<b>Description</b>		OPEN LENGTH=488 CLOSED LENGTH=309 UPPER MOUNT DIMENSION=M14x75 LOWER MOUNT DIMENSION=M14x75
	Shock Absorber		
	<b>SEM NO.</b>	<b>REF. NO.</b>	<b>Type / Model</b>
	11510	81437016794 81437016888 SACHS131256 SACHS125857	OPEN LENGTH=678 CLOSED LENGTH=415 UPPER MOUNT DIMENSION=M14x64 LOWER MOUNT DIMENSION=16x50
	<b>Description</b>		
	Shock Absorber		
	<b>SEM NO.</b>	<b>REF. NO.</b>	<b>Type / Model</b>
	11511	81437016253 81437016932 81437016338 81437016452 81437016782 81437016820 MONROET1117	SACHS124610 SACHS131945 SACHS106469
	<b>Description</b>		OPEN LENGTH=659 CLOSED LENGTH=404 UPPER MOUNT DIMENSION=12x80 LOWER MOUNT DIMENSION=14x45
	Shock Absorber		
	<b>SEM NO.</b>	<b>REF. NO.</b>	<b>Type / Model</b>
	11512	81437016784 81437016798 81437016931 SACHS125443 MONROET1186 MONROET1187	OPEN LENGTH=592 CLOSED LENGTH=377 UPPER MOUNT DIMENSION=14x45 LOWER MOUNT DIMENSION=14x45
	<b>Description</b>		
	Shock Absorber		
	<b>SEM NO.</b>	<b>REF. NO.</b>	<b>Type / Model</b>
	11517	83437016003	OPEN LENGTH=716 CLOSED LENGTH=432 UPPER MOUNT DIMENSION=16x50 LOWER MOUNT DIMENSION=16x50
	<b>Description</b>		
	Shock Absorber		



Type / Model	REF. NO.	SEM NO.	
OPEN LENGTH=697 CLOSED LENGTH=434 UPPER MOUNT DIMENSION=16x50 LOWER MOUNT DIMENSION=16x50	80437016005 81437016681	<b>11524</b>	
			<b>Description</b> Shock Absorber
Type / Model	REF. NO.	SEM NO.	
OPEN LENGTH=504 CLOSED LENGTH=310 UPPER MOUNT DIMENSION=M16 LOWER MOUNT DIMENSION=M16	81437016090 83437016004	<b>11525</b>	
			<b>Description</b> Shock Absorber
Type / Model	REF. NO.	SEM NO.	
19.190	81437060008	<b>7434</b>	
			<b>Description</b> Rubber Buffer
			D=Ø42.5 d=Ø24 h=36
Type / Model	REF. NO.	SEM NO.	
26.230		<b>7541</b>	
			<b>Description</b> Rubber Buffer
			D=Ø43 d=Ø22 h=25



	<b>SEM NO.</b>	<b>REF. NO.</b>	<b>Technical Specification</b>	
	<b>72.1885.R1</b>	81436010104 81436010123 81436010109 81436010125 81436010111 81436010140 81436010150	CONTITECH 1885N1 FIRESTONE 1R2A445-280 FIRESTONE W010950429 PHOENIX 1F20B	Total Weight 1,6 kg
	<b>Description</b>			
	Roll			
	<b>SEM NO.</b>	<b>REF. NO.</b>	<b>Technical Specification</b>	
	<b>72.1888.R</b>	81436010163	CONTITECH 1888 N	Total Weight 1,8 kg
	<b>Description</b>			
	Roll			
	<b>SEM NO.</b>	<b>REF. NO.</b>	<b>Technical Specification</b>	
	<b>72.4705.S01</b>	81436010155	CONTITECH 4705 N1 P01 GART NO. 302.0.521 GART REF. C302/B	Total Weight 5,5 kg
	<b>Description</b>			
	Service Assembly			
	<b>SEM NO.</b>	<b>REF. NO.</b>	<b>Technical Specification</b>	
	<b>72.4882.C05</b>	81436006036 81436006056	CONTITECH 4882 N P05 PHOENIX 1 DF 16 2 FIRESTONE 1T17TWR 8 GART REF. C289/M FIRESTONE W01 M58 9880 CF GOMMA REF. 1TS260 28 CF GOMMA NO. 206788 GART NO. 206788 VIBRACOUSTIC V1DF16 2	Total Weight 7,9 kg
	<b>Description</b>			
	Metal Piston			
	<b>SEM NO.</b>	<b>REF. NO.</b>	<b>Technical Specification</b>	
	<b>72.4882.S02</b>	81436010151 81436010176	CONTITECH 4882 N1 P01 PHOENIX 1 DF 16-2 NP GART REF. C289/M GOODYEAR 1R10-702 GY SPRINGRIDE D10U01 GART NO. 289.0.512 VIBRACOUSTIC V1DF16-2 NP	Total Weight 4,3 kg
	<b>Description</b>			
	Service Assembly			
	<b>SEM NO.</b>	<b>REF. NO.</b>	<b>Technical Specification</b>	
	<b>72.4883.C05</b>	81436006037	CONTITECH 4883 N1 P06 GOODYEAR 1R11-884	Total Weight 10,5 kg
	<b>Description</b>			
	Metal Piston			





Technical Specification	REF. NO.		ŞEM NO.		
Total Weight 5 kg	81436010153	CONTITECH 4883 N1 P01 GOODYEAR 1R11-804 GY SPRINGRIDE D11U47 GART NO. 304.0.513 GART REF. C304/M3 VIBRACOUSTIC V1DF19C-1	<b>72.4883.S02</b>	<b>Description</b> Service Assembly	
Total Weight 10,5 kg	81436006035 81436006055	CONTITECH 4884 N1 P06 PHOENIX 1 DF 19 B 1 VIBRACOUSTIC V1DF19B 1 FIRESTONE 1T17JR 7.2 FIRESTONE W01 M58 9879 CF GOMMA REF. 1TS290 28 CF GOMMA NO. 206787 GART NO. 304.1.510 GART REF. C304/M4 GOODYEAR 1R11 861	<b>72.4884.C06</b>	<b>Description</b> Metal Piston	
Total Weight 1,4 kg	81436010017	CONTITECH 644 N PHOENIX 1 E 21 Taurus BL121 VIBRACOUSTIC V1E21 FIRESTONE 1R1A390 295 FIRESTONE W01 095 0118 GOODYEAR 8017 GY SPRINGRIDE D11S01 CF GOMMA REF. 1S285 24	<b>72.644.R</b>	<b>Description</b> Roll	
Total Weight 1,8 kg	90831120144	CONTITECH 661 N PHOENIX 1 E 25 VIBRACOUSTIC V1E25( 2) FIRESTONE 1R1C390 310 FIRESTONE W01 095 0021 GOODYEAR 8018 Büssing 831 120 144 CF GOMMA REF. 1S310 28 CF GOMMA NO. 91016 GART NO. 297.0.390 GART REF. D297	<b>72.661.R</b>	<b>Description</b> Roll	
Total Weight 2,4 kg	81436010018 81436010051	GOODYEAR 9007 GY SPRINGRIDE D13S01 CF GOMMA REF. 1SC360-30 CF GOMMA NO. 92594 DUNLOP UK PNP302730101 Floor 848 SMB / VDL Bus 0 578 361 Kögel / Wackenhut	<b>72.662.R</b>	<b>Description</b> Roll	
Total Weight 2 kg	81436010096 81436010127 81436010098 81436010139 81436010101	CONTITECH 706 N GOODYEAR 9067 GY SPRINGRIDE D12S16	<b>72.706.R</b>	<b>Description</b> Roll	

	<b>SEM NO.</b>	<b>REF. NO.</b>	<b>Technical Specification</b>
	72.715.R	81436010059 81436010083 81436010060 81436010090	81436010078 81436010117 81436010081 CONTITECH 715 N
	<b>Description</b>	81436010061 81436010113	PHOENIX 1 F 25 VIBRACOUSTIC V1F25
	Roll	81436010075 81436010115	FIRESTONE 1R1C335 310 FIRESTONE W01 095 0087 GOODYEAR 8015
			Total Weight 2 kg
	<b>SEM NO.</b>	<b>REF. NO.</b>	<b>Technical Specification</b>
	72.716.R	81436010039 81436010040	CONTITECH 716 N PHOENIX 1 F 26 B 1
	<b>Description</b>		VIBRACOUSTIC V1F26B 1
	Roll		FIRESTONE 1R2A450 305 CF GOMMA NO. 92548 FIRESTONE W01 095 0145 GOODYEAR 9073 GY SPRINGRIDE D12S19 CF GOMMA REF. 1SC300 34
			Total Weight 2,2 kg
	<b>SEM NO.</b>	<b>REF. NO.</b>	<b>Technical Specification</b>
	72.720.R	81436010033 81436010036 81436010037	CONTITECH 720 N PHOENIX 1 F 21 VIBRACOUSTIC V1F21
	<b>Description</b>		FIRESTONE 1R2A460 295
	Roll		DUNLOP UK PNP301000100 FIRESTONE W01 095 0195 GOODYEAR 9008 GY SPRINGRIDE D12S04 CF GOMMA REF. 1SC290 30 CF GOMMA NO. 88802
			Total Weight 1,2 kg
	<b>SEM NO.</b>	<b>REF. NO.</b>	<b>Technical Specification</b>
	72.727.R	81436010056 81436010058 81436010057 81436010076	81436010114 81436010116 CONTITECH 727 N PHOENIX 1 F 32 A
	<b>Description</b>	81436010079	VIBRACOUSTIC V1F32A
	Roll	81436010084 81436010082 81436010091	FIRESTONE 1R2D460 360 FIRESTONE W01 095 0191 Floor 862 GOODYEAR 8117
			Total Weight 2,5 kg
	<b>SEM NO.</b>	<b>REF. NO.</b>	<b>Technical Specification</b>
	72.762.R	81436010049 81436010052	GOODYEAR 9010 GY SPRINGRIDE D13S02
	<b>Description</b>	CONTITECH 762 N	CF GOMMA REF. 1SC360-30
	Roll	PHOENIX 1 F 32 VIBRACOUSTIC V1F32 FIRESTONE 1R2D390-360 FIRESTONE W01-095-0190 Gigant 196035	CF GOMMA NO. 92594 DUNLOP UK PNP307800100 VDL Bus 0 644 425
			Total Weight 2,3 kg
	<b>SEM NO.</b>	<b>REF. NO.</b>	<b>Technical Specification</b>
	72.786.R	81436010053	CONTITECH 786 N PHOENIX 1 F 14
	<b>Description</b>		VIBRACOUSTIC V1F14
	Roll		FIRESTONE 1R1A355-245 FIRESTONE W01-095-0436
			Total Weight 1,5 kg







Technical Specification	REF. NO.		SEM NO.	
	81436010025	PHOENIX 1 E 18 E	<b>72.792.R</b>	
	81436010050	GOODYEAR 9133 GOODYEAR 9132		
			<b>Description</b>	
			Service Assembly	
Technical Specification	REF. NO.		SEM NO.	
Total Weight 3 kg	81436010025	CONTITECH 809 NT	<b>72.809.ST</b>	
	81436010050	PHOENIX 1D23B-2 CF GOMMA 1T320SP FIRESTONE 1T15L-6 FIRESTONE W01 M58 0031		
			<b>Description</b>	
			Service Assembly	
Technical Specification	REF. NO.		SEM NO.	
	81436016002	CONTITECH 809 NTB FIRESTONE 1T15L-6 FIRESTONE W01 M58 0687 GOODYEAR 1R12-709	<b>72.809.STB</b>	
			<b>Description</b>	
			Service Assembly	
Technical Specification	REF. NO.		SEM NO.	
Total Weight 3,8 kg	81436010047	CONTITECH 810 NT PHOENIX 1 DK 28 A FIRESTONE 1T19L-7 CF GOMMA REF. 1T19E-1S FIRESTONE W01-M58-0491 GOODYEAR 1R14-714 GY SPRINGRIDE D14U45	<b>72.810.ST</b>	
			<b>Description</b>	
			Service Assembly	
Technical Specification	REF. NO.		SEM NO.	
Total Weight 4,3 kg	81436016019	CONTITECH 810 NTB PHOENIX 1 DK 28 A 4 FIRESTONE 1T19L 7 FIRESTONE W01 M58 0749 Pegaso 174933 GOODYEAR 1R14 713 CF GOMMA REF. 1T19E 1 CF GOMMA NO. 93702 DUNLOP UK PNP311380000	<b>72.810.STB</b>	
			<b>Description</b>	
			Service Assembly	
Technical Specification	REF. NO.		SEM NO.	
Total Weight 4,2 kg	81436010035	CONTITECH 811 NT	<b>72.811.ST</b>	
	81436010048	FIRESTONE 1T19L-10 FIRESTONE W01 M58 0028 GOODYEAR 1R14-715 PHOENIX 1 DK 28 Taurus UR 622-03		
			<b>Description</b>	
			Service Assembly	

	<b>ŞEM NO.</b>	<b>REF. NO.</b>	<b>Technical Specification</b>	
	<b>72.811.STB</b>	81436010035 81436010048	CONTITECH 811 NTB FIRESTONE 1T19L-10 FIRESTONE W01 M58 0747 GOODYEAR 1R14-739 PHOENIX 1 DK 28 B-4	Total Weight 4,8 kg
	<b>Description</b>			
	Service Assembly			
	<b>ŞEM NO.</b>	<b>REF. NO.</b>	<b>Technical Specification</b>	
	<b>72.882.R1</b>	81436010065 81436010099 81436010067 81436010103 81436010070 81436010121 81436010092 81436010132	CONTITECH 882 N1 PHOENIX 1 F 16 VIBRACOUSTIC V1F16 FIRESTONE 1R4R465-260 FIRESTONE W01-095-0435 GOODYEAR 9048 GY SPRINGRIDE D12S12 CF GOMMA REF. 1SC250-28 CF GOMMA NO. 97042 GART NO. 289.0.400 GART REF. C289/D BredaMenarini D031115	Total Weight 1,8 kg
	<b>Description</b>			
	Roll			
	<b>ŞEM NO.</b>	<b>REF. NO.</b>	<b>Technical Specification</b>	
	<b>72.883.R1</b>	81436010071 81436010128 81436010072 81436010137 81436010110	CONTITECH 883 N1 PHOENIX 1 F 21 C-2 VIBRACOUSTIC V1F21C-2 GOODYEAR 9012 GY SPRINGRIDE D13S03 CF GOMMA REF. 1SC250-29 CF GOMMA NO. 204250 Pegaso	
	<b>Description</b>			
	Roll			
	<b>ŞEM NO.</b>	<b>REF. NO.</b>	<b>Technical Specification</b>	
	<b>72.884.R1</b>	81436010066 81436010108 81436010068 81436010106 81436010069	CONTITECH 884 N PHOENIX 1 F 20 A VIBRACOUSTIC V1F20A GOODYEAR 9002 GY SPRINGRIDE D12S06	Total Weight 2 kg
	<b>Description</b>			
	Roll			
	<b>ŞEM NO.</b>	<b>REF. NO.</b>	<b>Technical Specification</b>	
	<b>72.909.ST</b>	81436010050 81436010073 81436010054 81436016029	CONTITECH 909 NT	Total Weight 2,4 kg
	<b>Description</b>			
	Service Assembly			
	<b>ŞEM NO.</b>	<b>REF. NO.</b>	<b>Technical Specification</b>	
	<b>72.916.R1</b>	81436010095 81436010105 81436010097 81436010126 81436010100 81436010138 81436010102	CONTITECH 916 N1 PHOENIX 1 F 21 C-5 PHOENIX 1 F 21 C-6 Optare L5820005 / Taurus B154 Temsa TE771107Y ZF Sachs 00 17 70 000 160 ZF Sachs 00 17 48 000 160 VIBRACOUSTIC V1F21C-5 FIRESTONE 2R2A460-295 FIRESTONE W01-095-0555 GOODYEAR 9015 GY SPRINGRIDE D12S05	Total Weight 2 kg
	<b>Description</b>			
	Roll			

Technical Specification	REF. NO.		SEM NO.	
Total Weight 1,1 kg	88964200217	CONTITECH 608 N PHOENIX 2 B 20 R VIBRACOUSTIC V2B20R FIRESTONE 20 FIRESTONE W01-R58-4088 GOODYEAR 2B12-425/300	<b>72.2285.M01</b>	
			<b>Description</b> Convulated Air Spring	

	<p><b>ŞEM NO.</b> 8197</p>	<p><b>REF. NO.</b> 83417236002</p>	<p><b>Type / Model</b></p>
<p><b>Description</b> Hand Pump</p>			
	<p><b>ŞEM NO.</b> 8451</p>	<p><b>REF. NO.</b> 85417236020 85417236044 85417236011</p>	<p><b>Type / Model</b></p>
<p><b>Description</b> Hand Pump</p>			
	<p><b>ŞEM NO.</b> 8519</p>	<p><b>REF. NO.</b> 81417236026 81417236059 81417236114 81417236103</p>	<p><b>Type / Model</b></p>
<p><b>Description</b> Hand Pump</p>			
	<p><b>ŞEM NO.</b> 11650</p>	<p><b>REF. NO.</b> 85417236043</p>	<p><b>Type / Model</b></p>
<p><b>Description</b> Cabin Pump</p>			
	<p><b>ŞEM NO.</b> 9638</p>	<p><b>REF. NO.</b></p>	<p><b>Type / Model</b></p>
<p><b>Description</b> Repair Kit Oil</p>			



Type / Model	REF. NO.	SEM NO.
	83417236099 81417236099	8200
		
		<b>Description</b> Cylinder D=Ø50 Ax=470
Type / Model	REF. NO.	SEM NO.
TGA410-430	83417236123 81417236123 85417236009	8201
		
		<b>Description</b> Cylinder D=Ø50 Ax=900
Type / Model	REF. NO.	SEM NO.
TGA460-480	83417236124 85417236030 81417236124	8202
		
		<b>Description</b> Cylinder D=Ø50 Ax=940
Type / Model	REF. NO.	SEM NO.
	81417236076 81417239076	8316
		
		<b>Description</b> Cylinder D=Ø50 Ax=560
Type / Model	REF. NO.	SEM NO.
	81417236500	8517
		
		<b>Description</b> Cylinder D=Ø50 Ax=600
Type / Model	REF. NO.	SEM NO.
	81417236029	8518
		
		<b>Description</b> Cylinder D=Ø50 Ax=889



	SEM NO.	REF. NO.	Type / Model
	7236	81962100001	520
		81962100002	19.190 20.190 22.190 S2000
<b>Description</b> Cabin Mounting			
D=Ø100 h=56 M16x1,5			







	SEM NO.	REF. NO.	Type / Model
	7351	81962100339	26.281
		83962100500	
<b>Description</b> Cabin Mounting			
D=Ø130 h=92 M16x1.5			







	SEM NO.	REF. NO.	Type / Model
	7405	81962105011	26.210
<b>Description</b> Cabin Mounting			
Ax=135 d=20 h=82			





	SEM NO.	REF. NO.	Type / Model
	7522		26.230 26.270 26.321 33.372
<b>Description</b> Rubber Buffer			

	SEM NO.	REF. NO.	Type / Model
	7524	81962100362	19.372
		81962100407	19.422
<b>Description</b> Cabin Mounting			
D=Ø60 d=Ø15 h=18			

	SEM NO.	REF. NO.	Type / Model
	7490	81962100393	26.230
		83962100512	26.270 26.321
<b>Description</b> Cabin Mounting			

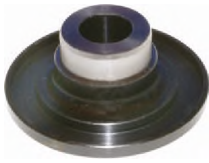
Type / Model	REF. NO.	SEM NO.	
26.230 26.270 26.321	81962100392 83962100515	7616	 <p><b>Description</b> Cabin Mounting</p>
Type / Model	REF. NO.	SEM NO.	
	85962100012 85962100007	7659	 <p><b>Description</b> Cabin Mounting</p>
Type / Model	REF. NO.	SEM NO.	
19.372 19.422	81962100400 81962100040	7523	 <p><b>Description</b> Cabin Mounting</p> <p>D=Ø50 d=Ø16 h=29</p>
Type / Model	REF. NO.	SEM NO.	
19.422 19.293 19.403 26.293 41.372 48.372	81962100437 81962100424	7570	 <p><b>Description</b> Cabin Mounting</p> <p>D=70 d=16 h=68</p>
Type / Model	REF. NO.	SEM NO.	
19.372 19.422 26.230 26.270 26.321 33.372	81962100462 81962100369	7590	 <p><b>Description</b> Cabin Bushing</p> <p>D=Ø30 d=Ø14 h=48</p>
Type / Model	REF. NO.	SEM NO.	
	85962100019	7737	 <p><b>Description</b> Cabin Bushing</p> <p>Ø60 Ø16 h=80</p>

 Ø53 Ø16 h=58	<b>SEM NO.</b> <b>7738</b>  <b>Description</b> Cabin Bushing	<b>REF. NO.</b> 85962100021	<b>Type / Model</b>
 D=Ø43 d=Ø16.5 h=58	<b>SEM NO.</b> <b>8136</b>  <b>Description</b> Bush	<b>REF. NO.</b> 81962100603	<b>Type / Model</b>
 D=Ø34 d=Ø16 h=30	<b>SEM NO.</b> <b>8148</b>  <b>Description</b> Cabin Mounting	<b>REF. NO.</b> 81618516023	<b>Type / Model</b>
	<b>SEM NO.</b> <b>7631</b>  <b>Description</b> Cabin Monting	<b>REF. NO.</b> 81962100348 81962100340 81962100349	<b>Type / Model</b> 12.152 12.192 12.222 12.232 12.262 12.272 14.152 14.162 19.422 33.372 M 2000 S 2000
 D=Ø79	<b>SEM NO.</b> <b>7859</b>  <b>Description</b> Ring	<b>REF. NO.</b> 85907100014	<b>Type / Model</b>
 D=Ø65 d=Ø49 h=11	<b>SEM NO.</b> <b>7948</b>  <b>Description</b> Spacer Ring	<b>REF. NO.</b> 85965010002	<b>Type / Model</b>
 D=Ø47 d=Ø37 h=5	<b>SEM NO.</b> <b>8296</b>  <b>Description</b> Sealing (Pur)	<b>REF. NO.</b> 81965030129	<b>Type / Model</b>

<b>Type / Model</b>	<b>REF. NO.</b>	<b>SEM NO.</b>	
	81417230067	8525	
		<b>Description</b>	
		Bush	
			D=Ø43 d=Ø25 h=24
<b>Type / Model</b>	<b>REF. NO.</b>	<b>SEM NO.</b>	
	85417150006	8142	
		<b>Description</b>	
		Cabin Mounting	
			D=Ø75 d=Ø17 h=22
<b>Type / Model</b>	<b>REF. NO.</b>	<b>SEM NO.</b>	
	06028135024 06028159027	8143	
		<b>Description</b>	
		Screw for Cabin Bushing	
			10.9 h=100 M16x1.5
<b>Type / Model</b>	<b>REF. NO.</b>	<b>SEM NO.</b>	
	06028135027 06028159024	8144	
		<b>Description</b>	
		Screw for Cabin Bushing	
			10.9 h=110 M16x1.5
<b>Type / Model</b>	<b>REF. NO.</b>	<b>SEM NO.</b>	
	06112512108 06112512008 06112518108	8145	
		<b>Description</b>	
		Nut for Cabin Bushing	
			M16x1.5
<b>Type / Model</b>	<b>REF. NO.</b>	<b>SEM NO.</b>	
	06290200131 87290483100 90750252194	10252	
		<b>Description</b>	
		Ring	

	SEM NO.	REF. NO.	Type / Model
 D=Ø47 d=Ø30 h=22	<b>8297</b>	06369500510 81934300009 81934300008 81934300010	orj. Elges germany GE-30 UK 2RS
	<b>Description</b>		
			Bearing



	SEM NO.	REF. NO.	Type / Model
 D=Ø47 d=Ø30 h=22	<b>8298</b>	06369500510S 81934300009S 81934300008S 81934300010S	Alternatively GE-30 UK 2RS
	<b>Description</b>		
			Bearing

	SEM NO.	REF. NO.	Type / Model
	<b>8811</b>	06369500210	
	<b>Description</b>		
			Bearing Original

	SEM NO.	REF. NO.	Type / Model
	<b>8811-1</b>	06369500210	
	<b>Description</b>		
			Bearing alternative

	SEM NO.	REF. NO.	Type / Model
 M 10	<b>7647</b>	81962100430	
	<b>Description</b>		
			Cabin Monting

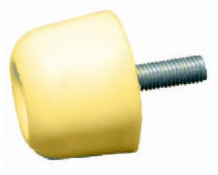
	SEM NO.	REF. NO.	Type / Model
 D=Ø50 h=37	<b>8244</b>	81962100515 81962100482	
	<b>Description</b>		
			Pur Bush

Type / Model	REF. NO.	SEM NO.	
	81962100536	8786	 <p><b>Description</b> Pur Mounting</p> <p>D=Ø50 h=36 M10x30</p>
Type / Model	REF. NO.	SEM NO.	
	85960200004	9248	 <p><b>Description</b> Pur Mounting</p> <p>D=Ø53 d=Ø22 h=42</p>



Description / Repair Kit for Cabin (Original Bearing)	SEM NO.	Model:													
	<b>7777</b>														
	<b>REF. NO:</b> 81962100407S 81962100362S 81962100424S 81962100437S 81961010638S 81971120844S 81907130909S 81907120844S	<table border="1"> <thead> <tr> <th>Item No</th> <th>Ref. No</th> </tr> </thead> <tbody> <tr> <td>1</td> <td>81962100407 - 81962100362</td> </tr> <tr> <td>2</td> <td>81962100437 - 81962100424</td> </tr> <tr> <td>3</td> <td>81961010638</td> </tr> <tr> <td>4</td> <td>81971120844 - 81907130909</td> </tr> <tr> <td>5</td> <td>06369500510-81934300008 81934300009-81934300010</td> </tr> <tr> <td>6</td> <td>81965030129</td> </tr> </tbody> </table>	Item No	Ref. No	1	81962100407 - 81962100362	2	81962100437 - 81962100424	3	81961010638	4	81971120844 - 81907130909	5	06369500510-81934300008 81934300009-81934300010	6
Item No	Ref. No														
1	81962100407 - 81962100362														
2	81962100437 - 81962100424														
3	81961010638														
4	81971120844 - 81907130909														
5	06369500510-81934300008 81934300009-81934300010														
6	81965030129														

Description / Repair Kit for Cabin (Alternatively Bearing)	SEM NO.	Model:													
	<b>7777-1</b>														
	<b>REF. NO:</b> 81962100407S 81962100362S 81962100424S 81962100437S 81961010638S 81971120844S 81907130909S 81907120844S	<table border="1"> <thead> <tr> <th>Item No</th> <th>Ref. No</th> </tr> </thead> <tbody> <tr> <td>1</td> <td>81962100407 - 81962100362</td> </tr> <tr> <td>2</td> <td>81962100437 - 81962100424</td> </tr> <tr> <td>3</td> <td>81961010638</td> </tr> <tr> <td>4</td> <td>81971120844 - 81907130909</td> </tr> <tr> <td>5</td> <td>06369500510-81934300008 81934300009-81934300010</td> </tr> <tr> <td>6</td> <td>81965030129</td> </tr> </tbody> </table>	Item No	Ref. No	1	81962100407 - 81962100362	2	81962100437 - 81962100424	3	81961010638	4	81971120844 - 81907130909	5	06369500510-81934300008 81934300009-81934300010	6
Item No	Ref. No														
1	81962100407 - 81962100362														
2	81962100437 - 81962100424														
3	81961010638														
4	81971120844 - 81907130909														
5	06369500510-81934300008 81934300009-81934300010														
6	81965030129														

Description / Repair Kit for Cabin (Original Bearing)	SEM NO.	Model:													
	<b>7778</b>														
	<b>REF. NO:</b> 81962100400S 81962100040S 81962100407S1 81962100362S1 81961010638S1 81971120844S1 81907130909S1	<table border="1"> <thead> <tr> <th>Item No</th> <th>Ref. No</th> </tr> </thead> <tbody> <tr> <td>1</td> <td>81962100407 - 81962100362</td> </tr> <tr> <td>2</td> <td>81962100400 - 81962100040</td> </tr> <tr> <td>3</td> <td>81961010638</td> </tr> <tr> <td>4</td> <td>81971120844 - 81907130909</td> </tr> <tr> <td>5</td> <td>06369500510-81934300008 81934300009-81934300010</td> </tr> <tr> <td>6</td> <td>81965030129</td> </tr> </tbody> </table>	Item No	Ref. No	1	81962100407 - 81962100362	2	81962100400 - 81962100040	3	81961010638	4	81971120844 - 81907130909	5	06369500510-81934300008 81934300009-81934300010	6
Item No	Ref. No														
1	81962100407 - 81962100362														
2	81962100400 - 81962100040														
3	81961010638														
4	81971120844 - 81907130909														
5	06369500510-81934300008 81934300009-81934300010														
6	81965030129														

Description / Repair Kit for Cabin (Alternatively Bearing)	SEM NO.	Model:													
	<b>7778-1</b>														
	<b>REF. NO:</b> 81962100400S 81962100040S 81962100407S1 81962100362S1 81961010638S1 81971120844S1 81907130909S1	<table border="1"> <thead> <tr> <th>Item No</th> <th>Ref. No</th> </tr> </thead> <tbody> <tr> <td>1</td> <td>81962100407 - 81962100362</td> </tr> <tr> <td>2</td> <td>81962100400 - 81962100040</td> </tr> <tr> <td>3</td> <td>81961010638</td> </tr> <tr> <td>4</td> <td>81971120844 - 81907130909</td> </tr> <tr> <td>5</td> <td>06369500510-81934300008 81934300009-81934300010</td> </tr> <tr> <td>6</td> <td>81965030129</td> </tr> </tbody> </table>	Item No	Ref. No	1	81962100407 - 81962100362	2	81962100400 - 81962100040	3	81961010638	4	81971120844 - 81907130909	5	06369500510-81934300008 81934300009-81934300010	6
Item No	Ref. No														
1	81962100407 - 81962100362														
2	81962100400 - 81962100040														
3	81961010638														
4	81971120844 - 81907130909														
5	06369500510-81934300008 81934300009-81934300010														
6	81965030129														

Model:	ŞEM NO.	Description /Repair Kit for Cabin (Original Bearing)
	<b>7780</b>	
<b>Item No</b>	<b>Ref. No</b>	<b>REF. NO:</b>
1	81962100400-81962100040	81962100400S1
2	06369500510-81934300008	81962100040S1
	81934300009-81934300010	

Model:	ŞEM NO.	Description /Repair Kit for Cabin (Alternatively Bearing)
	<b>7780-1</b>	
<b>Item No</b>	<b>Ref. No</b>	<b>REF. NO:</b>
1	81962100400-81962100040	81962100400S1
2	06369500510-81934300008	81962100040S1
	81934300009-81934300010	

Model:	ŞEM NO.	Description /Repair Kit for Cabin
	<b>7935</b>	
		<b>REF. NO:</b>
		81417156013

Model:	ŞEM NO.	Description /Repair Kit for Cabin (Alternatively Bearing)
	<b>7935-1</b>	
		<b>REF. NO:</b>
		81417156013



<b>Description / Repair Kit for Cabin</b>	<b>SEM NO.</b>	<b>Model:</b>
---	----------------	---------------



7936

REF. NO: 81417156014

<b>Description / Repair Kit for Cabin</b>	<b>SEM NO.</b>	<b>Model:</b>
---	----------------	---------------



9046

REF. NO: 81962100407S2  
81962100362S2

Item No	Ref. No
1	81962100407-81962100362
2	81961010638
3	81971120844-81907130909
4	06369500510-81934300008 81934300009-81934300010
5	81965030129

<b>Description /Repair Kit for Cabin (Alternatively Bearing)</b>	<b>SEM NO.</b>	<b>Model:</b>
--	----------------	---------------



9046-1

REF. NO: 81962100407S2  
81962100362S2

Item No	Ref. No
1	81962100407-81962100362
2	81961010638
3	81971120844-81907130909
4	06369500510-81934300008 81934300009-81934300010
5	81965030129

<b>Description / Pur Mounting Repair Kit)</b>	<b>SEM NO.</b>	<b>Model:</b>
---	----------------	---------------



9249

REF. NO: 85962100008  
85962100009

D=Ø95 h=30 D=Ø95 h=20

**Model:** **ŞEM NO.** **Description /** Pur Mounting Repair Kit

**9250**

Item No	Ref. No
1	85960200004
2	85942990015
3	06028134824
4	06112512003

**REF. NO:**  
85960200004S









**Model:** **ŞEM NO.** **Description /** Repair Kit for Cabin

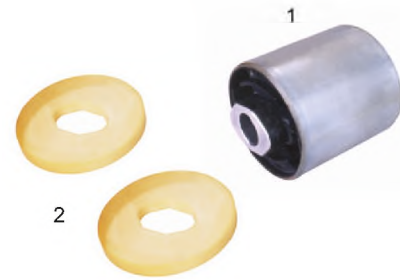



**9593**

Item No	Ref. No
1	7737
2	7859

**REF. NO:**  
85962100019S



	<b>SEM NO.</b> <b>8161</b>	<b>REF. NO.</b> 81417226048 81417226051 MONROE CB0092 SACHS105855	<b>Type / Model</b> F2000
	<b>Description</b> Cabin Suspansion Spring Wit Shock Absorber		
	<b>SEM NO.</b> <b>8162</b>	<b>REF. NO.</b> 81417226052 81417226049 MONROE CB0091 SACHS105856	<b>Type / Model</b> F2000 TGA
	<b>Description</b> Cabin Suspansion Spring Wit Shock Absorber		
	<b>SEM NO.</b> <b>8476</b>	<b>REF. NO.</b> 81417226057 81417226075 85417226006 85417226012	<b>Type / Model</b> SACHS 135198 SACHS 105378 SACHS 313183 WABCO 9640060050
	<b>Description</b> Cabin Suspansion Spring Wit Shock Absorber		
	<b>SEM NO.</b> <b>8477</b>	<b>REF. NO.</b> 85417226014 85417226022 85417226008 81417226077	<b>Type / Model</b> SACHS 135174 SACHS 135196 SACHS 313181 TGA
	<b>Description</b> Cabin Suspansion Spring Wit Shock Absorber		
	<b>SEM NO.</b> <b>8478</b>	<b>REF. NO.</b> 85417226015 85417226023 85417226009 85417226078	<b>Type / Model</b> SACHS 135195 SACHS 135197 SACHS 313182 TGA
	<b>Description</b> Cabin Suspansion Spring Wit Shock Absorber		
	<b>SEM NO.</b> <b>10812</b>	<b>REF. NO.</b> 81417226058 85417226007 85417226013	<b>Type / Model</b> SACHS 313184 SACHS 135200 SACHS 135199 TGA
	<b>Description</b> Cabin Suspansion Spring Wit Shock Absorber		

<b>Type / Model</b>	<b>REF. NO.</b>	<b>SEM NO.</b>	
	83961010022	007	
		<b>Description</b>	
		Sealing Strip	
<b>Type / Model</b>	<b>REF. NO.</b>	<b>SEM NO.</b>	
	81626510011	056	
		<b>Description</b>	
		Sealing Strip	
<b>Type / Model</b>	<b>REF. NO.</b>	<b>SEM NO.</b>	
	81626510075	057	
		<b>Description</b>	
		Sealing Strip	
<b>Type / Model</b>	<b>REF. NO.</b>	<b>SEM NO.</b>	
520	81964200142	7285	
19.190	81964200308		
20.190	81964200121		
22.190			
26.281			
		<b>Description</b>	
		Bellows	
<b>Type / Model</b>	<b>REF. NO.</b>	<b>SEM NO.</b>	
SL 200 SR 240	88964010004	7408	
		<b>Description</b>	
		Bellows	
<b>Type / Model</b>	<b>REF. NO.</b>	<b>SEM NO.</b>	
	83964200504	7719	
		<b>Description</b>	
		Bellows	

	SEM NO.	REF. NO.	Type / Model
	7394	81305110000	26.281 26.230 26.231
	<b>Description</b> Pedal Cover		

A=81 B=62 h=12

	SEM NO.	REF. NO.	Type / Model
	7461	83966010003	
	<b>Description</b> Gasket		

Ø80 Ø48 2

	SEM NO.	REF. NO.	Type / Model
	7462	83063400001	
	<b>Description</b> Rubber Packing		

110x50 2

	SEM NO.	REF. NO.	Type / Model
	7554	81907130909 81907120844	19.372 19.422
	<b>Description</b> Rubber Buffer		







D=Ø65 d=Ø33 h=6

	SEM NO.	REF. NO.	Type / Model
	7555	81961010638	19.372 19.422
	<b>Description</b> Buffer		

D=Ø70 d=Ø32 h=4

	SEM NO.	REF. NO.	Type / Model
	7579	81907130014	19.422 26.230
	<b>Description</b> Rubber Buffer		

D=Ø16 d=Ø32 h=6

Type / Model	REF. NO.	ŞEM NO.	
26.240 26.280 26.281 32.240	81971010000	7428	 <b>Description</b> Rubber Strain
Type / Model	REF. NO.	ŞEM NO.	
SL 232	81669506006 36669506002	7481	 <b>Description</b> Rubber Strech Band L=217
Type / Model	REF. NO.	ŞEM NO.	
19.422	81669506005 81669500006 81669506003 36669506001	7577	 <b>Description</b> Rubber Strech Band L=370
Type / Model	REF. NO.	ŞEM NO.	
19.422 26.230	83968026504 83968020001	7578	 <b>Description</b> Rubber Strech Band L=250
Type / Model	REF. NO.	ŞEM NO.	
	81669506009 81669506007 36669506000	7686	 <b>Description</b> Rubber Strech Bant L=303
Type / Model	REF. NO.	ŞEM NO.	
	81664100226	7918	 <b>Description</b> Rubber Buffer 22x40x145

	ŞEM NO.	REF. NO.	Type / Model
	8005	81664400192	
	<b>Description</b> Rubber Buffer		

	ŞEM NO.	REF. NO.	Type / Model
	7459	81960020075	19.372 19.422 26.230 26.270 26.321 33.372
	<b>Description</b> Rubber Stopper		

	ŞEM NO.	REF. NO.	Type / Model
	7483	83960010006	
	<b>Description</b> Rubber Plate		

A=120 B=30 h=3

	ŞEM NO.	REF. NO.	Type / Model
	7485	81961010539	
	<b>Description</b> Packing		

A=295 B=73 h=3







	ŞEM NO.	REF. NO.	Type / Model
	7494	83082400514	26.230
	<b>Description</b> Packing		

54x35 2

	ŞEM NO.	REF. NO.	Type / Model
	7608	81418200129	19.281 19.321 19.422 26.281 26.321
	<b>Description</b> Plate		

A=300 B=122



Type / Model	REF. NO.	SEM NO.	
	88960010016	7623	
			<b>Description</b> Rubber Buffer A=95 B=43 h=1.50
Type / Model	REF. NO.	SEM NO.	
	81961010280	7624	
			<b>Description</b> Rubber Sleeve 74x24x1
Type / Model	REF. NO.	SEM NO.	
19.281 19.321 19.422 26.281	81418202039	7629	
			<b>Description</b> Rubber Plate A=420 B=122
Type / Model	REF. NO.	SEM NO.	
	81961010531	7701	
			<b>Description</b> Rubber Buffer
Type / Model	REF. NO.	SEM NO.	
	36779402029	10209	
			<b>Description</b> Cover L=36 mm h=63 mm
Type / Model	REF. NO.	SEM NO.	
	81960010002	7450	
			<b>Description</b> Rubber Sleeve Ø10 Ø13.5 Ø18 11



	SEM NO.	REF. NO.	Type / Model
 Description Rubber Stopper	7451	81960020098	19.372 19.422 26.270 33.372
	Ø 37x14		







	SEM NO.	REF. NO.	Type / Model
 Description Rubber Sleeve	7452	81960010009	
	Ø13-Ø18 Ø25 7		

	SEM NO.	REF. NO.	Type / Model
 Description Rubber Sleeve	7453	81960010000	
	Ø6.8-Ø12 Ø16 8		

	SEM NO.	REF. NO.	Type / Model
 Description Rubber Sleeve	7454	81960010003	
	Ø11.5-Ø16 8		

	SEM NO.	REF. NO.	Type / Model
 Description Rubber Sleeve	7455	81960010096	
	Ø10-Ø14 Ø18 15		

	SEM NO.	REF. NO.	Type / Model
 Description Rubber Sleeve	7456	81960010039	
	Ø17-Ø20 8		

<b>Type / Model</b>	<b>REF. NO.</b>	<b>ŞEM NO.</b>	
	83960010503	<b>7457</b>	
		<b>Description</b>	
		Rubber Sleeve	
			Ø35-Ø28 7.5
<b>Type / Model</b>	<b>REF. NO.</b>	<b>ŞEM NO.</b>	
	81960200170	<b>7458</b>	
		<b>Description</b>	
		Rubber Buffer	
			Ø40-Ø17 30
<b>Type / Model</b>	<b>REF. NO.</b>	<b>ŞEM NO.</b>	
	83960010005	<b>7465</b>	
		<b>Description</b>	
		Rubber Stopper	
			Ø12.8x9
<b>Type / Model</b>	<b>REF. NO.</b>	<b>ŞEM NO.</b>	
26.270	81961010261	<b>7466</b>	
		<b>Description</b>	
		Packing	
			9x3.5 1.5
<b>Type / Model</b>	<b>REF. NO.</b>	<b>ŞEM NO.</b>	
	81960010042	<b>7467</b>	
		<b>Description</b>	
		Rubber Sleeve	
			Ø7.5 Ø11.5 Ø16 8.5
<b>Type / Model</b>	<b>REF. NO.</b>	<b>ŞEM NO.</b>	
	83960010009	<b>7468</b>	
		<b>Description</b>	
		Rubber Sleeve	
			Ø28 Ø35 Ø42 15

SEM NO.	REF. NO.	Type / Model
7474	81960200044	
<b>Description</b>		
Rubber Buffer		
Ø 28x18		



SEM NO.	REF. NO.	Type / Model
7476	81960010004	
<b>Description</b>		
Rubber Sleeve		
Ø10 Ø16 Ø22 8,5		



SEM NO.	REF. NO.	Type / Model
7477	83960020507	
<b>Description</b>		
Rubber Stopper		
Ø20 Ø15,5 15		



SEM NO.	REF. NO.	Type / Model
7486	83960020508	
<b>Description</b>		
Rubber Stopper		
D=Ø41 h=21		







SEM NO.	REF. NO.	Type / Model
7551	83960010015	
<b>Description</b>		
Bush		
Ø42.5-Ø30 40		



SEM NO.	REF. NO.	Type / Model
7561	81960010354	
<b>Description</b>		
Sleeve		
D=Ø36 d=Ø51 h=18		



Type / Model	REF. NO.	ŞEM NO.	
	83965010501	7568	
			<b>Description</b> Rubber Buffer D=Ø60.5 d=Ø37.5 h=19.5
Type / Model	REF. NO.	ŞEM NO.	
	81960010043 81960010373	7572	
			<b>Description</b> Rubber Sleeve D=Ø13 d=Ø6 h=8
Type / Model	REF. NO.	ŞEM NO.	
	83962100216	7625	
			<b>Description</b> Rubber Sleeve Ø 22x16
Type / Model	REF. NO.	ŞEM NO.	
	83960020516	7641	
			<b>Description</b> Packing
Type / Model	REF. NO.	ŞEM NO.	
	81960200058	7703	
			<b>Description</b> Packing

SEM NO.	REF. NO.	Type / Model
8375	81611400016	TGA XXL



**Description**

Pressure Spring

685 MM 200 N

SEM NO.	REF. NO.	Type / Model
8376	81748200095	26.270 19.422 19.423



**Description**

Pressure Spring

720 MM 220 N

SEM NO.	REF. NO.	Type / Model
8377	81611306500	26230



**Description**

Pressure Spring

350 MM 220 N

SEM NO.	REF. NO.	Type / Model
8378	81748210149 81748210146	TG 460 A XXL



**Description**

Pressure Spring

50 N

SEM NO.	REF. NO.	Type / Model
8379	81748210039	TG 460 A XXL



**Description**

Pressure Spring

350 N







SEM NO.	REF. NO.	Type / Model
9211	81748210068	



**Description**

Pressure Spring

925-380N

Type / Model	REF. NO.	SEM NO.
F 90 F 2000	81748210108 81748210107	9212
		
		<b>Description</b> Pressure Spring 290-600N
Type / Model	REF. NO.	SEM NO.
16.240 16.290 16.370	81748210063	9213
		
		<b>Description</b> Pressure Spring 700-360N
Type / Model	REF. NO.	SEM NO.
	81629006179	9706
		
		<b>Description</b> Pressure Spring 147-37-350N.
Type / Model	REF. NO.	SEM NO.
	81748210041	9707
		
		<b>Description</b> Pressure Spring 425-170-200N.
Type / Model	REF. NO.	SEM NO.
	81748210104	9708
		
		<b>Description</b> Pressure Spring 315-125-250N.
Type / Model	REF. NO.	SEM NO.
	81748210048	9709
		
		<b>Description</b> Pressure Spring 920-410-360N

SEM NO.	REF. NO.	Type / Model
<b>9710</b>	81970060016 81748210141	
 <p><b>Description</b> Pressure Spring</p>		
275-104-400N.		

SEM NO.	REF. NO.	Type / Model
<b>9711</b>	81970060001 81748210148	
 <p><b>Description</b> Pressure Spring</p>		
315-120-120N.		







SEM NO.	REF. NO.	Type / Model
<b>9712</b>	81748210131	
 <p><b>Description</b> Pressure Spring</p>		
650-325-250N.		

SEM NO.	REF. NO.	Type / Model
<b>9713</b>	81748210109	
 <p><b>Description</b> Pressure Spring</p>		
650-325-250N.		







SEM NO.	REF. NO.	Type / Model
<b>9714</b>	81970060002	
 <p><b>Description</b> Pressure Spring</p>		
685-300-180N.		

SEM NO.	REF. NO.	Type / Model
<b>9715</b>	81970060003	
 <p><b>Description</b> Pressure Spring</p>		
785-350-150N.		









Type / Model	REF. NO.	SEM NO.	
TGA	81970060010	10642	 <p><b>Description</b> Pressure Spring</p> <p>186-69-50N</p>
TGA TGX	81970060020 81970060033	10643	 <p><b>Description</b> Pressure Spring</p> <p>484-198-50N</p>
	81748210065	11006	 <p><b>Description</b> Pressure Spring</p> <p>138-60N</p>
	81748210110	11007	 <p><b>Description</b> Pressure Spring</p> <p>277-50N</p>
	81748210084	11008	 <p><b>Description</b> Pressure Spring</p> <p>425-100N</p>
	81748210125	11025	 <p><b>Description</b> Pressure Spring</p> <p>485-250N</p>







	SEM NO.	REF. NO.	Type / Model
 <p>485-200N</p>	11026	81748210130	
<p><b>Description</b> Pressure Spring</p>			







Type / Model	REF. NO.	ŞEM NO.	
	81618516023S 81618516020 81618516019 81618516029 81618516011	8178	
			<b>Description</b> Cabin Locked
Type / Model	REF. NO.	ŞEM NO.	
	85618516003 81618516003 81618516030	8195	
			<b>Description</b> Cabin Locked
Type / Model	REF. NO.	ŞEM NO.	
	81618516023S1 81618516019S 81618516029S 81618516011S 81618516020S	10300	
			<b>Description</b> Cabin Locked
Type / Model	REF. NO.	ŞEM NO.	
	81626806095	11536	
			<b>Description</b> Door Catch L
Type / Model	REF. NO.	ŞEM NO.	
	81626806096	11537	
			<b>Description</b> Door Catch R
Type / Model	REF. NO.	ŞEM NO.	
26.230 26.231	83960200004	7482	
			<b>Description</b> Rubber Buffer









SEM NO.	REF. NO.	Type / Model
9504	81626800132	TGA
<b>Description</b>		
Pull Right		







<b>Type / Model</b>	<b>REF. NO.</b>	<b>ŞEM NO.</b>	
TGA	81351140135	9737	
			h : 250 mm d : 225 mm
<b>Type / Model</b>	<b>REF. NO.</b>	<b>ŞEM NO.</b>	
TGA	81351140159	9739	
			h : 290 mm d : 265 mm
<b>Type / Model</b>	<b>REF. NO.</b>	<b>ŞEM NO.</b>	
	81351146075S	11298	
			h 1: 262 mm h 2: 240 mm
<b>Type / Model</b>	<b>REF. NO.</b>	<b>ŞEM NO.</b>	
26.281	81351140109S	11299	
			h 1: 272 mm h 2: 250 mm
<b>Type / Model</b>	<b>REF. NO.</b>	<b>ŞEM NO.</b>	
TGA 41.440/33.360	81351140126	11303	
			h 1: 250 mm h 2: 228 mm
<b>Type / Model</b>	<b>REF. NO.</b>	<b>ŞEM NO.</b>	
	81351146075S1	11304	
			57 mm

	<p><b>ŞEM NO.</b> <b>11305</b></p>	<p><b>REF. NO.</b> 81351140109S1</p>	<p><b>Type / Model</b> 26.270</p>
<p><b>Description</b> Planetary Carrier</p>			
<p>67 mm</p>			
	<p><b>ŞEM NO.</b> <b>9740</b></p>	<p><b>REF. NO.</b> 81351140134</p>	<p><b>Type / Model</b> TGA</p>
<p><b>Description</b> Planet Carrier</p>			
<p>h : 77 mm</p>			
	<p><b>ŞEM NO.</b> <b>11307</b></p>	<p><b>REF. NO.</b> 81351140130</p>	<p><b>Type / Model</b> TGA</p>
<p><b>Description</b> Planetary Carrier</p>			
<p>Q 27 mm</p>			
	<p><b>ŞEM NO.</b> <b>9732 (9733)</b></p>	<p><b>REF. NO.</b> 81351146075</p>	<p><b>Type / Model</b></p>
<p><b>Description</b> Bell Hub</p>			
<p>h : 265 mm d : 240 mm</p>			
	<p><b>ŞEM NO.</b> <b>9734 (10829)</b></p>	<p><b>REF. NO.</b> 81351140109</p>	<p><b>Type / Model</b> OM 355</p>
<p><b>Description</b> Bell Hub</p>			
<p>h : 275 mm d : 250 mm</p>			
	<p><b>ŞEM NO.</b> <b>9742</b></p>	<p><b>REF. NO.</b> 81351126005</p>	<p><b>Type / Model</b></p>
<p><b>Description</b> Planet Gear</p>			
<p>Q 45x75x31x34 mm</p>			

<b>Type / Model</b>	<b>REF. NO.</b>	<b>ŞEM NO.</b>	
TGA	81351130055	11322	
			<b>Description</b> Sun Gear Right
<b>Type / Model</b>	<b>REF. NO.</b>	<b>ŞEM NO.</b>	
TGA	81351130054	11323	
			<b>Description</b> Sun Gear Left
<b>Type / Model</b>	<b>REF. NO.</b>	<b>ŞEM NO.</b>	
SMALL DIFFERENTIAL SL 200	81351130022	9816	
			<b>Description</b> Sun Gear
			Z = 23 i = 3.48
<b>Type / Model</b>	<b>REF. NO.</b>	<b>ŞEM NO.</b>	
TGA	81351126024	11320	
			<b>Description</b> Planet Gear Full / Right
<b>Type / Model</b>	<b>REF. NO.</b>	<b>ŞEM NO.</b>	
TGA	81351126023	11321	
			<b>Description</b> Planet Gear Full / Left
<b>Type / Model</b>	<b>REF. NO.</b>	<b>ŞEM NO.</b>	
	81907110640	9876	
			<b>Description</b> Thrust Washer





	<table border="1"> <thead> <tr> <th>ŞEM NO.</th> <th>REF. NO.</th> </tr> </thead> <tbody> <tr> <td>7319</td> <td>06563414254 06563324254</td> </tr> </tbody> </table>	ŞEM NO.	REF. NO.	7319	06563414254 06563324254	<b>Type / Model</b>
ŞEM NO.	REF. NO.					
7319	06563414254 06563324254					
<b>Description</b> Toric Seal						
D=Ø255 d=Ø5 D=Ø240 d=Ø5.3						
	<table border="1"> <thead> <tr> <th>ŞEM NO.</th> <th>REF. NO.</th> </tr> </thead> <tbody> <tr> <td>9891</td> <td>81351400013</td> </tr> </tbody> </table>	ŞEM NO.	REF. NO.	9891	81351400013	<b>Type / Model</b> TGA
ŞEM NO.	REF. NO.					
9891	81351400013					
<b>Description</b> Hub						
	<table border="1"> <thead> <tr> <th>ŞEM NO.</th> <th>REF. NO.</th> </tr> </thead> <tbody> <tr> <td>11358</td> <td>81354010060</td> </tr> </tbody> </table>	ŞEM NO.	REF. NO.	11358	81354010060	<b>Type / Model</b> 26.281 33.372
ŞEM NO.	REF. NO.					
11358	81354010060					
<b>Description</b> Trangchse						
	<table border="1"> <thead> <tr> <th>ŞEM NO.</th> <th>REF. NO.</th> </tr> </thead> <tbody> <tr> <td>9744 (9745)</td> <td>81351006615 81351006618</td> </tr> </tbody> </table>	ŞEM NO.	REF. NO.	9744 (9745)	81351006615 81351006618	<b>Type / Model</b> STELL SMALL DIFFERENTIAL 2521
ŞEM NO.	REF. NO.					
9744 (9745)	81351006615 81351006618					
<b>Description</b> Supporter type without gear						
	<table border="1"> <thead> <tr> <th>ŞEM NO.</th> <th>REF. NO.</th> </tr> </thead> <tbody> <tr> <td>9749 (9750)</td> <td>81351076010</td> </tr> </tbody> </table>	ŞEM NO.	REF. NO.	9749 (9750)	81351076010	<b>Type / Model</b> SMALL DIFFERENTIAL 2521
ŞEM NO.	REF. NO.					
9749 (9750)	81351076010					
<b>Description</b> Axle introduction - Repair Kit						
	<table border="1"> <thead> <tr> <th>ŞEM NO.</th> <th>REF. NO.</th> </tr> </thead> <tbody> <tr> <td>9758</td> <td>81451006329</td> </tr> </tbody> </table>	ŞEM NO.	REF. NO.	9758	81451006329	<b>Type / Model</b> STELL SMALL DIFFERENTIAL 26.281
ŞEM NO.	REF. NO.					
9758	81451006329					
<b>Description</b> Axle introduction Small Bushing (Steel)						

<p><b>Type / Model</b></p> <p>STELL SMALL DIFFERENTIAL WITHOUT SCREW 26.281</p>	<p><b>REF. NO.</b></p> <p>81351056030 81351056035 81351006088</p>	<p><b>ŞEM NO.</b></p> <p><b>9760</b></p>	 <p><b>Description</b></p> <p>Differential Case / Small Bushing (Steel)</p>
<p><b>Type / Model</b></p> <p>SMALL DIFFERENTIAL 26.281</p>	<p><b>REF. NO.</b></p> <p>81351076001</p>	<p><b>ŞEM NO.</b></p> <p><b>9762</b></p>	 <p><b>Description</b></p> <p>Repair Kit Differential / Small Bushing</p>
<p><b>Type / Model</b></p> <p>BIG DIFFERENTIAL 4140</p>	<p><b>REF. NO.</b></p> <p>81351076035</p>	<p><b>ŞEM NO.</b></p> <p><b>9783 (9784)</b></p>	 <p><b>Description</b></p> <p>Differential Gear</p>
<p><b>Type / Model</b></p> <p>BIG DIFFERENTIAL 4140</p>	<p><b>REF. NO.</b></p> <p>81351076035S</p>	<p><b>ŞEM NO.</b></p> <p><b>9785 (9786)</b></p>	 <p><b>Description</b></p> <p>Differential Case</p>
<p><b>Type / Model</b></p> <p>AXOR 4140</p>	<p><b>REF. NO.</b></p> <p>81351076035S1</p>	<p><b>ŞEM NO.</b></p> <p><b>9789 (9790)</b></p>	 <p><b>Description</b></p> <p>Big Differential Repair Kit / Screw</p>
<p><b>Type / Model</b></p> <p>TGA</p>	<p><b>REF. NO.</b></p> <p>81351076043 81351076026</p>	<p><b>ŞEM NO.</b></p> <p><b>9791</b></p>	 <p><b>Description</b></p> <p>Differential Repair Kit</p>

	ŞEM NO.	REF. NO.	Type / Model
	9797	81351076020	19.422
<b>Description</b>	Differential Repair Kit		







	ŞEM NO.	REF. NO.	Type / Model
	9803	81351006361	BIG DIFFERENTIAL WITHOUT SCREW
<b>Description</b>	Differential Case		







	ŞEM NO.	REF. NO.	Type / Model
	9805 (9806)	81351076008 81351076007	
<b>Description</b>	Repair Kit / Differential Big Bushing		

	ŞEM NO.	REF. NO.	Type / Model
	9807 (9808)	81351006327	
<b>Description</b>	Full Differential Case Differential Big Bushing		







	ŞEM NO.	REF. NO.	Type / Model
	9819	81351006593	WITHOUT SCREW
<b>Description</b>	Big Differential Case		







	ŞEM NO.	REF. NO.	Type / Model
	9820	81351006087 81351006588	WITHOUT SCREW 26.281 26.321
<b>Description</b>	Small Differential Case		

Type / Model	REF. NO.	ŞEM NO.	
26.281	81351006087S 81351006588S	81351006087-1 pcs. 81356080024-1 pcs. 81351080008-4 pcs. 81907010722-4 pcs. 81356180003-1 pcs. 81352040034-1 pcs. 06022024212-12 pcs.	<p><b>9822</b></p> <p><b>Description</b> Full Small Differential Gear</p> 
TGA 410-480 1037	81351050062		<p><b>9893</b></p> <p><b>Description</b> Differential Case</p> 
TGA 410-480 1037	81351050063		<p><b>9894</b></p> <p><b>Description</b> Differential Cover</p> 
TGA 18.430 1237	81351050060		<p><b>9895</b></p> <p><b>Description</b> Differential Case</p> 
TGA 1237	81351050061		<p><b>9896</b></p> <p><b>Description</b> Differential Cover</p> 
TGA 410-480 1037	81351050062S	81351050062- 1 pcs. 81351050063- 1 pcs. 81351056026- 1 pcs.	<p><b>9898</b></p> <p><b>Description</b> Differential Case / Full</p> 

	<p><b>ŞEM NO.</b> <b>9899</b></p> <p><b>Description</b> Differential Case / Full</p>	<p><b>REF. NO.</b> 81351050060S</p> <p>81351050060- 1 pcs. 81351050061- 1 pcs. 81351056026- 1 pcs.</p>	<p><b>Type / Model</b> TGA COMMOROIL 1237</p>
	<p><b>ŞEM NO.</b> <b>9911 (9912)</b></p> <p><b>Description</b> Differential Gear</p>	<p><b>REF. NO.</b> 81351076033</p>	<p><b>Type / Model</b> BIG DIFFERENTIAL 4140</p>
	<p><b>ŞEM NO.</b> <b>9913 (9914)</b></p> <p><b>Description</b> Differential Case</p>	<p><b>REF. NO.</b> 81351076033S</p>	<p><b>Type / Model</b> BIG DIFFERENTIAL 4140</p>
	<p><b>ŞEM NO.</b> <b>9917 (9918)</b></p> <p><b>Description</b> Big Differential Repair Kit / Lagging</p>	<p><b>REF. NO.</b> 81351076033S2</p>	<p><b>Type / Model</b> 4140</p>
	<p><b>ŞEM NO.</b> <b>11312</b></p> <p><b>Description</b> Big Differential Gear / Lagging / Front</p>	<p><b>REF. NO.</b> 81351076033S3</p>	<p><b>Type / Model</b> TGA</p>
	<p><b>ŞEM NO.</b> <b>9787 (9788)</b></p> <p><b>Description</b> Oil Collector</p>	<p><b>REF. NO.</b> 81351050073</p>	<p><b>Type / Model</b> BIG DIFFERENTIAL 4140</p>















<b>Type / Model</b>	<b>REF. NO.</b>	<b>ŞEM NO.</b>	
SMALL DIFFERENTIAL	81356110017	9905	
			<b>Description</b> Shaft
<b>Type / Model</b>	<b>REF. NO.</b>	<b>ŞEM NO.</b>	
BIG DIFFERENTIAL	81356110018	9907	
			<b>Description</b> Shaft
<b>Type / Model</b>	<b>REF. NO.</b>	<b>ŞEM NO.</b>	
	81353016063	9862	
	81351250006- 1 pcs. 81351250004- 1 pcs. 06022020717- 4 pcs.		
		<b>Description</b> Axle Husing / Differential Small / Front	
<b>Type / Model</b>	<b>REF. NO.</b>	<b>ŞEM NO.</b>	
	81353016064	9863	
	81351250006- 1 pcs. 81351250004- 1 pcs. 06022020717- 4 pcs.		
		<b>Description</b> Axle Husing / Differential Small / Rear	
<b>Type / Model</b>	<b>REF. NO.</b>	<b>ŞEM NO.</b>	
	81351076033S1	9915 (9916)	
			<b>Description</b> Differential Spider
<b>Type / Model</b>	<b>REF. NO.</b>	<b>ŞEM NO.</b>	
SMALL DIFFERENTIAL 26.281	81351070020	9765	
			<b>Description</b> Differential Spider Bushing







	<b>ŞEM NO.</b> 9792	<b>REF. NO.</b> 81351070032	<b>Type / Model</b> TGA
<b>Description</b> Differential Spider			
	<b>ŞEM NO.</b> 9825	<b>REF. NO.</b> 81356080024	<b>Type / Model</b> SMALL DIFFERENTIAL
<b>Description</b> Differential Spider			
	<b>ŞEM NO.</b> 9837	<b>REF. NO.</b> 81356085001	<b>Type / Model</b> BIG DIFFERENTIAL
<b>Description</b> Differential Spider			
	<b>ŞEM NO.</b> 9798	<b>REF. NO.</b> 81351070025	<b>Type / Model</b> 19.422
<b>Description</b> Differential Spider			
	<b>ŞEM NO.</b> 9766	<b>REF. NO.</b> 81351080049	<b>Type / Model</b> SMALL DIFFERENTIAL 26.281
<b>Description</b> Differential Pinion			
	<b>ŞEM NO.</b> 9772 (9773)	<b>REF. NO.</b> 81351060028	<b>Type / Model</b> SMALL DIFFERENTIAL GEAR 16 T
<b>Description</b> Side Gear / Differential Small Bushing			















Type / Model	REF. NO.	ŞEM NO.	
TGA	81351080078	9793	 <p><b>Description</b> Differential Pinion</p>
TGA	81351060055	9795	 <p><b>Description</b> Side Gear</p>
19.422	81351080060	9799	 <p><b>Description</b> Differential Pinion</p>
19.422	81351060037	9801	 <p><b>Description</b> Side Gear</p>
BIG DIFFERENTIAL 19.422	81351080008	9827	 <p><b>Description</b> Differential Pinion</p>
BIG DIFFERENTIAL 19.422	81356090006	9839	 <p><b>Description</b> Differential Pinion</p>

	<p><b>ŞEM NO.</b> <b>10801</b></p> <p><b>Description</b> Whell Hub Drive</p>	<p><b>REF. NO.</b> 81356100017</p>	<p><b>Type / Model</b></p>
	<p><b>ŞEM NO.</b> <b>9831</b></p> <p><b>Description</b> Side Gear</p>	<p><b>REF. NO.</b> 81356180003</p>	<p><b>Type / Model</b> SMALL DIFFERENTIAL</p>
	<p><b>ŞEM NO.</b> <b>9843</b></p> <p><b>Description</b> Side Gear</p>	<p><b>REF. NO.</b> 81356170001</p>	<p><b>Type / Model</b> BIG DIFFERENTIAL</p>
	<p><b>ŞEM NO.</b> <b>11325</b></p> <p><b>Description</b> Differential Gear / Assembled / Big Dif.</p>	<p><b>REF. NO.</b> 81351076032</p>	<p><b>Type / Model</b> TGA</p>
	<p><b>ŞEM NO.</b> <b>11326</b></p> <p><b>Description</b> Differential Gear / Assembled / Small Dif.</p>	<p><b>REF. NO.</b> 81351076045</p>	<p><b>Type / Model</b> TGA</p>
	<p><b>ŞEM NO.</b> <b>9768 (9769)</b></p> <p><b>Description</b> Washer / Differential Small Bushing</p>	<p><b>REF. NO.</b> 81907010727</p>	<p><b>Type / Model</b> FOR SMALL DIFFERENTIAL</p>







Type / Model	REF. NO.	SEM NO.	
TGA	81907140248	9794	 <b>Description</b> Washer
19.422	81907100931	9800	 <b>Description</b> Washer
SMALL DIFFERENTIAL	81907010722	9829	 <b>Description</b> Washer
SMALL DIFFERENTIAL	81907010721	9841	 <b>Description</b> Washer
FOR SMALL DIFFERENTIAL	81356130026	9774 (9775)	 <b>Description</b> Side Gear / Differential Small Bushing
TGA	81356130050	9796	 <b>Description</b> Thrust Washer

	<b>ŞEM NO.</b>	<b>REF. NO.</b>	<b>Type / Model</b>
	9802	81356130040	19.422
	<b>Description</b> Thrust Washer		
	<b>ŞEM NO.</b>	<b>REF. NO.</b>	<b>Type / Model</b>
	9833	81352040034	SMALL DIFFERENTIAL
	<b>Description</b> Thrust Washer		
2,60 mm			
	<b>ŞEM NO.</b>	<b>REF. NO.</b>	<b>Type / Model</b>
	9901	81356130014	SMALL DIFFERENTIAL
	<b>Description</b> Thrust Washer		
4 mm			
	<b>ŞEM NO.</b>	<b>REF. NO.</b>	<b>Type / Model</b>
	9903	81352040022	BIG DIFFERENTIAL
	<b>Description</b> Thrust Washer		
4 mm			
	<b>ŞEM NO.</b>	<b>REF. NO.</b>	<b>Type / Model</b>
	9847	81352040310	BIG DIFFERENTIAL
	<b>Description</b> Thrust Washer		
	<b>ŞEM NO.</b>	<b>REF. NO.</b>	<b>Type / Model</b>
	9871	81357100044	26.321
	<b>Description</b> Thrust Ring		
115x145 mm			







<b>Type / Model</b>	<b>REF. NO.</b>	<b>ŞEM NO.</b>	
19.422	81357100067	<b>9873</b>	
		<b>Description</b>	Thrust Ring
			135x145
<b>Type / Model</b>	<b>REF. NO.</b>	<b>ŞEM NO.</b>	
SMALL DIFFERENTIAL	81351250006	<b>9852</b>	
		<b>Description</b>	Screw Collar
<b>Type / Model</b>	<b>REF. NO.</b>	<b>ŞEM NO.</b>	
SMALL DIFFERENTIAL	81351250004	<b>9854</b>	
		<b>Description</b>	Screw Coller
<b>Type / Model</b>	<b>REF. NO.</b>	<b>ŞEM NO.</b>	
BIG DIFFERENTIAL	81351250003	<b>9856</b>	
		<b>Description</b>	Differential Gear Adjustment
<b>Type / Model</b>	<b>REF. NO.</b>	<b>ŞEM NO.</b>	
BIG DIFFERENTIAL	81351250012	<b>9858</b>	
		<b>Description</b>	Differential Gear Adjustment
<b>Type / Model</b>	<b>REF. NO.</b>	<b>ŞEM NO.</b>	
	81351250048	<b>9860 (9861)</b>	
		<b>Description</b>	Screw Collar



	<b>ŞEM NO.</b>	<b>REF. NO.</b>	<b>Type / Model</b>
	9892	81351250023	
	<b>Description</b>		
	Screw Coller		
	<b>ŞEM NO.</b>	<b>REF. NO.</b>	<b>Type / Model</b>
	11330	06121140121	
	<b>Description</b>		
	Nut		
	<b>ŞEM NO.</b>	<b>REF. NO.</b>	<b>Type / Model</b>
	11333	81906200092	TGA
	<b>Description</b>		
	Nut		
	<b>ŞEM NO.</b>	<b>REF. NO.</b>	<b>Type / Model</b>
	11334	81351250040	TGA
	<b>Description</b>		
	Nut		
	<b>ŞEM NO.</b>	<b>REF. NO.</b>	<b>Type / Model</b>
	11335	81351250035	AXOR 4141
	<b>Description</b>		
	Nut		
	<b>ŞEM NO.</b>	<b>REF. NO.</b>	<b>Type / Model</b>
	11337	81351250007	
	<b>Description</b>		
	Grooved Nut / Small Differential		

M 102\*1,5 mm

Type / Model	REF. NO.	ŞEM NO.	
	81906850053	11338	
			<b>Description</b> Grooved Nut / Old Model /Big Differential
Type / Model	REF. NO.	ŞEM NO.	
SMALL DIFFERENTIAL	06028190002	9878	
			<b>Description</b> Screw 12x1x28 mm
Type / Model	REF. NO.	ŞEM NO.	
	81900100067	9880	
			<b>Description</b> Screw 14x1,5x80 mm
Type / Model	REF. NO.	ŞEM NO.	
	06017344371	9882 (9883)	
			<b>Description</b> Big Differential 12x1,5x80
Type / Model	REF. NO.	ŞEM NO.	
SMALL DIFFERENTIAL	81904050189	9884 (9885)	
			<b>Description</b> Screw 12x1,5x70 mm
Type / Model	REF. NO.	ŞEM NO.	
SMALL DIFFERENTIAL	06022020212	9886 (9887)	
			<b>Description</b> Screw 10x1,5x70 mm



	<b>ŞEM NO.</b> 9888 (9889)	<b>REF. NO.</b> 06028190004	<b>Type / Model</b>
	<b>Description</b> Differential Big		
14x1,5x95 mm			
	<b>ŞEM NO.</b> 9897	<b>REF. NO.</b> 06028163416	<b>Type / Model</b> SMALL DIFFERENTIAL
	<b>Description</b> Screw		
18x1,5x55 mm			
	<b>ŞEM NO.</b> 9919 (9920)	<b>REF. NO.</b> 06028163020	<b>Type / Model</b>
	<b>Description</b> Screw		
M16x1,5x75			
	<b>ŞEM NO.</b> 9921	<b>REF. NO.</b> 06022020717	<b>Type / Model</b>
	<b>Description</b> Screw		
M16x1,5x95			
	<b>ŞEM NO.</b> 9835	<b>REF. NO.</b> 81930200679	<b>Type / Model</b> SMALL DIFFERENTIAL
	<b>Description</b> Bushing		
	<b>ŞEM NO.</b> 9845	<b>REF. NO.</b> 81930200678	<b>Type / Model</b> SMALL DIFFERENTIAL
	<b>Description</b> Bushing		

Type / Model	REF. NO.	ŞEM NO.	
BIG DIFFERENTIAL	81930200569	9850	 <b>Description</b> Bushing
BIG DIFFERENTIAL	81930200568	9909	
BIG DIFFERENTIAL	81930200459 81930200482	11629	 <b>Description</b> Bush(Kingpin)  D = Ø57 d = Ø50 L = 45
BIG DIFFERENTIAL	81930200460	11630	
BIG DIFFERENTIAL	81930200460	11630	 <b>Description</b> Bush(Kingpin)  D = Ø57 d = Ø50 L = 50



SEM NO.



REF. NO.

Type / Model

12956

81394106023

81394106034







81394106033







81394106031





**Description**

Propeller Shaft Bearing

D=65L=13 Ax=220 Ax=85

Type / Model	REF. NO.	SEM NO.	
26.281 26.321	81305600050	9493	
			<b>Description</b> Clutch Lever
Type / Model	REF. NO.	SEM NO.	
SI200 SR240	81305600041	9495	
			<b>Description</b> Clutch Lever
Type / Model	REF. NO.	SEM NO.	
32.270 26.270	81305600061	9496	
			<b>Description</b> Clutch Lever
Type / Model	REF. NO.	SEM NO.	
32.270 26.270	81305600061S  81305600061- 1 pcs. 81305600055- 1 pcs. 81305606019- 1 pcs.	10021	
			<b>Description</b> Release Lever Complete
Type / Model	REF. NO.	SEM NO.	
19.422	81324110007	9497	
			<b>Description</b> Clutch Lever
Type / Model	REF. NO.	SEM NO.	
19.422	81324110007S  81305600051-1 pcs. 81305606019-1 pcs.	9498	
			<b>Description</b> Clutch Lever

	<b>SEM NO.</b>	<b>REF. NO.</b>	<b>Type / Model</b>
	10022	81324110007S1 81324110006S1	19.423 19.463
<b>Description</b> Release Lever Complete		81324110007- 1 pcs. 81324040002- 1 pcs. 81305606019- 1 pcs.	
	<b>SEM NO.</b>	<b>REF. NO.</b>	<b>Type / Model</b>
	9499	81305600063 81305600056 81305600057	SI232
<b>Description</b> Clutch Lever			
	<b>SEM NO.</b>	<b>REF. NO.</b>	<b>Type / Model</b>
	10033	81305600063S 81305600056S 81305600057S	SI232
<b>Description</b> Release Lever - Complete		81305600063- 1 pcs. 81305600055- 1 pcs. 81305606019- 1 pcs.	
	<b>SEM NO.</b>	<b>REF. NO.</b>	<b>Type / Model</b>
	10025	81324110008 1315268013	TGA
<b>Description</b> Release Lever			
	<b>SEM NO.</b>	<b>REF. NO.</b>	<b>Type / Model</b>
	9500	81305600055	32.270 26.270 19.422
<b>Description</b> Leaf Spring Bearing			
	<b>SEM NO.</b>	<b>REF. NO.</b>	<b>Type / Model</b>
	9501	81324040002	19.423 19.463
<b>Description</b> Leaf Spring Bearing			

Type / Model	REF. NO.	SEM NO.	
TGA	81910200775 ZF1316321038	10026	 <p><b>Description</b> Spindle</p>
26.281 26.321	81953020044 81953020053 81953020043 81953020051	9494	 <p><b>Description</b> Tie Rod End</p> <p>D=Ø30,5 M12x1,5</p>
32.270 26.270 19.463	81305606019	9502	 <p><b>Description</b> Clutch Lever Repair Kit</p>
	81305606021	10027	 <p><b>Description</b> Release Lever Repair Kit</p>

SEM NO.	REF. NO.	Type / Model
12835	81506106210 81506106166	
 <p><b>Description</b> Brake Slack Adjuster, Automatic-Right</p> <p>Ø 14x145x144°</p>		

SEM NO.	REF. NO.	Type / Model
12836	81506106211 81506106165	
 <p><b>Description</b> Brake Slack Adjuster, Automatic-Left</p> <p>Ø 14x145x144°</p>		













SEM NO.	REF. NO.	Type / Model
12837	81506106231 81506106081 81506106151	
 <p><b>Description</b> Brake Slack Adjuster, Automatic</p> <p>Ø 14x145x75°</p>		

SEM NO.	REF. NO.	Type / Model
12838	81506106212 81506106154 81506106084	
 <p><b>Description</b> Brake Slack Adjuster, Automatic-Right</p> <p>Ø 14x145x339°</p>		

SEM NO.	REF. NO.	Type / Model
12841	81506106213 81506106153 81506106083	
 <p><b>Description</b> Brake Slack Adjuster, Automatic-Left</p> <p>Ø 14x145x339°</p>		

SEM NO.	REF. NO.	Type / Model
12846	81506106203 81506106181	
 <p><b>Description</b> Brake Slack Adjuster, Automatic</p> <p>Ø 14x130x103°</p>		



<b>Type / Model</b>	<b>REF. NO.</b>		<b>SEM NO.</b>	
	81506106215		12856	
	81506106177			
	81506106139			
<b>Description</b>				
Brake Slack Adjuster, Automatic-Left				
				Ø 14x145x101°
<b>Type / Model</b>	<b>REF. NO.</b>		<b>SEM NO.</b>	
	81506106262		12857	
	81506106252			
<b>Description</b>				
Brake Slack Adjuster, Automatic-Right				
				Ø 14x145x0°
<b>Type / Model</b>	<b>REF. NO.</b>		<b>SEM NO.</b>	
	81506106214		12862	
	81506106176			
	81506106140			
<b>Description</b>				
Brake Slack Adjuster, Automatic-Right				
				Ø 14x145x101°
<b>Type / Model</b>	<b>REF. NO.</b>		<b>SEM NO.</b>	
	81506106261		12878	
	81506106251			
<b>Description</b>				
Brake Slack Adjuster, Automatic-Left				
				Ø 14x145x0°
<b>Type / Model</b>	<b>REF. NO.</b>		<b>SEM NO.</b>	
	81506106263		12879	
	81506106253			
<b>Description</b>				
Brake Slack Adjuster, Automatic				
				Ø 14x145x0°
<b>Type / Model</b>	<b>REF. NO.</b>		<b>SEM NO.</b>	
	81506106266		12881	
	81506106258			
<b>Description</b>				
Brake Slack Adjuster, Automatic-Right				
				Ø 14x145x0°



SEM NO.		REF. NO.	Type / Model
12883		81506106260 81506106254	

**Description**

Brake Slack Adjuster, Automatic-Right

Ø 14x145x0°













SEM NO.		REF. NO.	Type / Model
12884		81506106259 81506106255	





**Description**



Brake Slack Adjuster, Automatic-Left

Ø 14x145x0°

Type / Model	REF. NO.	SEM NO.	
		7206	 <b>Description</b> Bellows
Type / Model	REF. NO.	SEM NO.	
20.190 22.190 26.280 26.281	81964200248	7338	 <b>Description</b> Bellows
Type / Model	REF. NO.	SEM NO.	
20.190 22.190 26.280 26.281	81965010873	7339	 <b>Description</b> Seal  D=Ø45- d=Ø35 -h=21
Type / Model	REF. NO.	SEM NO.	
26.240 26.280 32.240 32.280 33.365	81962100132	7386	 <b>Description</b> Rubber Metal Buffer  D=Ø50 h=45 M10x25 SHORE A45
Type / Model	REF. NO.	SEM NO.	
26.280	81964010114	7392	 <b>Description</b> Cup  D=Ø125 d=Ø105 h=17
Type / Model	REF. NO.	SEM NO.	
19.280 26.280 ZF 70 ZF 90 ZF 110		7402	 <b>Description</b> Repair Kit

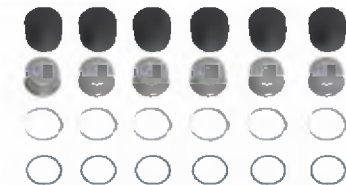

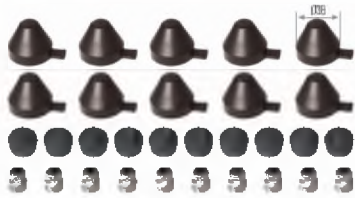



	SEM NO.	REF. NO.	Type / Model
 <p><b>Description</b> Repair Kit</p>	<b>7403</b>	81321706091	26.281 16 S ZF 130
	<hr/>		
 <p><b>Description</b> Repair Kit</p>	<b>7404</b>	81326380006S	26.281 SR 240 SL 200 ZF 130
	<hr/>		
 <p><b>Description</b> Rubber Buffer</p> <p>30x39.5</p>	<b>7553</b>	81960020267	19.372 19.422 26.230 26.270 26.321 33.372 SL.232
	<hr/>		
 <p><b>Description</b> Pedal Cover</p> <p>A=70 B=75 h=11</p>	<b>7618</b>	81482270006	18.230 19.372 19.442 26.270 33.372 SL232 S2000





Type / Model	REF. NO.	ŞEM NO.	
KN TYPE SN 5001, SN 5002, SN 5003, SN 5005, SN 5006, SN 5007, SN 5008, SN 5011, SN 5012, SN 5013, SN 5015, SN 5016, SN 5017, SN 5020, SN 5021, SN 5022, SN 5023, SN 5030, SN 5031, SN 5032, SN 5033	81508226027	<b>10680</b>	 <p><b>Description</b> Caliper Repair Kit</p>
KN TYPE All SB 5..., SB 6..., SB 7..., SN 5... Series	81508226022	<b>10683</b>	 <p><b>Description</b> Caliper Repair Kit</p>
KN TYPE NA 7027, NA 7028, NA 7037, NA 7038, NA 75..., SK 7..., SN 65..., SN 66..., SN 7..., SN 71..., SN 72..., SN 73.. Series	81508226020	<b>10684</b>	 <p><b>Description</b> Caliper Repair Kit</p>
KN TYPE IVECO TYPE	81508226023	<b>10689</b>	 <p><b>Description</b> Caliper Repair Kit</p>
KN TYPE / IVECO TYPE SN 6529, SN 6539, SN 7067, SN 7077, SN 7084, SN 7094, SN 7086, SN 7096, SN 7106, SN 7116, SN 7125, SN 7135, SN 7144, SN 7154, NA 7027, NA 7028, NA 7038, SK 7..., SN 65..., SN 66..., SN 7..., SN 71..., SN 72..., SN 73.. Series	81508226019	<b>10690</b>	 <p><b>Description</b> Caliper Repair Kit</p>
KN TYPE All SB... & SN... Series	81508226025	<b>10691</b>	 <p><b>Description</b> Caliper Repair Kit</p>

	SEM NO.	REF. NO.	Type / Model
	<b>10696</b>	81508226021 81508226024	KN TYPE SB 5..., SB 6..., SB 7... Series
	<b>Description</b>		
	<b>10698</b>	81508226026	KN TYPE SN 5... Series
	<b>Description</b>		
	<b>10995</b>		KN TYPE
	<b>Description</b>		

Type / Model	REF. NO.	ŞEM NO.	
MRT TYPE	81508026021	<b>10733</b>	<p><b>Description</b> Caliper Repair Kit</p>
MRT TYPE LRG 542, 543, 570, 571, 574, 575, 576, 577, 586, 587, 588, 589, 590, 591 616, 617, 632, 633, 642, 643, 704, 705, 752, 753, LUCAS KJ47/JJ47	81508026016	<b>10734</b>	<p><b>Description</b> Caliper Repair Kit</p>
MRT TYPE All LRG Series LRG 544, 545, 572, 573, 580, 581, 582, 583, 638, 639, 646, 647, 658, 659 662, 663, 664, 665, 669, 670, 700, 701, 712, 713, 720, 721, 722, 723, 724, 725, 736, 737, 744, 745, 748, 749, 750, 751	81508026024	<b>10748</b>	<p><b>Description</b> Caliper Repair Kit</p>
MRT TYPE LRG 544, 545, 572, 573, 580, 581, 582, 583, 638, 639, 646, 647, 658, 659 662, 663, 700, 701, 712, 713, 722, 723, 744, 745, 748, 749, 750, 751	81508026025	<b>10761</b>	<p><b>Description</b> Caliper Repair Kit</p>
MRT TYPE LRG 524, 525, 526, 527, 528, 529, 532, 533, 562, 563	81508026008 81508026009	<b>12358</b>	<p><b>Description</b> Caliper Repair Kit</p>
LRG 573, 574, 575, 590, 591, 704, 705 MRT TYPE	81508026022	<b>12398</b>	<p><b>Description</b> Caliper Repair Kit</p>

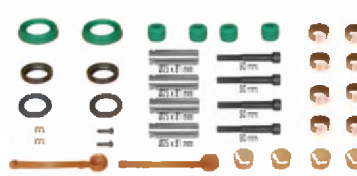
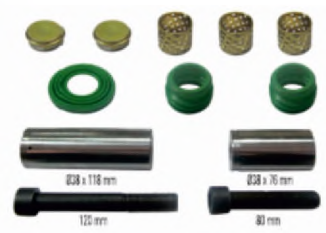







	SEM NO.	REF. NO.	Type / Model
	12429	81508046199	MRT TYPE LRG 570
<b>Description</b>	Caliper Repair Kit		
	SEM NO.	REF. NO.	Type / Model
	12430	81508046200	MRT TYPE LRG 571
<b>Description</b>	Caliper Repair Kit		
	SEM NO.	REF. NO.	Type / Model
	12464	81259376015	MRT TYPE TGA
<b>Description</b>	Pad Wear Indicator (Front Left-Right)		
	SEM NO.	REF. NO.	Type / Model
	12465	81259376041 81259376010 81259376017	MRT TYPE TGA
<b>Description</b>	Pad Wear Indicator (Back Left)		
	SEM NO.	REF. NO.	Type / Model
	12466	81259376044 81259376018 81259376022	MRT TYPE
<b>Description</b>	Pad Wear Indicator (Back Right)		
	SEM NO.	REF. NO.	Type / Model
	12480	81508046238	MRT TYPE LRG 639
<b>Description</b>	Caliper Repair Kit		
	SEM NO.	REF. NO.	Type / Model
	12380	81508026007	MRT TYPE LRG 524, 525, 526, 527, 528, 529, 532, 533, 622, 623
<b>Description</b>	Caliper Repair Kit		



Type / Model	REF. NO.	SEM NO.	
WBC TYPE 40 175 025, 026, 027, 028, 049, 050, 051, 052	81508226003	10769	 <p><b>Description</b> Caliper Repair Kit</p>
WBC TYPE	81508006023	12527	 <p><b>Description</b> Caliper Repair Kit</p>
WBC TYPE MAXX 22	81508226038	12608	 <p><b>Description</b> Caliper Repair Kit</p>
WBC TYPE MAXX 22	81508226042	12609	 <p><b>Description</b> Caliper Repair Kit</p>
WBC TYPE MAXX 22	81508226039	12611	 <p><b>Description</b> Caliper Repair Kit</p>
WBC TYPE MAXX 22	81508226040	12621	 <p><b>Description</b> Caliper Repair Kit</p>

	SEM NO.	REF. NO.	Type / Model
	<b>12622</b>	81508046087 81508046355 81508046071 81508049071 81508046089 81508049087	WBC TYPE
	<b>Description</b>		
	Caliper Repair Kit 17,5" (Left)		
	SEM NO.	REF. NO.	Type / Model
	<b>12623</b>	81508046070 81508049070 81508046354 81508049088	WBC TYPE
	<b>Description</b>		
	Caliper Repair Kit 17,5" (Right)		
	SEM NO.	REF. NO.	Type / Model
	<b>12629</b>	81508046579	WBC TYPE MAXX 22
	<b>Description</b>		
	Caliper Repair Kit 19,5" (Left)		
	SEM NO.	REF. NO.	Type / Model
	<b>12630</b>	81508046582	WBC TYPE MAXX 22
	<b>Description</b>		
	Caliper Repair Kit 19,5" (Right)		

Model:	ŞEM NO.	Description / Brake Shoe (Welded)
	(9924) <b>9923</b>	
	REF. NO: 81502016114	
	220 mm	
Model:	ŞEM NO.	Description / Brake Shoe (Welded)
	<b>9925</b>	
	REF. NO: 81502016193	
	180 mm	
Model:	ŞEM NO.	Description / Brake Shoe (Welded)
	<b>9927</b>	
	REF. NO: 81502016192	
	160 mm	
Model:	ŞEM NO.	Description / Brake Shoe (Casting)
	<b>9931</b>	
	REF. NO: 81502016114 S	
	220 mm	

Description / Brake Shoe (Casting)	SEM NO.	Model:
	<p><b>9933</b></p> <p>REF. NO: 81502016184</p> <p>180 mm</p>	
	<p><b>9046</b></p> <p>REF. NO: 81502016098</p> <p>160 mm</p>	

<b>Type / Model</b>	<b>REF. NO.</b>	<b>SEM NO.</b>	 <b>Description</b> Brake Shoe (Casting) 220 mm
	81502016188	9938	
<b>Type / Model</b>	<b>REF. NO.</b>	<b>SEM NO.</b>	 <b>Description</b> Brake Shoe (Casting) 160 mm
	81502016187	9939	
<b>Type / Model</b>	<b>REF. NO.</b>	<b>SEM NO.</b>	 <b>Description</b> Brake Anchor
	81502020080	9940	
<b>Type / Model</b>	<b>REF. NO.</b>	<b>SEM NO.</b>	 <b>Description</b> Joint Bearing Full
	81502136006S	9943	
<b>Type / Model</b>	<b>REF. NO.</b>	<b>SEM NO.</b>	 <b>Description</b> Pin Q30 mm
	81502120032 81502120036	9945	
<b>Type / Model</b>	<b>REF. NO.</b>	<b>SEM NO.</b>	 <b>Description</b> Joint Bearing With Bushing
	81502136006	9947	

	<b>SEM NO.</b> 9949	<b>REF. NO.</b> 81502110023	<b>Type / Model</b>
	<b>Description</b> Pin		
Q.20 mm			
	<b>SEM NO.</b> 9951	<b>REF. NO.</b> 81930200576	<b>Type / Model</b>
	<b>Description</b> Bushing		
30x34x47 mm			
	<b>SEM NO.</b> 9954 (9955)	<b>REF. NO.</b> 81522120036S	<b>Type / Model</b> For Two Brake Shoe
	<b>Description</b> Brake Shoe Repair Kit		



## MERCEDES GROUP



Engine and Transmission Group .....	:	182 - 263
Steering Group .....	:	264 - 279
Suspension Group .....	:	280 - 398
Cab Group .....	:	399 - 421
Axle / Differential ve Shaft Group.....	:	422 - 449
Clutch and Brake Group.....	:	450 - 467

	ŞEM NO.	REF. NO.	Type / Model
		7400	6452400118
3872400218			1926
3832400718			1932
6172400318			2626
<b>Description</b> Engine Mounting		6452400218	2628
		3872400418	
		6172400518	

M16x1.5 M12x1.5

	ŞEM NO.	REF. NO.	Type / Model
		7535	6452400418
6202400418			621
6202400518			2622
6202400018			
<b>Description</b> Engine Mounting		6202400218	
		6452400518	
		6202400118	

M 18x1.5 M 14x1.5

	ŞEM NO.	REF. NO.	Type / Model	
		7536	6452400018	393
3872400718			395	346
6172400418			620	363
			621	383
<b>Description</b> Engine Mounting			1935	385
			1938	387
				389
			391	

M 16x1.5 M 12x1.5

	ŞEM NO.	REF. NO.	Type / Model	
		7537	6202400318	620
6452400318			621	
<b>Description</b> Engine Mounting				

M 18x1.5 M 14x1.5

	ŞEM NO.	REF. NO.	Type / Model
		7584	6152400318
3812400718			2521
6152400418			2524
6152400218			
<b>Description</b> Engine Mounting		3812400618	
		3862407218	

M 14x1.5 M 12x1.5

	ŞEM NO.	REF. NO.	Type / Model
		7630	6522400318
6522400018			3031
6522400118			
<b>Description</b> Engine Mounting			

M 16x1.5 M 12x1.5

Type / Model	REF. NO.	SEM NO.	
	3572400118 3012401118 3012401618 6172400018 6172400118 6172400218	<b>7637</b>	 <p><b>Description</b> Engine Mounting (Epdm)</p> <p>M 16x1.5 M 12x1.5</p>
Type / Model	REF. NO.	SEM NO.	
	3572400218	<b>7638</b>	 <p><b>Description</b> Engine Mounting (Epdm)</p> <p>M 16x1.5 M 12x1.5</p>
Type / Model	REF. NO.	SEM NO.	
	3572400318 3002400718 3002400818 3002400918	<b>7639</b>	 <p><b>Description</b> Engine Mounting (Epdm)</p> <p>M 16x1.5 M 12x1.5</p>
Type / Model	REF. NO.	SEM NO.	
	3572400418 6162400618 6162400718 6162400818	<b>7650</b>	 <p><b>Description</b> Engine Mounting (Epdm) Left</p> <p>M 16x1.5 M 12x1.5</p>
Type / Model	REF. NO.	SEM NO.	
	3572400618 3002400418 3002400518 3002400618	<b>7720</b>	 <p><b>Description</b> Engine Mounting (Epdm) Right</p> <p>M 16x1.5 M 12x1.5</p>
Type / Model	REF. NO.	SEM NO.	
	6712400017	<b>7957</b>	 <p><b>Description</b> Engine Mounting</p>

	SEM NO.	REF. NO.	Type / Model
	7958	6712400117	
	<b>Description</b> Engine Mounting		

	SEM NO.	REF. NO.	Type / Model
	8445	6452400918	
	<b>Description</b> Engine Mounting		

M18x1.5 M14x1.5

	SEM NO.	REF. NO.	Type / Model
	7401	3872400417 3872400317 3872400017	1626 1628 1922 1926 1928 1932 2026 2032 2226 2232 2626 2638
	<b>Description</b> Engine Mounting		

M16x1.5 M12x1.5







	SEM NO.	REF. NO.	Type / Model
	7538	6202400317 6202400517 6202400417	1628 1633 1636 1638 1928 1933 1936 1938 2626 2633 2636 2638
	<b>Description</b> Engine Mounting		

M 16x1.5 M 16x1.5

	SEM NO.	REF. NO.	Type / Model
	7642	6202400717 6202400017 6202400217 6202400117	
	<b>Description</b> Engine Mounting		

	SEM NO.	REF. NO.	Type / Model
	8373	6582410013 6582410113 6582410213	
	<b>Description</b> Engine Mounting		







Type / Model	REF. NO.	SEM NO.	
	9412411713 9412417713 9412414713 9412415713 6342410513	7868	 <p><b>Description</b> Engine Mounting</p>
	9412417813 9412415813 9412411813 9412414813 6932410113	7869	
	9412417913 9412415913 6962410013	7870	
	9412417113 9412415113 9412414113 9412411113	7871	
	9412417213 9412415213	7872	
	9412417313 9412415313 9412414313 9412411313	7873	 <p><b>Description</b> Engine Mounting</p>







	<b>SEM NO.</b>	<b>REF. NO.</b>	<b>Type / Model</b>
	<b>7874</b>	9412417413 9412415413	
	<b>Description</b>	Engine Mounting	
	<b>SEM NO.</b>	<b>REF. NO.</b>	<b>Type / Model</b>
	<b>7875</b>	9412417513 9412415513 9412414513 9412411513	
	<b>Description</b>	Engine Mounting	
	<b>SEM NO.</b>	<b>REF. NO.</b>	<b>Type / Model</b>
	<b>7876</b>	9412417613 9412415613	
	<b>Description</b>	Engine Mounting	
	<b>SEM NO.</b>	<b>REF. NO.</b>	<b>Type / Model</b>
	<b>7930</b>	6292400217 6292400017	
	<b>Description</b>	Engine Mounting	
	<b>SEM NO.</b>	<b>REF. NO.</b>	<b>Type / Model</b>
	<b>7961</b>	6282401717 6282400117 53RS201507	
	<b>Description</b>	Engine Mounting	
	<b>SEM NO.</b>	<b>REF. NO.</b>	<b>Type / Model</b>
	<b>7970</b>	6282401817 6282400217	
	<b>Description</b>	Engine Mounting	









<b>Type / Model</b>	<b>REF. NO.</b>	<b>SEM NO.</b>	
	6282402317 6282400917 6282402517 6282401017 6282402417	<b>8140</b> (11582-11750)	
		<b>Description</b>	
		Engine Mounting (Epdm)	
<b>Type / Model</b>	<b>REF. NO.</b>	<b>SEM NO.</b>	
	6282402017 6282400717	<b>8304</b>	
		<b>Description</b>	
		Engine Mounting	
<b>Type / Model</b>	<b>REF. NO.</b>	<b>SEM NO.</b>	
	9412416713	<b>9187</b>	
		<b>Description</b>	
		Engine Mounting	
		M18x1.5 M14x1.5	
<b>Type / Model</b>	<b>REF. NO.</b>	<b>SEM NO.</b>	
	6282402717	<b>11763</b>	
		<b>Description</b>	
		Engine Mounting (Epdm)	
<b>Type / Model</b>	<b>REF. NO.</b>	<b>SEM NO.</b>	
	9412419713	<b>8499</b>	
		<b>Description</b>	
		Engine Mounting	
<b>Type / Model</b>	<b>REF. NO.</b>	<b>SEM NO.</b>	
	9412418713 6342410913	<b>8500</b>	
		<b>Description</b>	
		Engine Mounting	







	<b>ŞEM NO.</b> 8816	<b>REF. NO.</b> 9412418113	<b>Type / Model</b>
<b>Description</b> Engine Mounting			
	<b>ŞEM NO.</b> 9188	<b>REF. NO.</b> 9412418213	<b>Type / Model</b>
<b>Description</b> Engine Mounting			
M18x1,5    M14x1,5			
	<b>ŞEM NO.</b> 9189	<b>REF. NO.</b> 9412418313	<b>Type / Model</b>
<b>Description</b> Engine Mounting			
M18x1,5    M14x1,5			
	<b>ŞEM NO.</b> 9190	<b>REF. NO.</b> 9412418413	<b>Type / Model</b>
<b>Description</b> Engine Mounting			
M18x1,5    M14x1,5			
	<b>ŞEM NO.</b> 9191	<b>REF. NO.</b> 9412418513	<b>Type / Model</b>
<b>Description</b> Engine Mounting			
M18x1,5    M14x1,5			
	<b>ŞEM NO.</b> 9192	<b>REF. NO.</b> 9412418613	<b>Type / Model</b>
<b>Description</b> Engine Mounting			
M18x1,5    M14x1,5			

<b>Type / Model</b>	<b>REF. NO.</b>	<b>SEM NO.</b>	
	9412418813 9402410213 6932410413	<b>9193</b>	
			<b>Description</b> Engine Mounting
			M18x1,5 M14x1,5
<b>Type / Model</b>	<b>REF. NO.</b>	<b>SEM NO.</b>	
	9412418913	<b>9194</b>	
			<b>Description</b> Engine Mounting
			M18x1,5 M14x1,5
<b>Type / Model</b>	<b>REF. NO.</b>	<b>SEM NO.</b>	
	9402401118	<b>7884</b>	
			<b>Description</b> Engine Mounting
<b>Type / Model</b>	<b>REF. NO.</b>	<b>SEM NO.</b>	
	9402401218	<b>7885</b>	
			<b>Description</b> Engine Mounting
<b>Type / Model</b>	<b>REF. NO.</b>	<b>SEM NO.</b>	
	9402401318	<b>7886</b>	
			<b>Description</b> Engine Mounting
<b>Type / Model</b>	<b>REF. NO.</b>	<b>SEM NO.</b>	
	6292400018	<b>7887</b>	
			<b>Description</b> Engine Mounting

	<b>SEM NO.</b>	<b>REF. NO.</b>	<b>Type / Model</b>
	7889	6292400218	
<b>Description</b>			
Engine Mounting			
	<b>SEM NO.</b>	<b>REF. NO.</b>	<b>Type / Model</b>
	10838	9402402118	
<b>Description</b>			
Engine Mounting			
M14x1,5 Ax= 100x100 L=124			
	<b>SEM NO.</b>	<b>REF. NO.</b>	<b>Type / Model</b>
	7907	9402400817	
<b>Description</b>			
Engine Mounting			
Left			
	<b>SEM NO.</b>	<b>REF. NO.</b>	<b>Type / Model</b>
	7908	9402400917	
<b>Description</b>			
Engine Mounting			
Right			
	<b>SEM NO.</b>	<b>REF. NO.</b>	<b>Type / Model</b>
	9516	9702400317	
<b>Description</b>			
Engine Mounting			
	<b>SEM NO.</b>	<b>REF. NO.</b>	<b>Type / Model</b>
	10868	9702400417	1218 1318
<b>Description</b>			
Engine Mounting			
Ax=150x65 L=204			

<b>Type / Model</b>	<b>REF. NO.</b>	<b>SEM NO.</b>	
O309 O310 L408 L409 L508 L608	3142230012	7440	
			<b>Description</b> Engine Mounting
M 16 x 1.5			
<b>Type / Model</b>	<b>REF. NO.</b>	<b>SEM NO.</b>	
GM314 OM316 O309 O310 L409 L508 L608	3142230112	7441	
			<b>Description</b> Engine Mounting
<b>Type / Model</b>	<b>REF. NO.</b>	<b>SEM NO.</b>	
D6 L409 L508 O309	3102420113 3102400013	7442	
			<b>Description</b> Engine Mounting
<b>Type / Model</b>	<b>REF. NO.</b>	<b>SEM NO.</b>	
	6552410713 6552410113	7660	
			<b>Description</b> Engine Mounting (Left)
M 16x1.5			
<b>Type / Model</b>	<b>REF. NO.</b>	<b>SEM NO.</b>	
	6552410713S 6552410113S 6552410613S 6552410013S	7660-1 (7661-1)	
			<b>Description</b> Engine Mounting (Right)
M 16x1.5			
<b>Type / Model</b>	<b>REF. NO.</b>	<b>SEM NO.</b>	
	6552410613 6552410013	7661	
			<b>Description</b> Engine Mounting (Left)
M 16x1.5			

	<b>ŞEM NO.</b>	<b>REF. NO.</b>	<b>Type / Model</b>
	7730	3072400017 3072400117	
	<b>Description</b> Engine Mounting		
	<b>ŞEM NO.</b>	<b>REF. NO.</b>	<b>Type / Model</b>
	8533	3012402917 3012401917	
	<b>Description</b> Engine Mounting		
	<b>ŞEM NO.</b>	<b>REF. NO.</b>	<b>Type / Model</b>
	8534	3972400417 3012403017	
	<b>Description</b> Engine Mounting		
	<b>ŞEM NO.</b>	<b>REF. NO.</b>	<b>Type / Model</b>
	8535	3832400317 3832400217 3832400917 3832401717	
	<b>Description</b> Engine Mounting		
	<b>ŞEM NO.</b>	<b>REF. NO.</b>	<b>Type / Model</b>
	11277	9012412513 9012412713	SPRINTER VW LT 28-35 VW LT 28-46 CRYSLER DODGE
	<b>Description</b> Engine Mounting		
	<b>ŞEM NO.</b>	<b>REF. NO.</b>	<b>Type / Model</b>
	11279	6012400617	T1 T1/TN T2/LN1
	<b>Description</b> Engine Mounting		

Type / Model	REF. NO.	SEM NO.	
	3222850082	9002	 <b>Description</b> Rubber Bushing D=Ø46 d=Ø29 h=58
Type / Model	REF. NO.	SEM NO.	
SPRINTER	9012421513	11278	 <b>Description</b> Rubber Mounting
VW LT 28-35	9012421413		
VW LT 28-46			
CRYSLER			
DODGE			
Type / Model	REF. NO.	SEM NO.	
100D	6312410065	11280	 <b>Description</b> Engine Mounting

	<b>SEM NO.</b> <b>12890</b>		<b>REF. NO.</b> 0019933996	<b>Type / Model</b>
	<b>Description</b> V Ribbed Belt			
6PK691				
	<b>SEM NO.</b> <b>11682</b>		<b>REF. NO.</b> 9069934996	<b>Type / Model</b>
	<b>Description</b> V Ribbed Belt			
8PK1158				
	<b>SEM NO.</b> <b>11683</b>		<b>REF. NO.</b> 9069971392	<b>Type / Model</b>
	<b>Description</b> V Ribbed Belt			
8PK1190				
	<b>SEM NO.</b> <b>10319</b>		<b>REF. NO.</b> 5419972892 0029932496	<b>Type / Model</b>
	<b>Description</b> V Ribbed Belt			
8PK1215				
	<b>SEM NO.</b> <b>10320 (10321)</b>		<b>REF. NO.</b> 9069974492	<b>Type / Model</b>
	<b>Description</b> V Ribbed Belt			
8PK1220				
	<b>SEM NO.</b> <b>10329</b>		<b>REF. NO.</b> 9069933996	<b>Type / Model</b>
	<b>Description</b> V Ribbed Belt			
8PK1371				

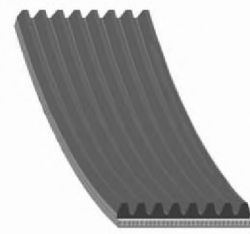
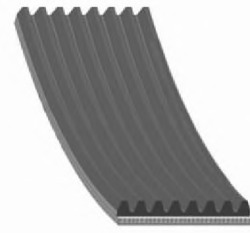
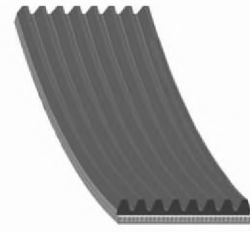
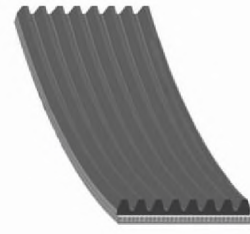
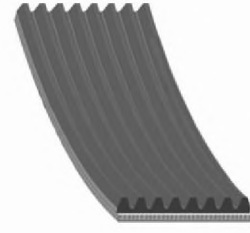
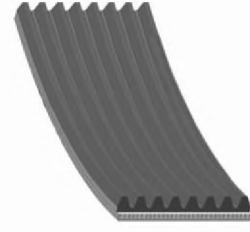

<b>Type / Model</b>	<b>REF. NO.</b>	<b>SEM NO.</b>	
	9069937996	<b>10330 (10331)</b>	
		<b>Description</b>	
		V Ribbed Belt	
			8PK1376
<b>Type / Model</b>	<b>REF. NO.</b>	<b>SEM NO.</b>	
	9069972492	<b>10332</b>	
		<b>Description</b>	
		V Ribbed Belt	
			8PK1420
<b>Type / Model</b>	<b>REF. NO.</b>	<b>SEM NO.</b>	
	9069937196	<b>11686</b>	
		<b>Description</b>	
		V Ribbed Belt	
			8PK1427
<b>Type / Model</b>	<b>REF. NO.</b>	<b>SEM NO.</b>	
	9069970892	<b>10334</b>	
		<b>Description</b>	
		V Ribbed Belt	
			8PK1450
<b>Type / Model</b>	<b>REF. NO.</b>	<b>SEM NO.</b>	
	9069970792	<b>10336</b>	
		<b>Description</b>	
		V Ribbed Belt	
			8PK1480
<b>Type / Model</b>	<b>REF. NO.</b>	<b>SEM NO.</b>	
	0139976092	<b>10342</b>	
		<b>Description</b>	
		V Ribbed Belt	
			8PK1580

	SEM NO.	REF. NO.	Type / Model
	<b>10344</b>	0149977892 0159971192 0019932596 159973292	
	<b>Description</b>		
		V Ribbed Belt	

8PK1610

	SEM NO.	REF. NO.	Type / Model
	<b>10346 (10347)</b>	9069936796 9069939696	
	<b>Description</b>		
		V Ribbed Belt	

8PK1635

	SEM NO.	REF. NO.	Type / Model
	<b>10350</b>	9069938996	
	<b>Description</b>		
		V Ribbed Belt	

8PK1795

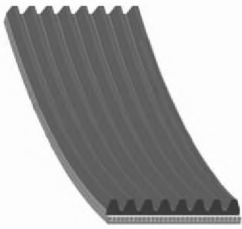
	SEM NO.	REF. NO.	Type / Model
	<b>10352</b>	0009939996 9069937096 9069973192	
	<b>Description</b>		
		V Ribbed Belt	

8PK1852

	SEM NO.	REF. NO.	Type / Model
	<b>10356</b>	9069972892	
	<b>Description</b>		
		V Ribbed Belt	

8PK1908

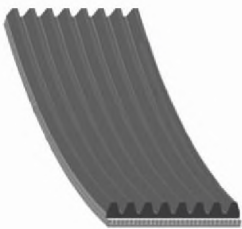
	SEM NO.	REF. NO.	Type / Model
	<b>11689</b>	9069934196	
	<b>Description</b>		
		V Ribbed Belt	

8PK1914

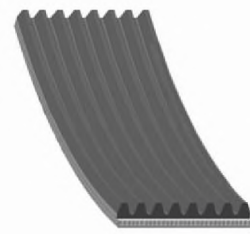
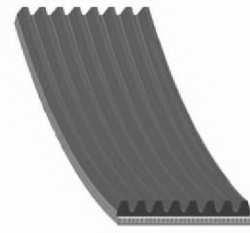
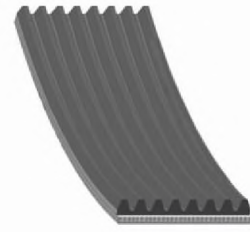
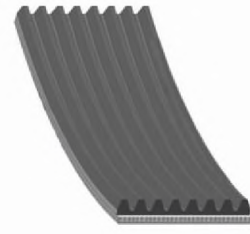
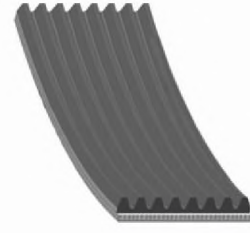
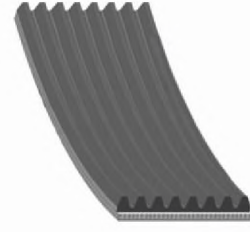
<b>Type / Model</b>	<b>REF. NO.</b>	<b>SEM NO.</b>	
	9069973292	10360	
		<b>Description</b>	
		V Ribbed Belt	8PK1988
<b>Type / Model</b>	<b>REF. NO.</b>	<b>SEM NO.</b>	
	9069971292	10362	
		<b>Description</b>	
		V Ribbed Belt	8PK2000
<b>Type / Model</b>	<b>REF. NO.</b>	<b>SEM NO.</b>	
	9069973792	12896	
		<b>Description</b>	
		V Ribbed Belt	8PK2020
<b>Type / Model</b>	<b>REF. NO.</b>	<b>SEM NO.</b>	
	9069972392	10363	
		<b>Description</b>	
		V Ribbed Belt	8PK2043
<b>Type / Model</b>	<b>REF. NO.</b>	<b>SEM NO.</b>	
	9069971092	10367	
		<b>Description</b>	
		V Ribbed Belt	8PK2063
<b>Type / Model</b>	<b>REF. NO.</b>	<b>SEM NO.</b>	
	9069971192	10369	
		<b>Description</b>	
		V Ribbed Belt	8PK2080

	SEM NO.	REF. NO.	Type / Model
	<b>10372</b>	0109972992	
	<b>Description</b>		
	V Ribbed Belt		
8PK2380			

	SEM NO.	REF. NO.	Type / Model
	<b>10375</b>	9069970992	
	<b>Description</b>		
	V Ribbed Belt		

	SEM NO.	REF. NO.	Type / Model
	<b>10377 (10378)</b>	0129976092 0019935796	
	<b>Description</b>		
	V Ribbed Belt		

	SEM NO.	REF. NO.	Type / Model
	<b>10380</b>	0159972192	
	<b>Description</b>		
	V Ribbed Belt		

	SEM NO.	REF. NO.	Type / Model
	<b>10381</b>	0149973492 0019931696	
	<b>Description</b>		
	V Ribbed Belt		

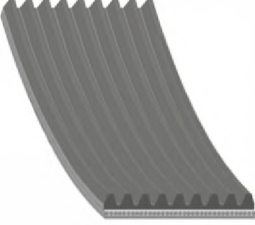
	SEM NO.	REF. NO.	Type / Model
	<b>11694</b>	9937296	
	<b>Description</b>		
	V Ribbed Belt		

9PK1880			
---------	--	--	--

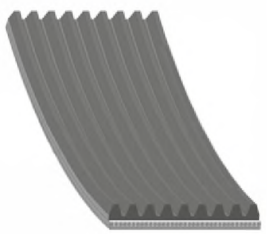
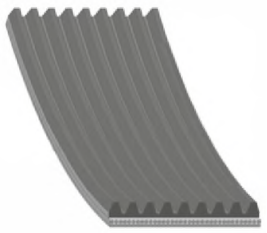
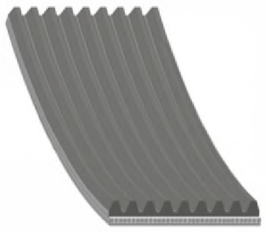
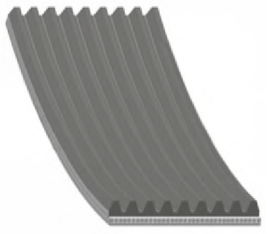
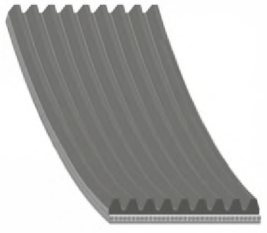
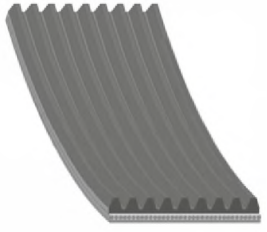
<b>Type / Model</b>	<b>REF. NO.</b>	<b>SEM NO.</b>	
	0139974392 0009937296 0149977392	<b>10383</b>	
		<b>Description</b>	
		V Ribbed Belt	
9PK1885			
<b>Type / Model</b>	<b>REF. NO.</b>	<b>SEM NO.</b>	
	5419970892	<b>10384</b>	
		<b>Description</b>	
		V Ribbed Belt	
9PK1890			
<b>Type / Model</b>	<b>REF. NO.</b>	<b>SEM NO.</b>	
	0149975392	<b>12898</b>	
		<b>Description</b>	
		V Ribbed Belt	
9PK1896			
<b>Type / Model</b>	<b>REF. NO.</b>	<b>SEM NO.</b>	
	0139971792 0159971792 0009937796 0139975792 0019934896 0019937196 0019934996	<b>10386</b>	
		<b>Description</b>	
		V Ribbed Belt	
9PK1920			
<b>Type / Model</b>	<b>REF. NO.</b>	<b>SEM NO.</b>	
	0139973592	<b>12899</b>	
		<b>Description</b>	
		V Ribbed Belt	
9PK2000			
<b>Type / Model</b>	<b>REF. NO.</b>	<b>SEM NO.</b>	
	0139971792 0159971792	<b>10388</b>	
		<b>Description</b>	
		V Ribbed Belt	
9PK2010			

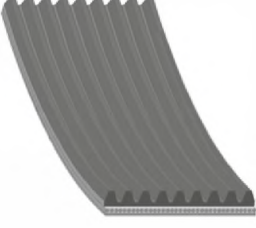
	<b>SEM NO.</b> <b>10389</b>	<b>REF. NO.</b> 0139976192	<b>Type / Model</b>
	<b>Description</b> V Ribbed Belt		
9PK2060			
	<b>SEM NO.</b> <b>10390</b>	<b>REF. NO.</b> 0129973892	<b>Type / Model</b>
	<b>Description</b> V Ribbed Belt		
9PK2080			
	<b>SEM NO.</b> <b>10392</b>	<b>REF. NO.</b> 0149976092	<b>Type / Model</b>
	<b>Description</b> V Ribbed Belt		
9PK2100			
	<b>SEM NO.</b> <b>10393</b>	<b>REF. NO.</b> 0129972092 0019935696	<b>Type / Model</b>
	<b>Description</b> V Ribbed Belt		
9PK2125			
	<b>SEM NO.</b> <b>10394</b>	<b>REF. NO.</b> 0019932796	<b>Type / Model</b>
	<b>Description</b> V Ribbed Belt		
9PK2140			
	<b>SEM NO.</b> <b>11695</b>	<b>REF. NO.</b> 5419971092	<b>Type / Model</b>
	<b>Description</b> V Ribbed Belt		
9PK2295			

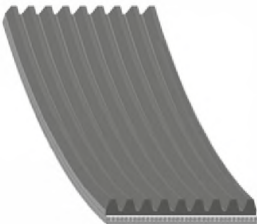
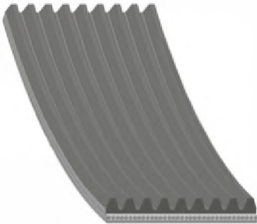
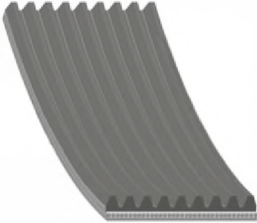
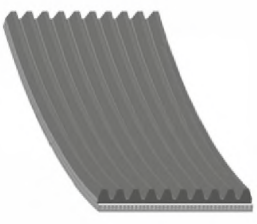
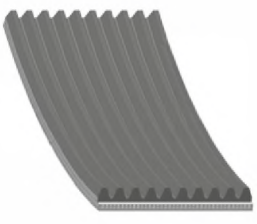
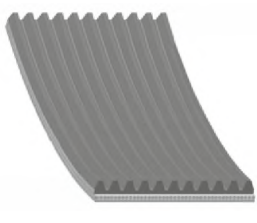
<b>Type / Model</b>	<b>REF. NO.</b>		<b>SEM NO.</b>	
	0019932496		<b>12902</b>	
			<b>Description</b>	
			V Ribbed Belt	9PK2338
<b>Type / Model</b>	<b>REF. NO.</b>		<b>SEM NO.</b>	
	5419970992 4768025000		<b>10395</b>	
			<b>Description</b>	
			V Ribbed Belt	9PK2835
<b>Type / Model</b>	<b>REF. NO.</b>		<b>SEM NO.</b>	
	0019937296		<b>11696</b>	
			<b>Description</b>	
			V Ribbed Belt	9PK2871
<b>Type / Model</b>	<b>REF. NO.</b>		<b>SEM NO.</b>	
	9069972692		<b>11699</b>	
			<b>Description</b>	
			V Ribbed Belt	10PK1350
<b>Type / Model</b>	<b>REF. NO.</b>		<b>SEM NO.</b>	
	0139972792		<b>10403</b>	
			<b>Description</b>	
			V Ribbed Belt	10PK1725
<b>Type / Model</b>	<b>REF. NO.</b>		<b>SEM NO.</b>	
	5419972692		<b>10408</b>	
			<b>Description</b>	
			V Ribbed Belt	11PK1890



	SEM NO.	REF. NO.	Type / Model
	<b>10409</b>	0139973092	
	<b>Description</b>		
	V Ribbed Belt		

11PK2020

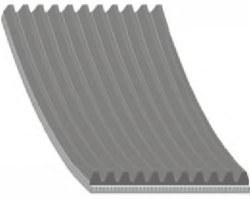
	SEM NO.	REF. NO.	Type / Model
	<b>11702</b>	129972192	
	<b>Description</b>		
	V Ribbed Belt		

11PK2055

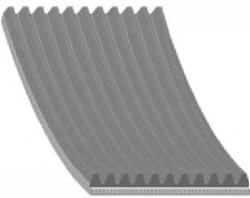
	SEM NO.	REF. NO.	Type / Model
	<b>11703</b>	5419972792	
	<b>Description</b>		
	V Ribbed Belt		

11PK2835

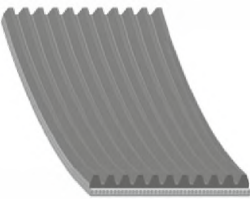
	SEM NO.	REF. NO.	Type / Model
	<b>11704</b>	0019937496	
	<b>Description</b>		
	V Ribbed Belt		

11PK2871

	SEM NO.	REF. NO.	Type / Model
	<b>10410 (10411)</b>	5419972592	
	<b>Description</b>		
	V Ribbed Belt		



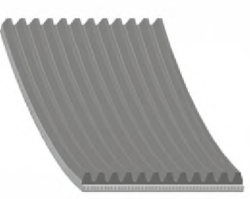







12PK1515







	SEM NO.	REF. NO.	Type / Model
	<b>10413</b>	5429970092	
	<b>Description</b>		
	V Ribbed Belt		







12PK2490





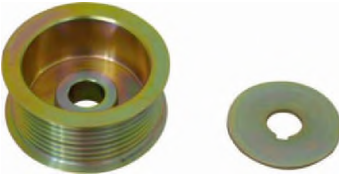

Type / Model	REF. NO.		SEM NO.	
	0009977092	0079970392	12901	
	0029973892	0079971692		
	0039970192	0099976892		
	0059976992	0099976992		
	0069971092	0109972092		
	0069974392	0109974992		
	0069979092			
	0069979792			
			<b>Description</b>	
			V Ribbed Belt	
				2XAVX13X1025





	<b>SEM NO.</b> 12131		<b>REF. NO.</b> 0032050106	<b>Type / Model</b>
	<b>Description</b> Blade, Fan			
	<b>SEM NO.</b> 12133		<b>REF. NO.</b> 9062050406	<b>Type / Model</b>
	<b>Description</b> Blade, Fan			
	<b>SEM NO.</b> 13027		<b>REF. NO.</b> 0032054206 0032054506	<b>Type / Model</b>
	<b>Description</b> Blade, Fan			
	<b>SEM NO.</b> 12130		<b>REF. NO.</b> 0002008122 0002003522 0002004722 0002003223 0002007022 0002004222 0002007122	<b>Type / Model</b>
	<b>Description</b> Visco Drive, Fan			
	<b>SEM NO.</b> 12132		<b>REF. NO.</b> 9062000822 9062001822	<b>Type / Model</b>
	<b>Description</b> Visco Drive, Fan			
	<b>SEM NO.</b> 9466		<b>REF. NO.</b> 3661320019	<b>Type / Model</b> 2517 2521 2524
	<b>Description</b> Pulley			







<b>Type / Model</b>	<b>REF. NO.</b>	<b>SEM NO.</b>	
345K	3572060010	<b>9467</b>	
		<b>Description</b>	
		Pulley	
<b>Type / Model</b>	<b>REF. NO.</b>	<b>SEM NO.</b>	
345K	3575060210	<b>9468</b>	
		<b>Description</b>	
		Pulley	
<b>Type / Model</b>	<b>REF. NO.</b>	<b>SEM NO.</b>	
345K	4072000670	<b>9469</b>	
		<b>Description</b>	
		Pulley	
<b>Type / Model</b>	<b>REF. NO.</b>	<b>SEM NO.</b>	
Axor 457	0005501633 0005500833	<b>9470</b>	
		<b>Description</b>	
		Pulley	
			d=Ø10 D=Ø80 h=48
<b>Type / Model</b>	<b>REF. NO.</b>	<b>SEM NO.</b>	
Axor 457	4572001070	<b>9471</b>	
		<b>Description</b>	
		Pulley	
			d=Ø20 D=Ø64 h=38
<b>Type / Model</b>	<b>REF. NO.</b>	<b>SEM NO.</b>	
Axor	9062002070S	<b>9472</b>	
		<b>Description</b>	
		Pulley	







	<table border="1"> <thead> <tr> <th>SEM NO.</th> <th>REF. NO.</th> <th>Type / Model</th> </tr> </thead> <tbody> <tr> <td>9473</td> <td>4572001470S</td> <td>Axor</td> </tr> </tbody> </table>	SEM NO.	REF. NO.	Type / Model	9473	4572001470S	Axor	<table border="1"> <thead> <tr> <th>Type / Model</th> </tr> </thead> <tbody> <tr> <td>Axor</td> </tr> </tbody> </table>	Type / Model	Axor
SEM NO.	REF. NO.	Type / Model								
9473	4572001470S	Axor								
Type / Model										
Axor										
<p><b>Description</b> Pulley</p>										
	<table border="1"> <thead> <tr> <th>SEM NO.</th> <th>REF. NO.</th> <th>Type / Model</th> </tr> </thead> <tbody> <tr> <td>9474</td> <td>4572003170S</td> <td>Axor</td> </tr> </tbody> </table>	SEM NO.	REF. NO.	Type / Model	9474	4572003170S	Axor	<table border="1"> <thead> <tr> <th>Type / Model</th> </tr> </thead> <tbody> <tr> <td>Axor</td> </tr> </tbody> </table>	Type / Model	Axor
SEM NO.	REF. NO.	Type / Model								
9474	4572003170S	Axor								
Type / Model										
Axor										
<p><b>Description</b> Pulley</p>										
	<table border="1"> <thead> <tr> <th>SEM NO.</th> <th>REF. NO.</th> <th>Type / Model</th> </tr> </thead> <tbody> <tr> <td>9475</td> <td>4572001970S</td> <td>Axor</td> </tr> </tbody> </table>	SEM NO.	REF. NO.	Type / Model	9475	4572001970S	Axor	<table border="1"> <thead> <tr> <th>Type / Model</th> </tr> </thead> <tbody> <tr> <td>Axor</td> </tr> </tbody> </table>	Type / Model	Axor
SEM NO.	REF. NO.	Type / Model								
9475	4572001970S	Axor								
Type / Model										
Axor										
<p><b>Description</b> Pulley</p>										
	<table border="1"> <thead> <tr> <th>SEM NO.</th> <th>REF. NO.</th> <th>Type / Model</th> </tr> </thead> <tbody> <tr> <td>9476</td> <td>4572003070S</td> <td>Axor</td> </tr> </tbody> </table>	SEM NO.	REF. NO.	Type / Model	9476	4572003070S	Axor	<table border="1"> <thead> <tr> <th>Type / Model</th> </tr> </thead> <tbody> <tr> <td>Axor</td> </tr> </tbody> </table>	Type / Model	Axor
SEM NO.	REF. NO.	Type / Model								
9476	4572003070S	Axor								
Type / Model										
Axor										
<p><b>Description</b> Pulley</p>										
<p>d=Ø17 D=Ø82 h=34</p>										
	<table border="1"> <thead> <tr> <th>SEM NO.</th> <th>REF. NO.</th> <th>Type / Model</th> </tr> </thead> <tbody> <tr> <td>9477</td> <td>0011552115</td> <td>Axor</td> </tr> </tbody> </table>	SEM NO.	REF. NO.	Type / Model	9477	0011552115	Axor	<table border="1"> <thead> <tr> <th>Type / Model</th> </tr> </thead> <tbody> <tr> <td>Axor</td> </tr> </tbody> </table>	Type / Model	Axor
SEM NO.	REF. NO.	Type / Model								
9477	0011552115	Axor								
Type / Model										
Axor										
<p><b>Description</b> Pulley</p>										
	<table border="1"> <thead> <tr> <th>SEM NO.</th> <th>REF. NO.</th> <th>Type / Model</th> </tr> </thead> <tbody> <tr> <td>10002</td> <td>4572020210</td> <td>Axor 457</td> </tr> </tbody> </table>	SEM NO.	REF. NO.	Type / Model	10002	4572020210	Axor 457	<table border="1"> <thead> <tr> <th>Type / Model</th> </tr> </thead> <tbody> <tr> <td>Axor 457</td> </tr> </tbody> </table>	Type / Model	Axor 457
SEM NO.	REF. NO.	Type / Model								
10002	4572020210	Axor 457								
Type / Model										
Axor 457										
<p><b>Description</b> Pulley</p>										







Type / Model	REF. NO.	SEM NO.	
Axor	4572002070	10003	 <b>Description</b> Guide Pulley - Welded 6304 NSK - FAG C3 Bearing h = 37 mm Q = 75 mm
Axor	9062005970	10004	 <b>Description</b> Guide Pulley - Welded NSK - FAG Bearing h = 33 mm Q = 75 mm
Axor 457	0011554615	10006	 <b>Description</b> Pulley 9 Canal
Axor 906	9061551715	10781	 <b>Description</b> Pulley 9 Canal D= Ø62 h= Ø41
Axor	4572004370S	11349	 <b>Description</b> Guide Pulley / Welded Seal With Thrust Ring And Boat Q = 78 mm h = 42 mm
25.21	6175050186	046	 <b>Description</b> Rubber Strip

	SEM NO.	REF. NO.	Type / Model
	047	6205050086	30.31
	<b>Description</b> Rubber Strip		
	058	6565050286	
	<b>Description</b> Rubber Strip		



Type / Model	REF. NO.	SEM NO.	
ACTROS	9415010382	8412	 <p><b>Description</b> Radiator Upper Hose</p> <p>d=Ø65 d=Ø65 h=740</p>
ACTROS	9405061235 3755060035	8413	 <p><b>Description</b> Radiator Upper Hose</p> <p>d=Ø19 d=Ø19 h=450</p>
ACTROS	9405061835	8414	 <p><b>Description</b> Radiator Upper Hose</p> <p>d=Ø20 d=Ø22 h=340</p>
ACTROS	9405281282	8415	 <p><b>Description</b> Oil Hose (NBR)</p> <p>d=Ø28 d=Ø28 h=280</p>
ACTROS	9415010582	8434	 <p><b>Description</b> Radiator Hose</p> <p>d=Ø63 d=Ø63 h=240</p>
TRAVEGO	0005015182	8435	 <p><b>Description</b> Radiator Hose</p> <p>d=Ø10 d=Ø10 h=850</p>

	SEM NO.	REF. NO.	Type / Model
 <p>d=Ø16 d=Ø21 h=850</p>	8436	0005013682	TRAVEGO
<b>Description</b>			
Radiator Hose			
	SEM NO.	REF. NO.	Type / Model
 <p>d=Ø12 d=Ø12 h=900</p>	8437	0005015282	TRAVEGO
<b>Description</b>			
Radiator Hose			
	SEM NO.	REF. NO.	Type / Model
 <p>d=Ø60 d=Ø65 h=190</p>	8438	0015012282	TRAVEGO
<b>Description</b>			
Radiator Hose			
	SEM NO.	REF. NO.	Type / Model
 <p>d=Ø70 d=Ø70 h=220</p>	8439	0005015982	TRAVEGO
<b>Description</b>			
Radiator Hose			
	SEM NO.	REF. NO.	Type / Model
 <p>d=Ø70 d=Ø70 h=180</p>	8440	0005015882	TRAVEGO
<b>Description</b>			
Radiator Hose			
	SEM NO.	REF. NO.	Type / Model
 <p>d=Ø37 d=Ø37 h=100</p>	8441	0005015482	TRAVEGO
<b>Description</b>			
Radiator Hose			

Type / Model	REF. NO.	SEM NO.	
TRAVEGO	0005015582	8442	 <p><b>Description</b> Radiator Hose</p> <p>d=Ø50 d=Ø50 h=100</p>
ACTROS	9425010682	8507	 <p><b>Description</b> Radiator Hose</p> <p>28x28x335</p>
ACTROS	9425063135	8508	 <p><b>Description</b> Radiator Hose</p> <p>22x22x250</p>
SPRINTER	9015284782 9015283582	8538	 <p><b>Description</b> Radiator Hose</p> <p>65x65x820</p>
SPRINTER	9015284382	8539	 <p><b>Description</b> Radiator Hose</p> <p>50x60x380</p>
TRAVEGO	0009872037 0009871437	8541	 <p><b>Description</b> Radiator Hose</p> <p>49x49x165</p>

	SEM NO.	REF. NO.	Type / Model
	8542	0015013782 0015012482	TRAVEGO
	<b>Description</b> Radiator Hose		
60x65x120			







	SEM NO.	REF. NO.	Type / Model
	8543	6285014482	TRAVEGO
	<b>Description</b> Radiator Hose		
60x60x290			

	SEM NO.	REF. NO.	Type / Model
	8544	9405280882	AXOR
	<b>Description</b> Oil Filler Pipe		
32x35x490			

	SEM NO.	REF. NO.	Type / Model
	8545	9405011282	AXOR
	<b>Description</b> Heating Hose		
28x28x220			

	SEM NO.	REF. NO.	Type / Model
	8546	9405011582	AXOR
	<b>Description</b> Upper Hose		
60x70x480			

	SEM NO.	REF. NO.	Type / Model
	8547	9015011882	SPRINTER
	<b>Description</b> Radiator Lower Hose		
42x42x290			

Type / Model	REF. NO.	SEM NO.	
SPRINTER	9015011182	8548	 <b>Description</b> Heating Hose 42x42x380
SPRINTER	9015282282	8549	 <b>Description</b> Heating Hose 60x65x610
SPRINTER	9015281882	8550	 <b>Description</b> Heating Hose 50x65x620
SPRINTER	9015011582	8551	 <b>Description</b> Radiator Hose 42x42x440
AXOR	9405061735	8552	 <b>Description</b> Radiator Hose 18x18x590
AXOR	9405011482	8553	 <b>Description</b> Radiator Hose 60x60x265

	SEM NO.	REF. NO.	Type / Model
	8554	9405011682 9405012882	AXOR
	<b>Description</b> Radiator Hose		
12x12x200			







	SEM NO.	REF. NO.	Type / Model
	8555	9405011782	AXOR
	<b>Description</b> Radiator Hose		
12x12x500			

	SEM NO.	REF. NO.	Type / Model
	8556	9405061635	AXOR
	<b>Description</b> Radiator Hose		
18x20x560			

	SEM NO.	REF. NO.	Type / Model
	8557	9405061335 9405011535 9405062935	AXOR
	<b>Description</b> Radiator Hose		
18x20x410			

	SEM NO.	REF. NO.	Type / Model
	8558	3755010582 9405010982	AXOR
	<b>Description</b> Radiator Lower Hose		
50x50x560			

	SEM NO.	REF. NO.	Type / Model
	8559	9405010782 3755010482	AXOR
	<b>Description</b> Radiator Upper Hose		
50x50x420			

Type / Model	REF. NO.	SEM NO.	
ACTROS	9424660281 9424660381	8560	 <b>Description</b> Nbr / Oil Tank Hose 22x22x450
ACTROS	9425064135	8561	
			 <b>Description</b> Heating Hose 18x18x285
ACTROS	9425061035	8562	 <b>Description</b> Radiator Hose 10x10x340
ACTROS	9425063635 9425063535 9425061635	8563	 <b>Description</b> Heating Water Hose 18x22x585
AXOR	9405011882	8564	 <b>Description</b> Radiator Hose 28x28x380
AXOR	6205280282 6205010182	8565	 <b>Description</b> Oil Hose 38x38x330



	SEM NO.	REF. NO.	Type / Model
 Description WaterPump Hose 50x50x680	8566	9705010082 9585012382 9705012482	AXOR







	SEM NO.	REF. NO.	Type / Model
 Description Water Hose 21x21x400	8567	9705010882	ATEGO

	SEM NO.	REF. NO.	Type / Model
 Description Radiator Hose 21x29x820	8568	9705010282 9585012582	ATEGO

	SEM NO.	REF. NO.	Type / Model
 Description Radiator Hose 22x28x520	8569	9735010282 9585011282	ATEGO

	SEM NO.	REF. NO.	Type / Model
 Description Radiator Hose 60x60x400	9525	6285010782	TRAVEGO

	SEM NO.	REF. NO.	Type / Model
 Description Radiator Hose 58x65x205	9526	0015012382	TRAVEGO

Type / Model	REF. NO.	SEM NO.	
TRAVEGO Connecto	6285010982	9527	
			<b>Description</b> Radiator Hose 59x59x318
Type / Model	REF. NO.	SEM NO.	
TRAVEGO	18321323	9528	
			<b>Description</b> Radiator Hose 38x38x370
Type / Model	REF. NO.	SEM NO.	
TRAVEGO	18321223	9529	
			<b>Description</b> Radiator Hose 38x38x135
Type / Model	REF. NO.	SEM NO.	
TRAVEGO	0015013982	9530	
			<b>Description</b> Radiator Hose 60x65x260
Type / Model	REF. NO.	SEM NO.	
Euro 3 Euro 4	6254660281	9531	
			<b>Description</b> Oil Hose 15x15x260
Type / Model	REF. NO.	SEM NO.	
Euro 3 Euro 4	3834660181	9532	
			<b>Description</b> Oil Hose 15x18x166

SEM NO.	REF. NO.	Type / Model
9533	9015012782	Sprinter 408CDI 411CDI 413CDI
<b>Description</b>		
Radiator Hose		
38x42x8		



SEM NO.	REF. NO.	Type / Model
9534	9015012682	Sprinter 408CDI 411CDI 413CDI
<b>Description</b>		
Radiator Hose		
36x40x14		



SEM NO.	REF. NO.	Type / Model
9535	9425281282 9425280582	ACTROS
<b>Description</b>		
Oil Hose		
38x38x700		



SEM NO.	REF. NO.	Type / Model
9536	9405000475	ACTROS
<b>Description</b>		
Heating Hose		
18x18x12x450		















SEM NO.	REF. NO.	Type / Model
9537	9405063735	ACTROS
<b>Description</b>		
Heating Hose		
22x18x455		









SEM NO.	REF. NO.	Type / Model
9538	9405063635	ACTROS
<b>Description</b>		
Heating Hose		
18x18x580		



Type / Model	REF. NO.	SEM NO.	
ACTROS	9405000175	9539	 <p><b>Description</b> Heating Hose</p> <p>57x50x485</p>
ACTROS	9424660181 9424660481 9424660081	9540	 <p><b>Description</b> Oil Hose</p> <p>15x15x320</p>
ACTROS	9405012182	9541	 <p><b>Description</b> Radiator Hose</p> <p>49x39x380</p>
ACTROS	9405012282	9542	 <p><b>Description</b> Radiator Hose</p> <p>22x25x225</p>
1720 1820	6555060535 6555060635 6555060235	9543	 <p><b>Description</b> Heating Hose</p> <p>18x18x460</p>
1636 1633	6205011882	9544	 <p><b>Description</b> Heating Hose</p> <p>27x27x310</p>

	<b>SEM NO.</b>	<b>REF. NO.</b>	<b>Type / Model</b>
	9545	6555060035	2629 3535
<b>Description</b>			
Radiator Hose			
18x18x365			
	<b>SEM NO.</b>	<b>REF. NO.</b>	<b>Type / Model</b>
	9546	4410180012	3031
<b>Description</b>			
Breather Hose			
28x28x310			
	<b>SEM NO.</b>	<b>REF. NO.</b>	<b>Type / Model</b>
	9547	3875011682	2635 2628
<b>Description</b>			
Radiator Hose			
15x15x212			
	<b>SEM NO.</b>	<b>REF. NO.</b>	<b>Type / Model</b>
	9548	5410180812	501LA
<b>Description</b>			
Breather Hose			
25x25x510			
	<b>SEM NO.</b>	<b>REF. NO.</b>	<b>Type / Model</b>
	9549	3754660081	3235K 3243K
<b>Description</b>			
Oil Hose			
22x22x295			
	<b>SEM NO.</b>	<b>REF. NO.</b>	<b>Type / Model</b>
	9550	6254660381	3238 3244 3250
<b>Description</b>			
Oil Hose			
22x22x450			

Type / Model	REF. NO.	ŞEM NO.	
1823L 2628L	6585010082	9551	 <p><b>Description</b> Radiator Hose</p> <p>32x28x175</p>
1622	6165011182	9552	 <p><b>Description</b> Radiator Hose</p> <p>49x67x785</p>
ATEGO	9705011282 9705010182	9553	 <p><b>Description</b> Radiator Hose</p> <p>55x55x1210</p>
ATEGO 1315 1418 1518	9705010482	9554	 <p><b>Description</b> Heating Hose</p> <p>17x21x200</p>
ATEGO 1718 1723 2425	9705012080	9555	 <p><b>Description</b> Radiator Hose</p> <p>49x49 17x20</p>
ATEGO 1718 1723	9738300096	9556	 <p><b>Description</b> Heating Hose</p> <p>20x21x460 20x21x175</p>

	ŞEM NO.	REF. NO.	Type / Model
	9557	3575011082	O 405
	<b>Description</b>		
	Radiator Hose		
50x60x245			

	ŞEM NO.	REF. NO.	Type / Model
	9567	6205012982	2638 3338
	<b>Description</b>		
	Radiator Hose		
64x66x765			







	ŞEM NO.	REF. NO.	Type / Model
	9568	9735010082	ATEGO 1718 1723
	<b>Description</b>		
	Radiator Hose		
49x49x620			

	ŞEM NO.	REF. NO.	Type / Model
	9569	9735010182	ATEGO 1315 1214 1224
	<b>Description</b>		
	Radiator Hose		
49x49x1000			

	ŞEM NO.	REF. NO.	Type / Model
	9639	3875012982 3875010782	2628 3328 3528
	<b>Description</b>		
	Radiator Hose		
65x60x350			

	ŞEM NO.	REF. NO.	Type / Model
	9640	3875011582	2032 2026 2226L
	<b>Description</b>		
	Radiator Hose		
65x65x510			



Type / Model	REF. NO.	SEM NO.	
2628 3328 1616	3875010982	9641	 <b>Description</b> Radiator Hose 65x65x500
Type / Model	REF. NO.	SEM NO.	
2032 2026 2232	3875012882 3875011382	9642	 <b>Description</b> Radiator Hose 28x32x400
Type / Model	REF. NO.	SEM NO.	
3335 3229 3538	3875011082	9643	 <b>Description</b> Radiator Hose 32x28x290
Type / Model	REF. NO.	SEM NO.	
2628 2228 1932	3875011782 3875011182	9644	 <b>Description</b> Radiator Hose 28x28x250
Type / Model	REF. NO.	SEM NO.	
2628S	6205060035	9645	 <b>Description</b> Radiator Hose 18x18x260
Type / Model	REF. NO.	SEM NO.	
1628 2235	6205060235	9646	 <b>Description</b> Radiator Hose 18x18x525

	SEM NO.	REF. NO.	Type / Model
	9647	3875060135	1628 2428
	<b>Description</b> Heating Hose		
18x18x235			







	SEM NO.	REF. NO.	Type / Model
	9648	6175012782	3028 3228
	<b>Description</b> Radiator Hose		
28x32x460			







	SEM NO.	REF. NO.	Type / Model
	9649	6205010382 6205013682	2628
	<b>Description</b> Radiator Hose		
65x65x250			







	SEM NO.	REF. NO.	Type / Model
	9650	6205010482	1835 1843 3344
	<b>Description</b> Radiator Hose		
60x65x300			







	SEM NO.	REF. NO.	Type / Model
	9651	6555014982 6555011282	1935 1938 3031
	<b>Description</b> Radiator Hose		
63x63x280			





	SEM NO.	REF. NO.	Type / Model
	9652	6205011082	2628
	<b>Description</b> Radiator Hose		
65x65x450			

Type / Model	REF. NO.	SEM NO.	
1928 2528 1935	3875010582	9653	 <b>Description</b> Radiator Hose 60x65x490
Type / Model	REF. NO.	SEM NO.	
2544	6205013782	9654	 <b>Description</b> Radiator Hose 64x64x370
Type / Model	REF. NO.	SEM NO.	
2628	6205012082	9655	 <b>Description</b> Radiator Hose 28x32x420
Type / Model	REF. NO.	SEM NO.	
2024 3235 1935	6555011082 6555014082	9656	 <b>Description</b> Radiator Hose 65x65x450
Type / Model	REF. NO.	SEM NO.	
2426 2551 2422	6555011482	9657	 <b>Description</b> Radiator Hose 15x15x440
Type / Model	REF. NO.	SEM NO.	
3031	6525012082	9658	 <b>Description</b> Radiator Hose 65x60x580

 28x32x500	<b>ŞEM NO.</b> 9659	<b>REF. NO.</b> 6525012282 6565011482	<b>Type / Model</b> 3031
	<b>Description</b> Radiator Hose		
 18x18x550	<b>ŞEM NO.</b> 9660	<b>REF. NO.</b> 6205062035	<b>Type / Model</b> 1928S 1935S
	<b>Description</b> Heating Hose		
 38x38x560	<b>ŞEM NO.</b> 9661	<b>REF. NO.</b> 9425280682	<b>Type / Model</b> ACTROS 1831 1840
	<b>Description</b> Oil Hose		
 55x39x310	<b>ŞEM NO.</b> 9662	<b>REF. NO.</b> 9405000075	<b>Type / Model</b> ACTROS 1823 1833
	<b>Description</b> Radiator Hose		
 37x34x440	<b>ŞEM NO.</b> 9663	<b>REF. NO.</b> 9065010182 9065012982 9065010582 9065012682	<b>Type / Model</b> Sprinter 209CDI 211CDI 218CDI
	<b>Description</b> Radiator Hose		
 18x18x272	<b>ŞEM NO.</b> 9664	<b>REF. NO.</b> 9068322223	<b>Type / Model</b> Sprinter 209CDI 211CDI 218CDI
	<b>Description</b> Heating Hose		

Type / Model	REF. NO.	SEM NO.	
Sprinter 209CDI 211CDI 218CDI	9065010682	9665	 <b>Description</b> Radiator Hose 19x24x255
Sprinter 209CDI 211CDI 218CDI	9065010782	9666	 <b>Description</b> Radiator Upper Hose 10x10x165
Sprinter 209CDI 211CDI 218CDI	9065010882 9065013182 9065012382 9065013882	9667	 <b>Description</b> Radiator Hose 10x8x750
Sprinter 616CDI	9018322823	9668	 <b>Description</b> Return Hose 18x21x690
Sprinter 616CDI	9018324223	9669	 <b>Description</b> Heating Hose 18x18x280
Sprinter 616CDI	9018323623	9670	 <b>Description</b> Heating Hose 18x18x300

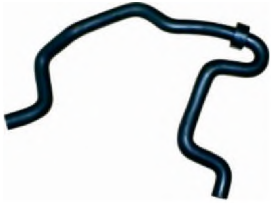
	<b>SEM NO.</b>	<b>REF. NO.</b>	<b>Type / Model</b>
	9671	9018324723	Sprinter 616 CDI
<b>Description</b>			
Heating Hose			
18x20x408			
	<b>SEM NO.</b>	<b>REF. NO.</b>	<b>Type / Model</b>
	9672	9018324323	Sprinter 311CDI 313CDI
<b>Description</b>			
Return Hose			
18x21x550			
	<b>SEM NO.</b>	<b>REF. NO.</b>	<b>Type / Model</b>
	9673	9018324923	Sprinter 616 CDI
<b>Description</b>			
Heating Hose			
18x21x537			
	<b>SEM NO.</b>	<b>REF. NO.</b>	<b>Type / Model</b>
	9674	9018324823	Sprinter 616 CDI
<b>Description</b>			
Heating Hose			
18x20x235			
	<b>SEM NO.</b>	<b>REF. NO.</b>	<b>Type / Model</b>
	9675	9018325823 9018325623 9018327123	Sprinter 208CDI 211CDI
<b>Description</b>			
Heating Hose			
18x15x110			
	<b>SEM NO.</b>	<b>REF. NO.</b>	<b>Type / Model</b>
	9676	9018325523 9018327923	Sprinter 311CDI 308CDI
<b>Description</b>			
Heating Hose			
15x18x160			

Type / Model	REF. NO.	SEM NO.	
ACTROS	9425062135	9677	 <p><b>Description</b> Radiator Hose</p> <p>18x18x500</p>
ACTROS	9425062035	9678	 <p><b>Description</b> Radiator Hose</p> <p>18x18x650</p>
ACTROS	9418300196	9679	 <p><b>Description</b> Return Hose</p> <p>18x18x105</p>
ACTROS	9418300096	9680	 <p><b>Description</b> Heating Hose</p> <p>18x18x117</p>
3244 3250	3635060235 3875060535	9681	 <p><b>Description</b> Radiator Hose</p> <p>18x18x525</p>
2524	3835060035	9682	 <p><b>Description</b> Heating Hose</p> <p>18x23x420</p>



	SEM NO.	REF. NO.	Type / Model
 18x18x185	9683	6205060335	1926LS 1932LS
	<b>Description</b> Expansion Tank Hose		







	SEM NO.	REF. NO.	Type / Model
 12x12x212	9684	3875011482	1920 1920 1921 1920
	<b>Description</b> Heating Hose		







	SEM NO.	REF. NO.	Type / Model
 16x24x240	9685	6112030582	OM 647LA
	<b>Description</b> Radiator Hose		



	SEM NO.	REF. NO.	Type / Model
 18x23x250	9686	6012030482	OM 601
	<b>Description</b> Thermostat Hose		

	SEM NO.	REF. NO.	Type / Model
 18x18x455	9687	9065012182 9065013782 9065013382	209CDI 211CDI 215CD
	<b>Description</b> Heating Hose		

	SEM NO.	REF. NO.	Type / Model
 28x32x470	9688	6555010482	1929L 2429L
	<b>Description</b> Heating Hose		

Type / Model	REF. NO.	SEM NO.	
2225B 3025	6175010082	9689	 <b>Description</b> Thermostat Hose 64x67x475
1724AK	6175014982	9690	 <b>Description</b> Thermostat Hose 67x64x535
1638 2238	6205010682 6205010982	9691	 <b>Description</b> Radiator Hose 64x64x370
2524	6205012882	9692	 <b>Description</b> Radiator Hose 9x15x208
1938 2438L	6205013082	9693	 <b>Description</b> Heating Hose 28x32x682
2044	6565012082 6525015282 6565012182	10556	 <b>Description</b> Expansion Tank Hose 28x28x305

	<b>SEM NO.</b>	<b>REF. NO.</b>	<b>Type / Model</b>
	10557	6565010382	1827
<b>Description</b>			
Heating Hose			
10x10x230			
	<b>SEM NO.</b>	<b>REF. NO.</b>	<b>Type / Model</b>
	10558	6555012082	2448 2550
<b>Description</b>			
Expansion Tank Hose			
16x16x400			
	<b>SEM NO.</b>	<b>REF. NO.</b>	<b>Type / Model</b>
	10559	6525012382	2524 2527 2531
<b>Description</b>			
Expansion Tank Hose			
15x15x330			
	<b>SEM NO.</b>	<b>REF. NO.</b>	<b>Type / Model</b>
	10560	9405063035	3344 4140
<b>Description</b>			
Radiator Hose			
18x18x500			
	<b>SEM NO.</b>	<b>REF. NO.</b>	<b>Type / Model</b>
	10561	9015012582	SPRINTER 208CDI
<b>Description</b>			
Water Hose			
15x28x295			
	<b>SEM NO.</b>	<b>REF. NO.</b>	<b>Type / Model</b>
	10562	9015013182	SPRINTER 308CDI 311 CDI
<b>Description</b>			
Water Hose			
37x43x250			

Type / Model	REF. NO.	SEM NO.	
SPRINTER 308CDI 311CDI	9015013082	10563	 <b>Description</b> Water Hose 14x14x220
SPRINTER 209CDI 211CDI 218CDI	9065283382	10564	
SPRINTER 209CDI 211CDI 218CDI	9065280182	10565	 <b>Description</b> Turbocharger Hose 57x66x300
SPRINTER 616CDI	9018320123	10566	
SPRINTER 208CDI 211CDI 213CDI	9018325923 9018326723 9018323423 9018325123	10567	 <b>Description</b> Recirculating Hose 18x20x340
SPRINTER 308CDI 311CDI 313CDI 316CDI	9018326123 9018324123	10568	

	SEM NO.	REF. NO.	Type / Model
	<b>10569</b>	9018326023	SPRINTER
		9018324623	208CDI 211CDI 213CDI
	<b>Description</b>		
	Recirculating Hose		
18x18x267			







	SEM NO.	REF. NO.	Type / Model
	<b>10570</b>	9018323723	SPRINTER
			408 CDI 411 CDI 413 CDI
	<b>Description</b>		
	Heating Hose		
18x15x230			

	SEM NO.	REF. NO.	Type / Model
	<b>10571</b>	9018323923	SPRINTER
		9018327823	408 CDI 411 CDI 413 CDI
	<b>Description</b>		
	Heating Hose		
15x18x320			

	SEM NO.	REF. NO.	Type / Model
	<b>10572</b>	9418300396	ACTROS
	<b>Description</b>		
	Heating Hose		
18x18x900			

	SEM NO.	REF. NO.	Type / Model
	<b>10573</b>	9418300296	ACTROS
	<b>Description</b>		
	Heating Hose		
18x18x1200			

	SEM NO.	REF. NO.	Type / Model
	<b>11060</b>	6010940782	SPRINTER
		6010940982	207D 208D
	<b>Description</b>		
	Air Hose		
55x60x605			

Type / Model	REF. NO.	SEM NO.	
Vito 639	6460980083 6460980283	11061	 <p><b>Description</b> Hose on Mixing Chamber</p> <p>57x67x157</p>
1921	3465015982	11062	 <p><b>Description</b> Radiator Hose</p> <p>11x8x400</p>
1921	3465015382	11063	 <p><b>Description</b> Radiator Hose</p> <p>15x15x360</p>
2448 2550 3248	6555013082 6555011882	11064	 <p><b>Description</b> Cooling Water Hose</p> <p>33x28x570</p>
OM 646	6462030282	11065	 <p><b>Description</b> Water Pump Hose</p> <p>18x24x235</p>
1016 1024	9745011282 9745010782	11066	 <p><b>Description</b> Cooling Water Hose</p> <p>18x21x860</p>

	ŞEM NO.	REF. NO.	Type / Model
	11067	9705011682	1315
		9585012482	1418
<b>Description</b>			
Radiator Hose			
50x50x285			

	ŞEM NO.	REF. NO.	Type / Model
	11068	9405000275	1933
			2533
<b>Description</b>			
Radiator Hose			
12x180			







	ŞEM NO.	REF. NO.	Type / Model
	11069	6565010782	2544
		6555014682	
		6565011982	
<b>Description</b>			
Radiator Hose			
33x28x570			







	ŞEM NO.	REF. NO.	Type / Model
	11070	9705011782	1215
		9705011382	1517
<b>Description</b>			
Radiator Hose			
12x20x982			









	ŞEM NO.	REF. NO.	Type / Model
	11071	9705012582	1016
		9705012682	1024
		9735011282	
<b>Description</b>			
Radiator Hose			
50x50x18			







	ŞEM NO.	REF. NO.	Type / Model
	11072	6625000075	1017
			1024
<b>Description</b>			
Radiator Hose			
21x50x22x48			



Type / Model	REF. NO.	SEM NO.	
208CDI 211CDI	9018323823	11073	 <b>Description</b> Heating Hose 18x15x293
1720 1920	6205062935	11074	 <b>Description</b> Heating Hose 18x18x230
1644LS 2244LS	6205280582 6205280482	11075	 <b>Description</b> Oil Hose 38x38x930
1625S	4020180482	11076	 <b>Description</b> Oil Hose 35x40x330
1016 1023	9735010382	11077	 <b>Description</b> Radiator Hose
OM 602 DE LA	6012030682	11078	 <b>Description</b> Cooling Water Hose 15x18x340

	<table border="1"> <thead> <tr> <th>SEM NO.</th> <th>REF. NO.</th> <th>Type / Model</th> </tr> </thead> <tbody> <tr> <td>11584</td> <td>9305060235</td> <td></td> </tr> </tbody> </table>	SEM NO.	REF. NO.	Type / Model	11584	9305060235		<p><b>Description</b> Heating Hose</p>	
SEM NO.	REF. NO.	Type / Model							
11584	9305060235								
	<table border="1"> <thead> <tr> <th>SEM NO.</th> <th>REF. NO.</th> <th>Type / Model</th> </tr> </thead> <tbody> <tr> <td>11711</td> <td>9438300096</td> <td>ACTROS</td> </tr> </tbody> </table>	SEM NO.	REF. NO.	Type / Model	11711	9438300096	ACTROS	<p><b>Description</b> Return Hose</p>	
SEM NO.	REF. NO.	Type / Model							
11711	9438300096	ACTROS							
18x18x520		<table border="1"> <thead> <tr> <th>SEM NO.</th> <th>REF. NO.</th> <th>Type / Model</th> </tr> </thead> <tbody> <tr> <td>11712</td> <td>9418320423</td> <td>ACTROS</td> </tr> </tbody> </table>	SEM NO.	REF. NO.	Type / Model	11712	9418320423	ACTROS	<p><b>Description</b> Return Hose</p>
SEM NO.	REF. NO.	Type / Model							
11712	9418320423	ACTROS							
18x18x325		<table border="1"> <thead> <tr> <th>SEM NO.</th> <th>REF. NO.</th> <th>Type / Model</th> </tr> </thead> <tbody> <tr> <td>11713</td> <td>9418320123</td> <td>ACTROS</td> </tr> </tbody> </table>	SEM NO.	REF. NO.	Type / Model	11713	9418320123	ACTROS	<p><b>Description</b> Return Hose</p>
SEM NO.	REF. NO.	Type / Model							
11713	9418320123	ACTROS							
18x18x350		<table border="1"> <thead> <tr> <th>SEM NO.</th> <th>REF. NO.</th> <th>Type / Model</th> </tr> </thead> <tbody> <tr> <td>11714</td> <td>9418320323</td> <td>ACTROS</td> </tr> </tbody> </table>	SEM NO.	REF. NO.	Type / Model	11714	9418320323	ACTROS	<p><b>Description</b> Heating Hose</p>
SEM NO.	REF. NO.	Type / Model							
11714	9418320323	ACTROS							
18x18x156		<table border="1"> <thead> <tr> <th>SEM NO.</th> <th>REF. NO.</th> <th>Type / Model</th> </tr> </thead> <tbody> <tr> <td>11715</td> <td>9438300196</td> <td>ACTROS</td> </tr> </tbody> </table>	SEM NO.	REF. NO.	Type / Model	11715	9438300196	ACTROS	<p><b>Description</b> Heating Hose</p>
SEM NO.	REF. NO.	Type / Model							
11715	9438300196	ACTROS							
18x18x235									

Type / Model	REF. NO.	SEM NO.	
ACTROS	9418320223	11716	 <p><b>Description</b> Heating Hose</p> <p>18x18x235</p>
ACTROS	9418320523	11717	 <p><b>Description</b> Heating Hose</p> <p>18x18x260</p>
1831 1848	9305010082	11718	 <p><b>Description</b> Heating Hose</p> <p>9x9x1650</p>
Type / Model	REF. NO.	SEM NO.	
	4411340882	11847	  <p><b>Description</b> Air Intake Hose</p> <p>30x35x525</p>
Type / Model	REF. NO.	SEM NO.	
	4421341282	11848	  <p><b>Description</b> Air Intake Hose</p> <p>30x35x315</p>
Type / Model	REF. NO.	SEM NO.	
	4031340482	11849	  <p><b>Description</b> Compressor Air Intake Hose</p> <p>22x32x145</p>

	SEM NO.		REF. NO.	Type / Model
 32x30x200 <b>Description</b> Compressor Air Intake Hose	11850		4421340582	
 22x32x390 <b>Description</b> Compressor Air Intake Hose	11851		4031340282	
 64x68x530 <b>Description</b> Radiator Hose	11852		6555015582	
 28x50x42 <b>Description</b> Radiator Hose	11853		6175013482	
 68x64x525 <b>Description</b> Radiator Hose	11854		6555015282	
 64x64x290 <b>Description</b> Radiator Hose	11855		6555011182	

<b>Type / Model</b>	<b>REF. NO.</b>		<b>SEM NO.</b>	
	6555015882		<b>11856</b>	
			<b>Description</b>	
			Radiator Hose	
				64x64x330
<b>Type / Model</b>	<b>REF. NO.</b>		<b>SEM NO.</b>	
	6565060635		<b>11857</b>	
			<b>Description</b>	
			Heating Hose	
				18x18x327
<b>Type / Model</b>	<b>REF. NO.</b>		<b>SEM NO.</b>	
	6555011382		<b>11858</b>	
			<b>Description</b>	
			Radiator Hose	
				64x64x307
<b>Type / Model</b>	<b>REF. NO.</b>		<b>SEM NO.</b>	
	3875060235		<b>11859</b>	
			<b>Description</b>	
			Radiator Hose	
				18x18x310
<b>Type / Model</b>	<b>REF. NO.</b>		<b>SEM NO.</b>	
	6555013382		<b>11860</b>	
			<b>Description</b>	
			Heating Hose	
				28x28x290
<b>Type / Model</b>	<b>REF. NO.</b>		<b>SEM NO.</b>	
	6565011882		<b>11861</b>	
			<b>Description</b>	
			Heating Hose	
				33x28x167

SEM NO.	REF. NO.	Type / Model
11862	6555060335	
 <p><b>Description</b> Heating Hose</p>		
18x18x335		













SEM NO.	REF. NO.	Type / Model
11863	6525012482	
 <p><b>Description</b> Heating Hose</p>		
18x18x305		

SEM NO.	REF. NO.	Type / Model
11864	6555015382	
 <p><b>Description</b> Expansion Tank Hose</p>		
15x15x350		

SEM NO.	REF. NO.	Type / Model
11865	4355060535	
 <p><b>Description</b> Heating Hose</p>		
33x28x120		

SEM NO.	REF. NO.	Type / Model
11866	9305060135	
 <p><b>Description</b> Radiator Hose</p>		
18x22x575		

SEM NO.	REF. NO.	Type / Model
11867	9305060035	
 <p><b>Description</b> Radiator Hose</p>		
22x18x640		

<b>Type / Model</b>	<b>REF. NO.</b>		<b>SEM NO.</b>	
	9425011582		<b>11868</b>	
			<b>Description</b>	
			Radiator Hose	
				65x65x235
<b>Type / Model</b>	<b>REF. NO.</b>		<b>SEM NO.</b>	
	9405000375		<b>11869</b>	
			<b>Description</b>	
			Radiator Hose	
				18x18x12
<b>Type / Model</b>	<b>REF. NO.</b>		<b>SEM NO.</b>	
	9425061535		<b>11870</b>	
			<b>Description</b>	
			Radiator Hose	
				18x18x175
<b>Type / Model</b>	<b>REF. NO.</b>		<b>SEM NO.</b>	
	9425011682		<b>11871</b>	
			<b>Description</b>	
			Radiator Hose	
				65x65x255
<b>Type / Model</b>	<b>REF. NO.</b>		<b>SEM NO.</b>	
	6505010682		<b>11872</b>	
			<b>Description</b>	
			Radiator Hose	
				65x45x300
<b>Type / Model</b>	<b>REF. NO.</b>		<b>SEM NO.</b>	
	6555013782		<b>11873</b>	
			<b>Description</b>	
			Radiator Hose	
				65x65x365









SEM NO.		REF. NO.	Type / Model
11874		4030181782	
			
<b>Description</b>			
Air Suction Hose			
24x27x585			

SEM NO.		REF. NO.	Type / Model
11875		6175010182	
			
<b>Description</b>			
Radiator Hose			
65x68x590			

SEM NO.		REF. NO.	Type / Model
11876		6555280382	
			
<b>Description</b>			
Oil Hose			
38x38x180			

SEM NO.		REF. NO.	Type / Model
11971		9065281182	
			
<b>Description</b>			
Radiator Hose			
55x60x300			

<b>Type / Model</b>	<b>REF. NO.</b>	<b>ŞEM NO.</b>	
BLACK RED	0249970382	8829	
		<b>Description</b>	
		Silicon Hose	D:Ø100 mm L:190 mm 3 HUMP
<b>Type / Model</b>	<b>REF. NO.</b>	<b>ŞEM NO.</b>	
BLACK RED	0020946382 0010947982 0020945482	8830	
		<b>Description</b>	
		Silicon Hose	D:Ø100 mm L:205 mm 4 HUMP
<b>Type / Model</b>	<b>REF. NO.</b>	<b>ŞEM NO.</b>	
BLACK RED	0005010082	8831	
		<b>Description</b>	
		Silicon Hose	D:Ø83 mm L:200 mm 4 HUMP
<b>Type / Model</b>	<b>REF. NO.</b>	<b>ŞEM NO.</b>	
BLACK RED	0020945582 0020946682 0020940882	8833	
		<b>Description</b>	
		Silicon Hose	D:Ø115 mm L:210 mm 5 HUMP
<b>Type / Model</b>	<b>REF. NO.</b>	<b>ŞEM NO.</b>	
BLACK RED	0020945282 0010947882 0020945982	8835	
		<b>Description</b>	
		Silicon Hose	D:Ø100 mm L:250 mm 6 HUMP
<b>Type / Model</b>	<b>REF. NO.</b>	<b>ŞEM NO.</b>	
BLACK RED	3715018082	8836	
		<b>Description</b>	
		Silicon Hose	D:Ø100 mm L:250 mm 8 HUMP

	SEM NO.	REF. NO.	Type / Model
	8837	3715017982	BLACK
	<b>Description</b> Silicon Hose D:Ø79 mm D:Ø84 mm L:320 mm 8 HUMP		







	SEM NO.	REF. NO.	Type / Model
	8838	0020946982	BLACK RED
	<b>Description</b> Silicon Hose D:Ø100 mm L:100 mm		

	SEM NO.	REF. NO.	Type / Model
	8839	0020947582 0020943782	BLACK RED
	<b>Description</b> Silicon Hose D:Ø80 mm L:155 mm 3 HUMP		

	SEM NO.	REF. NO.	Type / Model
	8840	9415011282 3015010682	RED
	<b>Description</b> Silicon Hose D:Ø50 mm D:Ø55 mm L:98 mm		

	SEM NO.	REF. NO.	Type / Model
	8841	6845011082 0010948582 0020941682	BLACK RED
	<b>Description</b> Silicon Hose D:Ø80 mm D:Ø 85 mm L:215 mm 4 HUMP		

	SEM NO.	REF. NO.	Type / Model
	9037		BLACK RED
	<b>Description</b> Silicon Hose D:Ø15 L:90		

Type / Model	REF. NO.	ŞEM NO.	
BLACK RED	N900271022024 N000000004975	9038	 <p><b>Description</b> Silicon Hose</p> <p>D:Ø22 L:90</p>
BLACK RED	N900271050005	9039	 <p><b>Description</b> Silicon Hose</p> <p>D:Ø50 L:150</p>
BLACK RED	0009970653	10049	 <p><b>Description</b> Silicon Hose</p> <p>d=Ø100 d=Ø115 L=120</p>
BLACK RED	9425010582	10054	 <p><b>Description</b> Silicon Hose</p> <p>d=Ø50 d=Ø60 L=104</p>
BLACK	5419970083	10206	 <p><b>Description</b> Silicon Hose</p> <p>D:Ø105 mm L:70 mm</p>
BLACK	3669970283	10207	 <p><b>Description</b> Silicon Hose</p> <p>D:Ø70 mm L:86 mm</p>

	SEM NO.	REF. NO.	Type / Model
	10208	5429970052	BLACK RED
<b>Description</b>			
Silicon Hose			
D:Ø95 mm L:70 mm			







	SEM NO.	REF. NO.	Type / Model
	10301	0029975452	BLACK RED
<b>Description</b>			
Silicon Hose			
D:Ø110 mm L:162 mm 2 HUMP			

	SEM NO.	REF. NO.	Type / Model
	10302	0029976352	RED
<b>Description</b>			
Silicon Hose			
D:Ø150 mm L:100 mm			

	SEM NO.	REF. NO.	Type / Model
	10303	0020947682	BLACK RED
<b>Description</b>			
Silicon Hose			
D:Ø100 mm L:250 mm 6 HUMP			

	SEM NO.	REF. NO.	Type / Model
	11163	0005019082	BLACK
<b>Description</b>			
Silicon Hose			
Ø70x200 5 hump			

	SEM NO.	REF. NO.	Type / Model
	11164	6965007175	BLACK
<b>Description</b>			
Silicon Hose			
Ø78xØ100x230 4 HUMP			

<b>Type / Model</b>	<b>REF. NO.</b>	<b>SEM NO.</b>	
BLACK RED	9040940582	11165	
			<b>Description</b> Silicon Hose Ø75XØ88X140 2 hump
<b>Type / Model</b>	<b>REF. NO.</b>	<b>SEM NO.</b>	
RED	9040940682 9040940782	11166	
			<b>Description</b> Silicon Hose Ø70X170 3 hump
<b>Type / Model</b>	<b>REF. NO.</b>	<b>SEM NO.</b>	
RED	6965007375 6965007575	11168	
			<b>Description</b> Silicon Hose Ø80XØ85X215 4 hump
<b>Type / Model</b>	<b>REF. NO.</b>	<b>SEM NO.</b>	
RED	0249970882	11169	
			<b>Description</b> Silicon Hose Ø130X170 3 hump
<b>Type / Model</b>	<b>REF. NO.</b>	<b>SEM NO.</b>	
BLACK RED	0249970782	11170	
			<b>Description</b> Silicon Hose Ø100X150 2 hump
<b>Type / Model</b>	<b>REF. NO.</b>	<b>SEM NO.</b>	
BLACK	0020945782	11171	
			<b>Description</b> Silicon Hose Ø115X210 5 hump

	SEM NO.	REF. NO.	Type / Model
	11172	0020946082	BLACK RED
	<b>Description</b>		
	Silicon Hose		
Ø100X235 5 hump			

	SEM NO.	REF. NO.	Type / Model
	11173	0005016082 0015017982	BLACK RED
	<b>Description</b>		
	Silicon Hose		
Ø85X200 4 hump			







	SEM NO.	REF. NO.	Type / Model
	11174	0005010182	BLUE
	<b>Description</b>		
	Silicon Hose		
Ø83X200 4 hump			

	SEM NO.	REF. NO.	Type / Model
	11175	0005016182	BLUE
	<b>Description</b>		
	Silicon Hose		
Ø85X200 4 hump			

	SEM NO.	REF. NO.	Type / Model
	11176	0015018882	BLACK RED
	<b>Description</b>		
	Silicon Hose		
Ø115X100 1 hump			

	SEM NO.	REF. NO.	Type / Model
	11177	0020943482	BLACK RED
	<b>Description</b>		
	Silicon Hose		
Ø100X110			



Type / Model	REF. NO.	ŞEM NO.	
BLACK RED	6285283282	11178	 <b>Description</b> Silicon Hose Ø100X120
BLACK RED	N90027105005	11179	 <b>Description</b> Silicon Hose Ø50X150
BLACK RED	N90027106002	11180	 <b>Description</b> Silicon Hose Ø60X100
GREY	0005010582	11181	 <b>Description</b> Silicon Hose Ø70X120
BLACK RED	0029970852	11182	 <b>Description</b> Silicon Hose Ø115X100
BLACK RED	0029872443	11184	 <b>Description</b> Silicon Hose Ø50X60X135

SEM NO.	REF. NO.	Type / Model
11185	0009872443	GREY
 <p><b>Description</b> Silicon Hose</p>		
Ø50X70X140		







SEM NO.	REF. NO.	Type / Model
11186	0029971152	BLACK RED
 <p><b>Description</b> Silicon Hose</p>		
Ø100XØ115X130		

SEM NO.	REF. NO.	Type / Model
11187	3760947082	RED
 <p><b>Description</b> Silicon Hose</p>		
Ø85x70		

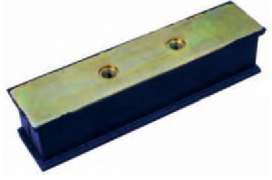
SEM NO.	REF. NO.	Type / Model
11188	3825288082	BLACK RED
 <p><b>Description</b> Silicon Hose</p>		
Ø100X70		

SEM NO.	REF. NO.	Type / Model
11189	3769970083	BLACK
 <p><b>Description</b> Silicon Hose</p>		
Ø100X70		

SEM NO.	REF. NO.	Type / Model
11190	9439972182	RED
 <p><b>Description</b> Silicon Hose</p>		
Ø50x120		

<b>Type / Model</b>	<b>REF. NO.</b>	<b>SEM NO.</b>	
	3875040012	7710	
			<b>Description</b> Rubber Metal Mounting
			A=170 B=40
<b>Type / Model</b>	<b>REF. NO.</b>	<b>SEM NO.</b>	
	3875040112	7732	
			<b>Description</b> Rubber Metal Mounting
			A=170 B=40
<b>Type / Model</b>	<b>REF. NO.</b>	<b>SEM NO.</b>	
	3825040012	8804 (1096)	
			<b>Description</b> Rubber Buffer
<b>Type / Model</b>	<b>REF. NO.</b>	<b>SEM NO.</b>	
	3825040112	8805 (1097)	
			<b>Description</b> Rubber Buffer
<b>Type / Model</b>	<b>REF. NO.</b>	<b>SEM NO.</b>	
	3365040012	9006	
			<b>Description</b> Radiator Mounting
			D=Ø76 d=Ø35 M10x1,5
<b>Type / Model</b>	<b>REF. NO.</b>	<b>SEM NO.</b>	
	0005040614	10231	
			<b>Description</b> Rubber Buffer



D=Ø38 d=Ø11 h=54

**SEM NO.**

**8493**

**REF. NO.**

9405040214

**Type / Model**

**Description**







Rubber Metal Bushing

Type / Model	REF. NO.	SEM NO.
1418 1518	3714927087	7520
1624 1924		
2223 2224		
2624 2628		

**Description**  
Rubber Metal Buffer









M 10x22

	ŞEM NO.	REF. NO.	Type / Model
 D=Ø170 d=Ø130 h=127	9513	9415281182	
<b>Description</b>			
Bellows			
	ŞEM NO.	REF. NO.	Type / Model
 D=Ø30 h=30 M.8x15mm	8495	3759870140 0019876340	
<b>Description</b>			
Rubber Buffer			
	ŞEM NO.	REF. NO.	Type / Model
 L=30 M8x25	10428	0029870940 3759870040	
<b>Description</b>			
Rubber Mounting			
	ŞEM NO.	REF. NO.	Type / Model
	11755	 4221440280	
<b>Description</b>			
Gasket			
	ŞEM NO.	REF. NO.	Type / Model
	11756	 4221440280S	
<b>Description</b>			
Repair Kit			
		1 - 11755	

Type / Model	REF. NO.	SEM NO.	
	8975500204 0004292184 0004292484	10919	 Description Coupling Seal Ring D=Ø41 d=Ø18 h=9
Type / Model	REF. NO.	SEM NO.	
	9522019202	10920	 Description Coupling Seal Ring D=Ø41 d=Ø18 h=13



	<table border="1"> <thead> <tr> <th>ŞEM NO.</th> <th>REF. NO.</th> <th>Type / Model</th> </tr> </thead> <tbody> <tr> <td>9959</td> <td>3662000804</td> <td>2521</td> </tr> <tr> <td colspan="3"><b>Description</b></td> </tr> <tr> <td colspan="3">Water Pump Repair Kit / Fag Bearing</td> </tr> </tbody> </table>	ŞEM NO.	REF. NO.	Type / Model	9959	3662000804	2521	<b>Description</b>			Water Pump Repair Kit / Fag Bearing			
ŞEM NO.	REF. NO.	Type / Model												
9959	3662000804	2521												
<b>Description</b>														
Water Pump Repair Kit / Fag Bearing														
	<table border="1"> <thead> <tr> <th>ŞEM NO.</th> <th>REF. NO.</th> <th>Type / Model</th> </tr> </thead> <tbody> <tr> <td>9960</td> <td>3662000804S</td> <td>2521</td> </tr> <tr> <td colspan="3"><b>Description</b></td> </tr> <tr> <td colspan="3">Water Pump Repair Kit / Ors Bearing</td> </tr> </tbody> </table>	ŞEM NO.	REF. NO.	Type / Model	9960	3662000804S	2521	<b>Description</b>			Water Pump Repair Kit / Ors Bearing			
ŞEM NO.	REF. NO.	Type / Model												
9960	3662000804S	2521												
<b>Description</b>														
Water Pump Repair Kit / Ors Bearing														
	<table border="1"> <thead> <tr> <th>ŞEM NO.</th> <th>REF. NO.</th> <th>Type / Model</th> </tr> </thead> <tbody> <tr> <td>9961</td> <td>4232000401</td> <td>Q 125 mm V6 V8</td> </tr> <tr> <td colspan="3"><b>Description</b></td> </tr> <tr> <td colspan="3">Water Pump Repair Kit</td> </tr> </tbody> </table>	ŞEM NO.	REF. NO.	Type / Model	9961	4232000401	Q 125 mm V6 V8	<b>Description</b>			Water Pump Repair Kit			
ŞEM NO.	REF. NO.	Type / Model												
9961	4232000401	Q 125 mm V6 V8												
<b>Description</b>														
Water Pump Repair Kit														
	<table border="1"> <thead> <tr> <th>ŞEM NO.</th> <th>REF. NO.</th> <th>Type / Model</th> </tr> </thead> <tbody> <tr> <td>9962</td> <td>4572000104</td> <td>Q 125 mm AXOR 457</td> </tr> <tr> <td colspan="3"><b>Description</b></td> </tr> <tr> <td colspan="3">Water Pump Repair Kit</td> </tr> </tbody> </table>	ŞEM NO.	REF. NO.	Type / Model	9962	4572000104	Q 125 mm AXOR 457	<b>Description</b>			Water Pump Repair Kit			
ŞEM NO.	REF. NO.	Type / Model												
9962	4572000104	Q 125 mm AXOR 457												
<b>Description</b>														
Water Pump Repair Kit														
	<table border="1"> <thead> <tr> <th>ŞEM NO.</th> <th>REF. NO.</th> <th>Type / Model</th> </tr> </thead> <tbody> <tr> <td>9963</td> <td>9042000004</td> <td>AXOR 906 ATEGO 904</td> </tr> <tr> <td colspan="3"><b>Description</b></td> </tr> <tr> <td colspan="3">Water Pump Repair Kit</td> </tr> </tbody> </table>	ŞEM NO.	REF. NO.	Type / Model	9963	9042000004	AXOR 906 ATEGO 904	<b>Description</b>			Water Pump Repair Kit			
ŞEM NO.	REF. NO.	Type / Model												
9963	9042000004	AXOR 906 ATEGO 904												
<b>Description</b>														
Water Pump Repair Kit														
	<table border="1"> <thead> <tr> <th>ŞEM NO.</th> <th>REF. NO.</th> <th>Type / Model</th> </tr> </thead> <tbody> <tr> <td>11348</td> <td>0012011919</td> <td></td> </tr> <tr> <td colspan="3"><b>Description</b></td> </tr> <tr> <td colspan="3">Seal With Thrust Ring And Boat</td> </tr> </tbody> </table>	ŞEM NO.	REF. NO.	Type / Model	11348	0012011919		<b>Description</b>			Seal With Thrust Ring And Boat			
ŞEM NO.	REF. NO.	Type / Model												
11348	0012011919													
<b>Description</b>														
Seal With Thrust Ring And Boat														

Q 15 mm

Type / Model	REF. NO.	SEM NO.	
	4030320309	11339	 <b>Description</b> Intermediate Ring / Rear 115x120x21
Type / Model	REF. NO.	SEM NO.	
	4420310027	11340	 <b>Description</b> Intermediate Ring / Front 100x105x 24,5



**SEM NO.**

**7508**

**REF. NO.**

6202680196  
3852680696

**Type / Model**

**Description**

Protecting Cap

D=Ø 58 d=Ø 20 h= 20



**SEM NO.**

**7795**

**REF. NO.**

3852681474S  
3852680696S  
6202680196S  
0019813931S  
0009814531S  
0009815531S

**Type / Model**

**Description**

Repair Kit for Gearshift Lever

1- 6202680196  
2- 0019813931  
0009815531  
0009814531  
3- 3852681474  
4- 000472042000

D=Ø42 d=Ø8 L=120



**SEM NO.**

**7797**

**REF. NO.**

3852681474S1  
0019813931S1  
0009814531S1  
0009815531S1

**Type / Model**

**Description**

Joint Bearing

D=Ø42 d=Ø8 L=120



**SEM NO.**

**9440**

**REF. NO.**

6552680074S

**Type / Model**

**Description**

Joint Bearing (Elges Germany)



**SEM NO.**

**9445**

**REF. NO.**

6552680074

**Type / Model**

**Description**

Joint Bearing (Elges Germany)

Ø42



**SEM NO.**

**8367**

**REF. NO.**







0002670697







**Type / Model**

**Description**

Seal (Viton)

D=Ø38 d=Ø24 h=15

Type / Model	REF. NO.	SEM NO.	
AXOR	3752600337	9989	 <p><b>Description</b> Lever</p>
AXOR 001481 00334	3752600337S1 3752600337- 1 Pcs. 3752680374- 2 Pcs. 0189975848- 2 Pcs. N001481003034- 2 Pcs.	9990	 <p><b>Description</b> Lever - Full</p>
AXOR	3752600337S2 3752600374- 2 Pcs. 3359920203- 2 Pcs. 6209920003- 2 Pcs. N000094002077- 2 Pcs. 0189975848- 2 Pcs. N000472025000- 1 Pcs. N912009010200- 2 Pcs. N000988018012- 1 Pcs.	9991	 <p><b>Description</b> Gear Shift Repair Kit</p>
AXOR	3752600037	9992	 <p><b>Description</b> Bracket</p>
AXOR	3752600037S 3752600037- 1 Pcs. 3359920203- 2 Pcs. 0009978648- 2 Pcs. 9702600152- 1 Pcs. 3859900740- 1 Pcs. N9101050100091- 1 Pcs.	9993	 <p><b>Description</b> Bracket And Repair Kit</p>
AXOR	3752600037S1 3752600037- 1 Pcs. 3752600337- 1 Pcs. 3752600374- 2 Pcs. 0189975848- 2 Pcs. 9702600152- 1 Pcs. 3859900740- 1 Pcs. N001481003034- 2 Pcs. N910105010009- 1 Pcs.	9994	 <p><b>Description</b> Bracket - Full</p>

	<table border="1"> <thead> <tr> <th>ŞEM NO.</th> <th>REF. NO.</th> <th>Type / Model</th> </tr> </thead> </table>	ŞEM NO.	REF. NO.	Type / Model	
ŞEM NO.	REF. NO.	Type / Model			
	<table border="1"> <tbody> <tr> <td>9995</td> <td>3752600562</td> <td>AXOR</td> </tr> </tbody> </table>	9995	3752600562	AXOR	
9995	3752600562	AXOR			
	<p><b>Description</b> Bracket</p>				
	<table border="1"> <thead> <tr> <th>ŞEM NO.</th> <th>REF. NO.</th> <th>Type / Model</th> </tr> </thead> </table>	ŞEM NO.	REF. NO.	Type / Model	
ŞEM NO.	REF. NO.	Type / Model			
	<table border="1"> <tbody> <tr> <td>9996</td> <td>3752600037S2 3759920203- 2 Pcs. 0009978648- 2 Pcs. 9702600152- 1 Pcs. 3859900740- 1 Pcs. N910105010009- 1 Pcs.</td> <td>AXOR</td> </tr> </tbody> </table>	9996	3752600037S2 3759920203- 2 Pcs. 0009978648- 2 Pcs. 9702600152- 1 Pcs. 3859900740- 1 Pcs. N910105010009- 1 Pcs.	AXOR	
9996	3752600037S2 3759920203- 2 Pcs. 0009978648- 2 Pcs. 9702600152- 1 Pcs. 3859900740- 1 Pcs. N910105010009- 1 Pcs.	AXOR			
	<p><b>Description</b> Gear Shift Repair Kit</p>				
	<table border="1"> <thead> <tr> <th>ŞEM NO.</th> <th>REF. NO.</th> <th>Type / Model</th> </tr> </thead> </table>	ŞEM NO.	REF. NO.	Type / Model	
ŞEM NO.	REF. NO.	Type / Model			
	<table border="1"> <tbody> <tr> <td>9997</td> <td>3752600737S 0019882510- 2 Pcs. 9702600152- 2 Pcs. 9702680253- 1 Pcs. N910105010016- 1 Pcs. N913023010002- 1 Pcs.</td> <td>AXOR</td> </tr> </tbody> </table>	9997	3752600737S 0019882510- 2 Pcs. 9702600152- 2 Pcs. 9702680253- 1 Pcs. N910105010016- 1 Pcs. N913023010002- 1 Pcs.	AXOR	
9997	3752600737S 0019882510- 2 Pcs. 9702600152- 2 Pcs. 9702680253- 1 Pcs. N910105010016- 1 Pcs. N913023010002- 1 Pcs.	AXOR			
	<p><b>Description</b> Gear Shift Repair Kit</p>				
	<table border="1"> <thead> <tr> <th>ŞEM NO.</th> <th>REF. NO.</th> <th>Type / Model</th> </tr> </thead> </table>	ŞEM NO.	REF. NO.	Type / Model	
ŞEM NO.	REF. NO.	Type / Model			
	<table border="1"> <tbody> <tr> <td>11352</td> <td>9762681515</td> <td>AXOR</td> </tr> </tbody> </table>	11352	9762681515	AXOR	
11352	9762681515	AXOR			
	<p><b>Description</b> Shift Lever</p>				
<p>906</p>		<table border="1"> <thead> <tr> <th>ŞEM NO.</th> <th>REF. NO.</th> <th>Type / Model</th> </tr> </thead> </table>	ŞEM NO.	REF. NO.	Type / Model
ŞEM NO.	REF. NO.	Type / Model			
	<table border="1"> <tbody> <tr> <td>11354</td> <td>9452601937</td> <td>AXOR 4140</td> </tr> </tbody> </table>	11354	9452601937	AXOR 4140	
11354	9452601937	AXOR 4140			
	<p><b>Description</b> Bracket</p>				
	<table border="1"> <thead> <tr> <th>ŞEM NO.</th> <th>REF. NO.</th> <th>Type / Model</th> </tr> </thead> </table>	ŞEM NO.	REF. NO.	Type / Model	
ŞEM NO.	REF. NO.	Type / Model			
	<table border="1"> <tbody> <tr> <td>11355</td> <td>9452601937S</td> <td>AXOR 4140</td> </tr> </tbody> </table>	11355	9452601937S	AXOR 4140	
11355	9452601937S	AXOR 4140			
	<p><b>Description</b> Gear Shift Repair Kit Complete</p>				

Type / Model	REF. NO.	SEM NO.	
4140 AXOR	9452601937S1	11356	
			<p><b>Description</b> Gear Shift Repair Kit</p>

Type / Model	REF. NO.	SEM NO.	
4140 AXOR	9452602562 9452601062	11357	
			<p><b>Description</b> Bracket</p>

	ŞEM NO.	REF. NO.	Type / Model
	8321	9423300403	
		9423300303	
<b>Description</b> Tie Rod		9423301603	
		9423302403	
L 1664 mm M27x1,5 M30x1,5 K 32			







	ŞEM NO.	REF. NO.	Type / Model
	8322	0024604905	
		0024605005	
<b>Description</b> Tie Rod		0034605605	
	L 895 mm M20x1,5 K 24		

	ŞEM NO.	REF. NO.	Type / Model
	8323	9753300203	
		9753301603	
<b>Description</b> Tie Rod		9753301703	
		9753300303	
		9753300803	
L 1605 mm M24x1,5 M30x1,5 K30			







	ŞEM NO.	REF. NO.	Type / Model
	8324	0024604405	
		0024604305	
<b>Description</b> Tie Rod		0034604805	
	L 879 mm M28x1,5 K 28,6		







	ŞEM NO.	REF. NO.	Type / Model
	8325	9453300603	
		9453300403	
<b>Description</b> Tie Rod		9453300103	
		9453300003	
L 1735 mm M27x1,5 M30x1,5 K 32			







	ŞEM NO.	REF. NO.	Type / Model
	8326	9423301103	
		9423300003	
<b>Description</b> Tie Rod		9423300703	
		9423300103	
		9423300203	
		9423302303	
L 1735 mm M27x1,5 M30x1,5 K 32			







Type / Model	REF. NO.	ŞEM NO.	
	0024604605 0024604505 3754600405 0034605005	8327	
		<b>Description</b>	
		Tie Rod	
			L 895 mm M30x1,5 K 28,6
Type / Model	REF. NO.	ŞEM NO.	
	3874603605 6474600305 6474600205 3874603505 3874601505	8537	
		<b>Description</b>	
		Tie Rod	
			L 865 mm M 24x1,5 M30x1,5 K 30
Type / Model	REF. NO.	ŞEM NO.	
	0024604705 0024604805 0034600905	9328	
		<b>Description</b>	
		Tie Rod	
			L=876 koni=28,6 boru=40
Type / Model	REF. NO.	ŞEM NO.	
	6204603705 6204600005 6204602005 6204602805 3874600405 3874605005	9330	
		<b>Description</b>	
		Tie Rod	
			L=885 koni=30 boru=40
Type / Model	REF. NO.	ŞEM NO.	
	6734600205 6734600405 6734600605 6734600805	9333	
		<b>Description</b>	
		Tie Rod	
			L=953 koni=30 boru=53
Type / Model	REF. NO.	ŞEM NO.	
	3433201632 3433201732 3433201832	9376	
		<b>Description</b>	
		Tie Axle Rod	
			L=595 L=160 M38x1,5



	ŞEM NO.	REF. NO.	Type / Model
 L 780 mm	<b>10087</b>	6764601105 6764600105 6764600605 6764601505	
	<b>Description</b>		
			Tie Rod
	ŞEM NO.	REF. NO.	Type / Model
 L 720 mm	<b>10088</b>	6754603005 6754601805 6754601205 6754602405	
	<b>Description</b>		
			Tie Rod
	ŞEM NO.	REF. NO.	Type / Model
 L 1615 mm	<b>10089</b>	3713307003 3933300203 3933300303 3933300003 3933300403	
	<b>Description</b>		
			Tie Rod
	ŞEM NO.	REF. NO.	Type / Model
 L 879 mm	<b>10090</b>	0004607105 0004607205 0014606705	
	<b>Description</b>		
			Tie Rod
	ŞEM NO.	REF. NO.	Type / Model
 L 840 mm	<b>10091</b>	0014602905 0014603005	
	<b>Description</b>		
			Tie Rod
	ŞEM NO.	REF. NO.	Type / Model
 L 505 mm	<b>10092</b>	6684600505 6684600705 6684600905 6684601105	
	<b>Description</b>		
			Tie Rod

Type / Model	REF. NO.	SEM NO.	
	0024605105 0024605205 0004604005	10093	 <b>Description</b> Tie Rod L 885 mm
Type / Model	REF. NO.	SEM NO.	
	9704600705 9704600905	10094	 <b>Description</b> Tie Rod L 846 mm
Type / Model	REF. NO.	SEM NO.	
	6253303203 9443301703 3463303903 3463304903 9443300503 9443301303	10095	 <b>Description</b> Tie Rod L 1588 mm
Type / Model	REF. NO.	SEM NO.	
	9744601005 9744601205 3754600005 0034604605	10097	 <b>Description</b> Tie Rod L 895 mm
Type / Model	REF. NO.	SEM NO.	
	9724601805 9724602005 0034605905 3754600305	10098	 <b>Description</b> Tie Rod L 895 mm
Type / Model	REF. NO.	SEM NO.	
	0004609805 0004609905	10099	 <b>Description</b> Tie Rod L 895 mm

	SEM NO.	REF. NO.	Type / Model
 L 510 mm	<b>10100</b>	6674601505 6674601705	
	<b>Description</b>		Tie Rod
 L 1236 mm	<b>10102</b>	6314600705	
	<b>Description</b>		Tie Rod
 L 1588 mm	<b>10103</b>	6253301203 6253300903 9443300203	
	<b>Description</b>		Tie Rod
 L 1745 mm	<b>10104</b>	9413300103 9413300203 9413300503 9413300003 9413300303	
	<b>Description</b>		Tie Rod
 Length: 200 mm	<b>11132</b>	6283200289 6283201189	
	<b>Description</b>		Tie Rod
 Length: 260 mm	<b>11133</b>	6283200089 6283201089	
	<b>Description</b>		Tie Rod

Type / Model	REF. NO.	SEM NO.	
	6343230216 6343230416	11134	 <b>Description</b> Tie Rod Length: 375 mm
	6343230316 6343230516 6343230116	11135	 <b>Description</b> Tie Rod Length: 375 mm
	6343260016 6343260516	11136	 <b>Description</b> Tie Rod Length: 300 mm
	6343260116 6343260616	11137	 <b>Description</b> Tie Rod Length: 300 mm
	0003200232 0003200632 0003200932 0003201032 6323200432	11138	 <b>Description</b> Tie Rod Length: 148 mm
	0003200132 0003200532 0003200832 0003201132 6323200332	11139	 <b>Description</b> Tie Rod Length: 148 mm

	SEM NO.	REF. NO.	Type / Model
	<b>11140</b>	0003201232 6293200189 6323200232 6323200532 6283201489	
	<b>Description</b>		
			Tie Rod
Length: 200 mm			

	SEM NO.	REF. NO.	Type / Model
	<b>11543</b>	0024609605 0024609705 0034605705	
	<b>Description</b>		
			Tie Rod

	SEM NO.	REF. NO.	Type / Model
	<b>11544</b>	0024606105 0024606205 0034604205	
	<b>Description</b>		
			Tie Rod

Type / Model	REF. NO.	SEM NO.	
ACTROS 0 403	0003305248	0004602948	<b>8631 (8641)</b>  <b>Description</b> Rod End  M30Xx1.5 RHT L=120
ATEGO 0 404	0014600248	0014602248	
AXOR 0 4	0014607748	0003387310	
ECONIC	0014600848		
LK/LN2	0004600348		
MK	0014601248		
NG	0004602848	0004608948	
Type / Model	REF. NO.	SEM NO.	
ACTROS 0 403	0004600648	0014602348	<b>8632 (8642)</b>  <b>Description</b> Rod End  M30Xx1.5 LHT L=120
ATEGO 0 404	0004601048	0014607848	
AXOR 0 4	0004601248	0016077848	
ECONIC	0004603448	6984603748	
LK/LN2	0004603548		
MK	0014600348		
NG	0014601448	0014601848	
Type / Model	REF. NO.	SEM NO.	
LK/LN2	0003301435	0023301135	<b>8633 (8643)</b>  <b>Description</b> Rod End  M28Xx1.5 RHT L=105
NG	0003301535		
T2/LN1	0003307135		
VARIO	0003309335		
	0003309535		
	0003309505		
	0003382129	0003383629	
Type / Model	REF. NO.	SEM NO.	
LK/LN2	0003303335		<b>8634 (8644)</b>  <b>Description</b> Rod End  M28Xx1.5 RHT L=105
NG	0003309635		
T2/LN1	0023301235		
VARIO	0003307235		
	0003309435		
Type / Model	REF. NO.	SEM NO.	
ACTROS 0301	0013300135	0013306735	<b>8635 (8645)</b>  <b>Description</b> Rod End  M30Xx1.5 RHT L=115
1996-2003 0340	0023301535	0014604148	
ATEGO 0402	0003300248	0014604448	
AXOR 0405	0003303235	0014606348	
LP 0407	0003383410	0014608348	
LK/LN2 0408	0004608348	0014608448	
MK SK	0004633429	0014609748	
NG UNIMOG	0013300235		
Type / Model	REF. NO.	SEM NO.	
ACTROS 0301	0003300035	3023300235	<b>8636 (8646)</b>  <b>Description</b> Rod End  M30Xx1.5 LHT L=115
1996-2003 0340	0003300148	3023300335	
ATEGO 0402	0013308835	3503307135	
AXOR 0405	3023300035	0014606448	
LP 0407	0014604348	3453307435	
LK/LN2 0408	0014604048		
MK SK	3453307235		
NG UNIMOG	3023300135		

	SEM NO.	REF. NO.	Type / Model
	<b>8637</b> (8649)	0003300335 0003308535 0003382410 0004607248	LK/LN2 NG T2/LN2 LP
	<b>Description</b> Rod End	0003300635 0003308735 0004633229	NG

M24x1.5 RHT L=95

	SEM NO.	REF. NO.	Type / Model
	<b>8638</b> (8650)	0003300235 0003300735 0003308635 0003306835	LK/LN2 NG T2/LN2 LP
	<b>Description</b> Rod End	0003308835	NG

M24x1.5 LHT L=95

	SEM NO.	REF. NO.	Type / Model
	<b>8639</b> (8652)	0004600148 0004602648 0004602748 0014607448	NG LK/LN2 O 405 SK
	<b>Description</b> Rod End		

M30x1.5 RHT L=120

	SEM NO.	REF. NO.	Type / Model
	<b>8640</b>	0014607548	
	<b>Description</b> Rod End		







M30x1.5 LHT L=120

	SEM NO.	REF. NO.	Type / Model
	<b>8647</b>	0003301235 0003307535 0003309935 0003309735	T2/LN1 VARIO UNIMOG
	<b>Description</b> Rod End	0003383429 0003383529	







M24x1.5 RHT L=105







	SEM NO.	REF. NO.	Type / Model
	<b>8648</b>	0003301335 0003309835 0013300035	T2/LN1 VARIO UNIMOG
	<b>Description</b> Rod End		







M24x1.5 LHT L=105







Type / Model	REF. NO.	SEM NO.	
T2 / LN1 VARIO	0003301035 0003381610 0013301435 0013301235	8651	 <b>Description</b> Rod End M24x1.5 RHT L=95
Type / Model	REF. NO.	SEM NO.	
NG 2232 O 307	0003304035	8653	 <b>Description</b> Rod End M35x1.5 RHT L=150
1626 2626 O 340	0003307735		
1632 2628 O 345	0013302135		
1719 2632 O 407	0013302635		
1919 2636 O 405	0003384929		
1932 3336 ATEGO			
2026 O 303 1217			
2226 O 205 1223			
	SK 1844		
Type / Model	REF. NO.	SEM NO.	
NG 2232 O 307	0003301935	8654	 <b>Description</b> Rod End M35x1.5 LHT L=150
1626 2626 O 340	0003304105		
1632 2628 O 345	0003385029		
1719 2632 O 407	0013302235		
1919 2636 O 405	0003302935		
1932 3336 ATEGO	0003302905		
2026 O 303 1217	0013302735		
2226 O 205 1223	0003307835		
	SK 1846		
Type / Model	REF. NO.	SEM NO.	
ACTROS SERIES	0004605748	8655	 <b>Description</b> Rod End M30x1.5 RHT L=120
ATECO SERIES	0004606048		
	0004606848		
	0004607048		
	0014609648		
	0014601148		
	0014601748		
	0014602448		
Type / Model	REF. NO.	SEM NO.	
ACTROS SERIES	0004605848	8656	 <b>Description</b> Rod End M30x1.5 LHT L=120
ATECO SERIES	0004606948		
	0014600548		
	0014607948		
	0004606148		
	0004607148		
	0014601348		
	0014602548		
Type / Model	REF. NO.	SEM NO.	
LK/LN2	0003303135	8657	 <b>Description</b> Rod End M30x1.5 RHT L=115
LP	0013300335		
NG	0003308135		
	0013300435		



	<table border="1"> <thead> <tr> <th>SEM NO.</th> <th>REF. NO.</th> <th>Type / Model</th> </tr> </thead> </table>	SEM NO.	REF. NO.	Type / Model
SEM NO.	REF. NO.	Type / Model		
	<table border="1"> <tbody> <tr> <td>8658</td> <td>0014602948</td> <td>ACTROS SERIES ATECO SERIES</td> </tr> </tbody> </table>	8658	0014602948	ACTROS SERIES ATECO SERIES
8658	0014602948	ACTROS SERIES ATECO SERIES		
	<p><b>Description</b> Rod End</p>			
<p>M30x1.5 RHT L=125</p>				
	<table border="1"> <thead> <tr> <th>SEM NO.</th> <th>REF. NO.</th> <th>Type / Model</th> </tr> </thead> </table>	SEM NO.	REF. NO.	Type / Model
SEM NO.	REF. NO.	Type / Model		
	<table border="1"> <tbody> <tr> <td>8659</td> <td>0004607748 0014602148</td> <td>O 403</td> </tr> </tbody> </table>	8659	0004607748 0014602148	O 403
8659	0004607748 0014602148	O 403		
	<p><b>Description</b> Rod End</p>			
<p>M24x1.5 RHT L=120</p>				
	<table border="1"> <thead> <tr> <th>SEM NO.</th> <th>REF. NO.</th> <th>Type / Model</th> </tr> </thead> </table>	SEM NO.	REF. NO.	Type / Model
SEM NO.	REF. NO.	Type / Model		
	<table border="1"> <tbody> <tr> <td>8660</td> <td>0004607848 0014602048</td> <td>O 403</td> </tr> </tbody> </table>	8660	0004607848 0014602048	O 403
8660	0004607848 0014602048	O 403		
	<p><b>Description</b> Rod End</p>			
<p>M24x1.5 LHT L=120</p>				
	<table border="1"> <thead> <tr> <th>SEM NO.</th> <th>REF. NO.</th> <th>Type / Model</th> </tr> </thead> </table>	SEM NO.	REF. NO.	Type / Model
SEM NO.	REF. NO.	Type / Model		
	<table border="1"> <tbody> <tr> <td>8661</td> <td>0014604248 0024600548 0014608948 0014605048 0014608548</td> <td>ACTROS SERIES ATECO SERIES AXOR SERIES</td> </tr> </tbody> </table>	8661	0014604248 0024600548 0014608948 0014605048 0014608548	ACTROS SERIES ATECO SERIES AXOR SERIES
8661	0014604248 0024600548 0014608948 0014605048 0014608548	ACTROS SERIES ATECO SERIES AXOR SERIES		
	<p><b>Description</b> Rod End</p>			
<p>M28x1.5 RHT L=115</p>				
	<table border="1"> <thead> <tr> <th>SEM NO.</th> <th>REF. NO.</th> <th>Type / Model</th> </tr> </thead> </table>	SEM NO.	REF. NO.	Type / Model
SEM NO.	REF. NO.	Type / Model		
	<table border="1"> <tbody> <tr> <td>10138</td> <td>0014603848 0014604848 0014609948 0014608648 0014605148</td> <td></td> </tr> </tbody> </table>	10138	0014603848 0014604848 0014609948 0014608648 0014605148	
10138	0014603848 0014604848 0014609948 0014608648 0014605148			
	<p><b>Description</b> Rod End</p>			
<p>M30x1.5 RHT L=115</p>				
	<table border="1"> <thead> <tr> <th>SEM NO.</th> <th>REF. NO.</th> <th>Type / Model</th> </tr> </thead> </table>	SEM NO.	REF. NO.	Type / Model
SEM NO.	REF. NO.	Type / Model		
	<table border="1"> <tbody> <tr> <td>10139</td> <td>0004606548</td> <td></td> </tr> </tbody> </table>	10139	0004606548	
10139	0004606548			
	<p><b>Description</b> Rod End</p>			
<p>M18x1.5 RHT L=92</p>				

<b>Type / Model</b>	<b>REF. NO.</b>	<b>SEM NO.</b>	 <b>Description</b> Rod End M38x1.5 RHT L=135
	0004601748	<b>10140</b> (10141)	
<b>Type / Model</b>	<b>REF. NO.</b>	<b>SEM NO.</b>	 <b>Description</b> Rod End M30x1.5 RHT L=160
	6994601648	<b>10150</b> (10151)	
<b>Type / Model</b>	<b>REF. NO.</b>	<b>SEM NO.</b>	 <b>Description</b> Rod End
	0002684689 0002686289 3662680389	<b>10931</b> (10934)	
<b>Type / Model</b>	<b>REF. NO.</b>	<b>SEM NO.</b>	 <b>Description</b> Rod End
	0002684789 0002686189 3662680489	<b>10937</b> (10940)	
<b>Type / Model</b>	<b>REF. NO.</b>	<b>SEM NO.</b>	 <b>Description</b> Rod End
	0002680181 0002685289 0002684889	<b>10943</b> (10946)	
<b>Type / Model</b>	<b>REF. NO.</b>	<b>SEM NO.</b>	 <b>Description</b> Rod End
	0009967045 0009966845	<b>10952</b>	

	<b>SEM NO.</b>	<b>REF. NO.</b>	<b>Type / Model</b>
	<b>10953</b>	<b>0002685989</b>	
	<b>Description</b> Rod End		
	<b>SEM NO.</b>	<b>REF. NO.</b>	<b>Type / Model</b>
	<b>10954</b>	<b>0009966745</b>	
	<b>Description</b> Rod End		
	<b>SEM NO.</b>	<b>REF. NO.</b>	<b>Type / Model</b>
	<b>10955</b>	<b>0009966645</b>	
	<b>Description</b> Rod End		
	<b>SEM NO.</b>	<b>REF. NO.</b>	<b>Type / Model</b>
	<b>10956</b>	<b>0009965545 0009967545 0009965045</b>	
	<b>Description</b> Rod End		
	<b>SEM NO.</b>	<b>REF. NO.</b>	<b>Type / Model</b>
	<b>10957</b>	<b>0009965645 0009965145</b>	
	<b>Description</b> Rod End		
	<b>SEM NO.</b>	<b>REF. NO.</b>	<b>Type / Model</b>
	<b>10960</b>	<b>0009965245</b>	
	<b>Description</b> Rod End		

<b>Type / Model</b>	<b>REF. NO.</b>	<b>SEM NO.</b>	
	0013301835	<b>11560</b>	
		<b>Description</b>	
		Rod End	
<b>Type / Model</b>	<b>REF. NO.</b>	<b>SEM NO.</b>	
	0014608248	<b>11562</b>	
		<b>Description</b>	
		Rod End	
<b>Type / Model</b>	<b>REF. NO.</b>	<b>SEM NO.</b>	
	0004605248	<b>11563</b>	
		<b>Description</b>	
		Rod End	
<b>Type / Model</b>	<b>REF. NO.</b>	<b>SEM NO.</b>	
	0004604948	<b>11575</b>	
		<b>Description</b>	
		Rod End	
<b>Type / Model</b>	<b>REF. NO.</b>	<b>SEM NO.</b>	
	6293380010	<b>11579</b>	
		<b>Description</b>	
		Rod End	
<b>Type / Model</b>	<b>REF. NO.</b>	<b>SEM NO.</b>	
	0014601648		
	0024600648		
		<b>Description</b>	
		Rod End	

SEM NO.	REF. NO.	Type / Model
7612	0003300711	
<b>Description</b>		
Ball Joint		

D=Ø49 L=104



SEM NO.	REF. NO.	Type / Model
10828	6283201289S	CITARO
<b>Description</b>		
Ball Joint		

D=Ø52 M20x1,5



SEM NO.	REF. NO.	Type / Model
8310	3753910017 3753230385	AXOR
<b>Description</b>		
Rubber Metal Bushing		

D=Ø63 d=Ø20 h=72,5



SEM NO.	REF. NO.	Type / Model
11267	6383330814	V-KLASSE VITO VIANO
<b>Description</b>		
Control Arm/Trailing Arm Bush		



SEM NO.	REF. NO.	Type / Model
11268	6383330014 6393330314 6393330214	V-CLASS VIANO VITO
<b>Description</b>		
Control Arm/Trailing Arm Bush		



D=Ø41,5 d=Ø14 h=75



SEM NO.	REF. NO.	Type / Model
11270	9013330214 0340330004	SPRINTER VW LT 28-35 VW LT 28-46 CHRYSLER DODGE
<b>Description</b>		
Control Arm/Trailing Arm Bush		

D=Ø44 d=Ø14 h=80



Type / Model	REF. NO.	SEM NO.	
SPRINTER VW CRAFTER CHRYSLER DODGE	9063330014	11275	 <b>Description</b> Control Arm/Trailing Arm Bush D=Ø52 d=Ø14,5 h=75
SPRINTER VW CRAFTER CHRYSLER DODGE	9063330114	11276	
			 <b>Description</b> Control Arm/Trailing Arm Bush D=Ø52 d=Ø14 h=75

	SEM NO.	REF. NO.	Type / Model
 D=60 d=22 h=76	<b>1021</b>	0003220385 0003220585	
	<b>Description</b> Spring Eye Bushing		







	SEM NO.	REF. NO.	Type / Model
 D=62 d=24 h=86	<b>1025</b>	0003221985	
	<b>Description</b> Spring Eye Bushing		

	SEM NO.	REF. NO.	Type / Model
 D=62 d=24 h=96	<b>8016</b>	0003223285	
	<b>Description</b> Spring Eye Bushing		







	SEM NO.	REF. NO.	Type / Model
 D=62 d=24 h=96	<b>8217 (1006)</b>	0003221285 0003222185 0003222285 3753220185	
	<b>Description</b> Spring Eye Bushing		







	SEM NO.	REF. NO.	Type / Model
 D=Ø62 d=Ø22 h=96	<b>9231</b>	9743200544	
	<b>Description</b> Spring Eye Bushing		

	SEM NO.	REF. NO.	Type / Model
 D=Ø67 d=Ø24 L=96	<b>10791</b>	9603231285	
	<b>Description</b> Rubber Metal Bush		

<b>Type / Model</b>	<b>REF. NO.</b>	<b>SEM NO.</b>	
	9603231385	10792	
		<b>Description</b>	
		Rubber Metal Bush	
			D=Ø67 d=Ø24 L=104
<b>Type / Model</b>	<b>REF. NO.</b>	<b>SEM NO.</b>	
	9603231685	10793	
		<b>Description</b>	
		Rubber Metal Bush	
			D=Ø62 d=Ø24 L=104
<b>Type / Model</b>	<b>REF. NO.</b>	<b>SEM NO.</b>	
	0003250285 0003250785 0003250885 3753200444	10860 (1007)	
		<b>Description</b>	
		Spring Bushing	
			D=Ø62 d=Ø24 L=106
<b>Type / Model</b>	<b>REF. NO.</b>	<b>SEM NO.</b>	
	9603232885	10904	
		<b>Description</b>	
		Spring Bushing	
			D=Ø62 d=Ø24 L=104
<b>Type / Model</b>	<b>REF. NO.</b>	<b>SEM NO.</b>	
	0009980142	10905	
		<b>Description</b>	
		Spring Bushing	
			D=Ø62 d=Ø24 L=104
<b>Type / Model</b>	<b>REF. NO.</b>	<b>SEM NO.</b>	
	0003251385	11741	
		<b>Description</b>	
		Spring Bushing	
			D=Ø62 d=Ø24 h=106



	<b>SEM NO.</b>	<b>REF. NO.</b>	<b>Type / Model</b>
	7581	6733200150	
<b>Description</b>			
Eye Bushing			
D=Ø58 d=Ø36 h=96			
	<b>SEM NO.</b>	<b>REF. NO.</b>	<b>Type / Model</b>
	7582	6673200044	411 609 611 709 711 809 811 819
<b>Description</b>			
Eye Bushing			
D=Ø52 d=Ø30 h=86			
	<b>SEM NO.</b>	<b>REF. NO.</b>	<b>Type / Model</b>
	7583	6703200444	
<b>Description</b>			
Eye Bushing			
D=Ø52 d=Ø30 h=87			
	<b>SEM NO.</b>	<b>REF. NO.</b>	<b>Type / Model</b>
	7586	6703200344	
<b>Description</b>			
Eye Bushing			
D=Ø58 d=Ø36 h=87			
	<b>SEM NO.</b>	<b>REF. NO.</b>	<b>Type / Model</b>
	7587	6023240050 6013240150 6023240150 6013240050	BM 601 BM 602 207 208 307 308
<b>Description</b>			
Eye Bushing			
D=Ø50 d=Ø12 h=70			
	<b>SEM NO.</b>	<b>REF. NO.</b>	<b>Type / Model</b>
	7589	6733200050	414 709 809 814 817 1114 1117 1120
<b>Description</b>			
Eye Bushing			
D=Ø46 d=Ø16 h=96			

<b>Type / Model</b>	<b>REF. NO.</b>	<b>SEM NO.</b>	
	6113240350 6113240450 6113240050 9043200563S 9043200363S	<b>7820</b>	
		<b>Description</b>	
		Spring Eye Bushing	D=Ø49 d=Ø16 h=80
<b>Type / Model</b>	<b>REF. NO.</b>	<b>SEM NO.</b>	
	9013240350 9013240250	<b>7821</b>	
		<b>Description</b>	
		Spring Eye Bushing	D=Ø49 d=Ø12 h=80
<b>Type / Model</b>	<b>REF. NO.</b>	<b>SEM NO.</b>	
	0003210250 0003210450	<b>7842</b>	
		<b>Description</b>	
		Spring Eye Bushing	D=Ø39 d=Ø16 h=80
<b>Type / Model</b>	<b>REF. NO.</b>	<b>SEM NO.</b>	
	6753200050	<b>7846</b>	
		<b>Description</b>	
		Spring Eye Bushing	D=Ø58 d=Ø19 h=96
<b>Type / Model</b>	<b>REF. NO.</b>	<b>SEM NO.</b>	
	6753250585	<b>7857</b>	
		<b>Description</b>	
		Spring Eye Bushing	D=Ø64 d=Ø20 h=96
<b>Type / Model</b>	<b>REF. NO.</b>	<b>SEM NO.</b>	
	9743200044 3753200244 9583200244	<b>7895 (1003)</b>	
		<b>Description</b>	
		Spring Eye Bushing	D=Ø 64 d=Ø22 h=96

	SEM NO.	REF. NO.	Type / Model
 D=Ø 56 d=Ø18 h=96	<b>7896</b> (1004)	9703200344 6753250485 3753200644	
	<b>Description</b>		
			Spring Eye Bushing







	SEM NO.	REF. NO.	Type / Model
 D=Ø 50 d=Ø18 h=96	<b>7897</b> (1005)	9703200144 3753200744	
	<b>Description</b>		
			Spring Eye Bushing

	SEM NO.	REF. NO.	Type / Model
 D=Ø75 d=Ø36 h=96	<b>10832</b>	6753200150	
	<b>Description</b>		
			Spring Eye Bushing

	SEM NO.	REF. NO.	Type / Model
 D=Ø 62 d=Ø22 h=96	<b>7893</b> (1001)	9743200244 9743200344 3753200344	
	<b>Description</b>		
			Spring Eye Bushing

	SEM NO.	REF. NO.	Type / Model
 D=Ø62 d=Ø36 h=96	<b>8186</b>	6753200650	
	<b>Description</b>		
			Spring Bushing

	SEM NO.	REF. NO.	Type / Model
 D=Ø43 d=Ø12.5 h=45	<b>8147</b>	0009884211	
	<b>Description</b>		
			Bush

<b>Type / Model</b>	<b>REF. NO.</b>	<b>SEM NO.</b>	
SPRINTER VW LT 28-35 VW LT 28-46	9013240150	<b>11259</b>	
			<b>Description</b> Rubber Bushing for Spring
			D=Ø31,5 d=Ø12 h=80
<b>Type / Model</b>	<b>REF. NO.</b>	<b>SEM NO.</b>	
SPRINTER VW LT 28-35 VW LT 28-46 CHRYSLER DODGE	9013240050	<b>11260</b>	
			<b>Description</b> Rubber Bushing for Spring
			D=Ø32 d=Ø12 h=134
<b>Type / Model</b>	<b>REF. NO.</b>	<b>SEM NO.</b>	
T1 T1/TN T2/L	0003210350 0003210150 0003210050	<b>11262</b>	
			<b>Description</b> Rubber Bushing for Spring
			D=Ø33 d=Ø12 h=70
<b>Type / Model</b>	<b>REF. NO.</b>	<b>SEM NO.</b>	
T2/L T2/LN1	3103200050	<b>11265</b>	
			<b>Description</b> Rubber Bushing for Spring
			D=Ø52 d=Ø30 h=77
<b>Type / Model</b>	<b>REF. NO.</b>	<b>SEM NO.</b>	
		<b>8137</b>	
			<b>Description</b> Spring Bushing
			D=Ø58.5 d=Ø25 h=104
<b>Type / Model</b>	<b>REF. NO.</b>	<b>SEM NO.</b>	
		<b>8191</b>	
			<b>Description</b> Spring Eye Bushing
			D=Ø57 d=Ø24 h=102

	SEM NO.	REF. NO.	Type / Model
 <p>D=Ø48 d=Ø36 h=58</p>	8236	6733200250	
	<p><b>Description</b> Stabilizer Bushing</p>		







	SEM NO.	REF. NO.	Type / Model
 <p>D=Ø42 d=Ø30 h=43,5</p>	11263	3183220250 6673220350 6673220650	EVOBUS LP T2/LN1 VARIO
	<p><b>Description</b> Rubber Bushing for Spring</p>		







	SEM NO.	REF. NO.	Type / Model
 <p>D=Ø42 d=Ø30 h=40</p>	11264	3193240450 3193240750	T2/L HENSCHEL 2-T
	<p><b>Description</b> Rubber Bushing for Spring</p>		

	SEM NO.	REF. NO.	Type / Model
 <p>D=Ø152 d=Ø31,5 h=171</p>	9402	9463900050	
	<p><b>Description</b> Rubber Buffer</p>		







	SEM NO.	REF. NO.	Type / Model
 <p>D=Ø155,5 L=114</p>	10210	9463900250	
	<p><b>Description</b> Spring Bushing</p>		

	SEM NO.	REF. NO.	Type / Model
 <p>D=Ø160 d=Ø32 L=95</p>	10447	9463900150	
	<p><b>Description</b> Rubber Metal Bush</p>		

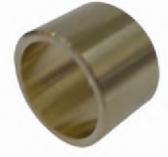



<b>Type / Model</b>	<b>REF. NO.</b>	<b>SEM NO.</b>	
	9493200073	<b>11590</b>	
			<b>Description</b> Spring Bushing
			D = Ø45 d = Ø24 L = 96
<b>Type / Model</b>	<b>REF. NO.</b>	<b>SEM NO.</b>	
	9493200173	<b>11591</b>	
			<b>Description</b> Spring Bushing
			D = Ø45 d = Ø24 L = 140
<b>Type / Model</b>	<b>REF. NO.</b>	<b>SEM NO.</b>	
	9493220153 9493200173S	<b>11625</b>	
			<b>Description</b> Spring Bushing
			d = Ø24 L = 140
<b>Type / Model</b>	<b>REF. NO.</b>	<b>SEM NO.</b>	
	9493220053 9493200073S	<b>11626</b>	
			<b>Description</b> Spring Bushing
			d = Ø24 L = 96
<b>Type / Model</b>	<b>REF. NO.</b>	<b>SEM NO.</b>	
	3143210050	<b>11609</b>	
			<b>Description</b> Spring Bushing
			D = Ø25 d = Ø20 L = 67
<b>Type / Model</b>	<b>REF. NO.</b>	<b>SEM NO.</b>	
	3703220050 3473210050 6203210050 3043210150 3043210050	<b>11610</b>	
			<b>Description</b> Spring Bushing
			D = Ø30 d = Ø25 L = 81

	<b>SEM NO.</b> <b>11611</b>	<b>REF. NO.</b> 3523250150 3963250050 3853250050 3273255050	<b>Type / Model</b>
	<b>Description</b> Spring Bushing		
D = Ø35 d = Ø30 L = 77			
	<b>SEM NO.</b> <b>11612</b>	<b>REF. NO.</b> 3163240350 3163240050	<b>Type / Model</b>
	<b>Description</b> Spring Bushing		
D = Ø30 d = Ø25 L = 77			
	<b>SEM NO.</b> <b>11613</b>	<b>REF. NO.</b> 3353240350 3043240050	<b>Type / Model</b>
	<b>Description</b> Spring Bushing		
D = Ø36 d = Ø30 L = 90			
	<b>SEM NO.</b> <b>11614</b>	<b>REF. NO.</b> 3353910050	<b>Type / Model</b>
	<b>Description</b> Spring Bushing		
D = Ø40 d = Ø30 L = 90			
	<b>SEM NO.</b> <b>11615</b>	<b>REF. NO.</b> 3873240050	<b>Type / Model</b>
	<b>Description</b> Spring Bushing		
D = Ø35 d = Ø30 L = 90			
	<b>SEM NO.</b> <b>11616</b>	<b>REF. NO.</b> 3853220050 3523220050 3123241250 3123241050	<b>Type / Model</b>
	<b>Description</b> Spring Bushing		
D = Ø30 d = Ø25 L = 67			



<b>Type / Model</b>	<b>REF. NO.</b>	<b>SEM NO.</b>	
	6243220050	<b>11617</b>	 <p><b>Description</b> Spring Bushing</p> <p>D = Ø36 d = Ø30 L = 25</p>
<b>Type / Model</b>	<b>REF. NO.</b>	<b>SEM NO.</b>	
	3123211350	<b>11622</b>	 <p><b>Description</b> Spring Bushing</p> <p>D = Ø25 d = Ø20 L = 56</p>
<b>Type / Model</b>	<b>REF. NO.</b>	<b>SEM NO.</b>	
	3533220050 3853220150	<b>11623</b>	 <p><b>Description</b> Spring Bushing</p> <p>D = Ø30 d = Ø25 L = 57</p>
<b>Type / Model</b>	<b>REF. NO.</b>	<b>SEM NO.</b>	
	3613251150	<b>11624</b>	 <p><b>Description</b> Spring Bushing</p> <p>D = Ø35 d = Ø30 L = 71</p>
<b>Type / Model</b>	<b>REF. NO.</b>	<b>SEM NO.</b>	
	9469900000	<b>10307</b>	 <p><b>Description</b> Spring Bolt</p> <p>M22x1,5x195</p>
<b>Type / Model</b>	<b>REF. NO.</b>	<b>SEM NO.</b>	
	0004010672 3854000124 6174000024	<b>10308</b>	 <p><b>Description</b> Nut</p> <p>M22x1,5</p>



	SEM NO.	REF. NO.	Type / Model
 M24x2	<b>10416</b>	910113024000	
	<b>Description</b> Nut		
	<b>10309</b>	9463280476	
	<b>Description</b> Ring		
	<b>11353</b>	9413220020	AXOR 4140
	<b>Description</b> Front Spring Rear		
	<b>10310</b>	9463280076	
	<b>Description</b> Plastic Ring		

Model:	ŞEM NO.	Description / Repair Kit for Spring
	<b>10305</b>	
<b>Item No</b>	<b>Ref. No</b>	<b>REF. NO:</b>
1	10307	9463900250S1
2	10309	
3	10210	
4	10308	
5	10310	



Model:	ŞEM NO.	Description / Repair Kit for Spring
	<b>10306</b>	
<b>Item No</b>	<b>Ref. No</b>	<b>REF. NO:</b>
1	10307	9463900250S2
2	10309	
3	10210	
4	10308	
5	10310	





Model:	ŞEM NO.	Description / Spring Bushing Repair Kit
<b>13030</b>		
<b>Item No</b>	<b>Ref. No</b>	<b>REF. NO:</b>
1	0003250285	0003250285S
	3753200444	0003250785S
2	000000005503	0003250885S
3	9413250150	3753200444S
4	0019908850	



Model:	ŞEM NO.	Description / Spring Bushing Repair Kit
<b>13031</b>		
<b>Item No</b>	<b>Ref. No</b>	<b>REF. NO:</b>
1	0003250285	0003250285S1
	3753200444	0003250785S1
2	000000005715	0003250885S1
3	0019908850	3753200444S1



Description / Spring Bushing Repair Kit	SEM NO.	Model:											
 <p><i>new product</i></p>	<b>13032</b>												
	<b>REF. NO:</b> 0003221285S 0003222185S 0003222285S 3753220185S	<table border="1"> <thead> <tr> <th>Item No</th> <th>Ref. No</th> </tr> </thead> <tbody> <tr> <td>1</td> <td>0003221285</td> </tr> <tr> <td></td> <td>3753220185</td> </tr> <tr> <td>2</td> <td>000000005503</td> </tr> <tr> <td>3</td> <td>9413250150</td> </tr> <tr> <td>4</td> <td>910113024000</td> </tr> </tbody> </table>	Item No	Ref. No	1	0003221285		3753220185	2	000000005503	3	9413250150	4
Item No	Ref. No												
1	0003221285												
	3753220185												
2	000000005503												
3	9413250150												
4	910113024000												

Description / Spring Bushing Repair Kit	SEM NO.	Model:									
 <p><i>new product</i></p>	<b>13033</b>										
	<b>REF. NO:</b> 0003221285S1 0003222185S1 0003222285S1 3753220185S1	<table border="1"> <thead> <tr> <th>Item No</th> <th>Ref. No</th> </tr> </thead> <tbody> <tr> <td>1</td> <td>0003221285</td> </tr> <tr> <td></td> <td>3753220185</td> </tr> <tr> <td>2</td> <td>000000005714</td> </tr> <tr> <td>3</td> <td>910113024000</td> </tr> </tbody> </table>	Item No	Ref. No	1	0003221285		3753220185	2	000000005714	3
Item No	Ref. No										
1	0003221285										
	3753220185										
2	000000005714										
3	910113024000										

Description / Spring Bushing Repair Kit	SEM NO.	Model:															
 <p><i>new product</i></p>	<b>13034</b>																
	<b>REF. NO:</b> 9493200073S1	<table border="1"> <thead> <tr> <th>Item No</th> <th>Ref. No</th> </tr> </thead> <tbody> <tr> <td>1</td> <td>9493200073</td> </tr> <tr> <td>2</td> <td>000000005506</td> </tr> <tr> <td>3</td> <td>000000005507</td> </tr> <tr> <td>4</td> <td>9493250050</td> </tr> <tr> <td>5</td> <td>9493250150</td> </tr> <tr> <td>6</td> <td>910113024000</td> </tr> <tr> <td>7</td> <td>9493220052</td> </tr> </tbody> </table>	Item No	Ref. No	1	9493200073	2	000000005506	3	000000005507	4	9493250050	5	9493250150	6	910113024000	7
Item No	Ref. No																
1	9493200073																
2	000000005506																
3	000000005507																
4	9493250050																
5	9493250150																
6	910113024000																
7	9493220052																

<b>Type / Model</b>	<b>REF. NO.</b>	<b>SEM NO.</b>	
	9013250084	7712	
			<b>Description</b> Spring Rubber 60x90x6
<b>Type / Model</b>	<b>REF. NO.</b>	<b>SEM NO.</b>	
	6673250084	7713	
			<b>Description</b> Spring Rubber 80x56x15
<b>Type / Model</b>	<b>REF. NO.</b>	<b>SEM NO.</b>	
	9433238484 9433238584 9433236184	7892	
			<b>Description</b> Rubber Metal Plate A=84 B=110 h=13
<b>Type / Model</b>	<b>REF. NO.</b>	<b>SEM NO.</b>	
	9433235184 3753230184	7898 (1008)	
			<b>Description</b> Rubber Metal Plate A=110 B=84 h=13
<b>Type / Model</b>	<b>REF. NO.</b>	<b>SEM NO.</b>	
	9433235384 9433238684 9433238384 9433235284 3753230084	7899 (1009)	
			<b>Description</b> Rubber Metal Plate A=110 B=84 h=13
<b>Type / Model</b>	<b>REF. NO.</b>	<b>SEM NO.</b>	
	6753250184	7900 (1010)	
			<b>Description</b> Rubber Metal Plate A=90 B=70 h=12

	SEM NO.	REF. NO.	Type / Model
	7901 (1011)	6753250284	
	<b>Description</b> Rubber Metal Plate		
A=90 B=66 h=12			

	SEM NO.	REF. NO.	Type / Model
	7903 (1013)	6753250584	
	<b>Description</b> Rubber Metal Plate		
A=120 B=70 h=12			

	SEM NO.	REF. NO.	Type / Model
	8232	6743250244 6743250044	
	<b>Description</b> Rubber Buffer		
D=Ø75 d=Ø55 h=15			

	SEM NO.	REF. NO.	Type / Model
	8406	9703250184	
	<b>Description</b> Spring Mounting		
90X70X13			

	SEM NO.	REF. NO.	Type / Model
	8407	9703250084	
	<b>Description</b> Spring Mounting		
90X70X13			

	SEM NO.	REF. NO.	Type / Model
	7902 (1012)	6753250144 3753200844	
	<b>Description</b> Rubber Metal Plate		
A=90 B=70 h=18			

<b>Type / Model</b>	<b>REF. NO.</b>	<b>SEM NO.</b>	
	9603220184	10220	
			<b>Description</b> Rubber Metal Rubber
			L=112 h=16 M12x1,5
<b>Type / Model</b>	<b>REF. NO.</b>	<b>SEM NO.</b>	
	9603220084 9603220384	10790	
			<b>Description</b> Rubber Metal Buffer
<b>Type / Model</b>	<b>REF. NO.</b>	<b>SEM NO.</b>	
	9013250744	7714	
			<b>Description</b> Spring Rubber
			80x70x42
<b>Type / Model</b>	<b>REF. NO.</b>	<b>SEM NO.</b>	
	9013222519 9013221619	7715	
			<b>Description</b> Spring Rubber
			134x94x42
<b>Type / Model</b>	<b>REF. NO.</b>	<b>SEM NO.</b>	
	9013222319	7716	
			<b>Description</b> Spring Rubber
			134x94x42
<b>Type / Model</b>	<b>REF. NO.</b>	<b>SEM NO.</b>	
	9013220619	7717	
			<b>Description</b> Spring Rubber
			134x94x44

	SEM NO.	REF. NO.	Type / Model
	7894 (1002)	9703200095	
	<b>Description</b>		
	Rubber Metal Plate		

	SEM NO.	REF. NO.	Type / Model
	9253	9703200195	
	<b>Description</b>		
	Spring Mounting		

	SEM NO.	REF. NO.	Type / Model
	7905 (1024)	9703250044 3753250144 9793250244	
	<b>Description</b>		
	Spring Mounting		

A=126 B=117

	SEM NO.	REF. NO.	Type / Model
	8496	3753300075	
	<b>Description</b>		
	Rubber Buffer		

	SEM NO.	REF. NO.	Type / Model
	8497	6173300175	
	<b>Description</b>		
	Rubber Buffer		

	SEM NO.	REF. NO.	Type / Model
	10213	9673250044	
	<b>Description</b>		
	Rubber Metal Rubber		





Type / Model	REF. NO.	SEM NO.	
	9679980040 9709980040	10214	
			<p><b>Description</b> Rubber Metal Rubber</p>

Type / Model	REF. NO.	SEM NO.	
	9673250144 9703250144	10215	
			<p><b>Description</b> Rubber Metal Rubber</p>

Type / Model	REF. NO.	SEM NO.	
	9673280039 9743280139	10216	
			<p><b>Description</b> Rubber Metal Rubber</p>

Type / Model	REF. NO.	SEM NO.	
	3093200177	9001	
			<p><b>Description</b> Spring Mounting</p>
			D=Ø66 d=Ø12 h=120

Type / Model	REF. NO.	SEM NO.	
	3093200277 6673200077	9008	
			<p><b>Description</b> Spring Mounting</p>

Type / Model	REF. NO.	SEM NO.	
	6293200077	11587	
			<p><b>Description</b> Rubber Buffer</p>



	SEM NO.	REF. NO.	Type / Model
	<b>10878</b>	0003220144 3753220044	
	<b>Description</b>		
			Rubber Buffer
D=Ø62 L=90			







	SEM NO.	REF. NO.	Type / Model
	<b>10879</b>	0003220244	
	<b>Description</b>		
			Rubber Buffer
D=Ø62 L=110			



	SEM NO.	REF. NO.	Type / Model
	<b>11261</b>	9013250144	SPRINTER
	<b>Description</b>		
			Spring Buffer







	SEM NO.	REF. NO.	Type / Model
	<b>9041</b>	3053240308	
	<b>Description</b>		
			Pur Mounting
D=Ø100 d=Ø14 h=115			







	SEM NO.	REF. NO.	Type / Model
	<b>9042</b>	3053240108	
	<b>Description</b>		
			Pur Mounting
D=Ø118 d=Ø16 h=95			

	SEM NO.	REF. NO.	Type / Model
	<b>9620</b>	3563210006	
	<b>Description</b>		
			Pur Mounting
D=Ø120 d=Ø24 h=115			

<b>Type / Model</b>	<b>REF. NO.</b>	<b>SEM NO.</b>	
	0003250896 0003250696	<b>8029</b>	
			<b>Description</b> Spring Mounting A=232 B=165 H=116,5
<b>Type / Model</b>	<b>REF. NO.</b>	<b>SEM NO.</b>	
	0003250596 0003250796	<b>8030</b>	
			<b>Description</b> Spring Mounting A=232 B=165 H=152
<b>Type / Model</b>	<b>REF. NO.</b>	<b>SEM NO.</b>	
4140	9473250296	<b>10867</b>	
			<b>Description</b> Spring Mounting d1=Ø15 d2=Ø17 Ax=170x60 L=152
<b>Type / Model</b>	<b>REF. NO.</b>	<b>SEM NO.</b>	
	0003250496	<b>10929</b>	
			<b>Description</b> Spring Mounting d1=21x31 Ax=125 Ax=100
<b>Type / Model</b>	<b>REF. NO.</b>	<b>SEM NO.</b>	
	6599900001	<b>11308</b>	
			<b>Description</b> Screw - Steel 20X1.5X 210 mm
<b>Type / Model</b>	<b>REF. NO.</b>	<b>SEM NO.</b>	
	N000912012214	<b>11737</b>	
			<b>Description</b> Bolt 12x1,5x60

	SEM NO.	REF. NO.	Type / Model
	11738	N913023012002	
	<b>Description</b> Nut		
M12x1,5			
	SEM NO.	REF. NO.	Type / Model
	11736	6293250015	
	<b>Description</b> Metal Sheet Plate		
D=Ø114 h=28			
	SEM NO.	REF. NO.	Type / Model
	11739	6293200077S	
	<b>Description</b> Repair Kit		
		1 - 11587	
		2 - 11736	
		3 - 11737	
		4 - 11738	

Type / Model	REF. NO.	SEM NO.	
3224	3833250112	9457	 <p><b>Description</b> Leaf Spring Bearing Rear</p>
3031 2631 2628 2622	6243250112	9458	 <p><b>Description</b> Leaf Spring Bearing</p>
AXOR 3028	9473250012	9976	 <p><b>Description</b> Spring Saddle - Up</p>
AXOR 3028	9473250042	9977	 <p><b>Description</b> Spring Saddle - Down</p>
AXOR	9413310526	9986	 <p><b>Description</b> Spring Holder Front Hub / Long Type</p>
AXOR	9413310426	11351	 <p><b>Description</b> Spring Holder Front Hub / Short Type</p>

	<b>SEM NO.</b>	<b>REF. NO.</b>	<b>Type / Model</b>
	10000	9473510126	AXOR 3340 4140
<b>Description</b>			
Rear Spring to Spring Saddle			
	<b>SEM NO.</b>	<b>REF. NO.</b>	<b>Type / Model</b>
	9460	3893200684	3031 2631 2628 2622
<b>Description</b>			
Cover for Leaf Spring			
	<b>SEM NO.</b>	<b>REF. NO.</b>	<b>Type / Model</b>
	10005	3832200084	3224
<b>Description</b>			
Cover			
	<b>SEM NO.</b>	<b>REF. NO.</b>	<b>Type / Model</b>
	9462	3893251062	3031 2631 2628 2622
<b>Description</b>			
Metal Washer			
	<b>SEM NO.</b>	<b>REF. NO.</b>	<b>Type / Model</b>
	9465	3873250162	3234
<b>Description</b>			
Pulley			
	<b>SEM NO.</b>	<b>REF. NO.</b>	<b>Type / Model</b>
	9974	0029815005 0029815305 0059819005	3031
<b>Description</b>			
Rokvel inside / Taped Roller Bearing (Steel)			

Ø= 110 mm

<b>Type / Model</b>	<b>REF. NO.</b>	<b>SEM NO.</b>	
3031	0049810605 0039816805 0079810305	9975	
			<b>Description</b> Rokvel Outside / Tapared Roller Bearing (Steel)
<b>Type / Model</b>	<b>REF. NO.</b>	<b>SEM NO.</b>	
3224	0049811805 0049814405	9998	
			<b>Description</b> Outside / Tapared Roller Bearing (Steel)
<b>Type / Model</b>	<b>REF. NO.</b>	<b>SEM NO.</b>	
3031 2631 2628 2622	3893252152	9459	
			<b>Description</b> Not for Leaf Spring
<b>Type / Model</b>	<b>REF. NO.</b>	<b>SEM NO.</b>	
3031 2631 2628 2622	3899905060	9461	
			<b>Description</b> Nut
<b>Type / Model</b>	<b>REF. NO.</b>	<b>SEM NO.</b>	
3234	3933250052	9463	
			<b>Description</b> Not for Leaf Spring
<b>Type / Model</b>	<b>REF. NO.</b>	<b>SEM NO.</b>	
3234	3939900060	9464	
			<b>Description</b> Not for Leaf Spring

	SEM NO.	REF. NO.	Type / Model
	9968	6253250219	2631 3031
	<b>Description</b> Spring Seat / Long Left		

	SEM NO.	REF. NO.	Type / Model
	9969	6253250319	2628
	<b>Description</b> Spring Seat Long Right		

	SEM NO.	REF. NO.	Type / Model
	9970	6253250119	
	<b>Description</b> Spring Seat Short - Right		



	SEM NO.	REF. NO.	Type / Model
	9971	6253250019	
	<b>Description</b> Spring Seat Short - Left		

	SEM NO.	REF. NO.	Type / Model
	9972	9703220184	ATEGO
	<b>Description</b> Shim-Left		

55 mm

	SEM NO.	REF. NO.	Type / Model
	9973	9703220084	ATEGO
	<b>Description</b> Shim-Right		

36 mm

Type / Model	REF. NO.	SEM NO.	
2622 2628 3031	6243250310	9978	 <b>Description</b> Support
AXOR 3028	9483250365 6483250365	9979	
AXOR	9473250426	9980	 <b>Description</b> Plate
AXOR	N910105020036	9981	
AXOR 3028	N000000005728	10043	 <b>Description</b> Screw M20x80x1,5 mm
AXOR 3028	N000000005579 N910105020032	10044	



	SEM NO.	REF. NO.	Type / Model
	<b>10045</b>	N910105020035	AXOR 4140
	<b>Description</b>		
	Screw - Steel		
M20x1.5x260 mm			







	SEM NO.	REF. NO.	Type / Model
	<b>11391</b>	3213511625	
	<b>Description</b>		
	Spring Bolt (U)		
M18x81x340			







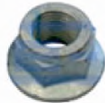

	SEM NO.	REF. NO.	Type / Model
	<b>11397</b>	9703511425	
	<b>Description</b>		
	Spring Bolt (U)		
M18x82x200			







	SEM NO.	REF. NO.	Type / Model
	<b>11398</b>	9743510425	
	<b>Description</b>		
	Spring Bolt (U)		
Ø20 M18x1,5x82x415			

	SEM NO.	REF. NO.	Type / Model
	<b>11399</b>	9493310225	
	<b>Description</b>		
	Spring Bolt (U)		
M20x92x205			

	SEM NO.	REF. NO.	Type / Model
	<b>11400</b>	9413310225	
	<b>Description</b>		
	Spring Bolt (U)		
M20x92x240			

<b>Type / Model</b>	<b>REF. NO.</b>	<b>SEM NO.</b>	
	3333310125	11401	
		<b>Description</b>	
		Spring Bolt (U)	
			M20x92x290
<b>Type / Model</b>	<b>REF. NO.</b>	<b>SEM NO.</b>	
	3753280026	11402	
		<b>Description</b>	
		Spring Bolt (U)	
			M24x130x266
<b>Type / Model</b>	<b>REF. NO.</b>	<b>SEM NO.</b>	
	6293510125	11403	
		<b>Description</b>	
		Spring Bolt (U)	
			M24x156x400
<b>Type / Model</b>	<b>REF. NO.</b>	<b>SEM NO.</b>	
	3953510425	11404	
		<b>Description</b>	
		Spring Bolt (U)	
			M24x102x480
<b>Type / Model</b>	<b>REF. NO.</b>	<b>SEM NO.</b>	
	N913023018002	11771	
		<b>Description</b>	
		Nut	
			M18x1,5
<b>Type / Model</b>	<b>REF. NO.</b>	<b>SEM NO.</b>	
	0029907950	11772	
		<b>Description</b>	
		Nut	
			M20x1,5

	SEM NO.		REF. NO.	Type / Model
 M24x2	11774		0019908850	
	<b>Description</b> Nut			
 M24x1,5	11775		0019902151	
	<b>Description</b> Nut			
 D=Ø39 d=Ø23 h=12	11773		0019906382	
	<b>Description</b> Metal Washer			
 D=Ø38 d=Ø24 h=12	11776		3433250070	
	<b>Description</b> Metal Washer			

<b>Type / Model</b>	<b>REF. NO.</b>	<b>SEM NO.</b>	
303 305 307	3013260081	7445	
			<b>Description</b> Stabilizer Bush (Half)
			D=Ø82 d=Ø50 h=80
<b>Type / Model</b>	<b>REF. NO.</b>	<b>SEM NO.</b>	
	3963230050	7504 (7761)	
			<b>Description</b> Stabilizer Bush (Half)
			D=Ø 93 d=Ø 56 h= 70
<b>Type / Model</b>	<b>REF. NO.</b>	<b>SEM NO.</b>	
	3563260081	7680	
			<b>Description</b> Stabilizer Bush (Half)
			D=Ø65 d=Ø37,5 h=60
<b>Type / Model</b>	<b>REF. NO.</b>	<b>SEM NO.</b>	
	4356167220	7906 (1033)	
			<b>Description</b> Rubber Buffer
			D=Ø 145 d=Ø100 h=100
<b>Type / Model</b>	<b>REF. NO.</b>	<b>SEM NO.</b>	
	0019882410	7968	
			<b>Description</b> Stabilizer Bush
			D=Ø75 d=Ø45 h=80 h=70
<b>Type / Model</b>	<b>REF. NO.</b>	<b>SEM NO.</b>	
	6523260381 6523260181 6163260281	7676	
			<b>Description</b> Stabilizer Bush
			D=Ø111 d=Ø65 h=65

	SEM NO.	REF. NO.	Type / Model
 D=Ø75 d=Ø45 h=60	7844	0003264081	
	<b>Description</b> Stabilizer Bushing		







	SEM NO.	REF. NO.	Type / Model
 D=Ø110 d=Ø82 h=65	7861	9413260050 3753260050	
	<b>Description</b> Spring Bushing		







	SEM NO.	REF. NO.	Type / Model
 D=Ø98 d=Ø70 h=67	7963	9413230150 3753230150	
	<b>Description</b> Stabilizer Bush		

	SEM NO.	REF. NO.	Type / Model
 D=Ø88 d=Ø50 h=60	8336	6583260581	
	<b>Description</b> Stabilizer Bushing		







	SEM NO.	REF. NO.	Type / Model
 D=Ø76 d=Ø45 h=70	9400	6283220050	Torismo
	<b>Description</b> Stabilizer Bearing		

	SEM NO.	REF. NO.	Type / Model
 D=Ø76 d=Ø50 h=70	10057	0009924003	
	<b>Description</b> Rubber Metal Bush		







<b>Type / Model</b>	<b>REF. NO.</b>	<b>SEM NO.</b>	
1844	6553260581	7588	
		<b>Description</b>	
		Stabilizer Bush	
			D=Ø91 d=Ø64 h=66
<b>Type / Model</b>	<b>REF. NO.</b>	<b>SEM NO.</b>	
1844	6553260481	7619	
		<b>Description</b>	
		Stabilizer Bush	
			D=Ø91 d=Ø70 h=66
<b>Type / Model</b>	<b>REF. NO.</b>	<b>SEM NO.</b>	
	0003250485 0003250985	8033	
		<b>Description</b>	
		Rubber Buffer	
			D=Ø106 d=Ø148 h=170
<b>Type / Model</b>	<b>REF. NO.</b>	<b>SEM NO.</b>	
	6533260381	7807	
		<b>Description</b>	
		Stabilizer Bush	
			D=Ø60 d=Ø45 h=60,5
<b>Type / Model</b>	<b>REF. NO.</b>	<b>SEM NO.</b>	
	0003262681 0003263281 0003263081 3753260081	7662	
		<b>Description</b>	
		Stabilizer Bush	
			D=Ø66 d=Ø47 h=56
<b>Type / Model</b>	<b>REF. NO.</b>	<b>SEM NO.</b>	
	0003262481 0003232981 0003235985 3753260181	7729	
		<b>Description</b>	
		Stabilizer Bush	
			D=Ø61 d=Ø38,5 h=56

	<b>SEM NO.</b>	<b>REF. NO.</b>	<b>Type / Model</b>
	<b>7931</b>	0003264481 0003264781	
<b>Description</b>			
Stabilizer Bush			
D=Ø82 d=Ø58 h=56			
	<b>SEM NO.</b>	<b>REF. NO.</b>	<b>Type / Model</b>
	<b>7962</b>	0003265081 3753260281	
<b>Description</b>			
Stabilizer Bush			
D=Ø46 d=Ø77 h=56			
	<b>SEM NO.</b>	<b>REF. NO.</b>	<b>Type / Model</b>
	<b>8129</b>	0003265181	
<b>Description</b>			
Stabilizer Bush			
D=Ø77 d=Ø53 h=56			
	<b>SEM NO.</b>	<b>REF. NO.</b>	<b>Type / Model</b>
	<b>8443</b>	0003236285 0003237185	
<b>Description</b>			
Stabilizer Bush			
D=Ø42 d=Ø35 h=55			
	<b>SEM NO.</b>	<b>REF. NO.</b>	<b>Type / Model</b>
	<b>8444</b>	0003235885 0003235385	
<b>Description</b>			
Stabilizer Bush			
D=Ø50 d=Ø35 h=56			
	<b>SEM NO.</b>	<b>REF. NO.</b>	<b>Type / Model</b>
	<b>8772</b>	9703231585	
<b>Description</b>			
Stabilizer Bush			

33x62x47

<b>Type / Model</b>	<b>REF. NO.</b>	<b>SEM NO.</b>	
	9703231785	<b>8783</b>	
		<b>Description</b>	
		Stabilizer Rubber	36x60x47
<b>Type / Model</b>	<b>REF. NO.</b>	<b>SEM NO.</b>	
815 F 816 F	9703231285	<b>8784</b>	
		<b>Description</b>	
		Stabilizer Rubber	25x62x47
<b>Type / Model</b>	<b>REF. NO.</b>	<b>SEM NO.</b>	
	9703231485	<b>11965</b>	
		<b>Description</b>	
		Rubber Bushing	D=Ø53 d=Ø28 L=47
<b>Type / Model</b>	<b>REF. NO.</b>	<b>SEM NO.</b>	
	6733230485	<b>8072</b>	
		<b>Description</b>	
		Stabilizer Rubber	Ø28/60
<b>Type / Model</b>	<b>REF. NO.</b>	<b>SEM NO.</b>	
	6733230385	<b>8073</b>	
		<b>Description</b>	
		Stabilizer Rubber	Ø28/60
<b>Type / Model</b>	<b>REF. NO.</b>	<b>SEM NO.</b>	
	6753231485	<b>8091</b>	
		<b>Description</b>	
		Stabilizer Rubber	Ø35x59,5x82



	<b>SEM NO.</b>	<b>REF. NO.</b>	<b>Type / Model</b>
	8096	6733230685	
<b>Description</b>			
Stabilizer Rubber			
Ø35x60x67			
	<b>SEM NO.</b>	<b>REF. NO.</b>	<b>Type / Model</b>
	8761	6753230485	
<b>Description</b>			
Stabilizer Rubber			
Ø 35			
	<b>SEM NO.</b>	<b>REF. NO.</b>	<b>Type / Model</b>
	8773	6753231585	
<b>Description</b>			
Stabilizer Rubber			
42x89x59			
	<b>SEM NO.</b>	<b>REF. NO.</b>	<b>Type / Model</b>
	8775	6733230585	
<b>Description</b>			
Stabilizer Rubber			
35x68			
	<b>SEM NO.</b>	<b>REF. NO.</b>	<b>Type / Model</b>
	8076	6113260081	
<b>Description</b>			
Stabilizer Rubber			
Ø32,5x47      53x48			
	<b>SEM NO.</b>	<b>REF. NO.</b>	<b>Type / Model</b>
	8077	6013260482	
<b>Description</b>			
Stabilizer Rubber			
Ø24x33      38x34,5			

<b>Type / Model</b>	<b>REF. NO.</b>	<b>SEM NO.</b>	
	9013260081	8078	
		<b>Description</b>	
		Stabilizer Rubber	Ø22x33 38,5x35
<b>Type / Model</b>	<b>REF. NO.</b>	<b>SEM NO.</b>	
	6023260482	8079	
		<b>Description</b>	
		Stabilizer Rubber	Ø30x40 49x45,5
<b>Type / Model</b>	<b>REF. NO.</b>	<b>SEM NO.</b>	
	6023260882	8080	
		<b>Description</b>	
		Stabilizer Rubber	Ø30x49x51
<b>Type / Model</b>	<b>REF. NO.</b>	<b>SEM NO.</b>	
	6023260282	8087	
		<b>Description</b>	
		Stabilizer Rubber	Ø33x49 50x51
<b>Type / Model</b>	<b>REF. NO.</b>	<b>SEM NO.</b>	
	6753230785	8093	
		<b>Description</b>	
		Stabilizer Rubber	Ø34,5x57x60
<b>Type / Model</b>	<b>REF. NO.</b>	<b>SEM NO.</b>	
	9013230185	8763	
		<b>Description</b>	
		Stabilizer Rubber	22x30 30,5x42
<b>Type / Model</b>	<b>REF. NO.</b>	<b>SEM NO.</b>	
	9043230085	8075	
		<b>Description</b>	
		Stabilizer Rubber	Ø25x30 30,5x42

	SEM NO.	REF. NO.	Type / Model
	9017	9013260181	SPRINTER
	<b>Description</b>		
	Stabilizer Rubber		
D=Ø32 d=Ø27 h=38,5			







	SEM NO.	REF. NO.	Type / Model
	8081	3093230385	
	<b>Description</b>		
	Stabilizer Rubber		
Ø29,5x48 50x46,5			







	SEM NO.	REF. NO.	Type / Model
	8084	6673230585	
	<b>Description</b>		
	Stabilizer Rubber		
Ø34,5x50x53			







	SEM NO.	REF. NO.	Type / Model
	8085	6673230485	
	<b>Description</b>		
	Stabilizer Rubber		
Ø29,5x50 56x53			

	SEM NO.	REF. NO.	Type / Model
	8092	6673230685	
	<b>Description</b>		
	Stabilizer Rubber		
D=Ø37 h=50			

	SEM NO.	REF. NO.	Type / Model
	8627	9043261081	
	<b>Description</b>		
	Stabilizer Rubber		
D=Ø46 d=Ø33 h=50			

<b>Type / Model</b>	<b>REF. NO.</b>	<b>SEM NO.</b>	
	9043260981	8767	
			<b>Description</b> Stabilizer Rubber
			30x46/50x54
<b>Type / Model</b>	<b>REF. NO.</b>	<b>SEM NO.</b>	
	9043260881	8768	
			<b>Description</b> Stabilizer Rubber
			27x46/50x54
<b>Type / Model</b>	<b>REF. NO.</b>	<b>SEM NO.</b>	
	9063260781	9024	
			<b>Description</b> Stabilizer Rubber
			d=Ø16 h=45
<b>Type / Model</b>	<b>REF. NO.</b>	<b>SEM NO.</b>	
SPRINTER	9063231685	9025	
			<b>Description</b> Stabilizer Rubber
			d=Ø23 h=45
<b>Type / Model</b>	<b>REF. NO.</b>	<b>SEM NO.</b>	
SPRINTER	9063260481	9026	
			<b>Description</b> Stabilizer Rubber
			Ø 33
<b>Type / Model</b>	<b>REF. NO.</b>	<b>SEM NO.</b>	
SPRINTER	3093230285	9054	
			<b>Description</b> Stabilizer Bearing
			D=Ø46 d=Ø25 h=50

	<b>SEM NO.</b>	<b>REF. NO.</b>	<b>Type / Model</b>
	<b>11269</b>	6383260281	V-KLASSE Vito
	<b>Description</b> Stabilizer Bearing		
D=Ø35 d=Ø13,5 h=46			
	<b>SEM NO.</b>	<b>REF. NO.</b>	<b>Type / Model</b>
	<b>11271</b>	6383230285	SPRINTER V-KLASSE VIANO Vito
	<b>Description</b> Stabilizer Bearing		
D=Ø35 d=Ø24 h=46			
	<b>SEM NO.</b>	<b>REF. NO.</b>	<b>Type / Model</b>
	<b>9052</b>	6673230385	
	<b>Description</b> Stabilizer Bearing		
D=Ø50 d=Ø26 h=51			
	<b>SEM NO.</b>	<b>REF. NO.</b>	<b>Type / Model</b>
	<b>9053</b>	6673230285	
	<b>Description</b> Stabilizer Bearing		
D=Ø50 d=Ø30 h=51			
	<b>SEM NO.</b>	<b>REF. NO.</b>	<b>Type / Model</b>
	<b>8082</b>	3093260281	
	<b>Description</b> Stabilizer Rubber		
Ø33,5xØ45,5 60x85			
	<b>SEM NO.</b>	<b>REF. NO.</b>	<b>Type / Model</b>
	<b>9050</b>	3093260481	
	<b>Description</b> Stabilizer Bearing		
D=Ø47 D=Ø59 d=Ø37 h=84			

<b>Type / Model</b>	<b>REF. NO.</b>	<b>SEM NO.</b>	
	9013230285	8242	
			<b>Description</b> Rubber Bushing
			D=Ø26 d=Ø13,5 h=24
<b>Type / Model</b>	<b>REF. NO.</b>	<b>SEM NO.</b>	
	3093260181	9051	
			<b>Description</b> Stabilizer Bearing
			D=Ø45 d=Ø33 h=68
<b>Type / Model</b>	<b>REF. NO.</b>	<b>SEM NO.</b>	
	6683260181	8083	
			<b>Description</b> Stabilizer Rubber
			Ø41x68,5 80,5
<b>Type / Model</b>	<b>REF. NO.</b>	<b>SEM NO.</b>	
	6673260681	8086	
			<b>Description</b> Stabilizer Rubber
			Ø46x80x80
<b>Type / Model</b>	<b>REF. NO.</b>	<b>SEM NO.</b>	
	6693260081	8088	
			<b>Description</b> Stabilizer Rubber
			Ø50x Ø68 80x80
<b>Type / Model</b>	<b>REF. NO.</b>	<b>SEM NO.</b>	
	6673260181	8097	
			<b>Description</b> Stabilizer Rubber
			Ø45x59 70x79

	SEM NO.	REF. NO.	Type / Model
	8762	6673260081	
	<b>Description</b>		
	Stabilizer Rubber		
36x68,5x80,5			





	SEM NO.	REF. NO.	Type / Model
	9027	6673261381	SPRINTER
	<b>Description</b>		
	Stabilizer Rubber		
D=Ø74 d=Ø41 h=60			

	SEM NO.	REF. NO.	Type / Model
	11273	6703230385	VARIO T2/LN1
	<b>Description</b>		
	Stabilizer Bearing		
d=Ø40 h=53			







	SEM NO.	REF. NO.	Type / Model
	11274	6673261481	100D
	<b>Description</b>		
	Stabilizer Bearing		
d=Ø46 h=60			







	SEM NO.	REF. NO.	Type / Model
	11272	6673261081	VARIO ATEGO
	<b>Description</b>		
	Stabilizer Bearing		
d=Ø46 h=60			







	SEM NO.	REF. NO.	Type / Model
	11793	6673260981	
	<b>Description</b>		
	Stabilizer Bearing		
d=Ø41 L=60			

<b>Type / Model</b>	<b>REF. NO.</b>	<b>SEM NO.</b>	
	6733260681 6733260181	<b>8089</b>	
		<b>Description</b>	
		Stabilizer Rubber	
			Ø39x58 63x46
<b>Type / Model</b>	<b>REF. NO.</b>	<b>SEM NO.</b>	
	6733260781 6733260381	<b>8090</b>	
		<b>Description</b>	
		Stabilizer Rubber	
			Ø45x58 63x46
<b>Type / Model</b>	<b>REF. NO.</b>	<b>SEM NO.</b>	
	6753231885	<b>8098</b>	
		<b>Description</b>	
		Stabilizer Rubber	
			Ø35x66 71x59
<b>Type / Model</b>	<b>REF. NO.</b>	<b>SEM NO.</b>	
	6753231285	<b>8099</b>	
		<b>Description</b>	
		Stabilizer Rubber	
			Ø35x66 71x59
<b>Type / Model</b>	<b>REF. NO.</b>	<b>SEM NO.</b>	
	6733260281 6733260581	<b>8764</b>	
		<b>Description</b>	
		Stabilizer Rubber	
			36x58x62
<b>Type / Model</b>	<b>REF. NO.</b>	<b>SEM NO.</b>	
	6753260681	<b>8765</b>	
		<b>Description</b>	
		Stabilizer Rubber	
			45x60









	<b>SEM NO.</b>	<b>REF. NO.</b>	<b>Type / Model</b>
	8769	6753260781	
<b>Description</b>			
Stabilizer Rubber			
50x66/71x59,5			
	<b>SEM NO.</b>	<b>REF. NO.</b>	<b>Type / Model</b>
	8771	6743260081	
<b>Description</b>			
Stabilizer Rubber			
42x66x60			
	<b>SEM NO.</b>	<b>REF. NO.</b>	<b>Type / Model</b>
	8774	6763260581	
<b>Description</b>			
Stabilizer Rubber			
63x84x60			
	<b>SEM NO.</b>	<b>REF. NO.</b>	<b>Type / Model</b>
	8776	6753231985	
<b>Description</b>			
Stabilizer Rubber			
38x60			
	<b>SEM NO.</b>	<b>REF. NO.</b>	<b>Type / Model</b>
	8777	6753231385	
<b>Description</b>			
Stabilizer Rubber			
42x71x60			
	<b>SEM NO.</b>	<b>REF. NO.</b>	<b>Type / Model</b>
	8779	6763260481 6763260281	
<b>Description</b>			
Stabilizer Rubber			
56x83x60			

<b>Type / Model</b>	<b>REF. NO.</b>	<b>SEM NO.</b>	
	6753231785	<b>8094</b>	
		<b>Description</b>	
		Stabilizer Rubber	
			Ø35x56 67x60
<b>Type / Model</b>	<b>REF. NO.</b>	<b>SEM NO.</b>	
	6753260581 6753260281	<b>8095</b>	
		<b>Description</b>	
		Stabilizer Rubber	
			Ø46,5x56 67x60
<b>Type / Model</b>	<b>REF. NO.</b>	<b>SEM NO.</b>	
	6753260481 6753260181	<b>8766 (8770)</b>	
		<b>Description</b>	
		Stabilizer Rubber	
			40x67x60
<b>Type / Model</b>	<b>REF. NO.</b>	<b>SEM NO.</b>	
	6753231685	<b>8778</b>	
		<b>Description</b>	
		Stabilizer Rubber	
			42x60x56
<b>Type / Model</b>	<b>REF. NO.</b>	<b>SEM NO.</b>	
	6753260981	<b>8780</b>	
		<b>Description</b>	
		Stabilizer Rubber	
			40x60x56
<b>Type / Model</b>	<b>REF. NO.</b>	<b>SEM NO.</b>	
	6743280381	<b>8781</b>	
		<b>Description</b>	
		Stabilizer Rubber	
			46x60x56

	<b>SEM NO.</b> 8782	<b>REF. NO.</b> 6743280281	<b>Type / Model</b>
44x60x56	<b>Description</b> Stabilizer Rubber		
	<b>SEM NO.</b> 9987	<b>REF. NO.</b> 9413230421	<b>Type / Model</b> 3331 4140 AXOR
	<b>Description</b> Torsion Bar to Shackle		
	<b>SEM NO.</b> 9988	<b>REF. NO.</b> 9413230521	<b>Type / Model</b> 3331 4140 ACTROS AXOR
	<b>Description</b> Torsion Bar to Shackle		
	<b>SEM NO.</b> 10830 (9719-10889)	<b>REF. NO.</b> 9433260164	<b>Type / Model</b> 3331 4140 AXOR ACTROS
	<b>Description</b> Torsion Bar to Shackle		
	<b>SEM NO.</b> 10890	<b>REF. NO.</b> 9433260064	<b>Type / Model</b>
	<b>Description</b> Connection Bearing		
	<b>SEM NO.</b> 7860	<b>REF. NO.</b> 9423260050	<b>Type / Model</b>
	<b>Description</b> Ball Joint		

D=Ø88 d=Ø20,5 Ax=130

Type / Model	REF. NO.	SEM NO.	
	3963260081	7909	 <p><b>Description</b> Stabilizer Bush</p> <p>D=Ø68 d=Ø15 Ax=103</p>
	9423260250	7947	 <p><b>Description</b> Stabilizer Bushing</p> <p>D=Ø75 d=Ø21 Ax=130</p>
	9413230050 3753230050	7964	 <p><b>Description</b> Stabilizer Bush</p> <p>D=Ø73 d=Ø19 Ax=100</p>
	0008902601	10789	 <p><b>Description</b> Repair Kit</p>
200 D W116 280 E W123 280 S W126 300 D 450 SEL 500 SEL	1163336314	7533	 <p><b>Description</b> Rubber Metal Buffer</p> <p>D=Ø52 d=Ø12</p>
	0003301711 9743300111S	7722	 <p><b>Description</b> Bend Sleeve Bush (Kit)</p> <p>D=Ø65,25 d=Ø22 h=60</p>

	SEM NO.	REF. NO.	Type / Model
 D=Ø82 d=Ø55 h=40	<b>7914</b>	3173331164 3173330964	
	<b>Description</b>		
			Bush







	SEM NO.	REF. NO.	Type / Model
 D=Ø83 d=Ø55 h=40	<b>7915</b>	3173331164S 3173330964S	
	<b>Description</b>		
			Bush







	SEM NO.	REF. NO.	Type / Model
 D=Ø82 d=Ø55 h=40	<b>8346</b>	3173331164S1 3173330964S1	
	<b>Description</b>		
			Bush







	SEM NO.	REF. NO.	Type / Model
 D=Ø55 d=Ø30 h=32	<b>8494 (9066)</b>	0009816131 0009817431	
	<b>Description</b>		
			Bearing

	SEM NO.	REF. NO.	Type / Model
 D=Ø30 d=Ø12 h=30	<b>8237</b>	3093200073 3143260153 3143260481	
	<b>Description</b>		
			Stabilizer Bushing

	SEM NO.	REF. NO.	Type / Model
 D=Ø32 d=Ø12 h=36	<b>8238</b>	6673200073 9793200173	
	<b>Description</b>		
			Stabilizer Bushing

<b>Type / Model</b>	<b>REF. NO.</b>	<b>SEM NO.</b>	
	6013210350 601321035064	<b>8239</b>	
		<b>Description</b>	
		Stabilizer Bushing	D=Ø26 d=Ø12 h=26
<b>Type / Model</b>	<b>REF. NO.</b>	<b>SEM NO.</b>	
	6023210250 6023210050 6023210450 6023210350	<b>8240</b>	
		<b>Description</b>	
		Stabilizer Bushing	D=Ø26 d=Ø16 h=26
<b>Type / Model</b>	<b>REF. NO.</b>	<b>SEM NO.</b>	
	3183200073	<b>8241</b>	
		<b>Description</b>	
		Stabilizer Bushing	D=Ø40 d=Ø17 h=34
<b>Type / Model</b>	<b>REF. NO.</b>	<b>SEM NO.</b>	
	9743280181	<b>10461</b>	
		<b>Description</b>	
		Rubber Metal Buffer	D=Ø47 d=Ø22 L=40
<b>Type / Model</b>	<b>REF. NO.</b>	<b>SEM NO.</b>	
	9703200237	<b>10667</b>	
		<b>Description</b>	
	1 - 10461	Stabilizer Rod	L=320
<b>Type / Model</b>	<b>REF. NO.</b>	<b>SEM NO.</b>	
	9743201937	<b>10668</b>	
		<b>Description</b>	
	1 - 10461	Stabilizer Rod	L=380

 <p>L=400</p>	<p><b>SEM NO.</b></p> <p><b>10669</b></p>	<p><b>REF. NO.</b></p> <p>9703200437</p>	<p><b>Type / Model</b></p>
	<p><b>Description</b></p> <p>Stabilizer Rod</p>	<p>1 - 10461</p>	
 <p>D=Ø68 d=Ø16 h=60</p>	<p><b>SEM NO.</b></p> <p><b>7675</b></p>	<p><b>REF. NO.</b></p> <p>6533260481 6533260081</p>	<p><b>Type / Model</b></p>
	<p><b>Description</b></p> <p>Stabilizer Bush</p>		
 <p>D=Ø49 d=Ø20 h=40</p>	<p><b>SEM NO.</b></p> <p><b>7843</b></p>	<p><b>REF. NO.</b></p> <p>3563230081</p>	<p><b>Type / Model</b></p>
	<p><b>Description</b></p> <p>Stabilizer Bushing</p>		
 <p>D=Ø70 d=Ø40 h=36,5 h=46</p>	<p><b>SEM NO.</b></p> <p><b>7862</b></p>	<p><b>REF. NO.</b></p> <p>0003237985 0003237585 0003237485 3753230585</p>	<p><b>Type / Model</b></p>
	<p><b>Description</b></p> <p>Spring Bushing</p>		
 <p>D=Ø65 d=Ø40 h=36 h=46</p>	<p><b>SEM NO.</b></p> <p><b>7862-1</b></p>	<p><b>REF. NO.</b></p> <p>0003237985S 0003237585S 0003237485S 3753230585S</p>	<p><b>Type / Model</b></p>
	<p><b>Description</b></p> <p>Spring Bushing (Alternative Design)</p>		
 <p>D=Ø80 d=Ø40 h=46</p>	<p><b>SEM NO.</b></p> <p><b>7965</b></p>	<p><b>REF. NO.</b></p> <p>0003238185</p>	<p><b>Type / Model</b></p>
	<p><b>Description</b></p> <p>Stabilizer Bush</p>		

<b>Type / Model</b>	<b>REF. NO.</b>	<b>SEM NO.</b>	
	0003238185S	7965-1	
			<p><b>Description</b></p> <p>Stabilizer Bush Alternative Design</p> <p>D=Ø75 d=Ø40 h=46</p>
<b>Type / Model</b>	<b>REF. NO.</b>	<b>SEM NO.</b>	
	6583230085	8334	
			<p><b>Description</b></p> <p>Stabilizer Bushing</p> <p>D=Ø68 d=Ø31 h=60</p>
<b>Type / Model</b>	<b>REF. NO.</b>	<b>SEM NO.</b>	
	6553230085	8335	
			<p><b>Description</b></p> <p>Stabilizer Bushing</p> <p>D=Ø71,5 d=Ø48 h=41</p>
<b>Type / Model</b>	<b>REF. NO.</b>	<b>SEM NO.</b>	
	0003262381 0003262281 0003262781	8803	
			<p><b>Description</b></p> <p>Spring Bushing</p> <p>D=Ø60 d=Ø32 h=52</p>
<b>Type / Model</b>	<b>REF. NO.</b>	<b>SEM NO.</b>	
	0003263781 0003263681 0003263881	10884	
			<p><b>Description</b></p> <p>Stabilizer Bush</p> <p>D= Ø60 d=Ø18 h=52</p>
<b>Type / Model</b>	<b>REF. NO.</b>	<b>SEM NO.</b>	
	9603234185 9603231785	11752	
			<p><b>Description</b></p> <p>Rubber Metal Bushing</p>



	SEM NO.	REF. NO.	Type / Model
	7798	3873260281	
	<b>Description</b>		
	Stabilizer Mounting		
D=Ø86 d=Ø46 h=63			







	SEM NO.	REF. NO.	Type / Model
	7803	3873260181	
	<b>Description</b>		
	Stabilizer Mounting		
D=Ø86 d=Ø51 h=63			







	SEM NO.	REF. NO.	Type / Model
	7847	3873230285	
	<b>Description</b>		
	Stabilizer Bushing		
D=Ø70 d=Ø37 h=62			





	SEM NO.	REF. NO.	Type / Model
	8603	3873230385	
	<b>Description</b>		
	Stabilizer Plastic		
D=Ø70 d=Ø40 h=62			







	SEM NO.	REF. NO.	Type / Model
	7942	3933260281	
	<b>Description</b>		
	Stabilizer Mounting		
D=Ø86 d=Ø65 h=90			

	SEM NO.	REF. NO.	Type / Model
	7943	3933260381	
	<b>Description</b>		
	Stabilizer Mounting		
D=Ø86 d=Ø60 h=90			

<b>Type / Model</b>	<b>REF. NO.</b>	<b>SEM NO.</b>	
	3893260081	7944	
			<b>Description</b> Stabilizer Mounting
			D=Ø86 d=Ø70 h=90
<b>Type / Model</b>	<b>REF. NO.</b>	<b>SEM NO.</b>	
	3183210085	8113	
			<b>Description</b> Stabilizer Bearing
			Ø25,5x37,5x55
<b>Type / Model</b>	<b>REF. NO.</b>	<b>SEM NO.</b>	
	3163230185	8114	
			<b>Description</b> Stabilizer Bearing
			Ø29x38 42x56,5
<b>Type / Model</b>	<b>REF. NO.</b>	<b>SEM NO.</b>	
	3143260081	8115	
			<b>Description</b> Stabilizer Bearing
			Ø30x40 56,5
<b>Type / Model</b>	<b>REF. NO.</b>	<b>SEM NO.</b>	
	3163260081	8116	
			<b>Description</b> Stabilizer Bearing
			Ø35x40 62
<b>Type / Model</b>	<b>REF. NO.</b>	<b>SEM NO.</b>	
	3183260081	8117	
			<b>Description</b> Stabilizer Bearing
			Ø38x40 62

 Ø29,5x40 62	<table border="1"> <thead> <tr> <th>SEM NO.</th> <th>REF. NO.</th> <th>Type / Model</th> </tr> </thead> <tbody> <tr> <td>8118</td> <td>3143260381 4213260081</td> <td></td> </tr> <tr> <td colspan="3"><b>Description</b></td> </tr> <tr> <td colspan="3">Stabilizer Bearing</td> </tr> </tbody> </table>	SEM NO.	REF. NO.	Type / Model	8118	3143260381 4213260081		<b>Description</b>			Stabilizer Bearing		
SEM NO.	REF. NO.	Type / Model											
8118	3143260381 4213260081												
<b>Description</b>													
Stabilizer Bearing													
 D=Ø56 d=Ø44 h=25	<table border="1"> <thead> <tr> <th>SEM NO.</th> <th>REF. NO.</th> <th>Type / Model</th> </tr> </thead> <tbody> <tr> <td>7799</td> <td>6203230350</td> <td></td> </tr> <tr> <td colspan="3"><b>Description</b></td> </tr> <tr> <td colspan="3">Stabilizer Bushing</td> </tr> </tbody> </table>	SEM NO.	REF. NO.	Type / Model	7799	6203230350		<b>Description</b>			Stabilizer Bushing		
SEM NO.	REF. NO.	Type / Model											
7799	6203230350												
<b>Description</b>													
Stabilizer Bushing													
 D=Ø70 d=Ø58,5 h=19	<table border="1"> <thead> <tr> <th>SEM NO.</th> <th>REF. NO.</th> <th>Type / Model</th> </tr> </thead> <tbody> <tr> <td>7800</td> <td>6203230150</td> <td></td> </tr> <tr> <td colspan="3"><b>Description</b></td> </tr> <tr> <td colspan="3">Stabilizer Bushing</td> </tr> </tbody> </table>	SEM NO.	REF. NO.	Type / Model	7800	6203230150		<b>Description</b>			Stabilizer Bushing		
SEM NO.	REF. NO.	Type / Model											
7800	6203230150												
<b>Description</b>													
Stabilizer Bushing													
 D=Ø35 d=Ø25 h=25	<table border="1"> <thead> <tr> <th>SEM NO.</th> <th>REF. NO.</th> <th>Type / Model</th> </tr> </thead> <tbody> <tr> <td>7848</td> <td>6203230250</td> <td></td> </tr> <tr> <td colspan="3"><b>Description</b></td> </tr> <tr> <td colspan="3">Bush</td> </tr> </tbody> </table>	SEM NO.	REF. NO.	Type / Model	7848	6203230250		<b>Description</b>			Bush		
SEM NO.	REF. NO.	Type / Model											
7848	6203230250												
<b>Description</b>													
Bush													
 D=Ø44 d=Ø32 h=25	<table border="1"> <thead> <tr> <th>SEM NO.</th> <th>REF. NO.</th> <th>Type / Model</th> </tr> </thead> <tbody> <tr> <td>7849</td> <td>0003232150</td> <td></td> </tr> <tr> <td colspan="3"><b>Description</b></td> </tr> <tr> <td colspan="3">Bush</td> </tr> </tbody> </table>	SEM NO.	REF. NO.	Type / Model	7849	0003232150		<b>Description</b>			Bush		
SEM NO.	REF. NO.	Type / Model											
7849	0003232150												
<b>Description</b>													
Bush													
 D=Ø35 d=Ø25 h=30	<table border="1"> <thead> <tr> <th>SEM NO.</th> <th>REF. NO.</th> <th>Type / Model</th> </tr> </thead> <tbody> <tr> <td>7945</td> <td>6203230050</td> <td></td> </tr> <tr> <td colspan="3"><b>Description</b></td> </tr> <tr> <td colspan="3">Bearing</td> </tr> </tbody> </table>	SEM NO.	REF. NO.	Type / Model	7945	6203230050		<b>Description</b>			Bearing		
SEM NO.	REF. NO.	Type / Model											
7945	6203230050												
<b>Description</b>													
Bearing													

<b>Type / Model</b>	<b>REF. NO.</b>	<b>SEM NO.</b>	
	0003230950	<b>7946</b>	
		<b>Description</b>	
		Bearing	
			D=Ø35 d=Ø25 h=28
<b>Type / Model</b>	<b>REF. NO.</b>	<b>SEM NO.</b>	
	9413230350	<b>8149</b>	
		<b>Description</b>	
		Plastic Bearing	
			D=Ø52 d=Ø40 h=24
<b>Type / Model</b>	<b>REF. NO.</b>	<b>SEM NO.</b>	
	3873260050	<b>8983</b>	
		<b>Description</b>	
		Plastic Bearing	
			D=Ø44 d=Ø37 h=37
<b>Type / Model</b>	<b>REF. NO.</b>	<b>SEM NO.</b>	
	0003260650	<b>8984</b>	
		<b>Description</b>	
		Plastic Bearing	
			D=Ø52 d=Ø40 h=25
<b>Type / Model</b>	<b>REF. NO.</b>	<b>SEM NO.</b>	
	0003260250	<b>9056</b>	
		<b>Description</b>	
		Stabilizer Bearing	
			D=Ø44 d=Ø32 h=35
<b>Type / Model</b>	<b>REF. NO.</b>	<b>SEM NO.</b>	
	9413260350	<b>8040</b>	
		<b>Description</b>	
		Bush	
			D=Ø65 d=Ø40 h=45

	SEM NO.	REF. NO.	Type / Model
 <p>D=Ø174 d=Ø137 h=10</p>	<b>8127</b>	9473250050	
	<b>Description</b>		
	Stabilizer Bush		
	SEM NO.	REF. NO.	Type / Model
 <p>D=Ø40 h=Ø25</p>	<b>8233</b>	3603230460	
	<b>Description</b>		
	Pur Ring		
	SEM NO.	REF. NO.	Type / Model
 <p>D=Ø65 d=Ø41 h=16</p>	<b>8234</b>	3603230560	
	<b>Description</b>		
	Pur Ring		
	SEM NO.	REF. NO.	Type / Model
 <p>D=65 d=36 h=27</p>	<b>8017</b>	3803230160	
	<b>Description</b>		
	Pu Ring		
	SEM NO.	REF. NO.	Type / Model
 <p>D=65 d=36 h=28</p>	<b>8018</b>	3803230260	
	<b>Description</b>		
	Pu Ring		
	SEM NO.	REF. NO.	Type / Model
 <p>M14x1,5</p>	<b>11749</b>	 6213230174	
	<b>Description</b>		
	Metal Pin		

Model:	SEM NO.	Description / Stabilizer Repair Kit
	<b>7788</b>	
	REF. NO: 6213200428	
	<b>7789</b>	
	REF. NO: 6253200111	
	<b>7790</b>	
	REF. NO: 6553200111	
	<b>7845</b>	
	REF. NO: 6203200628 6193200128	

Description / Stabilizer Repair Kit	SEM NO.	Model:
-------------------------------------	---------	--------

7923

REF. NO: 6523200511

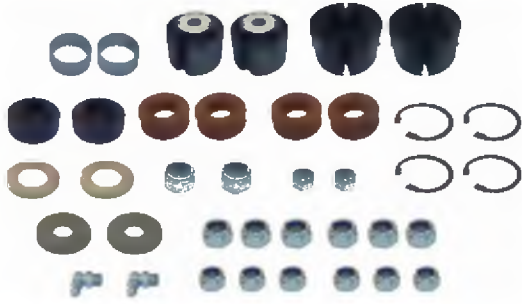

Description / Stabilizer Repair Kit	SEM NO.	Model:
-------------------------------------	---------	--------

7924

REF. NO: 6213200011



Description / Stabilizer Repair Kit	SEM NO.	Model:
-------------------------------------	---------	--------

7925

REF. NO: 6203200111



Description / Stabilizer Repair Kit	SEM NO.	Model:
-------------------------------------	---------	--------

7926



REF. NO: 3933200428  
3935860532





Model:	SEM NO.	Description / Stabilizer Repair Kit
	<p><b>7927</b></p> <p>REF. NO: 3873200328 3875860332</p>	
	<p><b>7928</b></p> <p>REF. NO: 3803200028 3805860032</p>	
	<p><b>7929</b></p> <p>REF. NO: 6213200128</p>	
	<p><b>7937</b></p> <p>REF. NO: 6253200611</p>	

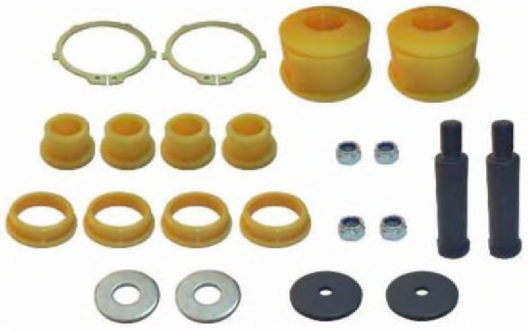

Description / Stabilizer Repair Kit	SEM NO.	Model:
	<p><b>7938</b></p> <p>REF. NO: 6473200028</p>	
	<p><b>7939</b></p> <p>REF. NO: 6203200428 6203200232 6205860232</p>	
	<p><b>7940</b></p> <p>REF. NO: 6203200228 6205860032</p>	
	<p><b>7941</b></p> <p>REF. NO: 6203200328 6205860132</p>	

Model:	SEM NO.	Description / Stabilizer Repair Kit
UNIMOG	8529	

REF. NO:  
4353200428



Model:	SEM NO.	Description / Stabilizer Repair Kit
	8969	

REF. NO:  
6203200028



Model:	SEM NO.	Description / Stabilizer Repair Kit
	9101	

REF. NO:  
6203200128



Model:	SEM NO.	Description / Stabilizer Repair Kit
	9102	

REF. NO:  
6173200128



Description / Stabilizer Repair Kit	SEM NO.	Model:
-------------------------------------	---------	--------

9103

REF. NO: 6173200611



Description / Stabilizer Repair Kit	SEM NO.	Model:
-------------------------------------	---------	--------

9104

REF. NO: 3933200328  
3935860432

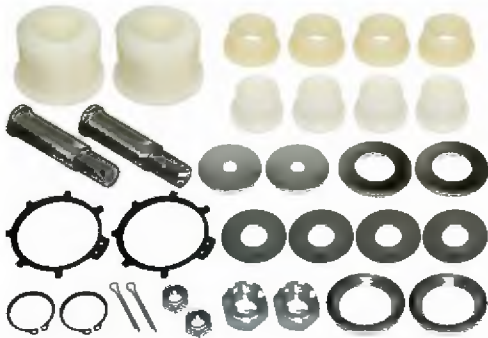

Description / Stabilizer Repair Kit	SEM NO.	Model:
-------------------------------------	---------	--------

9105

REF. NO: 3873200428  
3875860432



Description / Stabilizer Repair Kit	SEM NO.	Model:
-------------------------------------	---------	--------

9106

REF. NO: 3603200341  
3605860332  
3523260274



Model:	SEM NO.	Description / Stabilizer Repair Kit
	9107	
	REF. NO: 3873200528 3875860532	
	9108	
	REF. NO: 6173200028 6173200228	
	9110	
	REF. NO: 3603200041 3605860032	
	9109	
	REF. NO: 6683200511	



Description / Stabilizer Repair Kit	SEM NO.	Model:
-------------------------------------	---------	--------

9111



REF. NO: 6013200711  
6013200083  
6015860032

Description / Stabilizer Repair Kit	SEM NO.	Model:
-------------------------------------	---------	--------

9112



REF. NO: 6013200183  
6015860132

Description / Stabilizer Repair Kit	SEM NO.	Model:
-------------------------------------	---------	--------

9113



REF. NO: 6013200411





Description / Stabilizer Repair Kit	SEM NO.	Model:
-------------------------------------	---------	--------

9114



REF. NO: 3093200528  
3095860432

Model:	SEM NO.	Description / Stabilizer Repair Kit
	9115	
	REF. NO: 3093200228 3095860132	
Model:	SEM NO.	Description / Stabilizer Repair Kit
	9116	
	REF. NO: 3093200428 3095860332	
Model:	SEM NO.	Description / Stabilizer Repair Kit
	9117	
	REF. NO: 3093200128	
Model:	SEM NO.	Description / Stabilizer Repair Kit
	9118	
	REF. NO: 6703201811	

Description / Stabilizer Repair Kit	SEM NO.	Model:
	<p><b>9119</b></p> <p>REF. NO: 6703201411</p>	
	<p><b>9120</b></p> <p>REF. NO: 6703201211</p>	
	<p><b>9121</b></p> <p>REF. NO: 6683200411</p>	
	<p><b>9122</b></p> <p>REF. NO: 6673205111</p>	

Model:	SEM NO.	Description / Stabilizer Repair Kit
	9123	
	REF. NO: 6673204711	
	9124	
	REF. NO: 6673204311	
	9125	
	REF. NO: 6673204211	
	9126	
	REF. NO: 6113200311	





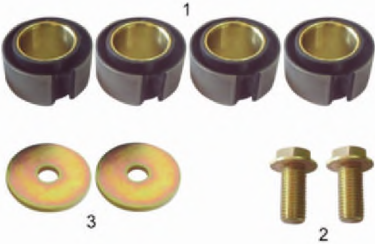

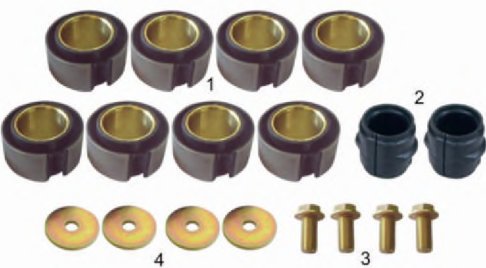

Description / Stabilizer Repair Kit	SEM NO.	Model:
	<b>9127</b>	
	<b>REF. NO:</b> 3093200028 3095860232	

Description / Stabilizer Repair Kit	SEM NO.	Model:							
	<b>7998</b>								
	<b>REF. NO:</b> 0003237985S3 0003237585S3 0003237485S3 3753230585S3	<table border="1"> <thead> <tr> <th>Item No</th> <th>Ref. No</th> </tr> </thead> <tbody> <tr> <td>1</td> <td>0003237985</td> </tr> <tr> <td>2</td> <td>910105016013</td> </tr> <tr> <td>3</td> <td>9433230152</td> </tr> </tbody> </table>	Item No	Ref. No	1	0003237985	2	910105016013	3
Item No	Ref. No								
1	0003237985								
2	910105016013								
3	9433230152								

Description / Stabilizer Repair Kit	SEM NO.	Model:							
	<b>7999</b>								
	<b>REF. NO:</b> 0003237985S2 0003237585S2 0003237485S2 3753230585S2	<table border="1"> <thead> <tr> <th>Item No</th> <th>Ref. No</th> </tr> </thead> <tbody> <tr> <td>1</td> <td>0003237985</td> </tr> <tr> <td>2</td> <td>910105016013</td> </tr> <tr> <td>3</td> <td>9433230152</td> </tr> </tbody> </table>	Item No	Ref. No	1	0003237985	2	910105016013	3
Item No	Ref. No								
1	0003237985								
2	910105016013								
3	9433230152								

Description / Stabilizer Repair Kit	SEM NO.	Model:									
	<b>8000</b>										
	<b>REF. NO:</b> 0003237985S1 0003237585S1 0003237485S1 3753230585S1	<table border="1"> <thead> <tr> <th>Item No</th> <th>Ref. No</th> </tr> </thead> <tbody> <tr> <td>1</td> <td>0003237985</td> </tr> <tr> <td>2</td> <td>0003262481</td> </tr> <tr> <td>3</td> <td>910105016013</td> </tr> <tr> <td>4</td> <td>9433230152</td> </tr> </tbody> </table>	Item No	Ref. No	1	0003237985	2	0003262481	3	910105016013	4
Item No	Ref. No										
1	0003237985										
2	0003262481										
3	910105016013										
4	9433230152										

Model:	SEM NO.	Description / Stabilizer Repair Kit
1 - 7862 2 - 8040 3 - 7729 4 - 8149	9436  <b>REF. NO:</b> 0003237985S4 0003237585S4 0003237485S4 3753230585S4	

	SEM NO.	REF. NO.	Type / Model
 2,975 kg	<b>10062</b>	9433230111 9433230516	
	<b>Description</b>		
			Stabilizer Rod
 3,088 kg	<b>10063</b>	9433230211 9433230616	
	<b>Description</b>		
			Stabilizer Rod
 2,370 kg	<b>10064</b>	9433260447	
	<b>Description</b>		
			Stabilizer Rod
 1	<b>10068</b>	9433230111S 9433230516S	
	<b>Description</b>		
			Stabilizer Rod
			1- 7862 Page 328
 1	<b>10069</b>	9433230211S 9433230616S	
	<b>Description</b>		
			Stabilizer Rod
			1- 7862 Page 328
 1	<b>10070</b>	9433260447S	
	<b>Description</b>		
			Stabilizer Rod
			1- 7862 Page 328

<p><b>Type / Model</b></p> <p>1-7862 2-10062</p>	<p><b>REF. NO.</b></p> <p>9433230111S1 9433230516S1</p> <p><b>SEM NO.</b></p> <p>10297</p> <p><b>Description</b></p> <p>Repair Kit</p>	
<p><b>Type / Model</b></p> <p>1-7862 2-10063</p>	<p><b>REF. NO.</b></p> <p>9433230211S1 9433230616S1</p> <p><b>SEM NO.</b></p> <p>10298</p> <p><b>Description</b></p> <p>Repair Kit</p>	
<p><b>Type / Model</b></p> <p>1-7862 2-10064</p>	<p><b>REF. NO.</b></p> <p>9433260447S1</p> <p><b>SEM NO.</b></p> <p>10299</p> <p><b>Description</b></p> <p>Repair Kit</p>	
<p><b>Type / Model</b></p>	<p><b>REF. NO.</b></p> <p>9493230011</p> <p><b>SEM NO.</b></p> <p>10417</p> <p><b>Description</b></p> <p>Stabilizer Rod</p>	<p style="text-align: right;">Ax=380</p>
<p><b>Type / Model</b></p>	<p><b>REF. NO.</b></p> <p>9493230011S</p> <p><b>SEM NO.</b></p> <p>10418</p> <p><b>Description</b></p> <p>Stabilizer Rod</p>	<p style="text-align: right;">Ax=380</p>
<p><b>Type / Model</b></p> <p>1-10417 2-7862</p>	<p><b>REF. NO.</b></p> <p>9493230011S1</p> <p><b>SEM NO.</b></p> <p>10419</p> <p><b>Description</b></p> <p>Repair Kit</p>	<p style="text-align: right;">Ax=380</p>

	SEM NO.	REF. NO.	Type / Model
	10420	9483260547	
	<b>Description</b> Stabilizer Rod		
Ax=365			







	SEM NO.	REF. NO.	Type / Model
	10421	9483260547S	
	<b>Description</b> Stabilizer Rod		
Ax=365			

	SEM NO.	REF. NO.	Type / Model
	10676	9483260347 9433260347	
	<b>Description</b> Stabilizer Rod		
Ax=280			

	SEM NO.	REF. NO.	Type / Model
	10677	9483260347S 9433260347S	
	<b>Description</b> Stabilizer Rod		
Ax=280			1 - 7965 Page 328

	SEM NO.	REF. NO.	Type / Model
	10834	9483260447	
	<b>Description</b> Stabilizer Rod		
Ax=340			

	SEM NO.	REF. NO.	Type / Model
	10835	9483260447S	
	<b>Description</b> Stabilizer Rod		
Ax=340			1 - 7965 Page 328

<p>Type / Model</p> <p>1 - 7965 Page 328</p>	<p>REF. NO.</p> <p>9483260647</p>	<p>SEM NO.</p> <p>10843</p>	<p>Description</p> <p>Stabilizer Rod</p>  <p>L= 420</p>
<p>Type / Model</p> <p>1 - 7965 Page 328</p>	<p>REF. NO.</p> <p>9483260647S</p>	<p>SEM NO.</p> <p>10844</p>	<p>Description</p> <p>Stabilizer Rod</p>  <p>L= 420</p>
<p>Type / Model</p>	<p>REF. NO.</p> <p>9433260747</p>	<p>SEM NO.</p> <p>12164</p> <p><i>new product</i></p>	<p>Description</p> <p>Stabilizer Rod</p>  <p>Ax= 280</p>
<p>Type / Model</p> <p>1 - 7862 Page 328</p>	<p>REF. NO.</p> <p>9433260747S</p>	<p>SEM NO.</p> <p>12165</p> <p><i>new product</i></p>	<p>Description</p> <p>Stabilizer Rod</p>  <p>Ax= 280</p>
<p>Type / Model</p>	<p>REF. NO.</p> <p>9413230163</p>	<p>SEM NO.</p> <p>10065</p>	<p>Description</p> <p>Stabilizer Rod Bracket</p>  <p>2,000 kg</p>
<p>Type / Model</p>	<p>REF. NO.</p> <p>9413230463</p>	<p>SEM NO.</p> <p>10066</p>	<p>Description</p> <p>Stabilizer Rod Bracket</p>  <p>3,985 kg</p>



2,875 kg

**SEM NO.**

**10067**

**REF. NO.**







**3753260063**







**Type / Model**

**Description**







Stabilizer Rod Bracket





Type / Model	REF. NO.	SEM NO.	
403	0003302611 0003302511	7596	 <p><b>Description</b> Ball Joint (Kit)</p> <p>D=Ø56 d=Ø15 Ax=90</p>
403	0003501005	7610	 <p><b>Description</b> Ball Joint (Kit)</p> <p>D=Ø67 d=Ø15 Ax=115</p>
	0003300511 0003302211	7615 (9203)	 <p><b>Description</b> Ball Joint (Kit)</p> <p>D=Ø67 d=Ø19 Ax=130</p>
	0003301411	7679	 <p><b>Description</b> Ball Joint (Kit)</p> <p>D=Ø67 d=Ø17 Ax=100</p>
	0003502005	8179	 <p><b>Description</b> Ball Joint (Kit)</p> <p>D=Ø67 d=Ø23 Ax=130</p>
	0003504705	9036	 <p><b>Description</b> Ball Joint (Kit)</p> <p>D=Ø67 d=Ø23 Ax=130</p>





	SEM NO.	REF. NO.	Type / Model
 <p>D=Ø67 d=Ø17 Ax=115</p>	9072	4443330127	
<b>Description</b>			
Ball Joint (Kit)			
	SEM NO.	REF. NO.	Type / Model
 <p>D=Ø67 d=Ø17 Ax=115</p>	9080	0003302111	
<b>Description</b>			
Ball Joint (Kit)			
	SEM NO.	REF. NO.	Type / Model
 <p>D=Ø75 d=Ø17 Ax=115</p>	7595	0003300707	
<b>Description</b>			
Ball Joint (Kit)			
	SEM NO.	REF. NO.	Type / Model
 <p>D=Ø75 d=Ø17 Ax=130</p>	7613	0003501305	403
<b>Description</b>			
Ball Joint (Kit)			
	SEM NO.	REF. NO.	Type / Model
 <p>D=Ø75 d=Ø19 Ax=126</p>	7614	0003300410 0003501205	
<b>Description</b>			
Ball Joint (Kit)			
	SEM NO.	REF. NO.	Type / Model
 <p>D=Ø75 d=Ø25 Ax=130</p>	7628	0003502505 0003503405	
<b>Description</b>			
Ball Joint (Kit)			





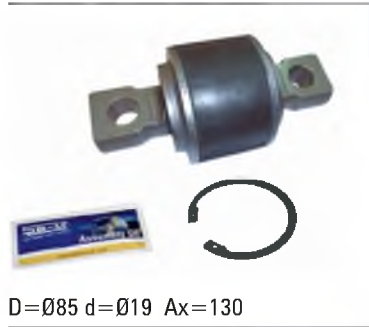

<b>Type / Model</b>	<b>REF. NO.</b>	<b>SEM NO.</b>	
	0003300207	7635	
			<b>Description</b> Ball Joint (Kit) D=Ø75 d=Ø19 Ax=130
<b>Type / Model</b>	<b>REF. NO.</b>	<b>SEM NO.</b>	
		7636	
			<b>Description</b> Ball Joint (Kit) D=Ø75 d=Ø21 Ax=130
<b>Type / Model</b>	<b>REF. NO.</b>	<b>SEM NO.</b>	
	3133330104 0003300210	7656	
			<b>Description</b> Ball Joint (Kit) D=Ø75 d=Ø15 Ax=115
<b>Type / Model</b>	<b>REF. NO.</b>	<b>SEM NO.</b>	
	6293300007	7949	
			<b>Description</b> Ball Joint (Kit) D=Ø75 d=Ø19 Ax=115
<b>Type / Model</b>	<b>REF. NO.</b>	<b>SEM NO.</b>	
	6293300407 6293300807 6293300907 0003503205	7950	
			<b>Description</b> Ball Joint (Kit) D=Ø75 d=Ø25 Ax=130
<b>Type / Model</b>	<b>REF. NO.</b>	<b>SEM NO.</b>	
	0003502105	7644	
			<b>Description</b> Ball Joint (Kit) D=Ø75 d=Ø25 Ax=152

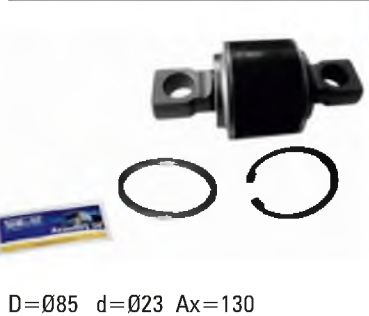
	SEM NO.	REF. NO.	Type / Model
 <p>D=Ø75 d=Ø25 Ax=130</p>	<b>7916</b>	0003502205	
<p><b>Description</b> Ball Joint (Kit)</p>			
 <p>D=Ø75 d=Ø19 Ax=130</p>	<b>9083</b>	0003302011	
<p><b>Description</b> Ball Joint (Kit)</p>			
 <p>D=Ø75 d=Ø25 Ax=152</p>	<b>9088</b>	0003504605	
<p><b>Description</b> Ball Joint (Kit)</p>			
 <p>D=Ø75 d=Ø21 Ax=152</p>	<b>9091</b>	0003502605	
<p><b>Description</b> Ball Joint (Kit)</p>			
 <p>D=Ø75 d=Ø25 Ax=130</p>	<b>9594</b>	0003504505	
<p><b>Description</b> Ball Joint (Kit)</p>			
 <p>D=Ø80 d=Ø21 Ax=152</p>	<b>7431</b>	0003500213S 0003500305S 0005861433S 0003500505S	Alternative Rubber Type
<p><b>Description</b> Ball Joint (Kit)</p>			



<b>Type / Model</b>	<b>REF. NO.</b>	<b>SEM NO.</b>	 <p><b>Description</b> Ball Joint (Kit)</p> <p>D=Ø85 d=Ø25 Ax=152</p>
TRAVEGO		1105	
<b>Type / Model</b>	<b>REF. NO.</b>	<b>SEM NO.</b>	 <p><b>Description</b> Ball Joint (Kit)</p> <p>D=Ø85 d=Ø19 Ax=130</p>
	0003500506	7335 (7593)	
<b>Type / Model</b>	<b>REF. NO.</b>	<b>SEM NO.</b>	 <p><b>Description</b> Ball Joint (Kit)</p> <p>D=Ø85 d=Ø21 Ax=152</p>
	0005861135 0003500613	7432	
<b>Type / Model</b>	<b>REF. NO.</b>	<b>SEM NO.</b>	 <p><b>Description</b> Ball Joint (Kit)</p> <p>D=Ø85 d=Ø16 Ax=130</p>
	0003300075	7767	
<b>Type / Model</b>	<b>REF. NO.</b>	<b>SEM NO.</b>	 <p><b>Description</b> Ball Joint (Kit)</p> <p>D=Ø85 d=Ø21 Ax=152</p>
	0003502705	8226 (7432)	
<b>Type / Model</b>	<b>REF. NO.</b>	<b>SEM NO.</b>	 <p><b>Description</b> Ball Joint (Kit)</p> <p>D=Ø85 d=Ø21&amp;26 Ax=152</p>
	0003501805	9634	



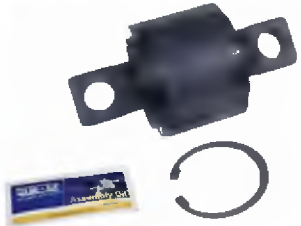





 <p>D=Ø85 d=Ø23 Ax=130</p>	<p><b>SEM NO.</b> <b>10205</b></p> <p><b>Description</b> Ball Joint (Kit)</p>	<p><b>REF. NO.</b> 3753500605S2</p>	<p><b>Type / Model</b></p>
 <p>D=Ø85 d=Ø25 Ax=152</p>	<p><b>SEM NO.</b> <b>7627</b></p> <p><b>Description</b> Ball Joint (Kit)</p>	<p><b>REF. NO.</b> 0003503105</p>	<p><b>Type / Model</b></p>
 <p>D=Ø85 d=Ø25 Ax=130</p>	<p><b>SEM NO.</b> <b>7850 (8491)</b></p> <p><b>Description</b> Ball Joint (Kit)</p>	<p><b>REF. NO.</b> 0003502805</p>	<p><b>Type / Model</b></p>
 <p>D=Ø85 d=Ø19 Ax=130</p>	<p><b>SEM NO.</b> <b>7919 (8019)</b></p> <p><b>Description</b> Ball Joint (Kit)</p>	<p><b>REF. NO.</b> 0003501513</p>	<p><b>Type / Model</b></p>
 <p>D=Ø85 d=Ø25 Ax=152</p>	<p><b>SEM NO.</b> <b>7954</b></p> <p><b>Description</b> Ball Joint (Kit)</p>	<p><b>REF. NO.</b> 0003502305 0003504005</p>	<p><b>Type / Model</b></p>
 <p>D=Ø85 d=Ø23 Ax=130</p>	<p><b>SEM NO.</b> <b>7959</b></p> <p><b>Description</b> Ball Joint (Kit)</p>	<p><b>REF. NO.</b> 0003504805 0003503305</p>	<p><b>Type / Model</b></p>

<b>Type / Model</b>	<b>REF. NO.</b>	<b>SEM NO.</b>	
	0003503705	<b>7981</b>	 <p><b>Description</b> Ball Joint (Kit)</p> <p>D=Ø85 d=Ø23 Ax=130</p>
<b>Type / Model</b>	<b>REF. NO.</b>	<b>SEM NO.</b>	
	0003300611 0003500906	<b>8216 (7960-9443)</b>	 <p><b>Description</b> Ball Joint (Kit)</p> <p>D=Ø85 d=Ø19 Ax=130</p>
<b>Type / Model</b>	<b>REF. NO.</b>	<b>SEM NO.</b>	
	0003504405	<b>9089</b>	 <p><b>Description</b> Ball Joint (Kit)</p> <p>D=Ø85 d=Ø25 Ax=152</p>
<b>Type / Model</b>	<b>REF. NO.</b>	<b>SEM NO.</b>	
	0003520127	<b>12044</b>	  <p><b>Description</b> Ball Joint</p> <p>D=Ø91 d=Ø19 Ax=130</p>
<b>Type / Model</b>	<b>REF. NO.</b>	<b>SEM NO.</b>	
1735 1748 1831 1838 1929 2426 2429 2433 2435 2629 2631 2635	0003500413 0005861235	<b>7550</b>	 <p><b>Description</b> Ball Joint (Kit)</p> <p>D=Ø95 d=Ø21 Ax=152</p>
<b>Type / Model</b>	<b>REF. NO.</b>	<b>SEM NO.</b>	
	0003502405 0003503505	<b>7682 (7878)</b>	 <p><b>Description</b> Ball Joint (Kit)</p> <p>D=Ø100 d=Ø25 Ax=152</p>



	SEM NO.	REF. NO.	Type / Model
 <p>D=Ø100 d=Ø25 Ax=152</p>	<b>9090</b>	0003504905	
<b>Description</b>			
Ball Joint (Kit)			
	SEM NO.	REF. NO.	Type / Model
 <p>D=Ø107,5 d=Ø21 Ax=152</p>	<b>7651</b>	0003500113	
<b>Description</b>			
Ball Joint (Kit)			
	SEM NO.	REF. NO.	Type / Model
 <p>D=Ø107,5 d=Ø25 Ax=152</p>	<b>10204</b>	3753500605S1	
<b>Description</b>			
Ball Joint (Kit)			
	SEM NO.	REF. NO.	Type / Model
 <p>D=Ø108 d=Ø25 Ax=152</p>	<b>7982</b>	0003503605	
<b>Description</b>			
Ball Joint (Kit)			
	SEM NO.	REF. NO.	Type / Model
 <p>D=Ø108 d=Ø25 Ax=152</p>	<b>10079</b>	0003502905	
<b>Description</b>			
Ball Joint (Kit)			
	SEM NO.	REF. NO.	Type / Model
 <p>D=Ø95 L=73</p>	<b>7611</b>	0003500905	
<b>Description</b>			
Ball Joint (Kit)			

<b>Type / Model</b>	<b>REF. NO.</b>	<b>SEM NO.</b>	 D=Ø95 L=73
	0003501905	9076 (7955)	
<b>Description</b>			Ball Joint (Kit)
<b>Type / Model</b>	<b>REF. NO.</b>	<b>SEM NO.</b>	 D=Ø108 d=Ø36 L=67
	0003501705	7774	
<b>Description</b>			Ball Joint (Kit)
<b>Type / Model</b>	<b>REF. NO.</b>	<b>SEM NO.</b>	 Alternatively Rubber Type D=Ø 80
911 BL 1113 LAK 1418 LPS 1813 L 2219 LP 2624 L	3435860032S 0005861633S	8371	
<b>Description</b>			Ball Joint (Kit)
<b>Type / Model</b>	<b>REF. NO.</b>	<b>SEM NO.</b>	 D=Ø85 L=250
345	0003300407	7594	
<b>Description</b>			Ball Joint (Kit)
<b>Type / Model</b>	<b>REF. NO.</b>	<b>SEM NO.</b>	 D=Ø85 d=Ø54 L=170
	6293300107 6293301007	7951	
<b>Description</b>			Ball Joint (Kit)
<b>Type / Model</b>	<b>REF. NO.</b>	<b>SEM NO.</b>	 D=Ø85 L=171
	0003501013	8530	
<b>Description</b>			Ball Joint (Kit)



D=Ø85 L=250 Cone=48

SEM NO.	REF. NO.	Type / Model
9098 (9099)	0003300107	
<b>Description</b>		
Ball Joint (Kit)		



D=Ø77 d=Ø28 Ax=62

SEM NO.	REF. NO.	Type / Model
7773	0003300811	
<b>Description</b>		
Stabilizer Bush		



D=Ø77 d=Ø24 h=96

SEM NO.	REF. NO.	Type / Model
9615	0003310017	
<b>Description</b>		
Stabilizer Bush		



D=Ø87 h=70

SEM NO.	REF. NO.	Type / Model
7772	0003301611	
<b>Description</b>		
Stabilizer Bush		



D=Ø91 d=Ø54 h=85

SEM NO.	REF. NO.	Type / Model
10779	0003220450	
<b>Description</b>		
Bush		



D=Ø77 d=Ø15 Ax=110





SEM NO.	REF. NO.	Type / Model
11757	9723500906S	
<b>Description</b>		
Ball Joint		

<b>Type / Model</b>	<b>REF. NO.</b>		<b>SEM NO.</b>	
	0003301811S 0003330027S		<b>11993</b>	
			<b>Description</b>	
			Ball Joint	
D=Ø77 d=Ø15 Ax=110				
<b>Type / Model</b>	<b>REF. NO.</b>		<b>SEM NO.</b>	
	6283300807 6283300407 0003301107 6293301407		<b>9625</b>	
			<b>Description</b>	
			Stabilizer Bushing	
D=Ø78 d=Ø19&22 Ax=130				
<b>Type / Model</b>	<b>REF. NO.</b>		<b>SEM NO.</b>	
	6283300707		<b>11282</b>	
			<b>Description</b>	
			Stabilizer Bushing	
D=Ø78 d=Ø23&25 Ax=130				
<b>Type / Model</b>	<b>REF. NO.</b>		<b>SEM NO.</b>	
	6293310017		<b>12824</b>	
			<b>Description</b>	
			Ball Joint	
<b>Type / Model</b>	<b>REF. NO.</b>		<b>SEM NO.</b>	
	0003300080		<b>7771</b>	
			<b>Description</b>	
			Ball Joint	
D=Ø87 d=Ø17 Ax=130				







Description / Ball Joint (Repair Kit)	SEM NO.	Model:
 <p>A collection of repair kit components including various colored bushings (orange, white, black), a ball joint, a grease gun, and a tube of grease.</p>	<p><b>7791</b></p> <p>REF. NO: 3435860032 0005861633</p> <p>D=Ø 80</p>	
 <p>A collection of repair kit components including various colored bushings (orange, white, black), a ball joint, a grease gun, and a tube of grease.</p>	<p><b>7792</b></p> <p>REF. NO: 0005860632</p> <p>D=Ø 80</p>	
 <p>A collection of repair kit components including plastic bushings (orange, white, black), a ball joint, a grease gun, and a tube of grease.</p>	<p><b>7793</b></p> <p>REF. NO: 0003500213 0005861433 0003500305 0003500505</p> <p>D=Ø 80</p>	
 <p>A collection of repair kit components including various colored bushings (yellow, white, black, green), a ball joint, a grease gun, and a tube of grease.</p>	<p><b>7794</b></p> <p>REF. NO: 0005860132</p> <p>D=Ø 80</p>	







Model:	SEM NO.	Description / Ball Joint (Repair Kit)
	<b>7801</b>	
	REF. NO: 0005860732	
	D=Ø 80	
	<b>7806</b>	
	REF. NO: 0005861533	
	D=Ø 80	
	<b>7826</b>	
	REF. NO: 0003500205	
	Ø80	
	<b>7877</b>	
	REF. NO: 0005861035	
	D=Ø80	















Description / Ball Joint (Repair Kit)	SEM NO.	Model:
	<p><b>8022</b></p> <p>REF. NO: 0003501405</p> <p>D=Ø 80</p>	
	<p><b>7825</b></p> <p>REF. NO: 0003500405 0005860135 0005861833 0005861933</p> <p>Ø90</p>	
	<p><b>8757</b></p> <p>REF. NO: 0003500805</p> <p>D=Ø 90</p>	
	<p><b>9092</b></p> <p>REF. NO: 0003500105</p> <p>D=Ø90</p>	



Type / Model	REF. NO.	SEM NO.	
	9453300007	<b>8041</b>	
		<b>Description</b>	1   1
		Axle Rod	
1- 7679 Page 353			L=850 d=Ø17/17 Ax=100/100
Type / Model	REF. NO.	SEM NO.	
	9413300007 3753300007	<b>8042</b>	
		<b>Description</b>	1   1
		Axle Rod	
1- 7679 Page 353			L=845 d=Ø17/17 Ax=100/100
Type / Model	REF. NO.	SEM NO.	
	3853500006 6533500006	<b>8047</b>	
		<b>Description</b>	1   1
		Axle Rod	
1- 7793 Page 364			L=500 d=Ø21/21 Ax=152/152
Type / Model	REF. NO.	SEM NO.	
	3853500006S 6533500006S	<b>8048</b>	
		<b>Description</b>	1   1
		Axle Rod Alternative Rubber	
1- 7431 Page 356			L=500 d=Ø21/21 Ax=152/152
Type / Model	REF. NO.	SEM NO.	
	3933200332	<b>8049</b>	
		<b>Description</b>	1   1
		Axle Rod	
1- 7793 Page 364			L=553 d=Ø21/21 Ax=152/152
Type / Model	REF. NO.	SEM NO.	
	3933200332S	<b>8050</b>	
		<b>Description</b>	1   1
		Axle Rod Alternative Rubber	
1- 7431 Page 356			L=553 d=Ø21/21 Ax=152/152

	<b>SEM NO.</b>	<b>REF. NO.</b>	<b>Type / Model</b>
	8051	3813500206 3833500006	
	<b>Description</b>		
	Axle Rod		
L=595 d=Ø21/21 Ax=152/152	1- 7793 Page 364		
	<b>SEM NO.</b>	<b>REF. NO.</b>	<b>Type / Model</b>
	8052	3813500206S 3833500006S	
	<b>Description</b>		
	Axle Rod Alternative Rubber		
L=595 d=Ø21/21 Ax=152/152	1- 7431 Page 356		
	<b>SEM NO.</b>	<b>REF. NO.</b>	<b>Type / Model</b>
	8054	3853500106 3953200332	
	<b>Description</b>		
	Axle Rod Alternative Rubber		
L=610 d=Ø21/21 Ax=152/152	1- 7432 Page 357		
	<b>SEM NO.</b>	<b>REF. NO.</b>	<b>Type / Model</b>
	8055	3933200232	
	<b>Description</b>		
	Axle Rod		
L=627 d=Ø21/21 Ax=152/152	1- 7793 Page 364		
	<b>SEM NO.</b>	<b>REF. NO.</b>	<b>Type / Model</b>
	8056	3933200232S	
	<b>Description</b>		
	Axle Rod Alternative Rubber		
L=627 d=Ø21/21 Ax=152/152	1- 7431 Page 356		
	<b>SEM NO.</b>	<b>REF. NO.</b>	<b>Type / Model</b>
	8064	6593500406 3953500706 6593502706	
	<b>Description</b>		
	Axle Rod		
L=585 d=Ø21/21 Ax=152/152	1- 7432 Page 357		

<b>Type / Model</b>	<b>REF. NO.</b>	<b>SEM NO.</b>	
	6243500106 6293501206 6593501206 6593503506	<b>8065</b>	
		<b>Description</b>	
		Axle Rod	
1- 7432 Page 357			L=579 d=Ø21/21 Ax=152/152
<b>Type / Model</b>	<b>REF. NO.</b>	<b>SEM NO.</b>	
	6593503406 3953500006 6243500006 6593501106	<b>8068</b>	
		<b>Description</b>	
		Axle Rod	
1- 7550 Page 359			L=579 d=Ø21/21 Ax=152/152
<b>Type / Model</b>	<b>REF. NO.</b>	<b>SEM NO.</b>	
	6593500106 6593502406 3953500206	<b>8305</b>	
		<b>Description</b>	
		Axle Rod	
1- 7432 Page 357			L=585 d=Ø21/21 Ax=152/152
<b>Type / Model</b>	<b>REF. NO.</b>	<b>SEM NO.</b>	
	6593502206 6593504506 6193500206	<b>8306</b>	
		<b>Description</b>	
		Axle Rod	
1- 7432 Page 357			L=660 d=Ø21/21 Ax=152/152
<b>Type / Model</b>	<b>REF. NO.</b>	<b>SEM NO.</b>	
	9483501305 9483500605 9483501205 9473500005	<b>8312</b>	
		<b>Description</b>	
		Axle Rod	
1- 8226 Page 357			L=565 d=Ø21/21 Ax=152/152
<b>Type / Model</b>	<b>REF. NO.</b>	<b>SEM NO.</b>	
	6133300011 356300211	<b>8923</b>	
		<b>Description</b>	
		Axle Rod	
1- 7613 Page 354			L=769 d=Ø17/17 Ax=130/130

SEM NO.	REF. NO.	Type / Model
<b>8924</b>	6133000006	1- 7611 Page 360 2- 7613 Page 354
	6133500006	
	3563500106	
	3563500006	
<b>Description</b>		
Axle Rod		
L=628 d=Ø17 Ax=130		



SEM NO.	REF. NO.	Type / Model
<b>8925</b>	3753500006	1- 7432 Page 357
<b>Description</b>		
Axle Rod		
L=579 d=Ø21/21 Ax=152/152		



SEM NO.	REF. NO.	Type / Model
<b>8926</b>	3953501306	1- 7651 Page 360
	6243500506	
	6593501606	
	6593503906	
	65935001006	
	6593503306	
<b>Description</b>		
Axle Rod		
L=629 d=Ø21/21 Ax=152/152		





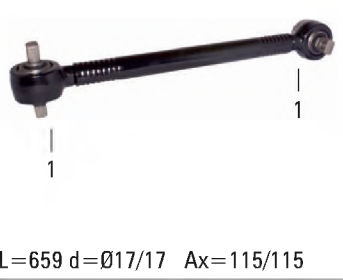



SEM NO.	REF. NO.	Type / Model
<b>8949</b>	6593503206	1- 7550 Page 359
	6593500906	
	3953501206	
	3953501106	
<b>Description</b>		
Axle Rod		
L=635 d=Ø21/21 Ax=152/152		



SEM NO.	REF. NO.	Type / Model
<b>8950</b>	6713330205	1- 7595 Page 354
	3573330505	
<b>Description</b>		
Axle Rod		
L=659 d=Ø17/17 Ax=115/115		



SEM NO.	REF. NO.	Type / Model
<b>8951</b>	6713330005	1- 7335 Page 357
	3573330205	
<b>Description</b>		
Axle Rod		
L=750 d=Ø19/19 Ax=130/130		

Type / Model	REF. NO.	SEM NO.	
1- 7594 Page 361 2- 7595 Page 354	6713330001	8952	
	3573330101		
			<p><b>Description</b></p> <p>Axle Rod</p> <p>L=806 d=Ø17 Ax=115</p>
1- 7595 Page 354	6713330405	8953	
	3573330705		
			<p><b>Description</b></p> <p>Axle Rod</p> <p>L=659 d=Ø17/17 Ax=115/115</p>
1- 7679 Page 353 2- 9615 Page 362	000360098524	9363	
	000390098524		
	9413300011		
	3753300111		
	SA508316/01		
			<p><b>Description</b></p> <p>Axle Rod Alternative Rubber</p> <p>L=754 d=Ø17/17 Ax=100/100</p>
1- 7432 Page 357	6203500006	9364	
	6203500106		
	6553500306		
			<p><b>Description</b></p> <p>Axle Rod Alternative Rubber</p> <p>L=595 d=Ø21/21 Ax=152/152</p>
1- 7432 Page 357 2- 9076 Page 361	6543500406	9365	
	6543500506		
	6543520005		
			<p><b>Description</b></p> <p>Axle Rod Alternative Rubber</p> <p>L=652 d=Ø21 Ax=152 D=Ø95 L=73</p>
1- 7767 Page 357	3573303311	9366	
	3573301911		
	3573300811		
			<p><b>Description</b></p> <p>Axle Rod Alternative Rubber</p> <p>L=713 d=Ø16,5/16,5 Ax=130/130</p>

SEM NO.	REF. NO.	Type / Model
9367	9453300011	
<b>Description</b>		
Axle Rod Alternative Rubber		
L=755 d=Ø17/17 Ax=100/100		1- 7679 Page 353







SEM NO.	REF. NO.	Type / Model
9368	6283330905 6283331705	
<b>Description</b>		
Axle Rod		
L=576 d=Ø19/19 Ax=130/130		1- 7919 Page 358

SEM NO.	REF. NO.	Type / Model
9369	9483502405 9473500605 9483500006 9483502005 9483500106 3753500106	
<b>Description</b>		
Axle Rod Alternative Rubber		
L=565 d=Ø21/21 Ax=152/152		1- 8226 Page 357









SEM NO.	REF. NO.	Type / Model
9370	6283331105 6283331905	
<b>Description</b>		
Axle Rod		
L=585 d=Ø19/19 Ax=130/130		1- 9083 Page 356

SEM NO.	REF. NO.	Type / Model
9371	3573330905	
<b>Description</b>		
Axle Rod Alternative Rubber		
L=662 d=Ø19/19 Ax=130/130		1- 7335 Page 357

SEM NO.	REF. NO.	Type / Model
9372	3173500606 3573303411	
<b>Description</b>		
Axle Rod		
L=585		

Type / Model	REF. NO.	ŞEM NO.	
	3933200132 6553500006 6583500206 6583500006	9373	
		<b>Description</b>	
1- 7432 Page 357		Axle Rod Alternative Rubber	L=585 d=Ø21/21 Ax=152/152
Type / Model	REF. NO.	ŞEM NO.	
	3813500606 6523500306 6533500106	9374	
		<b>Description</b>	
1- 7432 Page 357 2- 9076 Page 361		Axle Rod Alternative Rubber	L=522 d=Ø21 Ax=152
Type / Model	REF. NO.	ŞEM NO.	
	3953200132	9375	
		<b>Description</b>	
1- 7793 Page 364		Axle Rod	L=568 d=Ø21/21 Ax=152/152
Type / Model	REF. NO.	ŞEM NO.	
	3573330605	9377	
		<b>Description</b>	
1- 7615 Page 353		Axle Rod Alternative Rubber	L=662 d=Ø19/19 Ax=130/130
Type / Model	REF. NO.	ŞEM NO.	
	6273500006 6273500106 6283330003 6283330005 6283331005 6283331805	10165	
		<b>Description</b>	
1- 7919 Page 358		Axle Rod	L=664 d=Ø19/19 Ax=130/130
Type / Model	REF. NO.	ŞEM NO.	
	3953501006 6243500206 6593501306 6593503606	10166	
		<b>Description</b>	
1- 7550 Page 359		Axle Rod	L=629 d=Ø21/21 Ax=152/152



	SEM NO.	REF. NO.	Type / Model
 <p>L=629 d=Ø/21/21 Ax=152/152</p>	<b>10167</b>	6243500606 6593501706 6593504006	
	<b>Description</b>		1- 7432 Page 357
 <p>L=660 d=Ø/19/19 Ax=130/130</p>	<b>10168</b>	8226387000	
	<b>Description</b>		1- 7919 Page 358
 <p>L=565 d=Ø/21/21 Ax=152/152</p>	<b>10169</b>	9483500805 3753500206 9473500805 9483501905	
	<b>Description</b>		1- 9091 Page 356
 <p>L=806 d=Ø17 Ax=115</p>	<b>11798</b>	 6283330101	
	<b>Description</b>		1- 9098 Page 362 2- 7595 Page 354
 <p>L=659 d=Ø17/17 Ax=115/115</p>	<b>11799</b>	 6283330205	
	<b>Description</b>		1- 9080 Page 354
 <p>L=659 d=Ø17/17 Ax=115/115</p>	<b>11800</b>	 6283330305	
	<b>Description</b>		1- 9080 Page 354

<b>Type / Model</b>	<b>REF. NO.</b>		<b>SEM NO.</b>	
	9453500105 9483501005 9483502505		<b>11805</b>	
1- 8226 Page 357			<b>Description</b>	Axle Rod
				L=615 d=Ø21/21 Ax=152/152
<b>Type / Model</b>	<b>REF. NO.</b>		<b>SEM NO.</b>	
	6273500206 6293500306 6273500306 6293500406		<b>12936</b>	
1- 7335 Page 357			<b>Description</b>	Axle Rod
				L=570 d=Ø19/19 Ax=130/130
<b>Type / Model</b>	<b>REF. NO.</b>		<b>SEM NO.</b>	
	6293500006 6293501106 6293500105		<b>12938</b>	
1- 7919 Page 358			<b>Description</b>	Axle Rod
				L=725 d=Ø19/19 Ax=130/130
<b>Type / Model</b>	<b>REF. NO.</b>		<b>SEM NO.</b>	
0 405 GN2	3578900248		<b>8785</b>	
1- 8616 Page 90			<b>Description</b>	Axle Rod
<b>Type / Model</b>	<b>REF. NO.</b>		<b>SEM NO.</b>	
	6243500406 6593501506 6593503806		<b>8070</b>	
1- 7550 Page 359			<b>Description</b>	Axle Rod
				L=629 d=Ø21/21 Ax=152/152
<b>Type / Model</b>	<b>REF. NO.</b>		<b>SEM NO.</b>	
	6253500406 6253500506		<b>8071</b>	
1- 7550 Page 359			<b>Description</b>	Axle Rod
				L=559 d=Ø21/21 Ax=152/152



L=622 Ax=152/130/130 d=Ø25/23/23

SEM NO.	REF. NO.	Type / Model
<b>8169</b>	9423500805	
	9423500505	
	9423501205	
	3753500505	

**Description**

Axle Rod ( V )

1- 9089 Page 359  
2- 7959 Page 358



L=622 Ax=152/130/130 d=Ø25/25/25

SEM NO.	REF. NO.	Type / Model
<b>8170</b>	9423501005	
	9423501505	
	9473500105	
	3753500005	
	9443500005	
	9473501005	

**Description**

Axle Rod ( V )

1- 9089 Page 359  
2- 9594 Page 356



L=622 Ax=152/130/130 d=Ø25/25/25

SEM NO.	REF. NO.	Type / Model
<b>8171</b>	9483503005	
	9443500305	
	3753500205	
	9473500705	
	9483501105	
	9443500605	
	9443500505	
	9483502105	
	9483500405	

**Description**

Axle Rod ( V )

1- 9090 Page 360  
2- 9594 Page 356



L=622 Ax=152/130/130 d=Ø25/23/23

SEM NO.	REF. NO.	Type / Model
<b>8183</b>	9483502205	
	9483501705	

**Description**

Axle Rod ( V )

1- 7982 Page 360  
2- 7981 Page 359



L=667 Ax=152/130/130 d=Ø25/23/23

SEM NO.	REF. NO.	Type / Model
<b>8223</b>	9483502305	

**Description**

Axle Rod ( V )

1- 7982 Page 360  
2- 7981 Page 359



L=622 Ax=152/130/130 d=Ø25/23/23

SEM NO.	REF. NO.	Type / Model
<b>9314</b>	9423500105	
	9423501105	
	9423501605	
	3753500105	
	9423500705	

**Description**

Axle Rod ( V )

1- 7644 Page 355  
2- 9036 Page 353

<p><b>Type / Model</b></p> <p>1- 9092 Page 366 2- 8226 Page 357</p>	<p><b>REF. NO.</b></p> <p>3833500105 6533500105 3933505505 3933505205 6533530005 3933505305 6553500305 3933505405 6583500005</p>	<p><b>SEM NO.</b></p> <p><b>9315</b></p>	<p><b>Description</b></p> <p>Axle Rod ( V )</p> <p>L=623 Ax=152/152 d=Ø21/21</p>
<p><b>Type / Model</b></p> <p>1- 9092 Page 366 2- 7793 Page 364</p>	<p><b>REF. NO.</b></p> <p>6543500005 6543500105 6543500305</p>	<p><b>SEM NO.</b></p> <p><b>9316</b></p>	<p><b>Description</b></p> <p>Axle Rod ( V )</p> <p>L=623 Ax=152/152 d=Ø21/21</p>
<p><b>Type / Model</b></p> <p>1- 7774 Page 361 2- 7954 Page 358</p>	<p><b>REF. NO.</b></p> <p>6583500205 6533500205</p>	<p><b>SEM NO.</b></p> <p><b>9317</b></p>	<p><b>Description</b></p> <p>Axle Rod ( V )</p> <p>L=622 Ax=152/152 d=Ø25/25</p>
<p><b>Type / Model</b></p> <p>1- 7982 Page 360 2- 7981 Page 359</p>	<p><b>REF. NO.</b></p> <p>9483502805</p>	<p><b>SEM NO.</b></p> <p><b>9439</b></p>	<p><b>Description</b></p> <p>Axle Rod ( V )</p> <p>L=667 Ax=152/130/130 d=Ø25/23/23</p>
<p><b>Type / Model</b></p> <p>1- 7982 Page 360 2- 7981 Page 359</p>	<p><b>REF. NO.</b></p> <p>9483502705</p>	<p><b>SEM NO.</b></p> <p><b>9637</b></p>	<p><b>Description</b></p> <p>Axle Rod ( V )</p> <p>L=622 Ax=152/130/130 d=Ø25/23/23</p>
<p><b>Type / Model</b></p> <p>1- 7627 Page 358 2- 7959 Page 358</p>	<p><b>REF. NO.</b></p> <p>9423501305 9423500905</p>	<p><b>SEM NO.</b></p> <p><b>10156 (10985)</b></p>	<p><b>Description</b></p> <p>Axle Rod ( V )</p> <p>L=622 d=Ø/25/23/23 Ax=152/130/130</p>

	SEM NO.	REF. NO.	Type / Model
 <p>L=622 d=Ø25/25/25 Ax=152/130/130</p>	<b>10157</b>	9443500405	
	<b>Description</b>		1- 9089 Page 359 2- 9594 Page 356
			<b>Axle Rod ( V )</b>

	SEM NO.	REF. NO.	Type / Model
 <p>L=622 Ax=152/130/130 d=Ø25/23/23</p>	<b>10675</b>	9473500905	
	<b>Description</b>		1- 7627 Page 358 2- 9613 Page 87
			<b>Axle Rod ( V )</b>

	SEM NO.	REF. NO.	Type / Model
 <p>L=622 d=Ø25/25/25 Ax=152/130/130</p>	<b>10981</b>	9483502905	
	<b>Description</b>		1- 7682 Page 359 2- 7916 Page 356
			<b>Axle Rod (V)</b>

	SEM NO.	REF. NO.	Type / Model
 <p>L=622 d=Ø25/25 Ax=152/152</p>	<b>10987</b>	6583500105	
	<b>Description</b>		1- 7774 Page 361 2- 7954 Page 358
			<b>Axle Rod (V)</b>

	SEM NO.	REF. NO.	Type / Model
 <p>L=623 d=Ø25/25 Ax=152/152</p>	<b>11251</b>	6533500305	
	<b>Description</b>		1- 7774 Page 361 2- 7954 Page 358
			<b>V-torque Rod</b>

	SEM NO.	REF. NO.	Type / Model
 <p>L=762 d=Ø25/23/23 Ax=152/130/130</p>	<b>11252</b>	9743500505 9743500005 9743500405	
	<b>Description</b>		1- 7644 Page 355 2- 9036 Page 353
			<b>V-torque Rod</b>

Type / Model	REF. NO.	SEM NO.	
OPEN LENGTH=723	00053261100	"SACHS124359"	 <b>Description</b> Shock Absorber
CLOSED LENGTH=443	0053262500	"SACHS124361"	
UPPER MOUNT	0053267400	"SACHS131623"	
DIMENSION=20x105	3753260400	"MONROET5064"	
LOWER MOUNT	0063260100	"MONROET5171"	
DIMENSION=20x50	0063261100 0063263100		
Type / Model	REF. NO.	SEM NO.	
OPEN LENGTH=804	0053239500		 <b>Description</b> Shock Absorber
CLOSED LENGTH=479	0063233700		
UPPER MOUNT	0063236100		
DIMENSION=16x50	3753230800		
LOWER MOUNT	SACHS 310805		
DIMENSION=16x50	SACHS 124314 MONROE T1204		
Type / Model	REF. NO.	SEM NO.	
OPEN LENGTH=854	0053266400	3753260200	 <b>Description</b> Shock Absorber
CLOSED LENGTH=514	0053266600	9583260600	
UPPER MOUNT	0063266800	"SACHS124567"	
DIMENSION=16x105	9583260600	"MONROET1201"	
LOWER MOUNT	0053266600		
DIMENSION=16x50	"MONROET1211" 9583260700 0063262400		
Type / Model	REF. NO.	SEM NO.	
OPEN LENGTH=783	0053261200		 <b>Description</b> Shock Absorber
CLOSED LENGTH=473	0053266800		
UPPER MOUNT	0063262900		
DIMENSION=20x105	"MONROET5137"		
LOWER MOUNT	3753260000		
DIMENSION=20x50	"SACHS280940" "SACHS124360"		
Type / Model	REF. NO.	SEM NO.	
OPEN LENGTH=790	0023237200		 <b>Description</b> Shock Absorber
CLOSED LENGTH=479	0023237300		
UPPER MOUNT	0033239700		
DIMENSION=16x50	0043234400		
LOWER MOUNT	0043239700		
DIMENSION=16x50	0043239800 0063230700 "SACHS310772"		
Type / Model	REF. NO.	SEM NO.	
OPEN LENGTH=791	0033233200		 <b>Description</b> Shock Absorber
CLOSED LENGTH=483	0033233300		
UPPER MOUNT	0043239200		
DIMENSION=16x50	0053234000		
LOWER MOUNT	0053234100		
DIMENSION=16x50	0053239600 0063230900		



SEM NO.	REF. NO.	Type / Model
	<b>11292</b>	0008911405 0008911605 SACHS 101155
	<b>Description</b>	Shock Absorber
		OPEN LENGTH=254 CLOSED LENGTH=200 UPPER MOUNT DIMENSION=14x32 LOWER MOUNT DIMENSION=14x32

SEM NO.	REF. NO.	Type / Model	
	<b>11293</b>	0023231000 0033231900 0043230100 0043236800 0023235800 0033233400 0043233400 0043236900 0023235900 0033236500 0043233700 0063230800 0023236100 0033236600 0043234500 3713237100 0023238600 0033236700 0043234600 "SACHS112027" 0023238700 0033236800 0043234700 "SACHS106860" 0033230000 0033237100 0043235200 "SACHS106862" 0033231000 0033237200 0043236400 "MONROET1014" 0033231100 0033238900 0043236500 "MONROET1013" 0033231800 0043230000 0043236700 "MONROET1144" "MONROET1016"	OPEN LENGTH=810 CLOSED LENGTH=490 UPPER MOUNT DIMENSION=16x50 LOWER MOUNT DIMENSION=16x50
	<b>Description</b>	Shock Absorber	

SEM NO.	REF. NO.	Type / Model
	<b>11294</b>	0053239700 0063232100 0063237200 3753230100 3753230700 9583230500 "SACHS125898" "MONROET1207"
	<b>Description</b>	Shock Absorber
		OPEN LENGTH=853 CLOSED LENGTH=503 UPPER MOUNT DIMENSION=16x50 LOWER MOUNT DIMENSION=16x50

SEM NO.	REF. NO.	Type / Model
	<b>11431</b>	0004635932 0004636132 0004636232 0004636432 3024630032 3024630432 6714630032 "SACHS200341"
	<b>Description</b>	Shock Absorber
		OPEN LENGTH=878 CLOSED LENGTH=558 UPPER MOUNT DIMENSION=----- LOWER MOUNT DIMENSION=14x40

SEM NO.	REF. NO.	Type / Model
	<b>11432</b>	3564630332 6134630132
	<b>Description</b>	Shock Absorber
		OPEN LENGTH=859 CLOSED LENGTH=495 UPPER MOUNT DIMENSION=----- LOWER MOUNT DIMENSION=14x40

SEM NO.	REF. NO.	Type / Model
	<b>11436</b>	0002400048 0002402348 "SACHS125176" 6712400048 "SACHS101315" 3012400048
	<b>Description</b>	Shock Absorber
		OPEN LENGTH=247 CLOSED LENGTH=180 UPPER MOUNT DIMENSION=12x32 LOWER MOUNT DIMENSION=12x32





Type / Model	REF. NO.	SEM NO.	
OPEN LENGTH=589	0023238000	3013230100	 <b>Description</b> Shock Absorber
CLOSED LENGTH=352	0033237400	3023200230	
UPPER MOUNT	0033263400	3023260500	
DIMENSION=M14x80	3003260000	"SACHS310776"	
LOWER MOUNT	3003260100		
DIMENSION=M14x75	3003260300		
	3003260500		
	3013230000		

Type / Model	REF. NO.	SEM NO.	
OPEN LENGTH=590	0013262100	3023260200	 <b>Description</b> Shock Absorber
CLOSED LENGTH=354	0023262200	"MONROEB1263"	
UPPER MOUNT	0023264000		
DIMENSION=M14x71	0033267500		
LOWER MOUNT	3003260400		
DIMENSION=M14x67	3733200031		
	3733267300		
	"SACHS106893"		

Type / Model	REF. NO.	SEM NO.	
OPEN LENGTH=804	0063235400		 <b>Description</b> Shock Absorber
CLOSED LENGTH=479	3753230900	11439	
UPPER MOUNT	SACH 131622		
DIMENSION=16x50			
LOWER MOUNT			
DIMENSION=16x50			

Type / Model	REF. NO.	SEM NO.	
OPEN LENGTH=613	3563200031		 <b>Description</b> Shock Absorber
CLOSED LENGTH=373	3563260000	11442	
UPPER MOUNT	3563260700		
DIMENSION=M14x67	6133260100		
LOWER MOUNT	"SACHS124272"		
DIMENSION=M14x67	"MONROEB1305"		

Type / Model	REF. NO.	SEM NO.	
OPEN LENGTH=530	0053268900		 <b>Description</b> Shock Absorber
CLOSED LENGTH=325	3573200400	11443	
UPPER MOUNT	3573200431		
DIMENSION=M14x67	3573230400		
LOWER MOUNT	3573260300		
DIMENSION=M14x78	6713260000		
	6713260100		
	"SACHS112937"		

Type / Model	REF. NO.	SEM NO.	
OPEN LENGTH=664	3563230200		 <b>Description</b> Shock Absorber
CLOSED LENGTH=435	3563230400	11452	
UPPER MOUNT	"MONROEB5335"		
DIMENSION=20x62	3563230500		
LOWER MOUNT	"SACHS124876"		
DIMENSION=20x62			

	SEM NO.	REF. NO.	Type / Model
 <p><b>Description</b> Shock Absorber</p>	11457	3758900519	OPEN LENGTH=372
		9408903919	CLOSED LENGTH=302
		9408904119	UPPER MOUNT
		9583172103	DIMENSION=12,3x50
		"SACHS290995"	LOWER MOUNT
		"MONROECB0097"	DIMENSION=12,3x50
	SEM NO.	REF. NO.	Type / Model
 <p><b>Description</b> Shock Absorber</p>	11458	3758900119	OPEN LENGTH=278
		9408901719	CLOSED LENGTH=220
			UPPER MOUNT
			DIMENSION=14x40
			LOWER MOUNT
			DIMENSION=-----
	SEM NO.	REF. NO.	Type / Model
 <p><b>Description</b> Shock Absorber</p>	11459	3758900419	OPEN LENGTH=328
		3758900919	CLOSED LENGTH=284
		9408903819	UPPER MOUNT
		9408904719	DIMENSION=14x50
		9583171003	LOWER MOUNT
		9583171103	DIMENSION=14x50
		"SACHS290251"	
		"SACHS313949"	
	SEM NO.	REF. NO.	Type / Model
 <p><b>Description</b> Shock Absorber</p>	11460	3758900819	OPEN LENGTH=346
		9408904519	CLOSED LENGTH=281
		9408904619	UPPER MOUNT
		9583171503	DIMENSION=14x50
		"SACHS290996"	LOWER MOUNT
			DIMENSION=14x40
	SEM NO.	REF. NO.	Type / Model
 <p><b>Description</b> Shock Absorber</p>	11466	6714630132	OPEN LENGTH=878
			CLOSED LENGTH=558
			UPPER MOUNT
			DIMENSION=-----
			LOWER MOUNT
			DIMENSION=-----
	SEM NO.	REF. NO.	Type / Model
 <p><b>Description</b> Shock Absorber</p>	11469	3732407148	OPEN LENGTH=246
			CLOSED LENGTH=179
			UPPER MOUNT
			DIMENSION=12x32
			LOWER MOUNT
			DIMENSION=12x32

Type / Model	REF. NO.	SEM NO.	
OPEN LENGTH=246 CLOSED LENGTH=179 UPPER MOUNT DIMENSION=12x32 LOWER MOUNT DIMENSION=12x32	3732407048	11470	
			<b>Description</b> Shock Absorber
Type / Model	REF. NO.	SEM NO.	
OPEN LENGTH=248 CLOSED LENGTH=197 UPPER MOUNT DIMENSION=18x34 LOWER MOUNT DIMENSION=18x34	0008911805 0008912205 "SACHS101378"	11472	
			<b>Description</b> Shock Absorber
Type / Model	REF. NO.	SEM NO.	
OPEN LENGTH=518 CLOSED LENGTH=323 UPPER MOUNT DIMENSION=12x40 LOWER MOUNT DIMENSION=12x40	6013200431 6013200631 6013200831 6013201231 "SACHS101497"	11477	
			<b>Description</b> Shock Absorber
Type / Model	REF. NO.	SEM NO.	
OPEN LENGTH=603 CLOSED LENGTH=365 UPPER MOUNT DIMENSION=12x32 LOWER MOUNT DIMENSION=12x32	6013200030 6013200730 6013200130 "SACHS101496"	11478	
			<b>Description</b> Shock Absorber
Type / Model	REF. NO.	SEM NO.	
OPEN LENGTH=390 CLOSED LENGTH=260 UPPER MOUNT DIMENSION=12x32 LOWER MOUNT DIMENSION=12x32	0008910205 0008910305 0008910505 0008910805 0008911005 0013231900 "SACHS195422" "MONROECB0057"	11483	
			<b>Description</b> Shock Absorber
Type / Model	REF. NO.	SEM NO.	
OPEN LENGTH=656 CLOSED LENGTH=389 UPPER MOUNT DIMENSION=14x40 LOWER MOUNT DIMENSION=14x40	3143230800 3143230900 "SACHS101455"	11488	
			<b>Description</b> Shock Absorber

SEM NO.	REF. NO.	Type / Model
	<b>11489</b>	3143230300 3143230500 3143230600 3143230700
	<b>Description</b>	"SACHS780001"
<b>Description</b>		Shock Absorber
		OPEN LENGTH=661 CLOSED LENGTH=394 UPPER MOUNT DIMENSION=M10x53 LOWER MOUNT DIMENSION=M14x40

SEM NO.	REF. NO.	Type / Model
	<b>11490</b>	0013265700 0023233000 0033235500 3143260600
	<b>Description</b>	0013265900 0023239400 0033235800 "SACHS725002"
<b>Description</b>		Shock Absorber
		0013266200 0023239500 0033236100 0013267700 0023239600 3143260100 0013267800 0023239700 3143260200 0013268300 0023261900 3143260400 0013268800 0023262600 3143260500 0013268900 0023262700 0033235900 0023232700 0033234500 0033236000
		OPEN LENGTH=622 CLOSED LENGTH=375 UPPER MOUNT DIMENSION=14x40 LOWER MOUNT DIMENSION=14x40

SEM NO.	REF. NO.	Type / Model
	<b>11491</b>	3713237200
	<b>Description</b>	
<b>Description</b>		Shock Absorber
		OPEN LENGTH=568 CLOSED LENGTH=346 UPPER MOUNT DIMENSION=12x32 LOWER MOUNT DIMENSION=12x32

SEM NO.	REF. NO.	Type / Model
	<b>11492</b>	3713267000
	<b>Description</b>	
<b>Description</b>		Shock Absorber
		OPEN LENGTH=568 CLOSED LENGTH=346 UPPER MOUNT DIMENSION=14x40 LOWER MOUNT DIMENSION=14x40

SEM NO.	REF. NO.	Type / Model
	<b>11493</b>	3733237100
	<b>Description</b>	
<b>Description</b>		Shock Absorber
		OPEN LENGTH=589 CLOSED LENGTH=352 UPPER MOUNT DIMENSION=M14x80 LOWER MOUNT DIMENSION=M14x75

SEM NO.	REF. NO.	Type / Model
	<b>11500</b>	0063236000 0063237800 0063237900 3573230000
	<b>Description</b>	"SACHS131944"
<b>Description</b>		Shock Absorber
		OPEN LENGTH=801 CLOSED LENGTH=479 UPPER MOUNT DIMENSION=M16x50 LOWER MOUNT DIMENSION=M16x50

Type / Model	REF. NO.	SEM NO.	
OPEN LENGTH=710	0053263600	<b>11501</b>	
CLOSED LENGTH=434	6733261200		
UPPER MOUNT	6733261400		
DIMENSION=14x62	"MONROET1070"		
LOWER MOUNT	6743261400		
DIMENSION=16x50	"SACHS310781" "SACHS106774" "MONROET1111"		
		<b>Description</b>	
		Shock Absorber	

Type / Model	REF. NO.	SEM NO.	
OPEN LENGTH=774	0013239100	<b>11502</b>	
CLOSED LENGTH=475	0023231500		
UPPER MOUNT	0023233300		
DIMENSION=16x50	0023235300		
LOWER MOUNT	0043234300		
DIMENSION=16x50	0043236100		
	0063233300		
	0063233900		
	0063234000		
	0063237400		
		<b>Description</b>	
		Shock Absorber	

Type / Model	REF. NO.	SEM NO.	
OPEN LENGTH=660	4043230000	<b>11503</b>	
CLOSED LENGTH=420	4043230100		
UPPER MOUNT	4063230000		
DIMENSION=20x55	4063230200		
LOWER MOUNT	"SACHS112457"		
DIMENSION=20x55			
		<b>Description</b>	
		Shock Absorber	

Type / Model	REF. NO.	SEM NO.	
OPEN LENGTH=660	0023236900	<b>11504</b>	
CLOSED LENGTH=420	0053232800		
UPPER MOUNT	SACHS 112939		
DIMENSION=20x55			
LOWER MOUNT			
DIMENSION=20x55			
		<b>Description</b>	
		Shock Absorber	

Type / Model	REF. NO.	SEM NO.	
OPEN LENGTH=870	0013237100	<b>11507</b>	
CLOSED LENGTH=520	0023231600		
UPPER MOUNT	6343230100		
DIMENSION=16x50	3963200030		
LOWER MOUNT	3573260100		
DIMENSION=16x50	3573200131		
	0053231400		
	0043235900		
	0033260600		
	0013267100		
	0013266800		
	0033234200		
	0013233200		
	0023231800		
	0023235400		
	0023236000		
	0023262400		
	0033235300		
	3733200230		
	3733237200		
	0033237300		
	0033261800		
	0033263300		
	0033269000		
	0043235800		
	0043260300		
	0043262900		
	0053269100		
	3073230100		
	3073230400		
	3073260000		
	3073260100		
	3073260200		
	3073260400		
	3573200031		
	3573200100		
	3573260000		
	3733200030		
	"SACHS788001"		
		<b>Description</b>	
		Shock Absorber	







Type / Model	REF. NO.	SEM NO.	
OPEN LENGTH=737	0013237500	<b>11508</b>	
CLOSED LENGTH=444	0023233800		
UPPER MOUNT	0043237400		
DIMENSION=16x50	SACHS112025		
LOWER MOUNT			
DIMENSION=16x50			
		<b>Description</b>	
		Shock Absorber	

	ŞEM NO.	REF. NO.	Type / Model
 <p><b>Description</b> Shock Absorber</p>	<b>11509</b>	0063239500 SACHS 310163	OPEN LENGTH=802,5 CLOSED LENGTH=479,5 UPPER MOUNT DIMENSION=16x50 LOWER MOUNT DIMENSION=16x50
 <p><b>Description</b> Shock Absorber</p>	<b>11518</b>	0013236800 0023237600 0023237900 0023238400 0033232200 0033232300 0043233300 0043237100	0063231600 SACHS112871 OPEN LENGTH=890 CLOSED LENGTH=525 UPPER MOUNT DIMENSION=16x50 LOWER MOUNT DIMENSION=16x50
 <p><b>Description</b> Shock Absorber</p>	<b>11519</b>	0013262000 0023262000 3023260000 3643207031 SACHS101161	OPEN LENGTH=773 CLOSED LENGTH=460 UPPER MOUNT DIMENSION=16x50 LOWER MOUNT DIMENSION=M16x78
 <p><b>Description</b> Shock Absorber</p>	<b>11520</b>	6293260000 6293260100 "MONROEB1287" "SACHS300091" "SACHS290992"	OPEN LENGTH=617 CLOSED LENGTH=379 UPPER MOUNT DIMENSION=M14x67 LOWER MOUNT DIMENSION=M14x67
 <p><b>Description</b> Shock Absorber</p>	<b>11521</b>	6283260800 6283261100 6283261200 6283261600 6283262400 6283262500 6283262700 "SACHS290991"	OPEN LENGTH=508 CLOSED LENGTH=311 UPPER MOUNT DIMENSION=M14x67 LOWER MOUNT DIMENSION=M14x67
 <p><b>Description</b> Shock Absorber</p>	<b>11522</b>	3823230100 6283230100 6283230200 6283230400 "SACHS131828"	OPEN LENGTH=536 CLOSED LENGTH=326 UPPER MOUNT DIMENSION=M16x81 LOWER MOUNT DIMENSION=M16x81







Type / Model	REF. NO.	SEM NO.	
OPEN LENGTH=563 CLOSED LENGTH=353 UPPER MOUNT DIMENSION=Ø20x62 LOWER MOUNT DIMENSION=M16x75	6293230000 6293231000 6293231900 SACHS280966 MONROEB5286	11523	
			<b>Description</b> Shock Absorber
Type / Model	REF. NO.	SEM NO.	
OPEN LENGTH=792 CLOSED LENGTH=485 UPPER MOUNT DIMENSION=20x62 LOWER MOUNT DIMENSION=20x62	0013263200 0013266500 0013267400 0013267500 0013268500 0033269800 3453267700 "SACHS106949"	11527	
			<b>Description</b> Shock Absorber
Type / Model	REF. NO.	SEM NO.	
OPEN LENGTH=790 CLOSED LENGTH=478 UPPER MOUNT DIMENSION=16x50 LOWER MOUNT DIMENSION=16x50	0013233400 0013238200 0023230600 0023231300 0023233400 0043236200 0043237500 3713237000	"SACHS106954" 11528	
			<b>Description</b> Shock Absorber
Type / Model	REF. NO.	SEM NO.	
OPEN LENGTH=707 CLOSED LENGTH=442 UPPER MOUNT DIMENSION=20x55 LOWER MOUNT DIMENSION=20x55	0033232400 0033234000 0043232600 0043232700 0053231000 "SACHS106038"	11529	
			<b>Description</b> Shock Absorber
Type / Model	REF. NO.	SEM NO.	
OPEN LENGTH=853 CLOSED LENGTH=503 UPPER MOUNT DIMENSION=16x55 LOWER MOUNT DIMENSION=16x55	0053239100 "MONROET1251" "SACHS310804"	11530	
			<b>Description</b> Shock Absorber
Type / Model	REF. NO.	SEM NO.	
OPEN LENGTH=347 CLOSED LENGTH=250,5 UPPER MOUNT DIMENSION=14x50 LOWER MOUNT DIMENSION=25x40	9428905019 9428905119 SACHS 290259	 11970	
			<b>Description</b> Shock Absorber



	<b>SEM NO.</b> 12887		<b>REF. NO.</b> SACHS 105850 SACHS 105423	<b>Type / Model</b>
	<b>Description</b> Shock Absorber			
	<b>SEM NO.</b> 8074		<b>REF. NO.</b> 9013231185	<b>Type / Model</b>
	<b>Description</b> Rubber Bush (Shock Absorber)			
Ø16,3x Ø75 Ø85x37,5				
	<b>SEM NO.</b> 11266		<b>REF. NO.</b> 9013230085	<b>Type / Model</b> SPRINTER VW LT 28-35 VW LT 28-46 CHRYSLER DODGE
	<b>Description</b> Rubber Bushing for Shock Absorber			
	<b>SEM NO.</b> 8231		<b>REF. NO.</b> 3203230044	<b>Type / Model</b>
	<b>Description</b> Rubber Buffer			
	<b>SEM NO.</b> 8243		<b>REF. NO.</b> 0003231585	<b>Type / Model</b>
	<b>Description</b> Rubber Bushing			
	<b>SEM NO.</b> 8405		<b>REF. NO.</b> 0003232885 0003232444	<b>Type / Model</b>
	<b>Description</b> Rubber Bush (Shock Absorber)			

D=Ø40 d=Ø20 h=40

<b>Type / Model</b>	<b>REF. NO.</b>	<b>SEM NO.</b>	 D=Ø43 d=Ø22 h=49
	3173260070	9003	
		<b>Description</b>	
		Rubber Mounting	
<b>Type / Model</b>	<b>REF. NO.</b>	<b>SEM NO.</b>	 D=Ø53,5 d=Ø16 h=105
	0003200644	9004	
		<b>Description</b>	
		Stabilizer Bush	
<b>Type / Model</b>	<b>REF. NO.</b>	<b>SEM NO.</b>	 D=Ø55 d=Ø22 h=62
	0003200144 0003201444 0003201044	9005	
		<b>Description</b>	
		Stabilizer Bush	
<b>Type / Model</b>	<b>REF. NO.</b>	<b>SEM NO.</b>	 D=Ø53 d=Ø20 h=105
	0003200744	9007	
		<b>Description</b>	
		Stabilizer Bush	

	<b>SEM NO.</b>  <b>72.0081.C</b>	<b>REF. NO.</b> 9463280401 FIRESTONE 1T17B-11 FIRESTONE W01M588747 GOODYEAR 1R13-150 SAMRO 2500915 DUNLOP D13B42	<b>Technical Specification</b>  Total Weight 11,9 kg
	<b>Description</b>  Metal Piston		
	<b>SEM NO.</b>  <b>72.4157.CP04</b>	<b>REF. NO.</b> 9463281401 CONTITECH 4157 N P04 FIRESTONE 1T15MPW 7 FIRESTONE W01 M58 6297 DUNLOP D12B18 WW US 07364 GOODYEAR 1R11 111 TAURUS KR 915 54 PHOENIX 1DK 21 A 4 WW US 06287	<b>Technical Specification</b>  Total Weight 6,6 kg
	<b>Description</b>  Plastic Piston		
	<b>SEM NO.</b>  <b>72.4183.C01</b>	<b>REF. NO.</b> 9423202221 9423201321 9423206821 CONTITECH 4183 N P23	<b>Technical Specification</b>  Total Weight 8,8 kg
	<b>Description</b>  Metal Piston		
	<b>SEM NO.</b>  <b>72.4183.C24</b>	<b>REF. NO.</b> 9423202321 9423201421 9423206921 CONTITECH 4183 N P24	<b>Technical Specification</b>  Total Weight 8,8 kg
	<b>Description</b>  Metal Piston		
	<b>SEM NO.</b>  <b>72.4185.S1</b>	<b>REF. NO.</b> 9743280201 CONTITECH 4185 N	<b>Technical Specification</b>  Total Weight 3,2 kg
	<b>Description</b>  Service Assembly		
	<b>SEM NO.</b>  <b>72.4390.C01</b>	<b>REF. NO.</b> 9423200121 9423204921 9423202821 CONTITECH 4390 N P01 PHOENIX 1 KF 21-21 FIRESTONE 1R7Z-440-290 FIRESTONE W01-M58-8514 GOODYEAR 9505 VIBRACOUSTIC V1KF21-1	<b>Technical Specification</b>  Total Weight 6,2 kg
	<b>Description</b>  Metal Piston		

Technical Specification	REF. NO.		SEM NO.	
Total Weight 6,6 kg	9423200221	CONTITECH 4390 N P02	<b>72.4390.C02</b>	<b>Description</b> Metal Piston
	9423202921	PHOENIX 1 KF 21-22		
	9423205021	FIRESTONE 1R7Z-440-290		
		FIRESTONE W01-M58-8513		
		GOODYEAR 9506 VIBRACOUSTIC V1KF21-2		
<hr/>				
Total Weight 6,6 kg	9423200421	CONTITECH 4390 N P03	<b>72.4390.C03</b>	<b>Description</b> Metal Piston
	9423205221	VIBRACOUSTIC V1KF21-4-232		
		GOODYEAR 9563		
<hr/>				
Total Weight 6,6 kg	9423200321	CONTITECH 4390 N P04	<b>72.4390.C04</b>	<b>Description</b> Metal Piston
	9423205121	GOODYEAR 9564		
		VIBRACOUSTIC V1KF21-3-232		
<hr/>				
Total Weight 6,6 kg	9423200121	CONTITECH 4390 N P21	<b>72.4390.C21</b>	<b>Description</b> Metal Piston
	9423204921	PHOENIX 1 KF 21-21		
	9423202821	FIRESTONE 1R7Z-440-290		
		FIRESTONE W01-M58-8514		
		GOODYEAR 9505		
		VIBRACOUSTIC V1KF21-1		
<hr/>				
Total Weight 6,6 kg	9423200221	CONTITECH 4390 N P22	<b>72.4390.C22</b>	<b>Description</b> Metal Piston
	9423205021	PHOENIX 1 KF 21-22		
	9423202921	FIRESTONE 1R7Z-440-290		
		FIRESTONE W01-M58-8513		
		GOODYEAR 9506 VIBRACOUSTIC V1KF21-2		
<hr/>				
Total Weight 6,6 kg	9423200421	CONTITECH 4390 N P23	<b>72.4390.C23</b>	<b>Description</b> Metal Piston
	9423205221	GOODYEAR 9563		
		VIBRACOUSTIC V1KF21-4-232		

	<b>ŞEM NO.</b> 72.4390.C24	<b>REF. NO.</b> 9423200321 9423205121	<b>Technical Specification</b> CONTITECH 4390 N P04 GOODYEAR 9564 VIBRACOUSTIC V1KF21-3-232	Total Weight 6,6 kg
	<b>Description</b> Metal Piston			
	<b>ŞEM NO.</b> 72.4390.S1	<b>REF. NO.</b> 9423280001	<b>Technical Specification</b> CONTITECH 4390 N1 PHOENIX 1 KF 21 1 NP FIRESTONE 1R7Z 440 290 B FIRESTONE W01 M58 0904 GOODYEAR 9507 GY SPRINGRIDE D12U25 CF GOMMA REF. 1VSC285 30 CF GOMMA NO. 206782 GART NO. 304.0.440 GART REF. C304 VIBRACOUSTIC V1KF21 1 NP	Total Weight 2,5 kg
	<b>Description</b> Service Assembly			
	<b>ŞEM NO.</b> 72.4390.S2	<b>REF. NO.</b> 9423280101	<b>Technical Specification</b> CONTITECH 4390 N2 PHOENIX 1 KF 21 2 NP FIRESTONE 1R7Z 440 290 C FIRESTONE W01 M58 0905 GOODYEAR 9508 GY SPRINGRIDE D12U26 CF GOMMA REF. 1VSC285 30 CF GOMMA NO. 206784 GART NO. 304.0.441 GART REF. C304 VIBRACOUSTIC V1KF21 2 NP	Total Weight 2,5 kg
	<b>Description</b> Service Assembly			
	<b>ŞEM NO.</b> 72.450.R25	<b>REF. NO.</b> 3563270001 6133270101	<b>Technical Specification</b> CONTITECH RZ 450-R25 PHOENIX 1 E 23 VIBRACOUSTIC V1E23 GOODYEAR 9050 GY SPRINGRIDE D12S13 CF GOMMA REF. 1S300-27	Total Weight 1,5 kg
	<b>Description</b> Roll			
	<b>ŞEM NO.</b> 72.4737.C01	<b>REF. NO.</b> 9463200321	<b>Technical Specification</b> CONTITECH 4737 N P01	Total Weight 8,5 kg
	<b>Description</b> Metal Piston			
	<b>ŞEM NO.</b> 72.4737.C02	<b>REF. NO.</b> 9463200521	<b>Technical Specification</b> CONTITECH 4737 N P02	Total Weight 8,3 kg
	<b>Description</b> Metal Piston			

Technical Specification	REF. NO.		SEM NO.	
Total Weight 8,4 kg	9423203721	CONTITECH 4737 N P21	<b>72.4737.C21</b>	 <p><b>Description</b> Metal Piston</p>
Total Weight 8 kg	9423203921	CONTITECH 4737 N P22	<b>72.4737.C22</b>	 <p><b>Description</b> Metal Piston</p>
Total Weight 7,7 kg	9423200117 9423204321	CONTITECH 4757 N P01 PHOENIX 1 KF 24-21 FIRESTONE 1R7Z-460-305-A FIRESTONE W01-M58-8521 GOODYEAR 9519 GY SPRINGRIDE D13T01 VIBRACOUSTIC V1KF24-1-232	<b>72.4757.C01</b>	 <p><b>Description</b> Metal Piston</p>
Total Weight 7,5 kg	9423203221 9743200217 9743200417	CONTITECH 4757 N P09 PHOENIX 1 KF 24-29 FIRESTONE 1R7Z-460-305-B FIRESTONE W01-M58-8522 GOODYEAR 9520 GY SPRINGRIDE D13T02 VIBRACOUSTIC V1KF24-2-232	<b>72.4757.C09</b>	 <p><b>Description</b> Metal Piston</p>
Total Weight 9 kg	9423200117 9423204321	CONTITECH 4757 N P21 PHOENIX 1 KF 24-21 FIRESTONE 1R7Z-460-305-A FIRESTONE W01-M58-8521 GOODYEAR 9519 GY SPRINGRIDE D13T01 VIBRACOUSTIC V1KF24-1-232	<b>72.4757.C21</b>	 <p><b>Description</b> Metal Piston</p>
Total Weight 9 kg	9423203221 9743200217 9743200417	CONTITECH 4757 N P29 PHOENIX 1 KF 24-29 FIRESTONE 1R7Z-460-305-B FIRESTONE W01-M58-8522 GOODYEAR 9520 GY SPRINGRIDE D13T02 VIBRACOUSTIC V1KF24-2-232	<b>72.4757.C29</b>	 <p><b>Description</b> Metal Piston</p>



	<b>ŞEM NO.</b>	<b>REF. NO.</b>	<b>Technical Specification</b>	
	<b>72.4757.S1</b>	9423270001	CONTITECH 4757 N1 PHOENIX 1 KF 24 1 NP FIRESTONE 1R7Z 460 305 A GART REF. C299/A FIRESTONE W01 M58 0909 GOODYEAR 9517 GY SPRINGRIDE D13U42 GART NO. 299.0.461 VIBRACOUSTIC V1KF24 1 230 NP	Total Weight 2,5 kg
	<b>ŞEM NO.</b>	<b>REF. NO.</b>	<b>Technical Specification</b>	
	<b>72.4757.S2</b>	9743280001 9743280101	CONTITECH 4757 N2 PHOENIX 1 KF 24 2 NP FIRESTONE 1R7Z 460 305 B FIRESTONE W01 M58 0910 GOODYEAR 9518 GY SPRINGRIDE D13U43 GART NO. 299.0.460 GART REF. C299/A VIBRACOUSTIC V1KF24 2 230 NP	Total Weight 3,3 kg
	<b>ŞEM NO.</b>	<b>REF. NO.</b>	<b>Technical Specification</b>	
	<b>72.4758.C21</b>	9423204821 9453200017	CONTITECH 4758 N P21	Total Weight 7,4 kg
	<b>ŞEM NO.</b>	<b>REF. NO.</b>	<b>Technical Specification</b>	
	<b>72.4758.S1</b>	9453270001	CONTITECH 4758 N	Total Weight 2,4 kg
	<b>ŞEM NO.</b>	<b>REF. NO.</b>	<b>Technical Specification</b>	
	<b>72.4759.C</b>	9423200217	CONTITECH 4759 N P01	
	<b>ŞEM NO.</b>	<b>REF. NO.</b>	<b>Technical Specification</b>	
	<b>72.4759.S1</b>	9423270401	CONTITECH 4759 N P01	









Technical Specification	REF. NO.		SEM NO.	
Total Weight 14 kg	9463281501	VIBRACOUSTIC V1DK28F-3 GOODYEAR 1R14-823 WW US 04030P FIRESTONE 1T19L-11 FIRESTONE W01 M58 6223 WW US 04030G	<b>72.4823.C</b>	
			<b>Description</b>	
			Metal Piston	
Technical Specification	REF. NO.		SEM NO.	
Total Weight 8,2 kg	9423203821 9463200421	CONTITECH 4838 N P01 FIRESTONE 1R7Z-595-330-A FIRESTONE W01-M58-8512 VIBRACOUSTIC V1KF25-1-232	<b>72.4838.C01</b>	
			<b>Description</b>	
			Metal Piston	
Technical Specification	REF. NO.		SEM NO.	
Total Weight 9,9 kg	9423203621 9463200221	CONTITECH 4838 N P02 VIBRACOUSTIC V1KF25-2-232	<b>72.4838.C02</b>	
			<b>Description</b>	
			Metal Piston	
Technical Specification	REF. NO.		SEM NO.	
Total Weight 10 kg	9423203521 9463200121	CONTITECH 4838 N P03 VIBRACOUSTIC V1KF25-3-232	<b>72.4838.C03</b>	
			<b>Description</b>	
			Metal Piston	
Technical Specification	REF. NO.		SEM NO.	
Total Weight 8,8 kg	9423203821 9463200421	CONTITECH 4838 N P21 FIRESTONE 1R7Z-595-330-A FIRESTONE W01-M58-8512 VIBRACOUSTIC V1KF25-1-232	<b>72.4838.C21</b>	
			<b>Description</b>	
			Metal Piston	
Technical Specification	REF. NO.		SEM NO.	
Total Weight 10 kg	9423203621 9463200221	CONTITECH 4838 N P22 VIBRACOUSTIC V1KF25-2-232	<b>72.4838.C22</b>	
			<b>Description</b>	
			Metal Piston	







	<b>SEM NO.</b>	<b>REF. NO.</b>	<b>Technical Specification</b>
	72.4838.C23	9423203521 9463200121	CONTITECH 4838 N P23 VIBRACOUSTIC V1KF25-3-232 Total Weight 11 kg
	<b>Description</b>		
			Metal Piston
	<b>SEM NO.</b>	<b>REF. NO.</b>	<b>Technical Specification</b>
	72.644.R	0003270101 6133270001	CONTITECH 644 N PHOENIX 1 E 21 Taurus BL121 VIBRACOUSTIC V1E21 FIRESTONE 1R1A390-295 FIRESTONE W01-095-0118 GOODYEAR 8017 GY SPRINGRIDE D11S01 CF GOMMA REF. 1S285-24 CF GOMMA NO. 92574 DUNLOP UK PNP301470102 GART NO. 276.0.390 GART REF. D276/B Total Weight 1,4 kg
	<b>Description</b>		
			Roll
	<b>SEM NO.</b>	<b>REF. NO.</b>	<b>Technical Specification</b>
	72.661.R	6133270201	CONTITECH 661 N PHOENIX 1 E 25 VIBRACOUSTIC V1E25(-2) FIRESTONE 1R1C390-310 FIRESTONE W01-095-0021 GOODYEAR 8018 Büssing 831 120 144 CF GOMMA REF. 1S310-28 CF GOMMA NO. 91016 GART NO. 297.0.390 GART REF. D297 DUNLOP UK PNP304980101 GY SPRINGRIDE D12S02 Total Weight 1,8 kg
	<b>Description</b>		
			Roll
	<b>SEM NO.</b>	<b>REF. NO.</b>	<b>Technical Specification</b>
	72.673.R	3833270001	CONTITECH 673 N PHOENIX 1 F 21 A Taurus B141 VIBRACOUSTIC V1F21A FIRESTONE 1R1A370-285 FIRESTONE W01-095-0198 BredaMenarini 178 623 GOODYEAR 9051 GY SPRINGRIDE D11S06 Total Weight 1,5 kg
	<b>Description</b>		
			Roll
	<b>SEM NO.</b>	<b>REF. NO.</b>	<b>Technical Specification</b>
	72.715.R	3633280001	CONTITECH 715 N PHOENIX 1 F 25 VIBRACOUSTIC V1F25 FIRESTONE 1R1C335-310 FIRESTONE W01-095-0087 GOODYEAR 8015 CF GOMMA REF. 1SC310-16 CF GOMMA NO. 93518 DUNLOP UK PNP304890101 Total Weight 2 kg
	<b>Description</b>		
			Roll
	<b>SEM NO.</b>	<b>REF. NO.</b>	<b>Technical Specification</b>
	72.720.R	3873280101	3873280101 Total Weight 1,2 kg
	<b>Description</b>		
			Roll

<b>Technical Specification</b>	<b>REF. NO.</b>	<b>SEM NO.</b>	
Total Weight 2,4 kg	3933280101	CONTITECH 737 N PHOENIX 1 F 26 VIBRACOUSTIC V1F26 FIRESTONE 1R2A480-330 FIRESTONE W01-095-0211 GOODYEAR 9075 GY SPRINGRIDE D13S06 Pegaso MODEL 5316 Pegaso MODEL 5317	<b>72.737.R</b>  <b>Description</b> Roll
<b>Technical Specification</b>	<b>REF. NO.</b>	<b>SEM NO.</b>	
Total Weight 1,9 kg	3183280001	CONTITECH 746 N GOODYEAR 9076	<b>72.746.R</b>  <b>Description</b> Roll
<b>Technical Specification</b>	<b>REF. NO.</b>	<b>SEM NO.</b>	
Total Weight 2 kg	3633280201	CONTITECH 757 N PHOENIX 1 F 26 C VIBRACOUSTIC V1F26C GY SPRINGRIDE D12S20 FIRESTONE 1R2A380-305 FIRESTONE W01-095-0212 GOODYEAR 9077	<b>72.757.R</b>  <b>Description</b> Roll
<b>Technical Specification</b>	<b>REF. NO.</b>	<b>SEM NO.</b>	
Total Weight 2,4 kg	6743280001	CONTITECH 838 N PHOENIX 1 F 26 D VIBRACOUSTIC V1F26D GOODYEAR 9074 GY SPRINGRIDE D13S05	<b>72.838.R</b>  <b>Description</b> Roll
<b>Technical Specification</b>	<b>REF. NO.</b>	<b>SEM NO.</b>	
Total Weight 2 kg	6743280101	CONTITECH 873 N	<b>72.873.R</b>  <b>Description</b> Roll
<b>Technical Specification</b>	<b>REF. NO.</b>	<b>SEM NO.</b>	
Total Weight 1,8 kg	6993280101	CONTITECH 882 N1 PHOENIX 1 F 16 VIBRACOUSTIC V1F16 FIRESTONE 1R4R465 260 FIRESTONE W01 095 0435 GOODYEAR 9048 GY SPRINGRIDE D12S12 CF GOMMA REF. 1SC250 28 CF GOMMA NO. 97042 GART NO. 289.0.400 GART REF. C289/D	<b>72.882.R1</b>  <b>Description</b> Roll

	SEM NO.	REF. NO.	Technical Specification
	<b>72.2221.P03</b>	9423270601 9463281601	CONTITECH FD 200-25 1/4 M10 PHOENIX SP 2 B 12 R-A-10 VIBRACOUSTIC VSP2B12RA-10 FIRESTONE 20C-2 Granning 15670 FIRESTONE W01-M58-7679 FIRESTONE W01-968-6771 GOODYEAR 2B9-269
	<b>Description</b>		
	<b>72.2211.P14</b>	9423270601	CONTITECH FD 200-19 P02 FIRESTONE 20F FIRESTONE W01-M58-7756 CF GOMMA REF. T20L CF GOMMA NO. 207065
	<b>Description</b>		Total Weight 2,7 kg

Type / Model	REF. NO.	SEM NO.	
	0015535901 3755530001	8196	 <p><b>Description</b> Hand Pump</p>
Type / Model	REF. NO.	SEM NO.	
	0005538901	8197	 <p><b>Description</b> Hand Pump</p>
Type / Model	REF. NO.	SEM NO.	
	0005537901 3715537001 0005536901 0005532701 0005532301 0005533701 0005536801 0005533901 0005534001	8198	 <p><b>Description</b> Hand Pump</p>
Type / Model	REF. NO.	SEM NO.	
KP 0006	0005539901 0015539901 0015531401	8319	 <p><b>Description</b> Hand Pump</p>
Type / Model	REF. NO.	SEM NO.	
KP 0007	0015533701	8320	 <p><b>Description</b> Hand Pump</p>
Type / Model	REF. NO.	SEM NO.	
	0015533601	8450	 <p><b>Description</b> Hand Pump</p>

	SEM NO.	REF. NO.	Type / Model
	8452	0015533501	
	<b>Description</b>		
	Hand Pump		
	8453	0015533401	
	<b>Description</b>		
	Hand Pump		
	8454	0015533801	
	<b>Description</b>		
	Hand Pump		
	8455	0015534001	
	<b>Description</b>		
	Hand Pump - Long		
	8456	0015534101	
	<b>Description</b>		
	Hand Pump - Long		
	9418	0015533901	
	<b>Description</b>		
	Hand Pump		

Type / Model	REF. NO.	SEM NO.	
	0015533505 0015531605 0015531705 0015539505	<b>8199</b>	
			<b>Description</b> Cylinder D=Ø42 Ax=593
Type / Model	REF. NO.	SEM NO.	
ACTROS	0025531005 0025530905 0025531305 0025531405	<b>8203</b>	
			<b>Description</b> Cylinder D=Ø50 Ax=676
Type / Model	REF. NO.	SEM NO.	
AXOR	0025534405	<b>8204</b>	
			<b>Description</b> Cylinder D=Ø60 Ax=730
Type / Model	REF. NO.	SEM NO.	
AXOR	0025538205	<b>8205</b>	
			<b>Description</b> Cylinder D=Ø60 Ax=505
Type / Model	REF. NO.	SEM NO.	
AXOR	0025538505	<b>8206</b>	
			<b>Description</b> Cylinder D=Ø50 Ax=711
Type / Model	REF. NO.	SEM NO.	
ATEGO	3755530005 9735530005	<b>8207</b>	
			<b>Description</b> Cylinder D=Ø60 Ax=335





ŞEM NO.	REF. NO.	Type / Model
<b>8208</b>	0015530905 0015534205 0005537305 3715537005	4205
	<b>Description</b> Cylinder	
D=Ø50 Ax=622		







ŞEM NO.	REF. NO.	Type / Model
<b>8209</b>	3715537305	
	<b>Description</b> Cylinder	
D=Ø50 Ax=593		

ŞEM NO.	REF. NO.	Type / Model
<b>8210</b>	0015539605 3715537405	
	<b>Description</b> Cylinder	
D=Ø50 Ax=644		

ŞEM NO.	REF. NO.	Type / Model
<b>8211</b>	0015531005 0015534305 3715537105	
	<b>Description</b> Cylinder	
D=Ø50 Ax=678		

ŞEM NO.	REF. NO.	Type / Model
<b>8317</b>	0025539105 0025535705 0025537705	
	<b>Description</b> Cylinder	
D=Ø60 Ax=698		

ŞEM NO.	REF. NO.	Type / Model
<b>8318</b>	0025539205 0025537805 0025535905	
	<b>Description</b> Cylinder	
D=Ø50 Ax=698		

Type / Model	REF. NO.	SEM NO.	
	0025535405 0025536605 0025538405 0025538805	8463	 <b>Description</b> Cylinder D=Ø60 Ax=642
Type / Model	REF. NO.	SEM NO.	
	0015532505	8966	 <b>Description</b> Cylinder D=Ø42 Ax=643
Type / Model	REF. NO.	SEM NO.	
	0025536805	8967	 <b>Description</b> Cylinder D=Ø50 Ax=676
Type / Model	REF. NO.	SEM NO.	
	0005538705 0015534505	9420	 <b>Description</b> Cylinder
Type / Model	REF. NO.	SEM NO.	
	0005533205 0005533705 0005537505 0005534605 0015534605	9421	 <b>Description</b> Cylinder
Type / Model	REF. NO.	SEM NO.	
	3755530305	9422	 <b>Description</b> Cylinder

SEM NO.	REF. NO.	Type / Model
<b>11637</b>	0015533605 0005537005 0005534405 0005536805 0005532805	
<b>Description</b> Cabin Cylinder		



SEM NO.	REF. NO.	Type / Model
<b>11638</b>	0025536405 0025538105	
<b>Description</b> Cabin Cylinder		



SEM NO.	REF. NO.	Type / Model
<b>9638</b>		
<b>Description</b> Repair Kit Oil		



## 4 - 3

Cab Group  
Cab Bushing / Mountings and Repair Kits

SEM NO.	REF. NO.	Type / Model
<b>7534</b>	3093100277	L 408 L 508 O 309
<b>Description</b> Cabin Mounting		



A=80 B=53 h=37 M10

SEM NO.	REF. NO.	Type / Model
<b>7904 (1023)</b>	3753100159 9733100059	
<b>Description</b> Cabin Mounting		















A=50 B=39 h=18,5

SEM NO.	REF. NO.	Type / Model
<b>8513</b>	3093100777 3093100577	
<b>Description</b> Rubber Metal Buffer		



Type / Model	REF. NO.	SEM NO.	
	9403171012 3753170012	<b>7816</b>	 <b>Description</b> Cabin Mounting D=Ø100 d=Ø25 h=120
Type / Model	REF. NO.	SEM NO.	
	9403171112	<b>7817</b>	 <b>Description</b> Cabin Mounting D=Ø100 d=Ø25 h=120
Type / Model	REF. NO.	SEM NO.	
	9423172012	<b>7818</b>	 <b>Description</b> Cabin Mounting D=Ø100 d=Ø25 h=120
Type / Model	REF. NO.	SEM NO.	
	9423172112 9423171312 9423170812	<b>7819</b>	 <b>Description</b> Cabin Mounting D=Ø100 d=Ø25 h=120
Type / Model	REF. NO.	SEM NO.	
	0009921603	<b>8122</b>	 <b>Description</b> Cabin Bushing D=Ø69 d=Ø16 h=64

 <p>D=Ø99 d=Ø58 h=70</p>	<table border="1"> <thead> <tr> <th>SEM NO.</th> <th>REF. NO.</th> </tr> </thead> <tbody> <tr> <td><b>8123</b></td> <td>9703170112 9583170012</td> </tr> </tbody> </table> <p><b>Description</b> Cabin Bushing</p>	SEM NO.	REF. NO.	<b>8123</b>	9703170112 9583170012	<table border="1"> <thead> <tr> <th>Type / Model</th> </tr> </thead> </table>	Type / Model
SEM NO.	REF. NO.						
<b>8123</b>	9703170112 9583170012						
Type / Model							
 <p>D=Ø73 d=Ø55 h=69</p>	<table border="1"> <thead> <tr> <th>SEM NO.</th> <th>REF. NO.</th> </tr> </thead> <tbody> <tr> <td><b>8124</b></td> <td>9703170450 9583170250</td> </tr> </tbody> </table> <p><b>Description</b> Cabin Plastic Bushing</p>	SEM NO.	REF. NO.	<b>8124</b>	9703170450 9583170250	<table border="1"> <thead> <tr> <th>Type / Model</th> </tr> </thead> </table>	Type / Model
SEM NO.	REF. NO.						
<b>8124</b>	9703170450 9583170250						
Type / Model							
 <p>D=Ø65 d=Ø16 h=64</p>	<table border="1"> <thead> <tr> <th>SEM NO.</th> <th>REF. NO.</th> </tr> </thead> <tbody> <tr> <td><b>8175</b></td> <td>9423172212 9423100277 9423100077</td> </tr> </tbody> </table> <p><b>Description</b> Cabin Bushing</p>	SEM NO.	REF. NO.	<b>8175</b>	9423172212 9423100277 9423100077	<table border="1"> <thead> <tr> <th>Type / Model</th> </tr> </thead> </table>	Type / Model
SEM NO.	REF. NO.						
<b>8175</b>	9423172212 9423100277 9423100077						
Type / Model							
 <p>D=Ø96 d=Ø40 h=47</p>	<table border="1"> <thead> <tr> <th>SEM NO.</th> <th>REF. NO.</th> </tr> </thead> <tbody> <tr> <td><b>8192</b></td> <td>9423171812 9303170012</td> </tr> </tbody> </table> <p><b>Description</b> Cabin Bushing</p>	SEM NO.	REF. NO.	<b>8192</b>	9423171812 9303170012	<table border="1"> <thead> <tr> <th>Type / Model</th> </tr> </thead> </table>	Type / Model
SEM NO.	REF. NO.						
<b>8192</b>	9423171812 9303170012						
Type / Model							
 <p>D=Ø65 d=Ø16 h64</p>	<table border="1"> <thead> <tr> <th>SEM NO.</th> <th>REF. NO.</th> </tr> </thead> <tbody> <tr> <td><b>8230</b></td> <td>9423172312</td> </tr> </tbody> </table> <p><b>Description</b> Cabin Bushing</p>	SEM NO.	REF. NO.	<b>8230</b>	9423172312	<table border="1"> <thead> <tr> <th>Type / Model</th> </tr> </thead> </table>	Type / Model
SEM NO.	REF. NO.						
<b>8230</b>	9423172312						
Type / Model							
 <p>D=Ø59 d=Ø25 h=53</p>	<table border="1"> <thead> <tr> <th>SEM NO.</th> <th>REF. NO.</th> </tr> </thead> <tbody> <tr> <td><b>10248</b></td> <td>9423170069 9413170069</td> </tr> </tbody> </table> <p><b>Description</b> Rubber Metal Buffer</p>	SEM NO.	REF. NO.	<b>10248</b>	9423170069 9413170069	<table border="1"> <thead> <tr> <th>Type / Model</th> </tr> </thead> </table>	Type / Model
SEM NO.	REF. NO.						
<b>10248</b>	9423170069 9413170069						
Type / Model							

<b>Type / Model</b>	<b>REF. NO.</b>	<b>SEM NO.</b>	<b>Description</b>	
	3878910277	<b>11761</b>	Cabin Bushing	
				
<b>Type / Model</b>	<b>REF. NO.</b>	<b>SEM NO.</b>	<b>Description</b>	
	3878911910	<b>7809</b>	Rubber Buffer	
				D=Ø59 d=Ø20 h=12
<b>Type / Model</b>	<b>REF. NO.</b>	<b>SEM NO.</b>	<b>Description</b>	
	9408910023 3759980040	<b>7966</b>	Cabin Mounting	
				D=Ø61 d=Ø9 h=32
<b>Type / Model</b>	<b>REF. NO.</b>	<b>SEM NO.</b>	<b>Description</b>	
	9428910423 3759980140	<b>7967</b>	Cabin Mounting	
				D=Ø61 d=Ø9 h=11
<b>Type / Model</b>	<b>REF. NO.</b>	<b>SEM NO.</b>	<b>Description</b>	
	3638910617	<b>9064</b>	Cabin Bush	
				D=Ø34 d=Ø25 h=43
<b>Type / Model</b>	<b>REF. NO.</b>	<b>SEM NO.</b>	<b>Description</b>	
	0009817231	<b>9065</b>	Bearing	
				D=Ø35 d=Ø20 h=16

Description / Repair Kit for Cabin (Alternative Bearing)	SEM NO.	Model:																					
	<b>7779</b>																						
	<b>REF. NO:</b> 3873100077 3875860131	<table border="1"> <thead> <tr> <th>Item No</th> <th>Ref. No</th> </tr> </thead> <tbody> <tr><td>1</td><td>3873170674</td></tr> <tr><td>2</td><td>3638970617</td></tr> <tr><td>3</td><td>3878911910</td></tr> <tr><td>4</td><td>-----</td></tr> <tr><td>5</td><td>000417008004</td></tr> <tr><td>6</td><td>913004012001-913004012003-913004012008</td></tr> <tr><td>7</td><td>000125 013008-1409900840</td></tr> <tr><td>8</td><td>6203170176</td></tr> <tr><td>9</td><td>0009817231-0009810931-06369500208</td></tr> <tr><td>10</td><td>071412008200-063800702202-5005097016</td></tr> </tbody> </table>	Item No	Ref. No	1	3873170674	2	3638970617	3	3878911910	4	-----	5	000417008004	6	913004012001-913004012003-913004012008	7	000125 013008-1409900840	8	6203170176	9	0009817231-0009810931-06369500208	10
Item No	Ref. No																						
1	3873170674																						
2	3638970617																						
3	3878911910																						
4	-----																						
5	000417008004																						
6	913004012001-913004012003-913004012008																						
7	000125 013008-1409900840																						
8	6203170176																						
9	0009817231-0009810931-06369500208																						
10	071412008200-063800702202-5005097016																						



Description / Repair Kit for Cabin (Original Bearing)	SEM NO.	Model:																					
	<b>7779-1</b>																						
	<b>REF. NO:</b> 3873100077 3875860131	<table border="1"> <thead> <tr> <th>Item No</th> <th>Ref. No</th> </tr> </thead> <tbody> <tr><td>1</td><td>3873170674</td></tr> <tr><td>2</td><td>3638970617</td></tr> <tr><td>3</td><td>3878911910</td></tr> <tr><td>4</td><td>-----</td></tr> <tr><td>5</td><td>000417008004</td></tr> <tr><td>6</td><td>913004012001-913004012003-913004012008</td></tr> <tr><td>7</td><td>000125 013008-1409900840</td></tr> <tr><td>8</td><td>6203170176</td></tr> <tr><td>9</td><td>0009817231-0009810931-06369500208</td></tr> <tr><td>10</td><td>071412008200-063800702202-5005097016</td></tr> </tbody> </table>	Item No	Ref. No	1	3873170674	2	3638970617	3	3878911910	4	-----	5	000417008004	6	913004012001-913004012003-913004012008	7	000125 013008-1409900840	8	6203170176	9	0009817231-0009810931-06369500208	10
Item No	Ref. No																						
1	3873170674																						
2	3638970617																						
3	3878911910																						
4	-----																						
5	000417008004																						
6	913004012001-913004012003-913004012008																						
7	000125 013008-1409900840																						
8	6203170176																						
9	0009817231-0009810931-06369500208																						
10	071412008200-063800702202-5005097016																						













Description / Repair Kit (Kabin)	SEM NO.	Model:
	<b>11758</b>	
	<b>REF. NO:</b> 3875860531 6203100077 3003100077 3878910957	

Description / Cabin Bushing	SEM NO.	Model:
	<b>11759</b>	
	<b>REF. NO:</b> 9425000050	







Model:	SEM NO.	Description / Bushing
	12043	
	REF. NO: 9423170276	
	d=Ø40 D=Ø62 H=4	

Model:	SEM NO.	Description / Cabin Bushing
	13029	
	REF. NO: 9423100049	

	<table border="1"> <thead> <tr> <th>SEM NO.</th> <th>REF. NO.</th> <th>Type / Model</th> </tr> </thead> <tbody> <tr> <td>8159</td> <td>9428900119 9428902919 MONROE CB0089 SACHS 105392</td> <td>ACTROS</td> </tr> <tr> <td colspan="3"><b>Description</b></td> </tr> <tr> <td colspan="3">Cabin Suspansion Spring Wit Shock Absorber</td> </tr> </tbody> </table>	SEM NO.	REF. NO.	Type / Model	8159	9428900119 9428902919 MONROE CB0089 SACHS 105392	ACTROS	<b>Description</b>			Cabin Suspansion Spring Wit Shock Absorber		
SEM NO.	REF. NO.	Type / Model											
8159	9428900119 9428902919 MONROE CB0089 SACHS 105392	ACTROS											
<b>Description</b>													
Cabin Suspansion Spring Wit Shock Absorber													
	<table border="1"> <thead> <tr> <th>SEM NO.</th> <th>REF. NO.</th> <th>Type / Model</th> </tr> </thead> <tbody> <tr> <td>8160</td> <td>9428900219 9428906019 SACHS NEW 311189 SACHS OLD 290997 MONROE Cb0090</td> <td>ACTROS</td> </tr> <tr> <td colspan="3"><b>Description</b></td> </tr> <tr> <td colspan="3">Cabin Suspansion Spring Wit Shock Absorber</td> </tr> </tbody> </table>	SEM NO.	REF. NO.	Type / Model	8160	9428900219 9428906019 SACHS NEW 311189 SACHS OLD 290997 MONROE Cb0090	ACTROS	<b>Description</b>			Cabin Suspansion Spring Wit Shock Absorber		
SEM NO.	REF. NO.	Type / Model											
8160	9428900219 9428906019 SACHS NEW 311189 SACHS OLD 290997 MONROE Cb0090	ACTROS											
<b>Description</b>													
Cabin Suspansion Spring Wit Shock Absorber													
	<table border="1"> <thead> <tr> <th>SEM NO.</th> <th>REF. NO.</th> <th>Type / Model</th> </tr> </thead> <tbody> <tr> <td>8166</td> <td>9438903819 9438905919 9428905319 MONROE CB0115 SACHS NEW 311 663 SACHS OLD 290 998</td> <td>ACTROS</td> </tr> <tr> <td colspan="3"><b>Description</b></td> </tr> <tr> <td colspan="3">Cabin Suspansion Spring Wit Shock Absorber</td> </tr> </tbody> </table>	SEM NO.	REF. NO.	Type / Model	8166	9438903819 9438905919 9428905319 MONROE CB0115 SACHS NEW 311 663 SACHS OLD 290 998	ACTROS	<b>Description</b>			Cabin Suspansion Spring Wit Shock Absorber		
SEM NO.	REF. NO.	Type / Model											
8166	9438903819 9438905919 9428905319 MONROE CB0115 SACHS NEW 311 663 SACHS OLD 290 998	ACTROS											
<b>Description</b>													
Cabin Suspansion Spring Wit Shock Absorber													
	<table border="1"> <thead> <tr> <th>SEM NO.</th> <th>REF. NO.</th> <th>Type / Model</th> </tr> </thead> <tbody> <tr> <td>8167</td> <td></td> <td></td> </tr> <tr> <td colspan="3"><b>Description</b></td> </tr> <tr> <td colspan="3">Cabin Suspansion Spring Wit Shock Absorber</td> </tr> </tbody> </table>	SEM NO.	REF. NO.	Type / Model	8167			<b>Description</b>			Cabin Suspansion Spring Wit Shock Absorber		
SEM NO.	REF. NO.	Type / Model											
8167													
<b>Description</b>													
Cabin Suspansion Spring Wit Shock Absorber													
	<table border="1"> <thead> <tr> <th>SEM NO.</th> <th>REF. NO.</th> <th>Type / Model</th> </tr> </thead> <tbody> <tr> <td>12816</td> <td> 9428906119 SACHS 311664</td> <td>ACTROS</td> </tr> <tr> <td colspan="3"><b>Description</b></td> </tr> <tr> <td colspan="3">Shock Absorber For Kabin</td> </tr> </tbody> </table>	SEM NO.	REF. NO.	Type / Model	12816	 9428906119 SACHS 311664	ACTROS	<b>Description</b>			Shock Absorber For Kabin		
SEM NO.	REF. NO.	Type / Model											
12816	 9428906119 SACHS 311664	ACTROS											
<b>Description</b>													
Shock Absorber For Kabin													
	<table border="1"> <thead> <tr> <th>SEM NO.</th> <th>REF. NO.</th> <th>Type / Model</th> </tr> </thead> <tbody> <tr> <td>12817</td> <td> 9428905219 MONROE CB 0108</td> <td>ACTROS</td> </tr> <tr> <td colspan="3"><b>Description</b></td> </tr> <tr> <td colspan="3">Shock Absorber For Kabin</td> </tr> </tbody> </table>	SEM NO.	REF. NO.	Type / Model	12817	 9428905219 MONROE CB 0108	ACTROS	<b>Description</b>			Shock Absorber For Kabin		
SEM NO.	REF. NO.	Type / Model											
12817	 9428905219 MONROE CB 0108	ACTROS											
<b>Description</b>													
Shock Absorber For Kabin													

Type / Model	REF. NO.	SEM NO.	
AXOR	9428904919 SACHS 721700003575	<b>12818</b>	
			<b>Description</b>
			Shock Absorber For Kabin
Type / Model	REF. NO.	SEM NO.	
OPEN LENGTH=208	9428900419	<b>10881</b>	
CLOSED LENGTH=164	9583170703		
UPPER MOUNT	9428900519		
DIMENSION=12x32	9428901519		
LOWER MOUNT	9438902419		
DIMENSION=12x32	SACHS 290268		
Front AXOR			<b>Description</b>
			Shock Absorber
Type / Model	REF. NO.	SEM NO.	
OPEN LENGTH=372	9428904719	<b>10882</b>	
CLOSED LENGTH=302	SACHS 131275		
UPPER MOUNT	MONROE C60096		
DIMENSION=12x40			
LOWER MOUNT			
DIMENSION=12x32			
ACTROS			<b>Description</b>
			Shock Absorber

	<b>SEM NO.</b> 049	<b>REF. NO.</b>	<b>Type / Model</b> 25.21
<b>Description</b> Sealing Strip			
	<b>SEM NO.</b> 050	<b>REF. NO.</b> 3816710020	<b>Type / Model</b> 25.21
<b>Description</b> Frame Cpn			
	<b>SEM NO.</b> 7668	<b>REF. NO.</b> 6202680097	<b>Type / Model</b>
<b>Description</b> Bellows			
	<b>SEM NO.</b> 7768	<b>REF. NO.</b> 1102910182 1072910182	<b>Type / Model</b>
<b>Description</b> Cover			

71x72x13

Type / Model	REF. NO.	SEM NO.
ACTROS	9415220067	8602
		<b>Description</b> Rubber Buffer
		205x40x19



Type / Model	REF. NO.	SEM NO.
	9415220167	9446
		<b>Description</b> Rubber Buffer



SEM NO.	REF. NO.	Type / Model
8380 (9731)	3719800064	25 21



**Description**

Pressure Spring

SEM NO.	REF. NO.	Type / Model
8381	0009809064 0009806264	18 44



**Description**

Pressure Spring

220 N

SEM NO.	REF. NO.	Type / Model
8382	0019808464	18 40 18 48



**Description**

Pressure Spring

610 MM 360 N

SEM NO.	REF. NO.	Type / Model
8383		25 17 26 22



**Description**

Pressure Spring

735 MM 270 N

SEM NO.	REF. NO.	Type / Model
8809	0019809764	



**Description**

Pressure Spring

390 mm 400N







SEM NO.	REF. NO.	Type / Model
8810	0009809264	



**Description**

Pressure Spring

610 mm 350N

Type / Model	REF. NO.	SEM NO.
	0009806964 0009804964 0007503180	9214
		<b>Description</b> Pressure Spring
		540-490N
		
Type / Model	REF. NO.	SEM NO.
	6297500436	9215
		<b>Description</b> Pressure Spring
		753-220N
		
Type / Model	REF. NO.	SEM NO.
	6297500836	9216
		<b>Description</b> Pressure Spring
		270-80N
		
Type / Model	REF. NO.	SEM NO.
	6297501536	9217
		<b>Description</b> Pressure Spring
		350-200N
		
Type / Model	REF. NO.	SEM NO.
	0029801564	9218
		<b>Description</b> Pressure Spring
		685-500N
		
Type / Model	REF. NO.	SEM NO.
	6297502036	9219
		<b>Description</b> Pressure Spring
		730-1050N
		



SEM NO.	REF. NO.	Type / Model
9220	0009807064 0009801064	
 <p><b>Description</b> Pressure Spring</p>		
538-490N		







SEM NO.	REF. NO.	Type / Model
9221	0007503080 0009804864	
 <p><b>Description</b> Pressure Spring</p>		
535-330N		

SEM NO.	REF. NO.	Type / Model
9222	6297500236	
 <p><b>Description</b> Pressure Spring</p>		
750-320N		

SEM NO.	REF. NO.	Type / Model
9223	6297500336	
 <p><b>Description</b> Pressure Spring</p>		
750-420N.		

SEM NO.	REF. NO.	Type / Model
9224	6297500536	
 <p><b>Description</b> Pressure Spring</p>		
750-520N.		

SEM NO.	REF. NO.	Type / Model
9225	6297501936	
 <p><b>Description</b> Pressure Spring</p>		
730-900N		

Type / Model	REF. NO.	SEM NO.
	6297501236	9730
		 <p><b>Description</b> Pressure Spring 585-255-800N.</p>
Type / Model	REF. NO.	SEM NO.
Tourismo	6297501636	10644
		 <p><b>Description</b> Pressure Spring 348-140-100N.</p>
Type / Model	REF. NO.	SEM NO.
Tourismo	6297500636	10645
		 <p><b>Description</b> Pressure Spring 485-205-600N.</p>
Type / Model	REF. NO.	SEM NO.
Tourismo - Integro	6297500936	10646
		 <p><b>Description</b> Pressure Spring 580-255-520N.</p>
Type / Model	REF. NO.	SEM NO.
Travego	0007500336	10647
		 <p><b>Description</b> Pressure Spring 582-215-150N.</p>
Type / Model	REF. NO.	SEM NO.
Travego	6297500736	10648
		 <p><b>Description</b> Pressure Spring 585-255-700N.</p>

SEM NO.	REF. NO.	Type / Model
<b>10649</b>	6297501136	Travego
 <p><b>Description</b> Pressure Spring</p>		
740-300-900N.		





SEM NO.	REF. NO.	Type / Model
<b>10650</b> (11014)	6297502236	Setra S417SDH
 <p><b>Description</b> Pressure Spring</p>		
760-312-770N.		





SEM NO.	REF. NO.	Type / Model
<b>10651</b> (11054)	0009881501	AXOR
 <p><b>Description</b> Pressure Spring</p>		
515-190-120N.		





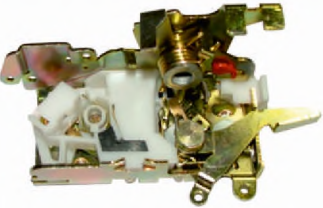
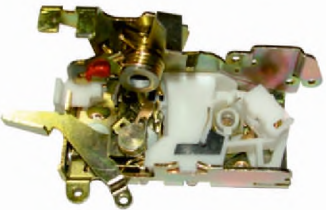

SEM NO.	REF. NO.	Type / Model
<b>11009</b>	0019804964	
 <p><b>Description</b> Pressure Spring</p>		
205-500N		

SEM NO.	REF. NO.	Type / Model
<b>11010</b>	0007502480	
 <p><b>Description</b> Pressure Spring</p>		
425-440N		

SEM NO.	REF. NO.	Type / Model
<b>11011</b>	0007502580	
 <p><b>Description</b> Pressure Spring</p>		
425-550N		

Type / Model	REF. NO.	SEM NO.
	0007502980	<b>11012</b> (11051)
		
		<b>Description</b> Pressure Spring
		536-220N
Type / Model	REF. NO.	SEM NO.
	0007502880	<b>11013</b>
		
		<b>Description</b> Pressure Spring
		537-170N
Type / Model	REF. NO.	SEM NO.
	0007502280	<b>11052</b>
		
		<b>Description</b> Pressure Spring
		425-220N
Type / Model	REF. NO.	SEM NO.
	0007502380	<b>11053</b>
		
		<b>Description</b> Pressure Spring
		425-330N
Type / Model	REF. NO.	SEM NO.
	6329700064	<b>11055</b>
		
		<b>Description</b> Pressure Spring
		215-450N

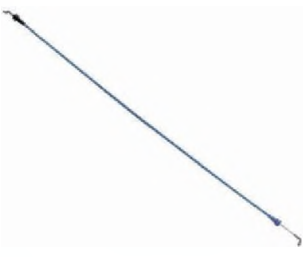
	SEM NO.	REF. NO.	Type / Model
	8193	9423100383	
	<b>Description</b>		
	Cabin Locked (Right)		
	SEM NO.	REF. NO.	Type / Model
	8194	9423100283	
	<b>Description</b>		
	Cabin Locked (Left)		
	SEM NO.	REF. NO.	Type / Model
	9403	9423100483 9303100083	
	<b>Description</b>		
	Cabin Locked		
	SEM NO.	REF. NO.	Type / Model
	11538	9737200735	
	<b>Description</b>		
	Door Catch L		
	SEM NO.	REF. NO.	Type / Model
	11539	9737200835	
	<b>Description</b>		
	Door Catch R		
	SEM NO.	REF. NO.	Type / Model
	9478	9737600004	Axor
	<b>Description</b>		
	Pull Right White		

<b>Type / Model</b>	<b>REF. NO.</b>	<b>SEM NO.</b>	
Axor	9737600104	9479	
			<b>Description</b> Pull Right Green
<b>Type / Model</b>	<b>REF. NO.</b>	<b>SEM NO.</b>	
Axor	9737600204	9480	
			<b>Description</b> Pull Righth Long
<b>Type / Model</b>	<b>REF. NO.</b>	<b>SEM NO.</b>	
Axor	9737600304	9481	
			<b>Description</b> Pull Righth Long
<b>Type / Model</b>	<b>REF. NO.</b>	<b>SEM NO.</b>	
Actros	0007200113	9482	
			<b>Description</b> Pull Righth Green
<b>Type / Model</b>	<b>REF. NO.</b>	<b>SEM NO.</b>	
Actros	0007200213	9483	
			<b>Description</b> Pull Righth Blue
<b>Type / Model</b>	<b>REF. NO.</b>	<b>SEM NO.</b>	
Actros	0007200513	10296	
			<b>Description</b> Door Window Cable



ŞEM NO.	REF. NO.	Type / Model
11298	3553505133S	

**Description**  
Planetary Carrier



ŞEM NO.	REF. NO.	Type / Model
11299	3463501533S 3553502533S 3463509233S	26.281 OM 355

**Description**  
Planetary Carrier



ŞEM NO.	REF. NO.	Type / Model
11300	3463507433S 3463507533S	4140 3340

**Description**  
Planetary Carrier

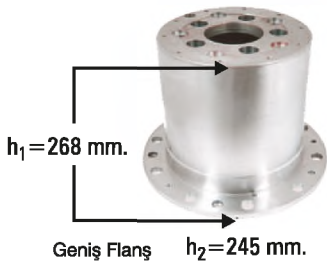

ŞEM NO.	REF. NO.	Type / Model
11301	0003500533S 3463507133S 3463507033S	AXOR 3240 AXOR 4140 ACTROS 3346

**Description**  
Planetary Carrier

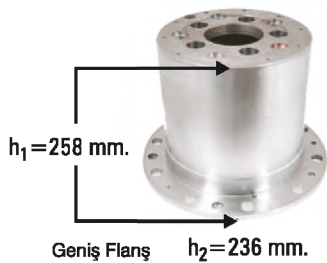

ŞEM NO.	REF. NO.	Type / Model
11302	9423501309S1	AXOR 1835 1840

**Description**  
Planetary Carrier

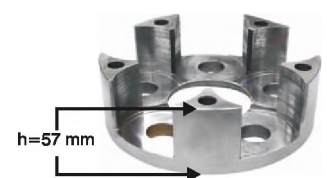

ŞEM NO.	REF. NO.	Type / Model
11304	3553505133S1	

**Description**  
Planetary Carrier

57 mm



Type / Model	REF. NO.	ŞEM NO.	
2521 2524 3031 2628	3553502533S1 3463501533S1 3463509233S1	11305	 <p><b>Description</b> Planetary Carrier</p> <p style="text-align: right;">67 mm</p>
Type / Model	REF. NO.	ŞEM NO.	
2521 2524 3031 2628	3463507433S1 3463507533S1	11306	 <p><b>Description</b> Planetary Carrier</p> <p style="text-align: right;">77 mm</p>
Type / Model	REF. NO.	ŞEM NO.	
	3553505133	9732	 <p><b>Description</b> Bell Hub</p> <p style="text-align: right;">h : 265 mm d : 240 mm</p>
Type / Model	REF. NO.	ŞEM NO.	
OM 355	3553502533 3463501533 3463509233	9734	 <p><b>Description</b> Bell Hub</p> <p style="text-align: right;">h : 275 mm d : 250 mm</p>
Type / Model	REF. NO.	ŞEM NO.	
	3463507433 3463507533	9735	 <p><b>Description</b> Bell Hub</p> <p style="text-align: right;">h : 285 mm d : 260 mm</p>
Type / Model	REF. NO.	ŞEM NO.	
AXOR	3463507133	9736	 <p><b>Description</b> Bell Hub</p> <p style="text-align: right;">Large Flange h:270 mm d:245 mm</p>

	ŞEM NO.	REF. NO.	Type / Model
	9738	9423501309S	AXOR 1835 1840
	<b>Description</b> Bell Hub Large Flange h:260 mm d:235 mm		







	ŞEM NO.	REF. NO.	Type / Model
	11998	3463504209 9423501609	
	<b>Description</b> Planetary Carrier/Full		

	ŞEM NO.	REF. NO.	Type / Model
	11999	3463503909	
	<b>Description</b> Planetary Carrier/Full		

	ŞEM NO.	REF. NO.	Type / Model
	9743	3553500254S	
	<b>Description</b> Planet Carrier Full Short		

	ŞEM NO.	REF. NO.	Type / Model
	9741	3553500254	
	<b>Description</b> Planet Gear Full Q 45 x 75x31x34 mm		

	ŞEM NO.	REF. NO.	Type / Model
	10799	3463500654	
	<b>Description</b> Planet Gear Full / 17 Team Q 45 x 75 x 41 x 44 mm		

<b>Type / Model</b>	<b>REF. NO.</b>	<b>ŞEM NO.</b>	 Q 45 X 85 X 51 X 54 mm
AXOR 4140 AXOR 3340 ACTROS	3553500454	11309	
<b>Description</b> Planet Gear Full / 24 Team			
<b>Type / Model</b>	<b>REF. NO.</b>	<b>ŞEM NO.</b>	 Z = 23 i = 3.48
SMALL DIFFERENTIAL SL 200	3553540417	9816 (9817)	
<b>Description</b> Sun Gear			
<b>Type / Model</b>	<b>REF. NO.</b>	<b>ŞEM NO.</b>	 Z=23
	3463540417	10800	
<b>Description</b> Sun Gear 23 T			
<b>Type / Model</b>	<b>REF. NO.</b>	<b>ŞEM NO.</b>	 Z=25
AXOR 4140 AXOR 3340 ACTROS	3463542517	11310	
<b>Description</b> Sun Gear 25 t			
<b>Type / Model</b>	<b>REF. NO.</b>	<b>ŞEM NO.</b>	
	6243560020	9849	
<b>Description</b> Hub Cap			
<b>Type / Model</b>	<b>REF. NO.</b>	<b>ŞEM NO.</b>	
	3273560120	11350	
<b>Description</b> Axle Tube Cover / Welded			

	ŞEM NO.	REF. NO.	Type / Model
	9877	3463541662	
	<b>Description</b>		
	Thrust Washer		

	ŞEM NO.	REF. NO.	Type / Model
	11327	3463541762	ACTROS
	<b>Description</b>		
	Thrust Washer		

	ŞEM NO.	REF. NO.	Type / Model
	7319	0019976848 0029974248 0279972248 0169979548 0169974048	
	<b>Description</b>		
	Toric Seal		







D=Ø255 d=Ø5 D=Ø240 d=Ø5.3

	ŞEM NO.	REF. NO.	Type / Model
	9982	9433300856	AXOR
	<b>Description</b>		
	Expansion Plug And Grease Nipple		

12x1,5x80

	ŞEM NO.	REF. NO.	Type / Model
	9983	6563300088	AXOR
	<b>Description</b>		
	Nut (Steel)		

	ŞEM NO.	REF. NO.	Type / Model
	9984	3893320072	2517 2521 2524
	<b>Description</b>		
	Nut (Steel)		

Type / Model	REF. NO.	ŞEM NO.	
AXOR	9423320362	9985	 <p><b>Description</b> Thrust Washer</p>
STELL SMALL DIFFERENTIAL 2521	3873505923	9744	 <p><b>Description</b> Supporter type without gear</p>
STELL SMALL DIFFERENTIAL WITH SCREW 2521	3873505923S	9746	 <p><b>Description</b> Differential Small Case Bearing (Steel)</p>
STELL SMALL DIFFERENTIAL WITHOUT SCREW 2521	3873505923S1	9747	 <p><b>Description</b> Differential Small Case Bearing (Steel)</p>
SMALL DIFFERENTIAL 2521	3953500040	9749	 <p><b>Description</b> Axle introduction - Repair Kit</p>
STELL SMALL DIFFERENTIAL	3873501323	9759	 <p><b>Description</b> Axle introduction / Small Bushing (Steel)</p>



SEM NO.	REF. NO.	Type / Model
9761	3553500227	STELL SMALL DIFFERENTIAL WITH SCREW 2622 2628 26.281
<b>Description</b>		
Differential Case / Small Bushing (Steel)		



SEM NO.	REF. NO.	Type / Model
9763	3935860035	SMALL DIFFERENTIAL WITH YELLOW BUSH 2622 2628
<b>Description</b>		
Repair Kit Diffrential - Small Bushing Differential Repair Kit / Bushing		



SEM NO.	REF. NO.	Type / Model
9776	9443500523	LONG AXOR 3028
<b>Description</b>		
Diff. Case / Differential Small Screw		



h : 163 mm

SEM NO.	REF. NO.	Type / Model
9777	9443500623	SHORT AXOR 3028
<b>Description</b>		
Differential Case / Short		









h : 153 mm

SEM NO.	REF. NO.	Type / Model
9778	9443500623S	AXOR 3028
<b>Description</b>		
Repair Kit / Lagging		









SEM NO.	REF. NO.	Type / Model
9779	9443500523S	AXOR 3028
<b>Description</b>		
Repair Kit / Screw		











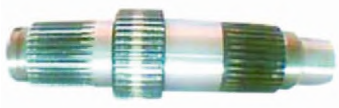



Type / Model	REF. NO.	ŞEM NO.	
FRONT DIFFERENTIAL AXOR 3028	9443500623S1	9780	 <p><b>Description</b> Full Differential Gear / Lagging</p>
LONG REAR DIFFERENTIAL AXOR 3028	9443500523S1	9781	 <p><b>Description</b> Differential Gear / Screw / Long</p> <p style="text-align: right;">h : 163 mm</p>
AXOR 3028	9443530328	9782	 <p><b>Description</b> Oil Collector</p>
BIG DIFFERENTIAL AXOR 4140	9423502123	9783	 <p><b>Description</b> Differential Gear</p>
BIG DIFFERENTIAL AXOR 4140	9423502123S	9785	 <p><b>Description</b> Differential Case</p>
BIG DIFFERENTIAL AXOR 4140	9423530428	9787	 <p><b>Description</b> Oil Collector</p>















	<table border="1"> <thead> <tr> <th>ŞEM NO.</th> <th>REF. NO.</th> <th>Type / Model</th> </tr> </thead> <tbody> <tr> <td>9789</td> <td>9423502123S1</td> <td>AXOR 4140</td> </tr> <tr> <td colspan="3"><b>Description</b></td> </tr> <tr> <td colspan="3">Big Differential Repair Kit / Screw</td> </tr> </tbody> </table>	ŞEM NO.	REF. NO.	Type / Model	9789	9423502123S1	AXOR 4140	<b>Description</b>			Big Differential Repair Kit / Screw			
ŞEM NO.	REF. NO.	Type / Model												
9789	9423502123S1	AXOR 4140												
<b>Description</b>														
Big Differential Repair Kit / Screw														
	<table border="1"> <thead> <tr> <th>ŞEM NO.</th> <th>REF. NO.</th> <th>Type / Model</th> </tr> </thead> <tbody> <tr> <td>9804</td> <td>3463500427</td> <td>BIG DIFFERENTIAL WITH SCREW</td> </tr> <tr> <td colspan="3"><b>Description</b></td> </tr> <tr> <td colspan="3">Differential Case</td> </tr> </tbody> </table>	ŞEM NO.	REF. NO.	Type / Model	9804	3463500427	BIG DIFFERENTIAL WITH SCREW	<b>Description</b>			Differential Case			
ŞEM NO.	REF. NO.	Type / Model												
9804	3463500427	BIG DIFFERENTIAL WITH SCREW												
<b>Description</b>														
Differential Case														
	<table border="1"> <thead> <tr> <th>ŞEM NO.</th> <th>REF. NO.</th> <th>Type / Model</th> </tr> </thead> <tbody> <tr> <td>9805</td> <td>3873500040</td> <td>BIG DIFFERENTIAL WITH SCREW</td> </tr> <tr> <td colspan="3"><b>Description</b></td> </tr> <tr> <td colspan="3">Repair Kit / Differential Big Bushing</td> </tr> </tbody> </table>	ŞEM NO.	REF. NO.	Type / Model	9805	3873500040	BIG DIFFERENTIAL WITH SCREW	<b>Description</b>			Repair Kit / Differential Big Bushing			
ŞEM NO.	REF. NO.	Type / Model												
9805	3873500040	BIG DIFFERENTIAL WITH SCREW												
<b>Description</b>														
Repair Kit / Differential Big Bushing														
	<table border="1"> <thead> <tr> <th>ŞEM NO.</th> <th>REF. NO.</th> <th>Type / Model</th> </tr> </thead> <tbody> <tr> <td>9807</td> <td>3463508123</td> <td></td> </tr> <tr> <td colspan="3"><b>Description</b></td> </tr> <tr> <td colspan="3">Full Differential Case Differential Big Bushing</td> </tr> </tbody> </table>	ŞEM NO.	REF. NO.	Type / Model	9807	3463508123		<b>Description</b>			Full Differential Case Differential Big Bushing			
ŞEM NO.	REF. NO.	Type / Model												
9807	3463508123													
<b>Description</b>														
Full Differential Case Differential Big Bushing														
	<table border="1"> <thead> <tr> <th>ŞEM NO.</th> <th>REF. NO.</th> <th>Type / Model</th> </tr> </thead> <tbody> <tr> <td>9818</td> <td>3463500527</td> <td>WITH SCREW</td> </tr> <tr> <td colspan="3"><b>Description</b></td> </tr> <tr> <td colspan="3">Big Differential Case</td> </tr> </tbody> </table>	ŞEM NO.	REF. NO.	Type / Model	9818	3463500527	WITH SCREW	<b>Description</b>			Big Differential Case			
ŞEM NO.	REF. NO.	Type / Model												
9818	3463500527	WITH SCREW												
<b>Description</b>														
Big Differential Case														
	<table border="1"> <thead> <tr> <th>ŞEM NO.</th> <th>REF. NO.</th> <th>Type / Model</th> </tr> </thead> <tbody> <tr> <td>9821</td> <td>3553501827</td> <td>WITH SCREW AXOR 3028 3031</td> </tr> <tr> <td colspan="3"><b>Description</b></td> </tr> <tr> <td colspan="3">Small Differential Case</td> </tr> </tbody> </table>	ŞEM NO.	REF. NO.	Type / Model	9821	3553501827	WITH SCREW AXOR 3028 3031	<b>Description</b>			Small Differential Case			
ŞEM NO.	REF. NO.	Type / Model												
9821	3553501827	WITH SCREW AXOR 3028 3031												
<b>Description</b>														
Small Differential Case														

Type / Model	REF. NO.	ŞEM NO.	
2631 3031	3553501827S 3553501827- 1 Pcs. 3553500128- 1 Pcs. 3553530214- 1 Pcs. 3553530176- 4 Pcs. 3553530215- 1 Pcs. 3553532362- 1 Pcs.	<b>9823</b>	<p><b>Description</b></p> <p>Full Small Differential Gear</p> 
	3463500527S 3463500527- 1 Pcs. 3463500128- 1 Pcs. 3463530514- 4 Pcs. 3463530224- 4 Pcs. 3463530862- 1 Pcs.	<b>9824</b>	<p><b>Description</b></p> <p>Full Big Differential Gear</p> 
	3553504603S 3553500343- 1 Pcs. 3553500125- 1 Pcs. N914126016008- 4 Pcs.	<b>9862</b>	<p><b>Description</b></p> <p>Axle Husing / Differential Small / Front</p> 
	3873500020S 3553500343- 1 Pcs. 3553500125- 1 Pcs. N914126016008- 4 Pcs.	<b>9863 (9864)</b>	<p><b>Description</b></p> <p>Axle Husing / Differential Small / Rear</p> 
AXOR	9483530153	<b>9900</b>	<p><b>Description</b></p> <p>Spacer Tube</p> 
SMALL DIFFERENTIAL	3553530235	<b>9905 (9906)</b>	<p><b>Description</b></p> <p>Shaft</p> 







	<table border="1"> <thead> <tr> <th>ŞEM NO.</th> <th>REF. NO.</th> <th>Type / Model</th> </tr> </thead> <tbody> <tr> <td>9907 (9908)</td> <td>3553530335</td> <td>BIG DIFFERENTIAL</td> </tr> </tbody> </table>	ŞEM NO.	REF. NO.	Type / Model	9907 (9908)	3553530335	BIG DIFFERENTIAL	<p><b>Description</b> Shaft</p>
ŞEM NO.	REF. NO.	Type / Model						
9907 (9908)	3553530335	BIG DIFFERENTIAL						
	<table border="1"> <thead> <tr> <th>ŞEM NO.</th> <th>REF. NO.</th> <th>Type / Model</th> </tr> </thead> <tbody> <tr> <td>9911</td> <td>9423500064</td> <td>AXOR 4140 BIG DIFFERENTIAL</td> </tr> </tbody> </table>	ŞEM NO.	REF. NO.	Type / Model	9911	9423500064	AXOR 4140 BIG DIFFERENTIAL	<p><b>Description</b> Differential Gear</p>
ŞEM NO.	REF. NO.	Type / Model						
9911	9423500064	AXOR 4140 BIG DIFFERENTIAL						
	<table border="1"> <thead> <tr> <th>ŞEM NO.</th> <th>REF. NO.</th> <th>Type / Model</th> </tr> </thead> <tbody> <tr> <td>9913</td> <td>9423500064S</td> <td>AXOR 4140 BIG DIFFERENTIAL</td> </tr> </tbody> </table>	ŞEM NO.	REF. NO.	Type / Model	9913	9423500064S	AXOR 4140 BIG DIFFERENTIAL	<p><b>Description</b> Differential Case</p>
ŞEM NO.	REF. NO.	Type / Model						
9913	9423500064S	AXOR 4140 BIG DIFFERENTIAL						
	<table border="1"> <thead> <tr> <th>ŞEM NO.</th> <th>REF. NO.</th> <th>Type / Model</th> </tr> </thead> <tbody> <tr> <td>9917</td> <td>9423500064S2</td> <td>AXOR 4140</td> </tr> </tbody> </table>	ŞEM NO.	REF. NO.	Type / Model	9917	9423500064S2	AXOR 4140	<p><b>Description</b> Big Differential Repair Kit / Lagging</p>
ŞEM NO.	REF. NO.	Type / Model						
9917	9423500064S2	AXOR 4140						
	<table border="1"> <thead> <tr> <th>ŞEM NO.</th> <th>REF. NO.</th> <th>Type / Model</th> </tr> </thead> <tbody> <tr> <td>11311</td> <td>9443500623S3</td> <td>AXOR 3028</td> </tr> </tbody> </table>	ŞEM NO.	REF. NO.	Type / Model	11311	9443500623S3	AXOR 3028	<p><b>Description</b> Small Differential Gear / Lagging / Short</p>
ŞEM NO.	REF. NO.	Type / Model						
11311	9443500623S3	AXOR 3028						
<p>h:153 mm</p>	<table border="1"> <thead> <tr> <th>ŞEM NO.</th> <th>REF. NO.</th> <th>Type / Model</th> </tr> </thead> <tbody> <tr> <td>11312</td> <td>9423500064S3</td> <td>AXOR 4140</td> </tr> </tbody> </table>	ŞEM NO.	REF. NO.	Type / Model	11312	9423500064S3	AXOR 4140	<p><b>Description</b> Big Differential Gear / Lagging / Front</p>
ŞEM NO.	REF. NO.	Type / Model						
11312	9423500064S3	AXOR 4140						
								

Type / Model	REF. NO.	ŞEM NO.	
AXOR 3031 3028	3553501827S1	11313	 <p><b>Description</b> Small Differential Case Not Screw</p>
	3463502327	11314	 <p><b>Description</b> Big Differential Case Not Screw</p>
AXOR 1840 ACTROS	9483500023	11315	 <p><b>Description</b> Full Differential Gear</p>
AXOR 1840 ACTROS	9483530001	11316	 <p><b>Description</b> Differential Gear</p>
AXOR 1840 ACTROS	9483500123	11317	 <p><b>Description</b> Differential Repair Kit</p>
	3873509823	11324	 <p><b>Description</b> Differential Gear / Assembled / Small Differential</p>







	ŞEM NO.	REF. NO.	Type / Model
	11325	9423502223 0003508123	AXOR 4140
	<b>Description</b>		
	Differential Gear / Assembled / Big Dif.		
	ŞEM NO.	REF. NO.	Type / Model
	11326	9443500723	AXOR 4140
	<b>Description</b>		
	Differential Gear / Assembled / Small Dif.		
	ŞEM NO.	REF. NO.	Type / Model
	9752	3953530320	SMALL DIFFERENTIAL 2521
	<b>Description</b>		
	Differential Spider		
	ŞEM NO.	REF. NO.	Type / Model
	9764	3553530620	SMALL DIFFERENTIAL 2622 2628
	<b>Description</b>		
	Differential Spider Bushing		
	ŞEM NO.	REF. NO.	Type / Model
	9809	3463530420	
	<b>Description</b>		
	Differential Spider Differential Big		
	ŞEM NO.	REF. NO.	Type / Model
	9825 (9826)	3553500128	SMALL DIFFERENTIAL
	<b>Description</b>		
	Differential Spider		







<b>Type / Model</b>	<b>REF. NO.</b>	<b>ŞEM NO.</b>	
BIG DIFFERENTIAL	3463500128	<b>9837 (9838)</b>	
		<b>Description</b>	Differential Spider
<b>Type / Model</b>	<b>REF. NO.</b>	<b>ŞEM NO.</b>	
AXOR 4140	9423500064S1	<b>9915</b>	
		<b>Description</b>	Differential Spider
<b>Type / Model</b>	<b>REF. NO.</b>	<b>ŞEM NO.</b>	
156 pcs. / 1 Kit 2521	3959810287	<b>9753</b>	
		<b>Description</b>	Roller
<b>Type / Model</b>	<b>REF. NO.</b>	<b>ŞEM NO.</b>	
FOR SMALL DIFFERENTIAL 2521	3953530114	<b>9748</b>	
		<b>Description</b>	Differential Pinion
<b>Type / Model</b>	<b>REF. NO.</b>	<b>ŞEM NO.</b>	
FOR SMALL DIFFERENTIAL GEAR 14 T 2521	3553530615	<b>9756</b>	
		<b>Description</b>	Side Gear - Differential Gear
<b>Type / Model</b>	<b>REF. NO.</b>	<b>ŞEM NO.</b>	
SMALL DIFFERENTIAL	4943350214	<b>9766 (9767)</b>	
		<b>Description</b>	Differential Pinion









	SEM NO.	REF. NO.	Type / Model
	9772	3553530315	FOR SMALL DIFFERENTIAL GEAR 16T
	<b>Description</b>		
	Side Gear Differential Small Bushing		
	SEM NO.	REF. NO.	Type / Model
	9810	3462530614	
	<b>Description</b>		
	Differential Pinion Differential Big / Bushing		
	SEM NO.	REF. NO.	Type / Model
	9813	3463530315	
	<b>Description</b>		
	Side Gear / Differential Big / Bushing		
	SEM NO.	REF. NO.	Type / Model
	9827 (9828)	3553530214	SMALL DIFFERENTIAL
	<b>Description</b>		
	Differential Pinion		
	SEM NO.	REF. NO.	Type / Model
	9831 (9832)	3553530215	SMALL DIFFERENTIAL
	<b>Description</b>		
	Side Gear		
	SEM NO.	REF. NO.	Type / Model
	9839 (9840)	3463530514	BIG DIFFERENTIAL
	<b>Description</b>		
	Differential Pinion		



<b>Type / Model</b>	<b>REF. NO.</b>	<b>ŞEM NO.</b>	
BIG DIFFERENTIAL	3463530515	<b>9843 (9844)</b>	
			<b>Description</b> Side Gear
<b>Type / Model</b>	<b>REF. NO.</b>	<b>ŞEM NO.</b>	
	3553500124	<b>10801 (10802)</b>	
			<b>Description</b> Wheel Hub Drive
<b>Type / Model</b>	<b>REF. NO.</b>	<b>ŞEM NO.</b>	
FOR SMALL DIFFERENTIAL 2521	3953530451	<b>9751</b>	
			<b>Description</b> Spacer Ring
<b>Type / Model</b>	<b>REF. NO.</b>	<b>ŞEM NO.</b>	
FOR SMALL DIFFERENTIAL 2521	3953530277	<b>9754</b>	
			<b>Description</b> Washer
<b>Type / Model</b>	<b>REF. NO.</b>	<b>ŞEM NO.</b>	
FOR SMALL DIFFERENTIAL 2521	3953530351	<b>9755</b>	
			<b>Description</b> Spacer Ring
<b>Type / Model</b>	<b>REF. NO.</b>	<b>ŞEM NO.</b>	
FOR SMALL DIFFERENTIAL 2521	3083530062	<b>9757</b>	
			<b>Description</b> Thrust Washer

	<b>ŞEM NO.</b> 9768	<b>REF. NO.</b> 4943350075	<b>Type / Model</b> FOR SMALL DIFFERENTIAL
<b>Description</b> Washer / Differential Small Bushing			
	<b>ŞEM NO.</b> 9771	<b>REF. NO.</b> 3553536051	<b>Type / Model</b> FOR SMALL DIFFERENTIAL 26.281
<b>Description</b> Spacer Ring/Differential Small Bushing			
	<b>ŞEM NO.</b> 9774	<b>REF. NO.</b> 3553530562	<b>Type / Model</b> FOR SMALL DIFFERENTIAL
<b>Description</b> Differential Small Bushing			
	<b>ŞEM NO.</b> 9812	<b>REF. NO.</b> 3463532551	<b>Type / Model</b>
<b>Description</b> Spacer Ring Differential / Big Bushing			
	<b>ŞEM NO.</b> 9814	<b>REF. NO.</b> 3463532262	<b>Type / Model</b>
<b>Description</b> Thrust Washer / Diff. Big / Bushing			
	<b>ŞEM NO.</b> 9815	<b>REF. NO.</b> 3463530124	<b>Type / Model</b>
<b>Description</b> Washer / Differential Big / Bushing			

Type / Model	REF. NO.	ŞEM NO.	
SMALL DIFFERENTIAL	3553530176	<b>9829</b> (9830)	 <p><b>Description</b> Washer</p>
SMALL DIFFERENTIAL	3553532362	<b>9833</b> (9834)	 <p><b>Description</b> Thrust Washer</p> <p style="text-align: right;">2,60 mm</p>
BIG DIFFERENTIAL	3463530224	<b>9841</b> (9842)	 <p><b>Description</b> Washer</p>
BIG DIFFERENTIAL	3463530862	<b>9847</b> (9848)	 <p><b>Description</b> Thrust Washer</p>
AXOR	9763560052	<b>9867</b>	 <p><b>Description</b> Thrust Washer</p>
2521	3603560415	<b>9869</b>	 <p><b>Description</b> Thrust Ring</p> <p style="text-align: right;">100x120 mm</p>

	ŞEM NO.	REF. NO.	Type / Model
	9870 (9872)	3553560915	
	<b>Description</b>		
	Thrust Ring		
110x145 mm			







	ŞEM NO.	REF. NO.	Type / Model
	9871	3463561415	26.321
	<b>Description</b>		
	Thrust Ring		
115x145 mm			







	ŞEM NO.	REF. NO.	Type / Model
	9874	9463560015	AXOR 2523 2528
	<b>Description</b>		
	Thrust Ring		
119x145 mm			







	ŞEM NO.	REF. NO.	Type / Model
	9875	6753560215	AXOR
	<b>Description</b>		
	Thrust Ring		
101x120 mm			

	ŞEM NO.	REF. NO.	Type / Model
	9903 (9904)	3463531762	BIG DIFFERENTIAL
	<b>Description</b>		
	Thrust Washer		
4 mm			







	ŞEM NO.	REF. NO.	Type / Model
	11318	9483530024	AXOR ACTROS 1840
	<b>Description</b>		
	Washer		







Type / Model	REF. NO.	ŞEM NO.	
AXOR 1840 ACTROS	9483530062	11319	
			<b>Description</b> Trust Washer
Type / Model	REF. NO.	ŞEM NO.	
AXOR	9463560073	11336	
			<b>Description</b> Trust Washer
Type / Model	REF. NO.	ŞEM NO.	
SMALL DIFFERENTIAL	3553500343	9852 (9853)	
			<b>Description</b> Screw Collar
Type / Model	REF. NO.	ŞEM NO.	
SMALL DIFFERENTIAL	3553530125	9854 (9855)	
			<b>Description</b> Screw Coller
Type / Model	REF. NO.	ŞEM NO.	
BIG DIFFERENTIAL	6523530025	9856 (9857)	
			<b>Description</b> Differential Gear Adjustment
Type / Model	REF. NO.	ŞEM NO.	
BIG DIFFERENTIAL	3463500443	9858 (9859)	
			<b>Description</b> Differential Gear Adjustment







	<table border="1"> <thead> <tr> <th>ŞEM NO.</th> <th>REF. NO.</th> <th>Type / Model</th> </tr> </thead> <tbody> <tr> <td>9860</td> <td>9423530925</td> <td>AXOR</td> </tr> </tbody> </table>	ŞEM NO.	REF. NO.	Type / Model	9860	9423530925	AXOR	<p><b>Description</b> Screw Collar</p>
ŞEM NO.	REF. NO.	Type / Model						
9860	9423530925	AXOR						
	<table border="1"> <thead> <tr> <th>ŞEM NO.</th> <th>REF. NO.</th> <th>Type / Model</th> </tr> </thead> <tbody> <tr> <td>9865</td> <td>9463560226</td> <td>AXOR</td> </tr> </tbody> </table>	ŞEM NO.	REF. NO.	Type / Model	9865	9463560226	AXOR	<p><b>Description</b> Grover Nut / Differential Small</p>
ŞEM NO.	REF. NO.	Type / Model						
9865	9463560226	AXOR						
	<table border="1"> <thead> <tr> <th>ŞEM NO.</th> <th>REF. NO.</th> <th>Type / Model</th> </tr> </thead> <tbody> <tr> <td>9866</td> <td>0009903260</td> <td>CONECTO</td> </tr> </tbody> </table>	ŞEM NO.	REF. NO.	Type / Model	9866	0009903260	CONECTO	<p><b>Description</b> Nut</p>
ŞEM NO.	REF. NO.	Type / Model						
9866	0009903260	CONECTO						
	<table border="1"> <thead> <tr> <th>ŞEM NO.</th> <th>REF. NO.</th> <th>Type / Model</th> </tr> </thead> <tbody> <tr> <td>9868</td> <td>3853560026</td> <td>2517 2521 2524</td> </tr> </tbody> </table>	ŞEM NO.	REF. NO.	Type / Model	9868	3853560026	2517 2521 2524	<p><b>Description</b> Axle Tube Nut</p>
ŞEM NO.	REF. NO.	Type / Model						
9868	3853560026	2517 2521 2524						
	<table border="1"> <thead> <tr> <th>ŞEM NO.</th> <th>REF. NO.</th> <th>Type / Model</th> </tr> </thead> <tbody> <tr> <td>10866</td> <td>6743560226</td> <td></td> </tr> </tbody> </table>	ŞEM NO.	REF. NO.	Type / Model	10866	6743560226		<p><b>Description</b> Nut</p>
ŞEM NO.	REF. NO.	Type / Model						
10866	6743560226							
	<table border="1"> <thead> <tr> <th>ŞEM NO.</th> <th>REF. NO.</th> <th>Type / Model</th> </tr> </thead> <tbody> <tr> <td>10891</td> <td>9423530225</td> <td></td> </tr> </tbody> </table>	ŞEM NO.	REF. NO.	Type / Model	10891	9423530225		<p><b>Description</b> Nut</p>
ŞEM NO.	REF. NO.	Type / Model						
10891	9423530225							



<b>Type / Model</b>	<b>REF. NO.</b>	<b>ŞEM NO.</b>	
	3553530026	<b>11328</b>	
		<b>Description</b>	
		Grooved Nut-Old Model	
			48x1,5 mm
<b>Type / Model</b>	<b>REF. NO.</b>	<b>ŞEM NO.</b>	
	3553530126	<b>11329</b>	
		<b>Description</b>	
		Grooved Nut-New Model	
			48x1,5 mm
<b>Type / Model</b>	<b>REF. NO.</b>	<b>ŞEM NO.</b>	
	N070852055000	<b>11330</b>	
		<b>Description</b>	
		Nut	
<b>Type / Model</b>	<b>REF. NO.</b>	<b>ŞEM NO.</b>	
	3463530126	<b>11331</b>	
		<b>Description</b>	
		Grooved Nut / Big Differential	
<b>Type / Model</b>	<b>REF. NO.</b>	<b>ŞEM NO.</b>	
AXOR	9763560026	<b>11332</b>	
		<b>Description</b>	
		Axle Tube Nut	
<b>Type / Model</b>	<b>REF. NO.</b>	<b>ŞEM NO.</b>	
AXOR 4140	9423500143	<b>11334</b>	
		<b>Description</b>	
		Nut	



	<b>ŞEM NO.</b>	<b>REF. NO.</b>	<b>Type / Model</b>
	11335	9703530025	AXOR 4141
	<b>Description</b> Nut		
	<b>ŞEM NO.</b>	<b>REF. NO.</b>	<b>Type / Model</b>
	11337	3553530225	
	<b>Description</b> Grooved Nut / Small Differential		
M 102x1,5 mm			
	<b>ŞEM NO.</b>	<b>REF. NO.</b>	<b>Type / Model</b>
	11338	3463530925	
	<b>Description</b> Grooved Nut / Old Model / Big Differential		
	<b>ŞEM NO.</b>	<b>REF. NO.</b>	<b>Type / Model</b>
	9878 (9879)	3839900701	SMALL DIFFERENTIAL
	<b>Description</b> Screw		
12x1x28 mm			
	<b>ŞEM NO.</b>	<b>REF. NO.</b>	<b>Type / Model</b>
	9880 (9881)	3553540371 6243540171	
	<b>Description</b> Screw		
14x1,5x80 mm			
	<b>ŞEM NO.</b>	<b>REF. NO.</b>	<b>Type / Model</b>
	9882	9429901704 N308676012022	
	<b>Description</b> Screw / Big Differential		
12x1,5x80			

<b>Type / Model</b>	<b>REF. NO.</b>	<b>ŞEM NO.</b>	
SMALL DIFFERENTIAL	0009906504	9884	
			<b>Description</b> Screw 12x1,5x70 mm
<b>Type / Model</b>	<b>REF. NO.</b>	<b>ŞEM NO.</b>	
SMALL DIFFERENTIAL	9429901004	9886	
			<b>Description</b> Screw 10x1,5x70 mm
<b>Type / Model</b>	<b>REF. NO.</b>	<b>ŞEM NO.</b>	
	0009906704	9888	
			<b>Description</b> Screw / Differential Big 14x1,5x95 mm
<b>Type / Model</b>	<b>REF. NO.</b>	<b>ŞEM NO.</b>	
AXOR 3028	9443500523S2 9443500623S2	9890	
			<b>Description</b> Screw / Small Differential 12x1,5x55 mm
<b>Type / Model</b>	<b>REF. NO.</b>	<b>ŞEM NO.</b>	
AXOR 4140	0019905000	9919	
			<b>Description</b> Screw M16x1,5x75
<b>Type / Model</b>	<b>REF. NO.</b>	<b>ŞEM NO.</b>	
	N914126016008	9921 (9922)	
			<b>Description</b> Screw M16x1,5x95

	<b>ŞEM NO.</b> 9770	<b>REF. NO.</b> 3553530750	<b>Type / Model</b> FOR SMALL DIFFERENTIAL 26.281
<b>Description</b> Bushing Differential / Small Bushing			
	<b>ŞEM NO.</b> 9811	<b>REF. NO.</b> 3463530950	<b>Type / Model</b>
<b>Description</b> Differential Big Bushing			
	<b>ŞEM NO.</b> 9835 (9836)	<b>REF. NO.</b> 3553531050	<b>Type / Model</b> SMALL DIFFERENTIAL
<b>Description</b> Bushing			
	<b>ŞEM NO.</b> 9845 (9846)	<b>REF. NO.</b> 3553530950	<b>Type / Model</b> SMALL DIFFERENTIAL
<b>Description</b> Bushing			
	<b>ŞEM NO.</b> 9850 (9851)	<b>REF. NO.</b> 3463530650	<b>Type / Model</b> BIG DIFFERENTIAL
<b>Description</b> Bushing			
	<b>ŞEM NO.</b> 9909 (9910)	<b>REF. NO.</b> 3463530450	<b>Type / Model</b> BIG DIFFERENTIAL
<b>Description</b> Bushing			

Type / Model	REF. NO.	SEM NO.	
	3463320048	11629	 <p><b>Description</b> Bush(Kingpin)</p> <p>D = Ø57 d = Ø50 L = 45</p>
	3603320048	11630	 <p><b>Description</b> Bush(Kingpin)</p> <p>D = Ø57 d = Ø50 L = 50</p>
SMALL DIFFERENTIAL	3553531862	9901 (9902)	 <p><b>Description</b> Thrust Washer</p> <p>4 mm</p>

SEM NO.	REF. NO.	Type / Model
12945	 973410022 3854100922 3854100222 3854101722 3854100110 3854100122	 Propeller Shaft Bearing

D=55 L=25 Ax=191

SEM NO.	REF. NO.	Type / Model
12946	 3954100022 6204100010 3954100622	 Propeller Shaft Bearing

SEM NO.	REF. NO.	Type / Model
12947	 3954100022 6204100010 3954100622	 Propeller Shaft Bearing

D=70 L=25 Ax=246

SEM NO.	REF. NO.	Type / Model
12948	 3814100222 3814101522 3854100010 3814101222 3855860041	 Propeller Shaft Bearing







D=60 L=25 Ax=246

SEM NO.	REF. NO.	Type / Model
12949	 4604100022 4604100222	 Propeller Shaft Bearing







SEM NO.	REF. NO.	Type / Model
12950	 4604100022 4604100222	 Propeller Shaft Bearing







D=35 L=17 Ax=160







<b>Type / Model</b>	<b>REF. NO.</b>		<b>SEM NO.</b>	
	6594110112		12951	
			<b>Description</b>	
			Propeller Shaft Bearing	
				D=80 L=22 Ax=246
<b>Type / Model</b>	<b>REF. NO.</b>		<b>SEM NO.</b>	
	6704110112		12952	
			<b>Description</b>	
			Propeller Shaft Bearing	
				D=45 L=19
<b>Type / Model</b>	<b>REF. NO.</b>		<b>SEM NO.</b>	
	6544110012		12953	
			<b>Description</b>	
			Propeller Shaft Bearing	
				D=80 L=22
<b>Type / Model</b>	<b>REF. NO.</b>		<b>SEM NO.</b>	
	6564110012		12954	
			<b>Description</b>	
			Propeller Shaft Bearing	
				D=70 L=20
<b>Type / Model</b>	<b>REF. NO.</b>		<b>SEM NO.</b>	
	9734110012		12955	
			<b>Description</b>	
			Propeller Shaft Bearing	
				D=55 L=23

	SEM NO.	REF. NO.	Type / Model
	9447	6552501813	Actros Axor 457
	<b>Description</b> Clutch Lever Complete		
	SEM NO.	REF. NO.	Type / Model
	9448	6552501513	Actros Axor 457
	<b>Description</b> Clutch Lever With Rolle		
	SEM NO.	REF. NO.	Type / Model
	9449	6552501513S	Actros Axor 457
	<b>Description</b> Clutch Lever		
	SEM NO.	REF. NO.	Type / Model
	9450	6502503813	3031 2631
	<b>Description</b> Clutch Lever With Rolle		
	SEM NO.	REF. NO.	Type / Model
	10001	6502503813S 6502503813 - 1 Pcs. 6502540006 - 1 Pcs.	3031
	<b>Description</b> Release Lever With Rolle		
	SEM NO.	REF. NO.	Type / Model
	10029	1328268011 0002542008	ZF
	<b>Description</b> Release Lever		



Type / Model	REF. NO.	SEM NO.	
TRAVEGO 457 EURO - 3 SETRA	6562500613 6562500813	10780	 <b>Description</b> Release Lever With Rolle
	Zf6060206006 2541008	10783	 <b>Description</b> Release Lever for ZF
Actros Axor 457	6552540206	9451	 <b>Description</b> Clutch Pin
3031 2631	6502540006	9452	 <b>Description</b> Clutch Pin
3031 2631	6502540006S	9453	 <b>Description</b> Clutch Repair Kit
Actros	6552540206S	9454	 <b>Description</b> Clutch Repair Kit

	<p><b>SEM NO.</b> <b>9455</b></p> <p><b>Description</b> Clutch Repair Kit</p>	<p><b>REF. NO.</b> 0029921501 0002540017 000988036100 0002540335 912009035100</p>	<p><b>Type / Model</b> Actros Axor 457</p>
	<p><b>SEM NO.</b> <b>10988</b></p> <p><b>Description</b> Washer</p>	<p><b>REF. NO.</b> 000988036100S</p>	<p><b>Type / Model</b></p>
	<p><b>SEM NO.</b> <b>10989</b></p> <p><b>Description</b> Clutch Washer</p>	<p><b>REF. NO.</b> 912009035108</p>	<p><b>Type / Model</b></p>
	<p><b>SEM NO.</b> <b>9456</b></p> <p><b>Description</b> Clutch Repair Kit</p>	<p><b>REF. NO.</b> 0019928401 0002540017S 912009037200 0002540335S 007993012100</p>	<p><b>Type / Model</b> 3031 2631</p>
	<p><b>SEM NO.</b> <b>9999</b></p> <p><b>Description</b> Release Spindle Repair Kit</p>	<p><b>REF. NO.</b> 6552540206S1 6552540206- 1 Pcs. N000988036100- 2 Pcs. N912009035100- 2 Pcs. N910105012026- 2 Pcs.</p>	<p><b>Type / Model</b> ACTROS</p>
	<p><b>SEM NO.</b> <b>10007</b></p> <p><b>Description</b> Release Spindle Repair Kit</p>	<p><b>REF. NO.</b> 6552540206S2 6552540206- 1 Pcs. 0002540017- 2 Pcs. 0002540335- 1 Pcs. 0029921501- 2 Pcs. N000988036100- 2 Pcs. N912009035100- 2 Pcs. N910105012026- 2 Pcs.</p>	<p><b>Type / Model</b> FULL ACTROS</p>

Type / Model	REF. NO.	SEM NO.	
3031 2631	6502540006S1 6502540006- 1 Pcs. 0002540017- 2 Pcs. 0002540335- 1 Pcs. 0019928401- 2 Pcs. N912009037200- 4 Pcs. N914112010025- 2 Pcs.	10008	 <p><b>Description</b> Release Spindle Repair Kit</p>
ZF	1328368001 0002540907	10030	 <p><b>Description</b> Spindle</p>
ZF	0002542008S 0002540907- 1 Pcs. 002540017- 2 Pcs. 0002540139- 1 Pcs. 0002540650- 1 Pcs.	10031	 <p><b>Description</b> Release Lever Repair Kit</p>
ZF	0002542008S1 0002540017- 2 Pcs. 0002540139- 1 Pcs. 0002540650- 1 Pcs.	10032	 <p><b>Description</b> Release Lever / Repair Kit</p>
	ZF6060206006S ZF6060306086S 0002541008S	10786	 <p><b>Description</b> Release Lever Repair Kit for ZF</p>
TRAVEGO 457 EURO - 3 SETRA	6562540506	10803	 <p><b>Description</b> Release Spindle</p>



**SEM NO.**

**REF. NO.**

**Type / Model**

**10804**

6562500613S

TRAVEGO 457  
EURO - 3

**Description**

Release Lever Repair Kit



**SEM NO.**

**REF. NO.**











**Type / Model**

**10805**

Zf6060306096  
0002540036  
0002540136

**Description**

Release Lever Block

<b>Type / Model</b>	<b>REF. NO.</b>		<b>SEM NO.</b>	
	9454200138 6194200138 6194200338 6234201338 6234201538 6524200138 6584200338 9424200138 9424200838 9424201338		12850	
			<b>Description</b>	
			Brake Slack Adjuster, Automatic-Right	Ø 14x145x0°
<b>Type / Model</b>	<b>REF. NO.</b>		<b>SEM NO.</b>	
	9454200038 6194200038 6194200238 6234201238 6234201438 6524200038 6584200238 9424200938 9424201238		12851	
			<b>Description</b>	
			Brake Slack Adjuster, Automatic-Left	Ø 14x145x0°
<b>Type / Model</b>	<b>REF. NO.</b>		<b>SEM NO.</b>	
	3054202638		12852	
			<b>Description</b>	
			Brake Slack Adjuster, Automatic	Ø 14x115x61°
<b>Type / Model</b>	<b>REF. NO.</b>		<b>SEM NO.</b>	
	3074200338		12854	
			<b>Description</b>	
			Brake Slack Adjuster, Automatic	Ø 14x130x79°
<b>Type / Model</b>	<b>REF. NO.</b>		<b>SEM NO.</b>	
	9454200238 3874200338 6174200338 6194200738 6554200038 9424200238		12855	
			<b>Description</b>	
			Brake Slack Adjuster, Automatic-Left	Ø 14x145x0°
<b>Type / Model</b>	<b>REF. NO.</b>		<b>SEM NO.</b>	
	9454200338 3874200238 6174200438 6194200638 6554200138 9424200338		12859	
			<b>Description</b>	
			Brake Slack Adjuster, Automatic-Right	Ø 14x145x0°

SEM NO.	REF. NO.	Type / Model
12860	9454200738 3834200438	
 <p><b>Description</b> Brake Slack Adjuster, Automatic-Right</p>		
Ø 14x145x0°		

SEM NO.	REF. NO.	Type / Model
12863	3354200338	
 <p><b>Description</b> Brake Slack Adjuster, Manuel</p>		
Ø 14x120/150/180x0° / 19' Lock		





SEM NO.	REF. NO.	Type / Model
12864	3464201838	
 <p><b>Description</b> Brake Slack Adjuster, Manuel-Right</p>		
Ø 14x145x0° / 19' Lock		

SEM NO.	REF. NO.	Type / Model
12865	3464201738	
 <p><b>Description</b> Brake Slack Adjuster, Manuel-Left</p>		
Ø 14x145x0° / 19' Lock		

SEM NO.	REF. NO.	Type / Model
12868	3574201338	
 <p><b>Description</b> Brake Slack Adjuster, Automatic-Left</p>		
Ø 14x130x103°		

SEM NO.	REF. NO.	Type / Model
12869	3574200538	
 <p><b>Description</b> Brake Slack Adjuster, Automatic</p>		
Ø 14x145x358°		









<b>Type / Model</b>	<b>REF. NO.</b>		<b>SEM NO.</b>	
	3014201138		12874	
				<b>Description</b>
				Brake Slack Adjuster, Automatic
				Ø 14x130x337.5°
<b>Type / Model</b>	<b>REF. NO.</b>		<b>SEM NO.</b>	
	6174200238		12875	
				<b>Description</b>
				Brake Slack Adjuster, Automatic
				Ø 14x145x86°
<b>Type / Model</b>	<b>REF. NO.</b>		<b>SEM NO.</b>	
	9454200938		12880	
				<b>Description</b>
				Brake Slack Adjuster, Automatic-Left
				Ø 14x145x0°
<b>Type / Model</b>	<b>REF. NO.</b>		<b>SEM NO.</b>	
	9454200438		12882	
				<b>Description</b>
				Brake Slack Adjuster, Automatic-Right
				Ø 14x145x0°
<b>Type / Model</b>	<b>REF. NO.</b>		<b>SEM NO.</b>	
26x22	0004233387		9953	
25x17	0004230576			
	0004233987			
				<b>Description</b>
				Was

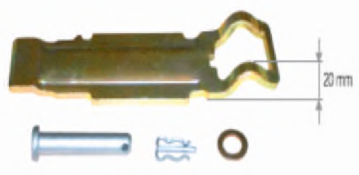

	ŞEM NO.	REF. NO.	Type / Model
	<b>10683</b>	0004203982 0004200682	KN TYPE  All SB 5..., SB 6..., SB 7..., SN 5... Series
	<p><b>Description</b> Caliper Repair Kit</p>		
	<b>10684</b>	0004202382 0004204082	KN TYPE NA 7027, NA 7028, NA 7037, NA 7038, NA 75..., SK 7..., SN 65..., SN 66..., SN 7..., SN 71..., SN 72..., SN 73.. Series
	<p><b>Description</b> Caliper Repair Kit</p>		
	<b>10688</b>	0004202282 0004200782	KN TYPE SB 5..., S6 65..., SB 71..., SB 75..., SB 76..., SB 77..
	<p><b>Description</b> Caliper Repair Kit</p>		
	<b>10689</b>	0004202982	KN TYPE IVECO TYPE
	<p><b>Description</b> Caliper Repair Kit</p>		
	<b>10693</b>	0004202182	KN TYPE SB 7122, SB 7132, SB 7126, SB 7136, SB 7586, SB 7596, SB 7666, SB 7676, SB 7785, SB 7859, SB 7869
	<p><b>Description</b> Caliper Repair Kit</p>		
	<b>10699</b>	0004201282	KN TYPE SB 5... Series
	<p><b>Description</b> Caliper Repair Kit</p>		

Type / Model	REF. NO.	ŞEM NO.	
KN TYPE All SB...	0004201182	12184	<p><b>Description</b> Caliper Repair Kit</p>
KN TYPE All SB... Series	0014205283 0004203015	12188	<p><b>Description</b> Caliper Repair Kit</p>
KN TYPE 3,5 m	4497560200	12197	<p><b>Description</b> Caliper Repair Kit</p>
KN TYPE	0004203482	12215	<p><b>Description</b> Caliper Repair Kit</p>
KN TYPE SB 7122, SB 7132, SB 7126, SB 7136, SB 7586, SB 7596, SB 7666, SB 7676	0024200383	12216	<p><b>Description</b> Caliper Repair Kit</p>
KN TYPE SB 7521, SB 7581, SB 7661, SB 7580, SB 7122, SB 7..., SB 75..., SB 7624, SB 7629, SB 7634, SB 7639, SB 7640, SB 7650, SB 7668, SB 7678	0501210167	12226	<p><b>Description</b> Caliper Repair Kit</p>

	ŞEM NO.	REF. NO.	Type / Model
 <p> <b>Description</b>            Caliper Repair Kit         </p>	<b>12235</b>	000 4201182 050 1211047	KN TYPE SB 7
 <p> <b>Description</b>            Caliper Repair Kit         </p>	<b>12238</b>	000 4200882 627 4200186	KN TYPE SN 5..., SB 6..., SB 7..., SN 7... Series
 <p> <b>Description</b>            Caliper Repair Kit         </p>	<b>12239</b>	000 4202482	KN TYPE SN 6..., SK 7... Series
 <p> <b>Description</b>            Caliper Repair Kit         </p>	<b>12260</b>	000 4204382	KN TYPE SN 6504, SN 6515
 <p> <b>Description</b>            Caliper Repair Kit         </p>	<b>12277</b>	004 4207183 004 4207583	KN TYPE SL 7..., SM 7... Series
 <p> <b>Description</b>            Caliper Repair Kit         </p>	<b>12278</b>	000 4230606	KN TYPE ACTROS AXOR

Type / Model	REF. NO.	ŞEM NO.	
KN TYPE SN 6..., SN 7...,	000 4213106	12284	 <p><b>Description</b> Caliper Repair Kit 19.5 "</p>

## 6.4.2

**Clutch and Brake Group**  
Caliper Group / MRT Type

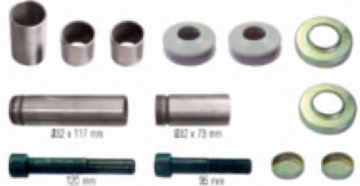
Type / Model	REF. NO.	ŞEM NO.	
MRT TYPE LRG 524, 525, 526, 527, 528, 529, 532, 533, 562, 563	0004200276	12358	 <p><b>Description</b> Caliper Repair Kit</p>

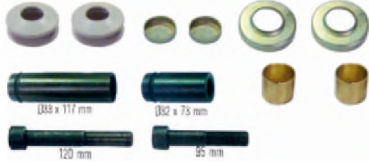
Type / Model	REF. NO.	ŞEM NO.	
MRT TYPE LRG 532, 533, 622, 623	0004200676	12359	 <p><b>Description</b> Caliper Repair Kit</p>



**SEM NO.**

**REF. NO.**

**Type / Model**

**12736**

0004211463

HYDRAULIC TYPE  
LRG 510, 511, 516, 517,  
520 521, 566, 567

**Description**

Caliper Repair Kit



**SEM NO.**

**REF. NO.**

**Type / Model**

**12737**







0004218386

HYDRAULIC TYPE







**Description**

Caliper Repair Kit

<b>Type / Model</b>	<b>REF. NO.</b>	<b>SEM NO.</b>	<p><b>Description</b> Brake Shoe (Welded)</p>
	6244200219	9923	
<b>Type / Model</b>	<b>REF. NO.</b>	<b>SEM NO.</b>	<p><b>Description</b> Brake Shoe (Welded)</p>
	6204200219	9925 (9926)	
<b>Type / Model</b>	<b>REF. NO.</b>	<b>SEM NO.</b>	<p><b>Description</b> Brake Shoe (Welded)</p>
	6594200019	9927 (9928)	
<b>Type / Model</b>	<b>REF. NO.</b>	<b>SEM NO.</b>	<p><b>Description</b> Brake Shoe (Welded)</p>
V6 / V8	3054200719	9929	
<b>Type / Model</b>	<b>REF. NO.</b>	<b>SEM NO.</b>	<p><b>Description</b> Brake Shoe (Casting)</p>
CONECTO 345 K	3054201119	9930	
<b>Type / Model</b>	<b>REF. NO.</b>	<b>SEM NO.</b>	<p><b>Description</b> Brake Shoe (Casting)</p>
	6594200419 6594200519	9931 (9932)	

	<table border="1"> <thead> <tr> <th>SEM NO.</th> <th>REF. NO.</th> <th>Type / Model</th> </tr> </thead> <tbody> <tr> <td>9933</td> <td>3894206119</td> <td></td> </tr> </tbody> </table>	SEM NO.	REF. NO.	Type / Model	9933	3894206119		<p><b>Description</b> Brake Shoe (Casting)</p>
SEM NO.	REF. NO.	Type / Model						
9933	3894206119							
180 mm								
	<table border="1"> <thead> <tr> <th>SEM NO.</th> <th>REF. NO.</th> <th>Type / Model</th> </tr> </thead> <tbody> <tr> <td>9936</td> <td>3894206319</td> <td></td> </tr> </tbody> </table>	SEM NO.	REF. NO.	Type / Model	9936	3894206319		<p><b>Description</b> Brake Shoe (Casting)</p>
SEM NO.	REF. NO.	Type / Model						
9936	3894206319							
160 mm								
	<table border="1"> <thead> <tr> <th>SEM NO.</th> <th>REF. NO.</th> <th>Type / Model</th> </tr> </thead> <tbody> <tr> <td>9937</td> <td>3054200719S</td> <td>345 K V6</td> </tr> </tbody> </table>	SEM NO.	REF. NO.	Type / Model	9937	3054200719S	345 K V6	<p><b>Description</b> Brake Shoe (Casting)</p>
SEM NO.	REF. NO.	Type / Model						
9937	3054200719S	345 K V6						
220 mm								
	<table border="1"> <thead> <tr> <th>SEM NO.</th> <th>REF. NO.</th> <th>Type / Model</th> </tr> </thead> <tbody> <tr> <td>9940 (9941)</td> <td>3464230906 9424230306</td> <td></td> </tr> </tbody> </table>	SEM NO.	REF. NO.	Type / Model	9940 (9941)	3464230906 9424230306		<p><b>Description</b> Brake Anchor</p>
SEM NO.	REF. NO.	Type / Model						
9940 (9941)	3464230906 9424230306							
	<table border="1"> <thead> <tr> <th>SEM NO.</th> <th>REF. NO.</th> <th>Type / Model</th> </tr> </thead> <tbody> <tr> <td>9957</td> <td>3464213106</td> <td></td> </tr> </tbody> </table>	SEM NO.	REF. NO.	Type / Model	9957	3464213106		<p><b>Description</b> Front Brake Anchor</p>
SEM NO.	REF. NO.	Type / Model						
9957	3464213106							
	<table border="1"> <thead> <tr> <th>SEM NO.</th> <th>REF. NO.</th> <th>Type / Model</th> </tr> </thead> <tbody> <tr> <td>11343</td> <td>9424232033</td> <td>AXOR 4140 3028</td> </tr> </tbody> </table>	SEM NO.	REF. NO.	Type / Model	11343	9424232033	AXOR 4140 3028	<p><b>Description</b> Bearing Braket / Right Front</p>
SEM NO.	REF. NO.	Type / Model						
11343	9424232033	AXOR 4140 3028						



Type / Model	REF. NO.	SEM NO.	
AXOR 4140 3028	9424231933	11344	 <p><b>Description</b> Bearing Braket / Left Front</p>
AXOR 4140 3028	9424230233	11345	 <p><b>Description</b> Bearing Braket / Right Rear</p>
AXOR 4140 3028	9424230133	11346	 <p><b>Description</b> Bearing Braket / Left Rear</p>
Type / Model	REF. NO.	SEM NO.	 <p><b>Description</b> Brake Shoe Pin Set</p>
	3074204102	9942	
Type / Model	REF. NO.	SEM NO.	 <p><b>Description</b> Joint Bearing Full</p>
	3074200339	9944	
Type / Model	REF. NO.	SEM NO.	 <p><b>Description</b> Pin</p>
	4974210074	9945 (9946)	

Q30 mm

	SEM NO.	REF. NO.	Type / Model
	9948	3074200339S	
	<b>Description</b> Joint Bearing With Bushing		

	SEM NO.	REF. NO.	Type / Model
	9949 (9950)	3074210074	
	<b>Description</b> Pin		

Q 20 mm



	SEM NO.	REF. NO.	Type / Model
	9951 (9952)	6744210150	
	<b>Description</b> Busing		

30x34x47 mm

	SEM NO.	REF. NO.	Type / Model
	9954	3074204002 3954200082	FOR TWO BRAKE SHOES
	<b>Description</b> Brake Shoe Repair Kit		

	SEM NO.	REF. NO.	Type / Model
	9956	0004200139	CONETTO FOR TWO BRAKE SHOES
	<b>Description</b> Brake Shoe Bearing		

	SEM NO.	REF. NO.	Type / Model
	11342	3074204002S	
	<b>Description</b> Brake Shoe/ Pin Set/for One Brake Shoe		

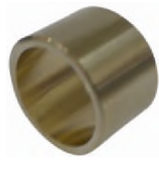

Type / Model	REF. NO.	SEM NO.	
	3074210550	11618	 <p><b>Description</b> Bush (Brake Shoe)</p> <p>D = Ø34 d = Ø30 L = 41</p>
	3184210050	11619	 <p><b>Description</b> Bush (Brake Shoe)</p> <p>D = Ø31 d = Ø28 L = 34</p>
	6744210050	11620	 <p><b>Description</b> Bush (Brake Shoe)</p> <p>D = Ø34 d = Ø30 L = 47</p>
	3024210150	11621	 <p><b>Description</b> Bush (Brake Shoe)</p> <p>D = Ø32 d = Ø30 L = 22</p>











## DAF GROUP

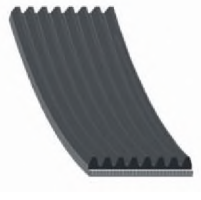

Engine and Transmission Group .....	:	470 - 485
Steering Group .....	:	486 - 491
Suspension Group .....	:	492 - 516
Cab Group .....	:	517 - 531
Axle / Differential ve Shaft Group.....	:	-
Clutch and Brake Group.....	:	532 - 539

	SEM NO.	REF. NO.	Type / Model
 M14x1,5	8996	1239183	
	<b>Description</b> Engine Mounting		
 M12x1,5	8997	0300911	
	<b>Description</b> Engine Mounting		
	8998	0300912	
	<b>Description</b> Dust Cover		

<b>Type / Model</b>	<b>REF. NO.</b>		<b>SEM NO.</b>	
	1812162 1638698 1458919		<b>12891</b>	
			<b>Description</b>	
			V Ribbed Belt	
				7PK1753
<b>Type / Model</b>	<b>REF. NO.</b>		<b>SEM NO.</b>	
	1665637		<b>12892</b>	
			<b>Description</b>	
			V Ribbed Belt	
				7PK1824
<b>Type / Model</b>	<b>REF. NO.</b>		<b>SEM NO.</b>	
	1393344		<b>10320</b>	
			<b>Description</b>	
			V Ribbed Belt	
				8PK1220
<b>Type / Model</b>	<b>REF. NO.</b>		<b>SEM NO.</b>	
	1388161 1702605		<b>10339</b>	
			<b>Description</b>	
			V Ribbed Belt	
				8PK1515
<b>Type / Model</b>	<b>REF. NO.</b>		<b>SEM NO.</b>	
	1393365		<b>10348</b>	
			<b>Description</b>	
			V Ribbed Belt	
				8PK1718
<b>Type / Model</b>	<b>REF. NO.</b>		<b>SEM NO.</b>	
	1372669		<b>10356</b>	
			<b>Description</b>	
			V Ribbed Belt	
				8PK1908



	SEM NO.	REF. NO.	Type / Model
	<b>11689</b> (10359)	1152425	
	<b>Description</b> V Ribbed Belt		
8PK1914			

	SEM NO.	REF. NO.	Type / Model
	<b>10365</b>	1393280	
	<b>Description</b> V Ribbed Belt		
8PK2050			





	SEM NO.	REF. NO.	Type / Model
	<b>10372</b> (10373)	1398637	
	<b>Description</b> V Ribbed Belt		
8PK2380			







	SEM NO.	REF. NO.	Type / Model
	<b>10376</b>	1654398 1661948	
	<b>Description</b> V Ribbed Belt		
9PK1380			







	SEM NO.	REF. NO.	Type / Model
	<b>11692</b>	1661949	
	<b>Description</b> V Ribbed Belt		
9PK1424			







	SEM NO.	REF. NO.	Type / Model
	<b>10400</b>	3040668	
	<b>Description</b> V Ribbed Belt		
10PK1360			

Type / Model	REF. NO.		SEM NO.	
	0067667		<b>12901</b>	
	0256063			
	0295063			
	0759749			
			<b>Description</b>	
			V Ribbed Belt	
				2XAVX13X1025

	<p><b>SEM NO.</b> 12145</p>	<p><b>new product</b></p>	<p><b>REF. NO.</b> 1315854</p>	<p><b>Type / Model</b></p>
<p><b>Description</b> Blade, Fan</p>				
	<p><b>SEM NO.</b> 12147</p>	<p><b>new product</b></p>	<p><b>REF. NO.</b> 1308285</p>	<p><b>Type / Model</b></p>
<p><b>Description</b> Blade, Fan</p>				
	<p><b>SEM NO.</b> 12144</p>	<p><b>new product</b></p>	<p><b>REF. NO.</b> 1436105 1349834 1334259 1319780</p>	<p><b>Type / Model</b></p>
<p><b>Description</b> Visco Drive, Fan</p>				
	<p><b>SEM NO.</b> 12146</p>	<p><b>new product</b></p>	<p><b>REF. NO.</b> 1330723 1305179</p>	<p><b>Type / Model</b></p>
<p><b>Description</b> Visco Drive, Fan</p>				
	<p><b>SEM NO.</b> 12151</p>	<p><b>new product</b></p>	<p><b>REF. NO.</b> 1306244 1224885</p>	<p><b>Type / Model</b></p>
<p><b>Description</b> Visco Drive, Fan</p>				

Type / Model	REF. NO.	ŞEM NO.	
XF 95	1347468 1333996	8416	 <p><b>Description</b> Radiator Hose</p> <p>d=Ø30 d=Ø30 h=530</p>
XF 95	1353922 1293805	8417	 <p><b>Description</b> Upper Hose</p> <p>d=Ø60 d=Ø60 h=400</p>
XF 95	1293809	8418	 <p><b>Description</b> Radiator Lower Hose</p> <p>d=Ø60 d=Ø70 h=400</p>
CF 85	1371353	8506	 <p><b>Description</b> Radiator Hose</p> <p>60x60x1250</p>
CF 85	1372303	8573	 <p><b>Description</b> Radiator Hose</p> <p>60x60x345</p>
F 85	1297733 0089348	8574	 <p><b>Description</b> Radiator Hose</p> <p>30x30x455</p>

	<b>SEM NO.</b>	<b>REF. NO.</b>	<b>Type / Model</b>
	8575	1355106 1346770	CF 85
<b>Description</b>			
Oil Hose			
25x34x460			
	<b>SEM NO.</b>	<b>REF. NO.</b>	<b>Type / Model</b>
	8576	1440636	CF
<b>Description</b>			
Radiator Lower Hose			
60x60x530			
	<b>SEM NO.</b>	<b>REF. NO.</b>	<b>Type / Model</b>
	8707	1338931	95XF
<b>Description</b>			
Radiator Hose			
60x60x440x330			
	<b>SEM NO.</b>	<b>REF. NO.</b>	<b>Type / Model</b>
	8708	1297739	95XF
<b>Description</b>			
Radiator Hose			
60x60x620x450			
	<b>SEM NO.</b>	<b>REF. NO.</b>	<b>Type / Model</b>
	8709	1290141	95XF
<b>Description</b>			
Radiator Hose			
31x42x440x365			
	<b>SEM NO.</b>	<b>REF. NO.</b>	<b>Type / Model</b>
	8710	1293808	95XF
<b>Description</b>			
Radiator Hose			
22x26x410x365			

Type / Model	REF. NO.	ŞEM NO.	
XF95	1399817	9570	 <p><b>Description</b> Radiator Hose</p> <p>30x26x30x665</p>
XF95	1689072 1677023 1427154 1657516	9571	 <p><b>Description</b> Radiator Hose</p> <p>26x20x770</p>
XF95	1689073 1677024 1427155 1657517	9572	 <p><b>Description</b> Radiator Hose</p> <p>20,5x26x860</p>
XF95	1340132	9573	 <p><b>Description</b> Breather Hose</p> <p>11x11x340</p>
XF95	1293807	10586	 <p><b>Description</b> Radiator Coolant Hose</p> <p>30x26x640</p>
75 CF 85 CF	1440841	10587	 <p><b>Description</b> Coolant Hose</p> <p>50x55x120</p>

SEM NO.	REF. NO.	Type / Model
10588	1376266	75 CF
		
<b>Description</b> Coolant Hose		
17x28x28		

SEM NO.	REF. NO.	Type / Model
10589	356923	75 CF
		
<b>Description</b> Oil Hose		
34x34x695		







SEM NO.	REF. NO.	Type / Model
10590	1348108	75 CF
		
<b>Description</b> Oil cooler Hose		
31x34x360		

SEM NO.	REF. NO.	Type / Model
10591	1247618	85 CF
		
<b>Description</b> Coolant Hose		
58x61x465		

SEM NO.	REF. NO.	Type / Model
10592	1297998	75 CF
		
<b>Description</b> Coolant Hose		
60x60x305		

SEM NO.	REF. NO.	Type / Model
11107	1297728 1243903	85 CF
		
<b>Description</b> Coolant Hose		
45x45x73		



<b>Type / Model</b>	<b>REF. NO.</b>	<b>SEM NO.</b>	
	1313582	<b>11108</b>	
		<b>Description</b>	Coolant Hose
			21x25x450
<b>Type / Model</b>	<b>REF. NO.</b>	<b>SEM NO.</b>	
85 CF	1435716	<b>11109</b>	
		<b>Description</b>	Coolant Hose
			27x31x720
<b>Type / Model</b>	<b>REF. NO.</b>	<b>SEM NO.</b>	
85 CF	1606133	<b>11726</b>	
		<b>Description</b>	Water Cooling Hose
			17x20x1100
<b>Type / Model</b>	<b>REF. NO.</b>	<b>SEM NO.</b>	
85 CF	1388285	<b>11727</b>	
		<b>Description</b>	Water Cooling Hose
			19x19x235
<b>Type / Model</b>	<b>REF. NO.</b>	<b>SEM NO.</b>	
	1386086	<b>11837</b>	
		<b>Description</b>	Expansion Tank Hose
			10x10x1440
<b>Type / Model</b>	<b>REF. NO.</b>	<b>SEM NO.</b>	
	1297719	<b>11890</b>	
		<b>Description</b>	Coolant Hose
			65x65x78

SEM NO.		REF. NO.	Type / Model
11891		1670856	
			
<b>Description</b> Coolant Hose			
60x60x650			













SEM NO.		REF. NO.	Type / Model
11892		1645506	
			
<b>Description</b> Coolant Hose			
31x27x890			











SEM NO.		REF. NO.	Type / Model
11893		1427570	
			
<b>Description</b> Coolant Hose			
27x21x212			

SEM NO.		REF. NO.	Type / Model
11894		1683774	
			
<b>Description</b> Coolant Hose			
60x65x780			

SEM NO.		REF. NO.	Type / Model
11895		1434385	
			
<b>Description</b> Coolant Hose			
19x19x330			

SEM NO.		REF. NO.	Type / Model
11896		1427572	
			
<b>Description</b> Coolant Hose			
21x21x140			

<b>Type / Model</b>	<b>REF. NO.</b>		<b>SEM NO.</b>	
	1638928		<b>11897</b>	<b>Description</b> Coolant Hose
27x27x287				
<b>Type / Model</b>	<b>REF. NO.</b>		<b>SEM NO.</b>	
	0799066		<b>11898</b>	<b>Description</b> Coolant Hose
9x9x2010				
<b>Type / Model</b>	<b>REF. NO.</b>		<b>SEM NO.</b>	
	1434384		<b>11899</b>	<b>Description</b> Coolant Hose
19x19x295				
<b>Type / Model</b>	<b>REF. NO.</b>		<b>SEM NO.</b>	
	1638927		<b>11900</b>	<b>Description</b> Air Hose
9x9x430				
<b>Type / Model</b>	<b>REF. NO.</b>		<b>SEM NO.</b>	
	1350004		<b>11901</b>	<b>Description</b> Coolant Hose
60x68x635				
<b>Type / Model</b>	<b>REF. NO.</b>		<b>SEM NO.</b>	
	1297996		<b>11902</b>	<b>Description</b> Coolant Hose
55x60x485				

	<b>SEM NO.</b>		<b>REF. NO.</b>	<b>Type / Model</b>
	11903		1427150	
<b>Description</b>				
Coolant Hose				
21x21x225				
	<b>SEM NO.</b>		<b>REF. NO.</b>	<b>Type / Model</b>
	11948		1387154	
<b>Description</b>				
Coolant Hose				
8x8x115				
	<b>SEM NO.</b>		<b>REF. NO.</b>	<b>Type / Model</b>
	11949		1387155	
<b>Description</b>				
Coolant Hose				
8x8x130				
	<b>SEM NO.</b>		<b>REF. NO.</b>	<b>Type / Model</b>
	11952		1399815	
<b>Description</b>				
Coolant Hose				
60x60x430				
	<b>SEM NO.</b>		<b>REF. NO.</b>	<b>Type / Model</b>
	11997		1643771	
<b>Description</b>				
Cooling Hose				

Type / Model	REF. NO.	ŞEM NO.	
BLACK	1204236	8868	 <b>Description</b> Silicon Hose D=Ø100 mm L=120 mm 1 HUMP
RED	1346328		
	0291452		
	0292577		
	1286075		

Type / Model	REF. NO.	ŞEM NO.	
BLUE	1142699	8869	 <b>Description</b> Silicon Hose D=Ø50 mm D=Ø60 mm L:115 mm

Type / Model	REF. NO.	ŞEM NO.	
BLACK	1633705	11191	 <b>Description</b> Silicon Hose Ø50XØ55X110
RED	1676184		
	1325086		
	1439581		

Type / Model	REF. NO.	ŞEM NO.	
RED	1378391	11192	 <b>Description</b> Silicon Hose Ø100X400 11 hump

Type / Model	REF. NO.	ŞEM NO.	
RED	1377572 0528299 0281514	11193	 <b>Description</b> Silicon Hose Ø76X75

Type / Model	REF. NO.	ŞEM NO.	
	1650940	11831	 <b>Description</b> Silicon Hose Ø50x55x110



SEM NO.

11832



REF. NO.

1353428

Type / Model

**Description**

Silicon Hose

Ø100x155x165

Model:		SEM NO. 11973	Description / Repair Kit
		REF. NO: 1391518	



	ŞEM NO.	REF. NO.	Type / Model
	<b>9326</b>	1407144 1700912 1405655 1406025	
	<b>Description</b>	1401940	
	Tie Rod		
L=889,5 koni=22 boru=38			







	ŞEM NO.	REF. NO.	Type / Model
	<b>10121</b>	1351734 1291060 1385499	
	<b>Description</b>		
	Tie Rod		
L 1005 mm			

	ŞEM NO.	REF. NO.	Type / Model
	<b>10122</b>	1270853 1353391	
	<b>Description</b>		
	Tie Rod		
L 1690 mm			

	ŞEM NO.	REF. NO.	Type / Model
	<b>10123</b>	1700913 1406600	
	<b>Description</b>		
	Tie Rod		
L 900 mm			

	ŞEM NO.	REF. NO.	Type / Model
	<b>11548</b>	1401937	
	<b>Description</b>		
	Tie Rod		

	ŞEM NO.	REF. NO.	Type / Model
	<b>11549</b>	1297572 1361155	
	<b>Description</b>		
	Tie Rod		

Type / Model	REF. NO.	SEM NO.	
	1395994	11550	 <b>Description</b> Tie Rod
	1405309	11551	 <b>Description</b> Tie Rod
	1408040	11552	 <b>Description</b> Tie Rod
	1385500 1291048 1351735	 11791	 <b>Description</b> Tie Rod
	1602821	 12906	 <b>Description</b> Tie Rod

L=867

	SEM NO.	REF. NO.	Type / Model
	8631 (8662)	0607981	65 F1600
		0698450	75 1700
<b>Description</b> Rod End		1257890	85 1800
		1603789	95 1900
		1149907	2000
		1618048	2100
		ACHF060	FA2000
			2105

M30Xx1.5 RHT L=120

	SEM NO.	REF. NO.	Type / Model
	8632 (8663)	0607053	65 F1600
		0696205	75 1700
<b>Description</b> Rod End		1228115	85 1800
		0696225	95 1900
		1329134	2000
			2100
			FA2000
			2105

M30Xx1.5 RHT L=120

	SEM NO.	REF. NO.	Type / Model
	8633 (8664)	0110197	45
		0607451	F1200
<b>Description</b> Rod End		1228114	1700
		0607453	1900
		ACU9242	

M28Xx1.5 RHT L=105

	SEM NO.	REF. NO.	Type / Model
	8634 (8665)	0110196	45
		0607452	F1200
<b>Description</b> Rod End		1373137	1700
		ACU9241	1901







M28Xx1.5 RHT L=105





	SEM NO.	REF. NO.	Type / Model
	8635 (8666)	0586753	1331925
		0607999	1137230
<b>Description</b> Rod End		0698609	1326896
		0694298	ACHB064
		1229944	ACHF242
		0694360	MAK1296
			1400
			1500
			1600
			1700







M30Xx1.5 RHT L=115







	SEM NO.	REF. NO.	Type / Model
	8636 (8667)	0311300	65
		1338714	75
<b>Description</b> Rod End		0607998	85
		1315447	1200
		1319838	1300
		ACHF241	1400
		MAK1295	1500
			1600
			1700

M30Xx1.5 LHT L=115







Type / Model	REF. NO.	SEM NO.	
95	608530	<b>8637</b> (8668)	 <b>Description</b> Rod End M24x1.5 RHT L=95
F1600	0069867 0161376 608000 1142173	<b>8639</b> (8669)	 <b>Description</b> Rod End M30x1.5 RHT L=120
	1604248	<b>8670</b>	 <b>Description</b> Rod End M28x1.5 RHT L=150
	1604247 1705908 1902996 1703473	<b>8671</b>	 <b>Description</b> Rod End M28x1.5 LHT L=150
IVECO ZETA 50-9 / 50-10 60-10 60-11 / 65-10 65-12 65-9 / 79-10 79-12 / 79-13 / 79-14 IVECO ZETA A 60-10 / 70-12 / 70-14 IVECO M 115-17 / 135-17 145-17 159-17 IVECO 80.12 / 85.12 / 120.14 FIAT M29 / M50	1689604	<b>8688</b>	 <b>Description</b> Rod End M28x1.5 RHT L=115
	1401942 AFRA635	<b>10147</b>	 <b>Description</b> Rod End M30Xx1.5 LHT L=120

	SEM NO.	REF. NO.	Type / Model
	<b>10931</b>	0589333 0656085 1249129 140362	
	<b>Description</b>		
			Rod End
	<b>10937</b>	0592106 0656084 1249088 140363	
	<b>Description</b>		
			Rod End
	<b>10943</b>	542477	
	<b>Description</b>		
			Rod End
	<b>11570</b>	0067389	
	<b>Description</b>		
			Rod End

<b>Type / Model</b>	<b>REF. NO.</b>	<b>SEM NO.</b>	
	0067303	11571	
		<b>Description</b>	
		Rod End	
<b>Type / Model</b>	<b>REF. NO.</b>	<b>SEM NO.</b>	
	1407394	11572	
		<b>Description</b>	
		Rod End	
<b>Type / Model</b>	<b>REF. NO.</b>	<b>SEM NO.</b>	
	1403899	11573	
		<b>Description</b>	
		Rod End	
<b>Type / Model</b>	<b>REF. NO.</b>	<b>SEM NO.</b>	
	1603883	11574	
		<b>Description</b>	
		Rod End	
<b>Type / Model</b>	<b>REF. NO.</b>	<b>SEM NO.</b>	
	1685552	11579	
		<b>Description</b>	
		Rod End	
<b>Type / Model</b>	<b>REF. NO.</b>	<b>SEM NO.</b>	
	1389190	11580	
		<b>Description</b>	
		Rod End	

	SEM NO.	REF. NO.	Type / Model
 D=Ø62,5 d=Ø24 h=86	8755	1357764	
	<b>Description</b>		
	Spring Bushing		
	<hr/>		
	SEM NO.	REF. NO.	Type / Model
 D=Ø62,5 d=Ø24 h=106	8756	1368283	
	<b>Description</b>		
	Spring Bushing		
	<hr/>		
	SEM NO.	REF. NO.	Type / Model
 D=Ø61 d=Ø24 h=86	10827	1671219	
	<b>Description</b>		
	Stabilizer Bushing		
	<hr/>		
	SEM NO.	REF. NO.	Type / Model
 D=Ø52 d=Ø18 L=97	12958	1401489	
	<b>Description</b>		
	Spring Eye Bushing		
	<hr/>		
	SEM NO.	REF. NO.	Type / Model
 D=Ø52 d=Ø18 L=158	12959	1401487	
	<b>Description</b>		
	Spring Eye Bushing		
	<hr/>		
	SEM NO.	REF. NO.	Type / Model
 D=Ø60 d=Ø18 Ax=132	10237 (1044)	1681114	
	<b>Description</b>		
	Rubber Metal Bush		



<b>Type / Model</b>	<b>REF. NO.</b>	<b>SEM NO.</b>	 <b>Description</b> Spring Bushing D = Ø31 d = Ø26 L = 52
	0679253	11604	
<b>Type / Model</b>	<b>REF. NO.</b>	<b>SEM NO.</b>	 <b>Description</b> Spring Bushing D = Ø42 d = Ø35 L = 97
	0659666 0643384 0631075	11605	
<b>Type / Model</b>	<b>REF. NO.</b>	<b>SEM NO.</b>	 <b>Description</b> Spring Bushing D = Ø42 d = Ø35 L = 77
	0654870	11606	
<b>Type / Model</b>	<b>REF. NO.</b>	<b>SEM NO.</b>	 <b>Description</b> Spring Bushing D = Ø32 d = Ø25 L = 77
	0645245	11607	
<b>Type / Model</b>	<b>REF. NO.</b>	<b>SEM NO.</b>	 <b>Description</b> Spring Bushing D = Ø37 d = Ø32 L = 72
	0266412	11608	
<b>Type / Model</b>	<b>REF. NO.</b>	<b>SEM NO.</b>	 <b>Description</b> Spring Bushing D = Ø37 d = Ø32 L = 52
	0092961	11628	





Type / Model	REF. NO.	SEM NO.	
	0652575 652575	10308	
		<b>Description</b>	
		Nut	
			M22x1,5







<b>Model:</b>		<b>SEM NO.</b>	<b>Description / Spring Bushing Repair Kit</b>
		<b>13035</b>	

Item No	Ref. No
1	1357764
2	1365622
3	1426976
4	0638475

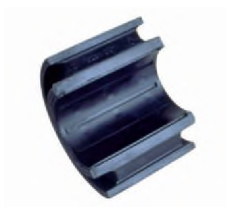
**REF. NO:**  
1357764S



	<b>SEM NO.</b> 10201	<b>REF. NO.</b> 1779767 1699564	<b>Type / Model</b>
<b>Description</b> Spring Mounting			
	<b>SEM NO.</b> 11592	<b>REF. NO.</b> 1628826	<b>Type / Model</b>
<b>Description</b> Rubber Metal Buffer			
A=70 B=90 h=13 M6			
	<b>SEM NO.</b> 11593	<b>REF. NO.</b> 1628828	<b>Type / Model</b>
<b>Description</b> Rubber Metal Buffer			
A=70 B=90 h=13 M6			
	<b>SEM NO.</b> 11939	 <b>REF. NO.</b> 361477	<b>Type / Model</b>
<b>Description</b> Rubber Metal Buffer			
D=Ø75 h=17			

<b>Type / Model</b>	<b>REF. NO.</b>	<b>SEM NO.</b>	
	0281007	<b>7688</b>	
		<b>Description</b>	
		Stabilizer Bush (Half)	
			D=Ø94 d=Ø44 h=80 h=70
<b>Type / Model</b>	<b>REF. NO.</b>	<b>SEM NO.</b>	
	0298498	<b>8119 (8120)</b>	
		<b>Description</b>	
		Stabilizer Bushing	
			D=Ø94 d=Ø62 h=80 h=70
<b>Type / Model</b>	<b>REF. NO.</b>	<b>SEM NO.</b>	
	1402587	<b>10542</b>	
		<b>Description</b>	
		Stabilizer Bush	
			d=Ø46 h=93
<b>Type / Model</b>	<b>REF. NO.</b>	<b>SEM NO.</b>	
	1402590	<b>10543</b>	
		<b>Description</b>	
		Stabilizer Bush	
			d=Ø48 h=93
<b>Type / Model</b>	<b>REF. NO.</b>	<b>SEM NO.</b>	
	0366351	<b>7687</b>	
		<b>Description</b>	
		Stabilizer Bush	
			D=Ø85 d=Ø64 h=60
<b>Type / Model</b>	<b>REF. NO.</b>	<b>SEM NO.</b>	
	0558864 0371586	<b>7728</b>	
		<b>Description</b>	
		Stabilizer Bush	
			D=Ø86 d=Ø57 h=60,5

	SEM NO.	REF. NO.	Type / Model
 D=Ø62 d=Ø43 h=60	9048	1732887 1291233	
	<b>Description</b>		
			Stabilizer Bush







	SEM NO.	REF. NO.	Type / Model
 d=Ø38	10540	1288000 1732886	
	<b>Description</b>		
			Stabilizer Bush

	SEM NO.	REF. NO.	Type / Model
 D= Ø82 d= Ø50 L=75	11594	1323838	
	<b>Description</b>		
			Rubber Metal Bushing

	SEM NO.	REF. NO.	Type / Model
 D= Ø82 d= Ø56 L=75	11595	1323839	
	<b>Description</b>		
			Rubber Metal Bushing

	SEM NO.	REF. NO.	Type / Model
 Ø33,5x53/62,5x57,5	8758	1400147	
	<b>Description</b>		
			Stabilizer Rubber

	SEM NO.	REF. NO.	Type / Model
 Ø26,5x53/63x52,5	8759	1402562	
	<b>Description</b>		
			Stabilizer Rubber

<b>Type / Model</b>	<b>REF. NO.</b>	<b>SEM NO.</b>	
	0010761	8791	
			<b>Description</b> Stabilizer Rubber 39,5x59x80
<b>Type / Model</b>	<b>REF. NO.</b>	<b>SEM NO.</b>	
	0082522	7564	
			<b>Description</b> Ball Joint D=Ø55 d=Ø17 Ax=100
<b>Type / Model</b>	<b>REF. NO.</b>	<b>SEM NO.</b>	
	0295726	9035	
			<b>Description</b> Bush D=Ø55 d=Ø20 h=56
<b>Type / Model</b>	<b>REF. NO.</b>	<b>SEM NO.</b>	
	1283618	9049	
			<b>Description</b> Stabilizer Bush D=Ø60 d=Ø20 h=60
<b>Type / Model</b>	<b>REF. NO.</b>	<b>SEM NO.</b>	
	1273279 1287999	9198	
			<b>Description</b> Spring Eye Bushing D=Ø46,5 d=Ø16 h=50
<b>Type / Model</b>	<b>REF. NO.</b>	<b>SEM NO.</b>	
	0268045	10536	
			<b>Description</b> Stabilizer Bush D=Ø70 d=Ø50 L=75



	SEM NO.	REF. NO.	Type / Model
	10537	0268044	
<b>Description</b>			
Stabilizer Bush			
D=Ø70 d=Ø55 L=75			



	SEM NO.	REF. NO.	Type / Model
	10538	0763523	
<b>Description</b>			
Stabilizer Bush			
D=Ø75 d=Ø50 L=60			

	SEM NO.	REF. NO.	Type / Model
	11974	 0538329	
<b>Description</b>			
Stabilizer Bush			
D=Ø75 d=Ø40 h=60			

	SEM NO.	REF. NO.	Type / Model
	11975	 0096109	
<b>Description</b>			
Stabilizer Bush			
D=Ø75 d=Ø45 h=60			

	SEM NO.	REF. NO.	Type / Model
	10467	274650 0274650	
<b>Description</b>			
Stabilizer Bush			
D=Ø50 d=Ø40,5 L=23,5			

	SEM NO.	REF. NO.	Type / Model
	10535	0299106 0290825 02599524 290825 299106 2599524	
<b>Description</b>			
Stabilizer Bush			
D=Ø55 d=Ø30 L=56			

Type / Model	REF. NO.	SEM NO.	
	0274651 274651	10892	 <b>Description</b> Plastic Bearing D=Ø60 d=Ø50 L=23
Type / Model	REF. NO.	SEM NO.	
	0268043	11976	 <b>Description</b> Bush D=Ø35 d=Ø25,5 h=23



**Description / Stabilizer Repair Kit** **SEM NO.** **Model:**

**9153**

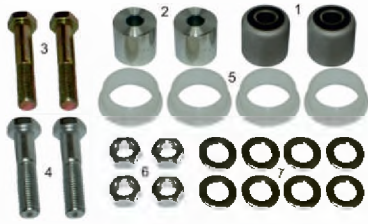

**REF. NO:**  
0295726S  
0274651S1  
274651S1

Item No	Ref. No
1	0295726
2	0298053
3	0282812
4	0286369
5	0274651
6	1355553
7	0202838

**Description / Stabilizer Repair Kit** **SEM NO.** **Model:**

**9154**



**REF. NO:**  
1283618S  
0295726S1

Item No	Ref. No
1	1283618
2	0295726
3	0282812
4	0286369
5	1355553
6	0202838

**Description / Stabilizer Repair Kit** **SEM NO.** **Model:**

**9155**



**REF. NO:**  
0274651S  
274651S

Item No	Ref. No
1	0298053
2	0274651
3	0282812
4	1355553

**Description / Stabilizer Repair Kit** **SEM NO.** **Model:**

**9156**



**REF. NO:**  
1283618S1  
0366351S

Item No	Ref. No
1	0366351
2	1283618
3	0311049
4	0286369
5	1355553
6	0202838

**Model:** **SEM NO.** **Description / Stabilizer Repair Kit**

**9157**

Item No	Ref. No
1	1283618
2	0311049
3	0286369
4	1355553
5	0202838

**REF. NO:**  
1283618S2



	SEM NO.	REF. NO.	Type / Model
 D=Ø67 d=Ø19 Ax=130	7615 (7910)	1321936	
	<b>Description</b> Ball Joint (Kit)		

	SEM NO.	REF. NO.	Type / Model
 D=Ø67 d=Ø17 Ax=115	9072 (9073)	1243618	CF XF
	<b>Description</b> Ball Joint (Kit)		

	SEM NO.	REF. NO.	Type / Model
 D=Ø72 d=Ø19 Ax=130	8035	1271124S	
	<b>Description</b> Ball Joint (Kit)		

	SEM NO.	REF. NO.	Type / Model
 D=Ø75 d=Ø17 Ax=115	7595 (7753)	0689748 689748	
	<b>Description</b> Ball Joint (Kit)		

	SEM NO.	REF. NO.	Type / Model
 D=Ø75 d=Ø19 Ax=130	7635 (7764)	0067354	
	<b>Description</b> Ball Joint (Kit)		

	SEM NO.	REF. NO.	Type / Model
 D=Ø75 d=Ø21 Ax=130	7636 (8219)	1252284	
	<b>Description</b> Ball Joint (Kit)		

<b>Type / Model</b>	<b>REF. NO.</b>	<b>SEM NO.</b>	
	20266127	7950	
			<p><b>Description</b> Ball Joint (Kit)</p> <p>D=Ø75 d=Ø25 Ax=130</p>
<b>Type / Model</b>	<b>REF. NO.</b>	<b>SEM NO.</b>	
	1376729	8313 (8819)	
			<p><b>Description</b> Ball Joint (Kit)</p> <p>D=Ø75 d=Ø23 Ax=152</p>
<b>Type / Model</b>	<b>REF. NO.</b>	<b>SEM NO.</b>	
	1376728	9044	
			<p><b>Description</b> Ball Joint (Kit)</p> <p>D=Ø75 d=Ø21 Ax=130</p>
<b>Type / Model</b>	<b>REF. NO.</b>	<b>SEM NO.</b>	
Alternative Rubber Type	0693778S 693778S	7431	
			<p><b>Description</b> Ball Joint (Kit)</p> <p>D=Ø80 d=Ø21 Ax=152</p>
<b>Type / Model</b>	<b>REF. NO.</b>	<b>SEM NO.</b>	
	0689749	7335 (7739)	
			<p><b>Description</b> Ball Joint (Kit)</p> <p>D=Ø85 d=Ø19 Ax=130</p>
<b>Type / Model</b>	<b>REF. NO.</b>	<b>SEM NO.</b>	
	0691703	7432 (7743)	
			<p><b>Description</b> Ball Joint (Kit)</p> <p>D=Ø85 d=Ø21 Ax=152</p>

	SEM NO.	REF. NO.	Type / Model
	7565 (7748)	0513757 0691709 513757 691709	
	<b>Description</b>		
			Ball Joint (Kit)
D=Ø85 d=Ø21 Ax=130			

	SEM NO.	REF. NO.	Type / Model
	9075	0698724	
	<b>Description</b>		
			Ball Joint (Kit)
D=Ø85 d=Ø23 Ax=152			



	SEM NO.	REF. NO.	Type / Model
	7880 (7881)	0696321 696321 1208071	
	<b>Description</b>		
			Ball Joint (Kit)
D=Ø95 d=Ø23 Ax=152			

	SEM NO.	REF. NO.	Type / Model
	7556	1252283	
	<b>Description</b>		
			Ball Joint (Kit)
D=67 d=25 L=140			

	SEM NO.	REF. NO.	Type / Model
	9095	1208073	
	<b>Description</b>		
			Ball Joint (Kit)
D=Ø67 L=95			

	SEM NO.	REF. NO.	Type / Model
	8530 (8531)	0689747	
	<b>Description</b>		
			Ball Joint (Kit)
D=Ø85 L=171			



Type / Model	REF. NO.	SEM NO.	
	1445656	7774 (8827)	 <p><b>Description</b> Ball Joint (Kit)</p> <p>D=Ø108 d=Ø36 L=67</p>
Type / Model	REF. NO.	SEM NO.	
	1676776	11988	 <p><b>Description</b> Ball Joint (Kit)</p> <p>D=Ø108 d=Ø36 L=67</p>

Description / Ball Joint (Repair Kit)	SEM NO.	Model:
---------------------------------------	---------	--------

7736 (7759)



REF. NO:  
1271124

D=Ø72 d=Ø19 Ax=130

Description / Ball Joint (Repair Kit)	SEM NO.	Model:
---------------------------------------	---------	--------

7829 (8985)



REF. NO:  
1398368

Ø72

Description / Ball Joint (Repair Kit)	SEM NO.	Model:
---------------------------------------	---------	--------

7832 (7833)



REF. NO:  
0691704  
691704  
1183201

Ø72



Description / Ball Joint (Repair Kit)	SEM NO.	Model:
---------------------------------------	---------	--------







8619 (8621)





REF. NO:  
1376730



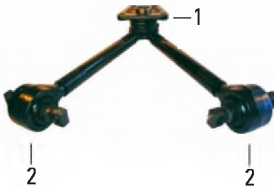

D=Ø72 d=Ø45 M20x1,5

Model:	SEM NO.	Description / Ball Joint (Plastic)
	7793 (7705)	 <p data-bbox="773 409 852 506">REF. NO: 0693778 693778</p> <p data-bbox="773 664 852 692">D=Ø 80</p>
Model:	SEM NO.	Description / Ball Joint (Repair Kit)
	7827 (8968)	 <p data-bbox="773 897 852 962">REF. NO: 0696320</p> <p data-bbox="794 1152 832 1180">Ø90</p>

	ŞEM NO.	REF. NO.	Type / Model
 <p>L=606 d=Ø19/19 Ax=130/130</p>	9342	1294251	1- 9595 Page 85
<b>Description</b>			
Axle Rod Alternative Rubber			
	ŞEM NO.	REF. NO.	Type / Model
 <p>L=611 d=Ø21/21 Ax=130/130</p>	9343	1656428 1361650 0267743 1361649	1- 9044 Page 505
<b>Description</b>			
Axle Rod			
	ŞEM NO.	REF. NO.	Type / Model
 <p>L=390 d=Ø21/Ø19 Ax=152/130</p>	10872	1261101	1- 7736 Page 508 2- 7793 Page 509
<b>Description</b>			
Axle Rod			
	ŞEM NO.	REF. NO.	Type / Model
 <p>L=665 d=Ø17/17 Ax=115/115</p>	12916	0099990 099990	1- 7595 Page 504
<b>Description</b>			
Axle Rod			
	ŞEM NO.	REF. NO.	Type / Model
 <p>L=600 d=Ø21/21 Ax=130/130</p>	12928	0646373 0655695 0655697 1284860 1620438	1- 7565 Page 506
<b>Description</b>			
Axle Rod			
	ŞEM NO.	REF. NO.	Type / Model
 <p>L=595 d=Ø21/21 Ax=130/130</p>	12940	1620439	1- 8616 Page 90
<b>Description</b>			
Axle Rod			

Type / Model	REF. NO.	SEM NO.	
1- 11988 Page 507 2- 8313 Page 505	0080521	<b>9438</b>	 <p>—1 2 — 2</p> <p><b>Description</b> Axle Rod ( V )</p> <p>L=609 Ax=152/152 d=Ø23/23</p>
	1361651		
	1368270		
	1390932		
	1617096		
	1793875		
1817808	1892492		
Type / Model	REF. NO.	SEM NO.	
1- 7827 Page 509 2- 9075 Page 506	1620436	<b>10152</b>	 <p>—1 2 2</p> <p><b>Description</b> Axle Rod ( V )</p> <p>L=608 d=Ø23/23 Ax=152/152</p>
	1361652		
	1793876		
Type / Model	REF. NO.	SEM NO.	
1- 7827 Page 509 2- 7880 Page 506	0649819	<b>10154</b>	 <p>—1 2 — 2</p> <p><b>Description</b> Axle Rod ( V )</p> <p>L=603 d=Ø23/23 Ax=152/152</p>
	1620437		
	1793877		

	<b>ŞEM NO.</b>	<b>REF. NO.</b>	<b>Type / Model</b>
	<b>9602</b>	92968 1283726 279245 1283852 296305 1286348 378220 1327883 1205672	1211866 1283723 1283724 1283725 SACHS 106976 SACHS 131426 SACHS 131158 MONROE T5052 MONROE T5053
	<b>ŞEM NO.</b>	<b>REF. NO.</b>	<b>Type / Model</b>
	<b>9603</b>	222773 1282623 252620 1282624 360585 1283732 380585 1328748	740021 755262 SACHS 112145 SACHS 124874 MONROE T5045 SACHS 112002 MONROE T5046
	<b>ŞEM NO.</b>	<b>REF. NO.</b>	<b>Type / Model</b>
	<b>9606</b>	1336823 1336827	
	<b>ŞEM NO.</b>	<b>REF. NO.</b>	<b>Type / Model</b>
	<b>10228</b>	251700112278 0083654	
	<b>ŞEM NO.</b>	<b>REF. NO.</b>	<b>Type / Model</b>
	<b>11455</b>	1382704 1398694 1427903 1618606 1696290 1696292	SACHS 290983 SACHS 290979 SACHS 290980 MONROE T5227 MONROE T5183
	<b>ŞEM NO.</b>	<b>REF. NO.</b>	<b>Type / Model</b>
	<b>11473</b>	260035 656395 MONROE Cb0120	

Type / Model	REF. NO.	SEM NO.	
OPEN LENGTH=647	98923	1283735	 <b>Description</b> Shock Absorber
CLOSED LENGTH=374	655776	505065	
UPPER MOUNT	114099	1283743	
DIMENSION=M16x77	1273854	505464	
LOWER MOUNT	373838	617739	
DIMENSION=M16x77	1283733	MONROE T5143	
	378225		
Type / Model	REF. NO.	SEM NO.	
	0109860	9014	 <b>Description</b> Rubber Mounting D=Ø59,5 d=Ø20,5 h=31,5
Type / Model	REF. NO.	SEM NO.	
	0699425	9015	 <b>Description</b> Rubber Mounting D=Ø57 d=Ø34,5 h=42
Type / Model	REF. NO.	SEM NO.	
	0698429	9016	 <b>Description</b> Rubber Mounting D=Ø40 d=Ø25 h=40
Type / Model	REF. NO.	SEM NO.	
	1620344	9028	 <b>Description</b> Rubber Mounting D=Ø49,5 d=Ø19 h=20
	93159607		



	<b>ŞEM NO.</b> 72.719.R	<b>REF. NO.</b> 818225	<b>Technical Specification</b> Total Weight 2,8 kg
	<b>Description</b> Roll		
	<b>ŞEM NO.</b> 72.727.R	<b>REF. NO.</b> 0638148 Van Hool 624319-640 VDL Bus 0638148	<b>Technical Specification</b> Total Weight 2,5 kg
	<b>Description</b> Roll		
	<b>ŞEM NO.</b> 72.810.C	<b>REF. NO.</b> 1384273 CONTITECH 810 MB GY SPRINGRIDE D13B01 PHOENIX 1 D 28 A 2 CF GOMMA REF.1T19E 1 Taurus KR621 26 CF GOMMA NO.87413/1 VIBRACOUSTIC V1D28A 2 DUNLOP UK 00984A AP FIRESTONE 1T19L 7	<b>Technical Specification</b> GART NO.277.4.420 FIRESTONE W01-M58-6345 GART REF.D277/B FIRESTONE W01-M58-8775 GOODYEAR1R14-716 GY SPRINGRIDE D13B20 Granning 15635 Total Weight 10,5 kg
	<b>Description</b> Metal Piston		
	<b>ŞEM NO.</b> 72.811.C	<b>REF. NO.</b> 1384274 CONTITECH 811 MB CF GOMMA NO.203878 GOODYEAR 1R14 718 DUNLOP UK PNP311670000 GY SPRINGRIDE D13B34 GART NO.277.4.506 CF GOMMA REF.1T19E 2 GART REF.D277/B	<b>Technical Specification</b> Total Weight 13,3 kg
	<b>Description</b> Metal Piston		
	<b>ŞEM NO.</b> 72.836.2C1	<b>REF. NO.</b> 0388167 CONTITECH 836 M2K1 FIRESTONE W01-M58-8721 PHOENIX 1 DF 25-13 GOODYEAR 1R12-711 VIBRACOUSTIC V1DF25-13 GY SPRINGRIDE D13B31 FIRESTONE 1T17AR-4.5	<b>Technical Specification</b> Total Weight 7,8 kg
	<b>Description</b> Metal Piston		
	<b>ŞEM NO.</b> 72.836.C1	<b>REF. NO.</b> 0388165 1697678 CONTITECH 836 MK1 FIRESTONE W01-M58-8722 PHOENIX1 DF 25-11 GOODYEAR 1R12-712 VIBRACOUSTIC V1DF25-11 GY SPRINGRIDE D13B32 FIRESTONE 1T17AR-4.5	<b>Technical Specification</b> Total Weight 7,7 kg
	<b>Description</b> Metal Piston		

Technical Specification	REF. NO.	SEM NO.	
Total Weight 10,3 kg	0526651 CONTITECH 836 MB K6 PHOENIX1 DF 25 15 VIBRACOUSTICV1DF25 15 FIRESTONE1T17AR 4.5 FIRESTONEW01 M58 8701 GOODYEAR1R12 768 GY SPRINGRIDED13B43 VDL Bus0526651	72.836.C6	
		<b>Description</b>	
		Metal Piston	
Technical Specification	REF. NO.	SEM NO.	
Total Weight 9,3 kg	0297721 CONTITECH 836 MK7 FIRESTONE W01-M58-8715 PHOENIX 1 DF 25-12 GOODYEAR 1R12-723 VIBRACOUSTIC V1DF25-12 GY SPRINGRIDE D13B33 FIRESTONE 1T17AR-4.5	72.836.C7	
		<b>Description</b>	
		Metal Piston	
Technical Specification	REF. NO.	SEM NO.	
Total Weight 3,7 kg	0067504 CONTITECH 836 M FIRESTONE W01-D08-0776 PHOENIX1 DF 25-1 NP FIRESTONE W01-M58-0776 VIBRACOUSTIC V1DF25-1 GOODYEAR 1R12-700 FIRESTONE 1T17AR-4.5 GY SPRINGRIDE D13U32	72.836.S	
		<b>Description</b>	
		Service Assembly	
Technical Specification	REF. NO.	SEM NO.	
Total Weight 3,7kg	0513985 CONTITECH 836 MB FIRESTONE W01-M58-0775 PHOENIX1 DF 25-4 NP GOODYEAR 1R12-764 VIBRACOUSTIC V1DF25-4 GY SPRINGRIDE D12U27 FIRESTONE 1T17AR-4.5 VDL Bus0 513 985	72.836.S1	
		<b>Description</b>	
		Service Assembly	
Technical Specification	REF. NO.	SEM NO.	
Total Weight 3,7 kg	0513982 CONTITECH 836 M2 FIRESTONE W01 M58 0777 PHOENIX1 DF 25 3 NP GOODYEAR 1R12 710 VIBRACOUSTIC V1DF25 3 GY SPRINGRIDE D13U31 FIRESTONE 1T17AR 4.5 VDL Bus 0513982 FIRESTONE W01 D08 0777	72.836.S2	
		<b>Description</b>	
		Service Assembly	
Technical Specification	REF. NO.	SEM NO.	
Total Weight 8,5 kg	559483 CONTITECH 887 M2K1 FIRESTONE W01 D08 8684 FIRESTONE 1T15LNR-3	72.887.2C1	
		<b>Description</b>	
		Metal Piston	

	<b>SEM NO.</b> <b>72.887.C1</b>	<b>REF. NO.</b> 0392022 0392011 1697684 CONTITECH 887 MK1 VIBRACOUSTIC V1DF18-2 FIRESTONE 1T15LNR-3 FIRESTONE W01-M58-8683	<b>Technical Specification</b> Total Weight 6,5 kg
	<b>Description</b> Metal Piston		
	<b>SEM NO.</b> <b>72.887.S</b>	<b>REF. NO.</b> 0513983 CONTITECH 887 M GOODYEAR 1R11-796 FIRESTONE 1T15LNR-3 GY SPRINGRIDE D11U41 FIRESTONE W01-M58-0780 VDL Bus 0 513 983	<b>Technical Specification</b> Total Weight 3 kg
	<b>Description</b> Service Assembly		
	<b>SEM NO.</b> <b>72.889.C2</b>	<b>REF. NO.</b> 1279141 1698434 CONTITECH 889 M K2 FIRESTONE W01-M58-8679 FIRESTONE 1T15LLR-5	<b>Technical Specification</b> Total Weight 7,2 kg
	<b>Description</b> Metal Piston		
	<b>SEM NO.</b> <b>72.889.S</b>	<b>REF. NO.</b> 1276846 CONTITECH 889 M FIRESTONE W01-M58-0781 FIRESTONE 1T15LLR-5	<b>Technical Specification</b> Total Weight 3 kg
	<b>Description</b> Service Assembly		

Type / Model	REF. NO.	SEM NO.	
	1450903 1382283 1382283A 1382283R	9408	 <p><b>Description</b> Hand Pump</p>
Type / Model	REF. NO.	SEM NO.	
	1315942	9416	 <p><b>Description</b> Hand Pump</p>
Type / Model	REF. NO.	SEM NO.	
	0372858	11647	 <p><b>Description</b> Cabin Pump</p>
Type / Model	REF. NO.	SEM NO.	
	1450902 1382282	11648	 <p><b>Description</b> Cabin Pump</p>

SEM NO.	REF. NO.	Type / Model
8462	0372863R	372862
	1295754	1295724A
Description Cylinder	683068	372863
	1349831	1295724R
	0683068R	372863A
	1349831A	683068A
	1295723	372863R
	1349831R	683068R
	1295723A	

D=Ø50 Ax=736



SEM NO.	REF. NO.	Type / Model
9432	1295729	
Description Cylinder		



SEM NO.	REF. NO.	Type / Model
9433	1346200	
	1346200A	
Description Cylinder	1308300A	
	1346200R	
	1308300R	









SEM NO.	REF. NO.	Type / Model
11740	1444742	
	1444742R	
	1444742A	
Description Cabin Cylinder		



SEM NO.	REF. NO.	Type / Model
9638		
Description Repair Kit Oil		



<b>Type / Model</b>	<b>REF. NO.</b>	<b>SEM NO.</b>	
	1396202 1298675 1438837	<b>7995</b>	
		<b>Description</b>	
		Cabin Bushing	D=Ø85 d=Ø20 h=23,8
<b>Type / Model</b>	<b>REF. NO.</b>	<b>SEM NO.</b>	
	1290794	<b>7996</b>	
		<b>Description</b>	
		Cabin Bushing	D=Ø60 d=Ø20 h=48
<b>Type / Model</b>	<b>REF. NO.</b>	<b>SEM NO.</b>	
	1290795	<b>7997</b>	
		<b>Description</b>	
		Cabin Mounting	D=Ø85 d=Ø20 h=8
<b>Type / Model</b>	<b>REF. NO.</b>	<b>SEM NO.</b>	
	1314545	<b>8001</b>	
		<b>Description</b>	
		Cabin Bushing	D=Ø90 d=Ø20 h=70
<b>Type / Model</b>	<b>REF. NO.</b>	<b>SEM NO.</b>	
	1425160 1366868	<b>10970</b>	
		<b>Description</b>	
		Cabin Bushing	D=Ø74 d=Ø20 h=62
<b>Type / Model</b>	<b>REF. NO.</b>	<b>SEM NO.</b>	
	1694967	 <b>11968</b>	
		<b>Description</b>	
		Cabin Mounting	

SEM NO.	REF. NO.	Type / Model
11969	1371070	
		
<b>Description</b> Repair Kit for Cabin		

SEM NO.	REF. NO.	Type / Model
11986	1694968	
		
<b>Description</b> Rubber Buffer		

SEM NO.	REF. NO.	Type / Model
11987	1694969	
		
<b>Description</b> Rubber Metal Bushing		

SEM NO.	REF. NO.	Type / Model
8300	1332194 0077390	
		
<b>Description</b> Metal Pin		

D=Ø25 h=136,5

SEM NO.	REF. NO.	Type / Model
8301	1656266 1399160	Xf95 Xf105
		
<b>Description</b> Metal Bush		

D=Ø48 d1=Ø30 d2=Ø25 h=20

SEM NO.	REF. NO.	Type / Model
8302	1271385 1271753	Xf95 Xf105
		
<b>Description</b> Seal		

D=Ø62 d=Ø48 h=5,7



Type / Model	REF. NO.	SEM NO.	
	1328885	11533	
		<b>Description</b>	
		Metal Bush	
			D=Ø35 d=Ø20 h=29

Description / Repair Kit for Cabin	ŞEM NO.	Model:
	<b>7983</b>	
	<b>REF. NO:</b>	<b>Item No</b> <b>Ref. No</b>
	1396202S 1298675S 1438837S 1399160S 1656266S3	1      1396202 2      0750928 3      1304576 4      1269537 5      0079330 6      066117 7      1248753 8      1328885 9      1266426 10      1271385

Description / Repair Kit for Cabin	ŞEM NO.	Model:
	<b>7984</b>	
	<b>REF. NO:</b>	<b>Item No</b> <b>Ref. No</b>
	1396202S1 1438837S1 1298675S1	1      1396202 2      1304576 3      1328885 4      0661173

Description / Repair Kit for Cabin	ŞEM NO.	Model:
	<b>7985</b>	
	<b>REF. NO:</b>	<b>Item No</b> <b>Ref. No</b>
	1266426S 1656266S4 1399160S1	1      0750928 2      1266426 3      0079330 4      1269537 5      1248753 6      1271385

Description / Repair Kit for Cabin	ŞEM NO.	Model:
	<b>7986</b>	
	<b>REF. NO:</b>	<b>Item No</b> <b>Ref. No</b>
	1290794S	1      1290794 2      0077390 3      1304576 4      1266426 5      1290795 6      0079330 7      1271385 8      0661173 9      0212045 10      1269537 11      0325081

Model:	ŞEM NO.	Description / Repair Kit for Cabin
	<b>7987</b>	
<b>Item No</b>	<b>Ref. No</b>	<b>REF. NO:</b>
1	1290794	1290794S1
2	1304576	
3	1290795	
4	0212045	
5	0661173	



Model:	ŞEM NO.	Description / Repair Kit for Cabin
	<b>7988</b>	
<b>Item No</b>	<b>Ref. No</b>	<b>REF. NO:</b>
1	0077390	0077390S
2	1266426	1332194S1
3	1271385	
4	0079330	
5	1269537	
6	0325081	



Model:	ŞEM NO.	Description / Repair Kit for Cabin
	<b>7989</b>	
<b>Item No</b>	<b>Ref. No</b>	<b>REF. NO:</b>
1	1314545	1314545S
2	1332194	
3	1304569	
4	1266426	
5	1271385	
6	1269537	
7	0241496	
8	0661173	



Model:	ŞEM NO.	Description / Repair Kit for Cabin
	<b>7990</b>	
<b>Item No</b>	<b>Ref. No</b>	<b>REF. NO:</b>
1	1314545	1314545S1
2	1304569	
3	0661173	

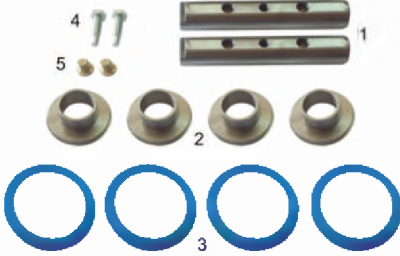

Description / Repair Kit for Cabin	SEM NO.	Model:
	<b>7991</b>	
	<b>REF. NO:</b>	<b>Item No</b>
	1266426S1	1
	1399160S2	2
	1656266S5	3
		4
		<b>Ref. No</b>
		1332194
		1266426
		1271385
		1269537
		0241496

Description / Repair Kit for Cabin	SEM NO.	Model:
	<b>8359</b>	
	<b>REF. NO:</b>	<b>Item No</b>
	1290794S2	1
		2
		3
		4
		5
		6
		7
		<b>Ref. No</b>
		1290794
		1332194
		1304576
		1656266
		1290795
		0661173
		1399159

Description / Repair Kit for Cabin	SEM NO.	Model:
	<b>8360</b>	
	<b>REF. NO:</b>	<b>Item No</b>
	1396202S2	1
	1438837S2	2
	1298675S2	3
		4
		5
		6
		7
		8
		9
		10
		<b>Ref. No</b>
		1396202
		0750928
		1304576
		1269537
		0079330
		0661173
		1248753
		1328885
		1656266
		1399159

Description / Repair Kit for Cabin	SEM NO.	Model:
	<b>8361</b>	
	<b>REF. NO:</b>	<b>Item No</b>
	1656266S	1
		2
		3
		4
		5
		6
		<b>Ref. No</b>
		0750928
		1656266
		1399159
		0079330
		1269537
		1248753

Model:	ŞEM NO.	Description / Repair Kit for Cabin
	8362	
	REF. NO: 1290794S3	
<b>Item No</b>	<b>Ref. No</b>	
1	1290794	
2	0077390	
3	1304576	
4	1656266	
5	1290795	
6	0079330	
7	1399159	
8	0661173	
9	0212045	
10	1269537	
11	0325081	



Model:	ŞEM NO.	Description / Repair Kit for Cabin
	8363	
	REF. NO: 1656266S1	
<b>Item No</b>	<b>Ref. No</b>	
1	0077390	
2	1656266	
3	0079330	
4	1399159	
5	1269537	
6	0325081	



Model:	ŞEM NO.	Description / Repair Kit for Cabin
	8364	
	REF. NO: 1314545S2	
<b>Item No</b>	<b>Ref. No</b>	
1	1314545	
2	1332194	
3	1304569	
4	1656266	
5	1399159	
6	1269537	
7	0241496	
8	0661173	



Model:	ŞEM NO.	Description / Repair Kit for Cabin
	8365	
	REF. NO: 1656266S2	
<b>Item No</b>	<b>Ref. No</b>	
1	1332194	
2	1656266	
3	1399159	
4	1269537	
5	0241496	





<b>Description / Repair Kit for Cabin</b>	<b>ŞEM NO.</b>	<b>Model:</b>
---	----------------	---------------

8366



**REF. NO:**  
1290794S4

Item No	Ref. No
1	1290794
2	1332194
3	1304576
4	1266426
5	1290795
6	0661173
7	1271385

<b>Description / Repair Kit for Cabin</b>	<b>ŞEM NO.</b>	<b>Model:</b>
---	----------------	---------------

11281



**REF. NO:**  
1425160S  
1366868S

Item No	Ref. No
1	1425160
2	0661173
3	1304576

<b>Description / Repair Kit for Cabin</b>	<b>ŞEM NO.</b>	<b>Model:</b>
---	----------------	---------------

11581



**REF. NO:**  
1332194S

Item No	Ref. No
1	1332194
2	1656266
3	1399159
4	0079330
5	1269537
6	0325081

<b>Description / Repair Kit for Cabin</b>	<b>ŞEM NO.</b>	<b>Model:</b>
---	----------------	---------------

11966







**REF. NO:**  
1314545S3

Item No	Ref. No
1	1694967
2	1694968
3	1694969
4	1699375
5	1699702
6	1243049
7	1231069
8	1269537
9	1314545
10	1330134
11	0661173

Model:		SEM NO.	Description / Repair Kit for Cabin
		11967	
		REF. NO: 1694967S	
Item No	Ref. No		
1	1694967		
2	1694968		
3	1694969		
4	1699375		
5	1699702		
6	1269537		





	<b>SEM NO.</b>	<b>REF. NO.</b>	<b>Type / Model</b>
	<b>10818</b>	126281 1371065 1285393 1444147 1321590 1622211 1353450 375224 1353453 MONROE CB0033	95 - 95XF
	<b>Description</b>		
	Cabin Suspension Spring With Shock Absorber		
	<b>SEM NO.</b>	<b>REF. NO.</b>	<b>Type / Model</b>
	<b>10819</b>	1265282 1371066 1285394 299862 1321591 1623477 1353451 1353454 MONROE CB0034	95 - 95XF
	<b>Description</b>		
	Cabin Suspension Spring With Shock Absorber		

Type / Model	REF. NO.	SEM NO.	
	1340450	10922	
		<b>Description</b>	
		Rubber Strip	
			L=215
Type / Model	REF. NO.	SEM NO.	
	0285530	10539	
		<b>Description</b>	
		Rubber Metal Buffer	
			D=Ø40 L=30 M8x20

SEM NO.	REF. NO.	Type / Model
<b>8384</b>	1238280	XF 480 XF 430
		
<b>Description</b> Pressure Spring		
530 MM 400 N		

SEM NO.	REF. NO.	Type / Model
<b>8385</b>	0758296	85-400 Ati
		
<b>Description</b> Pressure Spring		
405 MM 200 N		

SEM NO.	REF. NO.	Type / Model
<b>9718</b>	1451195 1651601	
		
<b>Description</b> Pressure Spring		
475-197-400N.		



SEM NO.	REF. NO.	Type / Model
<b>9719</b>	1400705	
		
<b>Description</b> Pressure Spring		
613-264-215N.		

SEM NO.	REF. NO.	Type / Model
<b>9720</b>	1296632	
		
<b>Description</b> Pressure Spring		
485-204-300N.		

SEM NO.	REF. NO.	Type / Model
<b>9721</b>	1296632	
		
<b>Description</b> Pressure Spring		
671-291-240N.		

Type / Model	REF. NO.	SEM NO.	
	1323677	9722	
		<b>Description</b>	
		Pressure Spring	

330-102

	SEM NO.	new product	REF. NO.	Type / Model
	11954	new product	1392537	Type / Model
<p><b>Description</b> Clutch Lever Complete</p>				
	SEM NO.	new product	REF. NO.	Type / Model
	11955	new product	1438641	Type / Model
<p><b>Description</b> Clutch Lever Complete</p>				
	SEM NO.	new product	REF. NO.	Type / Model
	11956	new product	1392537S 1438641S	Type / Model
<p><b>Description</b> Clutch Lever Repair Kit</p>				

<b>Type / Model</b>	<b>REF. NO.</b>		<b>SEM NO.</b>	
	0159590 0361544		<b>12827</b>	
				<b>Description</b> Brake Slack Adjuster, Automatic-Right
				Ø 14x165x40°
<b>Type / Model</b>	<b>REF. NO.</b>		<b>SEM NO.</b>	
	0159589 0361543		<b>12828</b>	
				<b>Description</b> Brake Slack Adjuster, Automatic-Left
				Ø 14x165x40°
<b>Type / Model</b>	<b>REF. NO.</b>		<b>SEM NO.</b>	
	0159556 0278350		<b>12832</b>	
				<b>Description</b> Brake Slack Adjuster, Automatic
				Ø 14x140x155°
<b>Type / Model</b>	<b>REF. NO.</b>		<b>SEM NO.</b>	
	1325309		<b>12833</b>	
				<b>Description</b> Brake Slack Adjuster, Automatic
				Ø14x250/180/165/150/135/120x5°
<b>Type / Model</b>	<b>REF. NO.</b>		<b>SEM NO.</b>	
	0159557 0278351		<b>12834</b>	
				<b>Description</b> Brake Slack Adjuster, Automatic
				Ø 14x140x155°
<b>Type / Model</b>	<b>REF. NO.</b>		<b>SEM NO.</b>	
	1325313		<b>12845</b>	
				<b>Description</b> Brake Slack Adjuster, Automatic
				Ø 14x205/153/140/127/115x60°



SEM NO.		REF. NO.	Type / Model
12848		0092420	

**Description**

Brake Slack Adjuster, Automatic-Left

Ø 14x165x155°



SEM NO.		REF. NO.	Type / Model
12849		0092419	

**Description**

Brake Slack Adjuster, Automatic-Right

Ø 14x165x155°







SEM NO.		REF. NO.	Type / Model
12863		0878596	



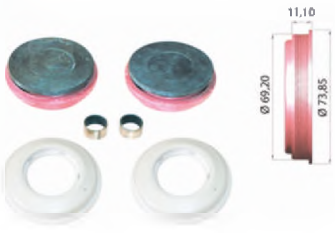

**Description**

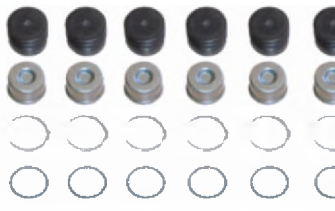



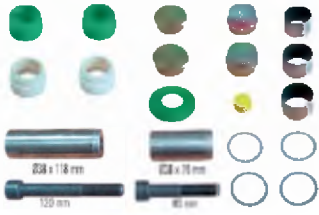
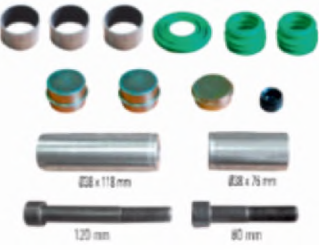

Brake Slack Adjuster, Manuel

Ø 14x120/150/180x0° / 19°



Type / Model	REF. NO.	ŞEM NO.	
KN TYPE NA 7027, NA 7028, NA 7037, NA 7038, NA 75..., SK 7..., SN 65..., SN 66..., SN 7..., SN 71..., SN 72..., SN 73.. Series	1689313 1622785 1616894	<b>10684</b>	 <p><b>Description</b> Caliper Repair Kit</p>
KN TYPE / IVECO TYPE SN 6529, SN 6539, SN 7067, SN 7077, SN 7084, SN 7094, SN 7086, SN 7096, SN 7106, SN 7116, SN 7125, SN 7135, SN 7144, SN 7154, NA 7027, NA 7028, NA 7038, SK 7..., SN 65..., SN 66..., SN 7..., SN 71..., SN 72..., SN 73.. Series	1639100	<b>10690</b>	 <p><b>Description</b> Caliper Repair Kit</p>
KN TYPE All SB... & SN... Series	1439494	<b>10691</b>	 <p><b>Description</b> Caliper Repair Kit</p>
KN TYPE SB 5..., SB 6..., SB 7... Series	1439493	<b>10696</b>	 <p><b>Description</b> Caliper Repair Kit</p>

SEM NO.	REF. NO.	Type / Model
 <p><b>10766</b></p> <p><b>Description</b> Caliper Repair Kit</p>	1505890	WBC TYPE 40 195 001, 40 195 002, 40 195 003, 40 195 004, 40 195 015, 40 195 024, 40 195 017, 40 195 020, 40 195 027, 40 195 030, 40 195 035, 40 195 038, 40 195 043, 40 195 044, 40 225 007, 40 225 008, 40 225 015, 40 225 016
 <p><b>10767</b></p> <p><b>Description</b> Caliper Repair Kit</p>	1628065	WBC TYPE 40 195 017, 40 195 020, 40 195 027, 40 195 030, 40 195 035, 40 195 038, 40 195 043, 40 195 044, 40 225 007, 40 225 008, 40 225 015, 40 225 016
 <p><b>10768</b></p> <p><b>Description</b> Caliper Repair Kit</p>	1436853	WBC TYPE 40 175 025, 026, 027, 028, 049, 050, 051, 056, 057, 058, 059, 060, 061, 062, 063, 064, 065, 069, 070, 071, 072, 073, 078, 079, 080, , 081, 090, 091
 <p><b>10769</b></p> <p><b>Description</b> Caliper Repair Kit</p>	1517407	WBC TYPE 40 175 025, 026, 027, 028, 049, 050, 051, 052
 <p><b>12527</b></p> <p><b>Description</b> Caliper Repair Kit</p>	1517354	WBC TYPE
 <p><b>12564</b></p> <p><b>Description</b> Caliper Repair Kit</p>	1440505	WBC TYPE 40 195 001, 40 195 002, 40 195 003, 40 195 004, 40 195 021, 40 195 022

Type / Model	REF. NO.	SEM NO.	
WBC TYPE 40 225 003, 40 225 004	865966	12577	 <p><b>Description</b> Caliper Repair Kit</p>
WBC TYPE	1505372	12622	 <p><b>Description</b> Caliper Repair Kit 17,5" (Left)</p>
WBC TYPE	1505373	12623	 <p><b>Description</b> Caliper Repair Kit 17,5" (Right)</p>
WBC TYPE	877930	12624	 <p><b>Description</b> Caliper Repair Kit 19,5" (Left)</p>
WBC TYPE	877931	12625	 <p><b>Description</b> Caliper Repair Kit 19,5" (Right)</p>
WBC TYPE	866216	12631	 <p><b>Description</b> Caliper Repair Kit 19,5" (Left)</p>



SEM NO.	REF. NO.	Type / Model
12632	866217	WBC TYPE

**Description**

Caliper Repair Kit 19,5" (Right)

Type / Model	REF. NO.		SEM NO.	
	1602394		12092	
			<b>Description</b>	
			Bushing	

070.087

















## VOLVO GROUP











Engine and Transmission Group .....	:	542 - 568
Steering Group .....	:	569 - 581
Suspension Group .....	:	582 - 636
Cab Group .....	:	637 - 649
Axle / Differential ve Shaft Group.....	:	-
Clutch and Brake Group.....	:	650 - 661



	<b>SEM NO.</b>	<b>REF. NO.</b>	<b>Type / Model</b>
	8340	20503551 1622825	
	<b>Description</b> Engine Mounting		
	<b>SEM NO.</b>	<b>REF. NO.</b>	<b>Type / Model</b>
	8341	20503552 1626870 20503553	
	<b>Description</b> Engine Mounting		
	<b>SEM NO.</b>	<b>REF. NO.</b>	<b>Type / Model</b>
	8342	20503550 1622836	
	<b>Description</b> Engine Mounting		
	<b>SEM NO.</b>	<b>REF. NO.</b>	<b>Type / Model</b>
	8343	1629614	
	<b>Description</b> Engine Mounting		
	<b>SEM NO.</b>	<b>REF. NO.</b>	<b>Type / Model</b>
	8344	1622148	
	<b>Description</b> Engine Mounting		
	<b>SEM NO.</b>	<b>REF. NO.</b>	<b>Type / Model</b>
	8345	70301773	
	<b>Description</b> Engine Mounting		

Type / Model	REF. NO.	SEM NO.	 <p><b>Description</b> Engine Mounting</p>
	20399992 20399980	 <p>11782</p>	
Type / Model	REF. NO.	SEM NO.	 <p><b>Description</b> Engine Mounting</p>
	20399981	 <p>11783</p>	
Type / Model	REF. NO.	SEM NO.	 <p><b>Description</b> Engine Mounting</p>
	20499469	9240	
Type / Model	REF. NO.	SEM NO.	 <p><b>Description</b> Engine Mounting</p>
	20499470	9241	
Type / Model	REF. NO.	SEM NO.	 <p><b>Description</b> Engine Mounting</p>
	20499471	9242	
Type / Model	REF. NO.	SEM NO.	 <p><b>Description</b> Engine Mounting</p>
	20499472	9243	



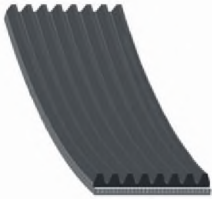
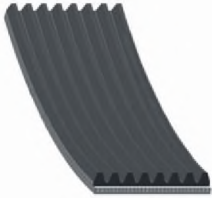
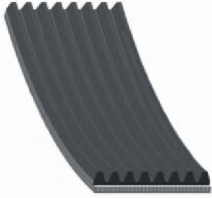
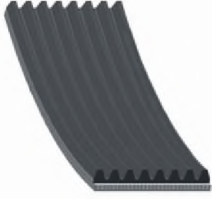
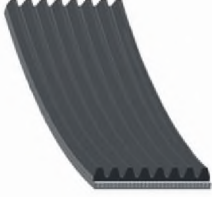



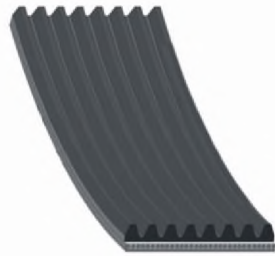
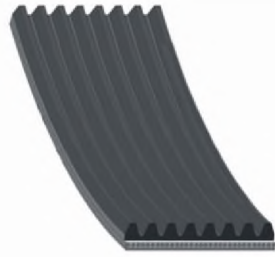
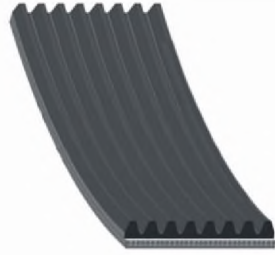
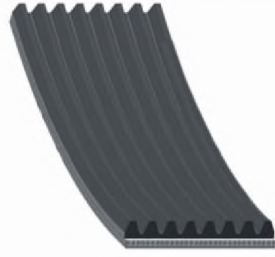
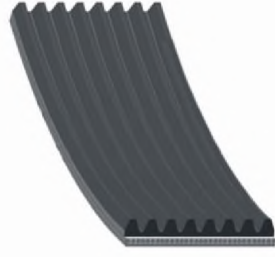

	<table border="1"> <thead> <tr> <th>SEM NO.</th> <th>REF. NO.</th> <th>Type / Model</th> </tr> </thead> <tbody> <tr> <td>9244</td> <td>20499473</td> <td></td> </tr> </tbody> </table>	SEM NO.	REF. NO.	Type / Model	9244	20499473		<p><b>Description</b> Engine Mounting</p>
SEM NO.	REF. NO.	Type / Model						
9244	20499473							
	<table border="1"> <thead> <tr> <th>SEM NO.</th> <th>REF. NO.</th> <th>Type / Model</th> </tr> </thead> <tbody> <tr> <td>9245</td> <td>20499474</td> <td></td> </tr> </tbody> </table>	SEM NO.	REF. NO.	Type / Model	9245	20499474		<p><b>Description</b> Engine Mounting</p>
SEM NO.	REF. NO.	Type / Model						
9245	20499474							
	<table border="1"> <thead> <tr> <th>SEM NO.</th> <th>REF. NO.</th> <th>Type / Model</th> </tr> </thead> <tbody> <tr> <td>9623</td> <td>21228153 20723224</td> <td></td> </tr> </tbody> </table>	SEM NO.	REF. NO.	Type / Model	9623	21228153 20723224		<p><b>Description</b> Engine Mounting</p>
SEM NO.	REF. NO.	Type / Model						
9623	21228153 20723224							
	<table border="1"> <thead> <tr> <th>SEM NO.</th> <th>REF. NO.</th> <th>Type / Model</th> </tr> </thead> <tbody> <tr> <td>9624</td> <td>21228154 20723225</td> <td></td> </tr> </tbody> </table>	SEM NO.	REF. NO.	Type / Model	9624	21228154 20723225		<p><b>Description</b> Engine Mounting</p>
SEM NO.	REF. NO.	Type / Model						
9624	21228154 20723225							
	<table border="1"> <thead> <tr> <th>SEM NO.</th> <th>REF. NO.</th> <th>Type / Model</th> </tr> </thead> <tbody> <tr> <td>8279</td> <td>1614600</td> <td></td> </tr> </tbody> </table>	SEM NO.	REF. NO.	Type / Model	8279	1614600		<p><b>Description</b> Transmission Mounting</p>
SEM NO.	REF. NO.	Type / Model						
8279	1614600							
<p>D=Ø112 d=Ø14 h=55 M10x1,5</p>	<table border="1"> <thead> <tr> <th>SEM NO.</th> <th>REF. NO.</th> <th>Type / Model</th> </tr> </thead> <tbody> <tr> <td>10961</td> <td>20747058</td> <td></td> </tr> </tbody> </table>	SEM NO.	REF. NO.	Type / Model	10961	20747058		<p><b>Description</b> Mounting</p>
SEM NO.	REF. NO.	Type / Model						
10961	20747058							
	<p>D=Ø83 h=38 M=10x1,5</p>							

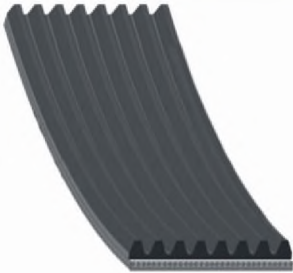
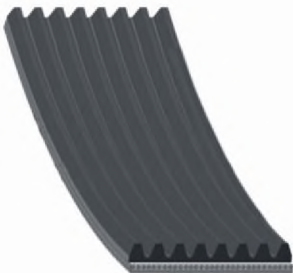
<b>Type / Model</b>	<b>REF. NO.</b>		<b>SEM NO.</b>	
	20923186		<b>12889</b>	
			<b>Description</b>	
			V Ribbed Belt	5PK1525
<b>Type / Model</b>	<b>REF. NO.</b>		<b>SEM NO.</b>	
	978207		<b>10311</b>	
			<b>Description</b>	
			V Ribbed Belt	8PK800
<b>Type / Model</b>	<b>REF. NO.</b>		<b>SEM NO.</b>	
	20430363		<b>11678</b>	
			<b>Description</b>	
			V Ribbed Belt	8PK830
<b>Type / Model</b>	<b>REF. NO.</b>		<b>SEM NO.</b>	
	978238		<b>10313</b>	
			<b>Description</b>	
			V Ribbed Belt	8PK952
<b>Type / Model</b>	<b>REF. NO.</b>		<b>SEM NO.</b>	
	20430367 0978242		<b>10314</b>	
			<b>Description</b>	
			V Ribbed Belt	8PK975
<b>Type / Model</b>	<b>REF. NO.</b>		<b>SEM NO.</b>	
	20430368		<b>10315</b>	
			<b>Description</b>	
			V Ribbed Belt	8PK980

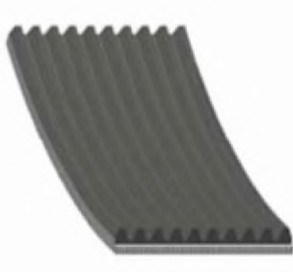
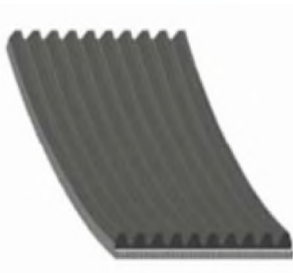
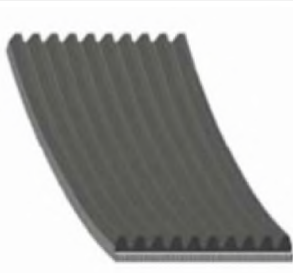
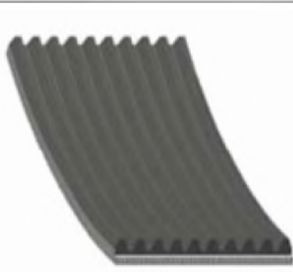

 <p>8PK1005</p>	<p><b>SEM NO.</b></p> <p><b>11679</b></p>	<p><b>REF. NO.</b></p> <p>977822</p>	<p><b>Type / Model</b></p>
	<p><b>Description</b></p> <p>V Ribbed Belt</p>		
 <p>8PK1035</p>	<p><b>SEM NO.</b></p> <p><b>10317</b></p>	<p><b>REF. NO.</b></p> <p>977828</p>	<p><b>Type / Model</b></p>
	<p><b>Description</b></p> <p>V Ribbed Belt</p>		
 <p>8PK1055</p>	<p><b>SEM NO.</b></p> <p><b>10318</b></p>	<p><b>REF. NO.</b></p> <p>0977832</p>	<p><b>Type / Model</b></p>
	<p><b>Description</b></p> <p>V Ribbed Belt</p>		
 <p>8PK1075</p>	<p><b>SEM NO.</b></p> <p><b>11680</b></p>	<p><b>REF. NO.</b></p> <p>977836</p>	<p><b>Type / Model</b></p>
	<p><b>Description</b></p> <p>V Ribbed Belt</p>		
 <p>8PK1075</p>	<p><b>SEM NO.</b></p> <p><b>11681</b></p>	<p><b>REF. NO.</b></p> <p>979047</p>	<p><b>Type / Model</b></p>
	<p><b>Description</b></p> <p>V Ribbed Belt</p>		
 <p>8PK1115</p>	<p><b>SEM NO.</b></p> <p><b>10320 (10323)</b></p>	<p><b>REF. NO.</b></p> <p>8158380</p>	<p><b>Type / Model</b></p>
	<p><b>Description</b></p> <p>V Ribbed Belt</p>		
<p>8PK1220</p>			

<b>Type / Model</b>	<b>REF. NO.</b>	<b>SEM NO.</b>	
	979956	<b>10324</b> (10325)	
		<b>Description</b>	
		V Ribbed Belt	8PK1230
<b>Type / Model</b>	<b>REF. NO.</b>	<b>SEM NO.</b>	
	20412534	<b>10326</b> (10327)	
		<b>Description</b>	
		V Ribbed Belt	8PK1275
<b>Type / Model</b>	<b>REF. NO.</b>	<b>SEM NO.</b>	
	20412535	<b>10328</b>	
		<b>Description</b>	
		V Ribbed Belt	8PK1365
<b>Type / Model</b>	<b>REF. NO.</b>	<b>SEM NO.</b>	
	979067	<b>12894</b>	
		<b>Description</b>	
		V Ribbed Belt	8PK1525
<b>Type / Model</b>	<b>REF. NO.</b>	<b>SEM NO.</b>	
	20430611	<b>10341</b>	
		<b>Description</b>	
		V Ribbed Belt	8PK1538
<b>Type / Model</b>	<b>REF. NO.</b>	<b>SEM NO.</b>	
	20430380	<b>10348</b> (10349)	
		<b>Description</b>	
		V Ribbed Belt	8PK1718



 <p>8PK1852</p>	<table border="1"> <thead> <tr> <th>SEM NO.</th> <th>REF. NO.</th> </tr> </thead> <tbody> <tr> <td>10352 (10355)</td> <td>3195992</td> </tr> </tbody> </table> <p><b>Description</b> V Ribbed Belt</p>	SEM NO.	REF. NO.	10352 (10355)	3195992	<table border="1"> <thead> <tr> <th>Type / Model</th> </tr> </thead> </table>	Type / Model
SEM NO.	REF. NO.						
10352 (10355)	3195992						
Type / Model							
 <p>8PK2020</p>	<table border="1"> <thead> <tr> <th>SEM NO.</th> <th>REF. NO.</th> </tr> </thead> <tbody> <tr> <td>12896 </td> <td>20451459</td> </tr> </tbody> </table> <p><b>Description</b> V Ribbed Belt</p>	SEM NO.	REF. NO.	12896 	20451459	<table border="1"> <thead> <tr> <th>Type / Model</th> </tr> </thead> </table>	Type / Model
SEM NO.	REF. NO.						
12896 	20451459						
Type / Model							
 <p>10PK1070</p>	<table border="1"> <thead> <tr> <th>SEM NO.</th> <th>REF. NO.</th> </tr> </thead> <tbody> <tr> <td>10396</td> <td>20430381 981331</td> </tr> </tbody> </table> <p><b>Description</b> V Ribbed Belt</p>	SEM NO.	REF. NO.	10396	20430381 981331	<table border="1"> <thead> <tr> <th>Type / Model</th> </tr> </thead> </table>	Type / Model
SEM NO.	REF. NO.						
10396	20430381 981331						
Type / Model							
 <p>10PK1108</p>	<table border="1"> <thead> <tr> <th>SEM NO.</th> <th>REF. NO.</th> </tr> </thead> <tbody> <tr> <td>10397 (10398)</td> <td>20430382 981335</td> </tr> </tbody> </table> <p><b>Description</b> V Ribbed Belt</p>	SEM NO.	REF. NO.	10397 (10398)	20430382 981335	<table border="1"> <thead> <tr> <th>Type / Model</th> </tr> </thead> </table>	Type / Model
SEM NO.	REF. NO.						
10397 (10398)	20430382 981335						
Type / Model							
 <p>10PK1108</p>	<table border="1"> <thead> <tr> <th>SEM NO.</th> <th>REF. NO.</th> </tr> </thead> <tbody> <tr> <td>11697</td> <td>20411607</td> </tr> </tbody> </table> <p><b>Description</b> V Ribbed Belt</p>	SEM NO.	REF. NO.	11697	20411607	<table border="1"> <thead> <tr> <th>Type / Model</th> </tr> </thead> </table>	Type / Model
SEM NO.	REF. NO.						
11697	20411607						
Type / Model							
 <p>10PK1135</p>	<table border="1"> <thead> <tr> <th>SEM NO.</th> <th>REF. NO.</th> </tr> </thead> <tbody> <tr> <td>10399 </td> <td>20430384 981338</td> </tr> </tbody> </table> <p><b>Description</b> V Ribbed Belt</p>	SEM NO.	REF. NO.	10399 	20430384 981338	<table border="1"> <thead> <tr> <th>Type / Model</th> </tr> </thead> </table>	Type / Model
SEM NO.	REF. NO.						
10399 	20430384 981338						
Type / Model							
<p>10PK1145</p>							

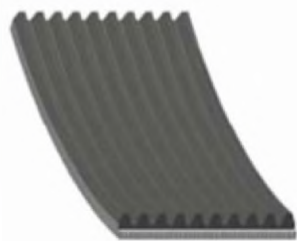
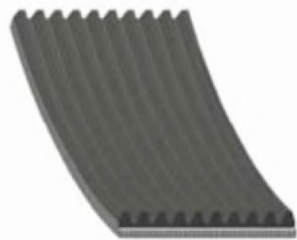
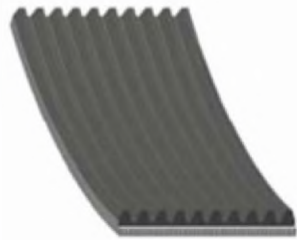
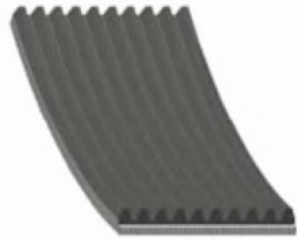
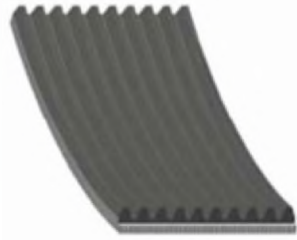

<b>Type / Model</b>	<b>REF. NO.</b>	<b>SEM NO.</b>	
	20440169	11699	
		<b>Description</b>	
		V Ribbed Belt	10PK1350
<b>Type / Model</b>	<b>REF. NO.</b>	<b>SEM NO.</b>	
	20751234	11824	
		<b>Description</b>	
		V Ribbed Belt	10PK1512
<b>Type / Model</b>	<b>REF. NO.</b>	<b>SEM NO.</b>	
	20430387 981390	10401 (10402)	
		<b>Description</b>	
		V Ribbed Belt	10PK1688
<b>Type / Model</b>	<b>REF. NO.</b>	<b>SEM NO.</b>	
	3828041	10403 (10405)	
		<b>Description</b>	
		V Ribbed Belt	10PK1725
<b>Type / Model</b>	<b>REF. NO.</b>	<b>SEM NO.</b>	
	70326598	10406 (10407)	
		<b>Description</b>	
		V Ribbed Belt	10PK1860
<b>Type / Model</b>	<b>REF. NO.</b>	<b>SEM NO.</b>	
	952248 967111	12901	
		<b>Description</b>	
		V Ribbed Belt	



**SEM NO.**

**REF. NO.**







**Type / Model**







059







1674444

**Description**

Rubber Strip

Type / Model	REF. NO.	SEM NO.	
FH 12	3154395	8419	 <p><b>Description</b> Radiator Hose</p> <p>d=Ø20 d=Ø20 h=310</p>
FH 12	3154396 3979894	8420	 <p><b>Description</b> Radiator Hose</p> <p>d=Ø20 d=Ø20 h=340</p>
FH 12	1665951	8421	 <p><b>Description</b> Radiator Hose</p> <p>d=Ø58 d=Ø63 h=480</p>
FH 12	1665940	8422	 <p><b>Description</b> Radiator Hose</p> <p>d=Ø60 d=Ø65 h=520</p>
F 10	475900	8423	 <p><b>Description</b> Radiator Hose</p> <p>d=Ø59 d=Ø62 h=510</p>
F 10	476503	8424	 <p><b>Description</b> Radiator Hose</p> <p>d=Ø20 d=Ø20 h=300</p>

	<b>SEM NO.</b>	<b>REF. NO.</b>	<b>Type / Model</b>
	8425	1664079	F 12 F 16
	<b>Description</b> Radiator Hose		
d=Ø32 d=Ø32 h=400			
	<b>SEM NO.</b>	<b>REF. NO.</b>	<b>Type / Model</b>
	8426	475861	F 10
	<b>Description</b> Radiator Hose		
d=Ø60 d=Ø60 h=480			
	<b>SEM NO.</b>	<b>REF. NO.</b>	<b>Type / Model</b>
	8512	20367063 21288160	FH FH 12
	<b>Description</b> Radiator Hose		
12x12x80			
	<b>SEM NO.</b>	<b>REF. NO.</b>	<b>Type / Model</b>
	8570	20456429 21288162	FH FH 12 FM
	<b>Description</b> Radiator Hose		
13x13x150			
	<b>SEM NO.</b>	<b>REF. NO.</b>	<b>Type / Model</b>
	8571	20544321	FH FH 12
	<b>Description</b> Oil Reservoir And Pump Hose		
21x21x340			
	<b>SEM NO.</b>	<b>REF. NO.</b>	<b>Type / Model</b>
	8572	20453672	FH FH 12
	<b>Description</b> Radiator Hose		
20x20x890			

Type / Model	REF. NO.	SEM NO.	
FH FH16	20968736 3979617	8711	 <p><b>Description</b> Radiator Hose</p> <p>58x61x310x440</p>
Fh12 FM12	20542199	8712	 <p><b>Description</b> Radiator Hose</p> <p>58x63x400x520</p>
F12 F16	1664045	8713	 <p><b>Description</b> Radiator Hose</p> <p>30x38x125x205</p>
FH FM FH12	20542202 3979986	8714	 <p><b>Description</b> Radiator Hose</p> <p>58x61x310x500</p>
FH 12	20542204	8715	 <p><b>Description</b> Radiator Hose</p> <p>20x20x220x290</p>
FL 12	1544845	8716	 <p><b>Description</b> Radiator Hose</p> <p>55x59x310x320</p>

	SEM NO.	REF. NO.	Type / Model
	8727	20968744 3154217	FH 16
	<b>Description</b> Radiator Upper Hose		
58x61x310x440			







	SEM NO.	REF. NO.	Type / Model
	8745	20829525	PREMIUM Dxi
	<b>Description</b> Radiator Hose		
49x59x450			

	SEM NO.	REF. NO.	Type / Model
	8746	3979688	FM 10
	<b>Description</b> Radiator Hose		
50x62x340			







	SEM NO.	REF. NO.	Type / Model
	8752	3183616	FM 10
	<b>Description</b> Radiator Hose		
50x61x625			







	SEM NO.	REF. NO.	Type / Model
	8753	1674928	FH 16
	<b>Description</b> Heating Hose		
27x31x400			

	SEM NO.	REF. NO.	Type / Model
	9574	20542213	FM 10 FM 12
	<b>Description</b> Radiator Hose		
26x31x455			

Type / Model	REF. NO.	SEM NO.	
FH 16	8149035	10574	 <p><b>Description</b> Radiator Hose</p> <p>58x61x375</p>
FH 16	1665571	10575	 <p><b>Description</b> Radiator Hose</p> <p>62x60x420</p>
F 10 F 12 FH 12	943367	10576	 <p><b>Description</b> Radiator Hose</p> <p>10x10x105</p>
FH 16	1665492	10577	 <p><b>Description</b> Radiator Hose</p> <p>60x62x457</p>
FH 12 NH 12	20776059	10578	 <p><b>Description</b> Radiator Hose</p> <p>27x31x320</p>
	20968686 20368993	10883	 <p><b>Description</b> Radiator Hose</p>



	<b>SEM NO.</b>	<b>REF. NO.</b>	<b>Type / Model</b>
	10928	20909063	
	<b>Description</b>		
	Radiator Hose		
	<b>SEM NO.</b>	<b>REF. NO.</b>	<b>Type / Model</b>
	11079	1664112	F10 ,F12
	<b>Description</b>		
	Radiator Hose		
24x20x310			
	<b>SEM NO.</b>	<b>REF. NO.</b>	<b>Type / Model</b>
	11080	1664753	F10 F12
	<b>Description</b>		
	Radiator Hose		
32x32x320			
	<b>SEM NO.</b>	<b>REF. NO.</b>	<b>Type / Model</b>
	11081	20582185 20447435	Fh12 FM12
	<b>Description</b>		
	Radiator Hose		
63x63x520			
	<b>SEM NO.</b>	<b>REF. NO.</b>	<b>Type / Model</b>
	11082	1544701	FH FM
	<b>Description</b>		
	Radiator Hose		
57x58x510			
	<b>SEM NO.</b>	<b>REF. NO.</b>	<b>Type / Model</b>
	11083	1676378	FH 12
	<b>Description</b>		
	Radiator Hose		
27x31x488			

Type / Model	REF. NO.	SEM NO.	
FM	20940665	11084	 <b>Description</b> Radiator Hose 58x61x510
FH	20968683	11085	 <b>Description</b> Heating Hose 21x21x235
FH FM	20592715	11086	 <b>Description</b> Gearbox Oil Cooler 15x15x135
FH FM	20968388 20504142	11087	 <b>Description</b> Heating Hose 21x21x170
FH FM	21258220	11088	 <b>Description</b> Radiator Hose 60x62x420
FH FM	20740344	11089	 <b>Description</b> Radiator Lower Hose 62x58x525

SEM NO.	REF. NO.	Type / Model
11090	1674308	Fh12
<b>Description</b>		
Expansion Tank Hose		
21x21x520		



SEM NO.	REF. NO.	Type / Model
11762	20589303	
<b>Description</b>		
Gearbox Oil Cooler		



SEM NO.	REF. NO.	Type / Model
11877	20709404	
<b>Description</b>		
Gearbox Oil Cooler		
15x15x162		



SEM NO.	REF. NO.	Type / Model
11878	1660218	
<b>Description</b>		
Radiator Hose		
25x31x185		





















SEM NO.	REF. NO.	Type / Model
11879	475438	
<b>Description</b>		
Coolant Hose		
50x50x405		















SEM NO.	REF. NO.	Type / Model
11880	20557007	
<b>Description</b>		
Radiator Hose		
59x62x490		









<b>Type / Model</b>	<b>REF. NO.</b>		<b>SEM NO.</b>	
	20592158		11881	
			<b>Description</b>	
			Gearbox Oil Cooler	
				59x59x112
<b>Type / Model</b>	<b>REF. NO.</b>		<b>SEM NO.</b>	
	20453670		11882	
			<b>Description</b>	
			Heating Hose	
				21x21x558
<b>Type / Model</b>	<b>REF. NO.</b>		<b>SEM NO.</b>	
	3197764		11883	
			<b>Description</b>	
			Oil Coolant Hose	
				17x21x220
<b>Type / Model</b>	<b>REF. NO.</b>		<b>SEM NO.</b>	
	1660268		11884	
			<b>Description</b>	
			Heating Hose	
				19x19x230
<b>Type / Model</b>	<b>REF. NO.</b>		<b>SEM NO.</b>	
	20968720		11885	
			<b>Description</b>	
			Expansion Hose	
				27x31x275
<b>Type / Model</b>	<b>REF. NO.</b>		<b>SEM NO.</b>	
	20390460		11886	
			<b>Description</b>	
			Gearbox Hose	
				50x60x278





	SEM NO.		REF. NO.	Type / Model
 14x14x1010 <b>Description</b> Gearbox Oil Cooler	11887		21339891	
 40x40x350 <b>Description</b> Radiator Hose	11888		475186	
 25x25x530 <b>Description</b> Radiator Hose	11889		1544831	











Type / Model	REF. NO.	ŞEM NO.	
BLUE	8149800 1665556	8858	 <p><b>Description</b> Silicon Hose</p> <p>D:Ø80 mm L:390 mm 12 HUMP</p>
GREEN	9519701	8859	 <p><b>Description</b> Silicon Hose</p> <p>D:Ø58 mm L:360 mm</p>
GREEN	1195576	8860	 <p><b>Description</b> Silicon Hose</p> <p>D:Ø60 mm L:250 mm</p>
GREEN	3028329	8861	 <p><b>Description</b> Silicon Hose</p> <p>D:Ø48 mm D:Ø58 mm L:240 mm</p>
GREEN	1196391 8365091	8862	 <p><b>Description</b> Silicon Hose</p> <p>D:Ø50 mm D:Ø60 mm L:160 mm</p>
GREEN	470464	8863	 <p><b>Description</b> Silicon Hose</p> <p>D:Ø57 mm L:65 mm</p>

	SEM NO.	REF. NO.	Type / Model
 D:Ø60 mm L:160 mm	8864	1195081	GREEN
<b>Description</b> Silicon Hose			
 D:Ø76 mm L:60 mm	8865	470327	BLUE
<b>Description</b> Silicon Hose			
 D:Ø19 mm L:60 mm	8866	466328	BLUE
<b>Description</b> Silicon Hose			
 d=Ø60 L=210	10050	3031068	GREEN
<b>Description</b> Silicon Hose			
 d=Ø50 L=240	10051	9516935	GREEN
<b>Description</b> Silicon Hose			
 d=Ø36 d=Ø51 L=133	10052	3018107	GREEN
<b>Description</b> Silicon Hose			



<b>Type / Model</b>	<b>REF. NO.</b>	<b>ŞEM NO.</b>	
BLACK	11110594	<b>10663</b>	 <p><b>Description</b> Silicon Hose</p> <p>d=Ø80 L=156 3 hump</p>
<b>Type / Model</b>	<b>REF. NO.</b>	<b>ŞEM NO.</b>	
BLACK	11110730	<b>10664</b>	 <p><b>Description</b> Silicon Hose</p> <p>d=Ø80 L=103 3 Hump</p>
<b>Type / Model</b>	<b>REF. NO.</b>	<b>ŞEM NO.</b>	
BLACK	20463924 1676481 20561450 1676491	<b>10666</b>	 <p><b>Description</b> Silicon Hose</p> <p>d=Ø83 L=150 3 Hump</p>
<b>Type / Model</b>	<b>REF. NO.</b>	<b>ŞEM NO.</b>	
BLACK	21312236 20589122	<b>11205</b>	 <p><b>Description</b> Silicon Hose</p> <p>Ø100X148 3 hump</p>
<b>Type / Model</b>	<b>REF. NO.</b>	<b>ŞEM NO.</b>	
BLACK	21312237 20589123	<b>11206</b>	 <p><b>Description</b> Silicon Hose</p> <p>Ø80X390 9 hump</p>
<b>Type / Model</b>	<b>REF. NO.</b>	<b>ŞEM NO.</b>	
GREEN	3031477	<b>11207</b>	 <p><b>Description</b> Silicon Hose</p> <p>Ø60X95X200</p>

	<table border="1"> <thead> <tr> <th>SEM NO.</th> <th>REF. NO.</th> <th>Type / Model</th> </tr> </thead> <tbody> <tr> <td>11208</td> <td>3030439</td> <td>GREEN</td> </tr> </tbody> </table>	SEM NO.	REF. NO.	Type / Model	11208	3030439	GREEN	<p><b>Description</b> Silicon Hose</p>
SEM NO.	REF. NO.	Type / Model						
11208	3030439	GREEN						
Ø33x80x80								
	<table border="1"> <thead> <tr> <th>SEM NO.</th> <th>REF. NO.</th> <th>Type / Model</th> </tr> </thead> <tbody> <tr> <td>11209</td> <td>440691</td> <td>GREEN</td> </tr> </tbody> </table>	SEM NO.	REF. NO.	Type / Model	11209	440691	GREEN	<p><b>Description</b> Silicon Hose</p>
SEM NO.	REF. NO.	Type / Model						
11209	440691	GREEN						
Ø56X175X175								
	<table border="1"> <thead> <tr> <th>SEM NO.</th> <th>REF. NO.</th> <th>Type / Model</th> </tr> </thead> <tbody> <tr> <td>11210</td> <td>3028381</td> <td>GREEN</td> </tr> </tbody> </table>	SEM NO.	REF. NO.	Type / Model	11210	3028381	GREEN	<p><b>Description</b> Silicon Hose</p>
SEM NO.	REF. NO.	Type / Model						
11210	3028381	GREEN						
Ø58X90X160X90								
	<table border="1"> <thead> <tr> <th>SEM NO.</th> <th>REF. NO.</th> <th>Type / Model</th> </tr> </thead> <tbody> <tr> <td>11211</td> <td>9523693</td> <td>GREEN</td> </tr> </tbody> </table>	SEM NO.	REF. NO.	Type / Model	11211	9523693	GREEN	<p><b>Description</b> Silicon Hose</p>
SEM NO.	REF. NO.	Type / Model						
11211	9523693	GREEN						
Ø18X100								
	<table border="1"> <thead> <tr> <th>SEM NO.</th> <th>REF. NO.</th> <th>Type / Model</th> </tr> </thead> <tbody> <tr> <td>11234</td> <td>1676744 1675097 1675579 20441625 476828</td> <td>BLUE</td> </tr> </tbody> </table>	SEM NO.	REF. NO.	Type / Model	11234	1676744 1675097 1675579 20441625 476828	BLUE	<p><b>Description</b> Silicon Hose</p>
SEM NO.	REF. NO.	Type / Model						
11234	1676744 1675097 1675579 20441625 476828	BLUE						
Ø67X260 5 hump								
	<table border="1"> <thead> <tr> <th>SEM NO.</th> <th>REF. NO.</th> <th>Type / Model</th> </tr> </thead> <tbody> <tr> <td>11825</td> <td>1675098 1660264</td> <td></td> </tr> </tbody> </table>	SEM NO.	REF. NO.	Type / Model	11825	1675098 1660264		<p><b>Description</b> Silicon Hose</p>
SEM NO.	REF. NO.	Type / Model						
11825	1675098 1660264							
Ø76x305								

<b>Type / Model</b>	<b>REF. NO.</b>		<b>SEM NO.</b>	
	1676218		<b>11826</b>	
			<b>Description</b>	
			Silicon Hose	
				Ø76 150x145x150
<b>Type / Model</b>	<b>REF. NO.</b>		<b>SEM NO.</b>	
	1676216 1660277		<b>11827</b>	
			<b>Description</b>	
			Silicon Hose	
				Ø76 150x165x125
<b>Type / Model</b>	<b>REF. NO.</b>		<b>SEM NO.</b>	
	9515673		<b>11828</b>	
			<b>Description</b>	
			Silicon Hose	
				Ø50x60x170
<b>Type / Model</b>	<b>REF. NO.</b>		<b>SEM NO.</b>	
	8154602		<b>11829</b>	
			<b>Description</b>	
			Silicon Hose	
				Ø19x40 380x90
<b>Type / Model</b>	<b>REF. NO.</b>		<b>SEM NO.</b>	
	8155665		<b>11830</b>	
			<b>Description</b>	
			Silicon Hose	
				Ø19x40 375x95



**SEM NO.**

**REF. NO.**

**Type / Model**



8277











6850149  
324842







**Description**

Rubber Buffer





D=Ø50 h=42 M12x1,5





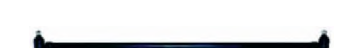

Type / Model	REF. NO.	SEM NO.	
	342275	7696	
			<b>Description</b> Rubber Metal Mounting
Type / Model	REF. NO.	SEM NO.	
	463909	8278	
			<b>Description</b> Stabilizer Bush
			D=Ø33 d=Ø8,5 h=28

	<b>SEM NO.</b> 11983		<b>REF. NO.</b> 8171927	<b>Type / Model</b>
	<b>Description</b> Plastic Bushing			
	<b>SEM NO.</b> 11984		<b>REF. NO.</b> 8171931	<b>Type / Model</b>
	<b>Description</b> Plastic Bushing			
	<b>SEM NO.</b> 11985		<b>REF. NO.</b> 8171932	<b>Type / Model</b>
	<b>Description</b> Plastic Bushing			
	<b>SEM NO.</b> 12166		<b>REF. NO.</b> 1063769 20383598 1623569	<b>Type / Model</b>
	<b>Description</b> Gear Shift Dust Cover			
	<b>SEM NO.</b> 12167		<b>REF. NO.</b> 1623568 20383596 3981132 8191213	<b>Type / Model</b>
	<b>Description</b> Gear Shift Dust Cover			

Type / Model	REF. NO.	ŞEM NO.	
	3099230 20830369	8323	 <b>Description</b> Tie Rod L 1605 mm M24x1,5 M30x1,5 K30
	8680-1	1075663 3988704 20393069	 <b>Description</b> Tie Rod L=861 koni=28,6 boru=52
	1588017 1505857 85114142	9340	 <b>Description</b> Tie Rod L=738 koni=31,5 boru=42
	1629668 20477805	9341	 <b>Description</b> Tie Rod L=325 koni=22 boru=30
	1626751 1610338	10110	 <b>Description</b> Tie Rod L 845 mm
	1606283 1576092	10111	 <b>Description</b> Tie Rod L 860 mm



	SEM NO.	REF. NO.	Type / Model
 L 810 mm	<b>10112</b>	1592940 85114145	
	<b>Description</b>		
 L 875 mm	<b>10113</b>	20393075 1629397	
	<b>Description</b>		
 L 435 mm	<b>10114</b>	3987354 3173613	
	<b>Description</b>		
 L 1640 mm	<b>10115</b>	3986450 3988711 3962343 1628637	
	<b>Description</b>		
 L 870 mm	<b>10116</b>	20393186 20375555 3986452 21106930	
	<b>Description</b>		
 L 1634 mm	<b>10117</b>	3198276 21260274	
	<b>Description</b>		

Type / Model	REF. NO.	SEM NO.	
	20443063 20994420 20443067 20539988	10118	 <b>Description</b> Stabilizer Rot L 350 mm    K=28.6 mm
Type / Model	REF. NO.	SEM NO.	
	20477807 3944046	10119	 <b>Description</b> Stabilizer Rot L 340 mm
Type / Model	REF. NO.	SEM NO.	
	20443061 20443065 20994418	10120	 <b>Description</b> Stabilizer Rot L 435 mm
Type / Model	REF. NO.	SEM NO.	
	9521922	10992	 <b>Description</b> Tie Rod
Type / Model	REF. NO.	SEM NO.	
	20367555	11114	 <b>Description</b> Tie Rod Length: 160,0 mm
Type / Model	REF. NO.	SEM NO.	
	3986433 21446333	11115	 <b>Description</b> Tie Rod Length: 325 mm

	SEM NO.	REF. NO.	Type / Model
 Length: 380 mm	<b>11117</b>	3987355 3173914	
	<b>Description</b>		
			Tie Rod







	SEM NO.	REF. NO.	Type / Model
 Length: 380 mm K=28,6 mm	<b>11118</b>	20443062 20443066 20994419 21248088	
	<b>Description</b>		
			Tie Rod













	SEM NO.	REF. NO.	Type / Model
 Length: 275 mm	<b>11119</b>	20477803 3987423	
	<b>Description</b>		
			Tie Rod









	SEM NO.	REF. NO.	Type / Model
 Length: 160 mm	<b>11120</b>	24425411	
	<b>Description</b>		
			Tie Rod

	SEM NO.	REF. NO.	Type / Model
 Length: 367 mm	<b>11121</b>	70314307 70397005 9959462	
	<b>Description</b>		
			Tie Rod

	SEM NO.	REF. NO.	Type / Model
 Length: 367 mm	<b>11122</b>	70314305 70397006 9523163	
	<b>Description</b>		
			Tie Rod

Type / Model	REF. NO.	SEM NO.	
	9959503	11123	 <p><b>Description</b> Tie Rod</p> <p>Length: 150 mm</p>
Type / Model	REF. NO.	SEM NO.	
	20490123 20745923 9519278 21308022	11545	 <p><b>Description</b> Tie Rod</p>
Type / Model	REF. NO.	SEM NO.	
	20393097 3985570 21260286 1612254 4510697 3985571	11546	 <p><b>Description</b> Tie Rod</p>
Type / Model	REF. NO.	SEM NO.	
	20393187 21106952	11547	 <p><b>Description</b> Tie Rod</p>
Type / Model	REF. NO.	SEM NO.	
	21252480 20374831	11779	 <p><b>Description</b> Tie Rod</p>
Type / Model	REF. NO.	SEM NO.	
	1628636 85114200	11788	 <p><b>Description</b> Tie Rod</p>

	SEM NO.		REF. NO.	Type / Model
	11789		1075005	
<b>Description</b>	Tie Rod			
	SEM NO.		REF. NO.	Type / Model
	11790		1075153 20303061 3988695 20393061 3988697	
<b>Description</b>	Tie Rod			
	SEM NO.		REF. NO.	Type / Model
	11797		70376892	
<b>Description</b>	Tie Rod			
	SEM NO.		REF. NO.	Type / Model
	11815		20393071 8190146	
<b>Description</b>	Tie Rod			
	SEM NO.		REF. NO.	Type / Model
	11938		20581086	
<b>Description</b>	Tie Rod			
	SEM NO.		REF. NO.	Type / Model
	11946		20800194	
<b>Description</b>	Tie Rod			

Type / Model	REF. NO.		SEM NO.
	21119064 21287061		<b>11995</b>
			<b>Description</b> Stabilizer Rod
			
Type / Model	REF. NO.		SEM NO.
	21560963		<b>12907</b>
			<b>Description</b> Tie Rod
 L=1686			
Type / Model	REF. NO.		SEM NO.
	25372885 21560957		<b>12909</b>
			<b>Description</b> Tie Rod
 L=1726			
Type / Model	REF. NO.		SEM NO.
	21260275 3198234		<b>12910</b>
			<b>Description</b> Tie Rod
 L=1660			

SEM NO.	REF. NO.	Type / Model
<b>8631</b>	20742127	
	20745043	
	20821160	
	20862494	
<b>Description</b>		
Rod End		
M30Xx1.5 RHT L=120		



SEM NO.	REF. NO.	Type / Model
<b>8632</b>	20742129	
<b>Description</b>		
Rod End		
M30Xx1.5 LHT L=120		



SEM NO.	REF. NO.	Type / Model
<b>8633 (8672)</b>	1517440	F 6
	1517444	F609
	1698191	F611
		F613
		F614
<b>Description</b>		
Rod End		
M28Xx1.5 RHT L=105		



SEM NO.	REF. NO.	Type / Model
<b>8634 (8673)</b>	1517279	F 6
	1517439	F609
	1698190	F611
		F613
		F614
<b>Description</b>		
Rod End		
M28Xx1.5 RHT L=105		



SEM NO.	REF. NO.	Type / Model
<b>8635 (8674)</b>	1695690	FL 6
	1697297	FL 612
	1517577	614
	15175771	615
<b>Description</b>		
Rod End		
M30Xx1.5 RHT L=115		









SEM NO.	REF. NO.	Type / Model
<b>8637 (8678)</b>	1190778	FL 4
	1517449	FI408
	1518142	
<b>Description</b>		
Rod End		
M24x1.5 RHT L=95		





Type / Model	REF. NO.	SEM NO.	
FL 4 FL408	1517448	<b>8638</b> (8679)	 Description Rod End M24x1.5 LHT L=95
FL 4 FL 6 FLC	1696919	<b>8647</b> (8676)	 Description Rod End M24x1.5 RHT L=105
FL 4 FL 6 FLC	1696920	<b>8648</b> (8677)	 Description Rod End M24x1.5 LHT L=105
F 12    FH 12/340    12/380 12/320    12/380    12/420 12/360    12/420    FM 7 12/370    12/460 12/400    FH 16/520 F 16    FL 4 16/470    FL 408 16/485    FM 12/340 16/500	3090727 3988965	<b>8680</b>	 Description Rod End M30x1.5 RHT L=115
FH 12/340 12/380 12/420 12/460 FH 16/520 FM 12/340 12/380 12/420 FM 7	3090728 3988968	<b>8681</b>	 Description Rod End M30x1.5 LHT L=115
	85112073 85125126	<b>10138</b>	 Description Rod End M30x1.5 RHT L=115

	<b>SEM NO.</b>	<b>REF. NO.</b>	<b>Type / Model</b>
	<b>10142</b>	0356310 85114146 1695776 1507826	
	<b>SEM NO.</b>	<b>REF. NO.</b>	<b>Type / Model</b>
	<b>10143</b>	1698558 85114147 6882112 3092795	
	<b>SEM NO.</b>	<b>REF. NO.</b>	<b>Type / Model</b>
	<b>10144</b>	1505759 6889479 1698846 1698532	
	<b>SEM NO.</b>	<b>REF. NO.</b>	<b>Type / Model</b>
	<b>10145</b>	1507822 366757 3092471 1698847	
	<b>SEM NO.</b>	<b>REF. NO.</b>	<b>Type / Model</b>
	<b>10146</b>	3097228 3099529 21263974	
	<b>SEM NO.</b>	<b>REF. NO.</b>	<b>Type / Model</b>
	<b>10931 (10936)</b>	1696685 1190131 382613	







M30x1.5 RHT L=125







M30x1.5 LHT L=125



M30x1.5 RHT L=125







M30x1.5 LHT L=125







M30x1.5 RHT L=140







<b>Type / Model</b>	<b>REF. NO.</b>	<b>SEM NO.</b>	
	1696684 1190132	<b>10937</b> (10942)	
		<b>Description</b>	
		Rod End	
<b>Type / Model</b>	<b>REF. NO.</b>	<b>SEM NO.</b>	
	6027074 6853913 1527453 1672152	<b>10943</b> (10948)	
		<b>Description</b>	
		Rod End	
<b>Type / Model</b>	<b>REF. NO.</b>	<b>SEM NO.</b>	
	1527234 1668638 382745	<b>10950</b>	
		<b>Description</b>	
		Rod End	
<b>Type / Model</b>	<b>REF. NO.</b>	<b>SEM NO.</b>	
	1668179	<b>10951</b>	
		<b>Description</b>	
		Rod End	
<b>Type / Model</b>	<b>REF. NO.</b>	<b>SEM NO.</b>	
	20581089	<b>10996</b>	
		<b>Description</b>	
		Rod End	
<b>Type / Model</b>	<b>REF. NO.</b>	<b>SEM NO.</b>	
	20710008	<b>10997</b>	
		<b>Description</b>	
		Rod End	

	SEM NO.	REF. NO.	Type / Model
	11563	20894438	
	<b>Description</b>		
	Rod End		
	SEM NO.	REF. NO.	Type / Model
	11565	1131741 1699400 6889483 1696900	
	<b>Description</b>	6882151	
	Rod End		
	SEM NO.	REF. NO.	Type / Model
	11566	1131742 1696901 6889484 1699401	
	<b>Description</b>	6882152	
	Rod End		
	SEM NO.	REF. NO.	Type / Model
	11567	3093647	
	<b>Description</b>		
	Rod End		
	SEM NO.	REF. NO.	Type / Model
	11568	8151876	
	<b>Description</b>		
	Rod End		
	SEM NO.	REF. NO.	Type / Model
	11569	20374698	
	<b>Description</b>		
	Rod End		







Type / Model	REF. NO.	SEM NO.	
	1606980	11578	 <p><b>Description</b> Rod End</p>
Type / Model	REF. NO.	SEM NO.	
	20937674	11579	 <p><b>Description</b> Rod End</p>







	<table border="1"> <thead> <tr> <th>SEM NO.</th> <th>REF. NO.</th> <th>Type / Model</th> </tr> </thead> <tbody> <tr> <td>8524</td> <td>1624486</td> <td></td> </tr> </tbody> </table>	SEM NO.	REF. NO.	Type / Model	8524	1624486		
SEM NO.	REF. NO.	Type / Model						
8524	1624486							
D=Ø55 d=Ø26 h=110	<p><b>Description</b> Spring Bushing</p>							
	<table border="1"> <thead> <tr> <th>SEM NO.</th> <th>REF. NO.</th> <th>Type / Model</th> </tr> </thead> <tbody> <tr> <td>10441</td> <td>20839455</td> <td></td> </tr> </tbody> </table>	SEM NO.	REF. NO.	Type / Model	10441	20839455		
SEM NO.	REF. NO.	Type / Model						
10441	20839455							
D=Ø61,5 d=Ø24 h=87	<p><b>Description</b> Rubber Metal Bush</p>							
	<table border="1"> <thead> <tr> <th>SEM NO.</th> <th>REF. NO.</th> <th>Type / Model</th> </tr> </thead> <tbody> <tr> <td>8526</td> <td>20533294</td> <td></td> </tr> </tbody> </table>	SEM NO.	REF. NO.	Type / Model	8526	20533294		
SEM NO.	REF. NO.	Type / Model						
8526	20533294							
D=Ø52 d=Ø20 h=110	<p><b>Description</b> Bush</p>							
	<table border="1"> <thead> <tr> <th>SEM NO.</th> <th>REF. NO.</th> <th>Type / Model</th> </tr> </thead> <tbody> <tr> <td>10238 (10968)</td> <td>20929989</td> <td></td> </tr> </tbody> </table>	SEM NO.	REF. NO.	Type / Model	10238 (10968)	20929989		
SEM NO.	REF. NO.	Type / Model						
10238 (10968)	20929989							
D=Ø60 d=Ø24 h=96	<p><b>Description</b> Spring Bushing</p>							
	<table border="1"> <thead> <tr> <th>SEM NO.</th> <th>REF. NO.</th> <th>Type / Model</th> </tr> </thead> <tbody> <tr> <td>7725 (7812)</td> <td>6879332</td> <td></td> </tr> </tbody> </table>	SEM NO.	REF. NO.	Type / Model	7725 (7812)	6879332		
SEM NO.	REF. NO.	Type / Model						
7725 (7812)	6879332							
D=Ø50 d=Ø16 h=95	<p><b>Description</b> Rubber Buffer</p>							
	<table border="1"> <thead> <tr> <th>SEM NO.</th> <th>REF. NO.</th> <th>Type / Model</th> </tr> </thead> <tbody> <tr> <td>7697</td> <td>3111274 85104649</td> <td></td> </tr> </tbody> </table>	SEM NO.	REF. NO.	Type / Model	7697	3111274 85104649		
SEM NO.	REF. NO.	Type / Model						
7697	3111274 85104649							
<p><b>Description</b> Bush</p>								







<b>Type / Model</b>	<b>REF. NO.</b>	<b>SEM NO.</b>	 D=Ø70 d=Ø16 h=82
	3112049	7956	
		<b>Description</b>	
		Bush	
<b>Type / Model</b>	<b>REF. NO.</b>	<b>SEM NO.</b>	 D=70 d=16 h=82
	70308561	8021	
		<b>Description</b>	
		Bush	
<b>Type / Model</b>	<b>REF. NO.</b>	<b>SEM NO.</b>	 D=Ø51 d=Ø24 h=110
	20959115	10191	
		<b>Description</b>	
		Spring Bushing	
<b>Type / Model</b>	<b>REF. NO.</b>	<b>SEM NO.</b>	 D=Ø50,5 d=Ø24 h=110
	20945984	10192	
		<b>Description</b>	
		Spring Bushing	
<b>Type / Model</b>	<b>REF. NO.</b>	<b>SEM NO.</b>	 h=160 M24x3
	1598764 1576943	9261	
		<b>Description</b>	
		Spring Pin	
<b>Type / Model</b>	<b>REF. NO.</b>	<b>SEM NO.</b>	 M24x3
	1598765	9262	
		<b>Description</b>	
		Spring Pin	





	<b>SEM NO.</b>	<b>REF. NO.</b>	<b>Type / Model</b>
	9263	6781881	
<b>Description</b>			
Spring Pin			
h=171 M36x3			
	<b>SEM NO.</b>	<b>REF. NO.</b>	<b>Type / Model</b>
	9264	1598766 1622510	
<b>Description</b>			
Spring Pin			
h=172 M24x3			
	<b>SEM NO.</b>	<b>REF. NO.</b>	<b>Type / Model</b>
	9265	6777141	
<b>Description</b>			
Spring Pin			
h=150,5 M36x3			
	<b>SEM NO.</b>	<b>REF. NO.</b>	<b>Type / Model</b>
	9266	1609960	
<b>Description</b>			
Spring Pin			
h=210 M36x3			
	<b>SEM NO.</b>	<b>REF. NO.</b>	<b>Type / Model</b>
	9267	339465 1614229	
<b>Description</b>			
Spring Pin			
h=169 M36x3			
	<b>SEM NO.</b>	<b>REF. NO.</b>	<b>Type / Model</b>
	9268	1614230 1589024	
<b>Description</b>			
Spring Pin			
h=169 M36x3			





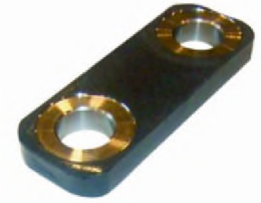

<b>Type / Model</b>	<b>REF. NO.</b>	<b>SEM NO.</b>	 <p><b>Description</b> Spring Pin</p> <p>h=170 D=38 M34x4</p>
	1076334	9269	
<b>Type / Model</b>	<b>REF. NO.</b>	<b>SEM NO.</b>	 <p><b>Description</b> Spring Pin</p> <p>h=152,5 M45X3</p>
	1608018 1598762	9270	
<b>Type / Model</b>	<b>REF. NO.</b>	<b>SEM NO.</b>	 <p><b>Description</b> Spring Pin</p> <p>d=Ø25 h=112 M45X3</p>
	1608019 1598761	9271	
<b>Type / Model</b>	<b>REF. NO.</b>	<b>SEM NO.</b>	 <p><b>Description</b> Spring Pin</p> <p>D=Ø45 h=109,5 M36X3</p>
	310947	9272	
<b>Type / Model</b>	<b>REF. NO.</b>	<b>SEM NO.</b>	 <p><b>Description</b> Spring Pin</p> <p>D=Ø45 h=104,5 M36X3</p>
	1504550	9273	
<b>Type / Model</b>	<b>REF. NO.</b>	<b>SEM NO.</b>	 <p><b>Description</b> Spring Pin</p> <p>D=Ø45 h=105 M34x4</p>
	1075726	9274	

	SEM NO.	REF. NO.	Type / Model
 <p>d=Ø25 h=112 M36X3</p>	9275	1587940	
<b>Description</b>			
Spring Pin			
	SEM NO.	REF. NO.	Type / Model
 <p>D=Ø55 h=104,5 M45X3</p>	9276	1598721	
<b>Description</b>			
Spring Bushing			
	SEM NO.	REF. NO.	Type / Model
 <p>D=Ø38 h=170 M34x4</p>	9277	1075723	
<b>Description</b>			
Spring Pin			
	SEM NO.	REF. NO.	Type / Model
 <p>D=Ø45 h=79,5 M36X3</p>	9278	6776801	
<b>Description</b>			
Spring Bushing			
	SEM NO.	REF. NO.	Type / Model
 <p>D=Ø50 h=99,5 M36X3</p>	9279	6781880	
<b>Description</b>			
Spring Bushing			
	SEM NO.	REF. NO.	Type / Model
 <p>D=Ø20 h=92,5 M36X3</p>	9280	6776802	
<b>Description</b>			
Spring Pin			

<b>Type / Model</b>	<b>REF. NO.</b>	<b>SEM NO.</b>	 <b>Description</b> Spring Pin D=Ø20 h=112 M36X3
	6782621	9281	
<b>Type / Model</b>	<b>REF. NO.</b>	<b>SEM NO.</b>	 <b>Description</b> Spring Pin h=194 M20x2,5 M36x3
	310948	9282	
<b>Type / Model</b>	<b>REF. NO.</b>	<b>SEM NO.</b>	 <b>Description</b> Spring Pin h=140,5 M36x3
	6776803	9283	
<b>Type / Model</b>	<b>REF. NO.</b>	<b>SEM NO.</b>	 <b>Description</b> Spring Pin h=121,5 M27x3
	351190	9284	
<b>Type / Model</b>	<b>REF. NO.</b>	<b>SEM NO.</b>	 <b>Description</b> Spring Bushing D=Ø45 h=83 M36X3
	330135	9285	
<b>Type / Model</b>	<b>REF. NO.</b>	<b>SEM NO.</b>	 <b>Description</b> Spring Pin h=155 M20x2,5
	20883938 20467714	9286	

	<b>SEM NO.</b>	<b>REF. NO.</b>	<b>Type / Model</b>
	9287	20427987	
	<b>Description</b> Spring Pin		
h=200 M34x4			
	<b>SEM NO.</b>	<b>REF. NO.</b>	<b>Type / Model</b>
	10193	20941429	
	<b>Description</b> Spring Bolt		
M24x3 h=155			
	<b>SEM NO.</b>	<b>REF. NO.</b>	<b>Type / Model</b>
	10194	20940495	
	<b>Description</b> Spring Washer		
h=20			
	<b>SEM NO.</b>	<b>REF. NO.</b>	<b>Type / Model</b>
	10195	20940508	
	<b>Description</b> Spring Washer		
h=15			
	<b>SEM NO.</b>	<b>REF. NO.</b>	<b>Type / Model</b>
	10246	963168	
	<b>Description</b> Spring Bolt		
M24x3			
	<b>SEM NO.</b>	<b>REF. NO.</b>	<b>Type / Model</b>
	10247	971069	
	<b>Description</b> Nut		
M24x3			

Type / Model	REF. NO.	SEM NO.	
	947972	10308	 <p><b>Description</b> Nut</p> <p>M22x1,5</p>
Type / Model	REF. NO.	SEM NO.	
	20794342	10966	 <p><b>Description</b> Nut</p> <p>D=Ø34 h=45 M20x2,5</p>

Description / Repair Kit for Spring	SEM NO.	Model:									
	<b>9130</b>										
	REF. NO: 1624486S	<table border="1"> <thead> <tr> <th>Item No</th> <th>Ref. No</th> </tr> </thead> <tbody> <tr> <td>1</td> <td>1624486</td> </tr> <tr> <td>2</td> <td>-</td> </tr> <tr> <td>3</td> <td>-</td> </tr> <tr> <td>4</td> <td>-</td> </tr> </tbody> </table>	Item No	Ref. No	1	1624486	2	-	3	-	4
Item No	Ref. No										
1	1624486										
2	-										
3	-										
4	-										
Description / Spring Repair Kit	SEM NO.	Model:									
	<b>9288</b>										
	REF. NO: 1614230S 1589024S 1504550S	<table border="1"> <thead> <tr> <th>Item No</th> <th>Ref. No</th> </tr> </thead> <tbody> <tr> <td>1</td> <td>9273</td> </tr> <tr> <td>2</td> <td>9268</td> </tr> </tbody> </table>	Item No	Ref. No	1	9273	2	9268			
Item No	Ref. No										
1	9273										
2	9268										
	h=169	M36x3									
Description / Spring Repair Kit	SEM NO.	Model:									
	<b>9289</b>										
	REF. NO: 1609960S 1504550S1	<table border="1"> <thead> <tr> <th>Item No</th> <th>Ref. No</th> </tr> </thead> <tbody> <tr> <td>1</td> <td>9273</td> </tr> <tr> <td>2</td> <td>9266</td> </tr> </tbody> </table>	Item No	Ref. No	1	9273	2	9266			
Item No	Ref. No										
1	9273										
2	9266										
	M36x3										
Description / Spring Repair Kit	SEM NO.	Model:									
	<b>9290</b>										
	REF. NO: 310948S 1504550S2	<table border="1"> <thead> <tr> <th>Item No</th> <th>Ref. No</th> </tr> </thead> <tbody> <tr> <td>1</td> <td>9273</td> </tr> <tr> <td>2</td> <td>9282</td> </tr> </tbody> </table>	Item No	Ref. No	1	9273	2	9282			
Item No	Ref. No										
1	9273										
2	9282										
	h=194	M20x2 M36x3									

Model:	SEM NO.	Description / Spring Repair Kit								
Washer	<b>9291</b>									
<table border="1"> <thead> <tr> <th>Item No</th> <th>Ref. No</th> </tr> </thead> <tbody> <tr> <td>1</td> <td>9276</td> </tr> <tr> <td>2</td> <td>9271</td> </tr> <tr> <td>3</td> <td>9261</td> </tr> </tbody> </table>	Item No	Ref. No	1	9276	2	9271	3	9261	<b>REF. NO:</b> 1598764S 1576943S 1608019S 1598721S 1598761S  M45x3	
Item No	Ref. No									
1	9276									
2	9271									
3	9261									
Model:	SEM NO.	Description / Spring Repair Kit								
	<b>9292</b>									
<table border="1"> <thead> <tr> <th>Item No</th> <th>Ref. No</th> </tr> </thead> <tbody> <tr> <td>1</td> <td>9276</td> </tr> <tr> <td>2</td> <td>9271</td> </tr> <tr> <td>3</td> <td>9264</td> </tr> </tbody> </table>	Item No	Ref. No	1	9276	2	9271	3	9264	<b>REF. NO:</b> 1598766S 1622510S 1598721S1  M45x3	
Item No	Ref. No									
1	9276									
2	9271									
3	9264									
Model:	SEM NO.	Description / Spring Repair Kit								
	<b>9293</b>									
<table border="1"> <thead> <tr> <th>Item No</th> <th>Ref. No</th> </tr> </thead> <tbody> <tr> <td>1</td> <td>9276</td> </tr> <tr> <td>2</td> <td>9270</td> </tr> <tr> <td>3</td> <td>9262</td> </tr> </tbody> </table>	Item No	Ref. No	1	9276	2	9270	3	9262	<b>REF. NO:</b> 1598765S 1598721S2 1608018S 1598762S  M45x3	
Item No	Ref. No									
1	9276									
2	9270									
3	9262									
Model:	SEM NO.	Description / Spring Repair Kit								
	<b>9294</b>									
<table border="1"> <thead> <tr> <th>Item No</th> <th>Ref. No</th> </tr> </thead> <tbody> <tr> <td>1</td> <td>9273</td> </tr> <tr> <td>2</td> <td>9267</td> </tr> <tr> <td>3</td> <td></td> </tr> </tbody> </table>	Item No	Ref. No	1	9273	2	9267	3		<b>REF. NO:</b> 1614229S 339465S 1504550S3  M36x3	
Item No	Ref. No									
1	9273									
2	9267									
3										

Description / Spring Repair Kit	SEM NO.	Model:									
	<b>9295</b>										
	REF. NO: 6795968S 6782621S	<table border="1"> <thead> <tr> <th>Item No</th> <th>Ref. No</th> </tr> </thead> <tbody> <tr> <td>1</td> <td>8279</td> </tr> <tr> <td>2</td> <td>9281</td> </tr> <tr> <td>3</td> <td>-</td> </tr> <tr> <td>4</td> <td>-</td> </tr> </tbody> </table>	Item No	Ref. No	1	8279	2	9281	3	-	4
Item No	Ref. No										
1	8279										
2	9281										
3	-										
4	-										

h=155 M20X2,5

Description / Spring Repair Kit	SEM NO.	Model:									
	<b>9296</b>										
	REF. NO: 6776801S	<table border="1"> <thead> <tr> <th>Item No</th> <th>Ref. No</th> </tr> </thead> <tbody> <tr> <td>1</td> <td>9278</td> </tr> <tr> <td>2</td> <td>9280</td> </tr> <tr> <td>3</td> <td>9297</td> </tr> <tr> <td>4</td> <td>-</td> </tr> </tbody> </table>	Item No	Ref. No	1	9278	2	9280	3	9297	4
Item No	Ref. No										
1	9278										
2	9280										
3	9297										
4	-										

h=127 M20X2,5





Description / Spring Repair Kit	SEM NO.	Model:
	<b>9297</b>	
	REF. NO: 6795968S1	

h=155 M20x2,5

Description / Spring Repair Kit	SEM NO.	Model:
	<b>9298</b>	
	REF. NO: 6776804S	

h=127 M20X2,5







Model:	SEM NO.	Description / Spring Repair Kit						
	<b>9299</b>							
	<b>REF. NO:</b> 1598764S1 1576943S1							
	h=160	M24x3						
Model:	SEM NO.	Description / Spring Repair Kit						
	<b>9300</b>							
	<b>REF. NO:</b> 1598765S1							
	h=220	M24x3						
Model:	SEM NO.	Description / Spring Repair Kit						
	<b>9301</b>							
	<b>REF. NO:</b> 1598766S1 1622510S1 1622502S							
	h=170	M24x3						
Model:	SEM NO.	Description / Spring Repair Kit						
	<b>9302</b>							
<table border="1"> <thead> <tr> <th>Item No</th> <th>Ref. No</th> </tr> </thead> <tbody> <tr> <td>1</td> <td>9283</td> </tr> <tr> <td>2</td> <td>9278</td> </tr> </tbody> </table>	Item No	Ref. No	1	9283	2	9278	<b>REF. NO:</b> 6776803S	
Item No	Ref. No							
1	9283							
2	9278							
		M36x3						

Description / Spring Repair Kit	SEM NO.	Model:					
	<b>9303</b>						
	<b>REF. NO:</b> 1614229S1 339465S1	<table border="1"> <thead> <tr> <th>Item No</th> <th>Ref. No</th> </tr> </thead> <tbody> <tr> <td>1</td> <td>9267</td> </tr> <tr> <td>2</td> <td>9272</td> </tr> </tbody> </table>	Item No	Ref. No	1	9267	2
Item No	Ref. No						
1	9267						
2	9272						
	M36x3						







Description / Spring Repair Kit	SEM NO.	Model:					
	<b>9304</b>						
	<b>REF. NO:</b> 1075723S	<table border="1"> <thead> <tr> <th>Item No</th> <th>Ref. No</th> </tr> </thead> <tbody> <tr> <td>1</td> <td>9277</td> </tr> <tr> <td>2</td> <td>9274</td> </tr> </tbody> </table>	Item No	Ref. No	1	9277	2
Item No	Ref. No						
1	9277						
2	9274						

Description / Spring Repair Kit	SEM NO.	Model:					
	<b>9305</b>						
	<b>REF. NO:</b> 1076334S	<table border="1"> <thead> <tr> <th>Item No</th> <th>Ref. No</th> </tr> </thead> <tbody> <tr> <td>1</td> <td>9269</td> </tr> <tr> <td>2</td> <td>9274</td> </tr> </tbody> </table>	Item No	Ref. No	1	9269	2
Item No	Ref. No						
1	9269						
2	9274						

Description / Spring Repair Kit	SEM NO.	Model:							
	<b>9306</b>								
	<b>REF. NO:</b> 1598764S2 1576943S2	<table border="1"> <thead> <tr> <th>Item No</th> <th>Ref. No</th> </tr> </thead> <tbody> <tr> <td>1</td> <td>9275</td> </tr> <tr> <td>2</td> <td>9273</td> </tr> <tr> <td>3</td> <td>9261</td> </tr> </tbody> </table>	Item No	Ref. No	1	9275	2	9273	3
Item No	Ref. No								
1	9275								
2	9273								
3	9261								
	M36x3								

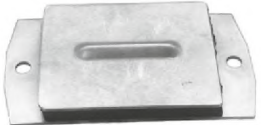
Model:		SEM NO.	Description / Spring Repair Kit
		<b>9307</b>	
<b>Item No</b>	<b>Ref. No</b>	<b>REF. NO:</b>	
1	9263	6781881S	
2	9279		
		M36x3	
Model:		SEM NO.	Description / Spring Repair Kit
		<b>9308</b>	
<b>Item No</b>	<b>Ref. No</b>	<b>REF. NO:</b>	
1	9265	677141S	
2	9278		
		M36x3	
Model:		SEM NO.	Description / Spring Repair Kit
		<b>9309</b>	
<b>Item No</b>	<b>Ref. No</b>	<b>REF. NO:</b>	
1	9280	6795968S2	
2	9285		
		h=147 M20x2,5	
Model:		SEM NO.	Description / Spring Repair Kit
		<b>9310</b>	
<b>Item No</b>	<b>Ref. No</b>	<b>REF. NO:</b>	
1	9272	310948S1	
2	9282		
		M36x3	

Description / Repair Kit for Axle	SEM NO.	Model:														
	<p><b>10196</b></p> <p>REF. NO: 20950080 21395854</p>	<table border="1"> <thead> <tr> <th data-bbox="1139 413 1301 443">Item No</th> <th data-bbox="1301 413 1498 443">Ref. No</th> </tr> </thead> <tbody> <tr> <td data-bbox="1139 443 1301 474">1</td> <td data-bbox="1301 443 1498 474">20959115</td> </tr> <tr> <td data-bbox="1139 474 1301 504">2</td> <td data-bbox="1301 474 1498 504">20945984</td> </tr> <tr> <td data-bbox="1139 504 1301 534">3</td> <td data-bbox="1301 504 1498 534">20941429</td> </tr> <tr> <td data-bbox="1139 534 1301 564">4</td> <td data-bbox="1301 534 1498 564">20940495</td> </tr> <tr> <td data-bbox="1139 564 1301 594">5</td> <td data-bbox="1301 564 1498 594">20940508</td> </tr> <tr> <td data-bbox="1139 594 1301 625">6</td> <td data-bbox="1301 594 1498 625">914170</td> </tr> </tbody> </table>	Item No	Ref. No	1	20959115	2	20945984	3	20941429	4	20940495	5	20940508	6	914170
Item No	Ref. No															
1	20959115															
2	20945984															
3	20941429															
4	20940495															
5	20940508															
6	914170															

<b>Type / Model</b>	<b>REF. NO.</b>	<b>SEM NO.</b>	
	1628449	8141	
			<b>Description</b> Spring Mounting
			D=Ø96 d=Ø19 h=96 M14x2
<b>Type / Model</b>	<b>REF. NO.</b>	<b>SEM NO.</b>	
	1506399	8592	
			<b>Description</b> Spring Mounting
			D=Ø98 h=121
<b>Type / Model</b>	<b>REF. NO.</b>	<b>SEM NO.</b>	
	1626139	8283	
			<b>Description</b> Spring Bushing
<b>Type / Model</b>	<b>REF. NO.</b>	<b>SEM NO.</b>	
	15802143	8284	
			<b>Description</b> Rubber Buffer
			M12
<b>Type / Model</b>	<b>REF. NO.</b>	<b>SEM NO.</b>	
	351111	11945	
			<b>Description</b> Rubber Metal Buffer
<b>Type / Model</b>	<b>REF. NO.</b>	<b>SEM NO.</b>	
	1629553	8333	
	8151413		
	1622982		
	1609657		
	1577873		
	1089501		
	20390836		<b>Description</b> Spring Mounting
			150x196x150

	SEM NO.	REF. NO.	Type / Model
 D=Ø154 d=Ø81 h=71	8622	20442252	FH 12 FH 16
	<b>Description</b> Stabilizer Bush		

	SEM NO.	REF. NO.	Type / Model
 D=Ø107 d=Ø25 h=74	9057	20466804	
	<b>Description</b> Metal Bushing		







	SEM NO.	REF. NO.	Type / Model
 D=Ø107 d=Ø25 h=74	13040	21363702 21178062	
	<b>Description</b> Metal Bushing		

	SEM NO.	REF. NO.	Type / Model
 M24x2x260	10415	993079	
	<b>Description</b> Screw		





	SEM NO.	REF. NO.	Type / Model
 M24x2	10416	984405	
	<b>Description</b> Nut		







	SEM NO.	REF. NO.	Type / Model
	10291	20429274S	1-8622 2-9057 3-10415 4-10416
	<b>Description</b> Repair Kit		







Type / Model	REF. NO.	SEM NO.	
10415 - 1 Pcs. 10416 - 1 Pcs.	993079S	10433	
			<p><b>Description</b> Repair Kit</p>
1-8622 - 2 Pcs. 2-9057 - 1 Pcs.	20429274S1	13039	
			<p><b>Description</b> Repair Kit</p>
1-8622 - 2 Pcs. 2-13040 - 1 Pcs.	21363702S1 21178062S1	13041	
			<p><b>Description</b> Repair Kit</p>
1-8622 2-13040 3-10415 4-10416	21363702S 21178062S	13042	
			<p><b>Description</b> Repair Kit</p>







	<b>SEM NO.</b>	<b>REF. NO.</b>	<b>Type / Model</b>
	11406	20442787	
M20x102x210	<b>Description</b> Spring Bolt (U)		
	<b>SEM NO.</b>	<b>REF. NO.</b>	<b>Type / Model</b>
	11407	1590942	
M20x102x285	<b>Description</b> Spring Bolt (U)		
	<b>SEM NO.</b>	<b>REF. NO.</b>	<b>Type / Model</b>
	11408	3987324	
M24x102x185	<b>Description</b> Spring Bolt (U)		
	<b>SEM NO.</b>	<b>REF. NO.</b>	<b>Type / Model</b>
	11409	3987325	
M24x102x210	<b>Description</b> Spring Bolt (U)		
	<b>SEM NO.</b>	<b>REF. NO.</b>	<b>Type / Model</b>
	11410	3987326	
M24x102x235	<b>Description</b> Spring Bolt (U)		
	<b>SEM NO.</b>	<b>REF. NO.</b>	<b>Type / Model</b>
	11411	20375242	
M24x102x260	<b>Description</b> Spring Bolt (U)		















Type / Model	REF. NO.	SEM NO.	
	20442764	11412	 <b>Description</b> Spring Bolt (U) M24x92x400
Type / Model	REF. NO.	SEM NO.	
	20442796 1590946	11413 (11414)	 <b>Description</b> Spring Bolt (U) M24x102x410
Type / Model	REF. NO.	SEM NO.	
	20442793	11415	 <b>Description</b> Spring Bolt (U) M24x78x450
Type / Model	REF. NO.	SEM NO.	
	20442768	11416	 <b>Description</b> Spring Bolt (U) M24x92x470
Type / Model	REF. NO.	SEM NO.	
	0947506	11417	 <b>Description</b> Spring Bolt (U) M24x102x520







 <p>D=Ø80 d=Ø45 h=95</p>	<table border="1"> <thead> <tr> <th>SEM NO.</th> <th>REF. NO.</th> <th>Type / Model</th> </tr> </thead> <tbody> <tr> <td>7705</td> <td>70301194 3028447 9518272 1135109</td> <td></td> </tr> <tr> <td><b>Description</b></td> <td></td> <td></td> </tr> <tr> <td>Stabilizer Bush</td> <td></td> <td></td> </tr> </tbody> </table>	SEM NO.	REF. NO.	Type / Model	7705	70301194 3028447 9518272 1135109		<b>Description</b>			Stabilizer Bush		
SEM NO.	REF. NO.	Type / Model											
7705	70301194 3028447 9518272 1135109												
<b>Description</b>													
Stabilizer Bush													
 <p>D=Ø80 d=Ø50 h=95</p>	<table border="1"> <thead> <tr> <th>SEM NO.</th> <th>REF. NO.</th> <th>Type / Model</th> </tr> </thead> <tbody> <tr> <td>7706</td> <td>9959304 9516523 3028448</td> <td></td> </tr> <tr> <td><b>Description</b></td> <td></td> <td></td> </tr> <tr> <td>Stabilizer Bush</td> <td></td> <td></td> </tr> </tbody> </table>	SEM NO.	REF. NO.	Type / Model	7706	9959304 9516523 3028448		<b>Description</b>			Stabilizer Bush		
SEM NO.	REF. NO.	Type / Model											
7706	9959304 9516523 3028448												
<b>Description</b>													
Stabilizer Bush													
 <p>D=Ø80 d=Ø55 h=95</p>	<table border="1"> <thead> <tr> <th>SEM NO.</th> <th>REF. NO.</th> <th>Type / Model</th> </tr> </thead> <tbody> <tr> <td>7707</td> <td>9516524 3028449</td> <td></td> </tr> <tr> <td><b>Description</b></td> <td></td> <td></td> </tr> <tr> <td>Stabilizer Bush</td> <td></td> <td></td> </tr> </tbody> </table>	SEM NO.	REF. NO.	Type / Model	7707	9516524 3028449		<b>Description</b>			Stabilizer Bush		
SEM NO.	REF. NO.	Type / Model											
7707	9516524 3028449												
<b>Description</b>													
Stabilizer Bush													
 <p>D=Ø90 d=Ø59 h=95</p>	<table border="1"> <thead> <tr> <th>SEM NO.</th> <th>REF. NO.</th> <th>Type / Model</th> </tr> </thead> <tbody> <tr> <td>8595</td> <td>9519245</td> <td></td> </tr> <tr> <td><b>Description</b></td> <td></td> <td></td> </tr> <tr> <td>Stabilizer Bush</td> <td></td> <td></td> </tr> </tbody> </table>	SEM NO.	REF. NO.	Type / Model	8595	9519245		<b>Description</b>			Stabilizer Bush		
SEM NO.	REF. NO.	Type / Model											
8595	9519245												
<b>Description</b>													
Stabilizer Bush													
 <p>D=Ø116 d=Ø65 h=95</p>	<table border="1"> <thead> <tr> <th>SEM NO.</th> <th>REF. NO.</th> <th>Type / Model</th> </tr> </thead> <tbody> <tr> <td>8596</td> <td>1079256</td> <td></td> </tr> <tr> <td><b>Description</b></td> <td></td> <td></td> </tr> <tr> <td>Stabilizer Bush</td> <td></td> <td></td> </tr> </tbody> </table>	SEM NO.	REF. NO.	Type / Model	8596	1079256		<b>Description</b>			Stabilizer Bush		
SEM NO.	REF. NO.	Type / Model											
8596	1079256												
<b>Description</b>													
Stabilizer Bush													
 <p>D=Ø116 d=Ø72 h=95</p>	<table border="1"> <thead> <tr> <th>SEM NO.</th> <th>REF. NO.</th> <th>Type / Model</th> </tr> </thead> <tbody> <tr> <td>8597</td> <td>1077594</td> <td></td> </tr> <tr> <td><b>Description</b></td> <td></td> <td></td> </tr> <tr> <td>Stabilizer Bush</td> <td></td> <td></td> </tr> </tbody> </table>	SEM NO.	REF. NO.	Type / Model	8597	1077594		<b>Description</b>			Stabilizer Bush		
SEM NO.	REF. NO.	Type / Model											
8597	1077594												
<b>Description</b>													
Stabilizer Bush													







<b>Type / Model</b>	<b>REF. NO.</b>	<b>SEM NO.</b>	<b>Description</b>	
	20898698	<b>12046</b>	Stabilizer Bush	
				D=Ø116 d=Ø40 h=95
<b>Type / Model</b>	<b>REF. NO.</b>	<b>SEM NO.</b>	<b>Description</b>	
	20428165	<b>8812</b>	Stabilizer Bush	
				D=Ø61 d=Ø30 h=55
<b>Type / Model</b>	<b>REF. NO.</b>	<b>SEM NO.</b>	<b>Description</b>	
	20428166	<b>8813</b>	Stabilizer Bush	
				D=Ø61 d=Ø35,5 h=55
<b>Type / Model</b>	<b>REF. NO.</b>	<b>SEM NO.</b>	<b>Description</b>	
	20428167	<b>8814</b>	Stabilizer Bush	
				D=Ø61 d=Ø41,5 h=55
<b>Type / Model</b>	<b>REF. NO.</b>	<b>SEM NO.</b>	<b>Description</b>	
FL 6 FM 7 FM 9 FM 12 FH 12	20493701	<b>10422</b>	Stabilizer Bush	
				D=Ø100 d=Ø53 Ax=78
<b>Type / Model</b>	<b>REF. NO.</b>	<b>SEM NO.</b>	<b>Description</b>	
FL 6 FM 7 FM 9 FM 12 FH 12	1079225	<b>10423</b>	Stabilizer Bush	
				D=Ø100 d=Ø58 Ax=78

	<b>SEM NO.</b> <b>10424</b>	<b>REF. NO.</b> 20452330	<b>Type / Model</b> FL 6 FM 7 FM 9 FM 12 FH 12
<b>Description</b> Stabilizer Bush			
D=Ø100 d=Ø64 Ax=65			
	<b>SEM NO.</b> <b>12825</b>	 <b>REF. NO.</b> 1591023	<b>Type / Model</b>
<b>Description</b> Rubber Metal Bushing			
	<b>SEM NO.</b> <b>8006</b>	<b>REF. NO.</b> 0363864	<b>Type / Model</b>
<b>Description</b> Stabilizer Rubber			
D=Ø71 d=Ø45 h=106			
	<b>SEM NO.</b> <b>8007</b>	<b>REF. NO.</b> 1609768	<b>Type / Model</b>
<b>Description</b> Stabilizer Rubber			
D=Ø71 d=Ø53 h=106			
	<b>SEM NO.</b> <b>8008</b>	<b>REF. NO.</b> 1573032	<b>Type / Model</b>
<b>Description</b> Stabilizer Rubber			
D=Ø71 d=Ø50 h=105			
	<b>SEM NO.</b> <b>8009</b>	<b>REF. NO.</b> 1629169	<b>Type / Model</b>
<b>Description</b> Stabilizer Rubber			
D=Ø82 d=Ø60 h=97			







<b>Type / Model</b>	<b>REF. NO.</b>	<b>SEM NO.</b>	 <p><b>Description</b> Stabilizer Rubber</p> <p>D=Ø81 d=Ø49 h=97</p>
	1575339	8010	
<b>Type / Model</b>	<b>REF. NO.</b>	<b>SEM NO.</b>	 <p><b>Description</b> Stabilizer Bushing</p> <p>D=Ø71 d=Ø40 h=106</p>
		8501	
<b>Type / Model</b>	<b>REF. NO.</b>	<b>SEM NO.</b>	 <p><b>Description</b> Stabilizer Bushing</p> <p>D=Ø82 d=Ø47 h=97</p>
		8502	
<b>Type / Model</b>	<b>REF. NO.</b>	<b>SEM NO.</b>	 <p><b>Description</b> Stabilizer Bushing</p> <p>D=Ø90 d=Ø48 h=88</p>
	15800105	8593	
<b>Type / Model</b>	<b>REF. NO.</b>	<b>SEM NO.</b>	 <p><b>Description</b> Stabilizer Bushing</p> <p>D=Ø66 d=Ø30 h=75</p>
	15800097	8594	
<b>Type / Model</b>	<b>REF. NO.</b>	<b>SEM NO.</b>	 <p><b>Description</b> Stabilizer Bush</p> <p>D=Ø65 d=Ø34 Ax=64</p>
	1620750	7692	







	<table border="1"> <thead> <tr> <th>SEM NO.</th> <th>REF. NO.</th> </tr> </thead> <tbody> <tr> <td>7785</td> <td>1624605</td> </tr> </tbody> </table>	SEM NO.	REF. NO.	7785	1624605	<table border="1"> <thead> <tr> <th>Type / Model</th> </tr> </thead> </table>	Type / Model
SEM NO.	REF. NO.						
7785	1624605						
Type / Model							
<p>D=Ø45 d=Ø17,5 h=50</p>	<p><b>Description</b> Stabilizer Mounting</p>						
	<table border="1"> <thead> <tr> <th>SEM NO.</th> <th>REF. NO.</th> </tr> </thead> <tbody> <tr> <td>7822</td> <td>001134955</td> </tr> </tbody> </table>	SEM NO.	REF. NO.	7822	001134955	<table border="1"> <thead> <tr> <th>Type / Model</th> </tr> </thead> </table>	Type / Model
SEM NO.	REF. NO.						
7822	001134955						
Type / Model							
<p>D=Ø57,5 d=Ø28 h=64</p>	<p><b>Description</b> Bush</p>						
	<table border="1"> <thead> <tr> <th>SEM NO.</th> <th>REF. NO.</th> </tr> </thead> <tbody> <tr> <td>8610</td> <td>1190030</td> </tr> </tbody> </table>	SEM NO.	REF. NO.	8610	1190030	<table border="1"> <thead> <tr> <th>Type / Model</th> </tr> </thead> </table>	Type / Model
SEM NO.	REF. NO.						
8610	1190030						
Type / Model							
<p>D=Ø57,5 d=Ø12 Ax=97</p>	<p><b>Description</b> Stabilizer Bushing</p>						
	<table border="1"> <thead> <tr> <th>SEM NO.</th> <th>REF. NO.</th> </tr> </thead> <tbody> <tr> <td>8125</td> <td>1620753</td> </tr> </tbody> </table>	SEM NO.	REF. NO.	8125	1620753	<table border="1"> <thead> <tr> <th>Type / Model</th> </tr> </thead> </table>	Type / Model
SEM NO.	REF. NO.						
8125	1620753						
Type / Model							
<p>D=Ø34 d=Ø14 Ax=97</p>	<p><b>Description</b> Pin for Bushing</p>						
	<table border="1"> <thead> <tr> <th>SEM NO.</th> <th>REF. NO.</th> </tr> </thead> <tbody> <tr> <td>8605</td> <td>3030255</td> </tr> </tbody> </table>	SEM NO.	REF. NO.	8605	3030255	<table border="1"> <thead> <tr> <th>Type / Model</th> </tr> </thead> </table>	Type / Model
SEM NO.	REF. NO.						
8605	3030255						
Type / Model							
<p>D=Ø28,1 d=Ø15 Ax=97</p>	<p><b>Description</b> Bush Pin</p>						
	<table border="1"> <thead> <tr> <th>SEM NO.</th> <th>REF. NO.</th> </tr> </thead> <tbody> <tr> <td>8606</td> <td>1608758</td> </tr> </tbody> </table>	SEM NO.	REF. NO.	8606	1608758	<table border="1"> <thead> <tr> <th>Type / Model</th> </tr> </thead> </table>	Type / Model
SEM NO.	REF. NO.						
8606	1608758						
Type / Model							
<p>D=Ø28,1 d=Ø13,5 Ax=97</p>	<p><b>Description</b> Bush Pin</p>						

<b>Type / Model</b>	<b>REF. NO.</b>	<b>SEM NO.</b>	
	1135803	8607	
			<b>Description</b> Bush Pin D=Ø28,1 d=Ø12 Ax=97
<b>Type / Model</b>	<b>REF. NO.</b>	<b>SEM NO.</b>	
	8157254	8608	
			<b>Description</b> Bush Pin D=Ø28,1 d=Ø14,5 Ax=107
<b>Type / Model</b>	<b>REF. NO.</b>	<b>SEM NO.</b>	
	5152450 8152450	8609	
			<b>Description</b> Bush Pin D=Ø34,1 d=Ø14,5 Ax=107
<b>Type / Model</b>	<b>REF. NO.</b>	<b>SEM NO.</b>	
1-7692 2-8125 3-8110 4-8039	1620753S 16050478S 1605182S 16051823S 1620750S	8126	
			<b>Description</b> Stabilizer Repair Kit
<b>Type / Model</b>	<b>REF. NO.</b>	<b>SEM NO.</b>	
	16051823 1605182	8039	
			<b>Description</b> Bush D=Ø90 d=Ø55 h=95
<b>Type / Model</b>	<b>REF. NO.</b>	<b>SEM NO.</b>	
	1075188	8100	
			<b>Description</b> Stabilizer Rubber Ø59,5x74 89x66

	<table border="1"> <thead> <tr> <th>SEM NO.</th> <th>REF. NO.</th> <th>Type / Model</th> </tr> </thead> <tbody> <tr> <td>8101</td> <td>1628318</td> <td></td> </tr> </tbody> </table>	SEM NO.	REF. NO.	Type / Model	8101	1628318		<p><b>Description</b> Stabilizer Plastic</p>
SEM NO.	REF. NO.	Type / Model						
8101	1628318							
Ø53x70x91								
	<table border="1"> <thead> <tr> <th>SEM NO.</th> <th>REF. NO.</th> <th>Type / Model</th> </tr> </thead> <tbody> <tr> <td>8106</td> <td>1624611</td> <td></td> </tr> </tbody> </table>	SEM NO.	REF. NO.	Type / Model	8106	1624611		<p><b>Description</b> Stabilizer Plastic</p>
SEM NO.	REF. NO.	Type / Model						
8106	1624611							
Ø35xØ50      63x56/59								
	<table border="1"> <thead> <tr> <th>SEM NO.</th> <th>REF. NO.</th> <th>Type / Model</th> </tr> </thead> <tbody> <tr> <td>8107</td> <td>1075179</td> <td></td> </tr> </tbody> </table>	SEM NO.	REF. NO.	Type / Model	8107	1075179		<p><b>Description</b> Stabilizer Plastic</p>
SEM NO.	REF. NO.	Type / Model						
8107	1075179							
Ø35x57x88								
	<table border="1"> <thead> <tr> <th>SEM NO.</th> <th>REF. NO.</th> <th>Type / Model</th> </tr> </thead> <tbody> <tr> <td>8108</td> <td>1075180</td> <td></td> </tr> </tbody> </table>	SEM NO.	REF. NO.	Type / Model	8108	1075180		<p><b>Description</b> Stabilizer Plastic</p>
SEM NO.	REF. NO.	Type / Model						
8108	1075180							
Ø45x66x88								
	<table border="1"> <thead> <tr> <th>SEM NO.</th> <th>REF. NO.</th> <th>Type / Model</th> </tr> </thead> <tbody> <tr> <td>8109</td> <td>1622838</td> <td></td> </tr> </tbody> </table>	SEM NO.	REF. NO.	Type / Model	8109	1622838		<p><b>Description</b> Stabilizer Plastic</p>
SEM NO.	REF. NO.	Type / Model						
8109	1622838							
Ø75xØ115x96								
	<table border="1"> <thead> <tr> <th>SEM NO.</th> <th>REF. NO.</th> <th>Type / Model</th> </tr> </thead> <tbody> <tr> <td>8110</td> <td>16050478</td> <td></td> </tr> </tbody> </table>	SEM NO.	REF. NO.	Type / Model	8110	16050478		<p><b>Description</b> Stabilizer Plastic</p>
SEM NO.	REF. NO.	Type / Model						
8110	16050478							
Ø60xØ90x96								



Type / Model	REF. NO.	SEM NO.	
	1607561	8111	 <b>Description</b> Stabilizer Plastic  Ø65xØ90x96
	1611551	8221	 <b>Description</b> Stabilizer Bush  D=Ø55 d=Ø39 h=52
	1076890	8598	 <b>Description</b> Stabilizer Plastic  D=Ø66 d=Ø40 h=90
	1570910 8152645	8102	 <b>Description</b> Stabilizer Plastic  Ø40,5xØ50      Ø62x27,5
	1581543	8103	 <b>Description</b> Stabilizer Plastic  Ø130xØ172 81,5
	1620443	8104	 <b>Description</b> Stabilizer Plastic  Ø130xØ172 67,5

	SEM NO.	REF. NO.	Type / Model
 Ø25xØ34,5    Ø45x27 <b>Description</b> Stabilizer Plastic	8105	1587261	
 D=Ø50 d=Ø25 L=24 <b>Description</b> Plastic Bearing	11964	 6799335	
 D=Ø46 d=Ø25 h=22 <b>Description</b> Stabilizer Bush	8235	1589807	
 <b>Description</b> Stabilizer Repair Kit	8299	1589807S	
 <b>Description</b> Stabilizer Repair Kit	9129	1611551S	1-1611551 2-968437 3-1625954 4-1589807 5-946673

<b>Type / Model</b>	<b>REF. NO.</b>	<b>SEM NO.</b>	
	275988 20808872	<b>8036 (8038)</b>	
		<b>Description</b>	
		Ball Joint (Kit)	
			D=Ø67 d=Ø17 Ax=100
<b>Type / Model</b>	<b>REF. NO.</b>	<b>SEM NO.</b>	
	271187 11043031	<b>7595 (7756)</b>	
		<b>Description</b>	
		Ball Joint (Kit)	
			D=Ø75 d=Ø17 Ax=115
<b>Type / Model</b>	<b>REF. NO.</b>	<b>SEM NO.</b>	
	274070	<b>7636 (8134)</b>	
		<b>Description</b>	
		Ball Joint (Kit)	
			D=Ø75 d=Ø21 Ax=130
<b>Type / Model</b>	<b>REF. NO.</b>	<b>SEM NO.</b>	
	20740700 24426061 20753761	<b>9614</b>	
		<b>Description</b>	
		Ball Joint (Kit)	
			D=Ø75 d=Ø17 Ax=130
<b>Type / Model</b>	<b>REF. NO.</b>	<b>SEM NO.</b>	
	20510773S 20912523S 20912602S 70371202S 20912536	<b>10429 (11747)</b>	
		<b>Description</b>	
		Ball Joint (Kit)	
			D=Ø75 d=Ø17 Ax=115
<b>Type / Model</b>	<b>REF. NO.</b>	<b>SEM NO.</b>	
	3093462	<b>8213 (8215)</b>	
		<b>Description</b>	
		Ball Joint (Kit)	
			D=Ø75 d=Ø17 Ax=115

 <p>D=Ø75 d=Ø19 Ax=115</p>	<table border="1"> <thead> <tr> <th>SEM NO.</th> <th>REF. NO.</th> </tr> </thead> <tbody> <tr> <td>8465</td> <td>20547286</td> </tr> </tbody> </table> <p><b>Description</b> Ball Joint (Kit)</p>	SEM NO.	REF. NO.	8465	20547286	<table border="1"> <thead> <tr> <th>Type / Model</th> </tr> </thead> </table>	Type / Model
SEM NO.	REF. NO.						
8465	20547286						
Type / Model							
 <p>D=Ø75 d=Ø17x20 Ax=115</p>	<table border="1"> <thead> <tr> <th>SEM NO.</th> <th>REF. NO.</th> </tr> </thead> <tbody> <tr> <td>9082</td> <td>3092452 3090452</td> </tr> </tbody> </table> <p><b>Description</b> Ball Joint (Kit)</p>	SEM NO.	REF. NO.	9082	3092452 3090452	<table border="1"> <thead> <tr> <th>Type / Model</th> </tr> </thead> </table>	Type / Model
SEM NO.	REF. NO.						
9082	3092452 3090452						
Type / Model							
 <p>D=Ø75 d=Ø17 Ax=115</p>	<table border="1"> <thead> <tr> <th>SEM NO.</th> <th>REF. NO.</th> </tr> </thead> <tbody> <tr> <td>10451</td> <td>20453123S 85104224</td> </tr> </tbody> </table> <p><b>Description</b> Ball Joint (Kit)</p>	SEM NO.	REF. NO.	10451	20453123S 85104224	<table border="1"> <thead> <tr> <th>Type / Model</th> </tr> </thead> </table>	Type / Model
SEM NO.	REF. NO.						
10451	20453123S 85104224						
Type / Model							
 <p>D=Ø75 d=Ø17 Ax=130</p>	<table border="1"> <thead> <tr> <th>SEM NO.</th> <th>REF. NO.</th> </tr> </thead> <tbody> <tr> <td>12045</td> <td>9523029 3093467</td> </tr> </tbody> </table> <p><b>Description</b> Ball Joint</p>	SEM NO.	REF. NO.	12045	9523029 3093467	<table border="1"> <thead> <tr> <th>Type / Model</th> </tr> </thead> </table>	Type / Model
SEM NO.	REF. NO.						
12045	9523029 3093467						
Type / Model							
 <p>D=Ø85 d=Ø21 Ax=152</p>	<table border="1"> <thead> <tr> <th>SEM NO.</th> <th>REF. NO.</th> </tr> </thead> <tbody> <tr> <td>7432 (7745)</td> <td>274068</td> </tr> </tbody> </table> <p><b>Description</b> Ball Joint (Kit)</p>	SEM NO.	REF. NO.	7432 (7745)	274068	<table border="1"> <thead> <tr> <th>Type / Model</th> </tr> </thead> </table>	Type / Model
SEM NO.	REF. NO.						
7432 (7745)	274068						
Type / Model							
 <p>D=Ø85 d=Ø21 Ax=130</p>	<table border="1"> <thead> <tr> <th>SEM NO.</th> <th>REF. NO.</th> </tr> </thead> <tbody> <tr> <td>7565 (7751)</td> <td>0273373 4941233 0691709 0274019</td> </tr> </tbody> </table> <p><b>Description</b> Ball Joint (Kit)</p>	SEM NO.	REF. NO.	7565 (7751)	0273373 4941233 0691709 0274019	<table border="1"> <thead> <tr> <th>Type / Model</th> </tr> </thead> </table>	Type / Model
SEM NO.	REF. NO.						
7565 (7751)	0273373 4941233 0691709 0274019						
Type / Model							

<b>Type / Model</b>	<b>REF. NO.</b>	<b>ŞEM NO.</b>	
	21295227S1 21295230	<b>7981 (10457)</b>	<p><b>Description</b> Ball Joint (Kit)</p> <p>D=Ø85 d=Ø23 Ax=130</p>
<b>Type / Model</b>	<b>REF. NO.</b>	<b>ŞEM NO.</b>	
	20840815 3093630 3093631	<b>8225</b>	<p><b>Description</b> Ball Joint (Kit)</p> <p>D=Ø85 d=Ø21x26 Ax=130</p>
<b>Type / Model</b>	<b>REF. NO.</b>	<b>ŞEM NO.</b>	
	20702096	<b>10430</b>	<p><b>Description</b> Ball Joint (Kit)</p> <p>D=Ø85 d=Ø21 Ax=130</p>
<b>Type / Model</b>	<b>REF. NO.</b>	<b>ŞEM NO.</b>	
Alternatively Rubber Type	273375S	<b>8174</b>	<p><b>Description</b> Ball Joint (Kit)</p> <p>D=Ø90 d=Ø23 Ax=152</p>
<b>Type / Model</b>	<b>REF. NO.</b>	<b>ŞEM NO.</b>	
	276192	<b>7879 (9202)</b>	<p><b>Description</b> Ball Joint (Kit)</p> <p>D=Ø95 d=Ø23 Ax=152</p>
<b>Type / Model</b>	<b>REF. NO.</b>	<b>ŞEM NO.</b>	
	274056	<b>7880 (7882)</b>	<p><b>Description</b> Ball Joint (Kit)</p> <p>D=Ø95 d=Ø23 Ax=152</p>

	SEM NO.	REF. NO.	Type / Model
	<b>8616</b> (10189)	273612 20702095	
	<b>Description</b> Ball Joint (Kit)		
D=Ø95 d=Ø21 Ax=130			









	SEM NO.	REF. NO.	Type / Model
	<b>10079</b> (10080)	3198309	
	<b>Description</b> Ball Joint (Kit)		
D=Ø108 d=Ø25 Ax=152			

	SEM NO.	REF. NO.	Type / Model
	<b>10836</b>	20976031S 21492537S 21513940S	
	<b>Description</b> Ball Joint (Kit)		
D=Ø108 d=Ø23 Ax=165			

	SEM NO.	REF. NO.	Type / Model
	<b>7838</b>	1628107	
	<b>Description</b> Ball Joint		
D=Ø91 Ax=145			

	SEM NO.	REF. NO.	Type / Model
	<b>7839</b>	1598588 3159435	
	<b>Description</b> Ball Joint		
D=Ø91 Ax=125			

	SEM NO.	REF. NO.	Type / Model
	<b>7840</b>	1614355	
	<b>Description</b> Ball Joint		
D=Ø91 Ax=125			

<b>Type / Model</b>	<b>REF. NO.</b>		<b>SEM NO.</b>		
	9520200		8404		
				<b>Description</b>	
				Ball Joint	
					D=Ø91 Ax=125
<b>Type / Model</b>	<b>REF. NO.</b>		<b>SEM NO.</b>		
	1136891		10440		
				<b>Description</b>	
				Rubber Metal Bush	
					D=Ø91 h=125
<b>Type / Model</b>	<b>REF. NO.</b>		<b>SEM NO.</b>		
	20523294		11823		
				<b>Description</b>	
				Rubber Metal Bush	
					D=Ø84 d=Ø18x21 Ax=115
<b>Type / Model</b>	<b>REF. NO.</b>		<b>SEM NO.</b>		
	70371217		10240		
				<b>Description</b>	
				Rubber Metal Bush	
					D=Ø91 d=Ø17 Ax=115
<b>Type / Model</b>	<b>REF. NO.</b>		<b>SEM NO.</b>		
	1135080		8285		
				<b>Description</b>	
				Bush	
					D=Ø91 d=Ø52 h=85
<b>Type / Model</b>	<b>REF. NO.</b>		<b>SEM NO.</b>		
	70392314		11988 (1154)		
				<b>Description</b>	
				Ball Joint (Kit)	
					D=Ø108 d=Ø36 L=67



	SEM NO.	REF. NO.	Type / Model
	7841	3173759 1075255 1591689 20554908	
	<b>Description</b> Ball Joint		

D=Ø138

	SEM NO.	REF. NO.	Type / Model
	12026	<i>new product</i> 20808868	
	<b>Description</b> Ball Joint		





D=75



	SEM NO.	REF. NO.	Type / Model
	9098 (9100)	3097188	
	<b>Description</b> Ball Joint (Kit)		





D=Ø85 L=250 Cone=48









Model:	SEM NO.	Description / Repair Kit
	<b>10885</b>	
	REF. NO: 20589061S1	
Model:	SEM NO.	Description / Ball Joint Kit
	<b>10886</b>	
	REF. NO: 20589061S2	
		D= Ø85 d=Ø19 Ax=115
Model:	SEM NO.	Description / Repair Kit
	<b>10927</b>	
	REF. NO: 20976031S1 21492537S1 21513940S1	
Model:	SEM NO.	Description / Ball Joint (Repair Kit)
	<b>7727 (7758)</b>	
	REF. NO: 3090015	

Description / Ball Joint (Repair Kit)	SEM NO.	Model:
	7829 (7830)	
	REF. NO: 3133173	
	Ø72	
Description / Ball Joint (Repair Kit)	SEM NO.	Model:
	7832	
	REF. NO: 271188	
	Ø72	
Description / Ball Joint (Repair Kit)	SEM NO.	Model:
	8466	
	REF. NO: 20741710	
	D=Ø72 h=45 M20x1,5	
Description / Ball Joint (Repair Kit)	SEM NO.	Model:
	8619	
	REF. NO: 3093469	
	D=Ø72 d=Ø45 M20x1,5	

Model:	SEM NO.	Description / Ball Joint (Repair Kit)
	<b>9094</b>	
	<b>REF. NO:</b> 274069	
	D=Ø72	
Model:	SEM NO.	Description / Ball Joint (Repair Kit)
	<b>7827 (7828)</b>	
	<b>REF. NO:</b> 273706	
	Ø90	
Model:	SEM NO.	Description / Ball Joint (Repair Kit)
	<b>7836</b>	
	<b>REF. NO:</b> 02733749	
	Ø90	
Model:	SEM NO.	Description / Ball Joint (Repair Kit)
	<b>7851 (10809)</b>	
	<b>REF. NO:</b> 276191	
	D=Ø90	

Description / Ball Joint (Repair Kit)	SEM NO.	Model:
	<p><b>7852 (7853)</b></p> <p>REF. NO: 273375</p> <p>D=Ø90</p>	
	<p><b>8020</b></p> <p>REF. NO: 3090712</p> <p>Ø90</p>	
	<p><b>8523</b></p> <p>REF. NO: 20840820</p> <p>Ø90</p>	
	<p><b>10436</b></p> <p>REF. NO: 21295227S</p> <p>D=Ø90</p>	

Type / Model	REF. NO.	SEM NO.	
FH 12 FM 400 FH 16 FM 440 FH 400 FM 480 FH 440 FL 6 FM 12 FM 9 FM 380	21051052 20522934      1- 8616 Page 614	<b>8615</b>	 <b>Description</b> Axle Rod L=510 d=Ø21/21 Ax=Ø130/130
	9518845	<b>9391</b>	 <b>Description</b> Axle Rod L=490 d=Ø17/17 Ax=100/100
	1135427	<b>9392</b>	 <b>Description</b> Axle Rod L=666 d=Ø14/52 Ax=125/30
	9523795	<b>9393</b>	 <b>Description</b> Axle Rod L=535 d=Ø14/14 Ax=125/30
	9523794	<b>9394</b>	 <b>Description</b> Axle Rod L=535 d=Ø14/52 Ax=125/30
	1589817	<b>9395</b>	 <b>Description</b> Axle Rod L=666 d=Ø14/14 Ax=125/30

SEM NO.	REF. NO.	Type / Model
<b>9396</b>	24426046 9955949	
 <p><b>Description</b> Axle Rod</p>		
L=510 d=Ø17/17 Ax=130/130		1- 9614 Page 611

SEM NO.	REF. NO.	Type / Model
<b>9397</b>	1581527 1607079 8154017 8158207 8158206	
 <p><b>Description</b> Axle Rod Alternative Rubber</p>		
L=660 d=Ø21/21 Ax=130/130		1- 7565 Page 612







SEM NO.	REF. NO.	Type / Model
<b>9398</b>	1626958	
 <p><b>Description</b> Axle Rod Alternative Rubber</p>		
L=571 d=Ø21/21 Ax=130/130		1- 7565 Page 612













SEM NO.	REF. NO.	Type / Model
<b>9399</b>	1606551 8154016	
 <p><b>Description</b> Axle Rod Alternative Rubber</p>		
L=660 d=Ø21/21 Ax=130/130		1- 7636 Page 611

SEM NO.	REF. NO.	Type / Model
<b>10178</b>	20453123	
 <p><b>Description</b> Axle Rod</p>		
L=449 d=Ø17/17 Ax=115/115		1- 10451 Page 612

SEM NO.	REF. NO.	Type / Model
<b>10179</b>	20374444 20410530 20509018	
 <p><b>Description</b> Axle Rod</p>		
L=625 d=Ø17/17 Ax=115/115		1- 8213 Page 611









Type / Model	REF. NO.	SEM NO.	
	20443044	10449	
		<b>Description</b>	1 1
		Axle Rod	
1- 8213 Page 611			Ax=510
	20517494	11659	
		<b>Description</b>	1 1
		Axle Rod	
1- 10451 Page 612			L=625 d=Ø/17/17 Ax=115/115
	20532931 21051046	11660	
		<b>Description</b>	1 1
		Axle Rod	
1- 10430 Page 613			L=515 d=Ø/21/21 Ax=130/130
	1082104 1605035	11787	
		<b>Description</b>	1 2
		Axle Rod	
1- 8285 Page 615 2- 7839 Page 614			L=666mm d=14/52 Ax=125x30
	20816995 21072242 24426047 70313756	11811	
		<b>Description</b>	1 1
		Axle Rod	
1- 9614 Page 611			L=576 d=17/17 Ax=130/130
	20816978 24426045 70301436 21477187	11812	
		<b>Description</b>	1 1
		Axle Rod	
1- 9614 Page 611			L=510 d=17/17 Ax=130/130

	SEM NO.		REF. NO.	Type / Model
	11994		8365399 1135429	
	<b>Description</b>			
	Axle Rod			
	12913		20510773 20912602 20912523 70371202	
	<b>Description</b>			
	Axle Rod			
L=666 d=Ø17/17 Ax=115/115				1- 7595 Page 611
	12915		8074268	
	<b>Description</b>			
	Axle Rod			
L=575 d=Ø17/17 Ax=100/100				1- 8036 Page 611
	12922		1626050	
	<b>Description</b>			
	Axle Rod			
L=496 d=Ø14/14 Ax=125/30				1- 7839 Page 614
	12929		20410053 21106157	
	<b>Description</b>			
	Axle Rod			
L=799 d=Ø17/17 Ax=115/115				1- 8213 Page 611
	12942		20816966 70321086 24426044	
	<b>Description</b>			
	Axle Rod			
L=580 d=Ø17/17 Ax=130/130				1- 9614 Page 611



<p><b>Type / Model</b></p> <p>REF. NO.</p> <p>20392649 1076639 1629734 1626896</p> <p>1- 8020 Page 620 2- 8225 Page 613</p>	<p><b>SEM NO.</b></p> <p><b>8224</b></p> <p><b>Description</b></p> <p>Axle Rod ( V )</p>	<p>L=671 Ax=130/130 d=Ø21x26/21x26</p>
<p><b>Type / Model</b></p> <p>REF. NO.</p> <p>20741703 20367004 20507262 20741695</p> <p>1- 8466 Page 618 2- 8465 Page 612</p>	<p><b>SEM NO.</b></p> <p><b>8464</b></p> <p><b>Description</b></p> <p>Axle Rod ( V )</p>	<p>L=663 Ax=115/115 d=Ø19/19</p>
<p><b>Type / Model</b></p> <p>PREMIUM LANDER KERAX</p> <p>REF. NO.</p> <p>20829503</p> <p>1- 8523 Page 620 2- 8225 Page 613</p>	<p><b>SEM NO.</b></p> <p><b>8521 (8522)</b></p> <p><b>Description</b></p> <p>Axle Rod ( V )</p>	<p>L=671 Ax=130/130 d=Ø26x21/26x21</p>
<p><b>Type / Model</b></p> <p>REF. NO.</p> <p>20556490 3173291</p> <p>1- 7841 Page 616 2- 7838 Page 614</p>	<p><b>SEM NO.</b></p> <p><b>8806</b></p> <p><b>Description</b></p> <p>Axle Rod ( V )</p>	<p>L=677 Ax=30-145/30-145 d=Ø15/15</p>
<p><b>Type / Model</b></p> <p>REF. NO.</p> <p>1606200 1576952 1509222 1080690</p> <p>1- 7851 Page 619 2- 7880 Page 613</p>	<p><b>SEM NO.</b></p> <p><b>8807</b></p> <p><b>Description</b></p> <p>Axle Rod ( V )</p>	<p>L=635 Ax=152/152 d=Ø23/23</p>
<p><b>Type / Model</b></p> <p>REF. NO.</p> <p>20382314 20502944 1094466</p> <p>1- 8466 Page 618 2- 9082 Page 612</p>	<p><b>SEM NO.</b></p> <p><b>9318</b></p> <p><b>Description</b></p> <p>Axle Rod ( V )</p>	<p>L=650,5 Ax=115/115 d=Ø20x17/20x17</p>

	<table border="1"> <thead> <tr> <th>SEM NO.</th> <th>REF. NO.</th> <th>Type / Model</th> </tr> </thead> <tbody> <tr> <td>9319</td> <td>3172829 8073569</td> <td></td> </tr> </tbody> </table>	SEM NO.	REF. NO.	Type / Model	9319	3172829 8073569		<p><b>Description</b></p>	<p>Axle Rod ( V )</p>	<p>1- 7832 Page 618 2- 9082 Page 612</p>
SEM NO.	REF. NO.	Type / Model								
9319	3172829 8073569									
<p>L=677 Ax=115/115 d=Ø20/20</p>										
	<table border="1"> <thead> <tr> <th>SEM NO.</th> <th>REF. NO.</th> <th>Type / Model</th> </tr> </thead> <tbody> <tr> <td>9320</td> <td>3173293 20556492</td> <td></td> </tr> </tbody> </table>	SEM NO.	REF. NO.	Type / Model	9320	3173293 20556492		<p><b>Description</b></p>	<p>Axle Rod ( V )</p>	<p>1- 7841 Page 616 2- 7838 Page 614</p>
SEM NO.	REF. NO.	Type / Model								
9320	3173293 20556492									
<p>L=660 Ax=30-145/30-145 d=Ø15/15</p>										
	<table border="1"> <thead> <tr> <th>SEM NO.</th> <th>REF. NO.</th> <th>Type / Model</th> </tr> </thead> <tbody> <tr> <td>9321</td> <td>3173292 20556491</td> <td></td> </tr> </tbody> </table>	SEM NO.	REF. NO.	Type / Model	9321	3173292 20556491		<p><b>Description</b></p>	<p>Axle Rod ( V )</p>	<p>1- 7841 Page 616 2- 7838 Page 614</p>
SEM NO.	REF. NO.	Type / Model								
9321	3173292 20556491									
<p>L=677 Ax=30-145/30-145 d=Ø15/15</p>										
	<table border="1"> <thead> <tr> <th>SEM NO.</th> <th>REF. NO.</th> <th>Type / Model</th> </tr> </thead> <tbody> <tr> <td>9322</td> <td>1590068</td> <td></td> </tr> </tbody> </table>	SEM NO.	REF. NO.	Type / Model	9322	1590068		<p><b>Description</b></p>	<p>Axle Rod ( V )</p>	<p>1- 7829 Page 618 2- 7595 Page 611</p>
SEM NO.	REF. NO.	Type / Model								
9322	1590068									
<p>L=644 Ax=115/115 d=Ø17/17</p>										
	<table border="1"> <thead> <tr> <th>SEM NO.</th> <th>REF. NO.</th> <th>Type / Model</th> </tr> </thead> <tbody> <tr> <td>9323</td> <td>1606552</td> <td></td> </tr> </tbody> </table>	SEM NO.	REF. NO.	Type / Model	9323	1606552		<p><b>Description</b></p>	<p>Axle Rod ( V )</p>	<p>1- 9094 Page 619 2- 7432 Page 612</p>
SEM NO.	REF. NO.	Type / Model								
9323	1606552									
<p>L=641 Ax=152/152 d=Ø21/21</p>										
	<table border="1"> <thead> <tr> <th>SEM NO.</th> <th>REF. NO.</th> <th>Type / Model</th> </tr> </thead> <tbody> <tr> <td>9324</td> <td>1576953</td> <td></td> </tr> </tbody> </table>	SEM NO.	REF. NO.	Type / Model	9324	1576953		<p><b>Description</b></p>	<p>Axle Rod ( V )</p>	<p>1- 7827 Page 619 2- 7880 Page 613</p>
SEM NO.	REF. NO.	Type / Model								
9324	1576953									
<p>L=700 Ax=152/152 d=Ø23/23</p>										

<p><b>Type / Model</b></p> <p>1- 10885 Page 617 2- 10886 Page 617</p>	<p><b>REF. NO.</b></p> <p>20589061 20428251 20556608 20491771 20703338</p> <p><b>ŞEM NO.</b></p> <p><b>9325</b></p>	<p><b>Description</b></p> <p>Axle Rod ( V )</p>  <p>L=662 Ax=115/115 d=Ø19/19</p>
<p><b>Type / Model</b></p> <p>1- 10436 Page 620 2- 7981 Page 613</p>	<p><b>REF. NO.</b></p> <p>21295227</p> <p><b>ŞEM NO.</b></p> <p><b>10459</b></p>	<p><b>Description</b></p> <p>Axle Rod ( V )</p>  <p>L=671 d=Ø23/23 Ax=130/130</p>
<p><b>Type / Model</b></p> <p>1- 10927 Page 617 2- 10836 Page 614</p>	<p><b>REF. NO.</b></p> <p>20976031 21492537 21513940</p> <p><b>ŞEM NO.</b></p> <p><b>10825</b></p>	<p><b>Description</b></p> <p>Axle Rod ( V )</p>  <p>L=646,5 d=Ø23/23 Ax=165/165</p>
<p><b>Type / Model</b></p> <p>1- 7841 Page 616 2- 7682 Page 90</p>	<p><b>REF. NO.</b></p> <p>20556493 3173297</p> <p><b>ŞEM NO.</b></p> <p><b>11253</b></p>	<p><b>Description</b></p> <p>V-Torque Rod</p>  <p>L=676,4 d=Ø15/15 Ax=145x30/145x30</p>
<p><b>Type / Model</b></p> <p>1- 7841 Page 616 2- 7839 Page 614</p>	<p><b>REF. NO.</b></p> <p>20556588 3173290</p> <p><b>ŞEM NO.</b></p> <p><b>11254</b></p>	<p><b>Description</b></p> <p>V-Torque Rod</p>  <p>L=673,6 d=Ø14/14 Ax=125x30/125x30</p>
<p><b>Type / Model</b></p> <p>1- 7841 Page 616 2- 7838 Page 614</p>	<p><b>REF. NO.</b></p> <p>20556488 3173289</p> <p><b>ŞEM NO.</b></p> <p><b>11255</b></p>	<p><b>Description</b></p> <p>V-Torque Rod</p>  <p>L=666,3 d=Ø15/15 Ax=145x30/145x30</p>

	<b>ŞEM NO.</b>  <b>10233</b>	<b>REF. NO.</b>  1629722 SACHS 290491 MONROE CB0028	<b>Type / Model</b>  OPEN LENGTH=436 CLOSED LENGTH=305 UPPER MOUNT DIMENSION=14x45 LOWER MOUNT DIMENSION=20x45 MAYSAN
	<b>ŞEM NO.</b>  <b>10464</b>	<b>REF. NO.</b>  1622227 3198849 3986315 SACHS 290493 MONROE CB0028 MONROE CB0007	<b>Type / Model</b>  OPEN LENGTH=257 CLOSED LENGTH=236 UPPER MOUNT DIMENSION=20x45 LOWER MOUNT DIMENSION=20x45
	<b>ŞEM NO.</b>  <b>11295</b>	<b>REF. NO.</b>  1576443 15994593 1585586 1622085	<b>Type / Model</b>  OPEN LENGTH=246 CLOSED LENGTH=186 UPPER MOUNT DIMENSION=12x32 LOWER MOUNT DIMENSION=12x32
	<b>ŞEM NO.</b>  <b>11296</b>	<b>REF. NO.</b>  20721849 20840318 SACHS 135050 MONROE CB0046	<b>Type / Model</b>  OPEN LENGTH=262 CLOSED LENGTH=206 UPPER MOUNT DIMENSION=14x45 LOWER MOUNT DIMENSION=14x45
	<b>ŞEM NO.</b>  <b>11441</b>	<b>REF. NO.</b>  1076717 1629478 3987957 20374545 20900497 SACHS 131595 SACHS 124247 SACHS 310774 MONROE T1177 MONROE T1023	<b>Type / Model</b>  OPEN LENGTH=717 CLOSED LENGTH=452 UPPER MOUNT DIMENSION=16x100 LOWER MOUNT DIMENSION=16x66
	<b>ŞEM NO.</b>  <b>11451</b>	<b>REF. NO.</b>  3198836 21111925 SACHS 312695 MONROE CB0040	<b>Type / Model</b>
<b>Description</b>  Shock Absorber			

Type / Model	REF. NO.	SEM NO.	
OPEN LENGTH=804	1628103	11456	 <b>Description</b> Shock Absorber
CLOSED LENGTH=490	1628136		
UPPER MOUNT	1629482		
DIMENSION=16x100	1629483		
LOWER MOUNT	SACHS 310785		
DIMENSION=M16x80	SACHS 124601 MONROE T5097 MONROE T5098		
Type / Model	REF. NO.	SEM NO.	
OPEN LENGTH=400	1629721	11462	 <b>Description</b> Shock Absorber
CLOSED LENGTH=345	SACHS 290489		
UPPER MOUNT	MONROE Cb0029		
DIMENSION=14x45			
LOWER MOUNT			
DIMENSION=14x45			
Type / Model	REF. NO.	SEM NO.	
OPEN LENGTH=328	1075478	11463	 <b>Description</b> Shock Absorber
CLOSED LENGTH=218	MONROE Cb0008		
UPPER MOUNT			
DIMENSION=M12x59			
LOWER MOUNT			
DIMENSION=M20x45			
Type / Model	REF. NO.	SEM NO.	
OPEN LENGTH=333	1580389	11467	 <b>Description</b> Shock Absorber
CLOSED LENGTH=265	301700005669		
UPPER MOUNT	1580387		
DIMENSION=14x32	SACHS 313834		
LOWER MOUNT			
DIMENSION=14x32			
Type / Model	REF. NO.	SEM NO.	
OPEN LENGTH=230	344574	11487	 <b>Description</b> Shock Absorber
CLOSED LENGTH=172	1508429		
UPPER MOUNT	1505892		
DIMENSION=16x32	1588043		
LOWER MOUNT	SACHS 313742		
DIMENSION=16x32			
Type / Model	REF. NO.	SEM NO.	
OPEN LENGTH=652	1069553	11516	 <b>Description</b> Shock Absorber
CLOSED LENGTH=413	1610920		
UPPER MOUNT	1094523		
DIMENSION=16x100	1610921		
LOWER MOUNT	1599623		
DIMENSION=16x66	1613248		
	1609553		
	1626057		
	1609555		
	SACHS 112130		
	MONROE T1005		

	SEM NO.	REF. NO.	Type / Model
 D=Ø47 d=Ø25 h=25	7606	11349628	F 10 F 7 F 12
	<b>Description</b> Rubber Buffer		

	SEM NO.	REF. NO.	Type / Model
 D=Ø42 d=Ø20 h=50	8994	3090934	
	<b>Description</b> Stabilizer Bush		

	SEM NO.	REF. NO.	Type / Model
 D=Ø42 d=Ø16 h=66	8995	3090935	
	<b>Description</b> Stabilizer Bush		

	SEM NO.	REF. NO.	Type / Model
 D=Ø40 d=Ø25 h=40	9016 (9018)	1698046	
	<b>Description</b> Rubber Mounting		







	SEM NO.	REF. NO.	Type / Model
 D=Ø59,5 d=Ø20,5 h=31,5	9019	1697732	
	<b>Description</b> Rubber Mounting		

	SEM NO.	REF. NO.	Type / Model
 D=Ø50,5 d=Ø19 h=26	9030 (9029)	1699143	
	<b>Description</b> Rubber Mounting		



Technical Specification	REF. NO.	SEM NO.	
Total Weight 8,7 kg	3027271	GOODYEAR 1R11-845 FIRESTONE 1T15L-4(3) PHOENIX 1 DF 23 B-2 FIRESTONE W01 095 0405	72.40307.C
			<b>Description</b> Metal Piston
			
Technical Specification	REF. NO.	SEM NO.	
Total Weight 1,7 kg	3027271	CONTITECH RZ 415-25 GOODYEAR 9004 PHOENIX 2 G 20 GY SPRINGRIDE D12S08 VIBRACOUSTIC V2G20 CF GOMMA REF. 1S280-25 FIRESTONE W01-095-0381 CF GOMMA NO. 203001	72.415.R25
			<b>Description</b> Roll
			
Technical Specification	REF. NO.	SEM NO.	
Total Weight 1,9 kg	3027272	CONTITECH RZ 415-28 GOODYEAR 9005 PHOENIX 2 G 20 A GY SPRINGRIDE D12S09 VIBRACOUSTIC V2G20A CF GOMMA REF. 1S280-28 FIRESTONE W01-095-0382 CF GOMMA NO. 203000	72.415.R28
			<b>Description</b> Roll
			
Technical Specification	REF. NO.	SEM NO.	
Total Weight 8,8 kg	1076075 20554756 1076076	CONTITECH 4420 N P01 FIRESTONE 1T17BR-8 FIRESTONE W01-M58-9707 GART NO. 278.1.355 GART REF. D278/V1	72.4420.C01
			<b>Description</b> Metal Piston
			
Technical Specification	REF. NO.	SEM NO.	
Total Weight 8 kg	1076594 20554755	CONTITECH 4713 N P02 PHOENIX 1 DF 22 C 1 FIRESTONE 1T17BR 8 FIRESTONE W01 M58 9706 GOODYEAR 1R12 762 GY SPRINGRIDE D12B24 CF GOMMA REF. 1TS300 28 CF GOMMA NO. 206778 GART NO. 293.1.460 GART REF. 293.1.460 VIBRACOUSTIC V1DF22C 1	72.4713.C02
			<b>Description</b> Metal Piston
			
Technical Specification	REF. NO.	SEM NO.	
Total Weight 4 kg	1076595	CONTITECH 4713 N P04 GOODYEAR 1R12-763 GY SPRINGRIDE D12U24 CF GOMMA REF. 1TS300-28 GART NO. 293.0.461 GART REF. C293/V	72.4713.S
			<b>Description</b> Service Assembly
			



	<b>SEM NO.</b>  <b>72.4718.C01</b>	<b>REF. NO.</b> 1075363 CONTITECH 4718 N P01 20554759 GOODYEAR 1R12-821 20452136 GART NO. 278.1.470 GART REF. D278/V	<b>Technical Specification</b>  Total Weight 9,5 kg
	<b>Description</b>  Metal Piston		
	<b>SEM NO.</b>  <b>72.4718.S</b>	<b>REF. NO.</b> 1079718 CONTITECH 4718 N P02	<b>Technical Specification</b>  Total Weight 4,2 kg
	<b>Description</b>  Service Assembly		
	<b>SEM NO.</b>  <b>72.4760.C</b>	<b>REF. NO.</b> 20554760 CONTITECH 6612 N P01 21961472 20580705	<b>Technical Specification</b>  Total Weight 8,5 kg
	<b>Description</b>  Metal Piston		
	<b>SEM NO.</b>  <b>72.4912.C10</b>	<b>REF. NO.</b> 20722412 CONTITECH 4912 N P10 GOODYEAR 1R13-753 PHOENIX 1 DK 28 F-5	<b>Technical Specification</b>  Total Weight 13,7 kg
	<b>Description</b>  Metal Piston		
	<b>SEM NO.</b>  <b>72.4912.S10</b>	<b>REF. NO.</b> 20722412 CONTITECH 4912 N P10 GOODYEAR 1R13-753 PHOENIX 1 DK 28 F-5	<b>Technical Specification</b>  Total Weight 12,6 kg
	<b>Description</b>  Service Assembly		
	<b>SEM NO.</b>  <b>72.6416.C</b>	<b>REF. NO.</b> 1075891 CONTITECH 6608 N P01 20531985 PHOENIX 1 DF 17 B-1 1076416 VIBRACOUSTIC V1DF16D-1 20582215 FIRESTONE 1T15UR-9 20374510 GART REF. C295/V 70321693 FIRESTONE W01-M58-8474 20456152 GOODYEAR 1R10-704 21961456 GY SPRINGRIDE D10B01 GART NO. 295.1.465	<b>Technical Specification</b>  Total Weight 6,2 kg
	<b>Description</b>  Metal Piston		

Technical Specification	REF. NO.	SEM NO.		
Total Weight 6 kg	1076418	CONTITECH 6607 N P01	<b>72.6418.C</b>	
	20582214	PHOENIX 1 DF 17 A-1		
	20374511	VIBRACOUSTIC V1DF16C-1		
	3171695	FIRESTONE 1T15UR-6		
	20456156	FIRESTONE W01-M58-8473		
	70321695	GOODYEAR 1R10-707		
	20531987	GART NO. 294.1.400		
	21961451	GART REF. C294/VA	<b>Description</b> Metal Piston	
Total Weight 5,2 kg	21961447	CONTITECH 6606 N P02	<b>72.6420.C</b>	
	20582212			
	20531988			
Total Weight 1,4 kg	1134445	GOODYEAR 8017	<b>72.644.R</b>	
	1622111	GY SPRINGRIDE D11S01		
	1199893	CF GOMMA REF. 1S285 24		
	CONTITECH 644 N	CF GOMMA NO. 92574		
	PHOENIX 1 E 21	DUNLOP UK PNP301470102		
	Taurus BL121	GART NO. 276.0.390		
	VIBRACOUSTIC V1E21	GART REF. D276/B		
	FIRESTONE 1R1A390 295	SMB		
	FIRESTONE W01 095 0118	BredaMenarini 199 196		
Total Weight 1,8 kg	624319690	Büssing 831 120 144	<b>72.661.R</b>	
	1137888	CF GOMMA REF. 1S310-28		
	3195253	CF GOMMA NO. 91016		
	CONTITECH 661 N	GART NO. 297.0.390		
	PHOENIX 1 E 25	GART REF. D297		
	VIBRACOUSTIC V1E25(-2)	DUNLOP UK PNP304980101		
	FIRESTONE 1R1C390-310	GY SPRINGRIDE D12S02		
	FIRESTONE W01-095-0021	Büssing 546 905 134		
	GOODYEAR 8018			
Total Weight 1,5 kg	CONTITECH 673 N		<b>72.673.R</b>	
	PHOENIX 1 F 21 A			
	Taurus B141			
	VIBRACOUSTIC V1F21A			
	FIRESTONE 1R1A370-285			
Total Weight 1,7 kg	1622116	CONTITECH 713 N	<b>72.713.R</b>	
	6797169	PHOENIX 1 F 21 D		
		VIBRACOUSTIC V1F21D		
		GOODYEAR 9066		
		GY SPRINGRIDE D12S15		

	<b>ŞEM NO.</b>	<b>REF. NO.</b>	<b>Technical Specification</b>
	72.715.R	6885533	CONTITECH 715 N PHOENIX 1 F 25 VIBRACOUSTIC V1F25 FIRESTONE 1R1C335-310 FIRESTONE W01-095-0087 GOODYEAR 8015 CF GOMMA REF. 1SC310-16 CF GOMMA NO. 93518
	<b>Description</b>		Total Weight 2 kg
			Roll
	<b>ŞEM NO.</b>	<b>REF. NO.</b>	<b>Technical Specification</b>
	72.716.R	1593842	CONTITECH 716 N PHOENIX 1 F 26 B-1 VIBRACOUSTIC V1F26B-1 FIRESTONE 1R2A450-305 CF GOMMA NO. 92548 FIRESTONE W01-095-0145 GOODYEAR 9073 GY SPRINGRIDE D12S19 CF GOMMA REF. 1SC300-34
	<b>Description</b>		Total Weight 2,2 kg
			Roll
	<b>ŞEM NO.</b>	<b>REF. NO.</b>	<b>Technical Specification</b>
	72.720.R	1590136 1629193 1622115	CONTITECH 720 N PHOENIX 1 F 21 VIBRACOUSTIC V1F21 FIRESTONE 1R2A460 295 DUNLOP UK PNP301000100 FIRESTONE W01 095 0195 GOODYEAR 9008 GY SPRINGRIDE D12S04 CF GOMMA REF. 1SC290 30 CF GOMMA NO. 88802
	<b>Description</b>		Total Weight 1,2 kg
			Roll
	<b>ŞEM NO.</b>	<b>REF. NO.</b>	<b>Technical Specification</b>
	72.727.R	1134446	CONTITECH 727 N PHOENIX 1 F 32 A VIBRACOUSTIC V1F32A FIRESTONE 1R2D460-360 FIRESTONE W01-095-0191 Floor 862 GOODYEAR 8117 GY SPRINGRIDE D13S04 CF GOMMA REF. 1SC360-34
	<b>Description</b>		Total Weight 2,5 kg
			Roll
	<b>ŞEM NO.</b>	<b>REF. NO.</b>	<b>Technical Specification</b>
	72.768.R	1612455	CONTITECH 768 N PHOENIX 1 E 27 FIRESTONE 1R2A380-330 FIRESTONE W01-095-0213 GOODYEAR 9078 GY SPRINGRIDE D13S08
	<b>Description</b>		Total Weight 2 kg
			Roll
	<b>ŞEM NO.</b>	<b>REF. NO.</b>	<b>Technical Specification</b>
	72.7803.C	1075890 20531984 20375226 20582206 20427800 21961374 20456150	CONTITECH 6605 N P01 PHOENIX 1 DF 20 D-1 VIBRACOUSTIC V1DF20B-1 FIRESTONE 1T15LNR-6 FIRESTONE W01-M58-8472 GOODYEAR 1R11-805 GART NO. 294.0,431 GART REF. C294/VA
	<b>Description</b>		Total Weight 7 kg
			Metal Piston





Technical Specification	REF. NO.	ŞEM NO.	
Total Weight 6,7 kg	20375227	CONTITECH 6606 N P01	<b>72.7804.C</b>
	3171694	PHOENIX 1 DF 20 E-1	
	20456154	VIBRACOUSTIC V1DF20A-1	
	70321694	FIRESTONE 1T15LNR-3	
	20531986	FIRESTONE W01-M58-8477	
	20427801	GOODYEAR 1R11-848	
	20582209	GART NO. 294.1.370	
	21961443	GART REF. C294/VA	<b>Description</b> Metal Piston
<hr/>			
Technical Specification	REF. NO.	ŞEM NO.	
Total Weight 1,4 kg	CONTITECH 782 N	CF GOMMA REF. 1S290-23V	<b>72.782.R</b>
	PHOENIX 1 E 21 D	CF GOMMA NO. 204427	
	VIBRACOUSTIC V1E21D	CF GOMMA NO. 204493	
	FIRESTONE 1R1A415-285	GART NO. 286.0.420	
	FIRESTONE W01-095-0197	GART REF. D286	
	GOODYEAR 9013	GART REF. D290	
	GY SPRINGRIDE D11S02	IRISBUS 5000954176	
	IRISBUS 500324098		
		<b>Description</b> Roll	
<hr/>			
Technical Specification	REF. NO.	ŞEM NO.	
	20540789	PHOENIX 1 E 21 B	<b>72.789.R</b>
	21836533	GOODYEAR 9131	
		GOODYEAR 9134	
			<b>Description</b> Roll
<hr/>			
Technical Specification	REF. NO.	ŞEM NO.	
	21836531	PHOENIX 1 E 18 E	<b>72.792.R</b>
	20540792	GOODYEAR 9133	
	21347075	GOODYEAR 9132	
			<b>Description</b> Roll
<hr/>			
Technical Specification	REF. NO.	ŞEM NO.	
Total Weight 10,5 kg	1080707	CONTITECH 810 MB	<b>72.810.C</b>
		PHOENIX 1 D 28 A-2	
		Taurus KR621-26	
		VIBRACOUSTIC V1D28A-2	
		FIRESTONE 1T19L-7	
		FIRESTONE W01-M58-6345	
		FIRESTONE W01-M58-8775	
		GY SPRINGRIDE D13B20	
	GY SPRINGRIDE D13B01	<b>Description</b> Metal Piston	
<hr/>			
Technical Specification	REF. NO.	ŞEM NO.	
Total Weight 2,5 kg	1082085	CONTITECH 883 N1	<b>72.883.R1</b>
		PHOENIX 1 F 21 C-2	
		VIBRACOUSTIC V1F21C-2	
		GOODYEAR 9012	
		GY SPRINGRIDE D13S03	
		CF GOMMA REF. 1SC250-29	
		CF GOMMA NO. 204250	
		Pegaso	







	<b>SEM NO.</b>	<b>REF. NO.</b>	<b>Technical Specification</b>
	<b>72.927.R</b>	3116354 AAU2542	CONTITECH 927 N PHOENIX 2 E 18 B VIBRACOUSTIC V2E18B FIRESTONE 1R1J415-285 Jonckheere FIRESTONE W01-095-0244 GOODYEAR 8037 DUNLOP UK PNP300080100 Dennis 685 2/3
	<b>Description</b>		Total Weight 1,2 kg
	Roll		
	<b>SEM NO.</b>	<b>REF. NO.</b>	<b>Technical Specification</b>
	<b>72.9270.C</b>	85101147	CONTITECH 9 10-13.5 S 433 Aurus 6385 FIRESTONE 1T15VM35 FIRESTONE W01-358-9270 GOODYEAR 1R13-119 GOODYEAR Flex No. 566263053 Automann 1DK23I-9270 Triangle 8433 FleetPride AS9270
	<b>Description</b>		Total Weight 11 kg
	Metal Piston		
	<b>SEM NO.</b>	<b>REF. NO.</b>	<b>Technical Specification</b>
	<b>72.928.R</b>	AAU2544 3116983 10904403	CONTITECH 928 N PHOENIX 2 E 23 A VIBRACOUSTIC V2E23A FIRESTONE 1R1K380-320 FIRESTONE W01-095-0228 MCW X 664 1056 GOODYEAR 8042 GY SPRINGRIDE D12S03
	<b>Description</b>		Total Weight 1,6 kg
	Roll		
	<b>SEM NO.</b>	<b>REF. NO.</b>	<b>Technical Specification</b>
	<b>72.4762.C</b>	20554762 20452138 20479802	Contitech 6613 N P01
	<b>Description</b>		
	Complete With Stell Piston		
	<b>SEM NO.</b>	<b>REF. NO.</b>	<b>Technical Specification</b>
	<b>72.6609.C</b>	1075365 1629782 20452138 20554761	Contitech 6609 N P01
	<b>Description</b>		
	Complete With Stell Piston		







Type / Model	REF. NO.	SEM NO.	
	1075296 1095005	8457	 <p><b>Description</b> Hand Pump</p>
Type / Model	REF. NO.	SEM NO.	
	3943332 8151731	9409	 <p><b>Description</b> Hand Pump</p>
Type / Model	REF. NO.	SEM NO.	
	1571288 1584644 1605627 1606771 1606772 1609552	9410	 <p><b>Description</b> Hand Pump</p>
Type / Model	REF. NO.	SEM NO.	
	1075295 1095004	9411	 <p><b>Description</b> Hand Pump</p>
Type / Model	REF. NO.	SEM NO.	
	20455262 20917279	9414	 <p><b>Description</b> Hand Pump</p>
Type / Model	REF. NO.	SEM NO.	
	20455259 20917278	11656	 <p><b>Description</b> Cabin Pump</p>

	SEM NO.	REF. NO.	Type / Model
	11657	1611186 3943330	
	<b>Description</b> Cabin Pump		



Type / Model	REF. NO.	SEM NO.	
FH 12	20922303	8460	
	20922308		
	3198842		
			<b>Description</b> Cylinder D=Ø60 Ax=677
Type / Model	REF. NO.	SEM NO.	
	1082068	9427	
	1610040		
	1606770		
	1610041		
	1609246		
	1571287		
	1609247		
1584643			
			<b>Description</b> Cylinder
Type / Model	REF. NO.	SEM NO.	
	1075233	9429	
	20452326		
	3944752		
	8141494		
			<b>Description</b> Cylinder
Type / Model	REF. NO.	SEM NO.	
	20922305	9431	
	3198843		
			<b>Description</b> Cylinder
Type / Model	REF. NO.	SEM NO.	
	20409130	11646	
	1075457		
			<b>Description</b> Cabin Cylinder

	SEM NO.	REF. NO.	Type / Model
 D=Ø68 d=Ø30 h=49	8002	1075266 8143460	
<b>Description</b>			
Cabin Bushing			
	SEM NO.	REF. NO.	Type / Model
 D=Ø83 d=Ø52 h=20	8003	8143461	
<b>Description</b>			
Cabin Bushing			
	SEM NO.	REF. NO.	Type / Model
 D=Ø90 d=Ø16 h=70	8282	20390840	
<b>Description</b>			
Cabin Bushing			
	SEM NO.	REF. NO.	Type / Model
 D=Ø40 h=70	9034	1089014	
<b>Description</b>			
Rubber Buffer			
	SEM NO.	REF. NO.	Type / Model
 D=Ø40 d=Ø30 h=28	8128	1629665	
<b>Description</b>			
Cabin Plastic Bushing			
	SEM NO.	REF. NO.	Type / Model
 D=Ø50 d=Ø20 h=38	11666	21333686	
<b>Description</b>			
Rubber Buffer			

<b>Type / Model</b>	<b>REF. NO.</b>	<b>SEM NO.</b>	
	20429148 21333684	<b>11667</b>	
		<b>Description</b>	
		Rubber Buffer	D=Ø65 d=Ø40 h=60
<b>Type / Model</b>	<b>REF. NO.</b>	<b>SEM NO.</b>	
	1075814	<b>11668</b>	
		<b>Description</b>	
		Rondela	D=Ø55 M12
<b>Type / Model</b>	<b>REF. NO.</b>	<b>SEM NO.</b>	
	8141727	<b>11669</b>	
		<b>Description</b>	
		Rubber Buffer	D=Ø50 d=Ø20 h=50
<b>Type / Model</b>	<b>REF. NO.</b>	<b>SEM NO.</b>	
	1629726	<b>11670</b>	
		<b>Description</b>	
		Rubber Buffer	D=Ø50 d=Ø20 h=50
<b>Type / Model</b>	<b>REF. NO.</b>	<b>SEM NO.</b>	
	1096625	<b>11671</b>	
		<b>Description</b>	
		Rubber Buffer	D=Ø50 d=Ø10 h=50
<b>Type / Model</b>	<b>REF. NO.</b>	<b>SEM NO.</b>	
	1075335	<b>11803</b>	
		<b>Description</b>	
		Metal Pin	M28x1,5 L=207

Description / Repair Kit for Cabin	SEM NO.	Model:												
	<b>10241</b>													
	REF. NO: 1075335S	<table border="1"> <thead> <tr> <th>Item No</th> <th>Ref. No</th> </tr> </thead> <tbody> <tr> <td>1</td> <td>1075335</td> </tr> <tr> <td>2</td> <td>8142699</td> </tr> <tr> <td>3</td> <td>8140869</td> </tr> <tr> <td>4</td> <td>1075386</td> </tr> <tr> <td>5</td> <td>1075367</td> </tr> </tbody> </table>	Item No	Ref. No	1	1075335	2	8142699	3	8140869	4	1075386	5	1075367
	Item No	Ref. No												
1	1075335													
2	8142699													
3	8140869													
4	1075386													
5	1075367													

Description / Repair Kit for Cabin	SEM NO.	Model:																		
	<b>11804</b>																			
	REF. NO: 1075335S1	<table border="1"> <thead> <tr> <th>Item No</th> <th>Ref. No</th> </tr> </thead> <tbody> <tr> <td>1</td> <td>1075335</td> </tr> <tr> <td>2</td> <td>8142699</td> </tr> <tr> <td>3</td> <td>8140869</td> </tr> <tr> <td>4</td> <td>1075386</td> </tr> <tr> <td>5</td> <td>1075367</td> </tr> <tr> <td>6</td> <td>----</td> </tr> <tr> <td>7</td> <td>----</td> </tr> <tr> <td>8</td> <td>1629665</td> </tr> </tbody> </table>	Item No	Ref. No	1	1075335	2	8142699	3	8140869	4	1075386	5	1075367	6	----	7	----	8	1629665
	Item No	Ref. No																		
1	1075335																			
2	8142699																			
3	8140869																			
4	1075386																			
5	1075367																			
6	----																			
7	----																			
8	1629665																			

Description / Repair Kit for Cabin	SEM NO.	Model:																					
	<b>8353</b>																						
	REF. NO: 20390840S	<table border="1"> <thead> <tr> <th>Item No</th> <th>Ref. No</th> <th></th> </tr> </thead> <tbody> <tr> <td>1</td> <td>20390840</td> <td>1 Pcs.</td> </tr> <tr> <td>2</td> <td>977173</td> <td>1 Pcs.</td> </tr> <tr> <td>3</td> <td>982613</td> <td>1 Pcs.</td> </tr> <tr> <td>4</td> <td>20466221</td> <td>1 Pcs.</td> </tr> <tr> <td>5</td> <td>955903</td> <td>1 Pcs.</td> </tr> <tr> <td>6</td> <td>981948</td> <td>1 Pcs.</td> </tr> </tbody> </table>	Item No	Ref. No		1	20390840	1 Pcs.	2	977173	1 Pcs.	3	982613	1 Pcs.	4	20466221	1 Pcs.	5	955903	1 Pcs.	6	981948	1 Pcs.
	Item No	Ref. No																					
1	20390840	1 Pcs.																					
2	977173	1 Pcs.																					
3	982613	1 Pcs.																					
4	20466221	1 Pcs.																					
5	955903	1 Pcs.																					
6	981948	1 Pcs.																					





Description / Repair Kit for Cabin	SEM NO.	Model:																					
	<b>8354</b>																						
	REF. NO: 20390840S1	<table border="1"> <thead> <tr> <th>Item No</th> <th>Ref. No</th> <th></th> </tr> </thead> <tbody> <tr> <td>1</td> <td>20390840</td> <td>2 Pcs.</td> </tr> <tr> <td>2</td> <td>977173</td> <td>2 Pcs.</td> </tr> <tr> <td>3</td> <td>982613</td> <td>2 Pcs.</td> </tr> <tr> <td>4</td> <td>20466221</td> <td>2 Pcs.</td> </tr> <tr> <td>5</td> <td>955903</td> <td>2 Pcs.</td> </tr> <tr> <td>6</td> <td>981948</td> <td>2 Pcs.</td> </tr> </tbody> </table>	Item No	Ref. No		1	20390840	2 Pcs.	2	977173	2 Pcs.	3	982613	2 Pcs.	4	20466221	2 Pcs.	5	955903	2 Pcs.	6	981948	2 Pcs.
	Item No	Ref. No																					
1	20390840	2 Pcs.																					
2	977173	2 Pcs.																					
3	982613	2 Pcs.																					
4	20466221	2 Pcs.																					
5	955903	2 Pcs.																					
6	981948	2 Pcs.																					

Model:	SEM NO.	Description / Repair Kit for Cabin
	<b>7969</b>	
	<b>REF. NO:</b>	
	1075266S	
	8143460S1	
<b>Item No</b>	<b>Ref. No</b>	
1	1075399	
2	8142699	
3	8142168	
4	8140869	
5	1629674	
6	1629673	
7	1075400	







Model:	SEM NO.	Description / Repair Kit for Cabin
	<b>7992</b>	
	<b>REF. NO:</b>	
	1075399S	
<b>Item No</b>	<b>Ref. No</b>	
1	1075399	
2	8142699	
3	8142168	
4	8140869	
5	1629674	
6	1629673	
7	1075400	

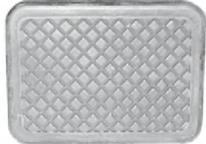









	<b>SEM NO.</b>	<b>REF. NO.</b>	<b>Type / Model</b>
	<b>8481</b>	3172984 1629719 1629724 MONROE CB 0003	FH12 FH16
<b>Description</b>			
Cabin Suspansion Spring With Shock Absorber			
	<b>SEM NO.</b>	<b>REF. NO.</b>	<b>Type / Model</b>
	<b>8485</b>	20427897 20721169 20775212 20889134 MONROE CB 0006	FH12 FH16
<b>Description</b>			
Cabin Suspansion Spring With Shock Absorber			
	<b>SEM NO.</b>	<b>REF. NO.</b>	<b>Type / Model</b>
	<b>8488</b>	1075076 1075077 MONROE CB 0002	FH12 FH16
<b>Description</b>			
Cabin Suspansion Spring With Shock Absorber			
	<b>SEM NO.</b>	<b>REF. NO.</b>	<b>Type / Model</b>
	<b>10814</b>	82052893 20898055 MONROE CB 0118	
<b>Description</b>			
Cabin Suspansion Spring With Shock Absorber			
	<b>SEM NO.</b>	<b>REF. NO.</b>	<b>Type / Model</b>
	<b>10817</b>	20453256 20889132 21111932 20889132-1 MONROE CB0055 MONROE CB0039	FH12
<b>Description</b>			
Cabin Suspansion Spring With Shock Absorber			





Type / Model	REF. NO.	SEM NO.	
	1272021 666176	8280	 <b>Description</b> Pedal Cover 80x60x13
Type / Model	REF. NO.	SEM NO.	
	1576051	8281	 <b>Description</b> Pedal Cover 95x70x18













	<table border="1"> <thead> <tr> <th>SEM NO.</th> <th>REF. NO.</th> </tr> </thead> <tbody> <tr> <td>10896</td> <td>20498623 7420498623</td> </tr> </tbody> </table>	SEM NO.	REF. NO.	10896	20498623 7420498623	<b>Type / Model</b>
SEM NO.	REF. NO.					
10896	20498623 7420498623					
L=175	<b>Description</b> Rubber Strip					
	<table border="1"> <thead> <tr> <th>SEM NO.</th> <th>REF. NO.</th> </tr> </thead> <tbody> <tr> <td>10897</td> <td>1079981</td> </tr> </tbody> </table>	SEM NO.	REF. NO.	10897	1079981	<b>Type / Model</b>
SEM NO.	REF. NO.					
10897	1079981					
L=205	<b>Description</b> Rubber Strip					
	<table border="1"> <thead> <tr> <th>SEM NO.</th> <th>REF. NO.</th> </tr> </thead> <tbody> <tr> <td>10898</td> <td>20552921</td> </tr> </tbody> </table>	SEM NO.	REF. NO.	10898	20552921	<b>Type / Model</b>
SEM NO.	REF. NO.					
10898	20552921					
L=655	<b>Description</b> Rubber Strip					
	<table border="1"> <thead> <tr> <th>SEM NO.</th> <th>REF. NO.</th> </tr> </thead> <tbody> <tr> <td>10899</td> <td>8156556</td> </tr> </tbody> </table>	SEM NO.	REF. NO.	10899	8156556	<b>Type / Model</b>
SEM NO.	REF. NO.					
10899	8156556					
	<b>Description</b> Rubber Strip					

Type / Model	REF. NO.	SEM NO.
FH 12 FH 16	1619106	8386
 <b>Description</b> Pressure Spring 530 MM 150 N		
Type / Model	REF. NO.	SEM NO.
FH 12 FH 16	3981920 8143670	8387
 <b>Description</b> Pressure Spring 410 MM 170 N		
Type / Model	REF. NO.	SEM NO.
FL 7 FL 10 FL 12	1611159	8388
 <b>Description</b> Pressure Spring 810 MM 550 N		
Type / Model	REF. NO.	SEM NO.
FL 12	1083670 1624101	8389
 <b>Description</b> Pressure Spring 610 MM 290 N		
Type / Model	REF. NO.	SEM NO.
	20379348	9716
 <b>Description</b> Pressure Spring 632-263-370N		
Type / Model	REF. NO.	SEM NO.
	20379349	10662
 <b>Description</b> Pressure Spring 632-365-190N.		

SEM NO.	REF. NO.	Type / Model
11022	20541720 20725387	
 <p><b>Description</b> Pressure Spring</p>		
596-50N		
SEM NO.	REF. NO.	Type / Model
11023	8191439	
 <p><b>Description</b> Pressure Spring</p>		
640-200N		
SEM NO.	REF. NO.	Type / Model
11027	20895863	
 <p><b>Description</b> Pressure Spring</p>		
393-170N		

Type / Model	REF. NO.	SEM NO.	
	20443002	8958	
			<b>Description</b> Cabin Latch
Type / Model	REF. NO.	SEM NO.	
	20588325	8992	
			<b>Description</b> Door Lock L
Type / Model	REF. NO.	SEM NO.	
	20588326	8993	
			<b>Description</b> Door Lock R
Type / Model	REF. NO.	SEM NO.	
	20922589	11634	
			<b>Description</b> Pull

	<b>SEM NO.</b> 10039	<b>REF. NO.</b> 3191966	<b>Type / Model</b>
<b>Description</b> Release Lever			
	<b>SEM NO.</b> 11360	<b>REF. NO.</b> 1667058	<b>Type / Model</b> FL 10 FL 12 NL 12 FH 12
<b>Description</b> Release Lever			
	<b>SEM NO.</b> 11742	<b>REF. NO.</b> 3192250	<b>Type / Model</b>
<b>Description</b> Clutch Release Fork			
	<b>SEM NO.</b> 10453	<b>REF. NO.</b> 20806212	<b>Type / Model</b>
<b>Description</b> Bushing			
	<b>SEM NO.</b> 10454	<b>REF. NO.</b> 20851010	<b>Type / Model</b>
<b>Description</b> Seal			
	<b>SEM NO.</b> 10455	<b>REF. NO.</b> 3150319	<b>Type / Model</b>
<b>Description</b> Plastic Bushing			

Type / Model	REF. NO.	SEM NO.	
FL 10 FL 12 NL 12 FH 12	1672000	11361	 <b>Description</b> Release Spindle
	3191966S	10040	 <b>Description</b> Release Lever Repair Kit
	3191966S1	10261	 <b>Description</b> Release Lever Repair Kit
FL 10 FL 12 NL 12 FH 12	1667058S	10785	 <b>Description</b> Release Lever Repair Kit



Ø 1/2"x140/165x0° / 19' LUCK

SEM NO.

12885



REF. NO.

1501311  
1505324

Type / Model

**Description**

Brake Slack Adjuster, Manuel



Ø 1/2"x140/165x0° / 19' LUCK

SEM NO.

12886



REF. NO.

1505325

Type / Model

**Description**

Brake Slack Adjuster, Manuel



Type / Model	REF. NO.	SEM NO.
MRT TYPE	20928564	12223

**Description**  
Pad Wear Indicator



Type / Model	REF. NO.	SEM NO.
MRT TYPE All LRG Series	3092329	10735

**Description**  
Caliper Repair Kit



Type / Model	REF. NO.	SEM NO.
MRT TYPE All LRG Series	3092261	10737

**Description**  
Caliper Repair Kit



Type / Model	REF. NO.	SEM NO.
MRT TYPE LRG 598/599	85102092	10746



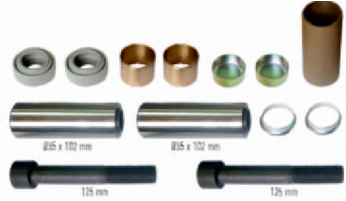



**Description**  
Caliper Repair Kit

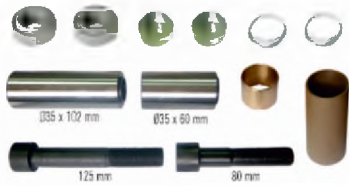



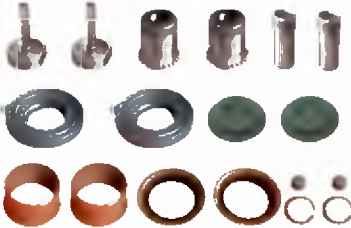



Type / Model	REF. NO.	SEM NO.
MRT TYPE LRG 536, 537, 552, 553, 560, 561, 578, 579, 596, 597, 648, 649, 650, 651, 652, 653	85102094	10747



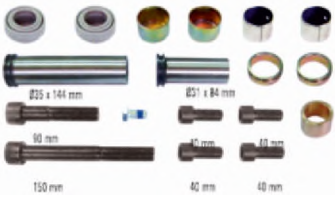





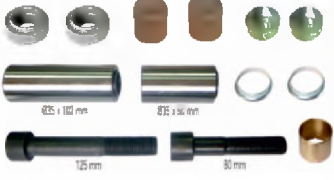

**Description**  
Caliper Repair Kit



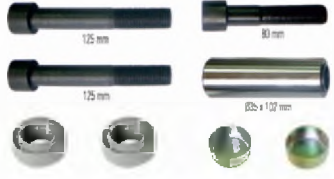









	SEM NO.	REF. NO.	Type / Model
 <p><b>Description</b> Caliper Repair Kit</p>	<b>10748</b>	85107913	MRT TYPE All LRG Series LRG 544, 545, 572, 573, 580, 581, 582, 583, 638, 639, 646, 647, 658, 659, 662, 663, 664, 665, 669, 670, 700, 701, 712, 713, 720, 721, 722, 723, 724, 725, 736, 737, 744, 745, 748, 749, 750, 751
 <p><b>Description</b> Caliper Repair Kit</p>	<b>10749</b>	3092264	MRT TYPE LRG 536, 537, 552, 553, 560, 561, 578, 579, 596, 597, 598, 599, 648, 649, 650, 651, 652, 653
 <p><b>Description</b> Caliper Repair Kit</p>	<b>10750</b>	3092262	MRT TYPE LRG 536, 560, 578, 597, 648, 650, 652
 <p><b>Description</b> Caliper Repair Kit</p>	<b>10751</b>	3092263	MRT TYPE LRG 537, 561, 579, 596, 649, 651, 653
 <p><b>Description</b> Caliper Repair Kit</p>	<b>10752</b>	85102095 3092265	MRT TYPE LRG 536, 560, 578, 597, 648, 650, 652
 <p><b>Description</b> Caliper Repair Kit</p>	<b>10753</b>	85102096 3092266	MRT TYPE LRG 537, 561, 562, 563, 579, 596, 598, 599, 649, 651

Type / Model	REF. NO.	ŞEM NO.	
MRT TYPE LRG 598, 599	85102093	10754	<p><b>Description</b> Caliper Repair Kit</p>
LRG 598, 599	21109755 3092260 85109977	10755	<p><b>Description</b> Caliper Repair Kit</p>
MRT TYPE LRG 578, 579	85109975 3092258	10756	<p><b>Description</b> Caliper Repair Kit</p>
MRT TYPE LRG 578, 579	85109976 21109754 3092259	10757	<p><b>Description</b> Caliper Repair Kit</p>
MRT TYPE LRG 598, 599	3092270	10758	<p><b>Description</b> Caliper Repair Kit</p>
MRT TYPE LRG 536, 537, 578, 579, 596, 597, 652, 653	3095669	10759	<p><b>Description</b> Caliper Repair Kit</p>



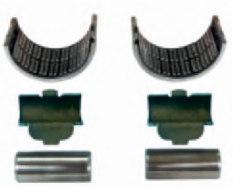

	ŞEM NO.	REF. NO.	Type / Model
	<b>10760</b>	3092269	MRT TYPE LRG 560, 561, 648, 649, 650, 651
<b>Description</b>	Caliper Repair Kit		
	ŞEM NO.	REF. NO.	Type / Model
	<b>10761</b>	85107912	MRT TYPE LRG 544, 545, 572, 573, 580, 581, 582, 583, 638, 639, 646, 647, 658, 659, 662, 663, 700, 701, 712, 713, 722, 723, 744, 745, 748, 749, 750, 751
<b>Description</b>	Caliper Repair Kit		
	ŞEM NO.	REF. NO.	Type / Model
	<b>11813</b>	85109889	MRT TYPE LRG 726, 727, ELSA 195, 225, RADIAL
<b>Description</b>	Caliper Repair Kit		
	ŞEM NO.	REF. NO.	Type / Model
	<b>11841</b>	85109890	MRT TYPE PREMIUM LRG 728, 729, 730, 731, 732, 733, RENAULT PREMIUM 440
<b>Description</b>	Caliper Repair Kit		
	ŞEM NO.	REF. NO.	Type / Model
	<b>12191</b>	 21390376 20534389	MRT TYPE
<b>Description</b>	Pad Wear Indicator		
	ŞEM NO.	REF. NO.	Type / Model
	<b>12251</b>	 21390372 20928356	KN TYPE All SB..., SN... Series
<b>Description</b>	Pad Wear Indicator		

Type / Model	REF. NO.		ŞEM NO.	
MRT TYPE  LRG 536, 537, 552, 553, 560, 561, 578, 579, 596, 597, 598, 599, 648, 649, 650, 651, 652, 653			<b>12286</b>	 <p><b>Description</b> Caliper Repair Kit</p>
MRT TYPE LRG 598/599	85103891		<b>12287</b>	 <p><b>Description</b> Caliper Repair Kit</p>
MRT TYPE LRG 536, 537, 552, 553, 560, 561, 578, 579, 596, 597, 598, 599, 648, 649, 650, 651, 652, 653	3095628 3096769 85107718		<b>12288</b>	 <p><b>Description</b> Caliper Repair Kit</p>
MRT TYPE D DUCO	3095626		<b>12305</b>	 <p><b>Description</b> Caliper Repair Kit</p>
MRT TYPE All LRG Series	20706975		<b>12450</b>	 <p><b>Description</b> Caliper Repair Kit</p>
MRT TYPE FH	20928533 20442608 20392985		<b>12462</b>	 <p><b>Description</b> Pad Wear Indicator (Front)</p>



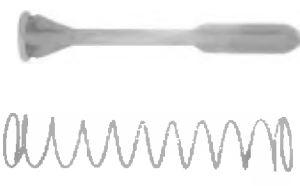

SEM NO.		REF. NO.	Type / Model
12463		20928532 20442607	MRT TYPE FH
 <p><b>Description</b> Pad Wear Indicator (Back)</p>			
SEM NO.		REF. NO.	Type / Model
12467		20928541 20526767	MRT TYPE
 <p><b>Description</b> Pad Wear Indicator</p>			
SEM NO.		REF. NO.	Type / Model
12468		21390374 20928539	MRT TYPE
 <p><b>Description</b> Pad Wear Indicator</p>			
SEM NO.		REF. NO.	Type / Model
12469		21390375 20928544	MRT TYPE
 <p><b>Description</b> Pad Wear Indicator</p>			
SEM NO.		REF. NO.	Type / Model
12476		21390373 20928537	
 <p><b>Description</b> Pad Wear Indicator</p>			
SEM NO.		REF. NO.	Type / Model
12477		20928563	
 <p><b>Description</b> Pad Wear Indicator</p>			

Type / Model	REF. NO.		SEM NO.	
MRT TYPE LRG 726, 727, 728, 729, 730, 731, 732, 733	85109892		12481	<p><b>Description</b> Caliper Repair Kit</p>
	20928547 20554506		12484	<p><b>Description</b> Pad Wear Indicator</p>
MRT TYPE LRG 726, 727, 728, 729, 730, 731, 732, 733	85109893		12490	<p><b>Description</b> Caliper Repair Kit</p>
MRT TYPE All LRG Series	68323746PK10		12495	<p><b>Description</b> Pad Wear Indicator</p>
MRT TYPE D LISA, LRG 548, 549, 550, 551, 564, 565, 592, 593, 630, 631	3098108		12507	<p><b>Description</b> Caliper Repair Kit</p>
MRT TYPE D LISA	8550881		12508	<p><b>Description</b> Caliper Repair Kit</p>

	SEM NO.		REF. NO.	Type / Model
	12511		3098111	MRT TYPE LRG 548, 550, 554, 564, 592, 630
	<b>Description</b> Caliper Repair Kit			
	12512		3098111	MRT TYPE LRG 549, 551, 554, 565, 593, 631
	<b>Description</b> Caliper Repair Kit			
	12523		3098113	MRT TYPE LRG 548, 549, 550, 551
	<b>Description</b> Caliper Repair Kit			
	12306		3092283	MRT TYPE LRG 536, 537, 552, 553, 560, 561, 578, 579, 596, 597, 598, 599, 648, 649, 650, 651, 652, 653
	<b>Description</b> Caliper Repair Kit			

## 6.4.6

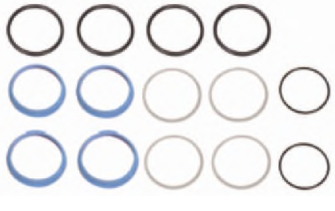
Clutch and Brake Group  
Caliper Group / HYDRAULIC Type

	SEM NO.		REF. NO.	Type / Model
	12727		11994196 6212908	HYDRAULIC TYPE
	<b>Description</b> Caliper Repair Kit			
	12728		6211532	HYDRAULIC TYPE
	<b>Description</b> Caliper Repair Kit			





Type / Model	REF. NO.		SEM NO.	
HYDRAULIC TYPE	6213565		12729	<p><b>Description</b> Caliper Repair Kit</p>
HYDRAULIC TYPE LRG 500, 501, 502, 503, 504, 505, 508, 509, 518, 519, 534, 535	270527 3090937		12730	<p><b>Description</b> Caliper Repair Kit</p>
HYDRAULIC TYPE LRG 502, 503, 504, 505	270531 3090938		12731	<p><b>Description</b> Caliper Repair Kit</p>
HYDRAULIC TYPE LRG 601, 602, 603, 608, 609, 610, 611, 628, 629, 634, 635	3090940		12734	<p><b>Description</b> Caliper Repair Kit</p>
HYDRAULIC TYPE LRG 500, 501, 502, 503, 504, 505, 508, 509, 512, 513, 514, 518, 519, 534, 535, 568, 569, 600, 601, 602, 603, 608, 609, 610, 611, 620, 621, 628, 629, 634, 635	3090851		12735	<p><b>Description</b> Caliper Repair Kit</p>
HYDRAULIC TYPE	271163 3090356 3090939		12739	<p><b>Description</b> Caliper Repair Kit</p>







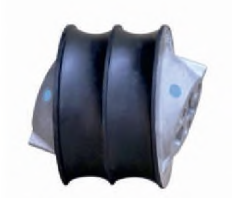

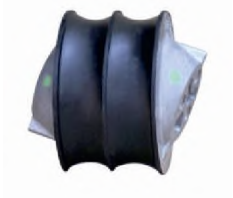
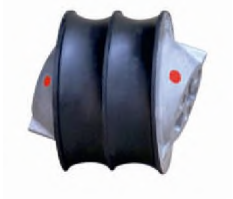
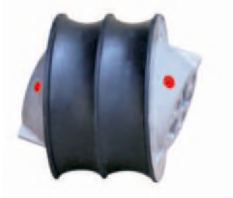
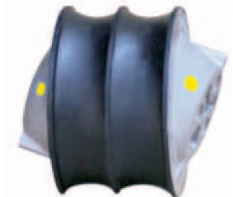
# SCANIA GROUP



Engine and Transmission Group .....	:	664 - 688
Steering Group .....	:	689 - 696
Suspension Group .....	:	697 - 731
Cab Group .....	:	732 - 755
Axle / Differential ve Shaft Group.....	:	-
Clutch and Brake Group.....	:	756 - 761

	SEM NO.	REF. NO.	Type / Model
 D=Ø110 h=120	8132	1469277	
	<b>Description</b>		
	Engine Mounting (Blue)		
 D=Ø110 h=120	8133	1475868 1423012 1371729	
	<b>Description</b>		
	Engine Mounting (Yellow)		
 D=Ø110 h=120	8176	1496288 1423011	
	<b>Description</b>		
	Engine Mounting (Green)		
 D=Ø110 h=120	8177	1496749	
	<b>Description</b>		
	Engine Mounting (Red)		
 D=Ø110 h=120	10217	1778532	
	<b>Description</b>		
	Engine Mounting (Red White)		
 D=Ø110 h=120	10218	1778529	
	<b>Description</b>		
	Engine Mounting (Yellow White)		

Type / Model	REF. NO.	SEM NO.	
	1778530 1336885	10219	 <b>Description</b> Engine Mounting (Green White)  D=Ø110 h=120
Type / Model	REF. NO.	SEM NO.	
	1371725 1336882	8245	 <b>Description</b> Engine Mounting
Type / Model	REF. NO.	SEM NO.	
	0364833 364833 0278599 278599	8246	 <b>Description</b> Engine Mounting
Type / Model	REF. NO.	SEM NO.	
	1921972 1782203 1779609 1469287	 11760	 <b>Description</b> Engine Mounting
Type / Model	REF. NO.	SEM NO.	
	137207 332708	8337	 <b>Description</b> Engine Mounting  D=Ø100 h=66 M12x1,75

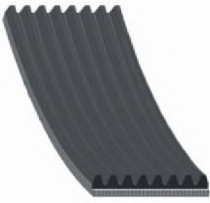
	SEM NO.	REF. NO.	Type / Model
	10320 (10322)	1389066 1531241	
	<b>Description</b>		V Ribbed Belt

8PK1220

	SEM NO.	REF. NO.	Type / Model
	11684	1800523	
	<b>Description</b>		V Ribbed Belt

8PK1255

	SEM NO.	REF. NO.	Type / Model
	10336 (10338)	1530987 1389016 1800543	
	<b>Description</b>		V Ribbed Belt

8PK1480

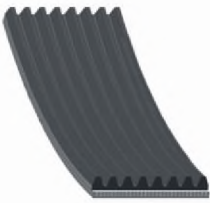
	SEM NO.	REF. NO.	Type / Model
	10339 (10340)	1519788 1530973 1800535 1389049 1354390 1376316	
	<b>Description</b>		V Ribbed Belt

8PK1515

	SEM NO.	REF. NO.	Type / Model
	12894 	1389036 1800535 1530989	
	<b>Description</b>		V Ribbed Belt

8PK1525

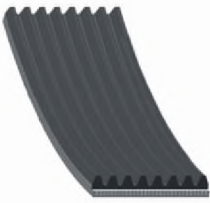
	SEM NO.	REF. NO.	Type / Model
	10341	1888464 1454281 1800522 1389029 1389012	
	<b>Description</b>		V Ribbed Belt

8PK1538

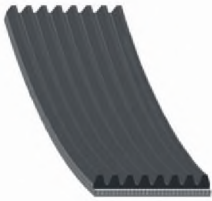
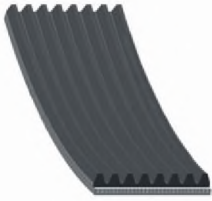
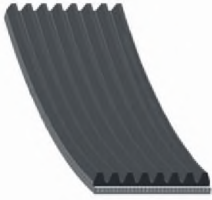
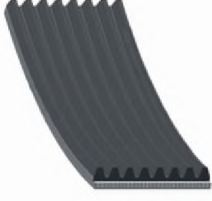
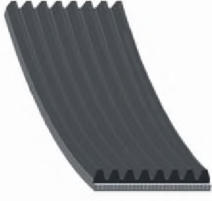
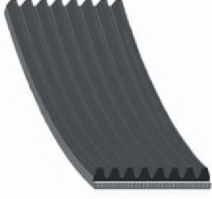
<b>Type / Model</b>	<b>REF. NO.</b>	<b>SEM NO.</b>	
	1389001 1389043 1530981 1800539	<b>10342</b> (10343)	
		<b>Description</b>	
		V Ribbed Belt	8PK1580
<b>Type / Model</b>	<b>REF. NO.</b>	<b>SEM NO.</b>	
	1888465 1389059 1514865	<b>10350</b> (10351)	
		<b>Description</b>	
		V Ribbed Belt	8PK1795
<b>Type / Model</b>	<b>REF. NO.</b>	<b>SEM NO.</b>	
	1389015 1800528 1501201	<b>10352</b> (10354)	
		<b>Description</b>	
		V Ribbed Belt	8PK1852
<b>Type / Model</b>	<b>REF. NO.</b>	<b>SEM NO.</b>	
	1888463 1454280	<b>10360</b> (10361)	
		<b>Description</b>	
		V Ribbed Belt	8PK1988
<b>Type / Model</b>	<b>REF. NO.</b>	<b>SEM NO.</b>	
	1920232	<b>12896</b>	
		<b>Description</b>	
		V Ribbed Belt	8PK2020
<b>Type / Model</b>	<b>REF. NO.</b>	<b>SEM NO.</b>	
	1371531 1389041 1530974 1371532 1800537	<b>10365</b> (10366)	
		<b>Description</b>	
		V Ribbed Belt	8PK2050

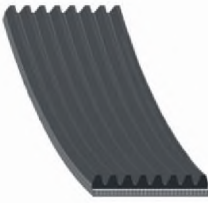

	SEM NO.	REF. NO.	Type / Model
	<b>10367</b> (10368)	1888470 1530982 1800540	
	<b>Description</b>		V Ribbed Belt

8PK2063

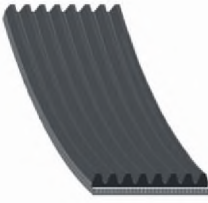
	SEM NO.	REF. NO.	Type / Model
	<b>11690</b>	1530984 1389058 1888471 1800541	
	<b>Description</b>		V Ribbed Belt

8PK2085

	SEM NO.	REF. NO.	Type / Model
	<b>10371</b>	1389048 1354391 1888467 1490819 1888468	
	<b>Description</b>		V Ribbed Belt

8PK2130

	SEM NO.	REF. NO.	Type / Model
	<b>12897</b> 	1389034 1389031 1389020 1803333 1530979	
	<b>Description</b>		V Ribbed Belt



8PK2215

	SEM NO.	REF. NO.	Type / Model
	<b>11691</b>	1768720	
	<b>Description</b>		V Ribbed Belt

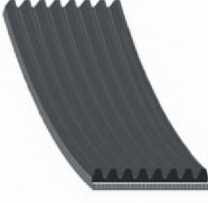
8PK2275

	SEM NO.	REF. NO.	Type / Model
	<b>10372</b> (10374)	1490821 1800527	
	<b>Description</b>		V Ribbed Belt

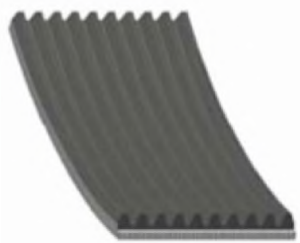
8PK2380

Type / Model	REF. NO.	SEM NO.	
	1779745	11701	 <p><b>Description</b> V Ribbed Belt</p> <p>10PK2070</p>
	814187	12901	 <p><b>Description</b> V Ribbed Belt</p> <p>2XAVX13X1025</p>





SEM NO.

12143



REF. NO.

1321876

Type / Model

**Description**

Blade, Fan



SEM NO.

12142









REF. NO.







1480770  
1321877







Type / Model

**Description**

Visco Drive, Fan

Type / Model	REF. NO.	SEM NO.	
CT 113	318350	8427	 <p><b>Description</b> Radiator Hose</p> <p>d=Ø55 d=Ø55 h=740</p>
CT 113	313134	8428	 <p><b>Description</b> Radiator Hose</p> <p>d=Ø15 d=Ø15 h=210</p>
N 113	380514	8429	 <p><b>Description</b> Radiator Hose</p> <p>d=Ø28 d=Ø32 h=510</p>
CR 143	371074	8430	 <p><b>Description</b> Radiator Hose</p> <p>d=Ø32 d=Ø42 h=260</p>
CT 93	1377997	8431	 <p><b>Description</b> Radiator Hose</p> <p>d=Ø50 d=Ø55 h=560</p>
DC 9	298829	8432	 <p><b>Description</b> Radiator Hose</p> <p>d=Ø55 d=Ø55 h=355</p>

	<table border="1"> <thead> <tr> <th>SEM NO.</th> <th>REF. NO.</th> <th>Type / Model</th> </tr> </thead> <tbody> <tr> <td>8433</td> <td>297394</td> <td>CT 143</td> </tr> </tbody> </table>	SEM NO.	REF. NO.	Type / Model	8433	297394	CT 143	<p><b>Description</b> Radiator Hose</p>						
SEM NO.	REF. NO.	Type / Model												
8433	297394	CT 143												
d=Ø55 d=Ø55 h=120														
	<table border="1"> <thead> <tr> <th>SEM NO.</th> <th>REF. NO.</th> <th>Type / Model</th> </tr> </thead> <tbody> <tr> <td>8514</td> <td>1449431</td> <td>CR 144</td> </tr> <tr> <td></td> <td>1376293</td> <td>CR 164</td> </tr> <tr> <td></td> <td>1394522</td> <td>GRS900 R</td> </tr> </tbody> </table>	SEM NO.	REF. NO.	Type / Model	8514	1449431	CR 144		1376293	CR 164		1394522	GRS900 R	<p><b>Description</b> Radiator Hose</p>
SEM NO.	REF. NO.	Type / Model												
8514	1449431	CR 144												
	1376293	CR 164												
	1394522	GRS900 R												
55x55x580														
	<table border="1"> <thead> <tr> <th>SEM NO.</th> <th>REF. NO.</th> <th>Type / Model</th> </tr> </thead> <tbody> <tr> <td>8515</td> <td>1377231</td> <td>CR 144 GRS900 R</td> </tr> </tbody> </table>	SEM NO.	REF. NO.	Type / Model	8515	1377231	CR 144 GRS900 R	<p><b>Description</b> Radiator Hose</p>						
SEM NO.	REF. NO.	Type / Model												
8515	1377231	CR 144 GRS900 R												
56x56x440														
	<table border="1"> <thead> <tr> <th>SEM NO.</th> <th>REF. NO.</th> <th>Type / Model</th> </tr> </thead> <tbody> <tr> <td>8516</td> <td>1426194</td> <td>CR 144</td> </tr> <tr> <td></td> <td>1375874</td> <td>CR 164 GRS900 R</td> </tr> </tbody> </table>	SEM NO.	REF. NO.	Type / Model	8516	1426194	CR 144		1375874	CR 164 GRS900 R	<p><b>Description</b> Radiator Hose</p>			
SEM NO.	REF. NO.	Type / Model												
8516	1426194	CR 144												
	1375874	CR 164 GRS900 R												
31x34x410														
	<table border="1"> <thead> <tr> <th>SEM NO.</th> <th>REF. NO.</th> <th>Type / Model</th> </tr> </thead> <tbody> <tr> <td>8577</td> <td>1529007</td> <td>CR 114 CR 124</td> </tr> </tbody> </table>	SEM NO.	REF. NO.	Type / Model	8577	1529007	CR 114 CR 124	<p><b>Description</b> Radiator Hose</p>						
SEM NO.	REF. NO.	Type / Model												
8577	1529007	CR 114 CR 124												
54x54x640														
	<table border="1"> <thead> <tr> <th>SEM NO.</th> <th>REF. NO.</th> <th>Type / Model</th> </tr> </thead> <tbody> <tr> <td>8578</td> <td>1376895</td> <td>CR 164</td> </tr> </tbody> </table>	SEM NO.	REF. NO.	Type / Model	8578	1376895	CR 164	<p><b>Description</b> Radiator Hose</p>						
SEM NO.	REF. NO.	Type / Model												
8578	1376895	CR 164												
10x10x540														

Type / Model	REF. NO.	SEM NO.	
CR 164	1376896	8579	 <b>Description</b> Radiator Hose 10x10x685
CP DSC 11 75 75 79	1385086	8590	 <b>Description</b> Radiator Hose 55x55x410
CP DSC 11 75 75 79	1395066 1384464	8591	 <b>Description</b> Radiator Hose 55x55x420
CP CR114 124	1370488 1797845	9558	 <b>Description</b> Breather Hose 56x56x270
CR 164	1511620 1494718 1422498	9559	 <b>Description</b> Radiator Hose 55x55x510
GR GRS 900	1380106 1854058	9560	 <b>Description</b> Radiator Hose 56x56x390

	SEM NO.	REF. NO.	Type / Model
 <b>Description</b> Radiator Hose 30x30x850	<b>9561</b>	1380621 1448384 1531776 1545116	CR 164

	SEM NO.	REF. NO.	Type / Model
 <b>Description</b> Radiator Hose 55x55x415	<b>9562</b>	486819	L94 DSC9 Dc9







	SEM NO.	REF. NO.	Type / Model
 <b>Description</b> Radiator Hose 55x55x360	<b>9563</b>	481886	L94 DSC9

	SEM NO.	REF. NO.	Type / Model
 <b>Description</b> Radiator Hose 55x49x495	<b>9564</b>	485995	ZF K94

	SEM NO.	REF. NO.	Type / Model
 <b>Description</b> Radiator Hose 9x9x600	<b>9575</b>	1886819	CR D9 11 12

	SEM NO.	REF. NO.	Type / Model
 <b>Description</b> Radiator Hose 55x55x670	<b>9576</b>	1755951 1446229	CR D9 11 12



Type / Model	REF. NO.	ŞEM NO.	
CR D9 11 12	1755956 1514108	<b>9577</b>	 <b>Description</b> Radiator Hose 19x19x305
CR D9 11 12	1755953 1446228	<b>10579</b>	 <b>Description</b> Radiator Hose 56x56x445
Ct124 GR GRS900	1496815 1447198	<b>10580</b>	 <b>Description</b> Radiator Hose 56x56x630
CR D9 11 12	1444948	<b>10581</b>	 <b>Description</b> Radiator Hose 32x32x405
CP D9 PDE 11 12	1755954 1733734	<b>10582</b>	 <b>Description</b> Radiator Hose 25x31x75
CG CR D9 11 12	1733735 1733741 1883423 1790071 1790072	<b>10583</b>	 <b>Description</b> Radiator Hose 20x25x20x32

SEM NO.	REF. NO.	Type / Model
10584	1376949	CR 144 CP 124
<b>Description</b> Expansion Tank Hose		
18x31x31		



SEM NO.	REF. NO.	Type / Model
10585	1375390	PR CA B4x4
<b>Description</b> Oil Hose		
22x28x135		



SEM NO.	REF. NO.	Type / Model
11091	1444944	CP D9PDE 11 12
<b>Description</b> Radiator Upper Hose		
55x55x620		



SEM NO.	REF. NO.	Type / Model
11092	1802618 1759415	Dc9 11 12
<b>Description</b> Water Cooling Hose		
55x55x512		















SEM NO.	REF. NO.	Type / Model
11093	1778326	CG/CR D9 11 12
<b>Description</b> Radiator Hose		
56x56x630		















SEM NO.	REF. NO.	Type / Model
11094	1514110	CR D9 11 12
<b>Description</b> Termostad Hose		
20x20x200		















Type / Model	REF. NO.	SEM NO.	
PR CA/B4x4	1375391	11095	 <p><b>Description</b> Water Tank Hose</p> <p>15x21x118</p>
GRSOH901R	318364	11096	 <p><b>Description</b> Water Cooling Hose</p> <p>57x57x295</p>
GRSH900R	1377566	11097	 <p><b>Description</b> Water Cooling Hose</p> <p>56x56x238</p>
CR,D9/11/12	1446221	11098	 <p><b>Description</b> Radiator Hose</p> <p>10x10x600</p>
CR,D9/11/12	1514111	11099	 <p><b>Description</b> Radiator Hose</p> <p>20x20x282</p>
GRS900R	1797962	11100	 <p><b>Description</b> Radiator Hose</p> <p>57x57x550</p>







	<table border="1"> <thead> <tr> <th>SEM NO.</th> <th>REF. NO.</th> <th>Type / Model</th> </tr> </thead> <tbody> <tr> <td>11101</td> <td>1422499</td> <td>Cr164</td> </tr> </tbody> </table>	SEM NO.	REF. NO.	Type / Model	11101	1422499	Cr164	<p><b>Description</b> Radiator Hose</p>
SEM NO.	REF. NO.	Type / Model						
11101	1422499	Cr164						
56x465								
	<table border="1"> <thead> <tr> <th>SEM NO.</th> <th>REF. NO.</th> <th>Type / Model</th> </tr> </thead> <tbody> <tr> <td>11102</td> <td>1763340</td> <td>GRSOH901R</td> </tr> </tbody> </table>	SEM NO.	REF. NO.	Type / Model	11102	1763340	GRSOH901R	<p><b>Description</b> Oil Cooling Hose</p>
SEM NO.	REF. NO.	Type / Model						
11102	1763340	GRSOH901R						
56x56x390								
	<table border="1"> <thead> <tr> <th>SEM NO.</th> <th>REF. NO.</th> <th>Type / Model</th> </tr> </thead> <tbody> <tr> <td>11103</td> <td>1377567</td> <td>GRS890R GR/GRS900R</td> </tr> </tbody> </table>	SEM NO.	REF. NO.	Type / Model	11103	1377567	GRS890R GR/GRS900R	<p><b>Description</b> Water Cooling Hose</p>
SEM NO.	REF. NO.	Type / Model						
11103	1377567	GRS890R GR/GRS900R						
56x56x210								
	<table border="1"> <thead> <tr> <th>SEM NO.</th> <th>REF. NO.</th> <th>Type / Model</th> </tr> </thead> <tbody> <tr> <td>11104</td> <td>1377331</td> <td>CR CP124</td> </tr> </tbody> </table>	SEM NO.	REF. NO.	Type / Model	11104	1377331	CR CP124	<p><b>Description</b> Radiator Hose</p>
SEM NO.	REF. NO.	Type / Model						
11104	1377331	CR CP124						
56x56x500								
	<table border="1"> <thead> <tr> <th>SEM NO.</th> <th>REF. NO.</th> <th>Type / Model</th> </tr> </thead> <tbody> <tr> <td>11105</td> <td>1446227</td> <td>CR D9/11/12</td> </tr> </tbody> </table>	SEM NO.	REF. NO.	Type / Model	11105	1446227	CR D9/11/12	<p><b>Description</b> Radiator Hose</p>
SEM NO.	REF. NO.	Type / Model						
11105	1446227	CR D9/11/12						
10x10x620								
	<table border="1"> <thead> <tr> <th>SEM NO.</th> <th>REF. NO.</th> <th>Type / Model</th> </tr> </thead> <tbody> <tr> <td>11106</td> <td>1376295</td> <td>CR D9/11/12</td> </tr> </tbody> </table>	SEM NO.	REF. NO.	Type / Model	11106	1376295	CR D9/11/12	<p><b>Description</b> Expansion Tank Hose</p>
SEM NO.	REF. NO.	Type / Model						
11106	1376295	CR D9/11/12						
32x32x80								













Type / Model	REF. NO.	ŞEM NO.	
P,G,R,T	2010515 1446379	11719	 <b>Description</b> Radiator Hose 56x56x580
CT 143	0561408	11720	 <b>Description</b> Water Hose 10x10x1020
DC 9	278474	11721	 <b>Description</b> Radiator Hose 57x57x240
Dc16	1493708	11722	 <b>Description</b> Radiator Hose 57x57x240
CP DC9	1517770	11723	 <b>Description</b> Radiator Lower Hose 56x475
D 14	1375603	11724	 <b>Description</b> Oil Cooler Hose 45x45x200

	<table border="1"> <thead> <tr> <th>SEM NO.</th> <th>REF. NO.</th> <th>Type / Model</th> </tr> </thead> <tbody> <tr> <td>11725</td> <td>1375604</td> <td>D 14</td> </tr> </tbody> </table>	SEM NO.	REF. NO.	Type / Model	11725	1375604	D 14	<p><b>Description</b> Water Cooling Hose</p>
SEM NO.	REF. NO.	Type / Model						
11725	1375604	D 14						
45x44x105								
	<table border="1"> <thead> <tr> <th>SEM NO.</th> <th>REF. NO.</th> <th>Type / Model</th> </tr> </thead> <tbody> <tr> <td>11914</td> <td>1373918</td> <td></td> </tr> </tbody> </table>	SEM NO.	REF. NO.	Type / Model	11914	1373918		<p><b>Description</b> Radiator Hose</p>
SEM NO.	REF. NO.	Type / Model						
11914	1373918							
56x56x450								
	<table border="1"> <thead> <tr> <th>SEM NO.</th> <th>REF. NO.</th> <th>Type / Model</th> </tr> </thead> <tbody> <tr> <td>11915</td> <td>1391380</td> <td></td> </tr> </tbody> </table>	SEM NO.	REF. NO.	Type / Model	11915	1391380		<p><b>Description</b> Expansion Tank Hose</p>
SEM NO.	REF. NO.	Type / Model						
11915	1391380							
32x32x1600								
	<table border="1"> <thead> <tr> <th>SEM NO.</th> <th>REF. NO.</th> <th>Type / Model</th> </tr> </thead> <tbody> <tr> <td>11916</td> <td>1391796</td> <td></td> </tr> </tbody> </table>	SEM NO.	REF. NO.	Type / Model	11916	1391796		<p><b>Description</b> Expansion Tank Hose</p>
SEM NO.	REF. NO.	Type / Model						
11916	1391796							
31x31x412								
	<table border="1"> <thead> <tr> <th>SEM NO.</th> <th>REF. NO.</th> <th>Type / Model</th> </tr> </thead> <tbody> <tr> <td>11917</td> <td>1341729</td> <td></td> </tr> </tbody> </table>	SEM NO.	REF. NO.	Type / Model	11917	1341729		<p><b>Description</b> Radiator Hose</p>
SEM NO.	REF. NO.	Type / Model						
11917	1341729							
56x56x550								
	<table border="1"> <thead> <tr> <th>SEM NO.</th> <th>REF. NO.</th> <th>Type / Model</th> </tr> </thead> <tbody> <tr> <td>11918</td> <td>1516785</td> <td></td> </tr> </tbody> </table>	SEM NO.	REF. NO.	Type / Model	11918	1516785		<p><b>Description</b> Radiator Hose</p>
SEM NO.	REF. NO.	Type / Model						
11918	1516785							
56x510								

<b>Type / Model</b>	<b>REF. NO.</b>		<b>SEM NO.</b>	
	1373919		<b>11919</b>	
			<b>Description</b>	
			Thermostat Hose	
				56x56x34
<b>Type / Model</b>	<b>REF. NO.</b>		<b>SEM NO.</b>	
	1521421		<b>11920</b>	
			<b>Description</b>	
			Crankcase Breather Hose	
				10x18x108
<b>Type / Model</b>	<b>REF. NO.</b>		<b>SEM NO.</b>	
	1521422		<b>11921</b>	
			<b>Description</b>	
			Crankcase Breather Hose	
				16x16x375
<b>Type / Model</b>	<b>REF. NO.</b>		<b>SEM NO.</b>	
	1383873		<b>11922</b>	
			<b>Description</b>	
			Radiator Hose	
				10x10x197
<b>Type / Model</b>	<b>REF. NO.</b>		<b>SEM NO.</b>	
	1393856		<b>11923</b>	
			<b>Description</b>	
			Radiator Hose	
				56x56x690
<b>Type / Model</b>	<b>REF. NO.</b>		<b>SEM NO.</b>	
	1876631		<b>11924</b>	
			<b>Description</b>	
			Water Cooling Hose	
				56x56x350



	SEM NO.		REF. NO.	Type / Model
 55x55x555 <b>Description</b> Radiator Hose	11925		1376294	
 55x55x570 <b>Description</b> Radiator Hose	11926		1449828	
 56x56x835 <b>Description</b> Radiator Hose	11927		1351081	
 55x55x585 <b>Description</b> Radiator Hose	11928		1497243	
 56x56x455 <b>Description</b> Radiator Hose	11929		486033	
 56x56x498 <b>Description</b> Radiator Hose	11930		387993	

<b>Type / Model</b>	<b>REF. NO.</b>		<b>SEM NO.</b>	
	1375601		<b>11931</b>	
			<b>Description</b>	
			Water Cooling Hose	
				44x44x297
<b>Type / Model</b>	<b>REF. NO.</b>		<b>SEM NO.</b>	
	1375859		<b>11932</b>	
			<b>Description</b>	
			Radiator Hose	
				56x56x185
<b>Type / Model</b>	<b>REF. NO.</b>		<b>SEM NO.</b>	
	1374040		<b>11933</b>	
			<b>Description</b>	
			Radiator Hose	
				56x56x440
<b>Type / Model</b>	<b>REF. NO.</b>		<b>SEM NO.</b>	
	301789		<b>11934</b>	
			<b>Description</b>	
			Thermostat Hose	
				55x55x470
<b>Type / Model</b>	<b>REF. NO.</b>		<b>SEM NO.</b>	
	1340201		<b>11935</b>	
			<b>Description</b>	
			Radiator Hose	
				56x56x330
<b>Type / Model</b>	<b>REF. NO.</b>		<b>SEM NO.</b>	
	1376291		<b>11936</b>	
			<b>Description</b>	
			Radiator Hose	
				56x56x475



SEM NO.

11937



REF. NO.







1383990

Type / Model

**Description**

Radiator Hose

55x55x1135



Type / Model	REF. NO.	SEM NO.	
BLACK RED	488368 1470040	8870	 <p><b>Description</b> Silicon Hose</p> <p>D:Ø90 mm L:140 mm 1 HUMP</p>
BLACK RED	1794725 1809771 1442579 1358202 1522011 1522010	8871	 <p><b>Description</b> Silicon Hose</p> <p>D:Ø80 mm L:182 mm 5 HUMP</p>
BLUE	412080	11212	 <p><b>Description</b> Silicon Hose</p> <p>Ø55X110X110</p>
GREY	2057832 1525145	11213	 <p><b>Description</b> Silicon Hose</p> <p>Ø80X180 6 HUMP</p>
RED	312646	11214	 <p><b>Description</b> Silicon Hose</p> <p>Ø90X103</p>
RED	375527	11215	 <p><b>Description</b> Silicon Hose</p> <p>Ø75X65</p>

	SEM NO.	REF. NO.	Type / Model
 Ø65X78X90	11216	452663	BLUE
	<b>Description</b> Silicon Hose		

	SEM NO.	REF. NO.	Type / Model
 Ø 50X50	11217	350572 325244	BLACK
	<b>Description</b> Silicon Hose		

	SEM NO.	REF. NO.	Type / Model
 Ø 56X280 17 HUMP	11218	1375718 1315195 290849 368559	GREY
	<b>Description</b> Silicon Hose		

	SEM NO.	REF. NO.	Type / Model
 Ø 90X140 3 HUMP	11219	390581 325699 325814 326712 525050	BLUE
	<b>Description</b> Silicon Hose		

Type / Model	REF. NO.	SEM NO.	
	391555	8112	 <p><b>Description</b> Rubber Metal Buffer</p> <p>105,5x106</p>
Type / Model	REF. NO.	SEM NO.	
	1363634	8275	 <p><b>Description</b> Rubber Metal Mounting</p> <p>48x110x35</p>

	SEM NO.	REF. NO.	Type / Model
	10917	182931	
	<b>Description</b>		
	Ring		
31x6,5			







	SEM NO.	REF. NO.	Type / Model
	10918	182929	
	<b>Description</b>		
	Ring		
23x6,2			

Engine and Transmission Group  
Transmission & Gear Box Products







	SEM NO.	REF. NO.	Type / Model
	10963	1391830	
	<b>Description</b>		
	Plastic Bearing		
d=Ø16 L=30			







	SEM NO.	REF. NO.	Type / Model
	10964	1391831	
	<b>Description</b>		
	Rubber Bush		
d=Ø16 L=8,5			







	SEM NO.	REF. NO.	Type / Model
	10965	1391830S 1391831S	
	<b>Description</b>		
	Repair Kit		
			10963 - 2 Pcs 10964 - 2 Pcs



Type / Model	REF. NO.	ŞEM NO.	
	0421573 421573	8330	
			<b>Description</b> Tie Rod L 1123 mm M30x1,5 M24x1,5 K 30
Type / Model	REF. NO.	ŞEM NO.	
	0390784 390784	8331	
			<b>Description</b> Tie Rod L 888 mm M30x1,5 M24x1,5 K 30
Type / Model	REF. NO.	ŞEM NO.	
	1384027 1769597 1912758 1847312 1379072	9329	
			<b>Description</b> Tie Rod L=1059 koni=30 boru=32
Type / Model	REF. NO.	ŞEM NO.	
8682-1	1384025 1379071 1768898 1356055 1912757 1847311	9336	
			<b>Description</b> Tie Rod L=1054 koni=30 boru=62
Type / Model	REF. NO.	ŞEM NO.	
	1385251 1409918 1379168 1897335 1723895 1737683 1501030 1369411	9337	
			<b>Description</b> Tie Rod L=1743 koni=30 boru=50
Type / Model	REF. NO.	ŞEM NO.	
	278665 278666	10124	
			<b>Description</b> Tie Rod L 940 mm



	SEM NO.	REF. NO.	Type / Model
 L 912 mm	<b>10126</b>	1304569 1369919 370875	
	<b>Description</b>		Tie Rod
 L 1743 mm	<b>10127</b>	1361413 1395614 1734019 1897333 2040254	
	<b>Description</b>		Tie Rod
 L 578 mm	<b>10128</b>	1369917 300308 382774	
	<b>Description</b>		Tie Rod
 L 100 mm	<b>10129</b>	445626 1766015	
	<b>Description</b>		Stabilizer Rot
 L 284 mm	<b>10130</b>	483527 1789082 1455327 1751418 1928859	
	<b>Description</b>		Stabilizer Rot
 L 433 mm	<b>10131</b>	1394884	
	<b>Description</b>		Tie Rod

Type / Model	REF. NO.	SEM NO.	
	416159	11124	 <b>Description</b> Tie Rod Length: 210 mm
	1506924	11125	 <b>Description</b> Tie Rod 1- 7596 Page 353 d=Ø15 Ax=90 Length: 150 mm
	1506925	11126	 <b>Description</b> Tie Rod 1- 7596 Page 353 d=Ø15 Ax=90 Length: 150 mm
	488739	11127	 <b>Description</b> Tie Rod 1- 7596 Page 353 d=Ø15 Ax=90 Length: 145 mm
	488738	11128	 <b>Description</b> Tie Rod 1- 7596 Page 353 d=Ø15 Ax=90 Length: 293 mm
	486590	11129	 <b>Description</b> Tie Rod Length: 160 mm

	SEM NO.	REF. NO.	Type / Model
 Length: 160 mm	11130	488056	
	<b>Description</b> Tie Rod		
 Length: 100 mm	11131	1766014 463245	
	<b>Description</b> Tie Rod		
	11553	1304571 381339	
	<b>Description</b> Tie Rod		
	11554	306981	
	<b>Description</b> Tie Rod		
	11555	1343262	
	<b>Description</b> Tie Rod		
	11556	1378435 311847 395350 1734020	
	<b>Description</b> Tie Rod 301639 2028998 1397866		

Type / Model	REF. NO.	SEM NO.	
	1343283	11557	 <p><b>Description</b> Tie Rod</p>
	1759691		
Type / Model	REF. NO.	SEM NO.	
	1897336	 12908	 <p><b>Description</b> Tie Rod</p>
	1527978		
	1723896		
	1737684		

L=1743

	SEM NO.	REF. NO.	Type / Model
 M30Xx1.5 RHT L=120	8631 (8682)	1738381 283784 395010 1767328 1914427	112 H / 112 M 113 E / 113 H 113 M 114 C / 114 G / 114 L 124 C / 124 G / 124 L 143 E 143 H / 143 M 144 C / 144 G 144 M 93 H / 93 M T 113 T 143 / T 93
	<b>Description</b>		
			Rod End





	SEM NO.	REF. NO.	Type / Model
 M30Xx1.5 RHT L=120	8632 (8683)	1358792 283783 1738380 395009 1914426	113 H / 112 M 113 E / 113 H 113 M 114 C / 114 G / 114 L 124 C / 124 G / 124 L 143 E 143 H / 143 M 144 C / 144 G 144 M 93 H / 93 M T 113 T 143 / T 93
	<b>Description</b>		
			Rod End





	SEM NO.	REF. NO.	Type / Model
 M30Xx1.5 RHT L=115	8635	1324857	
	<b>Description</b>		
			Rod End

	SEM NO.	REF. NO.	Type / Model
 M30Xx1.5 RHT L=140	10148 (10149)	1357674 1738379	
	<b>Description</b>		
			Rod End







	SEM NO.	REF. NO.	Type / Model
	10931 (10935)	1384898 305320 371452 527056	
	<b>Description</b>		
			Rod End

	SEM NO.	REF. NO.	Type / Model
	10937 (10941)	1384897 305319 371451 527055	
	<b>Description</b>		
			Rod End







Type / Model	REF. NO.	SEM NO.	
	243664 350270	10949	 <b>Description</b> Rod End
Type / Model	REF. NO.	SEM NO.	
	325614 0325614	11575	 <b>Description</b> Rod End
Type / Model	REF. NO.	SEM NO.	
	310980 539413	11576	 <b>Description</b> Rod End
Type / Model	REF. NO.	SEM NO.	
	310979 539412	11577	 <b>Description</b> Rod End







	SEM NO.	REF. NO.	Type / Model
	11578	1375228	
	<b>Description</b> Rod End		
	11579	1488890 1435746 1534756 1358793	
	<b>Description</b> Rod End		
	12912	 1723897 2051041	
	<b>Description</b> Rod End		

L=150

<b>Type / Model</b>	<b>REF. NO.</b>	<b>SEM NO.</b>	
	1362710 255669 445589	<b>7921</b>	
			<b>Description</b> Spring Eye Bushing
			D=Ø65 d=Ø30 h=122
<b>Type / Model</b>	<b>REF. NO.</b>	<b>SEM NO.</b>	
	0362385 362385	<b>8023</b>	
			<b>Description</b> Spring Bushing
			D=Ø65 d=Ø30 h=102
<b>Type / Model</b>	<b>REF. NO.</b>	<b>SEM NO.</b>	
	355146 137748	<b>8261</b>	
			<b>Description</b> Spring Bolt
			M28x4 153,5
<b>Type / Model</b>	<b>REF. NO.</b>	<b>SEM NO.</b>	
	355147 135035	<b>8262</b>	
			<b>Description</b> Spring Bolt
			M36x4 168,5
<b>Type / Model</b>	<b>REF. NO.</b>	<b>SEM NO.</b>	
	355148 202333	<b>8263</b>	
			<b>Description</b> Spring Bolt
			M36x4 182
<b>Type / Model</b>	<b>REF. NO.</b>	<b>SEM NO.</b>	
	355149	<b>8264</b>	
			<b>Description</b> Spring Bolt
			M36x4 130,5 172,5



	SEM NO.	REF. NO.	Type / Model
	<b>8265</b>	355145 128681	
	<b>Description</b> Spring Bolt		
M28x4 166,5			
	SEM NO.	REF. NO.	Type / Model
	<b>8266</b>	128680	
	<b>Description</b> Spring Bushing		
D=Ø36 d=Ø90 M28x4			
	SEM NO.	REF. NO.	Type / Model
	<b>8267</b>	139036	
	<b>Description</b> Spring Bushing		
M36x4 46x90			
	SEM NO.	REF. NO.	Type / Model
	<b>8268</b>	1364140	
	<b>Description</b> Spring Bolt		
M36x4 168,5			
	SEM NO.	REF. NO.	Type / Model
	<b>8269</b>	137749	
	<b>Description</b> Spring Bushing		
M28x4 Ø36x76			
	SEM NO.	REF. NO.	Type / Model
	<b>8274</b>		
	<b>Description</b> Spring Bushing		
M36x4 Ø46x103			

<b>Type / Model</b>	<b>REF. NO.</b>	<b>SEM NO.</b>	
	255315 1548054	<b>10081</b>	
		<b>Description</b>	Spring Bolt
			M30x3,5x225
<b>Type / Model</b>	<b>REF. NO.</b>	<b>SEM NO.</b>	
	1338491 1548055	<b>10798</b>	
		<b>Description</b>	Spring Bolt
			M30x3,5x245
<b>Type / Model</b>	<b>REF. NO.</b>	<b>SEM NO.</b>	
	0811911	<b>10888</b>	
		<b>Description</b>	Nut Fer Spring Bushing
			M30x3,5
<b>Type / Model</b>	<b>REF. NO.</b>	<b>SEM NO.</b>	
	1367370	<b>9033</b>	
		<b>Description</b>	Metal Washer
			D=Ø103,5 d=Ø30,5 h=16
<b>Type / Model</b>	<b>REF. NO.</b>	<b>SEM NO.</b>	
	272449	<b>10863</b>	
		<b>Description</b>	Spacer Ring
			D=Ø105 d=Ø30 h=6
<b>Type / Model</b>	<b>REF. NO.</b>	<b>SEM NO.</b>	
	805429	<b>10925</b>	
		<b>Description</b>	Cotter Pin
			d=Ø6,3 h=56

Description / Repair Kit for Axle	SEM NO.	Model:											
	<b>7993</b>												
	<b>REF. NO:</b> 255669S 1362710S 445589S 255315S 1548054S	<table border="1"> <thead> <tr> <th>Item No</th> <th>Ref. No</th> </tr> </thead> <tbody> <tr> <td>1</td> <td>255669-1362710</td> </tr> <tr> <td>2</td> <td>255315</td> </tr> <tr> <td>3</td> <td>1367370</td> </tr> <tr> <td>4</td> <td>811911</td> </tr> <tr> <td>5</td> <td>805479</td> </tr> </tbody> </table>	Item No	Ref. No	1	255669-1362710	2	255315	3	1367370	4	811911	5
Item No	Ref. No												
1	255669-1362710												
2	255315												
3	1367370												
4	811911												
5	805479												
	M30x3,5x225												

Description / Repair Kit for Axle	SEM NO.	Model:											
	<b>7994</b>												
	<b>REF. NO:</b> 255669S1 1362710S1 445589S1 255315S1 1548054S1	<table border="1"> <thead> <tr> <th>Item No</th> <th>Ref. No</th> </tr> </thead> <tbody> <tr> <td>1</td> <td>255669-1362710</td> </tr> <tr> <td>2</td> <td>255315</td> </tr> <tr> <td>3</td> <td>272449</td> </tr> <tr> <td>4</td> <td>811911</td> </tr> <tr> <td>5</td> <td>805479</td> </tr> </tbody> </table>	Item No	Ref. No	1	255669-1362710	2	255315	3	272449	4	811911	5
Item No	Ref. No												
1	255669-1362710												
2	255315												
3	272449												
4	811911												
5	805479												
	M30x3,5x225												

Description / Repair Kit for Spring	SEM NO.	Model:													
	<b>8024</b>														
	<b>REF. NO:</b> 362385S	<table border="1"> <thead> <tr> <th>Item No</th> <th>Ref. No</th> </tr> </thead> <tbody> <tr> <td>1</td> <td>362385</td> </tr> <tr> <td>2</td> <td>811911</td> </tr> <tr> <td>3</td> <td>805479</td> </tr> <tr> <td>4</td> <td>272449</td> </tr> <tr> <td>5</td> <td>1367370</td> </tr> <tr> <td>6</td> <td>255315</td> </tr> </tbody> </table>	Item No	Ref. No	1	362385	2	811911	3	805479	4	272449	5	1367370	6
Item No	Ref. No														
1	362385														
2	811911														
3	805479														
4	272449														
5	1367370														
6	255315														
	M30x3,5x225														

Description / Repair Kit	SEM NO.	Model:													
	<b>10435</b>														
	<b>REF. NO:</b> 255669S2 1362710S2 445589S2	<table border="1"> <thead> <tr> <th>Item No</th> <th>Ref. No</th> </tr> </thead> <tbody> <tr> <td>1</td> <td>255669-1362710</td> </tr> <tr> <td>2</td> <td>255315</td> </tr> <tr> <td>3</td> <td>1117830</td> </tr> <tr> <td>4</td> <td>811911</td> </tr> <tr> <td>5</td> <td>805479</td> </tr> <tr> <td>6</td> <td>272449</td> </tr> </tbody> </table>	Item No	Ref. No	1	255669-1362710	2	255315	3	1117830	4	811911	5	805479	6
Item No	Ref. No														
1	255669-1362710														
2	255315														
3	1117830														
4	811911														
5	805479														
6	272449														

Model:	ŞEM NO.	Description / Repair Kit
	<b>10796</b>	
<b>Item No</b>	<b>Ref. No</b>	<b>REF. NO:</b>
1	255669-1362710	1338491S
2	1338491-1548055	1548055S
3	1367370	1362710S3
4	811911	255669S3
5	805479	
	M30x3,5x245	



Model:	ŞEM NO.	Description / Repair Kit
	<b>10797</b>	
<b>Item No</b>	<b>Ref. No</b>	<b>REF. NO:</b>
1	255669-1362710	1338491S1
2	1338491-1548055	1548055S1
3	272449	1362710S4
4	811911	
5	805479	
	M30x3,5x245	



Model:	ŞEM NO.	Description / Repair Kit for Spring
	<b>8256</b>	
<b>Item No</b>	<b>Ref. No</b>	<b>REF. NO:</b>
1	355145	355145S
2	128680	128680S
3	182925	

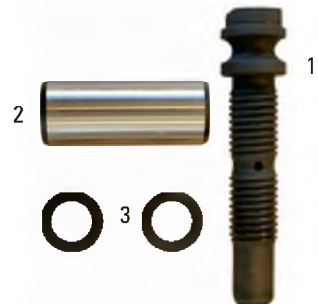

Model:	ŞEM NO.	Description / Repair Kit for Spring
	<b>8257</b>	
<b>Item No</b>	<b>Ref. No</b>	<b>REF. NO:</b>
1	355149	355149S
2	135036	135036S
3	182931	

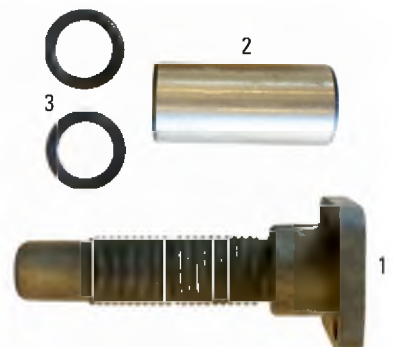

Description / Repair Kit for Spring	SEM NO.	Model:							
	<b>8258</b>								
	<b>REF. NO:</b> 1364140S 135036S1	<table border="1"> <thead> <tr> <th>Item No</th> <th>Ref. No</th> </tr> </thead> <tbody> <tr> <td>1</td> <td>1364140</td> </tr> <tr> <td>2</td> <td>135036</td> </tr> <tr> <td>3</td> <td>182931</td> </tr> </tbody> </table>	Item No	Ref. No	1	1364140	2	135036	3
Item No	Ref. No								
1	1364140								
2	135036								
3	182931								

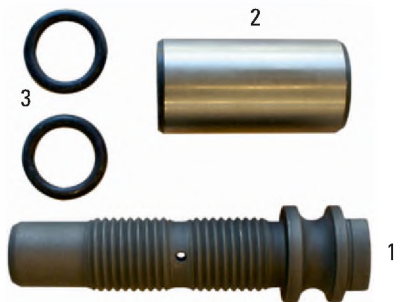
Description / Repair Kit for Spring	SEM NO.	Model:							
	<b>8259</b>								
	<b>REF. NO:</b> 355147S 135036S2	<table border="1"> <thead> <tr> <th>Item No</th> <th>Ref. No</th> </tr> </thead> <tbody> <tr> <td>1</td> <td>355147</td> </tr> <tr> <td>2</td> <td>135036</td> </tr> <tr> <td>3</td> <td>182931</td> </tr> </tbody> </table>	Item No	Ref. No	1	355147	2	135036	3
Item No	Ref. No								
1	355147								
2	135036								
3	182931								

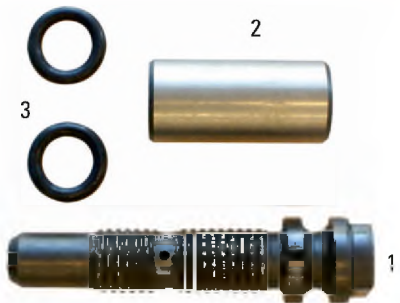

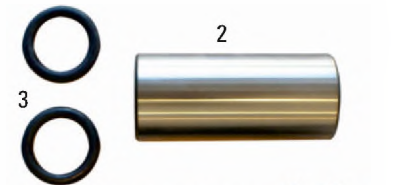

Description / Repair Kit for Spring	SEM NO.	Model:							
	<b>8260</b>								
	<b>REF. NO:</b> 355146S 137749S	<table border="1"> <thead> <tr> <th>Item No</th> <th>Ref. No</th> </tr> </thead> <tbody> <tr> <td>1</td> <td>355146</td> </tr> <tr> <td>2</td> <td>137749</td> </tr> <tr> <td>3</td> <td>182929</td> </tr> </tbody> </table>	Item No	Ref. No	1	355146	2	137749	3
Item No	Ref. No								
1	355146								
2	137749								
3	182929								

Description / Repair Kit for Spring	SEM NO.	Model:															
	<b>8270</b>																
	<b>REF. NO:</b> 355145S2	<table border="1"> <thead> <tr> <th>Item No</th> <th>Ref. No</th> </tr> </thead> <tbody> <tr> <td>1</td> <td>355145</td> </tr> <tr> <td>2</td> <td>182925</td> </tr> <tr> <td>3</td> <td>815125</td> </tr> <tr> <td>4</td> <td>803070</td> </tr> <tr> <td>5</td> <td>814894</td> </tr> <tr> <td>6</td> <td>806316</td> </tr> <tr> <td>7</td> <td>814896</td> </tr> </tbody> </table>	Item No	Ref. No	1	355145	2	182925	3	815125	4	803070	5	814894	6	806316	7
Item No	Ref. No																
1	355145																
2	182925																
3	815125																
4	803070																
5	814894																
6	806316																
7	814896																





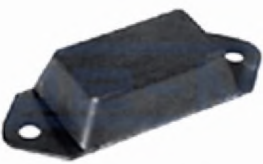

Model:	SEM NO.	Description / Repair Kit for Spring
	<b>8271</b>	
<b>Item No</b>	<b>Ref. No</b>	<b>REF. NO:</b>
1	355148	355148S
2	182931	
3	1120345	
4	814914	
5	815126	
6	803072	
7	806314	

Model:	SEM NO.	Description / Repair Kit for Spring
	<b>8272</b>	
<b>Item No</b>	<b>Ref. No</b>	<b>REF. NO:</b>
1	355148	355148S1
2	135698	
3	182931	







Model:	SEM NO.	Description / Repair Kit for Spring
	<b>8273</b>	
<b>Item No</b>	<b>Ref. No</b>	<b>REF. NO:</b>
1	355145	355145S3
2	182925	
3	815125	
4	803070	
5	814894	
6	814896	
7	806316	



	SEM NO.	REF. NO.	Type / Model
	8254	285493	
	<b>Description</b>		
	Rubber Metal Pad		
	SEM NO.	REF. NO.	Type / Model
	8255	222095	
	<b>Description</b>		
	Rubber Metal Pad		
	SEM NO.	REF. NO.	Type / Model
	10972	120252	
	<b>Description</b>		
	Rubber Metal Mounting		
A=126 B=46 h=25 d=8,5			
	SEM NO.	REF. NO.	Type / Model
	9021	1322341	
	<b>Description</b>		
	Spring Rubber		
67x101			
	SEM NO.	REF. NO.	Type / Model
	9022	1324366	
	<b>Description</b>		
	Spring Rubber		
67x101			









<b>Type / Model</b>	<b>REF. NO.</b>	<b>SEM NO.</b>	
	1324367 1726129	<b>11418</b>	
		<b>Description</b>	
		Spring Bolt (U)	
			M22x93x187
<b>Type / Model</b>	<b>REF. NO.</b>	<b>SEM NO.</b>	
	1726130	<b>11419</b>	
		<b>Description</b>	
		Spring Bolt (U)	
			M22x93x202
<b>Type / Model</b>	<b>REF. NO.</b>	<b>SEM NO.</b>	
	1331197 1726131	<b>11420</b>	
		<b>Description</b>	
		Spring Bolt (U)	
			M22x93x215
<b>Type / Model</b>	<b>REF. NO.</b>	<b>SEM NO.</b>	
	1331198 1726132	<b>11421</b>	
		<b>Description</b>	
		Spring Bolt (U)	
			M22x93x226
<b>Type / Model</b>	<b>REF. NO.</b>	<b>SEM NO.</b>	
	1384444 1726133	<b>11422</b>	
		<b>Description</b>	
		Spring Bolt (U)	
			M22x93x240
<b>Type / Model</b>	<b>REF. NO.</b>	<b>SEM NO.</b>	
	1331200 1726134	<b>11423</b>	
		<b>Description</b>	
		Spring Bolt (U)	
			M22x93x256











	<b>SEM NO.</b>	<b>REF. NO.</b>	<b>Type / Model</b>
	11424	1377702 1739274	
	<b>Description</b>	Spring Bolt (U)	
M22x105x305			
	<b>SEM NO.</b>	<b>REF. NO.</b>	<b>Type / Model</b>
	11425	1377700 1739272	
	<b>Description</b>	Spring Bolt (U)	
M22x105x315			
	<b>SEM NO.</b>	<b>REF. NO.</b>	<b>Type / Model</b>
	11426	1377701 1739273	
	<b>Description</b>	Spring Bolt (U)	
M22x105x325			
	<b>SEM NO.</b>	<b>REF. NO.</b>	<b>Type / Model</b>
	11427	550296	
	<b>Description</b>	Spring Bolt (U)	
M24x105x308			
	<b>SEM NO.</b>	<b>REF. NO.</b>	<b>Type / Model</b>
	11428	1739282	
	<b>Description</b>	Spring Bolt (U)	
M24x105x310			
	<b>SEM NO.</b>	<b>REF. NO.</b>	<b>Type / Model</b>
	11429	1377698	
	<b>Description</b>	Spring Bolt (U)	
M24x105x328			

Type / Model	REF. NO.	SEM NO.	
	1377699	11430	 <p><b>Description</b> Spring Bolt (U)</p> <p>M24x102x338</p>
Type / Model	REF. NO.	SEM NO.	
	1390243	11777	 <p><b>Description</b> Nut</p> <p>M22x2,5</p>



	<table border="1"> <thead> <tr> <th>SEM NO.</th> <th>REF. NO.</th> </tr> </thead> <tbody> <tr> <td>7504</td> <td>1904248</td> </tr> </tbody> </table>	SEM NO.	REF. NO.	7504	1904248	<b>Type / Model</b>
SEM NO.	REF. NO.					
7504	1904248					
<p><b>Description</b> Stabilizer Bush (Half)</p>						
<p>D=Ø 93 d=Ø 56 h= 70</p>						
	<table border="1"> <thead> <tr> <th>SEM NO.</th> <th>REF. NO.</th> </tr> </thead> <tbody> <tr> <td>11786</td> <td>1772693 1725213</td> </tr> </tbody> </table>	SEM NO.	REF. NO.	11786	1772693 1725213	<b>Type / Model</b>
SEM NO.	REF. NO.					
11786	1772693 1725213					
<p><b>Description</b> Rubber Mounting</p>						
	<table border="1"> <thead> <tr> <th>SEM NO.</th> <th>REF. NO.</th> </tr> </thead> <tbody> <tr> <td>8011 (8506)</td> <td>0228483</td> </tr> </tbody> </table>	SEM NO.	REF. NO.	8011 (8506)	0228483	<b>Type / Model</b>
SEM NO.	REF. NO.					
8011 (8506)	0228483					
<p><b>Description</b> Stabilizer Rubber</p>						
<p>D=Ø71 d=Ø50 h=103</p>						
	<table border="1"> <thead> <tr> <th>SEM NO.</th> <th>REF. NO.</th> </tr> </thead> <tbody> <tr> <td>8012</td> <td>0213604</td> </tr> </tbody> </table>	SEM NO.	REF. NO.	8012	0213604	<b>Type / Model</b>
SEM NO.	REF. NO.					
8012	0213604					
<p><b>Description</b> Stabilizer Rubber</p>						
<p>D=Ø56 d=Ø40 h=122</p>						
	<table border="1"> <thead> <tr> <th>SEM NO.</th> <th>REF. NO.</th> </tr> </thead> <tbody> <tr> <td>8013</td> <td>0295751</td> </tr> </tbody> </table>	SEM NO.	REF. NO.	8013	0295751	<b>Type / Model</b>
SEM NO.	REF. NO.					
8013	0295751					
<p><b>Description</b> Stabilizer Rubber</p>						
<p>D=Ø107 d=Ø49,5 h=100</p>						
	<table border="1"> <thead> <tr> <th>SEM NO.</th> <th>REF. NO.</th> </tr> </thead> <tbody> <tr> <td>8760</td> <td>1344190</td> </tr> </tbody> </table>	SEM NO.	REF. NO.	8760	1344190	<b>Type / Model</b>
SEM NO.	REF. NO.					
8760	1344190					
<p><b>Description</b> Stabilizer Rubber</p>						
<p>Ø65x103x103,5</p>						

<b>Type / Model</b>	<b>REF. NO.</b>		<b>SEM NO.</b>		
	1919010 469081		<b>10975</b>		
				<b>Description</b>	
				Rubber Buffer	
					D=Ø70 d=Ø39 h=100
<b>Type / Model</b>	<b>REF. NO.</b>		<b>SEM NO.</b>		
	1919024		<b>11785</b>		
				<b>Description</b>	
				Rubber Bushing	
<b>Type / Model</b>	<b>REF. NO.</b>		<b>SEM NO.</b>		
	1798776		<b>11792</b>		
				<b>Description</b>	
				Rubber Bushing	
					d=Ø60 h=104
<b>Type / Model</b>	<b>REF. NO.</b>		<b>SEM NO.</b>		
	1732460 1404313		<b>10967</b>		
				<b>Description</b>	
				Stabilizer Bush	
					D=Ø99 d=Ø25 Ax=130
<b>Type / Model</b>	<b>REF. NO.</b>		<b>SEM NO.</b>		
	1372432		<b>8253</b>		
				<b>Description</b>	
				Rubber Bushing	
					D=Ø71 d=Ø24 h=79,5
<b>Type / Model</b>	<b>REF. NO.</b>		<b>SEM NO.</b>		
	1516496		<b>9032</b>		
				<b>Description</b>	
				Rubber Buffer	
					D=Ø46,5 d=Ø16 h=24



**SEM NO.**

**9059**

**REF. NO.**

1477867  
1429110  
310808

**Type / Model**

**Description**

Stabilizer Mounting

D=Ø57 d=Ø20 h=30

Model:	ŞEM NO.	Description / Stabilizer Repair Kit
	<b>9131</b>	
<b>Item No</b>	<b>Ref. No</b>	<b>REF. NO:</b>
1	1477868	1429110S
2	1477867	1477867S
3	807356	310808S

Model:	ŞEM NO.	Description / Stabilizer Repair Kit
	<b>9132</b>	
<b>Item No</b>	<b>Ref. No</b>	<b>REF. NO:</b>
1	0228483	228483S
2	1477867	
3	814898	
4	1387576	
5	815125	

Model:	ŞEM NO.	Description / Stabilizer Repair Kit
	<b>9134</b>	
<b>Item No</b>	<b>Ref. No</b>	<b>REF. NO:</b>
1	0228483	228483S1
2	814898	
3	815125	

Model:	ŞEM NO.	Description / Stabilizer Repair Kit
	<b>9135</b>	
<b>Item No</b>	<b>Ref. No</b>	<b>REF. NO:</b>
1	1344190	1344190S1
2	1477867	
3	814900	
4	807356	
5	815148	
6	807327	

Description / Stabilizer Repair Kit	SEM NO.	Model:			
	<b>9136</b>				
	REF. NO: 213604S1				
		<table border="1"> <thead> <tr> <th>Item No</th> <th>Ref. No</th> </tr> </thead> <tbody> <tr> <td>1</td> <td>0213604</td> </tr> </tbody> </table>	Item No	Ref. No	1
Item No	Ref. No				
1	0213604				

Description / Stabilizer Repair Kit	SEM NO.	Model:					
	<b>9137</b>						
	REF. NO: 213604S2						
		<table border="1"> <thead> <tr> <th>Item No</th> <th>Ref. No</th> </tr> </thead> <tbody> <tr> <td>1</td> <td>0213604</td> </tr> <tr> <td>2</td> <td>1477867</td> </tr> </tbody> </table>	Item No	Ref. No	1	0213604	2
Item No	Ref. No						
1	0213604						
2	1477867						

Description / Stabilizer Repair Kit	SEM NO.	Model:					
	<b>9138</b>						
	REF. NO: 295751S						
		<table border="1"> <thead> <tr> <th>Item No</th> <th>Ref. No</th> </tr> </thead> <tbody> <tr> <td>1</td> <td>0295751</td> </tr> <tr> <td>2</td> <td>814858</td> </tr> </tbody> </table>	Item No	Ref. No	1	0295751	2
Item No	Ref. No						
1	0295751						
2	814858						

Description / Stabilizer Repair Kit	SEM NO.	Model:			
	<b>9139</b>				
	REF. NO: 1344190S				
		<table border="1"> <thead> <tr> <th>Item No</th> <th>Ref. No</th> </tr> </thead> <tbody> <tr> <td>1</td> <td>1344190</td> </tr> </tbody> </table>	Item No	Ref. No	1
Item No	Ref. No				
1	1344190				



Model:	ŞEM NO.	Description / Stabilizer Repair Kit						
	9140							
<table border="1"> <thead> <tr> <th>Item No</th> <th>Ref. No</th> </tr> </thead> <tbody> <tr> <td>1</td> <td>0213604</td> </tr> <tr> <td>2</td> <td>1477867</td> </tr> </tbody> </table>	Item No	Ref. No	1	0213604	2	1477867	<b>REF. NO:</b> 213604S3	
Item No	Ref. No							
1	0213604							
2	1477867							

Model:	ŞEM NO.	Description / Stabilizer Repair Kit				
	9142					
<table border="1"> <thead> <tr> <th>Item No</th> <th>Ref. No</th> </tr> </thead> <tbody> <tr> <td>1</td> <td>1477867</td> </tr> </tbody> </table>	Item No	Ref. No	1	1477867	<b>REF. NO:</b> 1429110S1 1477867S1 310808S1	
Item No	Ref. No					
1	1477867					

Model:	ŞEM NO.	Description / Stabilizer Repair Kit																
	9143																	
<table border="1"> <thead> <tr> <th>Item No</th> <th>Ref. No</th> </tr> </thead> <tbody> <tr> <td>1</td> <td>0295751</td> </tr> <tr> <td>2</td> <td>1477867</td> </tr> <tr> <td>3</td> <td>----</td> </tr> <tr> <td>4</td> <td>----</td> </tr> <tr> <td>5</td> <td>----</td> </tr> <tr> <td>6</td> <td>814858</td> </tr> <tr> <td>7</td> <td>----</td> </tr> </tbody> </table>	Item No	Ref. No	1	0295751	2	1477867	3	----	4	----	5	----	6	814858	7	----	<b>REF. NO:</b> 295751S1	
Item No	Ref. No																	
1	0295751																	
2	1477867																	
3	----																	
4	----																	
5	----																	
6	814858																	
7	----																	

Model:	ŞEM NO.	Description / Stabilizer Repair Kit																		
	9144																			
<table border="1"> <thead> <tr> <th>Item No</th> <th>Ref. No</th> </tr> </thead> <tbody> <tr> <td>1</td> <td>0228483</td> </tr> <tr> <td>2</td> <td>1477867</td> </tr> <tr> <td>3</td> <td>802294</td> </tr> <tr> <td>4</td> <td>----</td> </tr> <tr> <td>5</td> <td>814899</td> </tr> <tr> <td>6</td> <td>807358</td> </tr> <tr> <td>7</td> <td>815148</td> </tr> <tr> <td>8</td> <td>803070</td> </tr> </tbody> </table>	Item No	Ref. No	1	0228483	2	1477867	3	802294	4	----	5	814899	6	807358	7	815148	8	803070	<b>REF. NO:</b> 228483S2	
Item No	Ref. No																			
1	0228483																			
2	1477867																			
3	802294																			
4	----																			
5	814899																			
6	807358																			
7	815148																			
8	803070																			









Description / Stabilizer Repair Kit	SEM NO.	Model:										
	<b>9145</b>											
	<b>REF. NO:</b> 228483S3	<table border="1"> <thead> <tr> <th>Item No</th> <th>Ref. No</th> </tr> </thead> <tbody> <tr> <td>1</td> <td>0228483</td> </tr> <tr> <td>2</td> <td>814899</td> </tr> <tr> <td>3</td> <td>815148</td> </tr> <tr> <td>4</td> <td>803070</td> </tr> </tbody> </table>	Item No	Ref. No	1	0228483	2	814899	3	815148	4	803070
	Item No	Ref. No										
	1	0228483										
	2	814899										
	3	815148										
4	803070											

Description / Stabilizer Repair Kit	SEM NO.	Model:																
	<b>9146</b>																	
	<b>REF. NO:</b> 1344190S2	<table border="1"> <thead> <tr> <th>Item No</th> <th>Ref. No</th> </tr> </thead> <tbody> <tr> <td>1</td> <td>1344190</td> </tr> <tr> <td>2</td> <td>1477867</td> </tr> <tr> <td>3</td> <td>814901</td> </tr> <tr> <td>4</td> <td>----</td> </tr> <tr> <td>5</td> <td>----</td> </tr> <tr> <td>6</td> <td>815148</td> </tr> <tr> <td>7</td> <td>803070</td> </tr> </tbody> </table>	Item No	Ref. No	1	1344190	2	1477867	3	814901	4	----	5	----	6	815148	7	803070
	Item No	Ref. No																
	1	1344190																
	2	1477867																
	3	814901																
	4	----																
	5	----																
6	815148																	
7	803070																	

Description / Stabilizer Repair Kit	SEM NO.	Model:																
	<b>9147</b>																	
	<b>REF. NO:</b> 228483S4	<table border="1"> <thead> <tr> <th>Item No</th> <th>Ref. No</th> </tr> </thead> <tbody> <tr> <td>1</td> <td>0228483</td> </tr> <tr> <td>2</td> <td>1477867</td> </tr> <tr> <td>3</td> <td>----</td> </tr> <tr> <td>4</td> <td>814899</td> </tr> <tr> <td>5</td> <td>----</td> </tr> <tr> <td>6</td> <td>815148</td> </tr> <tr> <td>7</td> <td>803070</td> </tr> </tbody> </table>	Item No	Ref. No	1	0228483	2	1477867	3	----	4	814899	5	----	6	815148	7	803070
	Item No	Ref. No																
	1	0228483																
	2	1477867																
	3	----																
	4	814899																
	5	----																
6	815148																	
7	803070																	

Description / Stabilizer Repair Kit	SEM NO.	Model:																
	<b>9148</b>																	
	<b>REF. NO:</b> 228483S5	<table border="1"> <thead> <tr> <th>Item No</th> <th>Ref. No</th> </tr> </thead> <tbody> <tr> <td>1</td> <td>0228483</td> </tr> <tr> <td>2</td> <td>1477867</td> </tr> <tr> <td>3</td> <td>814899</td> </tr> <tr> <td>4</td> <td>807356</td> </tr> <tr> <td>5</td> <td>----</td> </tr> <tr> <td>6</td> <td>815148</td> </tr> <tr> <td>7</td> <td>803070</td> </tr> </tbody> </table>	Item No	Ref. No	1	0228483	2	1477867	3	814899	4	807356	5	----	6	815148	7	803070
	Item No	Ref. No																
	1	0228483																
	2	1477867																
	3	814899																
	4	807356																
	5	----																
6	815148																	
7	803070																	







<b>Type / Model</b>	<b>REF. NO.</b>	<b>SEM NO.</b>	
	550812 639319 1958009	<b>8036 (8037)</b>	
		<b>Description</b>	Ball Joint (Kit)
			D=Ø67 d=Ø17 Ax=100
<b>Type / Model</b>	<b>REF. NO.</b>	<b>SEM NO.</b>	
	550808 550805	<b>9072 (9074)</b>	
		<b>Description</b>	Ball Joint (Kit)
			D=Ø67 d=Ø17 Ax=115
<b>Type / Model</b>	<b>REF. NO.</b>	<b>SEM NO.</b>	
	1498131	<b>9077 (9079)</b>	
		<b>Description</b>	Ball Joint (Kit)
			D=Ø67 d=Ø19 Ax=115
<b>Type / Model</b>	<b>REF. NO.</b>	<b>SEM NO.</b>	
	550800	<b>9080 (10463)</b>	
		<b>Description</b>	Ball Joint (Kit)
			D=Ø67 d=Ø17 Ax=115
<b>Type / Model</b>	<b>REF. NO.</b>	<b>SEM NO.</b>	
	1783807 1942075S	<b>11748</b>	
		<b>Description</b>	Ball Joint
			D=Ø67 d=Ø17 Ax=115
<b>Type / Model</b>	<b>REF. NO.</b>	<b>SEM NO.</b>	
	0550806 639370 5508064 550806 0609370 0639370 1104334 1953249	<b>7595 (7555-10778)</b>	
		<b>Description</b>	Ball Joint (Kit)
			D=Ø75 d=Ø17 Ax=115

	SEM NO.	REF. NO.	Type / Model
 <p>D=Ø75 d=Ø19 Ax=115</p>	<b>7949</b> (9207)	1498132	
<b>Description</b>	Ball Joint (Kit)		
 <p>D=Ø75 d=Ø17 Ax=115</p>	<b>8213</b> (8214)	1517403 550799	
<b>Description</b>	Ball Joint (Kit)		
 <p>D=Ø75 d=Ø19 Ax=115</p>	<b>8465</b> (8614)	1515981	
<b>Description</b>	Ball Joint (Kit)		
 <p>D=Ø75 d=Ø19 Ax=115</p>	<b>9636</b>	1722753 2096392	
<b>Description</b>	Ball Joint (Kit)		
 <p>D=Ø75 d=Ø17 Ax=115</p>	<b>10190</b>	1783020	
<b>Description</b>	Ball Joint (Kit)		
 <p>D=Ø85 d=Ø19 Ax=130</p>	<b>7335</b> (7742)	0638862 638862 0639287 639287 1104335 1953248	
<b>Description</b>	Ball Joint (Kit)		







<b>Type / Model</b>	<b>REF. NO.</b>	<b>SEM NO.</b>	
	1435944	<b>8216 (8402)</b>	
			<p><b>Description</b> Ball Joint (Kit)</p> <p>D=Ø85 d=Ø19 Ax=130</p>
<b>Type / Model</b>	<b>REF. NO.</b>	<b>SEM NO.</b>	
	1104336	<b>7880</b>	
			<p><b>Description</b> Ball Joint (Kit)</p> <p>D=Ø95 d=Ø23 Ax=152</p>
<b>Type / Model</b>	<b>REF. NO.</b>	<b>SEM NO.</b>	
	638870	<b>7955</b>	
			<p><b>Description</b> Ball Joint (Kit)</p> <p>D=Ø95 L=73</p>
<b>Type / Model</b>	<b>REF. NO.</b>	<b>SEM NO.</b>	
	639340	<b>9076 (9383)</b>	
			<p><b>Description</b> Ball Joint (Kit)</p> <p>D=Ø95 L=73</p>
<b>Type / Model</b>	<b>REF. NO.</b>	<b>SEM NO.</b>	
	550807 5508072	<b>9095 (9096)</b>	
			<p><b>Description</b> Ball Joint (Kit)</p>
<b>Type / Model</b>	<b>REF. NO.</b>	<b>SEM NO.</b>	
	638861	<b>8530 (8532)</b>	
			<p><b>Description</b> Ball Joint (Kit)</p>







	SEM NO.	REF. NO.	Type / Model
	<b>10839</b>	1440028S 1722582S 1444472S	
	<b>Description</b> Ball Joint (Kit)		
D=Ø70 d=Ø19 Ax=115			

	SEM NO.	REF. NO.	Type / Model
	<b>10240 (10439)</b>	1386753	
	<b>Description</b> Rubber Metal Bush		
D=Ø91 d=Ø17 Ax=115			

Type / Model	REF. NO.	SEM NO.	
	1428349	9384	 Description Axle Rod L=522 d=Ø17/17 Ax=115/115
1- 9080 Page 715			
Type / Model	REF. NO.	SEM NO.	
	1485758 1486757	9385	 Description Axle Rod L=568,5 d=Ø19/19 Ax=115/115
1- 9077 Page 715			
Type / Model	REF. NO.	SEM NO.	
	1399180 1338769	9386	 Description Axle Rod L=568 d=Ø17/17 Ax=115/115
1- 7595 Page 715			
Type / Model	REF. NO.	SEM NO.	
	1499478 1485760 1722750	9387	 Description Axle Rod L=616,5 d=Ø19/19 Ax=115/115
1- 9636 Page 716			
Type / Model	REF. NO.	SEM NO.	
	1722746 1499474	9388	 Description Axle Rod L=568 d=Ø19/19 Ax=115/115
1- 9636 Page 716			
Type / Model	REF. NO.	SEM NO.	
	1486758	9389	 Description Axle Rod L=522 d=Ø19/19 Ax=115/115
1- 9077 Page 715			



	SEM NO.	REF. NO.	Type / Model
 L=616,5 d=Ø17/17 Ax=115/115	<b>9390</b>	1399019 1500576	
	<b>Description</b>		
			Axle Rod Alternative Rubber
			1- 8213 Page 716
	SEM NO.	REF. NO.	Type / Model
 L=568 d=Ø19/19 Ax=115/115	<b>10171</b>	1499475 1722747 1500573	
	<b>Description</b>		
			Axle Rod
			1- 9636 Page 716
	SEM NO.	REF. NO.	Type / Model
 L=568 d=Ø17/17 Ax=115/115	<b>10172</b>	1428347	
	<b>Description</b>		
			Axle Rod
			1- 9080 Page 715
	SEM NO.	REF. NO.	Type / Model
 L=532 d=Ø17/17 Ax=115/115	<b>10173</b>	0477889 1431471 477889	
	<b>Description</b>		
			Axle Rod
			1- 7595 Page 715
	SEM NO.	REF. NO.	Type / Model
 L=637 d=Ø17/17 Ax=115/115	<b>10174</b>	1770732	
	<b>Description</b>		
			Axle Rod
			1- 10190 Page 716
	SEM NO.	REF. NO.	Type / Model
 L=592 d=Ø19/19 Ax=115/115	<b>10175</b>	1499476 1722748	
	<b>Description</b>		
			Axle Rod
			1- 9636 Page 716

Type / Model	REF. NO.	SEM NO.	
	1499477 1722749 1399020	<b>10176</b>	 <b>Description</b> Axle Rod L=606 d=Ø/19/19 Ax=115/115
1- 9636 Page 716			
	1499479 1722751	<b>10177</b>	 <b>Description</b> Axle Rod L=629 d=Ø/19/19 Ax=115/115
1- 9636 Page 716			
	1326775 1326771	<b>10794</b>	 <b>Description</b> Axle Rod L=522 d=Ø17/17 Ax=115/115
1- 7595 Page 715			
	1486756	<b>11658</b>	 <b>Description</b> Axle Rod L=568 d=Ø/19/19 Ax=115/115
1- 9077 Page 715			
	1438475 1863130	<b>11810</b>	 <b>Description</b> Axle Rod L=539 d=17/17 Ax=115/115
1- 8213 Page 716			
	1101843 1379423 1393298	<b>11950</b>	 <b>Description</b> Axle Rod L=752 d=Ø17/17 Ax=115/115
1- 9080 Page 715			



SEM NO.	REF. NO.	Type / Model
11951	1942075	
 <p><b>Description</b> Axle Rod</p>		
L=752 d=Ø17/17 Ax=115/115		
1- 11748 Page 715		

SEM NO.	REF. NO.	Type / Model
12888	1464611 1353445 1942147	
 <p><b>Description</b> Axle Rod</p>		
1- 9072 Page 715 2- 9095 Page 717		







SEM NO.	REF. NO.	Type / Model
12918	463435	
 <p><b>Description</b> Axle Rod</p>		
L=750 d=Ø17/17 Ax=100/100		
1- 8036 Page 715		

SEM NO.	REF. NO.	Type / Model
12919	463436	
 <p><b>Description</b> Axle Rod</p>		
L=750 d=Ø17/17 Ax=100/100		
1- 8036 Page 715		

SEM NO.	REF. NO.	Type / Model
12923	1770730	
 <p><b>Description</b> Axle Rod</p>		
L=552 d=Ø17/17 Ax=115/115		
1- 9080 Page 715		

SEM NO.	REF. NO.	Type / Model
12924	1485753	
 <p><b>Description</b> Axle Rod</p>		
L=522 d=Ø19/19 Ax=115/115		
1- 7949 Page 716		

<b>Type / Model</b>	<b>REF. NO.</b>		<b>SEM NO.</b>	
	1367281		12925	
			<b>Description</b>	
			Axle Rod	
1- 7595 Page 715				L=522 d=Ø17/17 Ax=115/115
<b>Type / Model</b>	<b>REF. NO.</b>		<b>SEM NO.</b>	
	1399182		12926	
			<b>Description</b>	
			Axle Rod	
1- 7595 Page 715				L=580 d=Ø17/17 Ax=115/115
<b>Type / Model</b>	<b>REF. NO.</b>		<b>SEM NO.</b>	
	1770733		12927	
			<b>Description</b>	
			Axle Rod	
1- 10190 Page 716				L=652 d=Ø17/17 Ax=115/115
<b>Type / Model</b>	<b>REF. NO.</b>		<b>SEM NO.</b>	
	1485759		12930	
			<b>Description</b>	
			Axle Rod	
1- 7949 Page 716				L=580 d=Ø19/19 Ax=115/115
<b>Type / Model</b>	<b>REF. NO.</b>		<b>SEM NO.</b>	
	1500572		12931	
			<b>Description</b>	
			Axle Rod	
1- 8213 Page 716				L=568 d=Ø17/17 Ax=115/115
<b>Type / Model</b>	<b>REF. NO.</b>		<b>SEM NO.</b>	
	1367282		12932	
			<b>Description</b>	
			Axle Rod	
1- 7595 Page 715				L=540 d=Ø17/17 Ax=115/115

	SEM NO.		REF. NO.	Type / Model
 L=752 d=Ø17/17 Ax=115/115	12933		1431470	
	<b>Description</b> Axle Rod			1- 8213 Page 716
 L=522 d=Ø19/19 Ax=115/115	12934		1782019	
	<b>Description</b> Axle Rod			1- 9636 Page 716
 L=650 d=Ø19/19 Ax=130/130	12935		465816 466801 489987	
	<b>Description</b> Axle Rod			1 - 7335 Page 716

Type / Model	REF. NO.	SEM NO.
	1440028	10840
	1722582	

Description	
1- 9089 Page 359	Axle Rod ( V )
2- 10839 Page 718	L=613,5 d=25/19/19 Ax=152/115/115



	<b>SEM NO.</b>	<b>REF. NO.</b>	<b>Type / Model</b>
	11448	1315959 1370267 1420474 SACHS 125650 SACHS 123901 SACHS 310783 MONROE T1319 MONROE T1145	OPEN LENGTH=688 CLOSED LENGTH=418 UPPER MOUNT DIMENSION=M14x81 LOWER MOUNT DIMENSION=M16x48
	<b>SEM NO.</b>	<b>REF. NO.</b>	<b>Type / Model</b>
	11449	279011 1381807 307111 1421062 424306 1861118 1012044 20900141 1340252	SACHS 106763 SACHS 125797 SACHS 310997 OPEN LENGTH=690 CLOSED LENGTH=412 UPPER MOUNT DIMENSION=M16x77 LOWER MOUNT DIMENSION=21,5x42,5
	<b>SEM NO.</b>	<b>REF. NO.</b>	<b>Type / Model</b>
	11484	1397390 1397392 1397386 1424227 1397388 SACHS 290987 MONROE Cb0058	
	<b>SEM NO.</b>	<b>REF. NO.</b>	<b>Type / Model</b>
	11485	1502472 1502474 1502470 1505563 1502471 1595642 MONROE CB0079 SACHS 310620	
	<b>SEM NO.</b>	<b>REF. NO.</b>	<b>Type / Model</b>
	11497	0216976 1481718 1340260 MONROE T5238	OPEN LENGTH=661 CLOSED LENGTH=395 UPPER MOUNT DIMENSION=M16x77 LOWER MOUNT DIMENSION=M21,5x42,5
	<b>SEM NO.</b>	<b>REF. NO.</b>	<b>Type / Model</b>
	11513	1371447 1478500 1371448 1478499 SACHS 125598 MONROE T1215	OPEN LENGTH=865 CLOSED LENGTH=495 UPPER MOUNT DIMENSION=M14x64 LOWER MOUNT DIMENSION=20x50





Type / Model	REF. NO.	SEM NO.	
OPEN LENGTH=548 CLOSED LENGTH=341 UPPER MOUNT DIMENSION=M14x64 LOWER MOUNT DIMENSION=20x50	1401877 1478511 1454753 SACHS 131543	<b>11514</b>	 <b>Description</b> Shock Absorber
OPEN LENGTH=735 CLOSED LENGTH=430 UPPER MOUNT DIMENSION=M14x64 LOWER MOUNT DIMENSION=20x50	1390898 1478501 SACHS 000331 MONROE T1230	<b>11515</b>	 <b>Description</b> Shock Absorber
	550285	<b>7726</b>	 <b>Description</b> Rubber Metal Buffer (Kit) D=Ø20 d=Ø16 h=40
	0307113	<b>7814</b>	 <b>Description</b> Rubber Metal Buffer Ø60 Ø20 h=19
	339188	<b>9020</b>	 <b>Description</b> Rubber Mounting D=Ø49,5 d=Ø22 h=25,5







	<b>SEM NO.</b> 72.3608.C	<b>REF. NO.</b> 1903608 1944314	<b>Technical Specification</b> CONTITECH 6700 N P02 GOODYEAR 1R14-869 FIRESTONE W01-M58-8535	Total Weight 12 kg
	<b>Description</b> Metal Piston			
	<b>SEM NO.</b> 72.40301.C	<b>REF. NO.</b> 470920 1140301 488265	<b>Technical Specification</b> FIRESTONE 1T15VR-3 FIRESTONE W01 S15 8192 GOODYEAR 1R13-746 PHOENIX 1 DF 23 B-1	Total Weight 7,8 kg
	<b>Description</b> Metal Piston			
	<b>SEM NO.</b> 72.40302.C	<b>REF. NO.</b> 1440302 470921	<b>Technical Specification</b> FIRESTONE 1T15VPR-3 GOODYEAR 1R12-809 FIRESTONE W01 M58 8193 PHOENIX 1 DF 23 A-1	Total Weight 7,8 kg
	<b>Description</b> Metal Piston			
	<b>SEM NO.</b> 72.40303.C	<b>REF. NO.</b> 1440303 1475106 488263 1521114	<b>Technical Specification</b> GOODYEAR 1R11-833 FIRESTONE 1T15L-4 PHOENIX 1 DF 20 C-1 FIRESTONE W01 095 0422	Total Weight 7,8 kg
	<b>Description</b> Metal Piston			
	<b>SEM NO.</b> 72.40304.C	<b>REF. NO.</b> 1440304 470922 1440305	<b>Technical Specification</b> GOODYEAR 1R11-829 PHOENIX 1 DF 20 A-1	Total Weight 7,8 kg
	<b>Description</b> Metal Piston			
	<b>SEM NO.</b> 72.40305.C	<b>REF. NO.</b> 1440305	<b>Technical Specification</b> GOODYEAR 1R11-830 FIRESTONE W01 095 481 PHOENIX 1 DF 20 A-2	Total Weight 7,8 kg
	<b>Description</b> Metal Piston			



Technical Specification	REF. NO.	ŞEM NO.	
Total Weight 8,7 kg	1440306	GOODYEAR 1R11-831 PHOENIX 1 DF 20 A-3	<b>72.40306.C</b>
			<b>Description</b> Metal Piston
			
Technical Specification	REF. NO.	ŞEM NO.	
Total Weight 8,7 kg	1440307	GOODYEAR 1R11-845	<b>72.40307.C</b>
	475149	FIRESTONE 1T15L-4(3)	
	1440860	PHOENIX 1 DF 23 B-2	
	470919	FIRESTONE W01 095 0405	
			<b>Description</b> Metal Piston
			
Technical Specification	REF. NO.	ŞEM NO.	
Total Weight 11,5 kg	1107674	CONTITECH 4813 N P07	<b>72.4813.C07</b>
	255293	PHOENIX 1 D 28 B-9	
	1314906	VIBRACOUSTIC V1D28B-9	
	298568	FIRESTONE 1T19L-11	
	1865755	FIRESTONE W01-M58-7358	
	325748	GOODYEAR 1R14-727 GY SPRINGRIDE D13B10 GY SPRINGRIDE D13B22	
			<b>Description</b> Metal Piston
			
Technical Specification	REF. NO.	ŞEM NO.	
Total Weight 12,3 kg	1379392	CONTITECH 4913 N P02	<b>72.4913.C02</b>
	1440294	PHOENIX 1 D 28 H-16	
		FIRESTONE 1T19L-14	
		FIRESTONE W01-M58-9881	
		FIRESTONE W01-095-0500	
		GART REF. C282/H	
		GOODYEAR 1R14-753	
			<b>Description</b> Metal Piston
			
Technical Specification	REF. NO.	ŞEM NO.	
Total Weight 8 kg	1434930	FIRESTONE 1T15UR-9 FIRESTONE WQ01 M58 8653	<b>72.4930.CP</b>
			<b>Description</b> Plastic Piston
			
Technical Specification	REF. NO.	ŞEM NO.	
Total Weight 7 kg	1434933	FIRESTONE 1T15UR-9 FIRESTONE WQ01 M58 8633	<b>72.4933.C</b>
			<b>Description</b> Metal Piston
			



	<b>SEM NO.</b>	<b>REF. NO.</b>	<b>Technical Specification</b>
	72.4913.S04	1379393	CONTITECH 4913 N P04 PHOENIX 1 D 28 H-16 NP FIRESTONE 1T19L-14 FIRESTONE W01-095-0365 GOODYEAR 1R14-755 GY SPRINGRIDE D14U42 CF GOMMA REF. 1T19E-93 GART NO. 282.0.601 GART REF. C282/H
	<b>Description</b>		Total Weight 8,5 kg
	Service Assembly		
	<b>SEM NO.</b>	<b>REF. NO.</b>	<b>Technical Specification</b>
	72.6199.C	1386199	GOODYEAR 1R13-744
	<b>Description</b>		Total Weight 10,5 kg
	Metal Piston		
	<b>SEM NO.</b>	<b>REF. NO.</b>	<b>Technical Specification</b>
	72.6200.C	1386200	GOODYEAR 1R13-745
	<b>Description</b>		Total Weight 10,7 kg
	Metal Piston		
	<b>SEM NO.</b>	<b>REF. NO.</b>	<b>Technical Specification</b>
	72.715.R	CONTITECH 715 N VDL Bus 0659561 PHOENIX 1 F 25 VIBRACOUSTIC V1F25 FIRESTONE 1R1C335-310 FIRESTONE W01-095-0087 GOODYEAR 8015 CF GOMMA REF. 1SC310-16	CF GOMMA NO. 93518 DUNLOP UK PNP304890101 IRISBUS 5000819517
	<b>Description</b>		Total Weight 2 kg
	Roll		
	<b>SEM NO.</b>	<b>REF. NO.</b>	<b>Technical Specification</b>
	72.896.R	411627	CONTITECH 896 N PHOENIX 2 E 18 A FIRESTONE 1R1J520-285 FIRESTONE W01-095-0173 FIRESTONE W01-095-0245 GOODYEAR 8040 GY SPRINGRIDE SP2191 DUNLOP UK PNP305140100 Dennis 1261
	<b>Description</b>		Total Weight 1,7 kg
	Roll		
	<b>SEM NO.</b>	<b>REF. NO.</b>	<b>Technical Specification</b>
	72.897.R	411622 411623	CONTITECH 897 N PHOENIX 2 E 23 VIBRACOUSTIC V2E23 FIRESTONE 1R1K440-320 FIRESTONE W01-095-0229 FIRESTONE W01-095-0174 GOODYEAR 8028 GOODYEAR 8313
	<b>Description</b>		Total Weight 1,8 kg
	Roll		

Technical Specification	REF. NO.	SEM NO.		
Total Weight 1,6 kg	523229	CONTITECH 944 N PHOENIX 1 E 21-6 VIBRACOUSTIC V1E21-6 VIBRACOUSTIC V1E19 FIRESTONE 1R1B390-270 FIRESTONE W01-095-0121 Inbus 484 0005 Inbus 489 0001 GOODYEAR 9009	<b>72.944.R</b>  <b>Description</b> Roll	
Total Weight 2,7 kg	1319761 1387289	CONTITECH FD 200 19 P04 PHOENIX SP 2 B 12 R 5 VIBRACOUSTIC VSP2B12R 5 FIRESTONE 20F FIRESTONE W01 M58 7894 Kögel 6501706 GOODYEAR 2B9 700 GY SPRINGRIDE S09201 GART NO. 291.2.203 GART REF. T291/2 Granning 15599	<b>72.2211.P11</b>  <b>Description</b> Convulated Air Spring	
Total Weight 2,7 kg	1387283		<b>72.2211.P08</b>  <b>Description</b> Convulated Air Spring	
Total Weight	1387283	CONTITECH FD 200-25 1/4 M10 PHOENIX SP 2 B 12 R-A-10 VIBRACOUSTIC VSP2B12RA-10 FIRESTONE 20C-2 Granning 15670 FIRESTONE W01-M58-7679 FIRESTONE W01-968-6771 GOODYEAR 2B9-269 WW US 07394C	<b>72.2221.P04</b>  <b>Description</b> Convulated Air Spring	

	<table border="1"> <thead> <tr> <th>SEM NO.</th> <th>REF. NO.</th> <th>Type / Model</th> </tr> </thead> <tbody> <tr> <td>8198</td> <td>10575155 575155 1118103 1575155 1378526</td> <td></td> </tr> <tr> <td><b>Description</b></td> <td></td> <td></td> </tr> <tr> <td>Hand Pump</td> <td></td> <td></td> </tr> </tbody> </table>	SEM NO.	REF. NO.	Type / Model	8198	10575155 575155 1118103 1575155 1378526		<b>Description</b>			Hand Pump		
SEM NO.	REF. NO.	Type / Model											
8198	10575155 575155 1118103 1575155 1378526												
<b>Description</b>													
Hand Pump													
	<table border="1"> <thead> <tr> <th>SEM NO.</th> <th>REF. NO.</th> <th>Type / Model</th> </tr> </thead> <tbody> <tr> <td>8458</td> <td>1549740</td> <td></td> </tr> <tr> <td><b>Description</b></td> <td></td> <td></td> </tr> <tr> <td>Hand Pump</td> <td></td> <td></td> </tr> </tbody> </table>	SEM NO.	REF. NO.	Type / Model	8458	1549740		<b>Description</b>			Hand Pump		
SEM NO.	REF. NO.	Type / Model											
8458	1549740												
<b>Description</b>													
Hand Pump													
	<table border="1"> <thead> <tr> <th>SEM NO.</th> <th>REF. NO.</th> <th>Type / Model</th> </tr> </thead> <tbody> <tr> <td>8459</td> <td>1422840</td> <td></td> </tr> <tr> <td><b>Description</b></td> <td></td> <td></td> </tr> <tr> <td>Hand Pump</td> <td></td> <td></td> </tr> </tbody> </table>	SEM NO.	REF. NO.	Type / Model	8459	1422840		<b>Description</b>			Hand Pump		
SEM NO.	REF. NO.	Type / Model											
8459	1422840												
<b>Description</b>													
Hand Pump													
	<table border="1"> <thead> <tr> <th>SEM NO.</th> <th>REF. NO.</th> <th>Type / Model</th> </tr> </thead> <tbody> <tr> <td>8990</td> <td>1549741</td> <td></td> </tr> <tr> <td><b>Description</b></td> <td></td> <td></td> </tr> <tr> <td>Cabin Hand Pump</td> <td></td> <td></td> </tr> </tbody> </table>	SEM NO.	REF. NO.	Type / Model	8990	1549741		<b>Description</b>			Cabin Hand Pump		
SEM NO.	REF. NO.	Type / Model											
8990	1549741												
<b>Description</b>													
Cabin Hand Pump													
	<table border="1"> <thead> <tr> <th>SEM NO.</th> <th>REF. NO.</th> <th>Type / Model</th> </tr> </thead> <tbody> <tr> <td>9405</td> <td>10575160 1349010 1375497 1575160</td> <td></td> </tr> <tr> <td><b>Description</b></td> <td></td> <td></td> </tr> <tr> <td>Hand Pump</td> <td></td> <td></td> </tr> </tbody> </table>	SEM NO.	REF. NO.	Type / Model	9405	10575160 1349010 1375497 1575160		<b>Description</b>			Hand Pump		
SEM NO.	REF. NO.	Type / Model											
9405	10575160 1349010 1375497 1575160												
<b>Description</b>													
Hand Pump													
	<table border="1"> <thead> <tr> <th>SEM NO.</th> <th>REF. NO.</th> <th>Type / Model</th> </tr> </thead> <tbody> <tr> <td>9407</td> <td>10571689 1575159 1314653 10575159 1571689</td> <td></td> </tr> <tr> <td><b>Description</b></td> <td></td> <td></td> </tr> <tr> <td>Hand Pump</td> <td></td> <td></td> </tr> </tbody> </table>	SEM NO.	REF. NO.	Type / Model	9407	10571689 1575159 1314653 10575159 1571689		<b>Description</b>			Hand Pump		
SEM NO.	REF. NO.	Type / Model											
9407	10571689 1575159 1314653 10575159 1571689												
<b>Description</b>													
Hand Pump													

Type / Model	REF. NO.	SEM NO.
	10575151	1575152
	361453	575154
	10575154	1575154
	383524	
	1378531	
	575151	
	1575151	
	575152	
		<b>9412</b>
		<b>Description</b>
		Hand Pump
Type / Model	REF. NO.	SEM NO.
	10575153	
	1575153	
	1378527	
	368926	
	575153	
		<b>9413</b>
		<b>Description</b>
		Hand Pump

	SEM NO.	REF. NO.	Type / Model
	<b>8461</b>	1549738	10575102
		1517324	575163
<b>Description</b>	Cylinder	1575102	1423396
		575205	10575205
		1575163	517324
		1575161	10575163
		575102	575161
	1575205		

D=Ø60 Ax=648

	SEM NO.	REF. NO.	Type / Model
	<b>8963</b>	1466506	
<b>Description</b>			

Cylinder

D=Ø50 Ax=650

	SEM NO.	REF. NO.	Type / Model
	<b>9424</b>	549739	
		1511921	
<b>Description</b>	Cylinder	1549739	
		1720926	



	SEM NO.	REF. NO.	Type / Model
	<b>9425</b>	382386	
		575173	
<b>Description</b>	Cylinder	1575173	
		10575173	







	SEM NO.	REF. NO.	Type / Model
	<b>9426</b>	1477878	
		1720924	
<b>Description</b>			



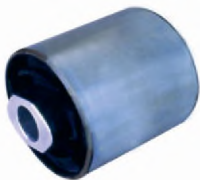



Cylinder

	SEM NO.	REF. NO.	Type / Model
	<b>9428</b>	1720925	
<b>Description</b>			







Cylinder







Type / Model	REF. NO.	SEM NO.
	1354888	11643
		 <p><b>Description</b> Cabin Cylinder</p>
Type / Model	REF. NO.	SEM NO.
	1720927	11644
		 <p><b>Description</b> Cabin Cylinder</p>
Type / Model	REF. NO.	SEM NO.
	1549737	11645
		 <p><b>Description</b> Cabin Cylinder</p>

	<table border="1"> <thead> <tr> <th>SEM NO.</th> <th>REF. NO.</th> <th>Type / Model</th> </tr> </thead> <tbody> <tr> <td>7813</td> <td>1377562</td> <td></td> </tr> </tbody> </table>	SEM NO.	REF. NO.	Type / Model	7813	1377562		<p><b>Description</b> Cabin Bushing</p>
SEM NO.	REF. NO.	Type / Model						
7813	1377562							
<p>Ø60 Ø16 h=80</p>								
	<table border="1"> <thead> <tr> <th>SEM NO.</th> <th>REF. NO.</th> <th>Type / Model</th> </tr> </thead> <tbody> <tr> <td>7823</td> <td>1105972 1514505</td> <td></td> </tr> </tbody> </table>	SEM NO.	REF. NO.	Type / Model	7823	1105972 1514505		<p><b>Description</b> Cabin Bushing</p>
SEM NO.	REF. NO.	Type / Model						
7823	1105972 1514505							
<p>D=Ø50 d=Ø16,5 h=80</p>								
	<table border="1"> <thead> <tr> <th>SEM NO.</th> <th>REF. NO.</th> <th>Type / Model</th> </tr> </thead> <tbody> <tr> <td>8028</td> <td>1394544</td> <td></td> </tr> </tbody> </table>	SEM NO.	REF. NO.	Type / Model	8028	1394544		<p><b>Description</b> Cabin Bushing</p>
SEM NO.	REF. NO.	Type / Model						
8028	1394544							
<p>D=Ø60 d=Ø16 h=80</p>								
	<table border="1"> <thead> <tr> <th>SEM NO.</th> <th>REF. NO.</th> <th>Type / Model</th> </tr> </thead> <tbody> <tr> <td>10976</td> <td>1353959</td> <td></td> </tr> </tbody> </table>	SEM NO.	REF. NO.	Type / Model	10976	1353959		<p><b>Description</b> Cabin Bushing</p>
SEM NO.	REF. NO.	Type / Model						
10976	1353959							
<p>D=Ø55 d=Ø10 h=70</p>								
	<table border="1"> <thead> <tr> <th>SEM NO.</th> <th>REF. NO.</th> <th>Type / Model</th> </tr> </thead> <tbody> <tr> <td>10977</td> <td>1788239</td> <td></td> </tr> </tbody> </table>	SEM NO.	REF. NO.	Type / Model	10977	1788239		<p><b>Description</b> Cabin Bushing</p>
SEM NO.	REF. NO.	Type / Model						
10977	1788239							
<p>D=Ø60 d=Ø16 h=70</p>								
	<table border="1"> <thead> <tr> <th>SEM NO.</th> <th>REF. NO.</th> <th>Type / Model</th> </tr> </thead> <tbody> <tr> <td>10978</td> <td>1892896</td> <td></td> </tr> </tbody> </table>	SEM NO.	REF. NO.	Type / Model	10978	1892896		<p><b>Description</b> Cabin Bushing</p>
SEM NO.	REF. NO.	Type / Model						
10978	1892896							
<p>D=Ø60 d=Ø16 h=70</p>								

<b>Type / Model</b>	<b>REF. NO.</b>	<b>SEM NO.</b>	 <b>Description</b> Cabin Bushing D=Ø42 d=Ø14 L=47
	1870611	11947	
			
<b>Type / Model</b>	<b>REF. NO.</b>	<b>SEM NO.</b>	 <b>Description</b> Cabin Bushing D=Ø39 d=Ø16 h=44
	1379244	8182	
<b>Type / Model</b>	<b>REF. NO.</b>	<b>SEM NO.</b>	 <b>Description</b> Cabin Bushing
	0390359	8248	
	390359		
	0347245		
	347245		
	0165332 165332		
<b>Type / Model</b>	<b>REF. NO.</b>	<b>SEM NO.</b>	 <b>Description</b> Cabin Mounting D=Ø56 h=36,5 M10x1,5
	329583	8276	
	305345		
<b>Type / Model</b>	<b>REF. NO.</b>	<b>SEM NO.</b>	 <b>Description</b> Spacer Ring D=Ø75 h=Ø8
	1385170 1381893	8031	
<b>Type / Model</b>	<b>REF. NO.</b>	<b>SEM NO.</b>	 <b>Description</b> Stabilizer Bush D=Ø74 d=Ø21 h=10
	1353965	8249	



	SEM NO.	REF. NO.	Type / Model
 D=Ø63 d=Ø21 h=20	8250	1343134 1481245 1894408	
	<b>Description</b> Stabilizer Bush		
 D=Ø60 h=41 M8x1,25	8251	0384595	
	<b>Description</b> Stabilizer Bush		
 D=Ø55 d=Ø22 h=44	8252	385266	
	<b>Description</b> Cabin Pur Bush		
 D=Ø40 h=32 M8x1,25	8338	1349810	
	<b>Description</b> Pur Mounting		
 D=Ø55 h=45 M8x1,25	8339	1349805 1923654	
	<b>Description</b> Pur Mounting		
 D=Ø44 d=Ø21 h=28	8787	1302008	
	<b>Description</b> Pur Mounting		

<b>Type / Model</b>	<b>REF. NO.</b>	<b>SEM NO.</b>	 <b>Description</b> Cabin Bellows Joint d=Ø16 h=81
	1744210 1504160 1443114 1364293	<b>8347</b>	
<b>Type / Model</b>	<b>REF. NO.</b>	<b>SEM NO.</b>	 <b>Description</b> Cabin Bellows Joint (Alternatively bearing) d=Ø16 h=81
	1744210S 1504160S 1443114S 1364293S	<b>8347-1</b>	
<b>Type / Model</b>	<b>REF. NO.</b>	<b>SEM NO.</b>	 <b>Description</b> Cabin Bellows Joint d=Ø16 h=120
	1744211 1426202	<b>8348</b>	
<b>Type / Model</b>	<b>REF. NO.</b>	<b>SEM NO.</b>	 <b>Description</b> Cabin Bellows Joint (Alternatively bearing) d=Ø16 h=120
	1744211 S 1426202S	<b>8348-1</b>	
<b>Type / Model</b>	<b>REF. NO.</b>	<b>SEM NO.</b>	 <b>Description</b> Cabin Bellows Joint Ø=16 h=110
	1743466	<b>10973</b>	
<b>Type / Model</b>	<b>REF. NO.</b>	<b>SEM NO.</b>	 <b>Description</b> Repair Kit for Cabin
10973-1 350-2	1743466S	<b>10974</b>	

	SEM NO.	REF. NO.	Type / Model
	8349	1324713	Bearing 21304 E1TVPB
	<b>Description</b> Bearing (Original bearing)		

	SEM NO.	REF. NO.	Type / Model
	8349-1	1324713	
	<b>Description</b> Bearing (Alternatively Bearing)		

	SEM NO.	REF. NO.	Type / Model
	9058	346085	
	<b>Description</b> Cabin Bushing		

D=Ø23 d=Ø20 h=10

	SEM NO.	REF. NO.	Type / Model
	9635	1459188 1343149 1780108	
	<b>Description</b> Pu Bushing		

	SEM NO.	REF. NO.	Type / Model
	10250	1375299 1768269	
	<b>Description</b> Metal Bush		

	SEM NO.	REF. NO.	Type / Model
	10251	1324712	
	<b>Description</b> Seal Ring		

Type / Model	REF. NO.	SEM NO.	
	804831	10252	
		<b>Description</b>	
		Ring	

**Description / Repair Kit for Cabin**      **SEM NO.**      **Model:**

**8314**



**REF. NO:** 1377562S  
1385170S  
1381893S

Item No	Ref. No
1	1377562
2	1385170
3	

D=Ø60    d=Ø16    h=80

**Description / Repair Kit for Cabin**      **SEM NO.**      **Model:**

**8315**

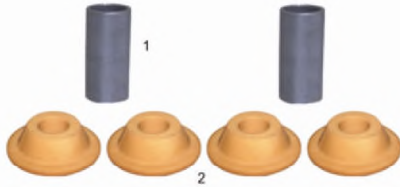

**REF. NO:** 1343134S  
1343135S  
1481245S  
1894408S

Item No	Ref. No
1	1343135
2	1481245 - 1343134
	1894408

D=Ø63    d=Ø21    h=20

**Description / Repair Kit for Cabin**      **SEM NO.**      **Model:**

**8332**



**REF. NO:** 1375299S  
1768269S

Item No	Ref. No
1	1768269
2	1324713
3	-----
4	1324712
5	-----
6	804831

**Description / Repair Kit for Cabin (alternatively bearing)**      **SEM NO.**      **Model:**

**8332-1**



**REF. NO:** 1375299S  
1768269S

Item No	Ref. No
1	1768269
2	1324713
3	-----
4	1324712
5	-----
6	804831

**Model:** **ŞEM NO.** **Description / Repair Kit for Cabin**

**8350**

**REF. NO:**  
1742449  
1539498



**Model:** **ŞEM NO.** **Description / Repair Kit for Cabin (original bearing)**

**8351**

Item No	Ref. No
1	1744210 - 1504160
	1443114 - 1364293
2	1459188 - 1343149
	1780108

**REF. NO:**  
1744210S1  
1504160S1  
1443114S1  
1364293S1  
1459188S  
1343149S  
1780108S



d=Ø16 h=81

**Model:** **ŞEM NO.** **Description / Repair Kit for Cabin (alternatively bearing)**

**8351-1**

Item No	Ref. No
1	1744210 - 1504160
	1443114 - 1364293
2	1459188 - 1343149
	1780108

**REF. NO:**  
1744210S1  
1504160S1  
1443114S1  
1364293S1  
1459188S  
1343149S  
1780108S



d=Ø16 h=81

**Model:** **ŞEM NO.** **Description / Repair Kit for Cabin (original bearing)**

**8352**

Item No	Ref. No
1	1744211 - 1426202
2	1459188 - 1343149
	1780108

**REF. NO:**  
1744211S1  
1426202S1  
1459188S1  
1343149S1  
1780108S1



d=Ø16 h=120

Description / Repair Kit for Cabin (alternatively bearing)	SEM NO.	Model:							
	<b>8352-1</b>								
	<b>REF. NO:</b> 1744211S1 1426202S1 1459188S1 1343149S1 1780108S1	<table border="1"> <thead> <tr> <th>Item No</th> <th>Ref. No</th> </tr> </thead> <tbody> <tr> <td>1</td> <td>1744211 - 1426202</td> </tr> <tr> <td>2</td> <td>1459188 - 1343149</td> </tr> <tr> <td></td> <td>1780108</td> </tr> </tbody> </table>	Item No	Ref. No	1	1744211 - 1426202	2	1459188 - 1343149	
Item No	Ref. No								
1	1744211 - 1426202								
2	1459188 - 1343149								
	1780108								
	d=Ø16 h=120								

Description / Cabin Repair Kit	SEM NO.	Model:																			
	<b>9133</b>																				
	<b>REF. NO:</b> 385266S	<table border="1"> <thead> <tr> <th>Item No</th> <th>Ref. No</th> </tr> </thead> <tbody> <tr> <td>1</td> <td>385266</td> </tr> <tr> <td>2</td> <td>346085</td> </tr> <tr> <td>3</td> <td>814918</td> </tr> <tr> <td>4</td> <td>311755</td> </tr> <tr> <td>5</td> <td>814916</td> </tr> <tr> <td>6</td> <td>325014</td> </tr> <tr> <td>7</td> <td>815126</td> </tr> <tr> <td>8</td> <td>318276</td> </tr> <tr> <td>9</td> <td>803005</td> </tr> </tbody> </table>	Item No	Ref. No	1	385266	2	346085	3	814918	4	311755	5	814916	6	325014	7	815126	8	318276	9
Item No	Ref. No																				
1	385266																				
2	346085																				
3	814918																				
4	311755																				
5	814916																				
6	325014																				
7	815126																				
8	318276																				
9	803005																				

Description / Cabin Repair Kit	SEM NO.	Model:															
	<b>9141</b>																
	<b>REF. NO:</b> 1302008S	<table border="1"> <thead> <tr> <th>Item No</th> <th>Ref. No</th> </tr> </thead> <tbody> <tr> <td>1</td> <td>1302008</td> </tr> <tr> <td>2</td> <td>1301941</td> </tr> <tr> <td>3</td> <td>346085</td> </tr> <tr> <td>4</td> <td>814909</td> </tr> <tr> <td>5</td> <td>814842</td> </tr> <tr> <td>6</td> <td>815149</td> </tr> <tr> <td>7</td> <td>204658</td> </tr> </tbody> </table>	Item No	Ref. No	1	1302008	2	1301941	3	346085	4	814909	5	814842	6	815149	7
Item No	Ref. No																
1	1302008																
2	1301941																
3	346085																
4	814909																
5	814842																
6	815149																
7	204658																

Description / Repair Kit for Cabin	SEM NO.	Model:											
	<b>9149</b>												
	<b>REF. NO:</b> 346085S	<table border="1"> <thead> <tr> <th>Item No</th> <th>Ref. No</th> </tr> </thead> <tbody> <tr> <td>1</td> <td>311755</td> </tr> <tr> <td>2</td> <td>814918</td> </tr> <tr> <td>3</td> <td>346085</td> </tr> <tr> <td>4</td> <td>----</td> </tr> <tr> <td>5</td> <td>815126</td> </tr> </tbody> </table>	Item No	Ref. No	1	311755	2	814918	3	346085	4	----	5
Item No	Ref. No												
1	311755												
2	814918												
3	346085												
4	----												
5	815126												



Model:	SEM NO.	Description / Cabin Repair Kit
	<b>9150</b>	
<b>Item No</b>	<b>Ref. No</b>	<b>REF. NO:</b>
1	0385266	385266S1
2	325014	
3	814916	
4	815126	
5	----	



Model:	SEM NO.	Description / Cabin Repair Kit
	<b>9151</b>	
<b>Item No</b>	<b>Ref. No</b>	<b>REF. NO:</b>
1	1301941	346085S1
2	814909	
3	346085	
4	815149	
5	804658	



Model:	SEM NO.	Description / Cabin Repair Kit
	<b>9152</b>	
<b>Item No</b>	<b>Ref. No</b>	<b>REF. NO:</b>
1	1302008	1302008S1
2	814842	



Model:	SEM NO.	Description / Repair Kit for Cabin (original bearing)
	<b>10841</b>	
<b>Item No</b>	<b>Ref. No</b>	<b>REF. NO:</b>
1	1377562	1768270S
2	1768269	1377562S1
3	-----	1385170S1
4	1349810	1381893S1
5	1324713	1349810S
6	1385170 - 1381893	
7	1324712	
8	815123	
9	-----	
10	804831	









Description / Repair Kit for Cabin (alternatively bearing)	SEM NO.	Model:																					
	<b>10841-1</b>																						
	<b>REF. NO:</b> 1768270S 1377562S1 1385170S1 1381893S1 1349810S	<table border="1"> <thead> <tr> <th>Item No</th> <th>Ref. No</th> </tr> </thead> <tbody> <tr><td>1</td><td>1377562</td></tr> <tr><td>2</td><td>1768269</td></tr> <tr><td>3</td><td>-----</td></tr> <tr><td>4</td><td>1349810</td></tr> <tr><td>5</td><td>1324713</td></tr> <tr><td>6</td><td>1385170 - 1381893</td></tr> <tr><td>7</td><td>1324712</td></tr> <tr><td>8</td><td>815123</td></tr> <tr><td>9</td><td>-----</td></tr> <tr><td>10</td><td>804831</td></tr> </tbody> </table>	Item No	Ref. No	1	1377562	2	1768269	3	-----	4	1349810	5	1324713	6	1385170 - 1381893	7	1324712	8	815123	9	-----	10
Item No	Ref. No																						
1	1377562																						
2	1768269																						
3	-----																						
4	1349810																						
5	1324713																						
6	1385170 - 1381893																						
7	1324712																						
8	815123																						
9	-----																						
10	804831																						









Description / Repair Kit for Cabin (original bearing)	SEM NO.	Model:
	<b>10862</b>	
	<b>REF. NO:</b> 1755638	







M16x20/35 h=67,5





Description / Repair Kit for Cabin (Alternatively bearing)	SEM NO.	Model:
	<b>10862-1</b>	
	<b>REF. NO:</b> 1755638	

M16x20/35 h=67,5

Type / Model	REF. NO.	SEM NO.	
93 113 143 T 113 T 143	1348121 MONROE:C80066 SACHS: 481002	<b>8151</b>	<b>Description</b> Cabin Suspansion Spring
			
Type / Model	REF. NO.	SEM NO.	
93 113 143 T 113 T 143	1331626 1331621 1331635 393257/393208/393290 1117320 1117334 1331634 370227/370228	1331620 1116535 1348118 1348119/1348121 550365 1348120/1348121 1348117 1348477/1348121	1117326 1531200011 MONROE CB0066/CB0065 SACHS 105875 SACHS 112320 SACHS 105831 SACHS 1105845 SACHS 105876
		<b>8152</b>	<b>Description</b> Cabin Suspansion Spring Wit Shock Absorber
			
Type / Model	REF. NO.	SEM NO.	
4 SERIE 94 114 124 144 164	1349840 MONROE:CB0067 SACHS:557001	<b>8153</b>	<b>Description</b> Cabin Suspansion Spring
			
Type / Model	REF. NO.	SEM NO.	
4 SERIE 94 114 124 144 164	1363122 1424228 1424227 1397396 1397400 1435859 1363120	MONROE CB0067 +CB0058 SACHS 105871 SACHS 105872 SACHS 290201 SACHS 290203 SACHS 290988 SACHS 290987	<b>8154</b> <b>Description</b> Cabin Suspansion Spring Wit Shock Absorber
			
Type / Model	REF. NO.	SEM NO.	
4 SERIE 94 114 124 144 164	1349844 1382826 1382827 1382829 1424229 MONROE CB0067 +CB0059 SACHS 105873 SACHS 290989	<b>8155</b>	<b>Description</b> Cabin Suspansion Spring Wit Shock Absorber
			
Type / Model	REF. NO.	SEM NO.	
P & R SERIE, 4 SERIE	138 1919 147 6415 MONROE 717262725 MONROE Cb0030	<b>8156 (8468)</b>	<b>Description</b> Cabin Suspansion Spring
			

	<b>SEM NO.</b>	<b>REF. NO.</b>	<b>Type / Model</b>
	8157 (8469)	1381903 1397400 / 1381919 1381904 / 1381919 1397400 / 1476415 1381904 / 1476415 1435859 / 1381919 1397395 1485852 1397399 MONROE CB0010+CB0030	P&R SERIE, 4 SERIE
	<b>SEM NO.</b>	<b>REF. NO.</b>	<b>Type / Model</b>
	8158	1381905 1397398 / 1476415 1381906 / 1381919 1435853 1381906 / 1476415 1435856 / 1381919 1397393 / 1435856 / 1476415 1397397 1397398 / 1381919 MONROE CB0009 + CB0030	P&R SERIE, 4 SERIE
	<b>SEM NO.</b>	<b>REF. NO.</b>	<b>Type / Model</b>
	8355	1424231 310619 Cb0067	R Serie
	<b>SEM NO.</b>	<b>REF. NO.</b>	<b>Type / Model</b>
	8356	1502471 1502468 MONROE Cb0074	R Serie
	<b>SEM NO.</b>	<b>REF. NO.</b>	<b>Type / Model</b>
	8357	1502470 1502474 1502471 MONROE CB0074+CB0078	R Serie
	<b>SEM NO.</b>	<b>REF. NO.</b>	<b>Type / Model</b>
	8467		R Serie
	<b>SEM NO.</b>	<b>REF. NO.</b>	<b>Type / Model</b>
	<b>SEM NO.</b>	<b>REF. NO.</b>	<b>Type / Model</b>

<b>Type / Model</b>	<b>REF. NO.</b>	<b>SEM NO.</b>	
R Serie	1505563 MONROE CB0130+CB0134 SACHS 312465 SACHS 310620	<b>8471</b>	
			<b>Description</b> Cabin Suspansion Spring With Shock Absorber
<b>Type / Model</b>	<b>REF. NO.</b>	<b>SEM NO.</b>	
R Serie	1363120 1397396 1397390 1397392 MONROE CB0058+CB0130 SACHS 312465 SACHS 290987	<b>10811</b>	
			<b>Description</b> Cabin Suspansion Spring With Shock Absorber
<b>Type / Model</b>	<b>REF. NO.</b>	<b>SEM NO.</b>	
R Serie	1502473 1505563 MONROE CB0067+CB0134 SACHS 310620	<b>12819</b>	
			<b>Description</b> Shock Absorber For Kabin
<b>Type / Model</b>	<b>REF. NO.</b>	<b>SEM NO.</b>	
4 Serie 94 114 124 144 164	1444016 MONROE CB 0130	<b>8470</b>	
			<b>Description</b> Cabin Suspansion Spring
<b>Type / Model</b>	<b>REF. NO.</b>	<b>SEM NO.</b>	
8152	1348120 1348119	<b>9505</b>	
			<b>Description</b> Shock Absorber for Cabin
<b>Type / Model</b>	<b>REF. NO.</b>	<b>SEM NO.</b>	
8154	1363120	<b>9506</b>	
			<b>Description</b> Shock Absorber for Cabin

	SEM NO.	REF. NO.	Type / Model
	9507	1424229	8155
	<p><b>Description</b> Shock Absorber for Cabin</p>		
	9508	1435859	8157
	<p><b>Description</b> Shock Absorber for Cabin</p>		
	9509	1397398	8158
	<p><b>Description</b> Shock Absorber for Cabin</p>		
	9510	1502474	8357
	<p><b>Description</b> Shock Absorber for Cabin</p>		
	9511	1505563	8467
	<p><b>Description</b> Shock Absorber for Cabin</p>		

Type / Model	REF. NO.	SEM NO.	
	0389035	8247	 <b>Description</b> Pedal Cover

**Cab Group**  
Cab&ody Stopper, Plates anad Rubber Tension Products

Type / Model	REF. NO.	SEM NO.	
	1383858	10874	 <b>Description</b> Rubber Buffer
	1377600		
	1358343		
			L=180

SEM NO.	REF. NO.	Type / Model
<b>8390</b>	1306492	124 144 LCG
		
<b>Description</b> Pressure Spring		
505 MM 250 N		



SEM NO.	REF. NO.	Type / Model
<b>8391</b>	1331164	113M 143H
		
<b>Description</b> Pressure Spring		
600 MM 700 N		

SEM NO.	REF. NO.	Type / Model
<b>8392</b>		124 144L
		
<b>Description</b> Pressure Spring		
210 MM 100 N		

SEM NO.	REF. NO.	Type / Model
<b>8393</b>	1369553	VARIOS
		
<b>Description</b> Pressure Spring		
120 MM 300 N		

SEM NO.	REF. NO.	Type / Model
<b>9226</b>	1123692 341299 353592 341292	
		
<b>Description</b> Pressure Spring		
590-630N		

SEM NO.	REF. NO.	Type / Model
<b>9227</b>	322929 312445	
		
<b>Description</b> Pressure Spring		
600-500N		

<b>Type / Model</b>	<b>REF. NO.</b>	<b>SEM NO.</b>	
	1481371	9717	
			<b>Description</b> Pressure Spring 684-300-400N.
<b>Type / Model</b>	<b>REF. NO.</b>	<b>SEM NO.</b>	
P / R SERIES	1492494	10657	
			<b>Description</b> Pressure Spring 140-35-250N.
<b>Type / Model</b>	<b>REF. NO.</b>	<b>SEM NO.</b>	
P / R SERIES	1727269	10658	
			<b>Description</b> Pressure Spring 155-45-250N.
<b>Type / Model</b>	<b>REF. NO.</b>	<b>SEM NO.</b>	
P / R SERIES	1435542	10659	
			<b>Description</b> Pressure Spring 586-255-400N.
<b>Type / Model</b>	<b>REF. NO.</b>	<b>SEM NO.</b>	
R	1481373	10660	
			<b>Description</b> Pressure Spring 685-300-250N.
<b>Type / Model</b>	<b>REF. NO.</b>	<b>SEM NO.</b>	
P	1481372 1845910	10661	
			<b>Description</b> Pressure Spring 785-350-250N.



SEM NO.	REF. NO.	Type / Model
11018	387729	
 <p><b>Description</b> Pressure Spring</p>		
265-200N		

SEM NO.	REF. NO.	Type / Model
11019	1366398	
 <p><b>Description</b> Pressure Spring</p>		
445-65N		

SEM NO.	REF. NO.	Type / Model
11020	417113	
 <p><b>Description</b> Pressure Spring</p>		
490-900N		

SEM NO.	REF. NO.	Type / Model
11021	192929	
 <p><b>Description</b> Pressure Spring</p>		
105-100N		

SEM NO.	REF. NO.	Type / Model
11028	1346570	
 <p><b>Description</b> Pressure Spring</p>		
316-400N		



SEM NO.	REF. NO.	Type / Model
11029	1383831	
 <p><b>Description</b> Pressure Spring</p>		
147-400N		







Type / Model	REF. NO.	SEM NO.	
	322201	11030	 <b>Description</b> Pressure Spring

225-700N

**Cab Group**  
Cab Locks and Equipments

**4 - 8**

Type / Model	REF. NO.	SEM NO.	
	1810345	11534	 <b>Description</b> Cabin Locked
	1383496 1461191	11535	 <b>Description</b> Cabin Locked

	SEM NO.	REF. NO.	Type / Model
	11631	1399788	
	<b>Description</b> Cluth Lever		
	11632	1399788S	
	<b>Description</b> Cluth Lever Complete		
	11633	1399788S1	
	<b>Description</b> Cluth Lever Repair Kit		
	11743	1773621	
	<b>Description</b> Clutch Lever Complete		
	11744	1773621S	
	<b>Description</b> Clutch Lever Repair Kit		
	11745	1737306	
	<b>Description</b> Clutch Lever Complete		

Type / Model	REF. NO.	SEM NO.	
	1737306S	11746	
		<b>Description</b> Clutch Lever Repair Kit	

SEM NO.		REF. NO.	Type / Model
12842		1789567 1358634	
<b>Description</b>			
Brake Slack Adjuster, Automatic-Right			
Ø 16x165x84°			



SEM NO.		REF. NO.	Type / Model
12843		1789561 394181 1112833	
<b>Description</b>			
Brake Slack Adjuster, Automatic-Left			
Ø 16x165x308°			

SEM NO.		REF. NO.	Type / Model
12844		1789562 1112834 394182	
<b>Description</b>			
Brake Slack Adjuster, Automatic-Right			
Ø 16x165x308°			

SEM NO.		REF. NO.	Type / Model
12847		1789568 1358635	
<b>Description</b>			
Brake Slack Adjuster, Automatic-Left			
Ø 16x165x84°			

SEM NO.		REF. NO.	Type / Model
12871		1789560 384419 1112831	
<b>Description</b>			
Brake Slack Adjuster, Automatic			
Ø 16x165x308°			

SEM NO.		REF. NO.	Type / Model
12872		1112829 384417	
<b>Description</b>			
Brake Slack Adjuster, Automatic-Left			
Ø 16x165x73°			

Type / Model	REF. NO.		SEM NO.	
	1112830 384418		12873	  <b>Description</b> Brake Slack Adjuster, Automatic-Right



SEM NO.	REF. NO.	Type / Model
10683	1390429	KN TYPE All SB 5..., SB 6..., SB 7..., SN 5... Series
	1746824	
	1759811	

**Description**  
Caliper Repair Kit

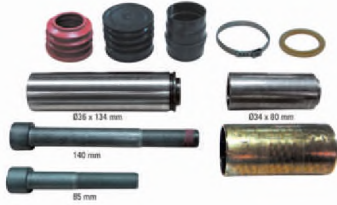

SEM NO.	REF. NO.	Type / Model
10693	1798063	KN TYPE SB 7122, SB 7132, SB 7126, SB 7136, SB 7586, SB 7596, SB 7666, SB 7676, SB 7785, SB 7795, SB 7840,

**Description**  
Caliper Repair Kit

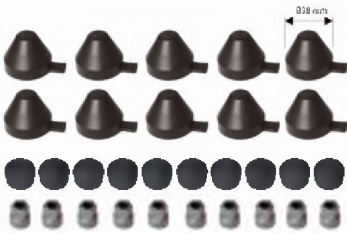

SEM NO.	REF. NO.	Type / Model
10696	1390430	KN TYPE SB 5..., SB 6..., SB 7... Series

**Description**  
Caliper Repair Kit



SEM NO.	REF. NO.	Type / Model
11814	1906779	KN TYPE SN 7
	1756390	

**Description**  
Caliper Repair Kit





SEM NO.	REF. NO.	Type / Model
12184	1415149	KN TYPE All SB...

**Description**  
Caliper Repair Kit



SEM NO.	REF. NO.	Type / Model
12216	1477675	KN TYPE SB 7122, SB 7132, SB 7126, SB 7136, SB 7586, SB 7596, SB 7666, SB 7676
	1527631	

**Description**  
Caliper Repair Kit

Type / Model	REF. NO.	ŞEM NO.	
KN TYPE SB 7648, SB 7666, SB 6506, SB 7108, SB 7122, SB 71..., SB 7785, SB 7795, SB 7825, SB 7835, SB 7842, SB 7852, SB 7882	1390427	12225	 <p><b>Description</b> Caliper Repair Kit</p>
KN TYPE SB 7	1415149	12235	 <p><b>Description</b> Caliper Repair Kit</p>
KN TYPE  SB 7..., SN 7..., SCANIA	1756388	12283	 <p><b>Description</b> Caliper Repair Kit 22.5</p>











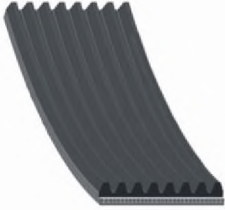
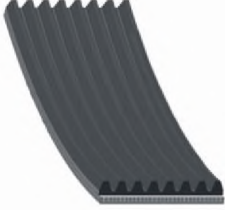
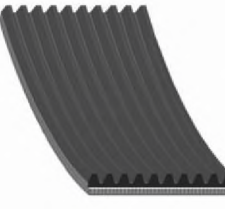
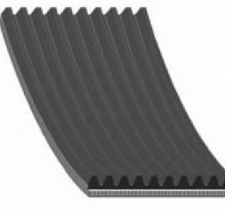
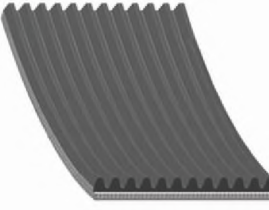

## IVECO GROUP



Engine and Transmission Group .....	: 764 - 783
Steering Group .....	: 784 - 789
Suspension Group .....	: 790 - 822
Cab Group .....	: 823 - 837
Axle / Differential ve Shaft Group.....	: 838 - 839
Clutch and Brake Group.....	: 840 - 846

 8PK1230	<table border="1"> <thead> <tr> <th>SEM NO.</th> <th>REF. NO.</th> <th>Type / Model</th> </tr> </thead> <tbody> <tr> <td>10324</td> <td>4898546</td> <td></td> </tr> <tr> <td colspan="3"><b>Description</b></td> </tr> <tr> <td colspan="3">V Ribbed Belt</td> </tr> </tbody> </table>	SEM NO.	REF. NO.	Type / Model	10324	4898546		<b>Description</b>			V Ribbed Belt									
SEM NO.	REF. NO.	Type / Model																		
10324	4898546																			
<b>Description</b>																				
V Ribbed Belt																				
 8PK1630	<table border="1"> <thead> <tr> <th>SEM NO.</th> <th>REF. NO.</th> <th>Type / Model</th> </tr> </thead> <tbody> <tr> <td>11688</td> <td>500387660</td> <td></td> </tr> <tr> <td colspan="3"><b>Description</b></td> </tr> <tr> <td colspan="3">V Ribbed Belt</td> </tr> </tbody> </table>	SEM NO.	REF. NO.	Type / Model	11688	500387660		<b>Description</b>			V Ribbed Belt									
SEM NO.	REF. NO.	Type / Model																		
11688	500387660																			
<b>Description</b>																				
V Ribbed Belt																				
 10PK1720	<table border="1"> <thead> <tr> <th>SEM NO.</th> <th>REF. NO.</th> <th>Type / Model</th> </tr> </thead> <tbody> <tr> <td>11700</td> <td>504056043</td> <td></td> </tr> <tr> <td colspan="3"><b>Description</b></td> </tr> <tr> <td colspan="3">V Ribbed Belt</td> </tr> </tbody> </table>	SEM NO.	REF. NO.	Type / Model	11700	504056043		<b>Description</b>			V Ribbed Belt									
SEM NO.	REF. NO.	Type / Model																		
11700	504056043																			
<b>Description</b>																				
V Ribbed Belt																				
 10PK1725	<table border="1"> <thead> <tr> <th>SEM NO.</th> <th>REF. NO.</th> <th>Type / Model</th> </tr> </thead> <tbody> <tr> <td>10403 (10404)</td> <td>500328020</td> <td></td> </tr> <tr> <td colspan="3"><b>Description</b></td> </tr> <tr> <td colspan="3">V Ribbed Belt</td> </tr> </tbody> </table>	SEM NO.	REF. NO.	Type / Model	10403 (10404)	500328020		<b>Description</b>			V Ribbed Belt									
SEM NO.	REF. NO.	Type / Model																		
10403 (10404)	500328020																			
<b>Description</b>																				
V Ribbed Belt																				
 12PK1815	<table border="1"> <thead> <tr> <th>SEM NO.</th> <th>REF. NO.</th> <th>Type / Model</th> </tr> </thead> <tbody> <tr> <td>10412</td> <td>500341808 504027703 504049425</td> <td></td> </tr> <tr> <td colspan="3"><b>Description</b></td> </tr> <tr> <td colspan="3">V Ribbed Belt</td> </tr> </tbody> </table>	SEM NO.	REF. NO.	Type / Model	10412	500341808 504027703 504049425		<b>Description</b>			V Ribbed Belt									
SEM NO.	REF. NO.	Type / Model																		
10412	500341808 504027703 504049425																			
<b>Description</b>																				
V Ribbed Belt																				
 2XAVX13X1025	<table border="1"> <thead> <tr> <th>SEM NO.</th> <th>REF. NO.</th> <th>Type / Model</th> </tr> </thead> <tbody> <tr> <td>12901</td> <td>02419105 4732571 98463584 4732574</td> <td></td> </tr> <tr> <td colspan="3"><b>Description</b></td> </tr> <tr> <td colspan="3">V Ribbed Belt</td> </tr> </tbody> </table>	SEM NO.	REF. NO.	Type / Model	12901	02419105 4732571 98463584 4732574		<b>Description</b>			V Ribbed Belt			<table border="1"> <thead> <tr> <th>SEM NO.</th> <th>REF. NO.</th> <th>Type / Model</th> </tr> </thead> <tbody> <tr> <td></td> <td>98465794 98465898</td> <td></td> </tr> </tbody> </table>	SEM NO.	REF. NO.	Type / Model		98465794 98465898	
SEM NO.	REF. NO.	Type / Model																		
12901	02419105 4732571 98463584 4732574																			
<b>Description</b>																				
V Ribbed Belt																				
SEM NO.	REF. NO.	Type / Model																		
	98465794 98465898																			

<b>Type / Model</b>	<b>REF. NO.</b>	<b>SEM NO.</b>	
EU.TECH EU.TRACKER	8161343	8583	
			<b>Description</b> Radiator Upper Hose
			58x58x475
<b>Type / Model</b>	<b>REF. NO.</b>	<b>SEM NO.</b>	
EU.TECH EU.STAR	8161344	8584	
			<b>Description</b> Radiator Lower Hose
			58x58x830
<b>Type / Model</b>	<b>REF. NO.</b>	<b>SEM NO.</b>	
EU.TRACKER	8161345	8585	
			<b>Description</b> Radiator Lower Hose
			60x60x1000
<b>Type / Model</b>	<b>REF. NO.</b>	<b>SEM NO.</b>	
STRALIS	41218703	8586	
			<b>Description</b> Radiator Lower Hose
			55x57x720
<b>Type / Model</b>	<b>REF. NO.</b>	<b>SEM NO.</b>	
STRALIS	204044093	8587	
			<b>Description</b> Radiator Upper Hose
			55x57x525
<b>Type / Model</b>	<b>REF. NO.</b>	<b>SEM NO.</b>	
EU.CARGO EU.BUS	500339054	8588	
			<b>Description</b> Radiator Lower Hose
			40x44x545

SEM NO.	REF. NO.	Type / Model
8589	500339052	EU.CARGO EU.BUS
<b>Description</b> Radiator Upper Hose		
44x44x490		



SEM NO.	REF. NO.	Type / Model
10593	41218108	TRAKKER
<b>Description</b> Radiator Upper Hose		
58x58x510		



SEM NO.	REF. NO.	Type / Model
10594	41218109 41270112	TRAKKER
<b>Description</b> Radiator Lower Hose		
58x58x710		



SEM NO.	REF. NO.	Type / Model
10595	41226988	STRALIS
<b>Description</b> Radiator Upper Hose		
58x58x670		









SEM NO.	REF. NO.	Type / Model
10596	41225411	STRALIS
<b>Description</b> Radiator Lower Hose		
58x58x530		



SEM NO.	REF. NO.	Type / Model
10597	504225293	EUROCARGO
<b>Description</b> Heating Hose		
15x15x220		



<b>Type / Model</b>	<b>REF. NO.</b>	<b>SEM NO.</b>	
EUROCARGO	500362700	10598	
			<b>Description</b> Radiator Lower Hose 48x42x620
<b>Type / Model</b>	<b>REF. NO.</b>	<b>SEM NO.</b>	
EUROCARGO	504294844	10599	
			<b>Description</b> Radiator Upper Hose 42x42x700
<b>Type / Model</b>	<b>REF. NO.</b>	<b>SEM NO.</b>	
DAILY 35C11	99487933	10600	
			<b>Description</b> Radiator Hose 36x36x490
<b>Type / Model</b>	<b>REF. NO.</b>	<b>SEM NO.</b>	
DAILY 35C11	99487932	10601	
			<b>Description</b> Radiator Hose 36x36x405
<b>Type / Model</b>	<b>REF. NO.</b>	<b>SEM NO.</b>	
DAILY 35.10	93809147	10602	
			<b>Description</b> Radiator Upper Hose 38x38x338
<b>Type / Model</b>	<b>REF. NO.</b>	<b>SEM NO.</b>	
DAILY 35.10	1904633	10603	
			<b>Description</b> Water Hose 16x16x860

	SEM NO.	REF. NO.	Type / Model
	<b>10604</b>	1902353	DAILY 35.10
	<b>Description</b> Water Hose		
8x8x1000			







	SEM NO.	REF. NO.	Type / Model
	<b>10605</b>	4852224	DAILY 35.10
	<b>Description</b> Water Hose		
15x15x140			

	SEM NO.	REF. NO.	Type / Model
	<b>10606</b>	93815254	DAILY 35.10
	<b>Description</b> Water Hose		
15x15x215			







	SEM NO.	REF. NO.	Type / Model
	<b>10607</b>	93811591	DAILY 35C11
	<b>Description</b> Radiator Lower Hose		
37x37x410			







	SEM NO.	REF. NO.	Type / Model
	<b>10608</b>	93824282	DAILY 35C11
	<b>Description</b> Radiator Upper Hose		
37x37x330			

	SEM NO.	REF. NO.	Type / Model
	<b>10609</b>	41271761	STRALIS
	<b>Description</b> Radiator Hose		
58x58x560			

Type / Model	REF. NO.	SEM NO.	
STRALIS	41022071	10610	 <p><b>Description</b> Water Hose</p> <p>19x19x1005</p>
STRALIS	41227335	10611	 <p><b>Description</b> Water Hose</p> <p>27x30x780</p>
E.TRAK	41807074	10612	 <p><b>Description</b> Water Hose</p> <p>10x10x1100</p>
E.TRAK	8160005	10613	 <p><b>Description</b> Water Hose</p> <p>58x58x660</p>
DAILY 35.10	4852226	10614	 <p><b>Description</b> Water Hose</p> <p>16x16x365</p>
NEW DAILY 30-8	99461491	10615	 <p><b>Description</b> Water Hose</p> <p>16x16x400</p>



	<table border="1"> <thead> <tr> <th>SEM NO.</th> <th>REF. NO.</th> <th>Type / Model</th> </tr> </thead> <tbody> <tr> <td>10616</td> <td>504098508</td> <td>40C15 VH</td> </tr> </tbody> </table>	SEM NO.	REF. NO.	Type / Model	10616	504098508	40C15 VH	<p><b>Description</b> Intercooler Hose</p>
SEM NO.	REF. NO.	Type / Model						
10616	504098508	40C15 VH						
53x58x780								
	<table border="1"> <thead> <tr> <th>SEM NO.</th> <th>REF. NO.</th> <th>Type / Model</th> </tr> </thead> <tbody> <tr> <td>10617</td> <td>504300627</td> <td>35C13 VAN</td> </tr> </tbody> </table>	SEM NO.	REF. NO.	Type / Model	10617	504300627	35C13 VAN	<p><b>Description</b> Intercooler Hose</p>
SEM NO.	REF. NO.	Type / Model						
10617	504300627	35C13 VAN						
59x59x680								
	<table border="1"> <thead> <tr> <th>SEM NO.</th> <th>REF. NO.</th> <th>Type / Model</th> </tr> </thead> <tbody> <tr> <td>10618</td> <td>504300628</td> <td>35C11</td> </tr> </tbody> </table>	SEM NO.	REF. NO.	Type / Model	10618	504300628	35C11	<p><b>Description</b> Intercooler Hose</p>
SEM NO.	REF. NO.	Type / Model						
10618	504300628	35C11						
59x63x660								
	<table border="1"> <thead> <tr> <th>SEM NO.</th> <th>REF. NO.</th> <th>Type / Model</th> </tr> </thead> <tbody> <tr> <td>10619</td> <td>12081287</td> <td>M-14</td> </tr> </tbody> </table>	SEM NO.	REF. NO.	Type / Model	10619	12081287	M-14	<p><b>Description</b> Water Hose</p>
SEM NO.	REF. NO.	Type / Model						
10619	12081287	M-14						
27x27x100								
	<table border="1"> <thead> <tr> <th>SEM NO.</th> <th>REF. NO.</th> <th>Type / Model</th> </tr> </thead> <tbody> <tr> <td>10620</td> <td>8590626</td> <td>85.12</td> </tr> </tbody> </table>	SEM NO.	REF. NO.	Type / Model	10620	8590626	85.12	<p><b>Description</b> Water Pump Hose</p>
SEM NO.	REF. NO.	Type / Model						
10620	8590626	85.12						
41x38x70								
	<table border="1"> <thead> <tr> <th>SEM NO.</th> <th>REF. NO.</th> <th>Type / Model</th> </tr> </thead> <tbody> <tr> <td>10621</td> <td>8570833</td> <td>85.12</td> </tr> </tbody> </table>	SEM NO.	REF. NO.	Type / Model	10621	8570833	85.12	<p><b>Description</b> Water Hose</p>
SEM NO.	REF. NO.	Type / Model						
10621	8570833	85.12						
18x18x60								

Type / Model	REF. NO.	SEM NO.	
M29.12	10136187	10622	 <p><b>Description</b> Water Hose</p> <p>40x40x80</p>
M50HF	4817952	10623	 <p><b>Description</b> Air Hose</p> <p>18x24x820</p>
M24.9	8590624	10624	 <p><b>Description</b> Radiator Lower Hose</p> <p>38x45x78</p>
M29.14	8591475	10625	 <p><b>Description</b> Water Hose</p> <p>29x25x121</p>
M50HF	98425606	10626	 <p><b>Description</b> Water Hose</p> <p>17x17x110</p>
M50HF	98425477	10627	 <p><b>Description</b> Air Kompressor Hose</p> <p>11x11x79</p>



7x7x705

SEM NO.	REF. NO.	Type / Model
10628	500329994	DAILY 35C11

**Description**  
Radiator Hose



57x545

SEM NO.	REF. NO.	Type / Model
11110	41218702	STRALIS

**Description**  
Radiator Hose



30x26x19x153

SEM NO.	REF. NO.	Type / Model
11111	8161791	EUROTECH

**Description**  
Water Hose



36x36x850

SEM NO.	REF. NO.	Type / Model
11904	504215702	

**Description**  
Radiator Hose



36x36x335

SEM NO.	REF. NO.	Type / Model
11905	504086541	













**Description**  
Radiator Hose



59x525

SEM NO.	REF. NO.	Type / Model
11906	41218106	

**Description**  
Radiator Hose

<b>Type / Model</b>	<b>REF. NO.</b>		<b>SEM NO.</b>	
	41218107		11907	
				<b>Description</b> Radiator Hose
				59x755
<b>Type / Model</b>	<b>REF. NO.</b>		<b>SEM NO.</b>	
	41222255		11908	
				<b>Description</b> Water Hose
				20x20x280
<b>Type / Model</b>	<b>REF. NO.</b>		<b>SEM NO.</b>	
	41001161		11909	
				<b>Description</b> Water Hose
				27x27x195
<b>Type / Model</b>	<b>REF. NO.</b>		<b>SEM NO.</b>	
	41227336		11910	
				<b>Description</b> Water Hose
				19x19x1060
<b>Type / Model</b>	<b>REF. NO.</b>		<b>SEM NO.</b>	
	41222840		11911	
				<b>Description</b> Oil Hose
				21x21x240
<b>Type / Model</b>	<b>REF. NO.</b>		<b>SEM NO.</b>	
	41227337		11912	
				<b>Description</b> Water Hose
				19x19x515



**SEM NO.**

11913



**REF. NO.**







41222359

**Type / Model**







**Description**

Water Hose







8x15x1400







Type / Model	REF. NO.	ŞEM NO.	
BLACK RED	42088621	8872	 <p><b>Description</b> Silicon Hose</p> <p>D:Ø88 mm L:160 mm 3 HUMP</p>
BLACK RED	41026109	8873	 <p><b>Description</b> Silicon Hose</p> <p>D:Ø90 mm L:190 mm 3 HUMP</p>
BLUE	8134300	8874	 <p><b>Description</b> Silicon Hose</p> <p>D:Ø88 mm L:260 mm</p>
BLACK RED	99446639 42542872 42543319 500300518	8875	 <p><b>Description</b> Silicon Hose</p> <p>D:Ø72 mm L:230 mm 5 HUMP</p>
GREEN	98423459	8876	 <p><b>Description</b> Silicon Hose</p> <p>D:Ø45 mm L:72 mm</p>
BLUE	500300744	8877	 <p><b>Description</b> Silicon Hose</p> <p>D:Ø57 mm L:230 mm</p>







	<table border="1"> <thead> <tr> <th>SEM NO.</th> <th>REF. NO.</th> <th>Type / Model</th> </tr> </thead> <tbody> <tr> <td>8878 (8897)</td> <td>41210945</td> <td>BLUE</td> </tr> </tbody> </table>	SEM NO.	REF. NO.	Type / Model	8878 (8897)	41210945	BLUE	<table border="1"> <thead> <tr> <th>Type / Model</th> </tr> </thead> <tbody> <tr> <td>BLUE</td> </tr> </tbody> </table>	Type / Model	BLUE
SEM NO.	REF. NO.	Type / Model								
8878 (8897)	41210945	BLUE								
Type / Model										
BLUE										
<p><b>Description</b> Silicon Hose</p> <p>D:Ø47 mm D:Ø57 mm L:102 mm</p>										
	<table border="1"> <thead> <tr> <th>SEM NO.</th> <th>REF. NO.</th> <th>Type / Model</th> </tr> </thead> <tbody> <tr> <td>8879</td> <td>98447313</td> <td>GREEN</td> </tr> </tbody> </table>	SEM NO.	REF. NO.	Type / Model	8879	98447313	GREEN	<table border="1"> <thead> <tr> <th>Type / Model</th> </tr> </thead> <tbody> <tr> <td>GREEN</td> </tr> </tbody> </table>	Type / Model	GREEN
SEM NO.	REF. NO.	Type / Model								
8879	98447313	GREEN								
Type / Model										
GREEN										
<p><b>Description</b> Silicon Hose</p> <p>D:Ø38 mm D:Ø44 mm L:75 mm</p>										
	<table border="1"> <thead> <tr> <th>SEM NO.</th> <th>REF. NO.</th> <th>Type / Model</th> </tr> </thead> <tbody> <tr> <td>8880</td> <td>98432897</td> <td>GREEN</td> </tr> </tbody> </table>	SEM NO.	REF. NO.	Type / Model	8880	98432897	GREEN	<table border="1"> <thead> <tr> <th>Type / Model</th> </tr> </thead> <tbody> <tr> <td>GREEN</td> </tr> </tbody> </table>	Type / Model	GREEN
SEM NO.	REF. NO.	Type / Model								
8880	98432897	GREEN								
Type / Model										
GREEN										
<p><b>Description</b> Silicon Hose</p> <p>D:Ø44 mm D:Ø48 mm L:70 mm</p>										
	<table border="1"> <thead> <tr> <th>SEM NO.</th> <th>REF. NO.</th> <th>Type / Model</th> </tr> </thead> <tbody> <tr> <td>8881</td> <td>4724415</td> <td>GREEN</td> </tr> </tbody> </table>	SEM NO.	REF. NO.	Type / Model	8881	4724415	GREEN	<table border="1"> <thead> <tr> <th>Type / Model</th> </tr> </thead> <tbody> <tr> <td>GREEN</td> </tr> </tbody> </table>	Type / Model	GREEN
SEM NO.	REF. NO.	Type / Model								
8881	4724415	GREEN								
Type / Model										
GREEN										
<p><b>Description</b> Silicon Hose</p> <p>D:Ø28 mm L:240 mm</p>										
	<table border="1"> <thead> <tr> <th>SEM NO.</th> <th>REF. NO.</th> <th>Type / Model</th> </tr> </thead> <tbody> <tr> <td>8882</td> <td>0058289</td> <td>GREEN</td> </tr> </tbody> </table>	SEM NO.	REF. NO.	Type / Model	8882	0058289	GREEN	<table border="1"> <thead> <tr> <th>Type / Model</th> </tr> </thead> <tbody> <tr> <td>GREEN</td> </tr> </tbody> </table>	Type / Model	GREEN
SEM NO.	REF. NO.	Type / Model								
8882	0058289	GREEN								
Type / Model										
GREEN										
<p><b>Description</b> Silicon Hose</p> <p>D:Ø60 mm L:450 mm</p>										
	<table border="1"> <thead> <tr> <th>SEM NO.</th> <th>REF. NO.</th> <th>Type / Model</th> </tr> </thead> <tbody> <tr> <td>8883</td> <td>98421373</td> <td>RED</td> </tr> </tbody> </table>	SEM NO.	REF. NO.	Type / Model	8883	98421373	RED	<table border="1"> <thead> <tr> <th>Type / Model</th> </tr> </thead> <tbody> <tr> <td>RED</td> </tr> </tbody> </table>	Type / Model	RED
SEM NO.	REF. NO.	Type / Model								
8883	98421373	RED								
Type / Model										
RED										
<p><b>Description</b> Silicon Hose</p> <p>D:Ø20 mm L:120 mm</p>										



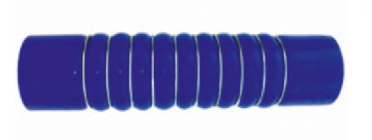

Type / Model	REF. NO.	SEM NO.	
GREEN	4820463	8884	 <p><b>Description</b> Silicon Hose</p> <p>D:Ø50 mm    D:Ø60 mm    L:80 mm</p>
GREEN	4780550	8885	 <p><b>Description</b> Silicon Hose</p> <p>D:Ø30 mm    L:250 mm</p>
GREEN	4792047	8886	 <p><b>Description</b> Silicon Hose</p> <p>D:Ø50 mm    L:225 mm</p>
GREEN	4788289	8887	 <p><b>Description</b> Silicon Hose</p> <p>D:Ø28 mm    L:240 mm</p>
GREEN	98438608	8888	 <p><b>Description</b> Silicon Hose</p> <p>D:Ø28 mm    L:165 mm</p>
BLUE	98463952	8889	 <p><b>Description</b> Silicon Hose</p> <p>D:Ø27,5 mm    D:Ø34 mm    L:135 mm</p>



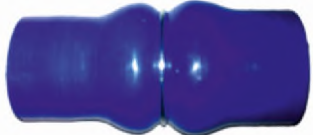

 D:Ø37 mm L:150 mm	<b>SEM NO.</b> <b>8891</b>	<b>REF. NO.</b> 93167510	<b>Type / Model</b> GREEN
	<b>Description</b> Silicon Hose		
 D:Ø57 mm L:100 mm	<b>SEM NO.</b> <b>8892</b>	<b>REF. NO.</b> 98480479	<b>Type / Model</b> BLUE
	<b>Description</b> Silicon Hose		
 D:Ø58 mm L:140 mm 1 HUMP	<b>SEM NO.</b> <b>8893</b>	<b>REF. NO.</b> 93165331	<b>Type / Model</b> GREEN
	<b>Description</b> Silicon Hose		
 D:Ø50 mm D:Ø55 mm L:60 mm	<b>SEM NO.</b> <b>8894</b>	<b>REF. NO.</b> 4787501	<b>Type / Model</b> GREEN
	<b>Description</b> Silicon Hose		
 D:Ø50 mm D:Ø60 mm L:120 mm	<b>SEM NO.</b> <b>8895</b>	<b>REF. NO.</b> 0058287	<b>Type / Model</b> BLACK RED
	<b>Description</b> Silicon Hose		
 D:Ø50 mm D:Ø70 mm L:150 mm	<b>SEM NO.</b> <b>8896</b>	<b>REF. NO.</b> 0098981	<b>Type / Model</b> BLACK RED
	<b>Description</b> Silicon Hose		

Type / Model	REF. NO.	SEM NO.	
RED	61586057	8898	 <p><b>Description</b> Silicon Hose</p> <p>D:Ø48 mm L:90 mm</p>
GREEN	93165466	8899	 <p><b>Description</b> Silicon Hose</p> <p>D:Ø27 mm D:Ø34 mm L:132 mm</p>
RED	98439326	8900	 <p><b>Description</b> Silicon Hose</p> <p>D:Ø17 mm D:Ø37 mm L:125 mm</p>
RED	42070016	8901	 <p><b>Description</b> Silicon Hose</p> <p>D:Ø90 mm L:100 mm</p>
BLUE	99454938	8902	 <p><b>Description</b> Silicon Hose</p> <p>D:Ø75 mm L:80 mm</p>
DAILY 35C11	500339314	10629	 <p><b>Description</b> Wiper Water Hose</p> <p>3,80*110*151</p>

 <p>Ø48x58</p>	<table border="1"> <thead> <tr> <th>SEM NO.</th> <th>REF. NO.</th> <th>Type / Model</th> </tr> </thead> <tbody> <tr> <td>11183</td> <td>99487930</td> <td>RED</td> </tr> </tbody> </table> <p><b>Description</b> Silicon Hose</p>	SEM NO.	REF. NO.	Type / Model	11183	99487930	RED	
SEM NO.	REF. NO.	Type / Model						
11183	99487930	RED						
 <p>Ø 46x66x120X120</p>	<table border="1"> <thead> <tr> <th>SEM NO.</th> <th>REF. NO.</th> <th>Type / Model</th> </tr> </thead> <tbody> <tr> <td>11220</td> <td>98463942</td> <td>BLUE</td> </tr> </tbody> </table> <p><b>Description</b> Silicon Hose</p>	SEM NO.	REF. NO.	Type / Model	11220	98463942	BLUE	
SEM NO.	REF. NO.	Type / Model						
11220	98463942	BLUE						
 <p>Ø 80X280 9 hump</p>	<table border="1"> <thead> <tr> <th>SEM NO.</th> <th>REF. NO.</th> <th>Type / Model</th> </tr> </thead> <tbody> <tr> <td>11221</td> <td>513690</td> <td>BLUE</td> </tr> </tbody> </table> <p><b>Description</b> Silicon Hose</p>	SEM NO.	REF. NO.	Type / Model	11221	513690	BLUE	
SEM NO.	REF. NO.	Type / Model						
11221	513690	BLUE						
 <p>Ø89x200 3 hump</p>	<table border="1"> <thead> <tr> <th>SEM NO.</th> <th>REF. NO.</th> <th>Type / Model</th> </tr> </thead> <tbody> <tr> <td>11222</td> <td>99440309</td> <td>BLACK RED</td> </tr> </tbody> </table> <p><b>Description</b> Silicon Hose</p>	SEM NO.	REF. NO.	Type / Model	11222	99440309	BLACK RED	
SEM NO.	REF. NO.	Type / Model						
11222	99440309	BLACK RED						
 <p>Ø89X170 2 hump</p>	<table border="1"> <thead> <tr> <th>SEM NO.</th> <th>REF. NO.</th> <th>Type / Model</th> </tr> </thead> <tbody> <tr> <td>11223</td> <td>41026110</td> <td>BLACK RED</td> </tr> </tbody> </table> <p><b>Description</b> Silicon Hose</p>	SEM NO.	REF. NO.	Type / Model	11223	41026110	BLACK RED	
SEM NO.	REF. NO.	Type / Model						
11223	41026110	BLACK RED						
 <p>Ø89X310 7 hump</p>	<table border="1"> <thead> <tr> <th>SEM NO.</th> <th>REF. NO.</th> <th>Type / Model</th> </tr> </thead> <tbody> <tr> <td>11224</td> <td>41201190</td> <td>BLACK</td> </tr> </tbody> </table> <p><b>Description</b> Silicon Hose</p>	SEM NO.	REF. NO.	Type / Model	11224	41201190	BLACK	
SEM NO.	REF. NO.	Type / Model						
11224	41201190	BLACK						

Type / Model	REF. NO.	SEM NO.	
RED	42107725	11225	 <p><b>Description</b> Silicon Hose</p> <p>Ø90X210 4 hump</p>
RED	42088622 42070329	11226	 <p><b>Description</b> Silicon Hose</p> <p>Ø85XØ90X210 5 hump</p>
RED	42106463	11227	 <p><b>Description</b> Silicon Hose</p> <p>Ø90X240 6 hump</p>
BLUE	500300763	11228	 <p><b>Description</b> Silicon Hose</p> <p>Ø50X60X185 2 hump</p>
RED	42088612	11229	 <p><b>Description</b> Silicon Hose</p> <p>Ø90X140 2 hump</p>
GREEN	43165466	11230	 <p><b>Description</b> Silicon Hose</p> <p>Ø27X34X132</p>

	SEM NO.	REF. NO.	Type / Model
	11231	4724716	GREEN
<b>Description</b>			
Silicon Hose			
Ø50X170 3 hump			

	SEM NO.	REF. NO.	Type / Model
	11232	4787499	
<b>Description</b>			
Silicon Hose			
Ø45XØ50X170 3 hump			

	SEM NO.	REF. NO.	Type / Model
	11233	61586214	GREEN
<b>Description</b>			
Silicon Hose			
Ø70X80			

	SEM NO.	REF. NO.	Type / Model
	11235	41042165 93165335	GREEN
<b>Description</b>			
Silicon Hose			
Ø60X100			

Type / Model	REF. NO.		SEM NO.	
	93826649		12980	
			<b>Description</b>	
			Rubber Metal Buffer	

	ŞEM NO.	REF. NO.	Type / Model
	9327	4834037 4773359	
	<b>Description</b>		
	Tie Rod		
L=979 koni=26 boru=36			

	ŞEM NO.	REF. NO.	Type / Model
	9331	4854874	
	<b>Description</b>		
	Tie Rod		
L=897 koni=26 boru=42			

	ŞEM NO.	REF. NO.	Type / Model
	9332	41005463 8131582 8132397 41042919	8662-1
	<b>Description</b>		
	Tie Rod		
L=953 koni=30 boru=52			

	ŞEM NO.	REF. NO.	Type / Model
	9334	98467459 98402544	8690-1
	<b>Description</b>		
	Tie Rod		
L=822 koni=26 boru=38			

	ŞEM NO.	REF. NO.	Type / Model
	10083	98446354	
	<b>Description</b>		
	Tie Rod		
L 900 mm			

	ŞEM NO.	REF. NO.	Type / Model
	10084	8590435	
	<b>Description</b>		
	Tie Rod		
L 715 mm			

Type / Model	REF. NO.	SEM NO.
	41028269 41298449	10085
<b>Description</b>		
Tie Rod		
L 887 mm		



Type / Model	REF. NO.	SEM NO.
	98469650 98449025	10086
<b>Description</b>		
Tie Rod		
L 878 mm		



Type / Model	REF. NO.	SEM NO.
	41215165 41226580	11540
<b>Description</b>		
Tie Rod		



Type / Model	REF. NO.	SEM NO.
	42115532 42118694	11541
<b>Description</b>		
Tie Rod		



Type / Model	REF. NO.	SEM NO.
	504049893	11542
<b>Description</b>		
Tie Rod		





Type / Model	REF. NO.	SEM NO.
	41036943 41005450 41005451 8163773	12911
<b>Description</b>		
Tie Rod		
L=1631		







	SEM NO.	REF. NO.	Type / Model
	<b>8631</b> (8684)	2966252 42489573 2969808 42491638	4833829 42489594 42537936 7138967
	<b>Description</b>	42483386 4802443 42488269 8122752	M165-24 / 175-24 TURBOSTAR 190-33 190-36/190-42/190-48 TURBOTECH 190-26 190-32 190-36 / 220-36 240-36
M31Xx1.5 RHT L=120			





	SEM NO.	REF. NO.	Type / Model
	<b>8632</b> (8685)	2984061 42489395 42491957 42489574	M165-24 / 175-24 TURBOSTAR 190-33 190-36 190-42 / 190-48 TURBOTECH 190-26 / 190-32 190-36 / 220-36 240-36
	<b>Description</b>	4833830 4802444 8190225	
M31Xx1.5 LHT L=120			

	SEM NO.	REF. NO.	Type / Model
	<b>8633</b> (8686)	2966321 2966635 8193545 42484886	ZETA 50-9 / 50-10 50-8 / 60-10 60-8 / 60-11 65-10 / 65-9 / 79-10 79-12 79-13 / 79-14 P/PA 160-23 / 190-30 / 120-13 / 120-16 FIAT M23 /M23S / 23.12 M24 / 23.9/ M25 35NC 35.9 / 50NC8 / 50NM23 / M65.9
	<b>Description</b>	8558533 4833825 8582322	
M28Xx1.5 RHT L=105			

	SEM NO.	REF. NO.	Type / Model
	<b>8634</b> (8687)	2969507 42484887 8123394 4833826 8193646 8558536	ZETA 50-9 / 50-10 / 50-8 / 60-10 60-8 / 60-11 / 65-10 / 65-9 / 79-10 79-12 / 79-13 / 79-14 ZETA A 60-9 / 60-10 / 40-12 P/PA 160-23 / 190-30 / 120-13 / 120-16 FIAT M23 /M23S / 23.12 M24 / 23.9/ M25 35NC 35.9 / 50NC8 / 50NM23 M65.
	<b>Description</b>		
M28Xx1.5 RHT L=105			

	SEM NO.	REF. NO.	Type / Model
	<b>8635</b> (8690)	2980323 8122754 42483520 42493781 3096213	MK110-113/110-16 110-16 130-13/130-16 P/PA 150-6
	<b>Description</b>	004833827 2966688 42485718 4833820 4833827	
M30Xx1.5 RHT L=115			

	SEM NO.	REF. NO.	Type / Model
	<b>8636</b> (8691)	8122755 42493782 2984511 4833821	MK110-113/110-16 110-16 130-13/130-16 P/PA 150-6
	<b>Description</b>	2980129 4833828	
M30Xx1.5 LHT L=115			

Type / Model	REF. NO.	SEM NO.	
75.9 - 80.9	42480024 42491937	<b>8637</b> (8694)	 <b>Description</b> Rod End M24x1.5 RHT L=95
75.9 - 80.9	42480023 8193649	<b>8638</b> (8695)	 <b>Description</b> Rod End M24x1.5 LHT L=95
	2980875	<b>8639</b> (8696)	 <b>Description</b> Rod End M30x1.5 RHT L=120
50 NC - 55 NC OM50 - OM 55 ZETA 50.8 / 50.9 50.10 / 60.8 / 60.10 60.11 / 65.9 / 65.10 65.12 79.10 / 79.12 / 79.13 BUS 50Ai / A60.9 A70.12	42487165 8558527 93194627	<b>8647</b> (8692)	 <b>Description</b> Rod End M24x1.5 RHT L=105
50 NC - 55 NC OM50 - OM 55 ZETA 50.8 / 50.9 50.10 / 60.8 / 60.10 60.11 / 65.9 / 65.10 65.12 79.10 / 79.12 79.13 BUS 50Ai A60.9 A70.12	7984276 8558524	<b>8648</b> (8693)	 <b>Description</b> Rod End M24x1.5 LHT L=105
ZETA 50 9 50 10 60 10 / 60 11 65 10 / 65 12 65 9 79 10 / 79 12 / 79 13 79 14 ZETA A 60 10 70 12 / 70 14 M 115 17 / 135 17 145 17 / 159 17 FIAT M29 / M50 80.12 / 85.12 / 120.14	4688941 7167757 8582332 8565366	<b>8688</b>	 <b>Description</b> Rod End M28x1.5 RHT L=115

	SEM NO.	REF. NO.	Type / Model
 M28x1.5 LHT L=115	<b>8689</b>	4688942 8582333 1689605 11019669	ZETA 50-9 / 50-10 60-10 60-11 / 65-10 / 65-12 65-9 79-10 / 79-12 79-13 / 79-14 ZETA A 60-10 / 70-12 70-14 M 115-17 / 135-17 145-17 159-17 FIAT M29 / M50 80.12 / 85.12 120.14
	<b>Description</b>		
			Rod End



	SEM NO.	REF. NO.	Type / Model
	<b>10871</b>	42533102	
	<b>Description</b>		
			Rot End







	SEM NO.	REF. NO.	Type / Model
	<b>10931 (10932)</b>	42485639 8198188	
	<b>Description</b>		
			Rod End







	SEM NO.	REF. NO.	Type / Model
	<b>10937 (10938)</b>	42485638 8198187	
	<b>Description</b>		
			Rod End

	SEM NO.	REF. NO.	Type / Model
	<b>10943 (10944)</b>	3435786 86027074 7981909	
	<b>Description</b>		
			Rod End

	SEM NO.	REF. NO.	Type / Model
	<b>10958</b>	41203863 41002118 42041327 42079853	
	<b>Description</b>		
			Rod End

Type / Model	REF. NO.	SEM NO.	
	41203864	10959	
	41002119		
	42079852		
	42041328		
	42079850		
		<b>Description</b>	
		Rod End	
Type / Model	REF. NO.	SEM NO.	
	4688949	11561	
		<b>Description</b>	
		Rod End	
Type / Model	REF. NO.	SEM NO.	
	42538384	11579	
		<b>Description</b>	
		Rod End	

 D=Ø62,5 d=Ø20,3 h=97	<table border="1"> <thead> <tr> <th>SEM NO.</th> <th>REF. NO.</th> </tr> </thead> <tbody> <tr> <td>8190</td> <td>8160686</td> </tr> </tbody> </table>	SEM NO.	REF. NO.	8190	8160686	<table border="1"> <thead> <tr> <th>Type / Model</th> </tr> </thead> </table>	Type / Model
SEM NO.	REF. NO.						
8190	8160686						
Type / Model							
<p><b>Description</b> Spring Eye Bushing</p>							
 D=Ø62 d=Ø20 h=107	<table border="1"> <thead> <tr> <th>SEM NO.</th> <th>REF. NO.</th> </tr> </thead> <tbody> <tr> <td>8290</td> <td>8160687</td> </tr> </tbody> </table>	SEM NO.	REF. NO.	8290	8160687	<table border="1"> <thead> <tr> <th>Type / Model</th> </tr> </thead> </table>	Type / Model
SEM NO.	REF. NO.						
8290	8160687						
Type / Model							
<p><b>Description</b> Spring Eye Bushing</p>							
 D=Ø57 d=Ø20 h=84	<table border="1"> <thead> <tr> <th>SEM NO.</th> <th>REF. NO.</th> </tr> </thead> <tbody> <tr> <td>8291</td> <td>98413939</td> </tr> </tbody> </table>	SEM NO.	REF. NO.	8291	98413939	<table border="1"> <thead> <tr> <th>Type / Model</th> </tr> </thead> </table>	Type / Model
SEM NO.	REF. NO.						
8291	98413939						
Type / Model							
<p><b>Description</b> Spring Eye Bushing</p>							
 D=Ø47,5 d=Ø16 L=74	<table border="1"> <thead> <tr> <th>SEM NO.</th> <th>REF. NO.</th> </tr> </thead> <tbody> <tr> <td>12957</td> <td>98413847</td> </tr> </tbody> </table>	SEM NO.	REF. NO.	12957	98413847	<table border="1"> <thead> <tr> <th>Type / Model</th> </tr> </thead> </table>	Type / Model
SEM NO.	REF. NO.						
12957	98413847						
Type / Model							
<p><b>Description</b> Spring Eye Bushing</p>							
 D=Ø45,5 d=Ø16 h=40	<table border="1"> <thead> <tr> <th>SEM NO.</th> <th>REF. NO.</th> </tr> </thead> <tbody> <tr> <td>9260</td> <td>98482540 098482540 504098045 1904697 504077096</td> </tr> </tbody> </table>	SEM NO.	REF. NO.	9260	98482540 098482540 504098045 1904697 504077096	<table border="1"> <thead> <tr> <th>Type / Model</th> </tr> </thead> </table>	Type / Model
SEM NO.	REF. NO.						
9260	98482540 098482540 504098045 1904697 504077096						
Type / Model							
<p><b>Description</b> Spring Bushing</p>							
 D=Ø40 d=Ø16 h=40	<table border="1"> <thead> <tr> <th>SEM NO.</th> <th>REF. NO.</th> </tr> </thead> <tbody> <tr> <td>10197</td> <td>8587681 08587681</td> </tr> </tbody> </table>	SEM NO.	REF. NO.	10197	8587681 08587681	<table border="1"> <thead> <tr> <th>Type / Model</th> </tr> </thead> </table>	Type / Model
SEM NO.	REF. NO.						
10197	8587681 08587681						
Type / Model							
<p><b>Description</b> Spring Bushing</p>							

<b>Type / Model</b>	<b>REF. NO.</b>	<b>SEM NO.</b>	
	93808935 093808935	<b>10198</b>	
		<b>Description</b>	
		Spring Bushing	D=Ø40 d=Ø16 h=35
<b>Type / Model</b>	<b>REF. NO.</b>	<b>SEM NO.</b>	
	99469085	<b>12985</b>	
		<b>Description</b>	
		Spring Eye Bushing	
<b>Type / Model</b>	<b>REF. NO.</b>	<b>SEM NO.</b>	
	504277459	<b>10180</b>	
		<b>Description</b>	
		Rubber Metal Bush	D=Ø52 d=Ø29 h=42
<b>Type / Model</b>	<b>REF. NO.</b>	<b>SEM NO.</b>	
	504277460	<b>10181</b>	
		<b>Description</b>	
		Rubber Metal Bush	D=Ø56 d=Ø37 h=42
<b>Type / Model</b>	<b>REF. NO.</b>	<b>SEM NO.</b>	
	504039506	<b>11663</b>	
		<b>Description</b>	
		Spring Bushing	Ø28xØ50x26
<b>Type / Model</b>	<b>REF. NO.</b>	<b>SEM NO.</b>	
	41031725 41036367 4459603	<b>10308</b>	
		<b>Description</b>	
		Nut	M22x1,5



**SEM NO.**  
13026





**REF. NO.**  
500339201







**Type / Model**

**Description**









Metal Bushing

Model:	SEM NO.	Description / Spring Bushing Repair Kit
<p></p>	<p><b>13025</b></p>	<p><b>REF. NO:</b> 504039506S</p> 
<p><b>Model:</b></p>	<p><b>SEM NO.</b> <b>11661</b></p>	<p><b>Description / Spring Bushing Repair Kit</b></p> <p><b>REF. NO:</b> 504112266</p>  <p>Ø24xØ40x33 L=70</p>
<p><b>Model:</b></p>	<p><b>SEM NO.</b> <b>11662</b></p>	<p><b>Description / Spring Bushing Repair Kit</b></p> <p><b>REF. NO:</b> 504112265</p>  <p>Ø24xØ40x33 L=87</p>
<p><b>Model:</b> 060.533</p>	<p><b>SEM NO.</b> <b>11818</b></p>	<p><b>Description / Spring Bushing Repair Kit</b></p> <p><b>REF. NO:</b> 504011462</p>  <p>Ø16,5xØ48 L=80</p>









Description / Spring Bushing Repair Kit		SEM NO. 13007	Model:
		REF. NO: 504089477	
Description / Spring Bushing Repair Kit		SEM NO. 13015	Model:
		REF. NO: 504112267	
Description / Spring Bushing Repair Kit		SEM NO. 13016	Model:
		REF. NO: 504139797	

<b>Type / Model</b>	<b>REF. NO.</b>		<b>SEM NO.</b>	
	98401286		9633	
			<b>Description</b>	
			Spring Mounting	
				h=24 L=80 M8x1,25
<b>Type / Model</b>	<b>REF. NO.</b>		<b>SEM NO.</b>	
	93800197		12978	
			<b>Description</b>	
			Rubber Metal Buffer	
<b>Type / Model</b>	<b>REF. NO.</b>		<b>SEM NO.</b>	
	500306407		12987	
			<b>Description</b>	
			Rubber Metal Buffer	
<b>Type / Model</b>	<b>REF. NO.</b>		<b>SEM NO.</b>	
	500320322		12990	
			<b>Description</b>	
			Rubber Metal Buffer	
<b>Type / Model</b>	<b>REF. NO.</b>		<b>SEM NO.</b>	
	504051677		13004	
			<b>Description</b>	
			Rubber Metal Buffer	
<b>Type / Model</b>	<b>REF. NO.</b>		<b>SEM NO.</b>	
	504060027		13005	
			<b>Description</b>	
			Rubber Metal Buffer	

	<b>SEM NO.</b> 13018		<b>REF. NO.</b> 504237430	<b>Type / Model</b>
	<b>Description</b> Rubber Metal Buffer			
	<b>SEM NO.</b> 12986		<b>REF. NO.</b> 99470924	<b>Type / Model</b>
	<b>Description</b> Rubber Metal Buffer			
	<b>SEM NO.</b> 13002		<b>REF. NO.</b> 500362468	<b>Type / Model</b>
	<b>Description</b> Rubber Metal Buffer			
	<b>SEM NO.</b> 12998		<b>REF. NO.</b> 500340498	<b>Type / Model</b>
	<b>Description</b> Stabilizer Rod			
	<b>SEM NO.</b> 10962		<b>REF. NO.</b> 42052764	<b>Type / Model</b>
	<b>Description</b> Plastic Cover			

D=Ø85 h=9

<b>Type / Model</b>	<b>REF. NO.</b>	<b>SEM NO.</b>	
	2521481	7504 (9612)	
			<b>Description</b> Stabilizer Bush (Half)
			D=Ø 93 d=Ø 56 h= 70
<b>Type / Model</b>	<b>REF. NO.</b>	<b>SEM NO.</b>	
	2521482	7688	
			<b>Description</b> Stabilizer Bush (Half)
			D=Ø94 d=Ø44 h=80 h=70
<b>Type / Model</b>	<b>REF. NO.</b>	<b>SEM NO.</b>	
	008169892 041270883	8119	
			<b>Description</b> Stabilizer Bushing
			D=Ø94 d=Ø62 h=80 h=70
<b>Type / Model</b>	<b>REF. NO.</b>	<b>SEM NO.</b>	
	5010393006	8818	
			<b>Description</b> Stabilizer Bush
			D=Ø75 d=Ø45 h=80
<b>Type / Model</b>	<b>REF. NO.</b>	<b>SEM NO.</b>	
	98469635 8509450	9047	
			<b>Description</b> Stabilizer Bush
			D=Ø74 d=Ø50 h=70
<b>Type / Model</b>	<b>REF. NO.</b>	<b>SEM NO.</b>	
	2521850	9067	
			<b>Description</b> Stabilizer Bush (Half)
			D=Ø94 d=Ø50 h=70 h=80

	SEM NO.	REF. NO.	Type / Model
 D=Ø74,5 d=Ø42 h=70 h=80	<b>9070</b>	2520448	
	<b>Description</b> Stabilizer Bush (Half)		







	SEM NO.	REF. NO.	Type / Model
 D=Ø72,5 d=Ø48 h=70	<b>9071</b>	98469634 8509460	EUROCARGO EUROTECH
	<b>Description</b> Stabilizer Bush (Half)		







	SEM NO.	REF. NO.	Type / Model
 D=Ø46 d=Ø34 L=65	<b>9632</b>	41015581	
	<b>Description</b> Stabilizer Bushing		







	SEM NO.	REF. NO.	Type / Model
 D=Ø57,5 d=Ø28 h=64	<b>7822</b> (8617-11809)	99432757 5010512567	
	<b>Description</b> Bush		

	SEM NO.	REF. NO.	Type / Model
 D=Ø57,5 d=Ø12 Ax=88	<b>8618</b>	500300848	
	<b>Description</b> Stabilizer Bush		

	SEM NO.	REF. NO.	Type / Model
 D=Ø62 d=Ø28 h=50	<b>8999</b>	500336108	
	<b>Description</b> Bush		

<b>Type / Model</b>	<b>REF. NO.</b>	<b>SEM NO.</b>	 D=Ø64 d=Ø37 L=33
	8162280	9630	
		<b>Description</b>	
		Stabilizer Bushing	
<b>Type / Model</b>	<b>REF. NO.</b>	<b>SEM NO.</b>	 D=Ø62 d=Ø29 L=50
	8162306	9631	
		<b>Description</b>	
		Stabilizer Bushing	
<b>Type / Model</b>	<b>REF. NO.</b>	<b>SEM NO.</b>	
	41288750	10056	
		<b>Description</b>	
		Rubber Metal Bush	
<b>Type / Model</b>	<b>REF. NO.</b>	<b>SEM NO.</b>	 D=Ø60 d=Ø28 h=50
	4601722 4733199	10074	
		<b>Description</b>	
		Rubber Metal Bush	
<b>Type / Model</b>	<b>REF. NO.</b>	<b>SEM NO.</b>	
	4606624	12975	
		<b>Description</b>	
		Stabilizer Bush	
<b>Type / Model</b>	<b>REF. NO.</b>	<b>SEM NO.</b>	
	4791448	12976	
		<b>Description</b>	
		Stabilizer Bush	

	<p><b>SEM NO.</b> 12991</p> <p><i>new product</i></p>	<p><b>REF. NO.</b> 500323279</p>	<p><b>Type / Model</b></p>
<p><b>Description</b> Stabilizer Rod Bushing</p>			
	<p><b>SEM NO.</b> 12992</p> <p><i>new product</i></p>	<p><b>REF. NO.</b> 500323280</p>	<p><b>Type / Model</b></p>
<p><b>Description</b> Stabilizer Rod Bushing</p>			
	<p><b>SEM NO.</b> 8792</p>	<p><b>REF. NO.</b> 8557780</p>	<p><b>Type / Model</b></p>
<p><b>Description</b> Stabilizer Rubber</p> <p>24x40x55,5x39,5</p>			
	<p><b>SEM NO.</b> 9629</p>	<p><b>REF. NO.</b> 93802248</p>	<p><b>Type / Model</b></p>
<p><b>Description</b> Stabilizer Rubber</p> <p>D=Ø50 d=Ø20 L=36</p>			
	<p><b>SEM NO.</b> 9579</p>	<p><b>REF. NO.</b> 8125490</p>	<p><b>Type / Model</b> EUROCARGO</p>
<p><b>Description</b> Stabilizer Bushing</p> <p>D=Ø54,5 d=Ø32 h=62</p>			
	<p><b>SEM NO.</b> 9580</p>	<p><b>REF. NO.</b> 8125491</p>	<p><b>Type / Model</b> EUROCARGO</p>
<p><b>Description</b> Stabilizer Bushing</p> <p>D=Ø54,5 d=Ø32 h=62</p>			

<b>Type / Model</b>	<b>REF. NO.</b>	<b>SEM NO.</b>	
EUROCARGO	8125492	<b>9581</b>	
			<b>Description</b> Stabilizer Bushing
			D=Ø54,5 d=Ø34 h=62
<b>Type / Model</b>	<b>REF. NO.</b>	<b>SEM NO.</b>	
EUROCARGO	8127383	<b>9582</b>	
			<b>Description</b> Stabilizer Bushing
			D=Ø54,5 d=Ø40 h=62
<b>Type / Model</b>	<b>REF. NO.</b>	<b>SEM NO.</b>	
	93814617	<b>9627</b>	
			<b>Description</b> Stabilizer Bushing
			D=Ø57 d=Ø26 L=62
<b>Type / Model</b>	<b>REF. NO.</b>	<b>SEM NO.</b>	
	93819387	<b>10182</b>	
			<b>Description</b> Plastic Bearing
			D=Ø46 d=Ø32 h=62
<b>Type / Model</b>	<b>REF. NO.</b>	<b>SEM NO.</b>	
	93817505 93817504	<b>10183</b>	
			<b>Description</b> Plastic Bearing
			D=Ø46 d=Ø36 h=62
<b>Type / Model</b>	<b>REF. NO.</b>	<b>SEM NO.</b>	
	93814618 093814618	<b>10184</b>	
			<b>Description</b> Plastic Bearing
			D=Ø46 d=Ø28 h=62











	SEM NO.	REF. NO.	Type / Model
	10861	93814505	
	<b>Description</b> Plastic Bearing		
D=Ø46 d=Ø24 L=63			













	SEM NO.	REF. NO.	Type / Model
	12977	8127381	
	<b>Description</b> Stabilizer Bush		













	SEM NO.	REF. NO.	Type / Model
	9583	98431946	EUROCARGO
	<b>Description</b> Stabilizer Bushing		

	SEM NO.	REF. NO.	Type / Model
	9584	8127910	EUROCARGO
	<b>Description</b> Stabilizer Bushing		
46x65			

	SEM NO.	REF. NO.	Type / Model
	9626	4792127	
	<b>Description</b> Stabilizer Bushing		
36,5x58			

<b>Type / Model</b>	<b>REF. NO.</b>		<b>SEM NO.</b>	
	98407168		<b>12981</b>	
			<b>Description</b>	
			Stabilizer Bush	
<b>Type / Model</b>	<b>REF. NO.</b>		<b>SEM NO.</b>	
	98407169		<b>12982</b>	
			<b>Description</b>	
			Stabilizer Bush	
<b>Type / Model</b>	<b>REF. NO.</b>		<b>SEM NO.</b>	
	98415468		<b>12983</b>	
			<b>Description</b>	
			Stabilizer Bush	
<b>Type / Model</b>	<b>REF. NO.</b>		<b>SEM NO.</b>	
	98415469		<b>12984</b>	
			<b>Description</b>	
			Stabilizer Bush	
<b>Type / Model</b>	<b>REF. NO.</b>		<b>SEM NO.</b>	
EUROCARGO	8127423		<b>9585</b>	
			<b>Description</b>	
			Stabilizer Bushing	
				D=Ø42 d=Ø33 h=27
<b>Type / Model</b>	<b>REF. NO.</b>		<b>SEM NO.</b>	
	500326957		<b>12993</b>	
			<b>Description</b>	
			Bushing	

	<b>SEM NO.</b> 12988	 <i>new product</i>	<b>REF. NO.</b> 500315608	<b>Type / Model</b>
	<b>Description</b> Stabilizer Rod			
	<b>SEM NO.</b> 12989	 <i>new product</i>	<b>REF. NO.</b> 500315622	<b>Type / Model</b>
	<b>Description</b> Stabilizer Rod			
	<b>SEM NO.</b> 12994	 <i>new product</i>	<b>REF. NO.</b> 500336363	<b>Type / Model</b>
	<b>Description</b> Stabilizer Rod			
	<b>SEM NO.</b> 12995	 <i>new product</i>	<b>REF. NO.</b> 500336364	<b>Type / Model</b>
	<b>Description</b> Stabilizer Rod			
	<b>SEM NO.</b> 12996	 <i>new product</i>	<b>REF. NO.</b> 500336365	<b>Type / Model</b>
	<b>Description</b> Stabilizer Rod			
	<b>SEM NO.</b> 12997	 <i>new product</i>	<b>REF. NO.</b> 500336366	<b>Type / Model</b>
	<b>Description</b> Stabilizer Rod			

<b>Type / Model</b>	<b>REF. NO.</b>		<b>SEM NO.</b>	
	504092612		<b>13008</b>	
			<b>Description</b>	
			Stabilizer Rod	
<b>Type / Model</b>	<b>REF. NO.</b>		<b>SEM NO.</b>	
	504092613		<b>13009</b>	
			<b>Description</b>	
			Stabilizer Rod	
<b>Type / Model</b>	<b>REF. NO.</b>		<b>SEM NO.</b>	
	504092615		<b>13010</b>	
			<b>Description</b>	
			Stabilizer Rod	
<b>Type / Model</b>	<b>REF. NO.</b>		<b>SEM NO.</b>	
	504092618		<b>13011</b>	
			<b>Description</b>	
			Stabilizer Rod	
<b>Type / Model</b>	<b>REF. NO.</b>		<b>SEM NO.</b>	
	504092619		<b>13012</b>	
			<b>Description</b>	
			Stabilizer Rod	
<b>Type / Model</b>	<b>REF. NO.</b>		<b>SEM NO.</b>	
	504092620		<b>13013</b>	
			<b>Description</b>	
			Stabilizer Rod	



**SEM NO.**

**13003**



**REF. NO.**

500363065

**Type / Model**

**Description**

Stabilizer Rod

<b>Type / Model</b>	<b>REF. NO.</b>	<b>SEM NO.</b>	
	93163617	7615 (7911)	
			<p><b>Description</b> Ball Joint (Kit)</p> <p>D=Ø67 d=Ø19 Ax=130</p>
<b>Type / Model</b>	<b>REF. NO.</b>	<b>SEM NO.</b>	
	42535445	8527 (9208)	
			<p><b>Description</b> Ball Joint (Kit)</p> <p>D=Ø67 d=Ø15 Ax=100</p>
<b>Type / Model</b>	<b>REF. NO.</b>	<b>SEM NO.</b>	
	42535045	9072	
			<p><b>Description</b> Ball Joint (Kit)</p> <p>D=Ø67 d=Ø17 Ax=115</p>
<b>Type / Model</b>	<b>REF. NO.</b>	<b>SEM NO.</b>	
	504001436	9077 (9078)	
			<p><b>Description</b> Ball Joint (Kit)</p> <p>D=Ø67 d=Ø19 Ax=115</p>
<b>Type / Model</b>	<b>REF. NO.</b>	<b>SEM NO.</b>	
	2980884S	8035	
			<p><b>Description</b> Ball Joint (Kit)</p> <p>D=Ø72 d=Ø19 Ax=130</p>
<b>Type / Model</b>	<b>REF. NO.</b>	<b>SEM NO.</b>	
	93192361	7635 (7765)	
			<p><b>Description</b> Ball Joint (Kit)</p> <p>D=Ø75 d=Ø19 Ax=130</p>

	SEM NO.	REF. NO.	Type / Model
	<b>7636</b> (8135)	093161960 93161960	
	<b>Description</b> Ball Joint (Kit)		
D=Ø75 d=Ø21 Ax=130			

	SEM NO.	REF. NO.	Type / Model
	<b>7950</b>	42559870	
	<b>Description</b> Ball Joint (Kit)		
D=Ø75 d=Ø25 Ax=130			







	SEM NO.	REF. NO.	Type / Model
	<b>9044</b>	42535779	
	<b>Description</b> Ball Joint (Kit)		
D=Ø75 d=Ø21 Ax=130			

	SEM NO.	REF. NO.	Type / Model
	<b>9083</b> (9085)	500333284	
	<b>Description</b> Ball Joint (Kit)		
D=Ø75 d=Ø19 Ax=130			

	SEM NO.	REF. NO.	Type / Model
	<b>10432</b>	41218620S	
	<b>Description</b> Ball Joint (Kit)		
D=Ø75 d=Ø21 Ax=130			

	SEM NO.	REF. NO.	Type / Model
	<b>7335</b> (7740)	42488722	
	<b>Description</b> Ball Joint (Kit)		
D=Ø85 d=Ø19 Ax=130			







<b>Type / Model</b>	<b>REF. NO.</b>	<b>SEM NO.</b>	 <p><b>Description</b> Ball Joint (Kit)</p> <p>D=Ø85 d=Ø21 Ax=152</p>
	93192618 93161720	<b>7432 (7744)</b>	
<b>Type / Model</b>	<b>REF. NO.</b>	<b>SEM NO.</b>	 <p><b>Description</b> Ball Joint (KIT)</p> <p>D=Ø85 d=Ø21 Ax=130</p>
	42535204	<b>7565 (7749)</b>	
<b>Type / Model</b>	<b>REF. NO.</b>	<b>SEM NO.</b>	 <p><b>Description</b> Ball Joint (Kit)</p> <p>D=Ø85 d=Ø19 Ax=130</p>
	42535446 42536819	<b>8216 (8400-9441)</b>	
<b>Type / Model</b>	<b>REF. NO.</b>	<b>SEM NO.</b>	 <p><b>Description</b> Ball Joint Kit</p> <p>D= Ø85 d=Ø21 Ax=145</p>
	42530929	<b>10887</b>	
<b>Type / Model</b>	<b>REF. NO.</b>	<b>SEM NO.</b>	 <p><b>Description</b> Ball Joint (Kit)</p> <p>D=Ø85 d=Ø54 L=170</p>
	42559869	<b>7951</b>	
<b>Type / Model</b>	<b>REF. NO.</b>	<b>SEM NO.</b>	 <p><b>Description</b> Ball Joint (Kit)</p> <p>D=Ø95 d=Ø21 Ax=152</p>
	42493431 93192619 93162288	<b>7550 (7746)</b>	









	SEM NO.	REF. NO.	Type / Model
	<b>10462</b>	175809S 175810S	
	<b>Description</b> Ball Joint (Kit)		
D=Ø95 d=Ø21 Ax=145			







	SEM NO.	REF. NO.	Type / Model
	<b>10877</b>	93194458	23835 01
	<b>Description</b> Ball Joint (Kit)		
D=Ø95 h=75			

Model:	SEM NO.	Description / Ball Joint (Repair Kit)
	<b>7829</b> (8986)	
	REF. NO: 42535781	
	Ø72	
Model:	SEM NO.	Description / Ball Joint (Repair Kit)
	<b>7832</b> (7834)	
	REF. NO: 02968454 002968454	
	Ø72	
Model:	SEM NO.	Description / Ball Joint (Repair Kit)
LEMFORDER	<b>8620</b>	
	REF. NO: 093161958 93161958	
	D=Ø72 d=Ø45 M20x1,5	
Model:	SEM NO.	Description / Repair Kit
	 <b>12060</b>	
	REF. NO: 93161631	

Description / Ball Joint (Repair Kit)	SEM NO.	Model:
 <p>A ball joint repair kit for SEM NO. 7736. The kit includes a ball joint assembly, two green O-rings, two black O-rings, two white O-rings, two black O-rings, two black O-rings, two black O-rings, and a tube of SEM grease.</p>	<p><b>7736 (7760)</b></p> <p>REF. NO: 02980884</p> <p>D=Ø72 d=Ø19 Ax=130</p>	
 <p>A ball joint repair kit for SEM NO. 9622. The kit includes a ball joint assembly, two green O-rings, two black O-rings, two black O-rings, two black O-rings, two black O-rings, and a tube of SEM grease.</p>	<p><b>9622</b></p> <p>REF. NO: 4738069S</p> <p>D=Ø72 d=Ø30 h=95</p>	
 <p>A ball joint repair kit for SEM NO. 8372. The kit includes a ball joint assembly, two black O-rings, two black O-rings, two black O-rings, two black O-rings, two black O-rings, and a tube of SEM grease.</p>	<p><b>8372</b></p> <p>REF. NO: 93161958S 093161958S</p> <p>D=Ø 80</p>	<p>TRW Type</p>

Type / Model	REF. NO.	SEM NO.	
	4738069	9345	
		<b>Description</b>	1 1
		Axle Rod	
1- 9622 Page 812			L=727
	98488010 42125057 4714134	9346	
		<b>Description</b>	1 1
		Axle Rod	
1- 8216 Page 901			L=583 d=Ø19/19 Ax=130/130
	98472466 41009661 41272429	9347	
		<b>Description</b>	1 1
		Axle Rod Alternative Rubber	
1- 7635 Page 86			L=594 d=Ø19/19 Ax=130/130
	98472871	9348	
		<b>Description</b>	1 1
		Axle Rod Alternative Rubber	
1- 7635 Page 86			L=594 d=Ø19/19 Ax=130/130
	41001626 500340452 41009663 41034330 41003268	9349	
		<b>Description</b>	1 1
		Axle Rod Alternative Rubber	
1- 9083 Page 87			L=594 d=Ø19/19 Ax=130/130
	41009961 41225960	9350	
		<b>Description</b>	1 1
		Axle Rod Alternative Rubber	
1- 7635 Page 86			L=594 d=Ø19/19 Ax=130/130

	SEM NO.	REF. NO.	Type / Model
<p>L=455 d=Ø19/19 Ax=130/130</p>	<b>9351</b>	41033731 41225961	
	<b>Description</b>		Axle Rod Alternative Rubber 1- 7635 Page 504
<p>L=610 d=Ø21/21 Ax=152/152</p>	<b>9352</b>	42041107 41011008	
	<b>Description</b>		Axle Rod Alternative Rubber 1- 7432 Page 357
<p>L=594 d=Ø19/19 Ax=130/130</p>	<b>10160</b>	41214462	
	<b>Description</b>		Axle Rod 1- 9595 Page 85
<p>L=594 d=Ø19/19 Ax=130/130</p>	<b>12937</b>	 8137027	
	<b>Description</b>		Axle Rod 1- 7615 Page 807

<table border="1"> <thead> <tr> <th>Type / Model</th> <th>REF. NO.</th> </tr> </thead> <tbody> <tr> <td>Stralis 430</td> <td>41034479</td> </tr> <tr> <td>Stralis 480</td> <td>41042050</td> </tr> <tr> <td>Eurotech</td> <td>41009665</td> </tr> <tr> <td>Eurocargo</td> <td>41028600</td> </tr> <tr> <td></td> <td>41028598</td> </tr> <tr> <td></td> <td>08137026</td> </tr> <tr> <td>1- 8372 Page 812</td> <td>41002770</td> </tr> <tr> <td>2- 7636 Page 984</td> <td></td> </tr> </tbody> </table>	Type / Model	REF. NO.	Stralis 430	41034479	Stralis 480	41042050	Eurotech	41009665	Eurocargo	41028600		41028598		08137026	1- 8372 Page 812	41002770	2- 7636 Page 984		<table border="1"> <thead> <tr> <th>REF. NO.</th> <th>ŞEM NO.</th> </tr> </thead> <tbody> <tr> <td></td> <td><b>8369</b></td> </tr> </tbody> </table> <p><b>Description</b> Axle Rod ( V )</p>  <p>L=665 Ax=130/130 d=Ø21/21</p>	REF. NO.	ŞEM NO.		<b>8369</b>
Type / Model	REF. NO.																						
Stralis 430	41034479																						
Stralis 480	41042050																						
Eurotech	41009665																						
Eurocargo	41028600																						
	41028598																						
	08137026																						
1- 8372 Page 812	41002770																						
2- 7636 Page 984																							
REF. NO.	ŞEM NO.																						
	<b>8369</b>																						
<table border="1"> <thead> <tr> <th>Type / Model</th> <th>REF. NO.</th> </tr> </thead> <tbody> <tr> <td>1- 8620 Page 811</td> <td>98472468</td> </tr> <tr> <td>2- 7635 Page 984</td> <td></td> </tr> </tbody> </table>	Type / Model	REF. NO.	1- 8620 Page 811	98472468	2- 7635 Page 984		<table border="1"> <thead> <tr> <th>REF. NO.</th> <th>ŞEM NO.</th> </tr> </thead> <tbody> <tr> <td></td> <td><b>9312</b></td> </tr> </tbody> </table> <p><b>Description</b> Axle Rod ( V )</p>  <p>L=659,5 Ax=130/130 d=Ø19/19</p>	REF. NO.	ŞEM NO.		<b>9312</b>												
Type / Model	REF. NO.																						
1- 8620 Page 811	98472468																						
2- 7635 Page 984																							
REF. NO.	ŞEM NO.																						
	<b>9312</b>																						
<table border="1"> <thead> <tr> <th>Type / Model</th> <th>REF. NO.</th> </tr> </thead> <tbody> <tr> <td></td> <td>41042092</td> </tr> <tr> <td></td> <td>41028599</td> </tr> <tr> <td></td> <td>504064007</td> </tr> <tr> <td>1- 8620 Page 811</td> <td></td> </tr> <tr> <td>2- 7636 Page 984</td> <td></td> </tr> </tbody> </table>	Type / Model	REF. NO.		41042092		41028599		504064007	1- 8620 Page 811		2- 7636 Page 984		<table border="1"> <thead> <tr> <th>REF. NO.</th> <th>ŞEM NO.</th> </tr> </thead> <tbody> <tr> <td></td> <td><b>10795</b></td> </tr> </tbody> </table> <p><b>Description</b> Axle Rod ( V )</p>  <p>L=659 Ax=130/130 d=Ø21/21</p>	REF. NO.	ŞEM NO.		<b>10795</b>						
Type / Model	REF. NO.																						
	41042092																						
	41028599																						
	504064007																						
1- 8620 Page 811																							
2- 7636 Page 984																							
REF. NO.	ŞEM NO.																						
	<b>10795</b>																						
<table border="1"> <thead> <tr> <th>Type / Model</th> <th>REF. NO.</th> </tr> </thead> <tbody> <tr> <td></td> <td>41218620</td> </tr> <tr> <td></td> <td>41218621</td> </tr> <tr> <td>1- 7954 Page 88</td> <td></td> </tr> <tr> <td>2- 10432 Page 808</td> <td></td> </tr> </tbody> </table>	Type / Model	REF. NO.		41218620		41218621	1- 7954 Page 88		2- 10432 Page 808		<table border="1"> <thead> <tr> <th>REF. NO.</th> <th>ŞEM NO.</th> </tr> </thead> <tbody> <tr> <td></td> <td><b>10982</b></td> </tr> </tbody> </table> <p><b>Description</b> Axle Rod (V)</p>  <p>L=665 d=Ø25/21/21 Ax=152/130/130</p>	REF. NO.	ŞEM NO.		<b>10982</b>								
Type / Model	REF. NO.																						
	41218620																						
	41218621																						
1- 7954 Page 88																							
2- 10432 Page 808																							
REF. NO.	ŞEM NO.																						
	<b>10982</b>																						
<table border="1"> <thead> <tr> <th>Type / Model</th> <th>REF. NO.</th> </tr> </thead> <tbody> <tr> <td></td> <td>4716271</td> </tr> <tr> <td>1- 7834 Page 811</td> <td></td> </tr> <tr> <td>2- 7760 Page 812</td> <td></td> </tr> </tbody> </table>	Type / Model	REF. NO.		4716271	1- 7834 Page 811		2- 7760 Page 812		<table border="1"> <thead> <tr> <th>REF. NO.</th> <th>ŞEM NO.</th> </tr> </thead> <tbody> <tr> <td></td> <td><b>11248</b></td> </tr> </tbody> </table> <p><b>Description</b> V-torque Rod</p>  <p>L=688/657 d=Ø19/19 Ax=130/130</p>	REF. NO.	ŞEM NO.		<b>11248</b>										
Type / Model	REF. NO.																						
	4716271																						
1- 7834 Page 811																							
2- 7760 Page 812																							
REF. NO.	ŞEM NO.																						
	<b>11248</b>																						
<table border="1"> <thead> <tr> <th>Type / Model</th> <th>REF. NO.</th> </tr> </thead> <tbody> <tr> <td></td> <td>4865483</td> </tr> <tr> <td></td> <td>04865483</td> </tr> <tr> <td>1- 10877 Page 810</td> <td></td> </tr> <tr> <td>2- 7760 Page 812</td> <td></td> </tr> </tbody> </table>	Type / Model	REF. NO.		4865483		04865483	1- 10877 Page 810		2- 7760 Page 812		<table border="1"> <thead> <tr> <th>REF. NO.</th> <th>ŞEM NO.</th> </tr> </thead> <tbody> <tr> <td></td> <td><b>11249</b></td> </tr> </tbody> </table> <p><b>Description</b> V-torque Rod</p>  <p>L=703 d=Ø19/19 Ax=130/130</p>	REF. NO.	ŞEM NO.		<b>11249</b>								
Type / Model	REF. NO.																						
	4865483																						
	04865483																						
1- 10877 Page 810																							
2- 7760 Page 812																							
REF. NO.	ŞEM NO.																						
	<b>11249</b>																						



SEM NO.	REF. NO.	Type / Model
11250	4716799	

**Description**

V-torque Rod







1- 7834 Page 811  
2- 7760 Page 812

L=688/657 d=Ø19/19 Ax=130/130

Type / Model	REF. NO.	SEM NO.	
	5003983364 42532854	<b>8995</b> (9621)	 Description Stabilizer Bush D=Ø42 d=Ø16 h=66
Type / Model	REF. NO.	SEM NO.	
OPEN LENGTH=753 CLOSED LENGTH=440 UPPER MOUNT DIMENSION=M14x80 LOWER MOUNT DIMENSION=16x50	41218445 99474644 98430150 MONROE T1137 SACHS 131625 SACHS 124864	<b>11440</b>	 Description Shock Absorber
Type / Model	REF. NO.	SEM NO.	
OPEN LENGTH=689 CLOSED LENGTH=398 UPPER MOUNT DIMENSION=M16x85 LOWER MOUNT DIMENSION=M16x85	1004877 SACHS 106885	<b>11445</b>	 Description Shock Absorber
Type / Model	REF. NO.	SEM NO.	
OPEN LENGTH=646 CLOSED LENGTH=412 UPPER MOUNT DIMENSION=20x55 LOWER MOUNT DIMENSION 20x55	98414531 99474622 98485042 99474639 98488107 99432314 SACHS 124857 MONROE T1138 MONROE T5274	<b>11453</b>	 Description Shock Absorber
Type / Model	REF. NO.	SEM NO.	
OPEN LENGTH=518 CLOSED LENGTH=343 UPPER MOUNT DIMENSION=20x46 LOWER MOUNT DIMENSION=20x46	4511866 4606072 4544579 8504009	<b>11461</b>	 Description Shock Absorber
Type / Model	REF. NO.	SEM NO.	
OPEN LENGTH=244 CLOSED LENGTH=182 UPPER MOUNT DIMENSION=14x40 LOWER MOUNT DIMENSION=14x40	4759468 SACHS 310011	<b>11471</b>	 Description Shock Absorber



	<b>SEM NO.</b>	<b>REF. NO.</b>	<b>Type / Model</b>
	11474	42121257 42121258	OPEN LENGTH=384 CLOSED LENGTH=331 UPPER MOUNT DIMENSION=14x45 LOWER MOUNT DIMENSION=14x45
	<b>Description</b>		
	Shock Absorber		
	<b>SEM NO.</b>	<b>REF. NO.</b>	<b>Type / Model</b>
	11475	4776649	OPEN LENGTH=220 CLOSED LENGTH=166 UPPER MOUNT DIMENSION=14x33 LOWER MOUNT DIMENSION=10x33
	<b>Description</b>		
	Shock Absorber		
	<b>SEM NO.</b>	<b>REF. NO.</b>	<b>Type / Model</b>
	11480	4829234 8587219 8574216 MONROE V1055	OPEN LENGTH=444 CLOSED LENGTH=283 UPPER MOUNT DIMENSION=16x38 LOWER MOUNT DIMENSION=16x38
	<b>Description</b>		
	Shock Absorber		
	<b>SEM NO.</b>	<b>REF. NO.</b>	<b>Type / Model</b>
	11481	42071723 42071793	OPEN LENGTH=252 CLOSED LENGTH=198 UPPER MOUNT DIMENSION=16x50 LOWER MOUNT DIMENSION=14x34
	<b>Description</b>		
	Shock Absorber		
	<b>SEM NO.</b>	<b>REF. NO.</b>	<b>Type / Model</b>
	11482	8139025 99433009 98426021 99454195 98472611 99454196 98487778 99454197	99431373 500348789 99433007 99433008 SACHS 105424 SACHS 105840 MONROE Cb0073
	<b>Description</b>		OPEN LENGTH=270 CLOSED LENGTH=195 UPPER MOUNT DIMENSION=14x34 LOWER MOUNT DIMENSION 16x34
	Shock Absorber		
	<b>SEM NO.</b>	<b>REF. NO.</b>	<b>Type / Model</b>
	11499	41033038 41214818 41214460 SACHS 131621 MONROE T1261	OPEN LENGTH=775 CLOSED LENGTH=455 UPPER MOUNT DIMENSION=M14x69 LOWER MOUNT DIMENSION=16x50
	<b>Description</b>		
	Shock Absorber		

Type / Model	REF. NO.	SEM NO.	
OPEN LENGTH=500 CLOSED LENGTH=333 UPPER MOUNT DIMENSION=20x46 LOWER MOUNT DIMENSION=20x46	500379054	11526	 <p><b>Description</b> Shock Absorber</p>
	93163099	8405 (9586)	 <p><b>Description</b> Rubber Bush (Shock Absorber)</p> <p>D=Ø40 d=Ø20 h=40</p>
	93159597	9016 (9023)	 <p><b>Description</b> Rubber Mounting</p> <p>D=Ø40 d=Ø25 h=40</p>
EUROCARGO EUROTECH	93192004	9587	 <p><b>Description</b> Rubber Bush</p> <p>D=Ø37,5 d=Ø17,5 h=33</p>
EUROTECH	93194023	9588	 <p><b>Description</b> Rubber Bush</p> <p>D=Ø34 d=Ø14 h=34</p>
EUROSTAR EUROTECH	93194024	9589	 <p><b>Description</b> Stabilizer Bushing</p> <p>D=Ø34 d=Ø16 h=34</p>



	<b>SEM NO.</b>	<b>REF. NO.</b>	<b>Technical Specification</b>
	72.1885.R1	98478799	CONTITECH 1885N1 FIRESTONE 1R2A445-280 FIRESTONE W010950429 PHOENIX 1F20B
	<b>SEM NO.</b>	<b>REF. NO.</b>	<b>Technical Specification</b>
	72.450.R25	93197594	CONTITECH RZ 450-R25 PHOENIX 1 E 23 VIBRACOUSTIC V1E23 GOODYEAR 9050 GY SPRINGRIDE D12S13 CF GOMMA REF. 1S300-27 CF GOMMA NO. 203386
	<b>SEM NO.</b>	<b>REF. NO.</b>	<b>Technical Specification</b>
	72.644.R	536905265	CONTITECH 644 N PHOENIX 1 E 21 Taurus BL121 VIBRACOUSTIC V1E21 FIRESTONE 1R1A390 295 FIRESTONE W01 095 0118 GOODYEAR 8017 GY SPRINGRIDE D11S01 CF GOMMA REF. 1S285 24 CF GOMMA NO. 92574
	<b>SEM NO.</b>	<b>REF. NO.</b>	<b>Technical Specification</b>
	72.661.R	4746733 4746733 41822247 02498667 041822247	CONTITECH 661 N PHOENIX 1 E 25 VIBRACOUSTIC V1E25(-2) FIRESTONE 1R1C390-310 FIRESTONE W01-095-0021 GOODYEAR 8018 Büssing 831 120 144 CF GOMMA REF. 1S310-28 CF GOMMA NO. 91016
	<b>SEM NO.</b>	<b>REF. NO.</b>	<b>Technical Specification</b>
	72.673.R	02491566	CONTITECH 673 N PHOENIX 1 F 21 A Taurus B141 VIBRACOUSTIC V1F21A FIRESTONE 1R1A370-285
	<b>SEM NO.</b>	<b>REF. NO.</b>	<b>Technical Specification</b>
	72.715.R	04456111	CONTITECH 715 N PHOENIX 1 F 25 VIBRACOUSTIC V1F25 FIRESTONE 1R1C335-310 FIRESTONE W01-095-0087 GOODYEAR 8015 CF GOMMA REF. 1SC310-16 CF GOMMA NO. 93518









Technical Specification	REF. NO.		SEM NO.	
Total Weight 1,4 kg	500324098	CONTITECH 782 N PHOENIX 1 E 21 D VIBRACOUSTIC V1E21D FIRESTONE 1R1A415-285 FIRESTONE W01-095-0197 GOODYEAR 9013 GY SPRINGRIDE D11S02 IRISBUS 500324098 CF GOMMA REF. 1S290-23V	<b>72.782.R</b>	
			<b>Description</b>	Roll
Technical Specification	REF. NO.		SEM NO.	
Total Weight 2 kg	8188539 500301452 97108363	CONTITECH 884 N PHOENIX 1 F 20 A VIBRACOUSTIC V1F20A GOODYEAR 9002 GY SPRINGRIDE D12S06	<b>72.884.R1</b>	
			<b>Description</b>	Roll
Technical Specification	REF. NO.		SEM NO.	
Total Weight 2 kg	99459166	CONTITECH 921 N PHOENIX 1 E 17 VIBRACOUSTIC V1E17 FIRESTONE 1R1A415-260 FIRESTONE W01-095-0226 GOODYEAR 8043 GY SPRINGRIDE D10S04 CF GOMMA REF. 1S285-23V CF GOMMA NO. 202728	<b>72.921.R</b>	
			<b>Description</b>	Roll
Technical Specification	REF. NO.		SEM NO.	
Total Weight 1,6 kg	6453741	CONTITECH 928 N PHOENIX 2 E 23 A VIBRACOUSTIC V2E23A FIRESTONE 1R1K380-320 FIRESTONE W01-095-0228 MCW X 664 1056 GOODYEAR 8042 GY SPRINGRIDE D12S03 DUNLOP UK IC3308	<b>72.928.R</b>	
			<b>Description</b>	Roll
Technical Specification	REF. NO.		SEM NO.	
Total Weight 1,6 kg	4714025 4714025 4738008 5254025 8188526 6657150	CONTITECH 944 N PHOENIX 1 E 21-6 VIBRACOUSTIC V1E21-6 VIBRACOUSTIC V1E19 FIRESTONE 1R1B390-270 FIRESTONE W01-095-0121 Inbus 484 0005 Inbus 489 0001 GOODYEAR 9009	<b>72.944.R</b>	
			<b>Description</b>	Roll
Technical Specification	REF. NO.		SEM NO.	
Total Weight 1,6 kg	4716989 4716989	CONTITECH 945 N PHOENIX 1 E 21 C FIRESTONE 1R1A460-290 FIRESTONE W01-095-0063 GART NO. 276.0.420 GART REF. D276 BredaMenarini 178 741 GOODYEAR 9014	<b>72.945.R</b>	
			<b>Description</b>	Roll













SEM NO.	REF. NO.	Technical Specification
<b>72.2285.M01</b>	03422571	CONTITECH 608 N PHOENIX 2 B 20 R VIBRACOUSTIC V2B20R FIRESTONE 20 FIRESTONE W01-R58-4088 GOODYEAR 2B12-425/300
<b>Description</b>		Total Weight 1,1 kg
Convulated Air Spring		

<b>Type / Model</b>	<b>REF. NO.</b>	<b>SEM NO.</b>	
	99458304	9404	
			<p><b>Description</b> Hand Pump</p>
<b>Type / Model</b>	<b>REF. NO.</b>	<b>SEM NO.</b>	
	500316981 504184573	9415	
			<p><b>Description</b> Hand Pump</p>
<b>Type / Model</b>	<b>REF. NO.</b>	<b>SEM NO.</b>	
	00289375	9417	
			<p><b>Description</b> Hand Pump</p>
<b>Type / Model</b>	<b>REF. NO.</b>	<b>SEM NO.</b>	
	41241683	11649	
			<p><b>Description</b> Cabin Pump</p>

	SEM NO.	REF. NO.	Type / Model
	9430	98427951	
<b>Description</b>			
Cylinder			
	SEM NO.	REF. NO.	Type / Model
	11635	504062817	
<b>Description</b>			
Cabin Cylinder			
	SEM NO.	REF. NO.	Type / Model
	11636	42067576	
<b>Description</b>			
Cabin Cylinder			

<b>Type / Model</b>	<b>REF. NO.</b>	<b>SEM NO.</b>	
	500331831 1908675	<b>9068</b>	
		<b>Description</b>	Cabin Bushing
<b>Type / Model</b>	<b>REF. NO.</b>	<b>SEM NO.</b>	
	1907808	<b>9069</b>	
		<b>Description</b>	Cabin Bushing
			D=Ø38 d=Ø22 h=31
<b>Type / Model</b>	<b>REF. NO.</b>	<b>SEM NO.</b>	
	41009544 1908221S	<b>9195</b>	
		<b>Description</b>	Cabin Bushing
			D=Ø60 d=Ø20 h=56,5
<b>Type / Model</b>	<b>REF. NO.</b>	<b>SEM NO.</b>	
	500351393	 <b>12820</b>	
		<b>Description</b>	Cabin Bushing
			D=78
<b>Type / Model</b>	<b>REF. NO.</b>	<b>SEM NO.</b>	
	500357265	 <b>12821</b>	
		<b>Description</b>	Cabin Bushing
			D=60
<b>Type / Model</b>	<b>REF. NO.</b>	<b>SEM NO.</b>	
	504082049	 <b>13006</b>	
		<b>Description</b>	Cabin Mounting



	SEM NO.	REF. NO.	Type / Model
	13014 	504107760	
	<b>Description</b> Cabin Mounting		
	13017 	504203908	
	<b>Description</b> Cabin Mounting		
	13019 	504273839	
	<b>Description</b> Cabin Mounting		
	13020 	504345863	
	<b>Description</b> Cabin Mounting		
	13021 	504345864	
	<b>Description</b> Cabin Mounting		
	10252	16873476	
	<b>Description</b> Ring		

Type / Model	REF. NO.		SEM NO.	
	504021532		12822	
			<b>Description</b>	
			Metal Bushing	

<b>Description /</b> Repair Kit for Cabin	<b>SEM NO.</b>	<b>Model:</b>
---	----------------	---------------



12823

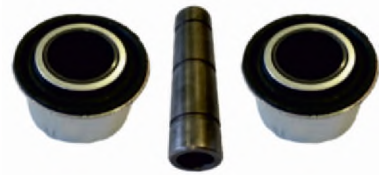

REF. NO: 500357265S  
504021532S  
500357265 - 2 Pcs.  
504021532 - 1 Pcs.

<b>Description /</b> Repair Kit for Cabin	<b>SEM NO.</b>	<b>Model:</b>
---	----------------	---------------

9196



REF. NO: 1908221  
41009544S

<b>Description /</b> Repair Kit for Cabin	<b>SEM NO.</b>	<b>Model:</b>
---	----------------	---------------

9158



REF. NO: 500331831S  
1908675S

Item No	Ref. No
1	500331831
2	-----







<b>Description /</b> Repair Kit for Cabin	<b>SEM NO.</b>	<b>Model:</b>
---	----------------	---------------







9159





REF. NO: 1907808S

Item No	Ref. No
1	1907808
2	-----
3	-----

Model:		SEM NO.	Description / Cabin Mounting (Repair Kit)
		13022	
		<b>REF. NO:</b> 42546400 42555620 42536919	
		13023	
		<b>REF. NO:</b> 2996417 42470849	
		13024	
		<b>REF. NO:</b> 42470850 42550500	

	<table border="1"> <thead> <tr> <th>SEM NO.</th> <th>REF. NO.</th> </tr> </thead> <tbody> <tr> <td>8472</td> <td>500357351 SACHS 310820</td> </tr> </tbody> </table>	SEM NO.	REF. NO.	8472	500357351 SACHS 310820	<table border="1"> <thead> <tr> <th>Type / Model</th> </tr> </thead> <tbody> <tr> <td>Stralis</td> </tr> </tbody> </table>	Type / Model	Stralis
SEM NO.	REF. NO.							
8472	500357351 SACHS 310820							
Type / Model								
Stralis								
<p><b>Description</b> Cabin Suspension Spring With Shock Absorber</p>								
	<table border="1"> <thead> <tr> <th>SEM NO.</th> <th>REF. NO.</th> </tr> </thead> <tbody> <tr> <td>8473</td> <td>504060241 SACHS 731700002845 SACHS 731700002770 SACHS 311 884</td> </tr> </tbody> </table>	SEM NO.	REF. NO.	8473	504060241 SACHS 731700002845 SACHS 731700002770 SACHS 311 884	<table border="1"> <thead> <tr> <th>Type / Model</th> </tr> </thead> <tbody> <tr> <td>Stralis</td> </tr> </tbody> </table>	Type / Model	Stralis
SEM NO.	REF. NO.							
8473	504060241 SACHS 731700002845 SACHS 731700002770 SACHS 311 884							
Type / Model								
Stralis								
<p><b>Description</b> Cabin Suspension Spring With Shock Absorber</p>								
	<table border="1"> <thead> <tr> <th>SEM NO.</th> <th>REF. NO.</th> </tr> </thead> <tbody> <tr> <td>8480</td> <td>500340706 ARVINMERITOR 908322986</td> </tr> </tbody> </table>	SEM NO.	REF. NO.	8480	500340706 ARVINMERITOR 908322986	<table border="1"> <thead> <tr> <th>Type / Model</th> </tr> </thead> <tbody> <tr> <td>Stralis</td> </tr> </tbody> </table>	Type / Model	Stralis
SEM NO.	REF. NO.							
8480	500340706 ARVINMERITOR 908322986							
Type / Model								
Stralis								
<p><b>Description</b> Cabin Suspension Spring With Shock Absorber</p>								
	<table border="1"> <thead> <tr> <th>SEM NO.</th> <th>REF. NO.</th> </tr> </thead> <tbody> <tr> <td>8482</td> <td>504060233 ARVINMERITOR 908323140</td> </tr> </tbody> </table>	SEM NO.	REF. NO.	8482	504060233 ARVINMERITOR 908323140	<table border="1"> <thead> <tr> <th>Type / Model</th> </tr> </thead> <tbody> <tr> <td>Stralis</td> </tr> </tbody> </table>	Type / Model	Stralis
SEM NO.	REF. NO.							
8482	504060233 ARVINMERITOR 908323140							
Type / Model								
Stralis								
<p><b>Description</b> Cabin Suspension Spring With Shock Absorber</p>								
	<table border="1"> <thead> <tr> <th>SEM NO.</th> <th>REF. NO.</th> </tr> </thead> <tbody> <tr> <td>8483</td> <td>500340705 ARVINMERITOR 908322985</td> </tr> </tbody> </table>	SEM NO.	REF. NO.	8483	500340705 ARVINMERITOR 908322985	<table border="1"> <thead> <tr> <th>Type / Model</th> </tr> </thead> <tbody> <tr> <td>Stralis</td> </tr> </tbody> </table>	Type / Model	Stralis
SEM NO.	REF. NO.							
8483	500340705 ARVINMERITOR 908322985							
Type / Model								
Stralis								
<p><b>Description</b> Cabin Suspension Spring With Shock Absorber</p>								
	<table border="1"> <thead> <tr> <th>SEM NO.</th> <th>REF. NO.</th> </tr> </thead> <tbody> <tr> <td>8484</td> <td>500357352 SACHS 310821</td> </tr> </tbody> </table>	SEM NO.	REF. NO.	8484	500357352 SACHS 310821	<table border="1"> <thead> <tr> <th>Type / Model</th> </tr> </thead> <tbody> <tr> <td>Stralis</td> </tr> </tbody> </table>	Type / Model	Stralis
SEM NO.	REF. NO.							
8484	500357352 SACHS 310821							
Type / Model								
Stralis								
<p><b>Description</b> Cabin Suspension Spring With Shock Absorber</p>								

Type / Model	REF. NO.	SEM NO.	
Eurotech	4102 8764	8486	<b>Description</b> Cabin Suspansion Spring With Shock Absorber
Eurostar	500348793		
	4102 8763		
	500377878		
	SACHS 115743		
			
Type / Model	REF. NO.	SEM NO.	
Eurotech	500379698	8487	<b>Description</b> Cabin Suspansion Spring With Shock Absorber
Eurostar	99438514		
	500307338		
	98472734		
	9945 5937		
	500352808		
	SACHS 115731		
			
Type / Model	REF. NO.	SEM NO.	
Eurotech	41015530	8489	<b>Description</b> Cabin Suspansion Spring With Shock Absorber
Eurostar	41019150		
	8169050		
	PIRELLI IGC130-30		
	MONROE Cb0077		
			



**SEM NO.**

**REF. NO.**

**Type / Model**







10922 (10926)

42559051  
42533556

**Description**

Rubber Strip

L=215

Type / Model	REF. NO.	SEM NO.
TURBOTECH	42332040	8394
		 <p><b>Description</b> Pressure Spring</p> <p>720 MM 710 N</p>
Type / Model	REF. NO.	SEM NO.
EUROTECH	98476371	8395
		 <p><b>Description</b> Pressure Spring</p> <p>760 MM 210 N</p>
Type / Model	REF. NO.	SEM NO.
EUROSTAR	98483247	8396
		 <p><b>Description</b> Pressure Spring</p> <p>280 N</p>
Type / Model	REF. NO.	SEM NO.
staralis	500390551	10641
		 <p><b>Description</b> Pressure Spring</p> <p>684-300-260N.</p>
Type / Model	REF. NO.	SEM NO.
	504032792	11005
		 <p><b>Description</b> Pressure Spring</p> <p>703-200N</p>
Type / Model	REF. NO.	SEM NO.
	4826817	11031
		 <p><b>Description</b> Pressure Spring</p> <p>195-100N</p>



SEM NO.	REF. NO.	Type / Model
11032	4787130	
		
<b>Description</b> Pressure Spring 195-150N		







SEM NO.	REF. NO.	Type / Model
11033	500321022	
		
<b>Description</b> Pressure Spring 405-300N		







SEM NO.	REF. NO.	Type / Model
11034	500303529	
		
<b>Description</b> Pressure Spring 278-200N		

SEM NO.	REF. NO.	Type / Model
11035	4825807	
		
<b>Description</b> Pressure Spring 405-350N		

SEM NO.	REF. NO.	Type / Model
11036	99482443	
		
<b>Description</b> Pressure Spring 405-500N		

SEM NO.	REF. NO.	Type / Model
11037	99445758	
		
<b>Description</b> Pressure Spring 195-50N		

Type / Model	REF. NO.	SEM NO.
	500321021	11038
		 <p><b>Description</b> Pressure Spring</p> <p>405-600N</p>
Type / Model	REF. NO.	SEM NO.
	99453944	11039
		 <p><b>Description</b> Pressure Spring</p> <p>375-200N</p>
Type / Model	REF. NO.	SEM NO.
	4867857	11040
		 <p><b>Description</b> Pressure Spring</p> <p>634-100N</p>
Type / Model	REF. NO.	SEM NO.
	7978657	11041
		 <p><b>Description</b> Pressure Spring</p> <p>405-200N</p>
Type / Model	REF. NO.	SEM NO.
	93196041	11042
		 <p><b>Description</b> Pressure Spring</p> <p>685-350N</p>
Type / Model	REF. NO.	SEM NO.
	93171032	11043
		 <p><b>Description</b> Pressure Spring</p> <p>685-700N</p>

 525-600N	<table border="1"> <thead> <tr> <th>SEM NO.</th> <th>REF. NO.</th> <th>Type / Model</th> </tr> </thead> <tbody> <tr> <td>11045</td> <td>504009089</td> <td></td> </tr> </tbody> </table>	SEM NO.	REF. NO.	Type / Model	11045	504009089	
	SEM NO.	REF. NO.	Type / Model				
	11045	504009089					
<p><b>Description</b> Pressure Spring</p>							
 487-800N	<table border="1"> <thead> <tr> <th>SEM NO.</th> <th>REF. NO.</th> <th>Type / Model</th> </tr> </thead> <tbody> <tr> <td>11046</td> <td>500315081</td> <td></td> </tr> </tbody> </table>	SEM NO.	REF. NO.	Type / Model	11046	500315081	
	SEM NO.	REF. NO.	Type / Model				
	11046	500315081					
<p><b>Description</b> Pressure Spring</p>							
 525-100N	<table border="1"> <thead> <tr> <th>SEM NO.</th> <th>REF. NO.</th> <th>Type / Model</th> </tr> </thead> <tbody> <tr> <td>11047</td> <td>98463694</td> <td></td> </tr> </tbody> </table>	SEM NO.	REF. NO.	Type / Model	11047	98463694	
	SEM NO.	REF. NO.	Type / Model				
	11047	98463694					
<p><b>Description</b> Pressure Spring</p>							
 445-200N	<table border="1"> <thead> <tr> <th>SEM NO.</th> <th>REF. NO.</th> <th>Type / Model</th> </tr> </thead> <tbody> <tr> <td>11048</td> <td>93930490</td> <td></td> </tr> </tbody> </table>	SEM NO.	REF. NO.	Type / Model	11048	93930490	
	SEM NO.	REF. NO.	Type / Model				
	11048	93930490					
<p><b>Description</b> Pressure Spring</p>							
 525-350N	<table border="1"> <thead> <tr> <th>SEM NO.</th> <th>REF. NO.</th> <th>Type / Model</th> </tr> </thead> <tbody> <tr> <td>11049</td> <td>4867858</td> <td></td> </tr> </tbody> </table>	SEM NO.	REF. NO.	Type / Model	11049	4867858	
	SEM NO.	REF. NO.	Type / Model				
	11049	4867858					
<p><b>Description</b> Pressure Spring</p>							
 685-600N	<table border="1"> <thead> <tr> <th>SEM NO.</th> <th>REF. NO.</th> <th>Type / Model</th> </tr> </thead> <tbody> <tr> <td>11050</td> <td>93171935</td> <td></td> </tr> </tbody> </table>	SEM NO.	REF. NO.	Type / Model	11050	93171935	
	SEM NO.	REF. NO.	Type / Model				
	11050	93171935					
<p><b>Description</b> Pressure Spring</p>							

Type / Model	REF. NO.	SEM NO.	
Eurocargo	504125466	8374	
		<b>Description</b>	
		Cabin Locked	
			106X39X100

SEM NO.	REF. NO.	Type / Model
10071	93810239	
<b>Description</b>		
Axle Rubber Bushing		
D=Ø57 d=Ø37 h=43		



SEM NO.	REF. NO.	Type / Model
10072	93807640	
<b>Description</b>		
Axle Rubber Bushing		
D=Ø52 d=Ø29 h=45		



SEM NO.	REF. NO.	Type / Model
10073	93807641	
<b>Description</b>		
Axle Rubber Bushing		
D=Ø52 d=Ø32 h=45		



SEM NO.	REF. NO.	Type / Model
10199	1391348	
<b>Description</b>		
Axle Rubber Bushing		
D=Ø52 d=Ø32 h=34		



SEM NO.	REF. NO.	Type / Model
10200	1391347 01391347	
<b>Description</b>		
Axle Rubber Bushing		
D=Ø52 d=Ø29 h=34		



SEM NO.	REF. NO.	Type / Model
12999	500350342	
<b>Description</b>		
Spring Bushing		



Type / Model	REF. NO.		SEM NO.	
	500350343		13000	
			<b>Description</b>	
			Spring Bushing	

# 6 - 4.1

SEM NO.	REF. NO.	Type / Model
10684	42541413	KN TYPE NA 7027, NA 7028, NA 7037, NA 7038, NA 75..., SK 7..., SN 65..., SN 66..., SN 7..., SN 71..., SN 72..., SN 73.. Series
 <p><b>Description</b> Caliper Repair Kit</p>		







SEM NO.	REF. NO.	Type / Model
10690	42541412	KN TYPE / IVECO TYPE SN 6529, SN 6539, SN 7067, SN 7077, SN 7084, SN 7094, SN 7086, SN 7096 SN 7106, SN 7116, SN 7125, SN 7135, SN 7144, SN 7154, NA 7027, NA 7028 NA 7038, SK 7..., SN 65..., SN 66..., SN 7..., SN 71..., SN 72..., SN 73.. Series
 <p><b>Description</b> Caliper Repair Kit</p>		

SEM NO.	REF. NO.	Type / Model
12261	42541464	KN TYPE IVECO TYPE
 <p><b>Description</b> Caliper Repair Kit</p>		





SEM NO.	REF. NO.	Type / Model
12231	42537451	KN TYPE SB 65..., SB 71..., SB 75..., SB 76..., SB 77..., SB 78..., SB 79..
 <p><b>Description</b> Caliper Repair Kit</p>		







# 6 - 4.3





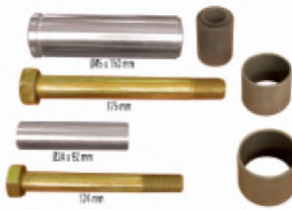

SEM NO.	REF. NO.	Type / Model
10768	42536957	WBC TYPE 40 175 025, 026, 027, 028, 049, 050, 051, 056, 057, 058, 059, 060, 061, 062, 063, 064, 065, 069, 070, 071, 072, 073, 078, 079, 080, 081, 090, 091
 <p><b>Description</b> Caliper Repair Kit</p>		













Type / Model	REF. NO.		SEM NO.	
HYDRAULIC TYPE LRG 506,LRG 507	93161028		12719	 <p><b>Description</b> Caliper Repair Kit</p>
HYDRAULIC TYPE LRG 500, 501, 502, 503, 504, 505, 508, 509, 518, 519, 534, 535	93161552		12730	 <p><b>Description</b> Caliper Repair Kit</p>
HYDRAULIC TYPE LRG 500, 501, 502, 503, 504, 505, 508, 509, 512, 513, 514, 518, 519, 534, 535, 568, 569, 600, 601, 602, 603, 608, 609, 610, 611, 620, 621, 628, 629, 634, 635	8124737		12735	 <p><b>Description</b> Caliper Repair Kit</p>
HYDRAULIC TYPE	93161037 93161473		12738	 <p><b>Description</b> Caliper Repair Kit</p>
HYDRAULIC TYPE	93161036 93161473		12740	 <p><b>Description</b> Caliper Repair Kit</p>
HYDRAULIC TYPE	93161034 93161471		12741	 <p><b>Description</b> Caliper Repair Kit</p>









	<p><b>SEM NO.</b> 12742</p>	<p><i>new product</i></p>	<p><b>REF. NO.</b> 42537365</p>	<p><b>Type / Model</b></p>
<p><b>Description</b> Caliper Repair Kit</p>				
	<p><b>SEM NO.</b> 12743</p>	<p><i>new product</i></p>	<p><b>REF. NO.</b> 42537366</p>	<p><b>Type / Model</b></p>
<p><b>Description</b> Caliper Repair Kit</p>				
	<p><b>SEM NO.</b> 12744</p>	<p><i>new product</i></p>	<p><b>REF. NO.</b> 93161254</p>	<p><b>Type / Model</b></p>
<p><b>Description</b> Caliper Repair Kit</p>				
	<p><b>SEM NO.</b> 12713</p>	<p><i>new product</i></p>	<p><b>REF. NO.</b> 63161192</p>	<p><b>Type / Model</b> IVECO TYPE T 4300 131.720, T 4300 131.721, T 4300 131.766, T 4300 131.767</p>
<p><b>Description</b> Caliper Repair Kit</p>				
	<p><b>SEM NO.</b> 12715</p>	<p><i>new product</i></p>	<p><b>REF. NO.</b> 93161928</p>	<p><b>Type / Model</b> IVECO TYPE</p>
<p><b>Description</b> Caliper Repair Kit</p>				

Type / Model	REF. NO.		SEM NO.	
	93161623		12745	 <b>Description</b> Caliper Repair Kit
	42536195		12746	 <b>Description</b> Caliper Repair Kit
	42531676		12747	 <b>Description</b> Caliper Repair Kit
131.720, 131.774, 131.776 131.721, 131.775, 131.777	93161189		12748	 <b>Description</b> Caliper Repair Kit
131.720, 131.774, 131.776, 131.721, 131.775, 131.777	93161560		12749	 <b>Description</b> Caliper Repair Kit
42101841, 42101842, 42102123	42491974		12751	 <b>Description</b> Caliper Repair Kit

	<p><b>SEM NO.</b> 12752</p>	<p><i>new product</i></p>	<p><b>REF. NO.</b> 7980406</p>	<p><b>Type / Model</b> 42101841 42101842 42102123</p>
<p><b>Description</b> Caliper Repair Kit</p>				
	<p><b>SEM NO.</b> 12753</p>	<p><i>new product</i></p>	<p><b>REF. NO.</b> 7980405</p>	<p><b>Type / Model</b> 42101841 42101842 42102123</p>
<p><b>Description</b> Caliper Repair Kit</p>				
	<p><b>SEM NO.</b> 12754</p>	<p><i>new product</i></p>	<p><b>REF. NO.</b> 42491950</p>	<p><b>Type / Model</b> 42101841 42101842 42102123</p>
<p><b>Description</b> Caliper Repair Kit</p>				
	<p><b>SEM NO.</b> 12755</p>	<p><i>new product</i></p>	<p><b>REF. NO.</b> 93161622 93161114 42558430</p>	<p><b>Type / Model</b> 41000981 41000982</p>
<p><b>Description</b> Caliper Repair Kit</p>				
	<p><b>SEM NO.</b> 12756</p>	<p><i>new product</i></p>	<p><b>REF. NO.</b> 93161256</p>	<p><b>Type / Model</b> 41000981 41000982</p>
<p><b>Description</b> Caliper Repair Kit</p>				
	<p><b>SEM NO.</b> 12757</p>	<p><i>new product</i></p>	<p><b>REF. NO.</b> 93161621</p>	<p><b>Type / Model</b> 41000981 41000982</p>
<p><b>Description</b> Caliper Repair Kit</p>				

Type / Model	REF. NO.		SEM NO.	
42101841 42101842 42102123	42480062		12758	<p><b>Description</b> Caliper Repair Kit</p> 
41000981 41000982	93161625		12761	<p><b>Description</b> Caliper Repair Kit</p> 
42101841 42101842 42102123	7980408		12762	<p><b>Description</b> Caliper Repair Kit</p> 
41000981 41000982	93161257		12763	<p><b>Description</b> Caliper Repair Kit</p> 
	42537841		12764	<p><b>Description</b> Caliper Repair Kit</p> 
41000981 41000982	93161624		12765	<p><b>Description</b> Caliper Repair Kit</p> 







	SEM NO.	REF. NO.	Type / Model
	12766	8121441	41000981 41000982
	<b>Description</b> Caliper Repair Kit		
	12768	42488484	SN 6529, SN 6539, SN 7067, SN 7077, SN 7084, SN 7094, SN 7086, SN 7096, SN 7106, SN 7116, SN 7125, SN 7135, SN 7144, SN 7154, NA 7027, NA 7028, NA 7038, SK 7..., SN 65..., SN 66..., SN 7..., SN 71..., SN 72..., SN 73.. Series
	<b>Description</b> Caliper Repair Kit		
	12788	7980407	42101841 42101842 42102123
	<b>Description</b> Caliper Repair Kit		
	12789	12999199VT 93161181	
	<b>Description</b> Caliper Repair Kit		
	12776	42480058	IVECO TYPE
	<b>Description</b> Caliper Repair Kit		
	12750	93161843	IVECO TYPE
	<b>Description</b> Caliper Repair Kit		









## RVI GROUP





Engine and Transmission Group .....	:	848 - 867
Steering Group .....	:	868 - 874
Suspension Group .....	:	875 - 914
Cab Group .....	:	915 - 929
Axle / Differential ve Shaft Group.....	:	-
Clutch and Brake Group.....	:	930 - 937





	<p><b>SEM NO.</b> 8340</p>	<p><b>REF. NO.</b> 7420503551</p>	<p><b>Type / Model</b></p>
<p><b>Description</b> Engine Mounting</p>			
	<p><b>SEM NO.</b> 8341 (10186)</p>	<p><b>REF. NO.</b> 7420503552</p>	<p><b>Type / Model</b></p>
<p><b>Description</b> Engine Mounting</p>			
	<p><b>SEM NO.</b> 11795</p>	<p><b>REF. NO.</b> 5010094716</p>	<p><b>Type / Model</b></p>
<p><b>Description</b> Engine Mounting</p>			
<p>70 Shore</p>			
	<p><b>SEM NO.</b> 11796</p>	<p><b>REF. NO.</b> 5010130602</p>	<p><b>Type / Model</b></p>
<p><b>Description</b> Engine Mounting</p>			
<p>50 Shore</p>			
	<p><b>SEM NO.</b> 9240 (10059)</p>	<p><b>REF. NO.</b> 7420499469</p>	<p><b>Type / Model</b></p>
<p><b>Description</b> Engine Mounting</p>			
	<p><b>SEM NO.</b> 9243 (10060)</p>	<p><b>REF. NO.</b> 7420499472</p>	<p><b>Type / Model</b></p>
<p><b>Description</b> Engine Mounting</p>			

<b>Type / Model</b>	<b>REF. NO.</b>		<b>SEM NO.</b>	
	5010316521		11941	
			<b>Description</b>	
			Engine Mounting	
<b>Type / Model</b>	<b>REF. NO.</b>		<b>SEM NO.</b>	
	5010316522		11942	
			<b>Description</b>	
			Engine Mounting	
<b>Type / Model</b>	<b>REF. NO.</b>		<b>SEM NO.</b>	
	5010316591		11943	
			<b>Description</b>	
			Engine Mounting	
<b>Type / Model</b>	<b>REF. NO.</b>		<b>SEM NO.</b>	
	5010316592		11944	
			<b>Description</b>	
			Engine Mounting	

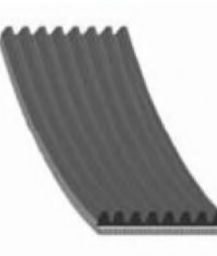

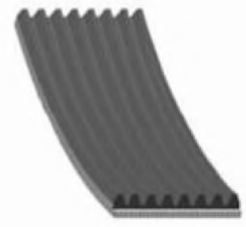

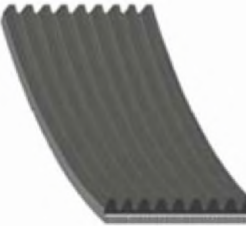
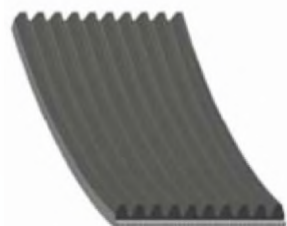
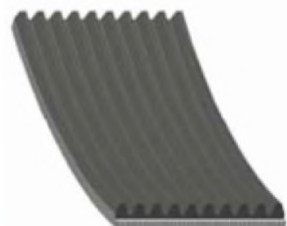
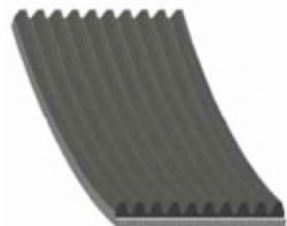





	<table border="1"> <thead> <tr> <th>SEM NO.</th> <th>REF. NO.</th> <th>Type / Model</th> </tr> </thead> <tbody> <tr> <td>11673</td> <td>5010477334</td> <td></td> </tr> </tbody> </table>	SEM NO.	REF. NO.	Type / Model	11673	5010477334		<p><b>Description</b> V Ribbed Belt</p>
SEM NO.	REF. NO.	Type / Model						
11673	5010477334							
5PK1025								
	<table border="1"> <thead> <tr> <th>SEM NO.</th> <th>REF. NO.</th> <th>Type / Model</th> </tr> </thead> <tbody> <tr> <td>11674</td> <td>5010477337</td> <td></td> </tr> </tbody> </table>	SEM NO.	REF. NO.	Type / Model	11674	5010477337		<p><b>Description</b> V Ribbed Belt</p>
SEM NO.	REF. NO.	Type / Model						
11674	5010477337							
5PK1240								
	<table border="1"> <thead> <tr> <th>SEM NO.</th> <th>REF. NO.</th> <th>Type / Model</th> </tr> </thead> <tbody> <tr> <td>11675</td> <td>5010550411</td> <td></td> </tr> </tbody> </table>	SEM NO.	REF. NO.	Type / Model	11675	5010550411		<p><b>Description</b> V Ribbed Belt</p>
SEM NO.	REF. NO.	Type / Model						
11675	5010550411							
5PK1250								
	<table border="1"> <thead> <tr> <th>SEM NO.</th> <th>REF. NO.</th> <th>Type / Model</th> </tr> </thead> <tbody> <tr> <td>11677</td> <td>5010477766</td> <td></td> </tr> </tbody> </table>	SEM NO.	REF. NO.	Type / Model	11677	5010477766		<p><b>Description</b> V Ribbed Belt</p>
SEM NO.	REF. NO.	Type / Model						
11677	5010477766							
6PK1420								
	<table border="1"> <thead> <tr> <th>SEM NO.</th> <th>REF. NO.</th> <th>Type / Model</th> </tr> </thead> <tbody> <tr> <td>10315 (10316)</td> <td>7420715585</td> <td></td> </tr> </tbody> </table>	SEM NO.	REF. NO.	Type / Model	10315 (10316)	7420715585		<p><b>Description</b> V Ribbed Belt</p>
SEM NO.	REF. NO.	Type / Model						
10315 (10316)	7420715585							
8PK980								
	<table border="1"> <thead> <tr> <th>SEM NO.</th> <th>REF. NO.</th> <th>Type / Model</th> </tr> </thead> <tbody> <tr> <td>11687</td> <td>7420543484</td> <td></td> </tr> </tbody> </table>	SEM NO.	REF. NO.	Type / Model	11687	7420543484		<p><b>Description</b> V Ribbed Belt</p>
SEM NO.	REF. NO.	Type / Model						
11687	7420543484							
8PK1435								







<b>Type / Model</b>	<b>REF. NO.</b>		<b>SEM NO.</b>	
	7420543481		<b>12894</b>	
			<b>Description</b>	
			V Ribbed Belt	8PK1525
<b>Type / Model</b>	<b>REF. NO.</b>		<b>SEM NO.</b>	
	7700068536		<b>10344 (10345)</b>	
			<b>Description</b>	
			V Ribbed Belt	8PK1610
<b>Type / Model</b>	<b>REF. NO.</b>		<b>SEM NO.</b>	
	5010477838		<b>11693</b>	
			<b>Description</b>	
			V Ribbed Belt	9PK1691
<b>Type / Model</b>	<b>REF. NO.</b>		<b>SEM NO.</b>	
	7420715587		<b>10397</b>	
			<b>Description</b>	
			V Ribbed Belt	10PK1108
<b>Type / Model</b>	<b>REF. NO.</b>		<b>SEM NO.</b>	
	7421190824		<b>11698</b>	
			<b>Description</b>	
			V Ribbed Belt	10PK1342
<b>Type / Model</b>	<b>REF. NO.</b>		<b>SEM NO.</b>	
	7420846321		<b>11700</b>	
			<b>Description</b>	
			V Ribbed Belt	10PK1720







	SEM NO.		REF. NO.	Type / Model
	12901		5000136827	
	<b>Description</b>			
	V Ribbed Belt			
2XAVX13X1025				

<b>Type / Model</b>	<b>REF. NO.</b>		<b>SEM NO.</b>	
	5010269870		12141	
			<b>Description</b>	
			Blade, Fan	
<b>Type / Model</b>	<b>REF. NO.</b>		<b>SEM NO.</b>	
	5010140298		12149	
			<b>Description</b>	
			Blade, Fan	
<b>Type / Model</b>	<b>REF. NO.</b>		<b>SEM NO.</b>	
	5010269871		12140	
			<b>Description</b>	
			Visco Drive, Fan	
<b>Type / Model</b>	<b>REF. NO.</b>		<b>SEM NO.</b>	
	5010140853		12148	
			<b>Description</b>	
			Visco Drive, Fan	
<b>Type / Model</b>	<b>REF. NO.</b>		<b>SEM NO.</b>	
	5010514015		12150	
			<b>Description</b>	
			Visco Drive, Fan	
<b>Type / Model</b>	<b>REF. NO.</b>		<b>SEM NO.</b>	
	7421146755		12152	
			<b>Description</b>	
			Visco Drive, Fan	

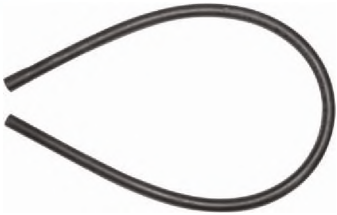





	SEM NO.	REF. NO.	Type / Model
	060	5010514325	PREMIUM 420
	<b>Description</b> Rubber Strip		
	061	5010514190	PREMIUM 370
	<b>Description</b> Rubber Strip		
	062	5010514188	
	<b>Description</b> Rubber Strip		







Type / Model	REF. NO.	ŞEM NO.	
FH FH 12	7420367063	8512 (10639)	 <p><b>Description</b> Radiator Hose</p> <p>12x12x80</p>
FH FH 12 FM	7420456429	8570 (10638)	 <p><b>Description</b> Radiator Hose</p> <p>13x13x150</p>
KERAX PREMIUM	5010514577 7421424710	8717	 <p><b>Description</b> Radiator Hose</p> <p>48x48x26x370x530</p>
KERAX PREMIUM	5010514578 7421424733	8718	 <p><b>Description</b> Radiator Hose</p> <p>48x48x26x350x505</p>
KERAX PREMIUM	5010514144	8719	 <p><b>Description</b> Radiator Hose</p> <p>48x53x510x395</p>
KERAX PREMIUM	5010304544	8720	 <p><b>Description</b> Radiator Hose</p> <p>25x25x20x600</p>

	<b>SEM NO.</b>	<b>REF. NO.</b>	<b>Type / Model</b>
	8721	5010304545	KERAX PREMIUM
<b>Description</b> Radiator Hose			
16x19x240x295			
	<b>SEM NO.</b>	<b>REF. NO.</b>	<b>Type / Model</b>
	8722	5010315046	MAGNUM 390 430 470
<b>Description</b> Radiator Hose			
50x58x600x1040			
	<b>SEM NO.</b>	<b>REF. NO.</b>	<b>Type / Model</b>
	8723 (8906)	5010514182	MAGNUM 390 430 470
<b>Description</b> Radiator Hose			
49x54x400x525			
	<b>SEM NO.</b>	<b>REF. NO.</b>	<b>Type / Model</b>
	8724	5010211354	MAGNUM 390 430 470
<b>Description</b> Expansion Tank Hose			
25x25x500x1000			
	<b>SEM NO.</b>	<b>REF. NO.</b>	<b>Type / Model</b>
	8725	5010514472	MAGNUM 390 430 470
<b>Description</b> Radiator Hose			
49x49x625x970			
	<b>SEM NO.</b>	<b>REF. NO.</b>	<b>Type / Model</b>
	8726	5010315936	MAGNUM 390 430 470
<b>Description</b> Radiator Hose			
49x58x430x455			

Type / Model	REF. NO.	ŞEM NO.	
MAGNUM	5010095439	8737	 <p><b>Description</b> Heating Hose</p> <p>11x13x1100</p>
PREMIUM	5010421142	8738	 <p><b>Description</b> Heating Hose</p> <p>20x20x270</p>
PREMIUM	5010467589	8739	 <p><b>Description</b> Radiator Hose</p> <p>53x53x240</p>
PREMIUM	5010514522	8740	 <p><b>Description</b> Radiator Hose</p> <p>60x60x96</p>
PREMIUM	5010530014	8741	 <p><b>Description</b> Heating Hose</p> <p>18x18x54</p>
PREMIUM	5010619237	8742	 <p><b>Description</b> Radiator Hose</p> <p>49x59x490</p>



	<b>SEM NO.</b>	<b>REF. NO.</b>	<b>Type / Model</b>
	8743	7420780845	MAGNUM Dxi
<b>Description</b>			
Radiator Lower Hose			
49x59x490			
	<b>SEM NO.</b>	<b>REF. NO.</b>	<b>Type / Model</b>
	8744	7420710486 7482256614	MAGNUM Dxi
<b>Description</b>			
Radiator Upper			
49x59x415			
	<b>SEM NO.</b>	<b>REF. NO.</b>	<b>Type / Model</b>
	8745	7420829525	MAGNUM Dxi
<b>Description</b>			
Radiator Hose			
49x59x450			
	<b>SEM NO.</b>	<b>REF. NO.</b>	<b>Type / Model</b>
	8747	5010228348	MAGNUM Dxi
<b>Description</b>			
Radiator Lower Hose			
70x63x445x340			
	<b>SEM NO.</b>	<b>REF. NO.</b>	<b>Type / Model</b>
	8907	5010514267	BLACK
<b>Description</b>			
Radiator Hose			
	<b>SEM NO.</b>	<b>REF. NO.</b>	<b>Type / Model</b>
	8908	5010547186	BLACK
<b>Description</b>			
Radiator Hose			

Type / Model	REF. NO.	ŞEM NO.	
PREMIUM	5010269848	9565 (8909)	 <p><b>Description</b> Radiator Hose</p> <p>50x50x480</p>
PREMIUM	5010269292	9566	 <p><b>Description</b> Radiator Hose</p> <p>50x50x565</p>
PREMIUM	5010547174	10630	 <p><b>Description</b> Expansion Tank Hose</p> <p>27x27x720</p>
PREMIUM MAGNUM	5010588206	10631	 <p><b>Description</b> Air Hose</p> <p>19x19x850</p>
PREMIUM	5010530009	10632	 <p><b>Description</b> Expansion Tank Hose</p> <p>19x19x725</p>
PREMIUM	7482227320	10633	 <p><b>Description</b> Expansion Tank Hose</p> <p>11x11x870</p>

	SEM NO.	REF. NO.	Type / Model
 19x27x21x27	<b>10634</b>	7420880538	PREMIUM
	<b>Description</b> Expansion Tank Hose		







	SEM NO.	REF. NO.	Type / Model
 49x59x372	<b>10635</b>	7482227397	PREMIUM KERAX
	<b>Description</b> Radiator Hose		

	SEM NO.	REF. NO.	Type / Model
 27x31x196	<b>10636</b>	5010547175	PREMIUM KERAX
	<b>Description</b> Expansion Tank Hose		







	SEM NO.	REF. NO.	Type / Model
 19x19x246	<b>10637</b>	5010588225	MAGNUM PREMIUM MIDLUM
	<b>Description</b> Air Hose		







	SEM NO.	REF. NO.	Type / Model
 53x53x250	<b>11112</b>	5010467459	PREMIUM
	<b>Description</b> Water Hose		

	SEM NO.	REF. NO.	Type / Model
 50x60x530	<b>11113</b>	5010619238	PREMIUM
	<b>Description</b> Radiator Hose		

Type / Model	REF. NO.	SEM NO.	
PREMIUM	5010562993	11728	 <p><b>Description</b> Expansion Tank Hose</p> <p>11x11x1050</p>
PREMIUM	5010330600	11729	 <p><b>Description</b> Air Hose</p> <p>38x62x1120</p>
PREMIUM KERAX	5010514134	11730	 <p><b>Description</b> Radiator Hose</p> <p>50x50x555</p>
PREMIUM	5010530963	11731	 <p><b>Description</b> Expansion Tank Hose</p> <p>20x20x930</p>
PREMIUM	5010547427	11732	 <p><b>Description</b> Expansion Tank Hose</p> <p>19x15x280</p>
	5010514570	11754	 <p><b>Description</b> Radiator Hose</p>



	<table border="1"> <thead> <tr> <th>ŞEM NO.</th> <th>REF. NO.</th> <th>Type / Model</th> </tr> </thead> </table>	ŞEM NO.	REF. NO.	Type / Model
ŞEM NO.	REF. NO.	Type / Model		
	<table border="1"> <tbody> <tr> <td>8903</td> <td>5010514306</td> <td>BLACK RED</td> </tr> </tbody> </table>	8903	5010514306	BLACK RED
8903	5010514306	BLACK RED		
<p>D:Ø80 mm L:420 mm</p>	<p><b>Description</b> Silicon Hose</p>			
	<table border="1"> <thead> <tr> <th>ŞEM NO.</th> <th>REF. NO.</th> <th>Type / Model</th> </tr> </thead> </table>	ŞEM NO.	REF. NO.	Type / Model
ŞEM NO.	REF. NO.	Type / Model		
	<table border="1"> <tbody> <tr> <td>8904</td> <td>5010514309</td> <td>BLACK</td> </tr> </tbody> </table>	8904	5010514309	BLACK
8904	5010514309	BLACK		
<p>D:Ø80 mm L:450 mm</p>	<p><b>Description</b> Silicon Hose</p>			
	<table border="1"> <thead> <tr> <th>ŞEM NO.</th> <th>REF. NO.</th> <th>Type / Model</th> </tr> </thead> </table>	ŞEM NO.	REF. NO.	Type / Model
ŞEM NO.	REF. NO.	Type / Model		
	<table border="1"> <tbody> <tr> <td>8905</td> <td>5005026307</td> <td>RED</td> </tr> </tbody> </table>	8905	5005026307	RED
8905	5005026307	RED		
<p>D:Ø66 mm L:84 mm</p>	<p><b>Description</b> Silicon Hose</p>			
	<table border="1"> <thead> <tr> <th>ŞEM NO.</th> <th>REF. NO.</th> <th>Type / Model</th> </tr> </thead> </table>	ŞEM NO.	REF. NO.	Type / Model
ŞEM NO.	REF. NO.	Type / Model		
	<table border="1"> <tbody> <tr> <td>10053</td> <td>5010315892</td> <td>BLACK</td> </tr> </tbody> </table>	10053	5010315892	BLACK
10053	5010315892	BLACK		
<p>d=Ø75 d=Ø80 L=215 4 HUMP</p>	<p><b>Description</b> Silicon Hose</p>			
	<table border="1"> <thead> <tr> <th>ŞEM NO.</th> <th>REF. NO.</th> <th>Type / Model</th> </tr> </thead> </table>	ŞEM NO.	REF. NO.	Type / Model
ŞEM NO.	REF. NO.	Type / Model		
	<table border="1"> <tbody> <tr> <td>10665</td> <td>5010530392</td> <td>BLUE BLACK</td> </tr> </tbody> </table>	10665	5010530392	BLUE BLACK
10665	5010530392	BLUE BLACK		
<p>d=Ø52 L=470</p>	<p><b>Description</b> Silicon Hose</p>			
	<table border="1"> <thead> <tr> <th>ŞEM NO.</th> <th>REF. NO.</th> <th>Type / Model</th> </tr> </thead> </table>	ŞEM NO.	REF. NO.	Type / Model
ŞEM NO.	REF. NO.	Type / Model		
	<table border="1"> <tbody> <tr> <td>11194</td> <td>5010315487</td> <td>BLACK</td> </tr> </tbody> </table>	11194	5010315487	BLACK
11194	5010315487	BLACK		
<p>Ø90X260 6 HUMP</p>	<p><b>Description</b> Silicon Hose</p>			

Type / Model	REF. NO.	ŞEM NO.	
BLACK RED	5010315483	11195	 <b>Description</b> Silicon Hose Ø90X260 6 hump
BLACK RED	5010228308	11196	 <b>Description</b> Silicon Hose Ø90X125 3 hump
BLACK RED	5010514310	11197	 <b>Description</b> Silicon Hose Ø79X325 8 hump
BLACK RED	5005026256	11198	 <b>Description</b> Silicon Hose Ø50X120
BLACK RED	5010211839	11199	 <b>Description</b> Silicon Hose Ø75X150 2 hump
BLACK RED	5010095482 5010138320 5010211836	11200	 <b>Description</b> Silicon Hose Ø76X100

	SEM NO.	REF. NO.	Type / Model
	11201	5005026298	BLUE
	<b>Description</b>		
	Silicon Hose		
Ø60X71			







	SEM NO.	REF. NO.	Type / Model
	11202	5010315918	BLACK RED
	<b>Description</b>		
	Silicon Hose		
Ø80X235 4 hump			

	SEM NO.	REF. NO.	Type / Model
	11203	5005026180	BLACK RED
	<b>Description</b>		
	Silicon Hose		
Ø90X100			





	SEM NO.	REF. NO.	Type / Model
	11204	5010514807	BLACK RED
	<b>Description</b>		
	Silicon Hose		
Ø80X120			

	SEM NO.	REF. NO.	Type / Model
	11733	7420986427	RED
	<b>Description</b>		
	Silicon Hose		
Ø90x190 3 hump			

	SEM NO.	REF. NO.	Type / Model
	11734	7420931361	RED
	<b>Description</b>		
	Silicon Hose		
Ø80x193 3 hump			

Type / Model	REF. NO.		SEM NO.	
BLACK	7420953255		11735	 <p><b>Description</b> Silicon Hose</p> <p>Ø90x195 3 hump</p>
	5010315451		11834	 <p><b>Description</b> Silicon Hose</p> <p>Ø75x84x332</p>
	5010514312		11835	 <p><b>Description</b> Silicon Hose</p> <p>Ø80x90x325</p>
	5005026255		13043	 <p><b>Description</b> Silicon Hose</p> <p>d=Ø60 h=87</p>



	<table border="1"> <thead> <tr> <th>ŞEM NO.</th> <th>REF. NO.</th> <th>Type / Model</th> </tr> </thead> <tbody> <tr> <td>9009</td> <td>5000704264</td> <td>340 ti MAJOR</td> </tr> </tbody> </table>	ŞEM NO.	REF. NO.	Type / Model	9009	5000704264	340 ti MAJOR
ŞEM NO.	REF. NO.	Type / Model					
9009	5000704264	340 ti MAJOR					
<p><b>Description</b> Radiator Mounting</p>							
<p>D=Ø99 d=Ø28 d=Ø45 h=35</p>							
	<table border="1"> <thead> <tr> <th>ŞEM NO.</th> <th>REF. NO.</th> <th>Type / Model</th> </tr> </thead> <tbody> <tr> <td>9010</td> <td>5000704265</td> <td>340 ti MAJOR</td> </tr> </tbody> </table>	ŞEM NO.	REF. NO.	Type / Model	9010	5000704265	340 ti MAJOR
ŞEM NO.	REF. NO.	Type / Model					
9010	5000704265	340 ti MAJOR					
<p><b>Description</b> Radiator Mounting</p>							
	<table border="1"> <thead> <tr> <th>ŞEM NO.</th> <th>REF. NO.</th> <th>Type / Model</th> </tr> </thead> <tbody> <tr> <td>9011</td> <td>5010140586 5000751272 5010064318</td> <td>340 ti MAJOR</td> </tr> </tbody> </table>	ŞEM NO.	REF. NO.	Type / Model	9011	5010140586 5000751272 5010064318	340 ti MAJOR
ŞEM NO.	REF. NO.	Type / Model					
9011	5010140586 5000751272 5010064318	340 ti MAJOR					
<p><b>Description</b> Radiator Mounting</p>							
<p>D=Ø60 d=Ø22 h=30</p>							
	<table border="1"> <thead> <tr> <th>ŞEM NO.</th> <th>REF. NO.</th> <th>Type / Model</th> </tr> </thead> <tbody> <tr> <td>9012</td> <td>5000751271 5010064317 5010140587</td> <td>340 ti MAJOR</td> </tr> </tbody> </table>	ŞEM NO.	REF. NO.	Type / Model	9012	5000751271 5010064317 5010140587	340 ti MAJOR
ŞEM NO.	REF. NO.	Type / Model					
9012	5000751271 5010064317 5010140587	340 ti MAJOR					
<p><b>Description</b> Radiator Mounting</p>							
<p>D=Ø65 d=Ø22 h=44</p>							
	<table border="1"> <thead> <tr> <th>ŞEM NO.</th> <th>REF. NO.</th> <th>Type / Model</th> </tr> </thead> <tbody> <tr> <td>10998</td> <td>5010570047</td> <td></td> </tr> </tbody> </table>	ŞEM NO.	REF. NO.	Type / Model	10998	5010570047	
ŞEM NO.	REF. NO.	Type / Model					
10998	5010570047						
<p><b>Description</b> Rubber Metal Buffer</p>							
<p>d=Ø40 M10x1,5</p>							

Type / Model	REF. NO.	SEM NO.	
	5003065085	10864	
		<b>Description</b>	
		Oring	
			d=Ø37,5

	ŞEM NO.	REF. NO.	Type / Model
 L 720 mm	<b>10106</b>	5010060764 5010557243	
	<b>Description</b> Tie Rod		







	ŞEM NO.	REF. NO.	Type / Model
 L 810 mm	<b>10107</b>	5010294287	
	<b>Description</b> Tie Rod		





	ŞEM NO.	REF. NO.	Type / Model
 L 845 mm	<b>10108</b>	5010294288	
	<b>Description</b> Tie Rod		

	ŞEM NO.	REF. NO.	Type / Model
 L 945 mm	<b>10109</b>	5010229242 5010488052	
	<b>Description</b> Tie Rod		

	ŞEM NO.	REF. NO.	Type / Model
 Length: 325 mm	<b>11115 (11116)</b>	7421446333	
	<b>Description</b> Tie Rod		

	ŞEM NO.	REF. NO.	Type / Model
 Length: 335 mm	<b>11141</b>	5000450714	
	<b>Description</b> Tie Rod		

<b>Type / Model</b>	<b>REF. NO.</b>	<b>SEM NO.</b>	
	5000450713	11142	
			<b>Description</b> Tie Rod Length: 335 mm
<b>Type / Model</b>	<b>REF. NO.</b>	<b>SEM NO.</b>	
	5010253256	11143	
			<b>Description</b> Tie Rod Length: 280 mm
<b>Type / Model</b>	<b>REF. NO.</b>	<b>SEM NO.</b>	
	5010253255	11144	
			<b>Description</b> Tie Rod Length: 280 mm
<b>Type / Model</b>	<b>REF. NO.</b>	<b>SEM NO.</b>	
	5000787609	11145	
			<b>Description</b> Tie Rod Length: 150 mm
<b>Type / Model</b>	<b>REF. NO.</b>	<b>SEM NO.</b>	
	5010151409 5000869761	11146	
			<b>Description</b> Tie Rod Length: 120 mm
<b>Type / Model</b>	<b>REF. NO.</b>	<b>SEM NO.</b>	
	5010151410 5000869762 5000786379	11147	
			<b>Description</b> Tie Rod Length: 120 mm

	SEM NO.	REF. NO.	Type / Model
	11556	5000613598	
<b>Description</b>			
Tie Rod			
	11946	7420800194	
<b>Description</b>			
Tie Rod			
	12907	5001868366 5010587034 5010587038 7421560963	
<b>Description</b>			
Tie Rod			
L=1686			
	12909	5001868363 5010600822 5010587004 7421560957	
<b>Description</b>			
Tie Rod			
L=1726			

Type / Model	REF. NO.	ŞEM NO.	
MAGNUM AE 385 390 / 420 / 430 470 520 / 560 MAJOR R 340 / 350 / 380 385 420 / MANAGER G 200 210 / 230 / 270 280 300 / 330 / 340	MAXTER G 230 / 260 / 270 300 / 340 MIDLINER M 140 / 150 / 160 180 / 200 / 210	0003406169 5000288360 0003406236 5000590236 0003406251 5000804824 0003406254 5001858773 0003406260 7701011412	<b>8631</b> (8697)  <b>Description</b> Rod End  M30Xx1.5 RHT L=120
MAGNUM AE 385 390 / 420 / 430 470 520 / 560 MAJOR R 340 / 350 / 380 385 420 MANAGER G 200 210 / 230 / 270 280 300 / 330 / 340	MAXTER G 230 / 260 / 270 300 / 340 MIDLINER M 140 / 150 / 160 180 / 200 210	0003401170 5000823265 5000242478 5001832581 5000242486 5010832583 5000288361 5410027884 5000587534 5001858774	<b>8632</b> (8698)  <b>Description</b> Rod End  M30Xx1.5 LHT L=120
MAGNUM AE 385 390 / 420 / 430 470 520 / 560 MAJOR R 340 / 350 / 380 385 420 MANAGER G 200 210 / 230 / 270 280 300 / 330 / 340	MAXTER G 230 / 260 / 270 300 / 340 MIDLINER M 140 / 150 / 160 180 / 200 210	0003406242 5000559335 5000823987 5001825687	<b>8633</b> (8699)  <b>Description</b> Rod End  M28Xx1.5 RHT L=105
MAGNUM AE 385 390 / 420 / 430 470 520 / 560 MAJOR R 340 / 350 / 380 385 420 MANAGER G 200 210 / 230 / 270 280 300 / 330 / 340	MAXTER G 230 / 260 / 270 300 / 340 MIDLINER M 140 / 150 / 160 180 / 200 210	5000559336 5000823947 5000823997	<b>8634</b> (8700)  <b>Description</b> Rod End  M28Xx1.5 RHT L=105
MAGNUM AE 385 390 / 420 / 430 470 520 / 560 MAJOR R 340 / 350 / 380 385 420 MANAGER G 200 210 / 230 / 270 280 300 / 330 / 340	MAXTER G 230 / 260 / 270 300 / 340 MIDLINER M 140 / 150 / 160 180 / 200 / 210	0003406212 5000812483 0003406253 5001831473 5000242159 5001852264 5000295214 7701016946 5001832582 5001859985	<b>8635</b> (8701)  <b>Description</b> Rod End  M30Xx1.5 RHT L=115
MAGNUM AE 385 390 / 420 / 430 470 520 / 560 MAJOR R 340 / 350 / 380 385 420 MANAGER G 200 210 / 230 / 270 280 300 / 330 / 340	MAXTER G 230 / 260 / 270 300 / 340 MIDLINER M 140 / 150 / 160 180 / 200 / 210	0003406218 5000295215 0003406213 5001834533 5001859984 5001852263	<b>8636</b> (8702)  <b>Description</b> Rod End  M30Xx1.5 LHT L=115

	SEM NO.	REF. NO.	Type / Model
	<b>8637</b> (8703)	0003406252 5000807554 5000814097 5001844136	B70 - B90 GAMMA RANGE
	<b>Description</b>	5001860770 5001860123	
Rod End			
M24x1.5 RHT L=95			





	SEM NO.	REF. NO.	Type / Model
	<b>8638</b> (8704)	5000807553 5000814096 5001844135	B70 - B90 GAMMA RANGE
	<b>Description</b>		
Rod End			
M24x1.5 LHT L=95			

	SEM NO.	REF. NO.	Type / Model
	<b>8639</b> (8705)	5000808458 7701002911	
	<b>Description</b>		
Rod End			
M30x1.5 RHT L=120			

	SEM NO.	REF. NO.	Type / Model
	<b>10148</b>	5001852452 5001858763	
	<b>Description</b>		
Rod End			
M30x1.5 RHT L=140			

	SEM NO.	REF. NO.	Type / Model
	<b>10943</b> (10947)	0023162046 5000516214 5010144543	
	<b>Description</b>		
Rod End			

	SEM NO.	REF. NO.	Type / Model
	<b>11258</b>	5010245591	
	<b>Description</b>		
Tie Rod			

<b>Type / Model</b>	<b>REF. NO.</b>	<b>SEM NO.</b>	
	0003401207 5001831481 5001832580	<b>11560</b>	
		<b>Description</b>	Rod End
<b>Type / Model</b>	<b>REF. NO.</b>	<b>SEM NO.</b>	
	0003401206 5001832579	<b>11561</b>	
		<b>Description</b>	Rod End
<b>Type / Model</b>	<b>REF. NO.</b>	<b>SEM NO.</b>	
	7420894438	<b>11563</b>	
		<b>Description</b>	Rod End
<b>Type / Model</b>	<b>REF. NO.</b>	<b>SEM NO.</b>	
	5001866165 5001867774	<b>11564</b>	
		<b>Description</b>	Rod End
<b>Type / Model</b>	<b>REF. NO.</b>	<b>SEM NO.</b>	
	7420937674	<b>11579</b>	
		<b>Description</b>	Rod End





**SEM NO.**

8310 (10236)

**REF. NO.**







5001852775







**Type / Model**







**Description**

Rubber Metal Bushing

D=Ø63 d=Ø20 h=72,5

<b>Type / Model</b>	<b>REF. NO.</b>	<b>SEM NO.</b>	
	5010557698	8217	
		<b>Description</b>	
		Spring Eye Bushing	
			D=62 d=24 h=96
<b>Type / Model</b>	<b>REF. NO.</b>	<b>SEM NO.</b>	
	7420929989	10238	
		<b>Description</b>	
		Spring Bushing	
			D=Ø60 d=Ø24 h=96
<b>Type / Model</b>	<b>REF. NO.</b>	<b>SEM NO.</b>	
	5010630625	11000	
		<b>Description</b>	
		Spring Eye Bushing	
			D=Ø50 d=Ø20 h=96
<b>Type / Model</b>	<b>REF. NO.</b>	<b>SEM NO.</b>	
	7421483476	12000	
		<b>Description</b>	
		Spring Eye Bushing	
			D=Ø50 d=Ø20 h=96
<b>Type / Model</b>	<b>REF. NO.</b>	<b>SEM NO.</b>	
	5001859721	8150	
		<b>Description</b>	
		Spring Bushing	
			D=Ø62 d=Ø24 h=97
<b>Type / Model</b>	<b>REF. NO.</b>	<b>SEM NO.</b>	
	7420839455	10441 (10442)	
		<b>Description</b>	
		Rubber Metal Bush	
			D=Ø61,5 d=Ø24 h=87

	<b>SEM NO.</b>	<b>REF. NO.</b>	<b>Type / Model</b>
	<b>10446</b>	5010557875 5001874879	
	<b>Description</b> Rubber Metal Bush		
D=Ø61,5 d=Ø24 L=95			
	<b>SEM NO.</b>	<b>REF. NO.</b>	<b>Type / Model</b>
	<b>10472</b>	5516010769	
	<b>Description</b> Spring Bushing		
D=Ø34 d=Ø18 L=54			
	<b>SEM NO.</b>	<b>REF. NO.</b>	<b>Type / Model</b>
	<b>7787</b>	5000815738	
	<b>Description</b> Spring Bushing		
D=Ø68 d=Ø30 h=104			
	<b>SEM NO.</b>	<b>REF. NO.</b>	<b>Type / Model</b>
	<b>8027</b>	5001852218 5001835446	
	<b>Description</b> Spring Bushing		
D=Ø70 d=Ø30 h=104			
	<b>SEM NO.</b>	<b>REF. NO.</b>	<b>Type / Model</b>
	<b>11781</b>	 7482139627 5001867795	
	<b>Description</b> Rubber Metal Bushing		
D=Ø60 d=Ø24 L=63			
	<b>SEM NO.</b>	<b>REF. NO.</b>	<b>Type / Model</b>
	<b>8287</b>	5000448404	
	<b>Description</b> Spring Eye Bushing		
D=Ø43,5 d=Ø16 h=95			

<b>Type / Model</b>	<b>REF. NO.</b>	<b>SEM NO.</b>	
	5000448405	8288	
		<b>Description</b>	
		Spring Eye Bushing	
			D=Ø54 d=Ø20 h=95
<b>Type / Model</b>	<b>REF. NO.</b>	<b>SEM NO.</b>	
	5010294961	8289	
		<b>Description</b>	
		Spring Eye Bushing	
			D=Ø43,5 d=Ø16 h=81
<b>Type / Model</b>	<b>REF. NO.</b>	<b>SEM NO.</b>	
	5010294770	10468	
		<b>Description</b>	
		Spring Bushing	
			D=Ø53 d=Ø20 L=81
<b>Type / Model</b>	<b>REF. NO.</b>	<b>SEM NO.</b>	
	5010066115	10465	
		<b>Description</b>	
		Spring Bushing	
			D=Ø56 d=Ø21 L=85
<b>Type / Model</b>	<b>REF. NO.</b>	<b>SEM NO.</b>	
	5010066116	10466	
		<b>Description</b>	
		Spring Bushing	
			D=Ø68 d=Ø25 L=85
<b>Type / Model</b>	<b>REF. NO.</b>	<b>SEM NO.</b>	
	5010137848	10469	
		<b>Description</b>	
		Spring Bushing	
			D=Ø61 d=Ø24 L=90

	SEM NO.	REF. NO.	Type / Model
 D=Ø37 d=Ø16 h=70	9252	5000392206	
	<b>Description</b> Spring Eye Bushing		





	SEM NO.	REF. NO.	Type / Model
 d=Ø35 L=75	11794	5001862978	
	<b>Description</b> Bushing		

	SEM NO.	REF. NO.	Type / Model
 D = Ø34 d = Ø28 L = 89	11627	5001851118 7485126312	
	<b>Description</b> Spring Bushing		

	SEM NO.	REF. NO.	Type / Model
 D=Ø104 d=Ø20,3 h=44,7	8625	5010060127	MAGNUM MANAGER MAXTER PREMIUM KERAX
	<b>Description</b> Spring Bushing		

	SEM NO.	REF. NO.	Type / Model
 D=Ø111 d=Ø63,5 h=146	8628	5010130652	KERAX
	<b>Description</b> Spring Bushing		

	SEM NO.	REF. NO.	Type / Model
 D=Ø111 d=Ø63,5 h=146	8978	5010130738	
	<b>Description</b> Spring Bold		

Type / Model	REF. NO.	SEM NO.	
	5010567399	8979	 <p><b>Description</b> Spring Bolt</p>
	5003101867	8980	 <p><b>Description</b> Spring Bolt</p>
	5003101526	8981	 <p><b>Description</b> Spring Bolt</p>
	5003034275	8982	 <p><b>Description</b> Spring Nut</p>
	5010051192	10865	 <p><b>Description</b> Plastic Cover</p>

d=Ø20

Description / Repair Kit for Axle	SEM NO.	Model:								
	<b>8971</b>									
	REF. NO: 5010060127S	<table border="1"> <thead> <tr> <th>Item No</th> <th>Ref. No</th> </tr> </thead> <tbody> <tr> <td>1</td> <td>5010060127</td> </tr> <tr> <td>2</td> <td>5010051192</td> </tr> <tr> <td>3</td> <td>5003065085</td> </tr> </tbody> </table>	Item No	Ref. No	1	5010060127	2	5010051192	3	5003065085
	Item No	Ref. No								
	1	5010060127								
	2	5010051192								
3	5003065085									

Description / Repair Kit for Axle	SEM NO.	Model:								
	<b>8971-1</b>									
	REF. NO: 5010060127S	<table border="1"> <thead> <tr> <th>Item No</th> <th>Ref. No</th> </tr> </thead> <tbody> <tr> <td>1</td> <td>5010060127</td> </tr> <tr> <td>2</td> <td>Alternatively Design 5010051192</td> </tr> <tr> <td>3</td> <td>5003065085</td> </tr> </tbody> </table>	Item No	Ref. No	1	5010060127	2	Alternatively Design 5010051192	3	5003065085
	Item No	Ref. No								
	1	5010060127								
	2	Alternatively Design 5010051192								
3	5003065085									

Description / Repair Kit for Axle	SEM NO.	Model:																
	<b>8972</b>																	
	REF. NO: 5010060127S1	<table border="1"> <thead> <tr> <th>Item No</th> <th>Ref. No</th> </tr> </thead> <tbody> <tr> <td>1</td> <td>5010060127</td> </tr> <tr> <td>2</td> <td>5010130738</td> </tr> <tr> <td>3</td> <td>5010051192</td> </tr> <tr> <td>4</td> <td>5003065085</td> </tr> <tr> <td>5</td> <td>5003034275</td> </tr> <tr> <td>6</td> <td>5003058086</td> </tr> <tr> <td>7</td> <td>5005097021</td> </tr> </tbody> </table>	Item No	Ref. No	1	5010060127	2	5010130738	3	5010051192	4	5003065085	5	5003034275	6	5003058086	7	5005097021
	Item No	Ref. No																
	1	5010060127																
	2	5010130738																
	3	5010051192																
	4	5003065085																
	5	5003034275																
	6	5003058086																
7	5005097021																	

Description / Repair Kit for Axle	SEM NO.	Model:																
	<b>8972-1</b>																	
	REF. NO: 5010060127S1	<table border="1"> <thead> <tr> <th>Item No</th> <th>Ref. No</th> </tr> </thead> <tbody> <tr> <td>1</td> <td>5010060127</td> </tr> <tr> <td>2</td> <td>Alternatively Design 5010130738</td> </tr> <tr> <td>3</td> <td>5010051192</td> </tr> <tr> <td>4</td> <td>5003065085</td> </tr> <tr> <td>5</td> <td>5003034275</td> </tr> <tr> <td>6</td> <td>5003058086</td> </tr> <tr> <td>7</td> <td>5005097021</td> </tr> </tbody> </table>	Item No	Ref. No	1	5010060127	2	Alternatively Design 5010130738	3	5010051192	4	5003065085	5	5003034275	6	5003058086	7	5005097021
	Item No	Ref. No																
	1	5010060127																
	2	Alternatively Design 5010130738																
	3	5010051192																
	4	5003065085																
	5	5003034275																
	6	5003058086																
7	5005097021																	



Model:	SEM NO.	Description / Repair Kit for Axle
	<b>8973</b>	
<b>Item No</b>	<b>Ref. No</b>	<b>REF. NO:</b>
1	5010060127	5010060127S2
2	5010567399	
3	5010051192	
4	5003065085	
5	5003034275	
6	5003058086	
7	5005097021	



Model:	SEM NO.	Description / Repair Kit for Axle
	<b>8973-1</b>	
<b>Item No</b>	<b>Ref. No</b>	<b>REF. NO:</b>
1	5010060127	5010060127S2
2	5010567399	
3	5010051192	
4	5003065085	
5	5003034275	
6	5003058086	
7	5005097021	



Model:	SEM NO.	Description / Repair Kit for Axle
	<b>8974</b>	
<b>Item No</b>	<b>Ref. No</b>	<b>REF. NO:</b>
1	5010060127	5010060127S3
2	5010130738	
3	5010567399	
4	5010051192	
5	5003058086	
6	5003065085	
7	5003034275	
8	5005097021	



Model:	SEM NO.	Description / Repair Kit for Axle
	<b>8974-1</b>	
<b>Item No</b>	<b>Ref. No</b>	<b>REF. NO:</b>
1	5010060127	5010060127S3
2	5010130738	
3	5010567399	
4	5010051192	
5	5003058086	
6	5003065085	
7	5003034275	
8	5005097021	





Description / Repair Kit for Axle	SEM NO.	Model:														
	<b>8975</b>															
	<b>REF. NO:</b> 5010060127S4	<table border="1"> <thead> <tr> <th>Item No</th> <th>Ref. No</th> </tr> </thead> <tbody> <tr> <td>1</td> <td>5010060127</td> </tr> <tr> <td>2</td> <td>5003101867</td> </tr> <tr> <td>3</td> <td>5010051192</td> </tr> <tr> <td>4</td> <td>5003058086</td> </tr> <tr> <td>5</td> <td>5003065085</td> </tr> <tr> <td>6</td> <td>5003034275</td> </tr> </tbody> </table>	Item No	Ref. No	1	5010060127	2	5003101867	3	5010051192	4	5003058086	5	5003065085	6	5003034275
	Item No	Ref. No														
	1	5010060127														
	2	5003101867														
	3	5010051192														
	4	5003058086														
	5	5003065085														
6	5003034275															

Description / Repair Kit for Axle	SEM NO.	Model:																
	<b>8975-1</b>																	
	<b>REF. NO:</b> 5010060127S4	<table border="1"> <thead> <tr> <th>Item No</th> <th>Ref. No</th> </tr> </thead> <tbody> <tr> <td>1</td> <td>5010060127</td> </tr> <tr> <td></td> <td>Alternatively Design</td> </tr> <tr> <td>2</td> <td>5003101867</td> </tr> <tr> <td>3</td> <td>5010051192</td> </tr> <tr> <td>4</td> <td>5003058086</td> </tr> <tr> <td>5</td> <td>5003065085</td> </tr> <tr> <td>6</td> <td>5003034275</td> </tr> </tbody> </table>	Item No	Ref. No	1	5010060127		Alternatively Design	2	5003101867	3	5010051192	4	5003058086	5	5003065085	6	5003034275
	Item No	Ref. No																
	1	5010060127																
		Alternatively Design																
	2	5003101867																
	3	5010051192																
	4	5003058086																
5	5003065085																	
6	5003034275																	

Description / Repair Kit for Axle	SEM NO.	Model:														
	<b>8976</b>															
	<b>REF. NO:</b> 5010060127S5	<table border="1"> <thead> <tr> <th>Item No</th> <th>Ref. No</th> </tr> </thead> <tbody> <tr> <td>1</td> <td>5010060127</td> </tr> <tr> <td>2</td> <td>5003101526</td> </tr> <tr> <td>3</td> <td>5010051192</td> </tr> <tr> <td>4</td> <td>5003065085</td> </tr> <tr> <td>5</td> <td>5003058086</td> </tr> <tr> <td>6</td> <td>5003034275</td> </tr> </tbody> </table>	Item No	Ref. No	1	5010060127	2	5003101526	3	5010051192	4	5003065085	5	5003058086	6	5003034275
	Item No	Ref. No														
	1	5010060127														
	2	5003101526														
	3	5010051192														
	4	5003065085														
	5	5003058086														
6	5003034275															

Description / Repair Kit for Axle	SEM NO.	Model:																
	<b>8976-1</b>																	
	<b>REF. NO:</b> 5010060127S5	<table border="1"> <thead> <tr> <th>Item No</th> <th>Ref. No</th> </tr> </thead> <tbody> <tr> <td>1</td> <td>5010060127</td> </tr> <tr> <td></td> <td>Alternatively Design</td> </tr> <tr> <td>2</td> <td>5003101526</td> </tr> <tr> <td>3</td> <td>5010051192</td> </tr> <tr> <td>4</td> <td>5003065085</td> </tr> <tr> <td>5</td> <td>5003058086</td> </tr> <tr> <td>6</td> <td>5003034275</td> </tr> </tbody> </table>	Item No	Ref. No	1	5010060127		Alternatively Design	2	5003101526	3	5010051192	4	5003065085	5	5003058086	6	5003034275
	Item No	Ref. No																
	1	5010060127																
		Alternatively Design																
	2	5003101526																
	3	5010051192																
	4	5003065085																
5	5003058086																	
6	5003034275																	

Model:	ŞEM NO.	Description / Repair Kit for Axle
	<b>8977</b>	
<b>Item No</b>	<b>Ref. No</b>	<b>REF. NO:</b>
1	5010060127	5010060127S6
2	5003101526	
3	5003101867	
4	5010051192	
5	5003058086	
6	5003065085	
7	5003034275	



Model:	ŞEM NO.	Description / Repair Kit for Axle
	<b>8977-1</b>	
<b>Item No</b>	<b>Ref. No</b>	<b>REF. NO:</b>
1	5010060127	5010060127S6
2	5003101526	
3	5003101867	
4	5010051192	
5	5003058086	
6	5003065085	
7	5003034275	





Model:	ŞEM NO.	Description / Stabilizer Repair Kit
	<b>9175</b>	
<b>Item No</b>	<b>Ref. No</b>	<b>REF. NO:</b>
1	5000448405	5000448405S
2	----	
3	----	
4	----	
5	5000448755	
6	5000659178	
7	----	



Model:	ŞEM NO.	Description / Stabilizer Repair Kit
	<b>9176</b>	
<b>Item No</b>	<b>Ref. No</b>	<b>REF. NO:</b>
1	5000448404	5000448404S
2	----	
3	----	
4	----	
5	5000448754	
6	----	
7	----	
8	----	



Description / Spring Repair Kit	SEM NO.	Model:										
	<b>9178</b>											
	REF. NO: 5001852218S 5001835446S	<table border="1"> <thead> <tr> <th>Item No</th> <th>Ref. No</th> </tr> </thead> <tbody> <tr> <td>1</td> <td>5001852218</td> </tr> <tr> <td>2</td> <td>5010294518</td> </tr> <tr> <td>3</td> <td>5010239047</td> </tr> <tr> <td>4</td> <td>5003034274</td> </tr> </tbody> </table>	Item No	Ref. No	1	5001852218	2	5010294518	3	5010239047	4	5003034274
	Item No	Ref. No										
1	5001852218											
2	5010294518											
3	5010239047											
4	5003034274											

Description / Spring Repair Kit	SEM NO.	Model:										
	<b>9179</b>											
	REF. NO: 5000815738S	<table border="1"> <thead> <tr> <th>Item No</th> <th>Ref. No</th> </tr> </thead> <tbody> <tr> <td>1</td> <td>1-5000815754</td> </tr> <tr> <td>2</td> <td>2-5000815755</td> </tr> <tr> <td>3</td> <td>3-5001836994</td> </tr> <tr> <td>4</td> <td>4-5000815738</td> </tr> </tbody> </table>	Item No	Ref. No	1	1-5000815754	2	2-5000815755	3	3-5001836994	4	4-5000815738
	Item No	Ref. No										
1	1-5000815754											
2	2-5000815755											
3	3-5001836994											
4	4-5000815738											

Description / Spring Repair Kit	SEM NO.	Model:														
	<b>9181</b>															
	REF. NO: 5010130652S	<table border="1"> <thead> <tr> <th>Item No</th> <th>Ref. No</th> </tr> </thead> <tbody> <tr> <td>1</td> <td>5010130652</td> </tr> <tr> <td>2</td> <td>5010130671</td> </tr> <tr> <td>3</td> <td>5010130670</td> </tr> <tr> <td>4</td> <td>5010130668</td> </tr> <tr> <td>5</td> <td>5010130669</td> </tr> <tr> <td>6</td> <td>5010130667</td> </tr> </tbody> </table>	Item No	Ref. No	1	5010130652	2	5010130671	3	5010130670	4	5010130668	5	5010130669	6	5010130667
	Item No	Ref. No														
1	5010130652															
2	5010130671															
3	5010130670															
4	5010130668															
5	5010130669															
6	5010130667															

Description / Spring Repair Kit	SEM NO.	Model:												
	<b>9182</b>													
	REF. NO: 5010130652S1	<table border="1"> <thead> <tr> <th>Item No</th> <th>Ref. No</th> </tr> </thead> <tbody> <tr> <td>1</td> <td>1-5010130668</td> </tr> <tr> <td>2</td> <td>2-5010130671</td> </tr> <tr> <td>3</td> <td>3-5010130670</td> </tr> <tr> <td>4</td> <td>4-5010130669</td> </tr> <tr> <td>5</td> <td>5-5010130667</td> </tr> </tbody> </table>	Item No	Ref. No	1	1-5010130668	2	2-5010130671	3	3-5010130670	4	4-5010130669	5	5-5010130667
	Item No	Ref. No												
1	1-5010130668													
2	2-5010130671													
3	3-5010130670													
4	4-5010130669													
5	5-5010130667													

Model:	ŞEM NO.	Description / Repair Kit
	<b>10075</b>	
<b>Item No</b>	<b>Ref. No</b>	<b>REF. NO:</b>
1	1- 5001859721	5001859721S1
2	2- 7421041753	
3	3- 7703067106	
4	4- 5010571624	
5	5- 5010557138	
6	6- 5003053480	
7	7- 5010571079	



Model:	ŞEM NO.	Description / Repair Kit
	<b>10076</b>	
<b>Item No</b>	<b>Ref. No</b>	<b>REF. NO:</b>
1	5001859721	5001859721S2
2	7421041753	
3	7703067106	
4	5010571624	
5	5010557138	
6	5003053480	
7	5010571079	



Model:	ŞEM NO.	Description / Repair Kit
	<b>10077</b>	
<b>Item No</b>	<b>Ref. No</b>	<b>REF. NO:</b>
1	5010571342	5001859721S3
2	5001859721	
3	7421041753	
4	5010377448	
5	5010557138	
6	5003053480	
7	5010571079	



Model:	ŞEM NO.	Description / Repair Kit
	<b>10078</b>	
<b>Item No</b>	<b>Ref. No</b>	<b>REF. NO:</b>
1	5010571342	5001859721S4
2	7421041753	
3	5001859721	
4	5010377448	
5	5010557138	
6	5003053480	
7	5010571079	



	SEM NO.	REF. NO.	Type / Model
	8592	7401506399	
	<b>Description</b>		
	Spring Mounting		
D=Ø98 h=121			

	SEM NO.	REF. NO.	Type / Model
	10470	5010130673	
	<b>Description</b>		
	Rubber Bush		
D=Ø84 d=Ø26 L=72			









	SEM NO.	REF. NO.	Type / Model
	9013	0000777903 5010634554	340 ti MAJOR
	<b>Description</b>		
	Spring Mounting		
45x81x56			

	SEM NO.	REF. NO.	Type / Model
	11945	 7400351111	
	<b>Description</b>		
	Rubber Metal Buffer		

	SEM NO.	REF. NO.	Type / Model
	10055	5010634553	
	<b>Description</b>		
	Spring Mounting		
105x120x65 M10x1,5			

	SEM NO.	REF. NO.	Type / Model
	7713	5000288447	
	<b>Description</b>		
	Spring Rubber		
80x56x15			



<b>Type / Model</b>	<b>REF. NO.</b>		<b>SEM NO.</b>	
	5000731430		<b>11839</b>	
			<b>Description</b>	
			Rubber Metal Buffer	
				D=Ø85 h=16
<b>Type / Model</b>	<b>REF. NO.</b>		<b>SEM NO.</b>	
	7420390836		<b>8333 (8403)</b>	
			<b>Description</b>	
			Spring Mounting	
				150x196x150
<b>Type / Model</b>	<b>REF. NO.</b>		<b>SEM NO.</b>	
	7420442252		<b>8622 (8626)</b>	
			<b>Description</b>	
			Stabilizer Bush	
				D=Ø154 d=Ø81 h=71
<b>Type / Model</b>	<b>REF. NO.</b>		<b>SEM NO.</b>	
	7220466804		<b>9057 (9197)</b>	
			<b>Description</b>	
			Metal Bushing	
				D=Ø107 d=Ø25 h=74
<b>Type / Model</b>	<b>REF. NO.</b>		<b>SEM NO.</b>	
	7421363702		<b>13040</b>	
			<b>Description</b>	
			Metal Bushing	
<b>Type / Model</b>	<b>REF. NO.</b>		<b>SEM NO.</b>	
	5010383950		<b>8788</b>	
			<b>Description</b>	
			Pur Mounting	
				D=Ø96 M12 h=122



**SEM NO.**

**REF. NO.**

**Type / Model**

**9031**

5010383951

**Description**

Pur Mounting

D=Ø96 h=100



**SEM NO.**

**REF. NO.**

**Type / Model**

**10415**

7400984970

**Description**

Screw

M24x2x260



**SEM NO.**

**REF. NO.**

**Type / Model**

**10416**

5003034182  
7400963096

**Description**

Nut

M24x2

Model:	ŞEM NO.	Description / Pur Mounting Repair Kit)
	<b>9238</b>	
	<b>REF. NO:</b> 5010383950S 5003101150S	
		D=Ø96 h=122

Model:	ŞEM NO.	Description / Pur Mounting Repair Kit)
	<b>9239</b>	
	<b>REF. NO:</b> 5010383951S 5003101150S1	
		D=Ø96 h=100

Model:	ŞEM NO.	Description / Repair Kit										
	<b>10291 (10434)</b>											
<table border="1"> <thead> <tr> <th>Item No</th> <th>Ref. No</th> </tr> </thead> <tbody> <tr> <td>1</td> <td>8622</td> </tr> <tr> <td>2</td> <td>9057</td> </tr> <tr> <td>3</td> <td>10415</td> </tr> <tr> <td>4</td> <td>10416</td> </tr> </tbody> </table>	Item No	Ref. No	1	8622	2	9057	3	10415	4	10416	<b>REF. NO:</b> 7420429274S	
Item No	Ref. No											
1	8622											
2	9057											
3	10415											
4	10416											

Model:	ŞEM NO.	Description / Repair Kit						
	<b>13039</b>							
<table border="1"> <thead> <tr> <th>Item No</th> <th>Ref. No</th> </tr> </thead> <tbody> <tr> <td>1</td> <td>8622 - 2 Pcs.</td> </tr> <tr> <td>2</td> <td>9057 - 1 Pcs.</td> </tr> </tbody> </table>	Item No	Ref. No	1	8622 - 2 Pcs.	2	9057 - 1 Pcs.	<b>REF. NO:</b> 7420429274S1	
Item No	Ref. No							
1	8622 - 2 Pcs.							
2	9057 - 1 Pcs.							



**Description / Repair Kit**      **SEM NO.**      **Model:**



**13041**



**REF. NO:** 7421363702S1

Item No	Ref. No
1	8622 - 2 Pcs.
2	13040 - 1 Pcs.

**Description / Repair Kit**      **SEM NO.**      **Model:**









**13042**













**REF. NO:** 7421363702S







Item No	Ref. No
1	8622
2	13040
3	10415
4	10416

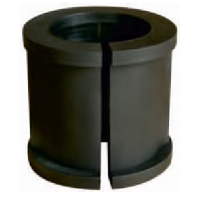





Type / Model	REF. NO.	SEM NO.	
	5010488949	11405	
		<b>Description</b>	
		Spring Bolt (U)	
			M24x151x370

	<table border="1"> <thead> <tr> <th>SEM NO.</th> <th>REF. NO.</th> <th>Type / Model</th> </tr> </thead> <tbody> <tr> <td>8009</td> <td>7401629169</td> <td></td> </tr> </tbody> </table>	SEM NO.	REF. NO.	Type / Model	8009	7401629169		<p><b>Description</b> Stabilizer Rubber</p>
SEM NO.	REF. NO.	Type / Model						
8009	7401629169							
<p>D=Ø82 d=Ø60 h=97</p>								
	<table border="1"> <thead> <tr> <th>SEM NO.</th> <th>REF. NO.</th> <th>Type / Model</th> </tr> </thead> <tbody> <tr> <td>8793</td> <td>5516031136</td> <td></td> </tr> </tbody> </table>	SEM NO.	REF. NO.	Type / Model	8793	5516031136		<p><b>Description</b> Stabilizer Rubber</p>
SEM NO.	REF. NO.	Type / Model						
8793	5516031136							
<p>34x69,5x70,5</p>								
	<table border="1"> <thead> <tr> <th>SEM NO.</th> <th>REF. NO.</th> <th>Type / Model</th> </tr> </thead> <tbody> <tr> <td>8794</td> <td>5516031135</td> <td></td> </tr> </tbody> </table>	SEM NO.	REF. NO.	Type / Model	8794	5516031135		<p><b>Description</b> Stabilizer Rubber</p>
SEM NO.	REF. NO.	Type / Model						
8794	5516031135							
<p>41x79x80</p>								
	<table border="1"> <thead> <tr> <th>SEM NO.</th> <th>REF. NO.</th> <th>Type / Model</th> </tr> </thead> <tbody> <tr> <td>8795</td> <td>5010215010</td> <td></td> </tr> </tbody> </table>	SEM NO.	REF. NO.	Type / Model	8795	5010215010		<p><b>Description</b> Stabilizer Rubber</p>
SEM NO.	REF. NO.	Type / Model						
8795	5010215010							
<p>36x80x66</p>								
	<table border="1"> <thead> <tr> <th>SEM NO.</th> <th>REF. NO.</th> <th>Type / Model</th> </tr> </thead> <tbody> <tr> <td>8796</td> <td>5000396856</td> <td></td> </tr> </tbody> </table>	SEM NO.	REF. NO.	Type / Model	8796	5000396856		<p><b>Description</b> Stabilizer Rubber</p>
SEM NO.	REF. NO.	Type / Model						
8796	5000396856							
<p>31,5x48x57x60x80</p>								
	<table border="1"> <thead> <tr> <th>SEM NO.</th> <th>REF. NO.</th> <th>Type / Model</th> </tr> </thead> <tbody> <tr> <td>8797</td> <td>5000391730</td> <td></td> </tr> </tbody> </table>	SEM NO.	REF. NO.	Type / Model	8797	5000391730		<p><b>Description</b> Stabilizer Rubber</p>
SEM NO.	REF. NO.	Type / Model						
8797	5000391730							
<p>30x40x58,5x60x66</p>								

<b>Type / Model</b>	<b>REF. NO.</b>	<b>SEM NO.</b>	
	5010130022	<b>8799</b>	
		<b>Description</b>	
		Stabilizer Rubber	
			D=Ø66,5 d=Ø40 h=60
<b>Type / Model</b>	<b>REF. NO.</b>	<b>SEM NO.</b>	
	5010130021	<b>8800</b>	
		<b>Description</b>	
		Stabilizer Rubber	
			D=Ø67 d=Ø38 h=60
<b>Type / Model</b>	<b>REF. NO.</b>	<b>SEM NO.</b>	
	5010060356	<b>8801</b>	
		<b>Description</b>	
		Stabilizer Rubber	
			D=Ø90,5 d=Ø53 h=73,5
<b>Type / Model</b>	<b>REF. NO.</b>	<b>SEM NO.</b>	
	7401134955	<b>7822 (10471)</b>	
		<b>Description</b>	
		Bush	
			D=Ø57,5 d=Ø28 h=64
<b>Type / Model</b>	<b>REF. NO.</b>	<b>SEM NO.</b>	
	41218902	<b>10056</b>	
		<b>Description</b>	
		Rubber Metal Bush	
<b>Type / Model</b>	<b>REF. NO.</b>	<b>SEM NO.</b>	
	5010557130	<b>10875</b>	
		<b>Description</b>	
		Rubber Metal Bush	
			D=Ø45 d=Ø20 L=66

	<table border="1"> <thead> <tr> <th>SEM NO.</th> <th>REF. NO.</th> <th>Type / Model</th> </tr> </thead> <tbody> <tr> <td>10876</td> <td>5010557129</td> <td></td> </tr> </tbody> </table>	SEM NO.	REF. NO.	Type / Model	10876	5010557129		<p><b>Description</b> Rubber Metal Bush</p>
SEM NO.	REF. NO.	Type / Model						
10876	5010557129							
<p>D=Ø45 d=Ø20 L=66</p>								
	<table border="1"> <thead> <tr> <th>SEM NO.</th> <th>REF. NO.</th> <th>Type / Model</th> </tr> </thead> <tbody> <tr> <td>8286</td> <td>5010383545</td> <td></td> </tr> </tbody> </table>	SEM NO.	REF. NO.	Type / Model	8286	5010383545		<p><b>Description</b> Bush</p>
SEM NO.	REF. NO.	Type / Model						
8286	5010383545							
<p>D=Ø51.5 d=Ø20 h=41</p>								
	<table border="1"> <thead> <tr> <th>SEM NO.</th> <th>REF. NO.</th> <th>Type / Model</th> </tr> </thead> <tbody> <tr> <td>8600</td> <td>5010557315</td> <td></td> </tr> </tbody> </table>	SEM NO.	REF. NO.	Type / Model	8600	5010557315		<p><b>Description</b> Stabilizer Plastic</p>
SEM NO.	REF. NO.	Type / Model						
8600	5010557315							
<p>D=Ø58 d=Ø38 h=73</p>								
	<table border="1"> <thead> <tr> <th>SEM NO.</th> <th>REF. NO.</th> <th>Type / Model</th> </tr> </thead> <tbody> <tr> <td>10443</td> <td>5010557313</td> <td></td> </tr> </tbody> </table>	SEM NO.	REF. NO.	Type / Model	10443	5010557313		<p><b>Description</b> Plastic Bearing</p>
SEM NO.	REF. NO.	Type / Model						
10443	5010557313							
<p>D=Ø65 d=Ø50 L=77</p>								
	<table border="1"> <thead> <tr> <th>SEM NO.</th> <th>REF. NO.</th> <th>Type / Model</th> </tr> </thead> <tbody> <tr> <td>10444</td> <td>5010557314</td> <td></td> </tr> </tbody> </table>	SEM NO.	REF. NO.	Type / Model	10444	5010557314		<p><b>Description</b> Plastic Bearing</p>
SEM NO.	REF. NO.	Type / Model						
10444	5010557314							
<p>D=Ø65 d=Ø38 L=77</p>								
	<table border="1"> <thead> <tr> <th>SEM NO.</th> <th>REF. NO.</th> <th>Type / Model</th> </tr> </thead> <tbody> <tr> <td>8189</td> <td>5010066937</td> <td></td> </tr> </tbody> </table>	SEM NO.	REF. NO.	Type / Model	8189	5010066937		<p><b>Description</b> Stabilizer Plastic Bush</p>
SEM NO.	REF. NO.	Type / Model						
8189	5010066937							
<p>D=Ø80 d=Ø53 h=76</p>								

<b>Type / Model</b>	<b>REF. NO.</b>	<b>SEM NO.</b>	
	5000464785 5010557312	<b>8798</b> (10445)	
		<b>Description</b>	
		Stabilizer Plastics	
			54,5x64x79*76
<b>Type / Model</b>	<b>REF. NO.</b>	<b>SEM NO.</b>	
	5010066936	<b>8802</b>	
		<b>Description</b>	
		Stabilizer Rubber	
			D=Ø75 d=Ø40 h=85
<b>Type / Model</b>	<b>REF. NO.</b>	<b>SEM NO.</b>	
	0000714814	<b>8599</b>	
		<b>Description</b>	
		Stabilizer Plastic	
			D=Ø33 h=60
<b>Type / Model</b>	<b>REF. NO.</b>	<b>SEM NO.</b>	
	0000716243	<b>9060</b>	
		<b>Description</b>	
		Stabilizer Bearing	
			D=Ø70 d=Ø38 h=60
<b>Type / Model</b>	<b>REF. NO.</b>	<b>SEM NO.</b>	
	0000716242	<b>9061</b>	
		<b>Description</b>	
		Stabilizer Bearing	
			D=Ø70 d=Ø42 h=60
<b>Type / Model</b>	<b>REF. NO.</b>	<b>SEM NO.</b>	
	5010304950	<b>7803</b>	
		<b>Description</b>	
		Stabilizer Mounting	
			D=Ø86 d=Ø51 h=63

	<b>SEM NO.</b>	<b>REF. NO.</b>	<b>Type / Model</b>
	<b>8601</b>	<b>5010239670</b>	
D=Ø60 d=Ø42 h=26	<b>Description</b> Stabilizer Plastic		
	<b>SEM NO.</b>	<b>REF. NO.</b>	<b>Type / Model</b>
	<b>8292</b>	<b>0000714088</b>	
D=Ø50 d=Ø25 h=50	<b>Description</b> Bearing		
	<b>SEM NO.</b>	<b>REF. NO.</b>	<b>Type / Model</b>
	<b>10999</b>	<b>5010294991</b>	
D=Ø42 d=Ø30 L=19	<b>Description</b> Stabilizer Bushing		
	<b>SEM NO.</b>	<b>REF. NO.</b>	<b>Type / Model</b>
	<b>10923</b>	<b>5010064794</b>	
M20x1,5 L=290	<b>Description</b> Screw		
	<b>SEM NO.</b>	<b>REF. NO.</b>	<b>Type / Model</b>
	<b>11840</b>	 <b>5010239135</b>	
L=40 D=Ø30 d=Ø20	<b>Description</b> Bushing		

Model:	ŞEM NO.	Description / Stabilizer Repair Kit
	9165	
	REF. NO:	
	0000714088S2	
<b>Item No</b>	<b>Ref. No</b>	
1	0000714089	
2	0000714088	
3	0000716242	
4	5003034260	
5	5003058071	



Model:	ŞEM NO.	Description / Stabilizer Repair Kit
	9166	
	REF. NO:	
	0000714088S3	
<b>Item No</b>	<b>Ref. No</b>	
1	5000297191	
2	0000714088	
3	0000716242	
4	5003034260	
5	5003058071	



Model:	ŞEM NO.	Description / Stabilizer Repair Kit
	9167	
	REF. NO:	
	0000714088S4 0000716243S	
<b>Item No</b>	<b>Ref. No</b>	
1	0000714089	
2	0000714088	
3	0000716243	
4	5003034260	
5	5003058071	



Model:	ŞEM NO.	Description / Stabilizer Repair Kit
	9168	
	REF. NO:	
	0000714088S5 0000716243S1	
<b>Item No</b>	<b>Ref. No</b>	
1	5000297191	
2	0000714088	
3	0000716243	
4	5003034260	
5	5003058071	







Description / Stabilizer Repair Kit	SEM NO.	Model:																
	<b>9169</b>																	
	REF. NO: 0000714088S6	<table border="1"> <thead> <tr> <th>Item No</th> <th>Ref. No</th> </tr> </thead> <tbody> <tr> <td>1</td> <td>0000714089</td> </tr> <tr> <td>2</td> <td>0000714088</td> </tr> <tr> <td>3</td> <td>0000714814</td> </tr> <tr> <td>4</td> <td>5003101619</td> </tr> <tr> <td>5</td> <td>5003058019</td> </tr> <tr> <td>6</td> <td>5003034260</td> </tr> <tr> <td>7</td> <td>5003053286</td> </tr> </tbody> </table>	Item No	Ref. No	1	0000714089	2	0000714088	3	0000714814	4	5003101619	5	5003058019	6	5003034260	7	5003053286
	Item No	Ref. No																
	1	0000714089																
	2	0000714088																
	3	0000714814																
	4	5003101619																
	5	5003058019																
	6	5003034260																
7	5003053286																	







Description / Stabilizer Repair Kit	SEM NO.	Model:										
	<b>9170</b>											
	REF. NO: 0000714088S7 0000716243S2	<table border="1"> <thead> <tr> <th>Item No</th> <th>Ref. No</th> </tr> </thead> <tbody> <tr> <td>1</td> <td>0000714089</td> </tr> <tr> <td>2</td> <td>0000714088</td> </tr> <tr> <td>3</td> <td>0000716243</td> </tr> <tr> <td>4</td> <td>5003034260</td> </tr> </tbody> </table>	Item No	Ref. No	1	0000714089	2	0000714088	3	0000716243	4	5003034260
	Item No	Ref. No										
	1	0000714089										
	2	0000714088										
	3	0000716243										
	4	5003034260										

Description / Stabilizer Repair Kit	SEM NO.	Model:										
	<b>9171</b>											
	REF. NO: 0000714088S8 0000716243S3	<table border="1"> <thead> <tr> <th>Item No</th> <th>Ref. No</th> </tr> </thead> <tbody> <tr> <td>1</td> <td>5000297191</td> </tr> <tr> <td>2</td> <td>0000714088</td> </tr> <tr> <td>3</td> <td>0000716243</td> </tr> <tr> <td>4</td> <td>5003034260</td> </tr> </tbody> </table>	Item No	Ref. No	1	5000297191	2	0000714088	3	0000716243	4	5003034260
	Item No	Ref. No										
	1	5000297191										
	2	0000714088										
	3	0000716243										
	4	5003034260										







Description / Stabilizer Repair Kit	SEM NO.	Model:								
	<b>9172</b>									
	REF. NO: 5010066937S 5010060356S 5010066936S	<table border="1"> <thead> <tr> <th>Item No</th> <th>Ref. No</th> </tr> </thead> <tbody> <tr> <td>1</td> <td>5010066937</td> </tr> <tr> <td>2</td> <td>5010060356</td> </tr> <tr> <td>3</td> <td>5010066936</td> </tr> </tbody> </table>	Item No	Ref. No	1	5010066937	2	5010060356	3	5010066936
	Item No	Ref. No								
	1	5010066937								
	2	5010060356								
	3	5010066936								

Model:	SEM NO.	Description / Stabilizer Repair Kit
	<b>9173</b>	
	<b>REF. NO:</b>	
	0000714088S	
		
<b>Item No</b>	<b>Ref. No</b>	
1	0000714089	
2	0000714088	
3	5003034260	

Model:	SEM NO.	Description / Stabilizer Repair Kit
	<b>9174</b>	
	<b>REF. NO:</b>	
	0000714088S1	
		
<b>Item No</b>	<b>Ref. No</b>	
1	5000297191	
2	0000714088	
3	5003034260	





	<table border="1"> <thead> <tr> <th>SEM NO.</th> <th>REF. NO.</th> <th>Type / Model</th> </tr> </thead> <tbody> <tr> <td>8527</td> <td>5000814841</td> <td></td> </tr> </tbody> </table>	SEM NO.	REF. NO.	Type / Model	8527	5000814841		<p>Type / Model</p>
SEM NO.	REF. NO.	Type / Model						
8527	5000814841							
<p>D=Ø67 d=Ø15 Ax=100</p>	<p><b>Description</b> Ball Joint (Kit)</p>							
	<table border="1"> <thead> <tr> <th>SEM NO.</th> <th>REF. NO.</th> <th>Type / Model</th> </tr> </thead> <tbody> <tr> <td>7635</td> <td>5001836091</td> <td></td> </tr> </tbody> </table>	SEM NO.	REF. NO.	Type / Model	7635	5001836091		<p>Type / Model</p>
SEM NO.	REF. NO.	Type / Model						
7635	5001836091							
<p>D=Ø75 d=Ø19 Ax=130</p>	<p><b>Description</b> Ball Joint (Kit)</p>							
	<table border="1"> <thead> <tr> <th>SEM NO.</th> <th>REF. NO.</th> <th>Type / Model</th> </tr> </thead> <tbody> <tr> <td>8139</td> <td>5000819365 5010104465 5000823228S</td> <td></td> </tr> </tbody> </table>	SEM NO.	REF. NO.	Type / Model	8139	5000819365 5010104465 5000823228S		<p>Type / Model</p>
SEM NO.	REF. NO.	Type / Model						
8139	5000819365 5010104465 5000823228S							
<p>D=Ø75 d=Ø17 Ax=122</p>	<p><b>Description</b> Ball Joint (Kit)</p>							
	<table border="1"> <thead> <tr> <th>SEM NO.</th> <th>REF. NO.</th> <th>Type / Model</th> </tr> </thead> <tbody> <tr> <td>8213 (10452)</td> <td>7485104224</td> <td></td> </tr> </tbody> </table>	SEM NO.	REF. NO.	Type / Model	8213 (10452)	7485104224		<p>Type / Model</p>
SEM NO.	REF. NO.	Type / Model						
8213 (10452)	7485104224							
<p>D=Ø75 d=Ø17 Ax=115</p>	<p><b>Description</b> Ball Joint (Kit)</p>							
	<table border="1"> <thead> <tr> <th>SEM NO.</th> <th>REF. NO.</th> <th>Type / Model</th> </tr> </thead> <tbody> <tr> <td>8465 (8613)</td> <td>7420547286</td> <td></td> </tr> </tbody> </table>	SEM NO.	REF. NO.	Type / Model	8465 (8613)	7420547286		<p>Type / Model</p>
SEM NO.	REF. NO.	Type / Model						
8465 (8613)	7420547286							
<p>D=Ø75 d=Ø19 Ax=115</p>	<p><b>Description</b> Ball Joint (Kit)</p>							
	<table border="1"> <thead> <tr> <th>SEM NO.</th> <th>REF. NO.</th> <th>Type / Model</th> </tr> </thead> <tbody> <tr> <td>7431</td> <td>0003404168S</td> <td>Alternative Rubber Type</td> </tr> </tbody> </table>	SEM NO.	REF. NO.	Type / Model	7431	0003404168S	Alternative Rubber Type	<p>Type / Model</p>
SEM NO.	REF. NO.	Type / Model						
7431	0003404168S	Alternative Rubber Type						
<p>D=Ø80 d=Ø21 Ax=152</p>	<p><b>Description</b> Ball Joint (Kit)</p>							



<b>Type / Model</b>	<b>REF. NO.</b>	<b>SEM NO.</b>	
	5001842823	7335 (7883)	
			<b>Description</b> Ball Joint (Kit)  D=Ø85 d=Ø19 Ax=130
<b>Type / Model</b>	<b>REF. NO.</b>	<b>SEM NO.</b>	
	5001842337	7866	
			<b>Description</b> Ball Joint (Kit)  D=Ø85 d=Ø21 Ax=152
<b>Type / Model</b>	<b>REF. NO.</b>	<b>SEM NO.</b>	
	5000802123 5001831526	8034	
			<b>Description</b> Ball Joint (Kit)  D=Ø85 d=Ø19 Ax=145
<b>Type / Model</b>	<b>REF. NO.</b>	<b>SEM NO.</b>	
	7420840815	8225 (9205)	
			<b>Description</b> Ball Joint (Kit)  D=Ø85 d=Ø21x26 Ax=130
<b>Type / Model</b>	<b>REF. NO.</b>	<b>SEM NO.</b>	
	7421295227S1	7981 (10458)	
			<b>Description</b> Ball Joint (Kit)  D=Ø85 d=Ø23 Ax=130
<b>Type / Model</b>	<b>REF. NO.</b>	<b>SEM NO.</b>	
	5001850588 5000333285	8216 (8401)	
			<b>Description</b> Ball Joint (Kit)  D=Ø85 d=Ø19 Ax=130

	SEM NO.	REF. NO.	Type / Model
 <p>D=Ø85 d=Ø21 Ax=130</p>	<b>8222</b> (9204)	5001847026	
	<b>Description</b>		
	Ball Joint (Kit)		
 <p>D=Ø85 d=Ø21 Ax=130</p>	<b>10430</b> (10431)	7420702096	
	<b>Description</b>		
	Ball Joint (Kit)		
 <p>D=Ø95 d=Ø21 Ax=130</p>	<b>8616</b> (10188)	7420702095	
	<b>Description</b>		
	Ball Joint (Kit)		
 <p>D=Ø100 d=Ø25 Ax=152</p>	<b>7682</b> (9201)	5010579389	
	<b>Description</b>		
	Ball Joint (Kit)		
 <p>D=Ø108 d=Ø23 Ax=165</p>	<b>10836</b>	7420976031S 7420864587	
	<b>Description</b>		
	Ball Joint (Kit)		
 <p>D=Ø95 L=166</p>	<b>9596</b>	5000819364	
	<b>Description</b>		
	Ball Joint (Kit)		















Model:	SEM NO.	Description / Ball Joint (Repair Kit)
	<b>7829</b> (7831)	
	REF. NO: 5001014520	
	Ø72	
Model:	SEM NO.	Description / Ball Joint (Repair Kit)
	<b>8466</b> (10187)	
	REF. NO: 7420741710	
	D=Ø72 h=45 M20x1,5	
Model:	SEM NO.	Description / Ball Joint (Repair Kit)
	<b>7783</b> (7784)	
	REF. NO: 7701011267	
	D=Ø 80	
Model:	SEM NO.	Description / Ball Joint (Plastic)
	<b>7793</b>	
	REF. NO: 0003404168	
	D=Ø 80	







Description / Ball Joint (Repair Kit)	SEM NO.	Model:
	<p><b>7806</b></p> <p>REF. NO: 5000819413</p> <p>D=Ø 80</p>	
	<p><b>8131</b></p> <p>REF. NO: 5001014345</p> <p>D=Ø80 d=Ø19 Ax=145</p>	
	<p><b>8523 (10082)</b></p> <p>REF. NO: 7420840820</p> <p>Ø90</p>	
	<p><b>8629</b></p> <p>REF. NO: 5001823280</p> <p>D=Ø90 d=21 Ax=152</p>	<p><b>Model:</b> KERAX</p>





Model:	SEM NO.	Description / Ball Joint (Repair Kit)
KERAX	<b>8630</b>	
	<b>REF. NO:</b> 5001823279	
	D=Ø90 d=Ø21 Ax=152	
Model:	SEM NO.	Description / Repair Kit
	<b>10436 (10437)</b>	
	<b>REF. NO:</b> 7421295227S	
	D=Ø90	
Model:	SEM NO.	Description / Repair Kit
	<b>11583</b>	
	<b>REF. NO:</b> 5000819414	
	D=Ø90	







	ŞEM NO.	REF. NO.	Type / Model
 L=560 d=Ø19/19 Ax=145/145	<b>8057</b>	0023123220	
	<b>Description</b>		
	Axle Rod		1- 8034 Page 901
	ŞEM NO.	REF. NO.	Type / Model
 L=535 d=Ø19/19 Ax=145/145	<b>8058</b>	0023123237 1151395	
	<b>Description</b>		
	Axle Rod		1- 8034 Page 901
	ŞEM NO.	REF. NO.	Type / Model
 L=565 d=Ø19/19 Ax=130/130	<b>8059 (8062)</b>	5000027957 5000810038	
	<b>Description</b>		
	Axle Rod		1- 7335 Page 901
	ŞEM NO.	REF. NO.	Type / Model
 L=555 d=Ø19/19 Ax=130/130	<b>8307</b>	5010347403	
	<b>Description</b>		
	Axle Rod		1- 7335 Page 901
	ŞEM NO.	REF. NO.	Type / Model
 L=570 d=Ø17/17 Ax=122/122	<b>8308</b>	5010197399	
	<b>Description</b>		
	Axle Rod		1- 8139 Page 900
	ŞEM NO.	REF. NO.	Type / Model
 L=692 d=Ø17/17 Ax=122/122	<b>8309</b>	5010207727	
	<b>Description</b>		
	Axle Rod		1- 8139 Page 900

Type / Model	REF. NO.	SEM NO.	
Premium KERAX	5010467915	8520	
			<b>Description</b> Axle Rod
1- 7866 Page 901			L=575 d=21/21 Ax=152/152
Type / Model	REF. NO.	SEM NO.	
FH 12 FM 9 FH 16 FM 380 FH 400 FM 400 FH 440 FM 440 FL 6 FM 480 FM 12	7421051052	8615 (8808)	
			<b>Description</b> Axle Rod
1- 8616 Page 902			L=510 d=Ø21/21 Ax=Ø130/130
Type / Model	REF. NO.	SEM NO.	
	5010389262	8955	
			<b>Description</b> Axle Rod
1- 7866 Page 901			L=574 d=Ø21/21 Ax=152/152
Type / Model	REF. NO.	SEM NO.	
	5010207726	9379	
			<b>Description</b> Axle Rod Alternative Rubber
1- 8139 Page 900			L=550 d=Ø17/17 Ax=122/122
Type / Model	REF. NO.	SEM NO.	
	5010347099	9380	
			<b>Description</b> Axle Rod Alternative Rubber
1- 7335 Page 901			L=575 d=Ø19/19 Ax=130/130
Type / Model	REF. NO.	SEM NO.	
	1151396 0023123238 23123238	9381	
			<b>Description</b> Axle Rod Alternative Rubber
1- 8034 Page 901			L=535 d=Ø19/19 Ax=145/145

	ŞEM NO.	REF. NO.	Type / Model
 L=575 d=Ø19/19 Ax=145/145	<b>9382</b>	5001850530 5010094941 5010094838 5010530366	1- 8034 Page 901
	<b>Description</b> Axle Rod	0023123253 5000750976 5000783574 5010064641	
 L=575 d=Ø19/19 Ax=145/145	<b>10170</b>	5010268035	1- 8034 Page 901
	<b>Description</b> Axle Rod		
 Ax=510	<b>10449 (10450)</b>	7420443044	1- 8213 Page 900
	<b>Description</b> Axle Rod		
 L=515 d=Ø21/21 Ax=130/130	<b>11660</b>	7421051046	1- 10430 Page 902
	<b>Description</b> Axle Rod		
 L=490 d=Ø19/19 Ax=130/130	<b>12920</b>	 5010207771	1- 7635 Page 900
	<b>Description</b> Axle Rod		

Type / Model	REF. NO.	SEM NO.	
1- 8466 Page 903 2- 8465 Page 900	74207741703	<b>8464</b> (10185)	 <p><b>Description</b> Axle Rod (V)</p> <p>L=663 Ax=115/115 d=Ø19/19</p>
PREMIUM LANDER KERAX	7420829503	<b>8521</b>	 <p><b>Description</b> Axle Rod (V)</p> <p>L=671 Ax=130/130 d=Ø26x21/26x21</p>
1- 10436 Page 905 2- 7981 Page 901	7421295227	<b>10459</b> (10460)	 <p><b>Description</b> Axle Rod (V)</p> <p>L=671 d=Ø23/23 Ax=130/130</p>
1- 10927 Page 617 2- 10836 Page 902	7420976031	<b>10825</b> (10826)	 <p><b>Description</b> Axle Rod (V)</p> <p>L=646,5 d=Ø23/23 Ax=165/165</p>

	<b>SEM NO.</b>	<b>REF. NO.</b>	<b>Type / Model</b>
	<b>9600</b>	5010052920 5010383049 5010130401 5010383050 5010294412 5010383613 5010294413	5010383692 5010383693 5010383694 SACHS 131028 SACHS 310962 MONROE T5179 MONROE T1223
	<b>Description</b>		OPEN LENGTH=597 CLOSED LENGTH=360 UPPER MOUNT DIMENSION=M14x78 LOWER MOUNT DIMENSION=14x78
	Shock Absorber		
	<b>SEM NO.</b>	<b>REF. NO.</b>	<b>Type / Model</b>
	<b>9606</b>	5000288425 5000786728 5000768840 5000790689	OPEN LENGTH=472 CLOSED LENGTH=332 UPPER MOUNT DIMENSION=24x62 LOWER MOUNT DIMENSION=24x62
	<b>Description</b>		
	Shock Absorber		
	<b>SEM NO.</b>	<b>REF. NO.</b>	<b>Type / Model</b>
	<b>9610</b>	5010294158 5010630386 5010383689 5010557482	OPEN LENGTH=857 CLOSED LENGTH=515 UPPER MOUNT DIMENSION=20x55 LOWER MOUNT DIMENSION=20x62
	<b>Description</b>	SACHS 131184 MONROE T5154	
	Shock Absorber		
	<b>SEM NO.</b>	<b>REF. NO.</b>	<b>Type / Model</b>
	<b>11295</b>	5010277261 5000336661 5000471623 5000356647	OPEN LENGTH=246 CLOSED LENGTH=186 UPPER MOUNT DIMENSION=12x32 LOWER MOUNT DIMENSION=12x32
	<b>Description</b>	SACHS 312273	
	Shock Absorber		
	<b>SEM NO.</b>	<b>REF. NO.</b>	<b>Type / Model</b>
	<b>11296</b>	5010460113 5010269605C 5010269605 7420840318 5010615880	OPEN LENGTH=262 CLOSED LENGTH=206 UPPER MOUNT DIMENSION=14x45 LOWER MOUNT DIMENSION=14x45
	<b>Description</b>		
	Shock Absorber		
	<b>SEM NO.</b>	<b>REF. NO.</b>	<b>Type / Model</b>
	<b>11297</b>	5000787974 5010130609 5010065309 5010065311	OPEN LENGTH=298 CLOSED LENGTH=232 UPPER MOUNT DIMENSION=12x47 LOWER MOUNT DIMENSION=12x47
	<b>Description</b>	SACHS 310956 MONROE CB0069	
	Shock Absorber		

Type / Model	REF. NO.	SEM NO.
OPEN LENGTH=290	5000741014	<b>11479</b>
CLOSED LENGTH=203	5010130535	
UPPER MOUNT	5010052405	
DIMENSION=M10x67,38	5010460114	
LOWER MOUNT	SACHS 124737	
DIMENSION=M10x67,38	MONROE Cb0051	
		<b>Description</b>
		Shock Absorber



Type / Model	REF. NO.	SEM NO.
OPEN LENGTH=830	23512048	<b>11498</b>
CLOSED LENGTH=480	5010130500	
UPPER MOUNT	23512085	
DIMENSION=M14x80	5010130888	
LOWER MOUNT	5000790666	
DIMENSION=M14x80	5010138561	
	5000867685	
	5010095719	
	SACHS 110657	
		<b>Description</b>
		Shock Absorber





Type / Model	REF. NO.	SEM NO.
	5001835165	<b>9030</b>
		<b>Description</b>
		Rubber Mounting









D=Ø50,5 d=Ø19 h=26





	<b>ŞEM NO.</b>  <b>72.4154.CP05</b>	<b>REF. NO.</b>  5010239252 5010488071 CONTITECH 4154 N P05 FIRESTONE W01-358-8172 PHOENIX 1 DK 23 F-1 FIRESTONE W01-M58-8172 GOODYEAR 1R12-069 FIRESTONE 1T15M-3 VIBRACOUSTIC V1DK23F-1	<b>Technical Specification</b>  Total Weight 5,1 kg
	<b>ŞEM NO.</b>  <b>72.4911.C03</b>	<b>REF. NO.</b>  5010294308 C CONTITECH 4911 N P03 GOODYEAR 1R13-739 GOODYEAR ex 1R13-714 GY SPRINGRIDE D13B41 GART NO. 287.1.540 GART REF. D287/E	<b>Technical Specification</b>  Total Weight 13,3 kg
	<b>ŞEM NO.</b>  <b>72.4912.C07</b>	<b>REF. NO.</b>  5010294307 CONTITECH 4912 C07 PHOENIX 1 DK 28 F 4 FIRESTONE 1T19L 14 FIRESTONE W01 M58 8786 GOODYEAR 1R13 738 CF GOMMA REF. 1T19E 4 CF GOMMA NO. 206779 GART NO. 287.1.600 GART REF. D287/C	<b>Technical Specification</b>  Total Weight 13,2 kg
	<b>ŞEM NO.</b>  <b>72.4912.C10</b>	<b>REF. NO.</b>  5010557355 CONTITECH 4912 N P10 GOODYEAR 1R13-753 PHOENIX 1 DK 28 F-5	<b>Technical Specification</b>  Total Weight 13,7 kg
	<b>ŞEM NO.</b>  <b>72.4912.S08</b>	<b>REF. NO.</b>  5001832067 CONTITECH 4912 N P08 GOODYEAR 1R13-713 CF GOMMA REF. 1T19E-4 CF GOMMA NO. 206780 GART NO. 287.0.601 GART REF. D287/C	<b>Technical Specification</b>  Total Weight 6,5 kg
	<b>ŞEM NO.</b>  <b>72.4912.S10</b>	<b>REF. NO.</b>  5010557355 CONTITECH 4912 N P10 GOODYEAR 1R13-753 PHOENIX 1 DK 28 F-5	<b>Technical Specification</b>  Total Weight 12,6 kg







<b>Technical Specification</b>	<b>REF. NO.</b>	<b>SEM NO.</b>	
Total Weight 10,6 kg	5010294309 CONTITECH 4915 N P06 PHOENIX 1 DK 19-1 VIBRACOUSTIC V1DK19-1	<b>72.4915.C06</b>	
		<b>Description</b>	Metal Piston
<b>Technical Specification</b>	<b>REF. NO.</b>	<b>SEM NO.</b>	
Total Weight 5,5 kg	5001855856 CONTITECH 4915 N P03	<b>72.4915.S03</b>	
		<b>Description</b>	Service Assembly
<b>Technical Specification</b>	<b>REF. NO.</b>	<b>SEM NO.</b>	
Total Weight 8 kg	7420767358 CONTITECH 4929 N P01 RT	<b>72.4929.C</b>	
		<b>Description</b>	Metal Piston
<b>Technical Specification</b>	<b>REF. NO.</b>	<b>SEM NO.</b>	
Total Weight 2 kg	5000819517 CONTITECH 715 N PHOENIX 1 F 25 VIBRACOUSTIC V1F25 FIRESTONE 1R1C335 310 FIRESTONE W01 095 0087 GOODYEAR 8015 CF GOMMA REF. 1SC310 16 CF GOMMA NO. 93518 DUNLOP UK PNP304890101	<b>72.715.R</b>	
		<b>Description</b>	Roll
<b>Technical Specification</b>	<b>REF. NO.</b>	<b>SEM NO.</b>	
Total Weight 2 kg	5000954175 CONTITECH 768 N PHOENIX 1 E 27 FIRESTONE 1R2A380-330 FIRESTONE W01-095-0213 GOODYEAR 9078 GY SPRINGRIDE D13S08	<b>72.768.R</b>	
		<b>Description</b>	Roll
<b>Technical Specification</b>	<b>REF. NO.</b>	<b>SEM NO.</b>	
Total Weight 10,5 kg	5000452939 CONTITECH 810 MB PHOENIX 1 D 28 A 2 Taurus KR621 26 VIBRACOUSTIC V1D28A 2 FIRESTONE 1T19L 7 FIRESTONE W01 M58 6345 FIRESTONE W01 M58 8775 GY SPRINGRIDE D13B20 GY SPRINGRIDE D13B01	<b>72.810.C</b>	
		<b>Description</b>	Metal Piston













	<b>SEM NO.</b>	<b>REF. NO.</b>	<b>Technical Specification</b>
	72.811.C	5000745918 CONTITECH 811 MB GOODYEAR 1R14-718 GY SPRINGRIDE D13B34 CF GOMMA REF. 1T19E-2 CF GOMMA NO. 203878 DUNLOP UK PNP311670000 GART NO. 277.4.506 GART REF. D277/B	Total Weight 13,3 kg
	<b>SEM NO.</b>	<b>REF. NO.</b>	<b>Technical Specification</b>
	72.813.C	5000790692 5010130925 CONTITECH 813 MB PHOENIX 1 D 28 B 2Taurus KR622 26 VIBRACOUSTIC V1D28B 2 FIRESTONE 1T19L 11 FIRESTONE W01 M58 6364 FIRESTONE W01 M58 6339 GART REF. D277/B GOODYEAR 1R14 705	Total Weight 11,6 kg
	<b>SEM NO.</b>	<b>REF. NO.</b>	<b>Technical Specification</b>
	72.901.C	5010052722 5010130683 CONTITECH 901 MB	Total Weight 15 kg
	<b>SEM NO.</b>	<b>REF. NO.</b>	<b>Technical Specification</b>
	72.902.C	5010211724 CONTITECH 902 MB FIRESTONE W01-M58-9910 FIRESTONE 1T19G-12	Total Weight 14,5 kg

<b>Type / Model</b>	<b>REF. NO.</b>	<b>SEM NO.</b>	
	5010316404	9406	
<b>Description</b>			
Hand Pump			
<b>Type / Model</b>	<b>REF. NO.</b>	<b>SEM NO.</b>	
	5010615920	11651	
<b>Description</b>			
Cabin Pump			
<b>Type / Model</b>	<b>REF. NO.</b>	<b>SEM NO.</b>	
	5010224942	11652	
<b>Description</b>			
Cabin Pump			
<b>Type / Model</b>	<b>REF. NO.</b>	<b>SEM NO.</b>	
	5010316438	11653	
<b>Description</b>			
Cabin Pump			
<b>Type / Model</b>	<b>REF. NO.</b>	<b>SEM NO.</b>	
	5010629361	11654	
<b>Description</b>			
Cabin Pump			
<b>Type / Model</b>	<b>REF. NO.</b>	<b>SEM NO.</b>	
	7482053294 5010629348	11655	
<b>Description</b>			
Cabin Pump			

	ŞEM NO.	REF. NO.	Type / Model
 <p><b>Description</b> Cylinder</p>	9423	5010316793	
 <p><b>Description</b> Cabin Cylinder</p>	11639	5010629108	
 <p><b>Description</b> Cabin Cylinder</p>	11640	5010629264	
 <p><b>Description</b> Cabin Cylinder</p>	11641	5010316495	
 <p><b>Description</b> Cabin Cylinder</p>	11642	7482050280	

<b>Type / Model</b>	<b>REF. NO.</b>	<b>SEM NO.</b>	
	5010228947	8002 (9258)	
		<b>Description</b>	
		Cabin Bushing	
			D=Ø68 d=Ø30 h=49
<b>Type / Model</b>	<b>REF. NO.</b>	<b>SEM NO.</b>	
	5010239669	8003 (9259)	
		<b>Description</b>	
		Cabin Bushing	
			D=Ø83 d=Ø52 h=20
<b>Type / Model</b>	<b>REF. NO.</b>	<b>SEM NO.</b>	
	5010269380 7420850895	8294	
		<b>Description</b>	
		Cabin Bushing	
			D=Ø40 d=Ø12 h=42
<b>Type / Model</b>	<b>REF. NO.</b>	<b>SEM NO.</b>	
	5000789265	8295	
		<b>Description</b>	
		Cabin Bushing	
			D=Ø40 d=Ø12 h=42
<b>Type / Model</b>	<b>REF. NO.</b>	<b>SEM NO.</b>	
KERAX MIDLUM PREMIUM	5010316015	10061	
		<b>Description</b>	
		Cabin Bushing	
			d=16 D=60 h=68
<b>Type / Model</b>	<b>REF. NO.</b>	<b>SEM NO.</b>	
	5010552346	10969	
		<b>Description</b>	
		Cabin Bushing	
			D=Ø65 d=Ø20 h=55

	<table border="1"> <thead> <tr> <th>SEM NO.</th> <th>REF. NO.</th> <th>Type / Model</th> </tr> </thead> <tbody> <tr> <td>11001</td> <td>5010418820</td> <td></td> </tr> </tbody> </table>	SEM NO.	REF. NO.	Type / Model	11001	5010418820		<p><b>Description</b> Cabin Bushing</p>
SEM NO.	REF. NO.	Type / Model						
11001	5010418820							
<p>D=Ø38 d=Ø16 L=90</p>								
	<table border="1"> <thead> <tr> <th>SEM NO.</th> <th>REF. NO.</th> <th>Type / Model</th> </tr> </thead> <tbody> <tr> <td>11002</td> <td>5010273535</td> <td></td> </tr> </tbody> </table>	SEM NO.	REF. NO.	Type / Model	11002	5010273535		<p><b>Description</b> Cabin Bushing</p>
SEM NO.	REF. NO.	Type / Model						
11002	5010273535							
<p>D=Ø50 d=Ø16 L=80</p>								
	<table border="1"> <thead> <tr> <th>SEM NO.</th> <th>REF. NO.</th> <th>Type / Model</th> </tr> </thead> <tbody> <tr> <td>11004</td> <td>5001844625</td> <td></td> </tr> </tbody> </table>	SEM NO.	REF. NO.	Type / Model	11004	5001844625		<p><b>Description</b> Cabin Bushing</p>
SEM NO.	REF. NO.	Type / Model						
11004	5001844625							
<p>D=Ø42 d=Ø14 L=60</p>								
	<table border="1"> <thead> <tr> <th>SEM NO.</th> <th>REF. NO.</th> <th>Type / Model</th> </tr> </thead> <tbody> <tr> <td>11784</td> <td>5010418819</td> <td></td> </tr> </tbody> </table>	SEM NO.	REF. NO.	Type / Model	11784	5010418819		<p><b>Description</b> Cabin Bushing</p>
SEM NO.	REF. NO.	Type / Model						
11784	5010418819							
<p>D=Ø27 d=Ø14 L=45</p>								
	<table border="1"> <thead> <tr> <th>SEM NO.</th> <th>REF. NO.</th> <th>Type / Model</th> </tr> </thead> <tbody> <tr> <td>8536</td> <td>5000739051</td> <td></td> </tr> </tbody> </table>	SEM NO.	REF. NO.	Type / Model	8536	5000739051		<p><b>Description</b> Cabin Mounting</p>
SEM NO.	REF. NO.	Type / Model						
8536	5000739051							
<p>D=Ø100 h=75 M16x1.5</p>								
	<table border="1"> <thead> <tr> <th>SEM NO.</th> <th>REF. NO.</th> <th>Type / Model</th> </tr> </thead> <tbody> <tr> <td>8293</td> <td>5010316016</td> <td></td> </tr> </tbody> </table>	SEM NO.	REF. NO.	Type / Model	8293	5010316016		<p><b>Description</b> Rubber Metal Pad</p>
SEM NO.	REF. NO.	Type / Model						
8293	5010316016							
<p>D=Ø70 d=Ø25 h=10</p>								

<b>Type / Model</b>	<b>REF. NO.</b>	<b>SEM NO.</b>	
	5010383949	8789	
		<b>Description</b>	
		Pur Mounting	
			D=Ø80 h=52
<b>Type / Model</b>	<b>REF. NO.</b>	<b>SEM NO.</b>	
	5000788113	9251	
		<b>Description</b>	
		Pur Mounting	
			D=Ø50 h=66
<b>Type / Model</b>	<b>REF. NO.</b>	<b>SEM NO.</b>	
	5010316874	8790	
		<b>Description</b>	
		Pur Mounting	
<b>Type / Model</b>	<b>REF. NO.</b>	<b>SEM NO.</b>	
	5010629784	10541	
		<b>Description</b>	
		Cabin Mounting	
			D=Ø94 h=150
<b>Type / Model</b>	<b>REF. NO.</b>	<b>SEM NO.</b>	
	7703066035	10252	
		<b>Description</b>	
		Ring	

Description / Stabilizer Repair Kit	SEM NO.	Model:																
	<b>9177</b>																	
	REF. NO: 5000789265S	<table border="1"> <thead> <tr> <th>Item No</th> <th>Ref. No</th> </tr> </thead> <tbody> <tr><td>1</td><td>5000789265</td></tr> <tr><td>2</td><td>5003101873</td></tr> <tr><td>3</td><td>5010269540</td></tr> <tr><td>4</td><td>5003032157</td></tr> <tr><td>5</td><td>5003058071</td></tr> <tr><td>6</td><td>7420850895</td></tr> <tr><td>7</td><td>5010269380</td></tr> </tbody> </table>	Item No	Ref. No	1	5000789265	2	5003101873	3	5010269540	4	5003032157	5	5003058071	6	7420850895	7	5010269380
	Item No	Ref. No																
	1	5000789265																
	2	5003101873																
	3	5010269540																
	4	5003032157																
	5	5003058071																
	6	7420850895																
7	5010269380																	

Description / Cabin Repair Kit	SEM NO.	Model:																
	<b>9180</b>																	
	REF. NO: 5010228947S	<table border="1"> <thead> <tr> <th>Item No</th> <th>Ref. No</th> </tr> </thead> <tbody> <tr><td>1</td><td>5010228947</td></tr> <tr><td>2</td><td>----</td></tr> <tr><td>3</td><td>----</td></tr> <tr><td>4</td><td>8143461</td></tr> <tr><td>5</td><td>----</td></tr> <tr><td>6</td><td>----</td></tr> <tr><td>7</td><td>----</td></tr> </tbody> </table>	Item No	Ref. No	1	5010228947	2	----	3	----	4	8143461	5	----	6	----	7	----
	Item No	Ref. No																
	1	5010228947																
	2	----																
	3	----																
	4	8143461																
	5	----																
	6	----																
7	----																	

Description / Cabin Mounting	SEM NO.	Model:
	<b>11978</b>	
	REF. NO: 5010552266	
	5010228902	

Description / Repair Kit for Cabin	SEM NO.	Model:								
	<b>11979</b>									
	REF. NO: 5010552266S	<table border="1"> <thead> <tr> <th>Item No</th> <th>Ref. No</th> </tr> </thead> <tbody> <tr><td>1</td><td>5010571249</td></tr> <tr><td>2</td><td>5010571248</td></tr> <tr><td>3</td><td>5010571246</td></tr> </tbody> </table>	Item No	Ref. No	1	5010571249	2	5010571248	3	5010571246
	Item No	Ref. No								
	1	5010571249								
	2	5010571248								
3	5010571246									



<b>Model:</b>	<b>SEM NO.</b>	<b>Description / Repair Kit for Cabin</b>
	11980	
<b>Item No</b>	<b>Ref. No</b>	<b>REF. NO:</b>
1	5010571249	5010552266S1
2	5010571248	
3	5010571246	



<b>Model:</b>	<b>SEM NO.</b>	<b>Description / Repair Kit for Cabin</b>
	11981	
<b>Item No</b>	<b>Ref. No</b>	<b>REF. NO:</b>
1	5010571249	5010552266S2
2	5010571248	
3	5010571246	
4	5003101627	
5	5003058034	





<b>Model:</b>	<b>SEM NO.</b>	<b>Description / Repair Kit for Cabin</b>
	11982	
<b>Item No</b>	<b>Ref. No</b>	<b>REF. NO:</b>
1	5010571249	5010552266S3
2	5010571248	
3	5010571246	
4	5003101627	
5	5003058034	







<b>Model:</b>	<b>SEM NO.</b>	<b>Description / Cabin Bushing Rod</b>
	12162	
		<b>REF. NO:</b>
		5010316479





Description / Cabin Bushing	SEM NO.		Model:
	12163		
	REF. NO:	5010460097	
	d=16,5 D=92 h=80		

Type / Model	REF. NO.	SEM NO.	
PREMIUM	5010130797G MONROE CB0075 CONTITECH SZ50-9	8163	<p><b>Description</b> Cabin Suspansion Spring</p> 
G 340 TI	5010092916E MONROE CB0082 CONTITECH SZ50-8	8164	<p><b>Description</b> Cabin Suspansion Spring</p> 
G 340 TI	5010266845A 5010313619A MONROE CB0083 CONTITECH SZ50-10	8165	<p><b>Description</b> Cabin Suspansion Spring</p> 
GAMME G	5010133079D CONTITECH SZ50-6	8168	<p><b>Description</b> Cabin Suspansion Spring</p> 
PREMIUM	5010228908 5010316783 5010269674 CONTITECH SZ36-10 MONROE CB 0088 SACHS 131041 SACHS 310957	8479	<p><b>Description</b> Cabin Suspansion Spring With Shock Absorber</p> 
MAGNUM	5010320096A MONROE CB0076 CONTITECH 816-Z	8490	<p><b>Description</b> Cabin Suspansion Spring</p> 

	<b>SEM NO.</b>  <b>10813</b>	<b>REF. NO.</b>  5010228849 MONROE CB0070	<b>Type / Model</b>  MAGNUM E-TECH
<b>Description</b> Cabin Suspansion Spring With Shock Absorber			
	<b>SEM NO.</b>  <b>10814</b>	<b>REF. NO.</b>  7420898055 5010629471 7482052893	<b>Type / Model</b>  MAGNUM
<b>Description</b> Cabin Suspansion Spring With Shock Absorber			
	<b>SEM NO.</b>  <b>10815</b>	<b>REF. NO.</b>  5010629414 MONROE CB0075 CONTITECH SZ509P02	<b>Type / Model</b>  PREMIUM
<b>Description</b> Cabin Suspansion Spring			
	<b>SEM NO.</b>  <b>10816</b>	<b>REF. NO.</b>  5010615879 SACHS 78100001622 SACHS 25376537	<b>Type / Model</b>  PREMIUM
<b>Description</b> Cabin Suspansion Spring With Shock Absorber			

Type / Model	REF. NO.	SEM NO.	
	7420498623	10896	
		<b>Description</b>	
		Rubber Strip	

L=175

SEM NO.	REF. NO.	Type / Model
8397 (9229)	5010353702	PREMIUM
 <p><b>Description</b> Pressure Spring</p>		
660 MM 350 N		







SEM NO.	REF. NO.	Type / Model
8398	5010468464	MIDLUM
 <p><b>Description</b> Pressure Spring</p>		

SEM NO.	REF. NO.	Type / Model
9228	5010093384	
 <p><b>Description</b> Pressure Spring</p>		
690-460N		

SEM NO.	REF. NO.	Type / Model
9723	5010353703	
 <p><b>Description</b> Pressure Spring</p>		
638-270-200N.		

SEM NO.	REF. NO.	Type / Model
9724	5010225922	
 <p><b>Description</b> Pressure Spring</p>		
635-275-350N.		

SEM NO.	REF. NO.	Type / Model
9725	5010468003	
 <p><b>Description</b> Pressure Spring</p>		
615-258-230N.		

Type / Model	REF. NO.	SEM NO.
	5010578586	9726
		
		<b>Description</b> Pressure Spring 630-250-400N.
Type / Model	REF. NO.	SEM NO.
	5010623108	9727
		
		<b>Description</b> Pressure Spring 592-232-235N.
Type / Model	REF. NO.	SEM NO.
	5010623483	9728
		
		<b>Description</b> Pressure Spring 512-167-260N.
Type / Model	REF. NO.	SEM NO.
MIDLUM	5001855293	10652 (11015)
		
		<b>Description</b> Pressure Spring 157-40-150N.
Type / Model	REF. NO.	SEM NO.
MIDLUM	5010150154	10653 (11016)
		
		<b>Description</b> Pressure Spring 195- 65- 150N.
Type / Model	REF. NO.	SEM NO.
PREMIUM KERAX	5010290528	10654
		
		<b>Description</b> Pressure Spring 236-84-250N.







SEM NO.	REF. NO.	Type / Model
<b>10655</b> (11017)	5010445375 5010227221	MAGNUM
		
<b>Description</b> Pressure Spring 404-165-150N.		













SEM NO.	REF. NO.	Type / Model
<b>10656</b>	5010353858	MIDLUM
		
<b>Description</b> Pressure Spring 708-318-170N.		

Type / Model	REF. NO.	SEM NO.	
	5001858133	10035	
			<b>Description</b> Pull Righth

Type / Model	REF. NO.	SEM NO.	
	5001836273	10036	
			<b>Description</b> Pull Righth



	<p><b>SEM NO.</b> <b>10037</b></p> <p><b>Description</b> Release Lever</p>	<p><b>REF. NO.</b> 5010452528</p>	<p><b>Type / Model</b> ZF Type 370 380 400 420</p>
	<p><b>SEM NO.</b> <b>10038</b></p> <p><b>Description</b> Release Lever Repair Kit</p>	<p><b>REF. NO.</b> 5010452528S</p>	<p><b>Type / Model</b> ZF Type 370 380 400 420</p>
	<p><b>SEM NO.</b> <b>12161</b></p> <p><b>Description</b> Lever Splindle</p>	<p><b>REF. NO.</b> 5010244008</p> <p><i>new product</i></p>	<p><b>Type / Model</b></p>
	<p><b>SEM NO.</b> <b>10784</b></p> <p><b>Description</b> Release Lever Repair Kit-With Bearing</p>	<p><b>REF. NO.</b> 5010244008S 5010244327S</p>	<p><b>Type / Model</b> KERAX 400</p>
	<p><b>SEM NO.</b> <b>10979</b></p> <p><b>Description</b> Clutch Lever Repair Kit</p>	<p><b>REF. NO.</b> 5001863718</p>	<p><b>Type / Model</b></p>
	<p><b>SEM NO.</b> <b>11359</b></p> <p><b>Description</b> Lever Splindle / ZF Type</p>	<p><b>REF. NO.</b> 5010452542</p>	<p><b>Type / Model</b> ZF</p>

<b>Type / Model</b>	<b>REF. NO.</b>		<b>SEM NO.</b>	
	5010244075		12154	
<b>Description</b> Release Lever				
<b>Type / Model</b>	<b>REF. NO.</b>		<b>SEM NO.</b>	
	5010244075 S		12155	
<b>Description</b> Release Lever Repair Kit				
<b>Type / Model</b>	<b>REF. NO.</b>		<b>SEM NO.</b>	
	5000787873		12156	
<b>Description</b> Release Lever Bushing				
<b>Type / Model</b>	<b>REF. NO.</b>		<b>SEM NO.</b>	
	5000677320		12157	
<b>Description</b> Release Lever Joint				
<b>Type / Model</b>	<b>REF. NO.</b>		<b>SEM NO.</b>	
	5005044001		12158	
<b>Description</b> Dust Cover				
<b>Type / Model</b>	<b>REF. NO.</b>		<b>SEM NO.</b>	
	5010452530		12159	
<b>Description</b> Roller / Long				



**SEM NO.**  
12160















**REF. NO.**  
5010244334

**Type / Model**

**Description**

Roller / Short

<b>Type / Model</b>	<b>REF. NO.</b>		<b>SEM NO.</b>	
	5010260028		12829	
				<b>Description</b> Brake Slack Adjuster, Automatic-Left
				Ø 14x160x350°
<b>Type / Model</b>	<b>REF. NO.</b>		<b>SEM NO.</b>	
	5010098831		12830	
				<b>Description</b> Brake Slack Adjuster, Automatic-Right
				Ø 14x160x10°
<b>Type / Model</b>	<b>REF. NO.</b>		<b>SEM NO.</b>	
	5010098832		12853	
				<b>Description</b> Brake Slack Adjuster, Automatic-Left
				Ø 14x160x10°
<b>Type / Model</b>	<b>REF. NO.</b>		<b>SEM NO.</b>	
	5000791212		12858	
				<b>Description</b> Brake Slack Adjuster, Automatic-Right
				Ø 14x175x10°
<b>Type / Model</b>	<b>REF. NO.</b>		<b>SEM NO.</b>	
	5000791213		12861	
				<b>Description</b> Brake Slack Adjuster, Automatic-Left
				Ø 14x175x10°
<b>Type / Model</b>	<b>REF. NO.</b>		<b>SEM NO.</b>	
	5010260027		12870	
				<b>Description</b> Brake Slack Adjuster, Automatic-Right
				Ø 14x160x350°

	<b>SEM NO.</b>	<b>REF. NO.</b>	<b>Type / Model</b>
	11841	5001866989	MRT TYPE PREMIUM LRG 728, 729, 730, 731, 732, 733, PREMIUM 440
	<b>Description</b>		
	Caliper Repair Kit		
	<b>SEM NO.</b>	<b>REF. NO.</b>	<b>Type / Model</b>
	12454	5001856032	PREMIUM 420
	<b>Description</b>		
	Pad Wear Indicator (Front Right)		
	<b>SEM NO.</b>	<b>REF. NO.</b>	<b>Type / Model</b>
	12455	5001856034	PREMIUM 420
	<b>Description</b>		
	Pad Wear Indicator (Back Right)		
	<b>SEM NO.</b>	<b>REF. NO.</b>	<b>Type / Model</b>
	12456	5001856031	PREMIUM 420
	<b>Description</b>		
	Pad Wear Indicator (Front Left)		
	<b>SEM NO.</b>	<b>REF. NO.</b>	<b>Type / Model</b>
	12457	5001856033	PREMIUM 420
	<b>Description</b>		
	Pad Wear Indicator (Back Left)		
	<b>SEM NO.</b>	<b>REF. NO.</b>	<b>Type / Model</b>
	12458	7420928560	MRT TYPE VOLVO FH, PREMIUM 440:
	<b>Description</b>		
	Pad Wear Indicator (Front Left)		
	<b>SEM NO.</b>	<b>REF. NO.</b>	<b>Type / Model</b>
	12360	5001822994	MRT TYPE LRG 524, 525, 526, 527, 528, 529, 532, 533, 562, 563
	<b>Description</b>		
	Caliper Repair Kit		

Type / Model	REF. NO.	SEM NO.	
VOLVO FH, PREMIUM 440, 430:	7420928559	12460	
		<b>Description</b>	
		PAD WEAR INDICATOR (FRONT LEFT)	
VOLVO FH, PREMIUM 440:	7420928552	12461	
		<b>Description</b>	
		PAD WEAR INDICATOR (BACK LEFT)	
VOLVO FH, PREMIUM 440:	7420928553	12459	
		<b>Description</b>	
		PAD WEAR INDICATOR (BACK RIGHT)	
MRT TYPE LRG 726, 727, 728, 729, 730, 731, 732, 733	5001866400	12481	
		<b>Description</b>	
		Caliper Repair Kit	
MRT TYPE D LISA, LRG 548, 549, 550, 55, 564, 565, 592, 593, 630, 631	5001837006	12507	
		<b>Description</b>	
		Caliper Repair Kit	
MRT TYPE LRG 544, 545, 572, 573, 580 581, 582, 583, 638, 639, 646 647, 658, 659, 662, 663, 700 701, 712, 713, 722, 723, 744 745, 748, 749, 750, 751	5001860791	10761	
		<b>Description</b>	
		Caliper Repair Kit	
MRT TYP	5001823001	12396	
		<b>Description</b>	
		Caliper Repair Kit	
MRT TYPE	5001866398	12443	
		<b>Description</b>	
		Caliper Repair Kit	



## 6 - 4.2

ŞEM NO.	REF. NO.	Type / Model
12431	5001858717	MRT TYPE
 <p><b>Description</b> Caliper Repair Kit</p>		

## 6 - 4.3

ŞEM NO.	REF. NO.	Type / Model
10767	5001866626	WBC TYPE 40 195 017, 40 195 020, 40 195 027, 40 195 030, 40 195 035, 40 195 038, 40 195 043, 40 195 044, 40 225 007, 40 225 008, 40 225 015, 40 225 016
 <p><b>Description</b> Caliper Repair Kit</p>		





ŞEM NO.	REF. NO.	Type / Model
12564	5001858722	WBC TYPE 40 195 001, 40 195 002, 40 195 003, 40 195 004, 40 195 021, 40 195 022
 <p><b>Description</b> Caliper Repair Kit</p>		

ŞEM NO.	REF. NO.	Type / Model
12577	5021170488	WBC TYPE 40 225 003, 40 225 004
 <p><b>Description</b> Caliper Repair Kit</p>		

## 6.4.6

ŞEM NO.	REF. NO.	Type / Model
12730	5001014701 5001829895	HYDRAULIC TYPE LRG 500, 501, 502, 503, 504, 505, 508, 509, 518, 519, 534, 535
 <p><b>Description</b> Caliper Repair Kit</p>		

ŞEM NO.	REF. NO.	Type / Model
12732	5001014679 5001829892	HYDRAULIC TYPE LRG 510, 511, 516, 517, 520 521, 566, 567
 <p><b>Description</b> Caliper Repair Kit</p>		

Type / Model	REF. NO.		SEM NO.	
	5000816347		12047	
				<b>Description</b> Bushing
Type / Model	REF. NO.		SEM NO.	
	5000816349		12055	
				<b>Description</b> Bushing





## FORD GROUP







Engine and Transmission Group .....	:	940
Steering Group .....	:	-
Suspension Group .....	:	941 - 945
Cab Group .....	:	-
Axle / Differential ve Shaft Group.....	:	-
Clutch and Brake Group.....	:	-

	SEM NO.	REF. NO.	Type / Model
	11243	4C466K770AA	BLACK RED
	<b>Description</b> Silicon Hose		
Ø90X175 3 hump			



	SEM NO.	REF. NO.	Type / Model
	11244	90CT6K770BA	RED
	<b>Description</b> Silicon Hose		
Ø76X165 2 hump			

	SEM NO.	REF. NO.	Type / Model
	11245	90CT6K683AA	RED
	<b>Description</b> Silicon Hose		
Ø51X70			

	SEM NO.	REF. NO.	Type / Model
	11246	YC446K683AA	RED
	<b>Description</b> Silicon Hose		
Ø51X85			

<b>Type / Model</b>	<b>REF. NO.</b>	<b>SEM NO.</b>	
	7C465781AA	1054	
			<b>Description</b> Spring Eye Bushing
			D=62 d=24 h=95
<b>Type / Model</b>	<b>REF. NO.</b>	<b>SEM NO.</b>	
		1060	
			<b>Description</b> Spring Eye Bushing
			D=60 d=24 h=81
<b>Type / Model</b>	<b>REF. NO.</b>	<b>SEM NO.</b>	
	BC465348CA	1205	
			<b>Description</b> Spring Eye Bushing
			D=Ø65 d=Ø24 h=95
<b>Type / Model</b>	<b>REF. NO.</b>	<b>SEM NO.</b>	
	BC465348AA	1190	
			<b>Description</b> Spring Eye Bushing
<b>Type / Model</b>	<b>REF. NO.</b>	<b>SEM NO.</b>	
	BC465348BA	1191	
			<b>Description</b> Spring Eye Bushing



Type / Model	REF. NO.	SEM NO.	
	4T165586AA	1039	
		<b>Description</b>	
		Spring Mounting	
Type / Model	REF. NO.	SEM NO.	
	6C165586AA	1063	
		<b>Description</b>	
		Spring Mounting	

 <p>D=Ø85 d=Ø25 Ax=152</p>	<table border="1"> <thead> <tr> <th>SEM NO.</th> <th>REF. NO.</th> <th>Type / Model</th> </tr> </thead> <tbody> <tr> <td>11822</td> <td>9C465541BBS2</td> <td></td> </tr> <tr> <td colspan="3"><b>Description</b></td> </tr> <tr> <td colspan="3">Ball Joint (Kit)</td> </tr> </tbody> </table>	SEM NO.	REF. NO.	Type / Model	11822	9C465541BBS2		<b>Description</b>			Ball Joint (Kit)		
SEM NO.	REF. NO.	Type / Model											
11822	9C465541BBS2												
<b>Description</b>													
Ball Joint (Kit)													
 <p>D=Ø100 d=Ø21 Ax=152</p>	<table border="1"> <thead> <tr> <th>SEM NO.</th> <th>REF. NO.</th> <th>Type / Model</th> </tr> </thead> <tbody> <tr> <td>10991</td> <td>9C465541AAS1</td> <td></td> </tr> <tr> <td colspan="3"><b>Description</b></td> </tr> <tr> <td colspan="3">Ball Joint (Kit)</td> </tr> </tbody> </table>	SEM NO.	REF. NO.	Type / Model	10991	9C465541AAS1		<b>Description</b>			Ball Joint (Kit)		
SEM NO.	REF. NO.	Type / Model											
10991	9C465541AAS1												
<b>Description</b>													
Ball Joint (Kit)													
 <p>D=Ø107,5 d=Ø25 Ax=156</p>	<table border="1"> <thead> <tr> <th>SEM NO.</th> <th>REF. NO.</th> <th>Type / Model</th> </tr> </thead> <tbody> <tr> <td>11820</td> <td>9C465541BBS</td> <td></td> </tr> <tr> <td colspan="3"><b>Description</b></td> </tr> <tr> <td colspan="3">Ball Joint (Kit)</td> </tr> </tbody> </table>	SEM NO.	REF. NO.	Type / Model	11820	9C465541BBS		<b>Description</b>			Ball Joint (Kit)		
SEM NO.	REF. NO.	Type / Model											
11820	9C465541BBS												
<b>Description</b>													
Ball Joint (Kit)													
 <p>D=Ø107,5 d=Ø25 Ax=156</p>	<table border="1"> <thead> <tr> <th>SEM NO.</th> <th>REF. NO.</th> <th>Type / Model</th> </tr> </thead> <tbody> <tr> <td>11821</td> <td>9C465541BBS1</td> <td></td> </tr> <tr> <td colspan="3"><b>Description</b></td> </tr> <tr> <td colspan="3">Ball Joint (Kit)</td> </tr> </tbody> </table>	SEM NO.	REF. NO.	Type / Model	11821	9C465541BBS1		<b>Description</b>			Ball Joint (Kit)		
SEM NO.	REF. NO.	Type / Model											
11821	9C465541BBS1												
<b>Description</b>													
Ball Joint (Kit)													

Type / Model	REF. NO.	SEM NO.
	9C465541BB	10984

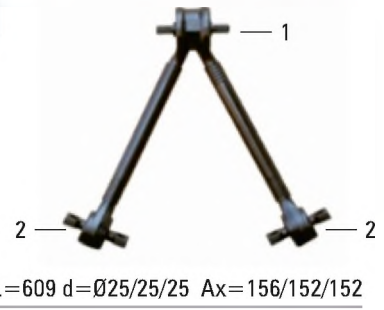

**Description**

Axle Rod (V)

1- 11820 Page 944  
2- 9089 Page 359

**Cab Group**  
Cab Pumps

Type / Model	REF. NO.	SEM NO.
	3C4600356AA	8959



**Description**

Cabin Hand Pump

**Cab Group**  
Pressure Springs

Type / Model	REF. NO.	SEM NO.
	3C4616C826AA	11024



**Description**

Pressure Spring

600-200N





## BMC GROUP



Engine and Transmission Group .....	:	948 - 952
Steering Group .....	:	953
Suspension Group .....	:	954 - 959
Cab Group .....	:	960 - 962
Axle / Differential ve Shaft Group.....	:	-
Clutch and Brake Group.....	:	-

	SEM NO.	REF. NO.	Type / Model
 h=47,5 M12x1,25	1184	51RS203110	
	<b>Description</b> Engine Mounting Right		

	SEM NO.	REF. NO.	Type / Model
 h=47,5 M12x1,25	1185	51RS203109	
	<b>Description</b> Engine Mounting Left		

	SEM NO.	REF. NO.	Type / Model
 M16x1.5 M12x1.5	7400	2B100634 53RS201696	0403 1926 1932 2626 2628
	<b>Description</b> Engine Mounting		

	SEM NO.	REF. NO.	Type / Model
	7887 (8821)	53RS201508	
	<b>Description</b> Engine Mounting		

	SEM NO.	REF. NO.	Type / Model
	7961 (8822)	53RS201507	
	<b>Description</b> Engine Mounting		

	SEM NO.	REF. NO.	Type / Model
	8533 (8820)	53RS200211	
	<b>Description</b> Engine Mounting		

Type / Model	REF. NO.	SEM NO.	
	54RS211097	7488 (8825)	 <p><b>Description</b> Engine Mounting</p> <p>D=Ø59 h=56.5</p>
	54RS211098	7666 (8823)	 <p><b>Description</b> Engine Mounting</p> <p>SHORE A55 D=Ø 72 h= 84</p>
	52RS012269	7667 (8824)	 <p><b>Description</b> Engine Mounting</p> <p>SHORE A45 D=Ø 72 h= 84</p>

	ŞEM NO.	REF. NO.	Type / Model
	8910	2K98417	RED
<b>Description</b>			
Silicon Hose			
D:Ø100 mm L:190 mm 2 HUMP			







	ŞEM NO.	REF. NO.	Type / Model
	8911	3279246	RED
<b>Description</b>			
Silicon Hose			
D:Ø48 mm L:70 mm			

	ŞEM NO.	REF. NO.	Type / Model
	8912	2K55894	RED
<b>Description</b>			
Silicon Hose			
D:Ø62 mm L:150 mm			

	ŞEM NO.	REF. NO.	Type / Model
	8913	2K56167	BLACK RED
<b>Description</b>			
Silicon Hose			
D:Ø62 mm L:110 mm			

	ŞEM NO.	REF. NO.	Type / Model
	8914 (11238)	3903745	BLUE
<b>Description</b>			
Silicon Hose			
D:Ø22 mm L:77,5 mm			

	ŞEM NO.	REF. NO.	Type / Model
	8915	2K67230	RED
<b>Description</b>			
Silicon Hose			
D:Ø76 mm D:Ø100 mm L:150 mm			

Type / Model	REF. NO.	ŞEM NO.	
RED	52RS011982	8916	 <p><b>Description</b> Silicon Hose</p> <p>D:Ø76 mm L:158 mm 2 HUMP</p>
RED	2K90272	8917	 <p><b>Description</b> Silicon Hose</p> <p>D:Ø63,5 mm L:470 mm</p>
BLACK	53RS200863	8918	 <p><b>Description</b> Silicon Hose</p> <p>D:Ø100 mm L:350 mm</p>
BLACK RED	53RS201575	8919	 <p><b>Description</b> Silicon Hose</p> <p>D:Ø100 mm L:350 mm</p>
BLUE	53RS201585	8920	 <p><b>Description</b> Silicon Hose</p> <p>D:Ø100 mm L:350 mm</p>
RED	52RS011983	11236	 <p><b>Description</b> Silicon Hose</p> <p>Ø76X158 2 hump</p>



SEM NO.	REF. NO.	Type / Model
11237	2K98418	GREY
 <p><b>Description</b> Silicon Hose</p>		
Ø100X190 2 hump		

SEM NO.	REF. NO.	Type / Model
11239	C3279245	RED
 <p><b>Description</b> Silicon Hose</p>		
Ø51X70		



SEM NO.	REF. NO.	Type / Model
11240	A2K6167	BLACK RED
 <p><b>Description</b> Silicon Hose</p>		
Ø64X110		

SEM NO.	REF. NO.	Type / Model
11241	53RS200318	BLACK
 <p><b>Description</b> Silicon Hose</p>		
Ø90X110		

SEM NO.	REF. NO.	Type / Model
11242	53RS200317	RED
 <p><b>Description</b> Silicon Hose</p>		
Ø90X110		

Type / Model	REF. NO.	SEM NO.	
	9P914836	8631	 <b>Description</b> Rod End  M30Xx1.5 RHT L120
Type / Model	REF. NO.	SEM NO.	
	9P914835	8632	 <b>Description</b> Rod End  M30Xx1.5 LHT L120



	<b>SEM NO.</b>	<b>REF. NO.</b>	<b>Type / Model</b>
	7856 (8368)	51RS701476	
<b>Description</b>			
Spring Eye Bushing			
D=Ø57 d=Ø20 h=84			
	<b>SEM NO.</b>	<b>REF. NO.</b>	<b>Type / Model</b>
	8817	51RS701988	
<b>Description</b>			
Stabilizer Bush			
D=Ø32,5 d=Ø14,5 h=43			
	<b>SEM NO.</b>	<b>REF. NO.</b>	<b>Type / Model</b>
	1048	51RS701534	
<b>Description</b>			
Rubber Bushing			

Type / Model	REF. NO.	SEM NO.	
	2T165586AB	1029	
		<b>Description</b>	
		Spring Mounting	



D=Ø70 d=Ø50 h=86

SEM NO.	REF. NO.	Type / Model
8370	52RS013869	

**Description**  
Stabilizer Bush



D=Ø75 d=Ø18 Ax=111,25

SEM NO.	REF. NO.	Type / Model
8828	9P914908 57RS308894	

**Description**  
Stabilizer Bush

Type / Model	REF. NO.	SEM NO.	
		<b>7683</b>	
		<b>Description</b>	<b>Ball Joint (Kit)</b>
			D=Ø67 d=Ø20 Ax=111.25
Type / Model	REF. NO.	SEM NO.	
		<b>7718</b>	
		<b>Description</b>	<b>Ball Joint</b>
			D=Ø75 d=Ø21 Ax=111
Type / Model	REF. NO.	SEM NO.	
		<b>7769</b>	
		<b>Description</b>	<b>Ball Joint (Kit)</b>
			D=Ø75 d=Ø21 Ax=111
Type / Model	REF. NO.	SEM NO.	
	52RS0029072	<b>7681</b>	
		<b>Description</b>	<b>Ball Joint (Kit)</b>
			D=Ø75 d=Ø21 Ax=138
Type / Model	REF. NO.	SEM NO.	
	57RS308879S	<b>10249</b>	
		<b>Description</b>	<b>Ball Joint (Kit)</b>
			D=Ø75 d=Ø17 Ax=111
Type / Model	REF. NO.	SEM NO.	
	53RS700172	<b>7335 (7762)</b>	
		<b>Description</b>	<b>Ball Joint (Kit)</b>
			D=Ø85 d=Ø19 Ax=130



	SEM NO.	REF. NO.	Type / Model
 <p>D=Ø85 d=Ø20 Ax=111.25</p>	7592	52RS001077 52RS001401	
	<p><b>Description</b> Ball Joint (Kit)</p>		







	SEM NO.	REF. NO.	Type / Model
 <p>D=Ø85 d=Ø21 Ax=138</p>	7648	52RS001076 52RS001400	
	<p><b>Description</b> Ball Joint (Kit)</p>		

	SEM NO.	REF. NO.	Type / Model
 <p>D=Ø107,5 B=54 L=73</p>	7649	52RS700318	
	<p><b>Description</b> Ball Joint (Kit)</p>		

	SEM NO.	REF. NO.	Type / Model
 <p>D=Ø95 h=132</p>	7811		
	<p><b>Description</b> Ball Joint</p>		

Type / Model	REF. NO.	SEM NO.	
	52RS002907	10983	 <p data-bbox="1032 406 1156 453"><b>Description</b></p> <p data-bbox="1032 464 1156 499">Axle Rod (V)</p> <p data-bbox="1164 511 1536 546">L=581 d=Ø25/21/21 Ax=152/138/138</p>
<p>1- 7682 Page 902</p> <p>2- 7681 Page 957</p>			

	<p><b>SEM NO.</b> 8197</p>	<p><b>REF. NO.</b> 8K153605M</p>	<p><b>Type / Model</b></p>
	<p><b>Description</b> Hand Pump</p>		
	<p><b>SEM NO.</b> 8959</p>	<p><b>REF. NO.</b> 52RS015703</p>	<p><b>Type / Model</b></p>
	<p><b>Description</b> Cabin Hand Pump</p>		
	<p><b>SEM NO.</b> 8960</p>	<p><b>REF. NO.</b> 8K200017</p>	<p><b>Type / Model</b></p>
	<p><b>Description</b> Cabin Hand Pump</p>		

<b>Type / Model</b>	<b>REF. NO.</b>	<b>SEM NO.</b>	
	52RS015502	8961	
		<b>Description</b>	
		Cylinder	
			D=Ø40 Ax=617
<b>Type / Model</b>	<b>REF. NO.</b>	<b>SEM NO.</b>	
	52RS015501	8962	
		<b>Description</b>	
		Cylinder	
			D=Ø40 Ax=617
<b>Type / Model</b>	<b>REF. NO.</b>	<b>SEM NO.</b>	
	8K63946	8964	
		<b>Description</b>	
		Cylinder	
			D=Ø50 Ax=749
<b>Type / Model</b>	<b>REF. NO.</b>	<b>SEM NO.</b>	
	8K15363	8965	
		<b>Description</b>	
		Cylinder	
			D=Ø50 Ax=478
<b>Type / Model</b>	<b>REF. NO.</b>	<b>SEM NO.</b>	
	6K61748	8987	
		<b>Description</b>	
		Cylinder	
<b>Type / Model</b>	<b>REF. NO.</b>	<b>SEM NO.</b>	
		9638	
		<b>Description</b>	
		Repair Kit Oil	





A=60 B=23

SEM NO.	REF. NO.	Type / Model
7482 (8826)	53RS805976	
<b>Description</b>		
Rubber Buffer		

# FREIGHTLINER GROUP



Engine and Transmission Group .....	:	-
Steering Group .....	:	-
Suspension Group .....	:	964
Cab Group .....	:	964
Axle / Differential ve Shaft Group.....	:	-
Clutch and Brake Group.....	:	-



**SEM NO.**

1144

**REF. NO.**

1616412000

**Type / Model**

**Description**

Spring Bushing

D=Ø63 d=Ø20 Ax=144

**4 - 4**



**SEM NO.**

10820

**REF. NO.**

1840977000  
FIRESTONE W023587207

**Type / Model**

**Description**

Cabin Suspension Spring



**SEM NO.**

10821

**REF. NO.**

1829919000  
CONTITECH ABSZ70  
FIRESTONE W023587206

**Type / Model**

**Description**

Cabin Suspension Spring

# PETERBILT GROUP



Engine and Transmission Group .....	:	-
Steering Group .....	:	-
Suspension Group .....	:	-
Cab Group .....	:	966
Axle / Differential ve Shaft Group.....	:	-
Clutch and Brake Group.....	:	-



SEM NO.	REF. NO.	Type / Model
10822	2906016 FIRESTONE W023587093	
<b>Description</b>		
Cabin Suspansion Spring		

# NEWAY GROUP



Engine and Transmission Group .....	:	-
Steering Group .....	:	-
Suspension Group .....	:	968 - 970
Cab Group .....	:	-
Axle / Differential ve Shaft Group.....	:	-
Clutch and Brake Group.....	:	-



D=Ø70 d=Ø30 h=127

SEM NO.	REF. NO.	Type / Model
10211	90008207	
<b>Description</b>		
Spring Bushing		

Technical Specification	REF. NO.	ŞEM NO.	
Total Weight 8,8 kg	90557075 90557027 CONTITECH 4156 N P04 GOODYEAR 1R12-092 TAURUS KR 506-22SU GRANNING 1359 DUNLOP D12B33 RANNING 1528	<b>72.4156.C04</b>	
		<b>Description</b>	
		Metal Piston	
Technical Specification	REF. NO.	ŞEM NO.	
Total Weight 8,8 kg	CONTITECH 4156 N P06 Taurus KR 506-28 GOODYEAR 1R12-719 DUNLOP D12B19 PHOENIX 1 DK 21 A-2 WW US 35864" 90557075	<b>72.4156.C06</b>	
		<b>Description</b>	
		Metal Piston	
Technical Specification	REF. NO.	ŞEM NO.	
Total Weight 6,6 kg	90557075 90557037 90557054 90557033 90557027 CONTITECH 4156 N P14 Granning 1359 PHOENIX 1 DK 23 K-9082 Granning 1528	Granning 2727 Transpart 520 728 WW US 09361F WW US 97306 VIBRACOUSTIC V1DK23K-9082 FIRESTONE 1T15M-6 GOODYEAR 1R12-092 FIRESTONE W01-358-9082 GY SPRINGRIDE D12B33	
		<b>72.4156.CP14</b>	
		<b>Description</b>	
		Plastic Piston	
Technical Specification	REF. NO.	ŞEM NO.	
Total Weight 6,2 kg	90557233 CONTITECH 4157 N P08 FIRESTONE W01 M58 6317 DUNLOP D12B30 PHOENIX 1 DK 20 C-2 GOODYEAR 1R11-773 SAMRO H 2501869 FIRESTONE 1T15MPW-7 SMB M 078580	<b>72.4157.CP08</b>	
		<b>Description</b>	
		Plastic Piston	
Technical Specification	REF. NO.	ŞEM NO.	
Total Weight 9,6 kg	90557009 CONTITECH 4159 N P04	<b>72.4159.C04</b>	
		<b>Description</b>	
		Metal Piston	
Technical Specification	REF. NO.	ŞEM NO.	
Total Weight 9,6 kg	90557009 CONTITECH 4159 N P04	<b>72.4159.C06</b>	
		<b>Description</b>	
		Metal Piston	





SEM NO.	REF. NO.	Technical Specification
---------	----------	-------------------------

<b>72.810.C</b>	21215632	Total Weight 10,5 kg
-----------------	----------	-------------------------

**Description**

Metal Piston



SEM NO.	REF. NO.	Technical Specification
---------	----------	-------------------------

<b>72.813.C</b>	21215633 Paul NFZ P2700MB0813 Pegaso 175005	Total Weight 11,6 kg
-----------------	---	-------------------------

**Description**

Metal Piston

# SETRA / EVOBUS KASSBOHRER GROUP



Engine and Transmission Group .....	:	972 - 975
Steering Group .....	:	976 - 977
Suspension Group .....	:	978 - 989
Cab Group .....	:	990
Axle / Differential ve Shaft Group.....	:	-
Clutch and Brake Group.....	:	991 - 992



M 18x1.5 M 14x1.5

SEM NO.	REF. NO.	Type / Model
7535	6452400418	620
	6202400418	621
	6202400518	2622
	6202400018	
	6202400218	
<b>Description</b>		
Mounting	6452400518	
	6202400118	



M 16x1.5 M 12x1.5

SEM NO.	REF. NO.	Type / Model
7637	4771217421	
<b>Description</b>		
Engine Mounting (Epdm)		

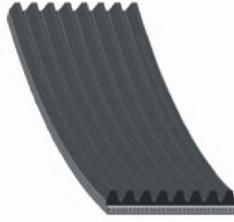
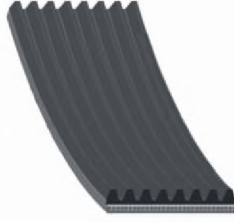
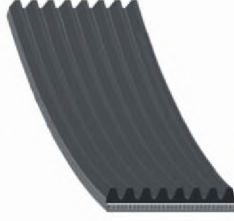
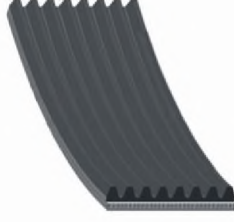
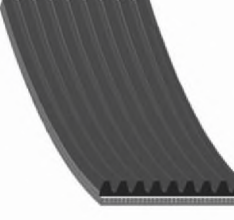
<b>Type / Model</b>	<b>REF. NO.</b>	<b>SEM NO.</b>	
	9069972492	<b>10332</b> (10333)	
		<b>Description</b>	
		V Ribbed Belt	8PK1420
<b>Type / Model</b>	<b>REF. NO.</b>	<b>SEM NO.</b>	
	9069970892	<b>10334</b> (10335)	
		<b>Description</b>	
		V Ribbed Belt	8PK1450
<b>Type / Model</b>	<b>REF. NO.</b>	<b>SEM NO.</b>	
	9069970792	<b>10336</b> (10337)	
		<b>Description</b>	
		V Ribbed Belt	8PK1480
<b>Type / Model</b>	<b>REF. NO.</b>	<b>SEM NO.</b>	
	0009939996 9069937096 9069973192	<b>10352</b> (10353)	
		<b>Description</b>	
		V Ribbed Belt	8PK1852
<b>Type / Model</b>	<b>REF. NO.</b>	<b>SEM NO.</b>	
	9069972392	<b>10363</b> (10364)	
		<b>Description</b>	
		V Ribbed Belt	8PK2043
<b>Type / Model</b>	<b>REF. NO.</b>	<b>SEM NO.</b>	
	0129976092 0019935796	<b>10377</b> (10379)	
		<b>Description</b>	
		V Ribbed Belt	9PK1725

	SEM NO.	REF. NO.	Type / Model
	<b>10381</b> (10382)	0149971792	
	<b>Description</b> V Ribbed Belt		
9PK1825			

	SEM NO.	REF. NO.	Type / Model
	<b>10384</b> (10385)	5419970892	
	<b>Description</b> V Ribbed Belt		
9PK1890			

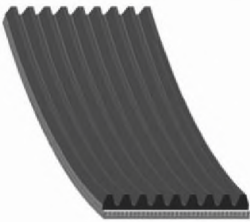
	SEM NO.	REF. NO.	Type / Model
	<b>10386</b> (10387)	0009937796 0139975792 0019934896 0019937196 0019934996	
	<b>Description</b> V Ribbed Belt		
9PK1920			

	SEM NO.	REF. NO.	Type / Model
	<b>10390</b> (10391)	0129973892	
	<b>Description</b> V Ribbed Belt		
9PK2080			



	SEM NO.	REF. NO.	Type / Model
	<b>10413</b> (10414)	5429970092	
	<b>Description</b> V Ribbed Belt		
12PK2490			





Type / Model	REF. NO.	SEM NO.	
Axor 457	0005501633 0005500833	9470	 <p><b>Description</b> Pulley</p> <p>d=Ø10 D=Ø80 h=48</p>

**Engine and Transmission Group**  
Hoses





**1 - 5**

Type / Model	REF. NO.	SEM NO.	
BLACK RED	4741220400	11170	 <p><b>Description</b> Silicon Hose</p> <p>Ø100X150 2 hump</p>
BLACK RED	4741291400	11247	

 <p>Length: 148 mm</p>	<b>SEM NO.</b>	<b>REF. NO.</b>	<b>Type / Model</b>	
	<b>11138</b>	0003200232	0003200632	
	<b>Description</b>		0003200932	0003201032
			6323200432	8226369000
			0003200632	0003200232
			0003201032	6323200432
			0003200232	0003200932
		0003200932	8226369000	
	6323200432			
 <p>Length: 148 mm</p>	<b>SEM NO.</b>	<b>REF. NO.</b>	<b>Type / Model</b>	
	<b>11139</b>	0003200232	0003201032	
	<b>Description</b>		0003200632	6323200432
			0003200932	8226369000
			0003201032	0003200232
			6323200432	0003200932
			0003200232	6323200432
		0003200632	8226369000	
	0003200932			
 <p>Length: 200 mm</p>	<b>SEM NO.</b>	<b>REF. NO.</b>	<b>Type / Model</b>	
	<b>11140</b>	0003201232	6323200532	
	<b>Description</b>		6293200189	6283201489
			6323200232	6323200232
			6323200532	6293200189
			6283201489	6283201489
			0003201232	6323200532
		6293200189		
	6323200232			

Type / Model	REF. NO.	SEM NO.	
	6851475000 6851480000 6851484000 6851531000 8226236059	<b>8631</b>	 <b>Description</b> Rod End M30Xx1.5 RHT L=120
Type / Model	REF. NO.	SEM NO.	
	6851103000 6851509000 6851517000	<b>8635</b>	 <b>Description</b> Rod End M30Xx1.5 RHT L=115
Type / Model	REF. NO.	SEM NO.	
	6851532000 6851479000 6851487000 6851459000 6851446000	<b>8640</b>	 <b>Description</b> Rod End M30x1.5 LHT L=120
Type / Model	REF. NO.	SEM NO.	
	6851491000	<b>10140</b>	 <b>Description</b> Rod End M38x1.5 RHT L=135









	SEM NO.	REF. NO.	Type / Model
 <p>D=Ø68 h=170</p>	<b>7782</b>	477138900	
<p><b>Description</b> Spring Bushing</p>			
	SEM NO.	REF. NO.	Type / Model
 <p>D=Ø68 h=190</p>	<b>7802</b>	477138800	
<p><b>Description</b> Spring Bushing</p>			
	SEM NO.	REF. NO.	Type / Model
 <p>D=Ø65 d=Ø30 h=102</p>	<b>8023 (10831)</b>	4771327000	
<p><b>Description</b> Spring Bushing</p>			
	SEM NO.	REF. NO.	Type / Model
 <p>M22x1,5</p>	<b>10308</b>	8241999726	
<p><b>Description</b> Nut</p>			







Model:		SEM NO.	Description / Repair Kit for Spring
		<b>8024</b>	
<b>Item No</b>	<b>Ref. No</b>	<b>REF. NO:</b>	
1	362385	4771327000S	
2	811911		
3	805479		
4	272449		
5	1367370		
6	255315		
		M30x3,5x225	

**Suspension Group**  
Spring Rubber & Mounting and Repair Kits

**3 - 2**

Type / Model	REF. NO.	SEM NO.	Description
	4771160000	<b>8492</b>	
			Rubber Buffer
			
			D=Ø96 d=Ø19 h=96

	<table border="1"> <thead> <tr> <th>SEM NO.</th> <th>REF. NO.</th> <th>Type / Model</th> </tr> </thead> <tbody> <tr> <td>7652</td> <td>4771475000 4771318000</td> <td></td> </tr> </tbody> </table>	SEM NO.	REF. NO.	Type / Model	7652	4771475000 4771318000		<p><b>Description</b> Bush</p>
SEM NO.	REF. NO.	Type / Model						
7652	4771475000 4771318000							
<p>D=Ø70 d=Ø45 h=68</p>								
	<table border="1"> <thead> <tr> <th>SEM NO.</th> <th>REF. NO.</th> <th>Type / Model</th> </tr> </thead> <tbody> <tr> <td>7653</td> <td>4771214000 4771476000</td> <td></td> </tr> </tbody> </table>	SEM NO.	REF. NO.	Type / Model	7653	4771214000 4771476000		<p><b>Description</b> Bush</p>
SEM NO.	REF. NO.	Type / Model						
7653	4771214000 4771476000							
<p>D=Ø64 d=Ø45 h=50,5</p>								
	<table border="1"> <thead> <tr> <th>SEM NO.</th> <th>REF. NO.</th> <th>Type / Model</th> </tr> </thead> <tbody> <tr> <td>7654</td> <td>4771300000</td> <td></td> </tr> </tbody> </table>	SEM NO.	REF. NO.	Type / Model	7654	4771300000		<p><b>Description</b> Bush</p>
SEM NO.	REF. NO.	Type / Model						
7654	4771300000							
<p>D=Ø56 d=Ø35 h=60,5</p>								
	<table border="1"> <thead> <tr> <th>SEM NO.</th> <th>REF. NO.</th> <th>Type / Model</th> </tr> </thead> <tbody> <tr> <td>7655</td> <td>4771347000D</td> <td></td> </tr> </tbody> </table>	SEM NO.	REF. NO.	Type / Model	7655	4771347000D		<p><b>Description</b> Bush</p>
SEM NO.	REF. NO.	Type / Model						
7655	4771347000D							
<p>D=Ø85 d=Ø60 h=46,5</p>								
	<table border="1"> <thead> <tr> <th>SEM NO.</th> <th>REF. NO.</th> <th>Type / Model</th> </tr> </thead> <tbody> <tr> <td>7671</td> <td>179233115004</td> <td></td> </tr> </tbody> </table>	SEM NO.	REF. NO.	Type / Model	7671	179233115004		<p><b>Description</b> Stabilizer Bush</p>
SEM NO.	REF. NO.	Type / Model						
7671	179233115004							
<p>D=Ø85 D=Ø130 d=Ø56,5 h=65</p>								
	<table border="1"> <thead> <tr> <th>SEM NO.</th> <th>REF. NO.</th> <th>Type / Model</th> </tr> </thead> <tbody> <tr> <td>7775</td> <td>4771194000</td> <td></td> </tr> </tbody> </table>	SEM NO.	REF. NO.	Type / Model	7775	4771194000		<p><b>Description</b> Bush</p>
SEM NO.	REF. NO.	Type / Model						
7775	4771194000							
<p>D=Ø84 d=Ø60 Ax=75</p>								

<b>Type / Model</b>	<b>REF. NO.</b>	<b>SEM NO.</b>	
	4771213000	7776	
			<b>Description</b> Bush D=Ø56 d=Ø36 Ax=52
<b>Type / Model</b>	<b>REF. NO.</b>	<b>SEM NO.</b>	
	1792311180	7670	
			<b>Description</b> Stabilizer Bush (Half) D=Ø73 d=Ø42 h=80 h=70
<b>Type / Model</b>	<b>REF. NO.</b>	<b>SEM NO.</b>	
	4771449000 4771227000	7672	
			<b>Description</b> Stabilizer Bush (Half) D=Ø90 d=Ø61 h=137 h=100
<b>Type / Model</b>	<b>REF. NO.</b>	<b>SEM NO.</b>	
	47713250000	7952	
			<b>Description</b> Stabilizer Bush D=Ø75 d=Ø45 h1=80 h2=70
<b>Type / Model</b>	<b>REF. NO.</b>	<b>SEM NO.</b>	
	4771477000C	7724	
			<b>Description</b> Bush D=Ø59 d=Ø32 h=63
<b>Type / Model</b>	<b>REF. NO.</b>	<b>SEM NO.</b>	
	179233021102D	7804	
			<b>Description</b> Pin D=Ø60 d=Ø35 h=250



**SEM NO.**

**REF. NO.**

**Type / Model**

9230

4771228000

**Description**

Rubber Bush





D=Ø112    d=Ø65    h=12



Model:	ŞEM NO.	Description / Stabilizer Repair Kit
	<b>9183</b>	
<b>Item No</b>	<b>Ref. No</b>	<b>REF. NO:</b>
1	179233021102D	4771227000S
2	4771449000	4771449000S
3	4771228000	4771228000S
4	----	
5	----	

Model:	ŞEM NO.	Description / Stabilizer Repair Kit
	<b>9184</b>	
<b>Item No</b>	<b>Ref. No</b>	<b>REF. NO:</b>
1	----	
2	179233115004	179233115004S
3	----	
4	----	

Model:	ŞEM NO.	Description / Stabilizer Repair Kit
	<b>9185</b>	
<b>Item No</b>	<b>Ref. No</b>	<b>REF. NO:</b>
1	4771318000	4771214000S
2	4771476000	4771476000S
3	----	
4	----	
5	----	

Model:	ŞEM NO.	Description / Stabilizer Repair Kit
	<b>9186</b>	
<b>Item No</b>	<b>Ref. No</b>	<b>REF. NO:</b>
1	----	4771318000S
2	2-4771318000	4771475000S
3	4771475000	
4	----	
5	----	

	SEM NO.	REF. NO.	Type / Model
 <p>D=Ø75 d=Ø21 Ax=130</p>	7636 (8218)	8226296069	
	<b>Description</b> Ball Joint (Kit)		
 <p>D=Ø85 d=Ø19 Ax=130</p>	7335 (7752)	8226232066 82262320660 0003500506	
	<b>Description</b> Ball Joint (Kit)		
 <p>D=Ø 95 B=53,5 L=73</p>	7598	8226296070	
	<b>Description</b> Ball Joint (Kit)		
 <p>D=Ø78 d=Ø19&amp;22 Ax=130</p>	9625	6283300807 6283300407 0003301107 6293301407	
	<b>Description</b> Stabilizer Bushing		

Type / Model	REF. NO.	SEM NO.	
1 - 7335 Page 984	3573330205	8951	 <p><b>Description</b> Axle Rod</p> <p>L=750 d=Ø19/19 Ax=130/ 130</p>
1 - 8216 Page 359	8226318000B 8226323000B	9344	 <p><b>Description</b> Axle Rod Alternative Rubber</p> <p>L=660 d=Ø19/19 Ax=130/130</p>
1 - 7919 Page 358	6273500006 6273500106 6283330003 6283330005 6283331005 6283331805	10165	 <p><b>Description</b> Axle Rod</p> <p>L=664 d=Ø19/19 Ax=130/130</p>







SEM NO.	REF. NO.	Type / Model
11521	6283261800	OPEN LENGTH=508
	6283262600	CLOSED LENGTH=311
	6283262300	UPPER MOUNT
	SACHS 290991	DIMENSION=M14x67
<b>Description</b>		LOWER MOUNT
Shock Absorber		DIMENSION=M14x67

Technical Specification	REF. NO.	SEM NO.	
Total Weight 1,5 kg	3563270001 3563270201 6133270101 CONTITECH RZ 450 R25 GY SPRINGRIDE D12S13 PHOENIX 1 E 23 CF GOMMA REF.1S300 27 VIBRACOUSTIC V1E23 CF GOMMA NO. 203386 GOODYEAR9050	<b>72.450.R25</b>	<b>Description</b> Roll
			
Total Weight 1,9 kg	6293270001 CONTITECH 4644 N GOODYEAR 9561	<b>72.4644.S</b>	<b>Description</b> Service Assembly
			
Total Weight 1,4 kg	0003270101 3273270001 0003270201 3273270101 3073280001 3273280001 0003200321 6133270001	CONTITECH 644 NGY SPRINGRIDE D11S01 PHOENIX 1 E 21 CF GOMMA REF.1S285-24 Taurus B1121 CF GOMMA NO. 92574 VIBRACOUSTIC V1E21 DUNLOP UK PNP301470102 FIRESTONE 1R1A390-295 GART NO. 276.0.390 FIRESTONE W01-095-0118 GART REF. D276/B GOODYEAR 8017	<b>72.644.R</b>
			<b>Description</b> Roll
			
Total Weight 1,8 kg	4103270001 CONTITECH 661 N CF GOMMA REF.1S310 28 PHOENIX 1 E 25 CF GOMMA NO.91016 VIBRACOUSTIC V1E25( 2) ART NO. 297.0.390 FIRESTONE 1R1C390 310 GART REF.D297	FIRESTONE W01 095 0021 DUNLOP UK PNP304980101 GOODYEAR 8018 GY SPRINGRIDE D12S02 Büssing 831 120 144 Büssing 546 905 134 Hanomag 536 905 265 IRISBUS 5001829866	<b>72.661.R</b>
			<b>Description</b> Roll
			
Total Weight 1,5 kg	3833270001 6213280001 CONTITECH 673 N GOODYEAR 9051 PHOENIX 1 F 21 A GY SPRINGRIDE D11S06 Taurus B141 CF GOMMA REF.1SC285-22	VIBRACOUSTIC V1F21A CF GOMMA NO. 88786 FIRESTONE 1R1A370-285 GART NO.276.0.370 FIRESTONE W01-095-0198 GART REF. D276/C BredaMenarini 178 623 BredaMenarini 325 993	<b>72.673.R</b>
			<b>Description</b> Roll
			
Total Weight 2,8 kg	4731032000 GIGANT 196036 GIGANT 166205 Kögel 4731032000		<b>72.719.R</b>
			<b>Description</b> Roll
			

	<b>SEM NO.</b>	<b>REF. NO.</b>	<b>Technical Specification</b>
	72.762.R	4731013000 3823277101	Total Weight 2,3 kg
<b>Description</b>			
Roll			
	<b>SEM NO.</b>	<b>REF. NO.</b>	<b>Technical Specification</b>
	72.775.R	4731040000	Total Weight 5 kg
<b>Description</b>			
Roll			
	<b>SEM NO.</b>	<b>REF. NO.</b>	<b>Technical Specification</b>
	72.811.ST	4731029000 CONTITECH 811 NT GOODYEAR 1R14-715 FIRESTONE 1T19L-10 PHOENIX 1 DK 28 FIRESTONE W01 M58 0028 Taurus UR 622-03	Total Weight 4,2 kg
<b>Description</b>			
Service Assembly			
	<b>SEM NO.</b>	<b>REF. NO.</b>	<b>Technical Specification</b>
	72.811.STB	4731029000 CONTITECH 811 NTB GOODYEAR 1R14-739 FIRESTONE 1T19L-10 PHOENIX 1 DK 28 B-4 FIRESTONE W01 M58 0747	Total Weight 4,8 kg
<b>Description</b>			
Service Assembly			
	<b>SEM NO.</b>	<b>REF. NO.</b>	<b>Technical Specification</b>
	72.813.C	4731030000 4731033000	Total Weight 11,6 kg
<b>Description</b>			
Metal Piston			
	<b>SEM NO.</b>	<b>REF. NO.</b>	<b>Technical Specification</b>
	72.921.R	4771503000 0003280001 CONTITECH 921 N GY SPRINGRIDE D10S04 PHOENIX 1 E 17 CF GOMMA REF.1S285-23V VIBRACOUSTIC V1E17 CF GOMMA NO. 202728 FIRESTONE 1R1A415-260	GART NO.276.0.391 FIRESTONE W01-095-0226 GART REF. D276/BS GOODYEAR 8043 Heuliez 5 000 288 982 IRISBUS 5000288982 IRISBUS 5010151379 IRISBUS 5010151378 Temsa Total Weight 2 kg
<b>Description</b>			
Roll			

Technical Specification	REF. NO.	SEM NO.	
Total Weight 2 kg	6993280101 CONTITECH 975 N FIRESTONE W01 095 0437 PHOENIX 1 E 10 DUNLOP UK 00628A AP VIBRACOUSTIC V1E10 GART NO.305.0.320 FIRESTONE 1R1T320195 GART REF. D305 Optare R 5800001 ZF Sachs 0501 312 548	<b>72.975.R</b>	
		<b>Description</b> Roll	
Technical Specification	REF. NO.	SEM NO.	
Total Weight 1,1 kg	4731003000 4731024000	<b>72.2285.M01</b>	
		<b>Description</b> Convulated Air Spring	

SEM NO.	REF. NO.	Type / Model
9729	8233190000	



<b>Description</b>
Pressure Spring



565-240-730N.

**SETRA / EVOBUS  
KASSBOHRER**

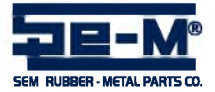
Clutch and Brake Group  
Brake Adjuster

**6 - 2**



Type / Model	REF. NO.		SEM NO.	
	8241037367		12863	 <b>Description</b> Brake Slack Adjuster, Manuel Ø 14x120/150/180x0° / 19'LOCK

Type / Model	REF. NO.		SEM NO.	
Clutch and Brake Group Caliper Group / MRT Type			<b>6 - 4 - 2</b>	
MRT TYPE LRG 524, 525, 526, 527, 528, 529, 532, 533, 622, 623	8285388441		12380	 <b>Description</b> Caliper Repair Kit

	<p><b>SEM NO.</b> 12062</p>	<p><i>new product</i></p>	<p><b>REF. NO.</b> 8241000622</p>	<p><b>Type / Model</b></p>
	<p><b>Description</b> Repair Kit</p>			
	<p><b>SEM NO.</b> 12082</p>	<p><i>new product</i></p>	<p><b>REF. NO.</b> 8241999301</p>	<p><b>Type / Model</b></p>
	<p><b>Description</b> Metal Bushing</p>			
	<p><b>SEM NO.</b> 12083</p>	<p><i>new product</i></p>	<p><b>REF. NO.</b> 8241999300</p>	<p><b>Type / Model</b></p>
	<p><b>Description</b> Metal Bushing</p>			
	<p><b>SEM NO.</b> 12084</p>	<p><i>new product</i></p>	<p><b>REF. NO.</b> 8241016214</p>	<p><b>Type / Model</b></p>
	<p><b>Description</b> Metal Bushing</p>			
	<p><b>SEM NO.</b> 12085</p>	<p><i>new product</i></p>	<p><b>REF. NO.</b> 8241000618</p>	<p><b>Type / Model</b></p>
	<p><b>Description</b> Metal Bushing</p>			
	<p><b>SEM NO.</b> 12090</p>	<p><i>new product</i></p>	<p><b>REF. NO.</b> 8241016213</p>	<p><b>Type / Model</b></p>
	<p><b>Description</b> Bushing</p>			

## NEOPLAN GROUP



Engine and Transmission Group .....	:	994
Steering Group .....	:	994
Suspension Group .....	:	995 - 1001
Cab Group .....	:	-
Axle / Differential ve Shaft Group.....	:	-
Clutch and Brake Group.....	:	1001 -1003





SEM NO.	REF. NO.	Type / Model
7720	010211100	
<b>Description</b>		
Engine Mounting (Epdm)		

M 16X1.5 M 12X1.5



SEM NO.	REF. NO.	Type / Model
8246	010252000 0523434	
<b>Description</b>		
Engine Mounting		

# 1 - 7



SEM NO.	REF. NO.	Type / Model
7294	N1011000961	19.190 20.190 22.190 26.321 30.240 32.281
<b>Description</b>		
Rubber Metal Buffer		

D=Ø50 h=40 M10X25 ShoreA 55

# 2 - 2



SEM NO.	REF. NO.	Type / Model
8631	11019659 14013769 120325000 122353202 N1011020300	
<b>Description</b>		
Rod End		

M30Xx1.5 RHT L=120



SEM NO.	REF. NO.	Type / Model
8635	082192300 120325101	
<b>Description</b>		
Rod End		

M30Xx1.5 RHT L=115

<b>Type / Model</b>	<b>REF. NO.</b>	<b>SEM NO.</b>	
	080155020 22000008706	<b>7609</b>	
			<b>Description</b> Block
			D=Ø64 d=Ø36 h=76
<b>Type / Model</b>	<b>REF. NO.</b>	<b>SEM NO.</b>	
	080155038	<b>7645</b>	
			<b>Description</b> Silent Block
			D=Ø64 d=Ø36 h=76
<b>Type / Model</b>	<b>REF. NO.</b>	<b>SEM NO.</b>	
	080155037	<b>7657</b>	
			<b>Description</b> Silent Block
			D=Ø60 d=Ø32 h=66
<b>Type / Model</b>	<b>REF. NO.</b>	<b>SEM NO.</b>	
		<b>7684</b>	
			<b>Description</b> Silent Block
			D=Ø78 d=Ø30 h=79
<b>Type / Model</b>	<b>REF. NO.</b>	<b>SEM NO.</b>	
	080155035	<b>7685</b>	
			<b>Description</b> Silent Block
			D=Ø78 d=Ø45 h=76
<b>Type / Model</b>	<b>REF. NO.</b>	<b>SEM NO.</b>	
	082192400	<b>7933</b>	
			<b>Description</b> Silent Block
			D=Ø78 d=Ø30 h=78

SEM NO.	REF. NO.	Type / Model
7632	080155019	
 <p><b>Description</b> Silent Block</p> <p>D=Ø64 d=Ø19 B=72 Ax=124</p>		





SEM NO.	REF. NO.	Type / Model
7633	080155033	
 <p><b>Description</b> Silent Block</p> <p>D=Ø64 d=Ø19 B=86 Ax=124</p>		

SEM NO.	REF. NO.	Type / Model
7708	81432206177S 81432206179S1 81432206224S1	
 <p><b>Description</b> Stabilizer Bush</p> <p>D=Ø 67 Cone=Ø 36 L=83</p>		

SEM NO.	REF. NO.	Type / Model
7709	81432206177S 81432206179S 81432206224S 81432206215S	
 <p><b>Description</b> Stabilizer Bush</p> <p>D=Ø67 d=Ø15 Ax=80</p>		

SEM NO.	REF. NO.	Type / Model
10260	81432206177 81432206179 81432206224	S 2000
 <p><b>Description</b> Stabilizer Rod</p> <p>L=330 Cone=Ø 36 d=Ø15 Ax=80</p>		
		1- 7708 Page 996 2- 7709 Page 996

SEM NO.	REF. NO.	Type / Model
11817	81432206215	
 <p><b>Description</b> Axle Rod</p> <p>L=413 d=15/15 Ax=80/80</p>		
		1- 7709 Page 996

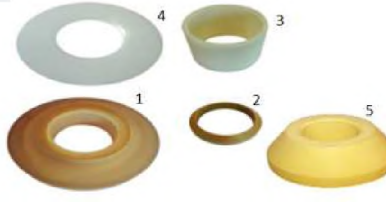
Type / Model	REF. NO.	SEM NO.	
	11014444	9040	 <p><b>Description</b> Pur Mounting</p> <p>D=Ø275 d=Ø115 h=121</p>
	428437	10203	 <p><b>Description</b> Pur Mounting</p>
	11014444S 11014440S	10448	 <p><b>Description</b> Pur Kit</p> <p>1</p>
1-9040			
	11014444S1	11838	  <p><b>Description</b> Pur Kit</p>
1-11806 2-11807 3-11588 4-11589 5- 9040			

	SEM NO.	REF. NO.	Type / Model
	7335 (7741)	070550504 11013547	
	<b>Description</b> Ball Joint (Kit)		
D=Ø85 d=Ø19 Ax=130			

	SEM NO.	REF. NO.	Type / Model
	7565 (7750)	082756611 11015964	
	<b>Description</b> Ball Joint (KIT)		
D=Ø85 d=Ø21 Ax=130			

	SEM NO.	REF. NO.	Type / Model
	7611 (7757)	11015972	
	<b>Description</b> Ball Joint (Kit)		
D=Ø95 L=73			

	SEM NO.	REF. NO.	Type / Model
	9076 (9419)	082751027	
	<b>Description</b> Ball Joint (Kit)		
D=Ø95 L=73			

Suspension Group  
Axle Rod Bushing and Repair Kits

Description / Ball Joint (Repair Kit)	SEM NO.	Model:
	7832 (7835)	
	REF. NO:	
	082750905 11015868	
	Ø72	

Type / Model	REF. NO.	ŞEM NO.	
	81432206190	9359	 Description Axle Rod Alternative Rubber L=531 d=Ø19/19 Ax=130/130
1- 7335 Page 998			

Type / Model	REF. NO.	ŞEM NO.	
	81432206189	9360	 Description Axle Rod Alternative Rubber L=614 d=Ø19/19 Ax=130/130
1- 7335 Page 998			

**Suspension Group**  
V Arms

Type / Model	REF. NO.	ŞEM NO.	
	082750900 11015863 N1011015863	11256	 Description V- Torque Rod L=750 d=19/19 Ax=130/130
1- 7832 Page 998 2- 7335 Page 998			

**Suspension Group**  
Shock Absorbers / Shock Absorber Bushing and Rubbers

Type / Model	REF. NO.	ŞEM NO.	
OPEN LENGTH=247 CLOSED LENGTH=180 UPPER MOUNT DIMENSION=12x32 LOWER MOUNT DIMENSION=12x32	11001047 SACHS 125176 SACHS 101315	11436	 Description Shock Absorber

Type / Model	REF. NO.	ŞEM NO.	
OPEN LENGTH=625 CLOSED LENGTH=377 UPPER MOUNT DIMENSION=M16x92 LOWER MOUNT DIMENSION=M16x92	12104 100210300 12105 102201000 12106 12107 11016416 100210200	SACHS 101424 SACHS 101425 SACHS 101426 SACHS 101427 SACHS 101428 SACHS 101429 SACHS 101430 SACHS 101431 SACHS 101432	MONROE B5313 MONROE B5314 MONROE B5315 MONROE B5316 MONROE B5317 MONROE B5318 MONROE B5319 MONROE B5320 MONROE B5321
		11446	 Description Shock Absorber

	<b>ŞEM NO.</b>	<b>REF. NO.</b>	<b>Technical Specification</b>
	72.644.R	100110300 100112254 100110300 AA1001300	CONTITECH 644 N PHOENIX 1 E 21 Taurus BL121 VIBRACOUSTIC V1E21 FIRESTONE 1R1A390 295 FIRESTONE W01 095 0118 GOODYEAR 8017 GY SPRINGRIDE D11S01 CF GOMMA REF. 1S285 24 CF GOMMA NO. 92574
	<b>ŞEM NO.</b>	<b>REF. NO.</b>	<b>Technical Specification</b>
	72.661.R	100112250 11016345 AA1001001	CONTITECH 661 N PHOENIX 1 E 25 VIBRACOUSTIC V1E25( 2) FIRESTONE 1R1C390 310 FIRESTONE W01 095 0021 GOODYEAR 8018 Büssing 831 120 144 CF GOMMA REF. 1S310 28 CF GOMMA NO. 91016 GART NO. 297.0.390 GART REF. D297
	<b>ŞEM NO.</b>	<b>REF. NO.</b>	<b>Technical Specification</b>
	72.662.R	100110200 100112251 AA1021300 AA1001002	CONTITECH 662 N PHOENIX 1 E 32 VIBRACOUSTIC V1E32 FIRESTONE 1R1D355 355 FIRESTONE W01 095 0207 Büssing 100 110 200 Büssing 100 112 251 GOODYEAR 9007 GY SPRINGRIDE D13S01 CF GOMMA REF. 1SC360 30
	<b>ŞEM NO.</b>	<b>REF. NO.</b>	<b>Technical Specification</b>
	72.719.R	100110100 102100200	CONTITECH 719 N PHOENIX 1 F 32 B VIBRACOUSTIC V1F32B FIRESTONE 1R2D530-360 FIRESTONE W01-095-0192 GOODYEAR 8118 CF GOMMA REF.1SC360-43 CF GOMMA NO. 92593 DUNLOP UK PNP304620101
	<b>ŞEM NO.</b>	<b>REF. NO.</b>	<b>Technical Specification</b>
	72.720.R	100112300	CONTITECH 720 N PHOENIX 1 F 21 VIBRACOUSTIC V1F21 FIRESTONE 1R2A460 295 DUNLOP UK PNP301000100 FIRESTONE W01 095 0195 GOODYEAR 9008 GY SPRINGRIDE D12S04 CF GOMMA REF. 1SC290 30 CF GOMMA NO. 88802
	<b>ŞEM NO.</b>	<b>REF. NO.</b>	<b>Technical Specification</b>
	72.762.R	102100300	CONTITECH 762 N PHOENIX 1 F 32 VIBRACOUSTIC V1F32 FIRESTONE 1R2D390 360 FIRESTONE W01 095 0190 Gigant 196035 GOODYEAR 9010 GY SPRINGRIDE D13S02 CF GOMMA REF. 1SC360 30 CF GOMMA NO. 92594



Technical Specification	REF. NO.	SEM NO.	
Total Weight 2,4 kg	102100500 102121500	CONTITECH 909 NT	<b>72.909.ST</b>
			<b>Description</b> Service Assembly



Technical Specification	REF. NO.	SEM NO.	
Total Weight 2 kg	CONTITECH 921 N PHOENIX 1 E 17 VIBRACOUSTIC V1E17 FIRESTONE 1R1A415-260 FIRESTONE W01-095-0226 GOODYEAR 8043 GY SPRINGRIDE D10S04 CF GOMMA REF. 1S285-23V CF GOMMA NO. 202728		<b>72.921.R</b>
			<b>Description</b> Roll



**Clutch and Brake Group**  
Clutch&Clutch Steering Products

**6 - 1**

Type / Model	REF. NO.	SEM NO.	
SL 232	81305600063 81305600056 81305600057		<b>9499</b>
			<b>Description</b> Clutch Lever



Type / Model	REF. NO.	SEM NO.	
32.270 26.270 19.463	81305606019		<b>9502</b>
			<b>Description</b> Clutch Lever Repair Kit





SEM NO.		REF. NO.	Type / Model
12839		070276100	
<b>Description</b>			
Brake Slack Adjuster, Automatic			
Ø 14x145x50°			

SEM NO.		REF. NO.	Type / Model
12840		070276000 11013281	
<b>Description</b>			
Brake Slack Adjuster, Automatic			
Ø 14x145x50°			

SEM NO.		REF. NO.	Type / Model
12843		082460300	
<b>Description</b>			
Brake Slack Adjuster, Automatic-Left			
Ø 16x165x308°			

SEM NO.		REF. NO.	Type / Model
12844		070265600	
<b>Description</b>			
Brake Slack Adjuster, Automatic-Right			
Ø 16x165x308°			

SEM NO.		REF. NO.	Type / Model
12852		070112507	
<b>Description</b>			
Brake Slack Adjuster, Automatic			
Ø 14x115x61°			

SEM NO.		REF. NO.	Type / Model
12854		080110802	
<b>Description</b>			
Brake Slack Adjuster, Automatic			
Ø 14x130x79°			

Type / Model	REF. NO.		SEM NO.	
	70115348		12859	 <p><b>Description</b> Brake Slack Adjuster, Automatic-Right</p> <p>Ø 14x145x0°</p>

**Clutch and Brake Group**  
Caliper Group / WBC Type

**6 - 4.3**

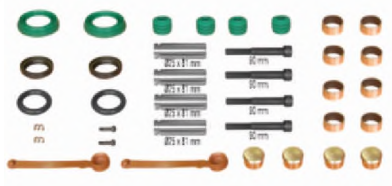
Type / Model	REF. NO.		SEM NO.	
WBC TYPE	082139200 11015566		12527	 <p><b>Description</b> Caliper Repair Kit</p>



# IKARUS GROUP



Engine and Transmission Group .....	:	1006
Steering Group .....	:	-
Suspension Group .....	:	1006 - 1007
Cab Group .....	:	-
Axle / Differential ve Shaft Group.....	:	-
Clutch and Brake Group.....	:	-

	ŞEM NO.	REF. NO.	Type / Model
	7370 (7863)	3962107832	590 NG232 SG220 SG242 SL200 SR240 Sr280
<b>Description</b> Engine Mounting			
M 14x1.5			

3 - 5

Suspension Group  
Axle Rod Bushing and Repair Kits

	ŞEM NO.	REF. NO.	Type / Model
	7335 (7499)	3660 7000307001	
<b>Description</b> Ball Joint (Kit)			
D=Ø85 d=Ø19 Ax=130			

	ŞEM NO.	REF. NO.	Type / Model
	7498	3661	
<b>Description</b> Ball Joint			
D=Ø 85 B=55 L=170			

	ŞEM NO.	REF. NO.	Type / Model
	7480	30020000000	
<b>Description</b> Ball Joint			
D=Ø80 d=Ø26 h=60			

	ŞEM NO.	REF. NO.	Type / Model
	7658	M502774	
<b>Description</b> Ball Joint			
D=Ø80 d=Ø26 h=78			

Type / Model	REF. NO.	SEM NO.	
	06020490	7605	 <b>Description</b> Round Buffer D=Ø76 d=Ø26 h=30

**Suspension Group**  
Suspension Bellows

**3 - 9**

Technical Specification	REF. NO.	SEM NO.	
Total Weight 1,4 kg	CONTITECH 644 N	CF GOMMA NO. 92574	 <b>Description</b> Roll
	PHOENIX 1 E 21	DUNLOP UK PNP301470102	
	Taurus BL121	GART NO. 276.0.390	
	VIBRACOUSTIC V1E21	GART REF. D276/B	
	FIRESTONE 1R1A390 295	SMB	
	FIRESTONE W01 095 0118	BredaMenarini 199 196	
	GOODYEAR 8017	Büssing 536 905 265	
GY SPRINGRIDE D11S01	Büssing 536 905 266		
CF GOMMA REF. 1S285 24	Daewoo 96708659		
Total Weight 1,8 kg	CONTITECH 661 N	GART REF. D297	 <b>Description</b> Roll
	PHOENIX 1 E 25	DUNLOP UK PNP304980101	
	VIBRACOUSTIC V1E25( 2)	GY SPRINGRIDE D12S02	
	FIRESTONE 1R1C390 310	Büssing 546 905 134	
	FIRESTONE W01 095 0021	Hanomag 536 905 265	
	GOODYEAR 8018	IRISBUS 5001829866	
	Büssing 831 120 144	RABA	
CF GOMMA REF. 1S310 28			
CF GOMMA NO. 91016			
GART NO. 297.0.390			
Total Weight 2,4 kg	CONTITECH 662 N	CF GOMMA REF. 1SC360-30	 <b>Description</b> Roll
	PHOENIX 1 E 32	CF GOMMA NO. 92594	
	VIBRACOUSTIC V1E32	DUNLOP UK PNP302730101	
	FIRESTONE 1R1D355-355	Floor 848	
	FIRESTONE W01-095-0207	SMB	
	Büssing 100 110 200	VDL Bus 0 578 361	
	Büssing 100 112 251	Kögel	
GOODYEAR 9007	Wackenhut		
GY SPRINGRIDE D13S01			



# VANHOO L GROUP



Engine and Transmission Group .....	:	-
Steering Group .....	:	1010
Suspension Group .....	:	1010 - 1012
Cab Group .....	:	1013
Axle / Differential ve Shaft Group.....	:	-
Clutch and Brake Group.....	:	-





**SEM NO.**

**REF. NO.**

**Type / Model**

**8631**

634301250

**Description**

Rod End

M30Xx1.5 RHT L=120



**SEM NO.**

**REF. NO.**

**Type / Model**

**8635**

634301260

634301330

634301331

**Description**

Rod End

M30Xx1.5 RHT L=115

**3 - 2**



**SEM NO.**

**REF. NO.**

**Type / Model**

**1120**

10739069

**Description**

Spring Mounting



**SEM NO.**

**REF. NO.**

**Type / Model**

**9199**

10569442

**Description**

Rubber Buffer

D=Ø50 h=40 M10x1,5x28

<b>Type / Model</b>	<b>REF. NO.</b>	<b>SEM NO.</b>	
	634300570	8527 (9210)	
			<b>Description</b> Ball Joint (Kit) D=Ø67 d=Ø15 Ax=100
<b>Type / Model</b>	<b>REF. NO.</b>	<b>SEM NO.</b>	
	10938662 133509 634301790	7595 (9512)	
			<b>Description</b> Ball Joint (Kit) D=Ø75 d=Ø17 Ax=115
<b>Type / Model</b>	<b>REF. NO.</b>	<b>SEM NO.</b>	
	500333284	9083 (9086)	
			<b>Description</b> Ball Joint (Kit) D=Ø75 d=Ø19 Ax=130
<b>Type / Model</b>	<b>REF. NO.</b>	<b>SEM NO.</b>	
26.280 26.281 26.321 33.372 S2000	634303610	7335 (9200)	
			<b>Description</b> Ball Joint (Kit) D=Ø85 d=Ø19 Ax=130
<b>Type / Model</b>	<b>REF. NO.</b>	<b>SEM NO.</b>	
	634300770	10873	
			<b>Description</b> Ball Joint (Kit) D=Ø85 d=Ø19 Ax=130
<b>Type / Model</b>	<b>REF. NO.</b>	<b>SEM NO.</b>	
	920918033 8970225	7599	
			<b>Description</b> Ball Joint D=Ø 85 d=Ø 32 h=95

	<b>ŞEM NO.</b>	<b>REF. NO.</b>	<b>Technical Specification</b>
	72.644.R	624319-420 624319-610 CONTITECH 644 N PHOENIX 1 E 21 Taurus BL121 VIBRACOUSTIC V1E21	GY SPRINGRIDE D11S01 CF GOMMA REF. 1S285 24 CF GOMMA NO. 92574 DUNLOP UK PNP301470102 GART NO. 276.0.390 GART REF. D276/B SMB BredaMenarini 199 196
	<b>Description</b>	Roll	Total Weight 1,4 kg
	<b>ŞEM NO.</b>	<b>REF. NO.</b>	<b>Technical Specification</b>
	72.661.R	624319670 624319700 CONTITECH 661 N PHOENIX 1 E 25 VIBRACOUSTIC V1E25( 2)	CF GOMMA REF. 1S310 28 CF GOMMA NO. 91016 GART NO. 297.0.390 GART REF. D297 DUNLOP UK PNP304980101 GY SPRINGRIDE D12S02
	<b>Description</b>	Roll	Total Weight 1,8 kg
			Büssing 546 905 134 Hanomag 536 905 265 IRISBUS 5001829866 RABA
	<b>ŞEM NO.</b>	<b>REF. NO.</b>	<b>Technical Specification</b>
	72.662.R	CONTITECH 662 N PHOENIX 1 E 32 VIBRACOUSTIC V1E32	GOODYEAR 9007 GY SPRINGRIDE D13S01 CF GOMMA REF. 1SC360-30 CF GOMMA NO. 92594
	<b>Description</b>	Roll	Total Weight 2,4 kg
			DUNLOP UK PNP302730101 Floor 848 SMB VDL Bus 0 578 361
	<b>ŞEM NO.</b>	<b>REF. NO.</b>	<b>Technical Specification</b>
	72.673.R	624319860 CONTITECH 673 N PHOENIX 1 F 21 A Taurus B141 VIBRACOUSTIC V1F21A	GY SPRINGRIDE D11S06 CF GOMMA REF. 1SC285-22 CF GOMMA NO. 88786 GART NO. 276.0.370 GART REF. D276/C BredaMenarini 325 993
	<b>Description</b>	Roll	Total Weight 1,5 kg
			FIRESTONE 1R1A370-285 FIRESTONE W01-095-0198 BredaMenarini 178 623
	<b>ŞEM NO.</b>	<b>REF. NO.</b>	<b>Technical Specification</b>
	72.762.R	624319460 624319680 CONTITECH 762 N PHOENIX 1 F 32 VIBRACOUSTIC V1F32	GY SPRINGRIDE D13S02 CF GOMMA REF. 1SC360-30 CF GOMMA NO. 92594 DUNLOP UK PNP307800100 VDL Bus 0 644 425
	<b>Description</b>	Roll	Total Weight 2,3 kg
			FIRESTONE 1R2D390 360 FIRESTONE W01 095 0190 Gigant 196035 GOODYEAR 9010
	<b>ŞEM NO.</b>	<b>REF. NO.</b>	<b>Technical Specification</b>
	72.769.R	CONTITECH 769 N FIRESTONE W01-095-0204 PHOENIX 1 E 18 GOODYEAR 8053 VIBRACOUSTIC V1E18	IRISBUS 5000786640 Daewoo 96708574 IRISBUS 5000786641 Heuliez 5 000 805 284 IRISBUS 5000805284 624319-860 Hyundai Scania
	<b>Description</b>	Roll	Total Weight 1,3 kg
			GY SPRINGRIDE D10S02 FIRESTONE 1R1A380-260 DUNLOP UK PNP037690200 BredaMenarini 252 933

Type / Model	REF. NO.	SEM NO.	
	631000090	7690	
		<b>Description</b>	
		Cabin Mounting	



## BOVA GROUP



Engine and Transmission Group .....	:	-
Steering Group .....	:	1016
Suspension Group .....	:	1017 - 1018
Cab Group .....	:	-
Axle / Differential ve Shaft Group.....	:	-
Clutch and Brake Group.....	:	-





M30Xx1.5 RHT L=120

SEM NO.	REF. NO.	Type / Model
8631	264074 510053 607981	
<b>Description</b>		
Rod End		



SEM NO.	REF. NO.	Type / Model
11579	229872	
<b>Description</b>		
Rod End		

Type / Model	REF. NO.	SEM NO.	
	226127	7950	 <p><b>Description</b> Ball Joint (Kit)</p> <p>D=Ø75 d=Ø25 Ax=130</p>
	229283 20229283	10640	 <p><b>Description</b> Ball Joint (Kit)</p> <p>D=Ø75 d=Ø19 Ax=124</p>
	239310	7335 (10202)	 <p><b>Description</b> Ball Joint (Kit)</p> <p>D=Ø85 d=Ø19 Ax=130</p>









	SEM NO.	REF. NO.	Type / Model
 <p>L=700 d=Ø/19/19 Ax=130/130</p>	<b>10158</b>	233046	
	<p><b>Description</b> Axle Rod</p>		
			1- 7335 Page 1017

	SEM NO.	REF. NO.	Type / Model
 <p>L=815 d=Ø/19/19 Ax=130/130</p>	<b>10159</b>	233047 20233047	
	<p><b>Description</b> Axle Rod</p>		
			1- 7335 Page 1017

**JOST GROUP**



	SEM NO.	REF. NO.	Type / Model
	1125	Sk210519	
	<b>Description</b>		
	Lock Ring		
	1126	Sk212151	
	<b>Description</b>		
	Lock Ring Kit		
	1127	Sk322150	
	<b>Description</b>		
	Lock Ring Kit		
	1128	Sk322152	
	<b>Description</b>		
	Lock Ring Kit		
	1129	SK1489Z	
	<b>Description</b>		
	Lock Claw		
	1130	Sk310592 Sk310593	
	<b>Description</b>		
	Lock Ring		

Type / Model	REF. NO.	SEM NO.	
		1131	
		<b>Description</b>	
		Lock Ring Kit	
Type / Model	REF. NO.	SEM NO.	
	SK322160Z	1132	
		<b>Description</b>	
		Lock Ring Kit	
Type / Model	REF. NO.	SEM NO.	
	SK320506	1133	
		<b>Description</b>	
		Lock Nail	
Type / Model	REF. NO.	SEM NO.	
	SK001009720	1134	
		<b>Description</b>	
		Lock Nail	
Type / Model	REF. NO.	SEM NO.	
	KZ1006 KZ1012	1135	
		<b>Description</b>	
		2"King Pin	
Type / Model	REF. NO.	SEM NO.	
	KZ1008 KZ1010	1136	
		<b>Description</b>	
		2"King Pin Kit	

	SEM NO.	REF. NO.	Type / Model
	1137	KZ1008S KZ1010S	
	<b>Description</b> 2" King Pin Plate Kit		

	SEM NO.	REF. NO.	Type / Model
	1139		
	<b>Description</b> Container Hinget Lock		





	SEM NO.	REF. NO.	Type / Model
	1149		
	<b>Description</b> Trailer's Door Lock		

	SEM NO.	REF. NO.	Type / Model
	1180	SKE001370220	
	<b>Description</b> Lock Repair Kit		

	SEM NO.	REF. NO.	Type / Model
	1222	SKE001370020	
	<b>Description</b> Lock Repair Kit		

	SEM NO.	REF. NO.	Type / Model
	7979	SK1259	
	<b>Description</b> Rubber Cushion		

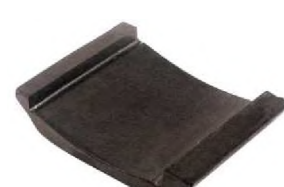
A=160 B=175 H=64

Type / Model	REF. NO.	SEM NO.	
	SK210525	7980	 <p><b>Description</b> Rubber Buffer</p> <p>A=105 B=114 H=16</p>
SK 1259- 2 pcs SK 2105-25- 2 pcs		8754	 <p><b>Description</b> Jost Repair Kit</p> <p>A=160 B=175 H=64 A=105 B=114 H=16</p>
	SK2006	9062	 <p><b>Description</b> Rubber Mounting</p> <p>A=230 B=190 h=66</p>
	SK2007	9063	 <p><b>Description</b> Rubber Mounting</p> <p>A=185 B=151 h=39</p>
	SK212169	10292	 <p><b>Description</b> Repair Kit</p>
	SK212115	10293	 <p><b>Description</b> Repair Kit</p>

	SEM NO.	REF. NO.	Type / Model
	<b>10294</b>	SK242178	
	<b>Description</b>		
	Repair Kit		
	SEM NO.	REF. NO.	Type / Model
	<b>10295</b>	SK242155	
	<b>Description</b>		
	Repair Kit		

## BPW GROUP



Engine and Transmission Group .....	:	-
Steering Group .....	:	1026
Suspension Group .....	:	1027 - 1053
Cab Group .....	:	-
Axle / Differential ve Shaft Group.....	:	-
Clutch and Brake Group.....	:	1054 - 1066





SEM NO.

12153



REF. NO.







99871001  
3727702







Type / Model







**Description**







Rubber Metal Bushing







D=Ø63 d=Ø20 h=72,5









<b>Type / Model</b>	<b>REF. NO.</b>	<b>SEM NO.</b>	 <b>Description</b> Spring Bushing D=Ø57 d=Ø30 h=102
	0203169000	7781	
<b>Type / Model</b>	<b>REF. NO.</b>	<b>SEM NO.</b>	 <b>Description</b> Spring Bushing D=Ø60 d=Ø30 h=72
	0203159800	8025	
<b>Type / Model</b>	<b>REF. NO.</b>	<b>SEM NO.</b>	 <b>Description</b> Spring Bushing D=Ø60 d=Ø30 h=102
	023160600	8026	
<b>Type / Model</b>	<b>REF. NO.</b>	<b>SEM NO.</b>	 <b>Description</b> Spring Bushing D=Ø60 d=Ø24 h=72
	0203142400	10253	
<b>Type / Model</b>	<b>REF. NO.</b>	<b>SEM NO.</b>	 <b>Description</b> Spring Bushing D=Ø59,5 d=Ø30 h=102
	0203160600	7971	
<b>Type / Model</b>	<b>REF. NO.</b>	<b>SEM NO.</b>	 <b>Description</b> Spring Bushing D=Ø100 d=Ø50 h=130
	0203166500 0203160500	7972	







 D=Ø50 d=Ø24 h=68	<table border="1"> <thead> <tr> <th>SEM NO.</th> <th>REF. NO.</th> <th>Type / Model</th> </tr> </thead> <tbody> <tr> <td>7975</td> <td>0511390060</td> <td></td> </tr> </tbody> </table> <p><b>Description</b> Spring Bushing</p>	SEM NO.	REF. NO.	Type / Model	7975	0511390060		<table border="1"> <thead> <tr> <th>SEM NO.</th> <th>REF. NO.</th> <th>Type / Model</th> </tr> </thead> <tbody> <tr> <td>7975</td> <td>0511390060</td> <td></td> </tr> </tbody> </table>	SEM NO.	REF. NO.	Type / Model	7975	0511390060	
SEM NO.	REF. NO.	Type / Model												
7975	0511390060													
SEM NO.	REF. NO.	Type / Model												
7975	0511390060													
 D=Ø65,5 d=Ø36 h=68	<table border="1"> <thead> <tr> <th>SEM NO.</th> <th>REF. NO.</th> <th>Type / Model</th> </tr> </thead> <tbody> <tr> <td>7976</td> <td>0511393030</td> <td></td> </tr> </tbody> </table> <p><b>Description</b> Spring Bushing</p>	SEM NO.	REF. NO.	Type / Model	7976	0511393030		<table border="1"> <thead> <tr> <th>SEM NO.</th> <th>REF. NO.</th> <th>Type / Model</th> </tr> </thead> <tbody> <tr> <td>7976</td> <td>0511393030</td> <td></td> </tr> </tbody> </table>	SEM NO.	REF. NO.	Type / Model	7976	0511393030	
SEM NO.	REF. NO.	Type / Model												
7976	0511393030													
SEM NO.	REF. NO.	Type / Model												
7976	0511393030													
 D=Ø84 d=Ø40 h=130	<table border="1"> <thead> <tr> <th>SEM NO.</th> <th>REF. NO.</th> <th>Type / Model</th> </tr> </thead> <tbody> <tr> <td>7977</td> <td>0511398080</td> <td></td> </tr> </tbody> </table> <p><b>Description</b> Spring Bushing</p>	SEM NO.	REF. NO.	Type / Model	7977	0511398080		<table border="1"> <thead> <tr> <th>SEM NO.</th> <th>REF. NO.</th> <th>Type / Model</th> </tr> </thead> <tbody> <tr> <td>7977</td> <td>0511398080</td> <td></td> </tr> </tbody> </table>	SEM NO.	REF. NO.	Type / Model	7977	0511398080	
SEM NO.	REF. NO.	Type / Model												
7977	0511398080													
SEM NO.	REF. NO.	Type / Model												
7977	0511398080													
 D=Ø105 d=Ø60 h=146	<table border="1"> <thead> <tr> <th>SEM NO.</th> <th>REF. NO.</th> <th>Type / Model</th> </tr> </thead> <tbody> <tr> <td>7978</td> <td>0511397100</td> <td></td> </tr> </tbody> </table> <p><b>Description</b> Spring Bushing</p>	SEM NO.	REF. NO.	Type / Model	7978	0511397100		<table border="1"> <thead> <tr> <th>SEM NO.</th> <th>REF. NO.</th> <th>Type / Model</th> </tr> </thead> <tbody> <tr> <td>7978</td> <td>0511397100</td> <td></td> </tr> </tbody> </table>	SEM NO.	REF. NO.	Type / Model	7978	0511397100	
SEM NO.	REF. NO.	Type / Model												
7978	0511397100													
SEM NO.	REF. NO.	Type / Model												
7978	0511397100													
 D=Ø24	<table border="1"> <thead> <tr> <th>SEM NO.</th> <th>REF. NO.</th> <th>Type / Model</th> </tr> </thead> <tbody> <tr> <td>10914</td> <td>0316435030</td> <td></td> </tr> </tbody> </table> <p><b>Description</b> Plate Sheet</p>	SEM NO.	REF. NO.	Type / Model	10914	0316435030		<table border="1"> <thead> <tr> <th>SEM NO.</th> <th>REF. NO.</th> <th>Type / Model</th> </tr> </thead> <tbody> <tr> <td>10914</td> <td>0316435030</td> <td></td> </tr> </tbody> </table>	SEM NO.	REF. NO.	Type / Model	10914	0316435030	
SEM NO.	REF. NO.	Type / Model												
10914	0316435030													
SEM NO.	REF. NO.	Type / Model												
10914	0316435030													
 D=Ø80 d=Ø15 h=80	<table border="1"> <thead> <tr> <th>SEM NO.</th> <th>REF. NO.</th> <th>Type / Model</th> </tr> </thead> <tbody> <tr> <td>9444</td> <td>0311390110</td> <td></td> </tr> </tbody> </table> <p><b>Description</b> Spring Bushing</p>	SEM NO.	REF. NO.	Type / Model	9444	0311390110		<table border="1"> <thead> <tr> <th>SEM NO.</th> <th>REF. NO.</th> <th>Type / Model</th> </tr> </thead> <tbody> <tr> <td>9444</td> <td>0311390110</td> <td></td> </tr> </tbody> </table>	SEM NO.	REF. NO.	Type / Model	9444	0311390110	
SEM NO.	REF. NO.	Type / Model												
9444	0311390110													
SEM NO.	REF. NO.	Type / Model												
9444	0311390110													
 M30x200	<table border="1"> <thead> <tr> <th>SEM NO.</th> <th>REF. NO.</th> <th>Type / Model</th> </tr> </thead> <tbody> <tr> <td>10222</td> <td>0334105030</td> <td></td> </tr> </tbody> </table> <p><b>Description</b> Spring Bolt</p>	SEM NO.	REF. NO.	Type / Model	10222	0334105030		<table border="1"> <thead> <tr> <th>SEM NO.</th> <th>REF. NO.</th> <th>Type / Model</th> </tr> </thead> <tbody> <tr> <td>10222</td> <td>0334105030</td> <td></td> </tr> </tbody> </table>	SEM NO.	REF. NO.	Type / Model	10222	0334105030	
SEM NO.	REF. NO.	Type / Model												
10222	0334105030													
SEM NO.	REF. NO.	Type / Model												
10222	0334105030													

Type / Model	REF. NO.	SEM NO.	
	0334105050	10262	 <b>Description</b> Spring Bolt M30x170
	0334105040	10266	 <b>Description</b> Spring Bolt M30x200
	0334015370 0334015310	10269	 <b>Description</b> Spring Bolt M30x3,5x265
	0334015270	10270	 <b>Description</b> Spring Bolt M30x3,5x190
	0334014200	10911	 <b>Description</b> Spring Bolt M24x170
	0326015010 0252208126 0252208182	10224	 <b>Description</b> Nut M30x3.5







	<b>SEM NO.</b>	<b>REF. NO.</b>	<b>Type / Model</b>
	10308	0252192310 0526054090 0526054100	
<b>Description</b>			
Nut			
M22x1,5			
	<b>SEM NO.</b>	<b>REF. NO.</b>	<b>Type / Model</b>
	10912	0326014130	
<b>Description</b>			
Nut			
M24			
	<b>SEM NO.</b>	<b>REF. NO.</b>	<b>Type / Model</b>
	10223	0311301340	
<b>Description</b>			
Bush			
	<b>SEM NO.</b>	<b>REF. NO.</b>	<b>Type / Model</b>
	10272	0311301460	
<b>Description</b>			
Bush			
	<b>SEM NO.</b>	<b>REF. NO.</b>	<b>Type / Model</b>
	10273	0311323010	
<b>Description</b>			
Slotted Bushing			
	<b>SEM NO.</b>	<b>REF. NO.</b>	<b>Type / Model</b>
	10279	0311301290	
<b>Description</b>			
Bush			

<b>Type / Model</b>	<b>REF. NO.</b>	<b>SEM NO.</b>	
	0311394100	<b>10282</b>	
		<b>Description</b>	
		Plastic Bearing	
			d=41 D=50 h=23
<b>Type / Model</b>	<b>REF. NO.</b>	<b>SEM NO.</b>	
	0300114860	<b>10271</b>	
		<b>Description</b>	
		Bush	
<b>Type / Model</b>	<b>REF. NO.</b>	<b>SEM NO.</b>	
	0318120080	<b>10276</b>	
		<b>Description</b>	
		Seperator Plate	
<b>Type / Model</b>	<b>REF. NO.</b>	<b>SEM NO.</b>	
	0331030490	<b>11962</b>	
		<b>Description</b>	
		Metal Bushing	
			D=Ø39 d=Ø30 H=25
<b>Type / Model</b>	<b>REF. NO.</b>	<b>SEM NO.</b>	
	0332032380	<b>10225</b>	
		<b>Description</b>	
		Washer	
			D=Ø58 d=Ø31 h=5
<b>Type / Model</b>	<b>REF. NO.</b>	<b>SEM NO.</b>	
	0332034530	<b>10264</b>	
		<b>Description</b>	
		Washer	

	SEM NO.	REF. NO.	Type / Model
 d=31 D=56 h=4	10280	0254013101	
	<b>Description</b>		
	Washer		
 d=31 D=45,5 h=6	10281	0332031270	
	<b>Description</b>		
	Washer		
 d=Ø25	10913	0332033280	
	<b>Description</b>		
	Spacer Ring		
 D=Ø55 d=Ø30 H=10	11961	 0332032410	
	<b>Description</b>		
	Metal Bushing		
 D=Ø36 d=Ø25 H=6	11963	 0332030410	
	<b>Description</b>		
	Metal Bushing		
 A=101 B=140 d=Ø56 h=4,5	10226	0328135160	
	<b>Description</b>		
	Metal Plate		

Type / Model	REF. NO.	SEM NO.	
	0328115030	10227	
		<b>Description</b>	
		Metal Sheet	
			A=105 B=105 d=Ø56 h=4,5
Type / Model	REF. NO.	SEM NO.	
	0328125060	10274	
		<b>Description</b>	
		Plate Sheet	
Type / Model	REF. NO.	SEM NO.	
	0328120080	10275	
		<b>Description</b>	
		Plate Sheet	
Type / Model	REF. NO.	SEM NO.	
	0316135070	10277	
		<b>Description</b>	
		Plate Holder	
Type / Model	REF. NO.	SEM NO.	
	0328154180	10263	
		<b>Description</b>	
		Spring Plate	
Type / Model	REF. NO.	SEM NO.	
	0328154140	10278	
		<b>Description</b>	
		Spring Plate	





	SEM NO.	REF. NO.	Type / Model
	10916	0328144250	
L1 = 25	<b>Description</b> Spring Plate		
	11960	 0328154200	
85x65 T=8	<b>Description</b> Metal Bushing		
	10265	0316435020	
d = Ø30	<b>Description</b> Plate Sheet		
	10267	0316435010	
d = Ø30	<b>Description</b> Plate Sheet		
	10914		
d = Ø24	<b>Description</b> Plate Sheet		
	10915	0316435040	
d = Ø24	<b>Description</b> Plate Sheet		





Type / Model	REF. NO.	SEM NO.	
	0518913190	10268	
		<b>Description</b>	
		Plate Sheet	

Description / Repair Kit For Spring	SEM NO.	Model:																
	<b>9160</b>	BERGISCHE ACHSEN																
	<b>REF. NO:</b> 0980106280	<table border="1"> <thead> <tr> <th>Item No</th> <th>Ref. No</th> </tr> </thead> <tbody> <tr> <td>1</td> <td>0334015270</td> </tr> <tr> <td>2</td> <td>0203160600</td> </tr> <tr> <td>3</td> <td>----</td> </tr> <tr> <td>4</td> <td>0326015010</td> </tr> <tr> <td>5</td> <td>----</td> </tr> <tr> <td>6</td> <td>0328135160</td> </tr> <tr> <td>7</td> <td>0328115030</td> </tr> </tbody> </table>	Item No	Ref. No	1	0334015270	2	0203160600	3	----	4	0326015010	5	----	6	0328135160	7	0328115030
	Item No	Ref. No																
	1	0334015270																
	2	0203160600																
	3	----																
	4	0326015010																
	5	----																
	6	0328135160																
7	0328115030																	

Description / Repair Kit For Spring	SEM NO.	Model:																
	<b>9161</b>	BERGISCHE ACHSEN																
	<b>REF. NO:</b> 0980106290	<table border="1"> <thead> <tr> <th>Item No</th> <th>Ref. No</th> </tr> </thead> <tbody> <tr> <td>1</td> <td>0334015270</td> </tr> <tr> <td>2</td> <td>0203160600</td> </tr> <tr> <td>3</td> <td>----</td> </tr> <tr> <td>4</td> <td>0326015010</td> </tr> <tr> <td>5</td> <td>----</td> </tr> <tr> <td>6</td> <td>0328135160</td> </tr> <tr> <td>7</td> <td>0328115030</td> </tr> </tbody> </table>	Item No	Ref. No	1	0334015270	2	0203160600	3	----	4	0326015010	5	----	6	0328135160	7	0328115030
	Item No	Ref. No																
	1	0334015270																
	2	0203160600																
	3	----																
	4	0326015010																
	5	----																
	6	0328135160																
7	0328115030																	

Description / Spring Repair Kit	SEM NO.	Model:
	<b>10254</b>	
	<b>REF. NO:</b> 0585700180	

Description / Spring Repair Kit	SEM NO.	Model:
	<b>10255</b>	
	<b>REF. NO:</b> 0585700150	

Model:	SEM NO.	Description / Spring Repair Kit
	10256	
	REF. NO: 0585700190	
	10257	
	REF. NO: 0585700120	
	10258	
	REF. NO: 0585700240	
	10283	
	REF. NO: 0980106870	

Description / Repair Kit	SEM NO.	Model:
	<b>10284</b>	
	<b>REF. NO:</b> 0585700090	

Description / Repair Kit	SEM NO.	Model:
	<b>10285</b>	
	<b>REF. NO:</b> 0585700030	









Description / Repair Kit	SEM NO.	Model:
	<b>10286</b>	
	<b>REF. NO:</b> 0980106920	

Description / Repair Kit	SEM NO.	Model:
	<b>10287</b>	
	<b>REF. NO:</b> 0980107020	

Model:	SEM NO.	Description / Repair Kit
	<b>10288</b>	
	<b>REF. NO:</b> 0980106770	
<b>Model:</b>	<b>SEM NO.</b>	<b>Description / Repair Kit</b>
	<b>10289</b>	
	<b>REF. NO:</b> 0585700130	
<b>Model:</b>	<b>SEM NO.</b>	<b>Description / Repair Kit</b>
	<b>10290</b>	
	<b>REF. NO:</b> 0980107030	
<b>Model:</b>	<b>SEM NO.</b>	<b>Description / Spring Repair Kit</b>
	<b>10837</b>	
	<b>REF. NO:</b> 0980106290S	
<b>Item No</b>	<b>Ref. No</b>	
1	0203169000	
2	0334015270	
3	0326015010	
4	-----	
5	0328115030	
6	0328135160	
7	-----	

Description / Spring Repair Kit	SEM NO.	Model:												
	<b>10909</b>													
	<b>REF. NO: 0585700280</b>													
		<table border="1"> <thead> <tr> <th>Item No</th> <th>Ref. No</th> </tr> </thead> <tbody> <tr> <td>1</td> <td>0334014200</td> </tr> <tr> <td>2</td> <td>0326014130</td> </tr> <tr> <td>3</td> <td>0332033280</td> </tr> <tr> <td>4</td> <td>0316435030</td> </tr> <tr> <td>5</td> <td>0328144250</td> </tr> </tbody> </table>	Item No	Ref. No	1	0334014200	2	0326014130	3	0332033280	4	0316435030	5	0328144250
Item No	Ref. No													
1	0334014200													
2	0326014130													
3	0332033280													
4	0316435030													
5	0328144250													

Description / Spring Repair Kit	SEM NO.	Model:												
	<b>10910</b>													
	<b>REF. NO: 0585700290</b>													
		<table border="1"> <thead> <tr> <th>Item No</th> <th>Ref. No</th> </tr> </thead> <tbody> <tr> <td>1</td> <td>0334014200</td> </tr> <tr> <td>2</td> <td>0326014130</td> </tr> <tr> <td>3</td> <td>0332033280</td> </tr> <tr> <td>4</td> <td>0316435040</td> </tr> <tr> <td>5</td> <td>0328144250</td> </tr> </tbody> </table>	Item No	Ref. No	1	0334014200	2	0326014130	3	0332033280	4	0316435040	5	0328144250
Item No	Ref. No													
1	0334014200													
2	0326014130													
3	0332033280													
4	0316435040													
5	0328144250													

<b>Type / Model</b>	<b>REF. NO.</b>		<b>SEM NO.</b>	
	0235060100		<b>11957</b>	
			<b>Description</b>	
			Rubber Metal Buffer	
				80x80 M12x1,75 H=30
<b>Type / Model</b>	<b>REF. NO.</b>		<b>SEM NO.</b>	
	0235060200		<b>11958</b>	
			<b>Description</b>	
			Rubber Metal Buffer	
				D=Ø82 M12x1,75 H=32
<b>Type / Model</b>	<b>REF. NO.</b>		<b>SEM NO.</b>	
	0235060600		<b>11959</b>	
			<b>Description</b>	
			Rubber Buffer	
				90x60 H=25
<b>Type / Model</b>	<b>REF. NO.</b>		<b>SEM NO.</b>	
	0314016010		<b>11664</b>	
			<b>Description</b>	
			Rubber Cover	
				A=120mm
<b>Type / Model</b>	<b>REF. NO.</b>		<b>SEM NO.</b>	
	0314014010		<b>11665</b>	
			<b>Description</b>	
			Rubber Cover	
				A=90mm
<b>Type / Model</b>	<b>REF. NO.</b>		<b>SEM NO.</b>	
	0334014250		<b>10415</b>	
			<b>Description</b>	
			Screw	
				M24x2x260



	SEM NO.	REF. NO.	Type / Model
	11362	0313830074	
	<b>Description</b>		
	Spring Bolt (U)		
M22x71x280			







	SEM NO.	REF. NO.	Type / Model
	11363	0313837024	
	<b>Description</b>		
	Spring Bolt (U)		
M22x128x290			

	SEM NO.	REF. NO.	Type / Model
	11364	0313841050	
	<b>Description</b>		
	Spring Bolt (U)		
M24x128x45			

	SEM NO.	REF. NO.	Type / Model
	11365	0313841064	
	<b>Description</b>		
	Spring Bolt (U)		
M24x128x365			

	SEM NO.	REF. NO.	Type / Model
	11366	0313841070	
	<b>Description</b>		
	Spring Bolt (U)		
M24x128x385			

	SEM NO.	REF. NO.	Type / Model
	11367	0313841084	
	<b>Description</b>		
	Spring Bolt (U)		
M24x128x320			

<b>Type / Model</b>	<b>REF. NO.</b>	<b>SEM NO.</b>	
	0313841134	11368	
		<b>Description</b>	
		Spring Bolt (U)	
			M24x128x300
<b>Type / Model</b>	<b>REF. NO.</b>	<b>SEM NO.</b>	
	0313841144	11369	
		<b>Description</b>	
		Spring Bolt (U)	
			M24x128x290
<b>Type / Model</b>	<b>REF. NO.</b>	<b>SEM NO.</b>	
	0313841164	11370	
		<b>Description</b>	
		Spring Bolt (U)	
			M24x128x310
<b>Type / Model</b>	<b>REF. NO.</b>	<b>SEM NO.</b>	
	0313841174	11371	
		<b>Description</b>	
		Spring Bolt (U)	
			M24x128x290
<b>Type / Model</b>	<b>REF. NO.</b>	<b>SEM NO.</b>	
	0313841194	11372	
		<b>Description</b>	
		Spring Bolt (U)	
			M24x128x280
<b>Type / Model</b>	<b>REF. NO.</b>	<b>SEM NO.</b>	
	0313841250	11373	
		<b>Description</b>	
		Spring Bolt (U)	
			M24x128x320

	SEM NO.	REF. NO.	Type / Model
	11374	0313841264	
	<b>Description</b>		
	Spring Bolt (U)		
M24x128x330			







	SEM NO.	REF. NO.	Type / Model
	11375	0313841334	
	<b>Description</b>		
	Spring Bolt (U)		
M24x128x285			

	SEM NO.	REF. NO.	Type / Model
	11376	0313841344	
	<b>Description</b>		
	Spring Bolt (U)		
M24x128x300			

	SEM NO.	REF. NO.	Type / Model
	11377	0313841374	
	<b>Description</b>		
	Spring Bolt (U)		
M24x128x300			

	SEM NO.	REF. NO.	Type / Model
	11378	0313844044	
	<b>Description</b>		
	Spring Bolt (U)		
M24x101x315			

	SEM NO.	REF. NO.	Type / Model
	11379	0313844084	
	<b>Description</b>		
	Spring Bolt (U)		
M24x101x280			

Type / Model	REF. NO.	SEM NO.	
	0313844090 0313844094	<b>11380</b> (11381)	 <b>Description</b> Spring Bolt (U) M24x101x308
Type / Model	REF. NO.	SEM NO.	
	0313844154	<b>11382</b>	 <b>Description</b> Spring Bolt (U) M24x101x320
Type / Model	REF. NO.	SEM NO.	
	0313844164	<b>11383</b>	 <b>Description</b> Spring Bolt (U) M24x101x292
Type / Model	REF. NO.	SEM NO.	
	0313844180 0313844184	<b>11384</b>	 <b>Description</b> Spring Bolt (U) M24x101x340
Type / Model	REF. NO.	SEM NO.	
	0313844194	<b>11385</b>	 <b>Description</b> Spring Bolt (U) M24x101x270
Type / Model	REF. NO.	SEM NO.	
	0313845030	<b>11386</b>	 <b>Description</b> Spring Bolt (U) M24x156x400

	SEM NO.	REF. NO.	Type / Model
	11387	0313845084	
	<b>Description</b>		
	Spring Bolt (U)		
M24x156x350			



	SEM NO.	REF. NO.	Type / Model
	11388	0313845074	
	<b>Description</b>		
	Spring Bolt (U)		
M24x156x360			



	SEM NO.	REF. NO.	Type / Model
	11764	 0326004190	
	<b>Description</b>		
	Nut		
M22x2,5			

	SEM NO.	REF. NO.	Type / Model
	11766	 0252207412	
	<b>Description</b>		
	Nut		
M24x3			

	SEM NO.	REF. NO.	Type / Model
	11765	 0254012307	
	<b>Description</b>		
	Metal Washer		
D=Ø39 d=Ø23 h=3			

	SEM NO.	REF. NO.	Type / Model
	11767	 0254012507	
	<b>Description</b>		
	Metal Washer		
D=Ø44 d=Ø25 h=4			

Type / Model	REF. NO.	SEM NO.	
	0511396050 0203160100	<b>7973</b>	 <b>Description</b> Spring Bushing D=Ø60 d=Ø30 h=68
Type / Model	REF. NO.	SEM NO.	
	0511396060 0511393020	<b>7974</b>	 <b>Description</b> Spring Bushing D=Ø52,5 d=Ø30 h=68

	SEM NO.	REF. NO.	Type / Model
 <p><b>Description</b> Shock Absorber</p>	<b>9597</b>	0237221400 SACHS112923 SACHS123868 MONROEF5073	OPEN LENGTH=500 CLOSED LENGTH=328 UPPER MOUNT DIMENSION=24x55 LOWER MOUNT DIMENSION=24x55
 <p><b>Description</b> Shock Absorber</p>	<b>9605</b>	0237029200 SACHS112925	OPEN LENGTH=540 CLOSED LENGTH=350 UPPER MOUNT DIMENSION=24x55 LOWER MOUNT DIMENSION=24x55
 <p><b>Description</b> Shock Absorber</p>	<b>9607</b>	0237022000 SACHS 170178	OPEN LENGTH=695 CLOSED LENGTH=425 UPPER MOUNT DIMENSION=24x55 LOWER MOUNT DIMENSION=24x55
 <p><b>Description</b> Shock Absorber</p>	<b>11454</b>	0237228300 SACHS312561 MONROEF5083 MONROEF5005	OPEN LENGTH=495 CLOSED LENGTH=325 UPPER MOUNT DIMENSION=24x55 LOWER MOUNT DIMENSION=24x55
 <p><b>Description</b> Metal Shock Absorber</p>	<b>11505</b>	0237021000 SACHS 106201 MONROE F5002	OPEN LENGTH=801 CLOSED LENGTH=478 UPPER MOUNT DIMENSION=24x55 LOWER MOUNT DIMENSION=24x55



Technical Specification	REF. NO.		SEM NO.		
Total Weight 12,2 kg	0542943410 (36 K)	CONTITECH4881 NP30 FIRESTONEW01-M58-8666 PHOENIX1 DK 32 K-2 GOODYEAR1R14-757 VIBRACOUSTICV1DK32K Y10 GY SPRINGRIDED14B44 FIRESTONE1T66F-7.0	<b>72.4881.CP</b>	<b>Description</b> Plastic Piston	
Total Weight 6,2 kg	542941010	CONTITECH4881 NP02 GOODYEAR1R14-701 PHOENIX1 DK 32 K GY SPRINGRIDED14U37 VIBRACOUSTICV1DK32K CF GOMMA REF.1TC360-40 FIRESTONE1T66D-7 CF GOMMA NO.205537	<b>72.4881.S02</b>	<b>Description</b> Service Assembly	
Total Weight 4,5 kg	0542941560	CONTITECH4940 N P02 GY SPRINGRIDED11U42 GOODYEAR1R11-799 TYPE 30 K	<b>72.4940.S02</b>	<b>Description</b> Service Assembly	
Total Weight 7,8 kg	0542943250	CONTITECH4941 MB	<b>72.4941.C</b>	<b>Description</b> Metal Piston	
Total Weight 5 kg	0542941250	CONTITECH4941 N P02 GART NO.293.0.513 GOODYEAR1R11-802 GART REF.C293 GY SPRINGRIDED11U45 TYPE 30	<b>72.4941.S02</b>	<b>Description</b> Service Assembly	
Total Weight 7,7 kg	0542941090	CONTITECH4942 N P02 GART REF.C293 GART NO.293.0.514 TYPE 36-2	<b>72.4942.S02</b>	<b>Description</b> Service Assembly	



	<b>SEM NO.</b>  72.4960.S02	<b>REF. NO.</b>  0542941770	<b>Technical Specification</b>  CONTITECH4960 N P02 GY SPRINGRIDED11U44 PHOENIX1 DK 21 K-3 GART NO.293.0.412 VIBRACOUSTICV1DK21K-3 GART REF.C292/A GOODYEAR1R11-801 TYPE 30 K	<b>Total Weight</b> 4,5 kg
	<b>SEM NO.</b>  72.4961.S02	<b>REF. NO.</b>  0542942040	<b>Technical Specification</b>  CONTITECH4961 N P02 GART NO.292.0.414 GOODYEAR1R11-800 GART REF.C292/A GY SPRINGRIDED11U43 TYPE 30 K	<b>Total Weight</b> 4,7 kg
	<b>SEM NO.</b>  72.4962.S02	<b>REF. NO.</b>  0542942030	<b>Technical Specification</b>  CONTITECH4962 N P02 GY SPRINGRIDED11U46 GOODYEAR1R11-803 TYPE 30	<b>Total Weight</b> 5,1 kg
	<b>SEM NO.</b>  72.644.R	<b>REF. NO.</b>  0220024400	<b>Technical Specification</b>  CONTITECH644 N GY SPRINGRIDED11S01 PHOENIX1 E 21 CF GOMMA REF.1S285-24 TaurusBL121 CF GOMMA NO.92574 VIBRACOUSTICV1E21 DUNLOP UKPNP301470102	<b>Total Weight</b> 1,4 kg
	<b>SEM NO.</b>  72.719.R	<b>REF. NO.</b>  CONTITECH719 N GOODYEAR8118 PHOENIX1 F 32 B CF GOMMA REF.1SC360 43 VIBRACOUSTICV1F32B CF GOMMA NO.92593 FIRESTONE1R2D530 360 DUNLOP UKPNP304620101 FIRESTONEW01 095 0192 SMB	<b>Technical Specification</b>  CONTITECH719 N GOODYEAR8118 PHOENIX1 F 32 B CF GOMMA REF.1SC360 43 VIBRACOUSTICV1F32B CF GOMMA NO.92593 FIRESTONE1R2D530 360 DUNLOP UKPNP304620101 FIRESTONEW01 095 0192 SMB	<b>Total Weight</b> 2,8 kg
	<b>SEM NO.</b>  72.720.R	<b>REF. NO.</b>  0220024100	<b>Technical Specification</b>  CONTITECH 720 N FIRESTONEW01-095-0195 PHOENIX1 F 21 GOODYEAR9008 VIBRACOUSTICV1F21 GY SPRINGRIDED12S04 FIRESTONE1R2A460-295 CF GOMMA REF.1SC290-30	<b>Total Weight</b> 1,2 kg

Technical Specification	REF. NO.	SEM NO.			
Total Weight 2,3 kg	0220024200	CONTITECH762 N GOODYEAR9010 PHOENIX1 F 32 GY SPRINGRIDED13S02 VIBRACOUSTICV1F32 CF GOMMA REF.1SC360 30 FIRESTONE1R2D390 360 CF GOMMA NO.92594 FIRESTONEW01 095 0190	<b>72.762.R</b>	<b>Description</b> Roll	
Total Weight 5 kg	0220024700	CONTITECH775 N Gigant196038 k6gel4731040000	<b>72.775.R</b>	<b>Description</b> Roll	
Total Weight 17,5 kg	0542940081 0542940540 0542841361	CONTITECH881 MB PHOENIX1 DK 32 1 FIRESTONE1T66F 10.8 DunlopD14B36 FIRESTONEW01 M58 8966 GOODYEAR1R14 712	<b>72.881.C</b>	<b>Description</b> Metal Piston	
Total Weight 13,5 kg	0542943510	CONTITECH881 MB P30 PHOENIX1 DK 32-2 VIBRACOUSTICV1DK32 Y9 FIRESTONE1T66F-10.8 FIRESTONEW01-M58-8667 GOODYEAR1R14-748 GY SPRINGRIDED14B41 TYPE 36	<b>72.881.CP</b>	<b>Description</b> Plastic Piston	
Total Weight 6,5 kg	CONTITECH881 MB GOODYEAR1R14-708 PHOENIX1 DK 32 GY SPRINGRIDED14U36 VIBRACOUSTICV1DK32 CF GOMMA REF.1TC360-45 FIRESTONE1T66D-10.8 CF GOMMA NO.204530	FIRESTONEW01-M58-8978 GART NO.292.0.531 GART REF.C292 542940010 TYPE 36	<b>72.881.S</b>	<b>Description</b> Service Assembly	
Total Weight 11,5 kg	0542941141 0542942191 0542941231	CONTITECH940 MB SPRINGRIDED11B39 FIRESTONE1T17D-4.3 GOODYEAR1R11-763 FIRESTONEW01 M58 8609	<b>72.940.C</b>	<b>Description</b> Metal Piston	



	<p><b>SEM NO.</b> <b>72.940.CP</b></p> <p><b>Description</b> Plastic Piston</p>	<p><b>REF. NO.</b> 0542943210</p>	<p><b>Technical Specification</b></p> <p>CONTITECH940 MB P30 FIRESTONE1T17D-4.3 PHOENIX1 DK 21 K-2 FIRESTONEW01-M58-8585 VIBRACOUSTICV1DK21K Y4 GOODYEAR1R11-752</p>	<p><b>Technical Specification</b></p> <p>Total Weight 8,4 kg</p>
	<p><b>SEM NO.</b> <b>72.940.S</b></p> <p><b>Description</b> Service Assembly</p>	<p><b>REF. NO.</b> 0542940910</p>	<p><b>Technical Specification</b></p> <p>CONTITECH940 MB GY SPRINGRIDED11U31 PHOENIX1 DK 21 K CF GOMMA REF.1TC300-30 VIBRACOUSTICV1DK21K CF GOMMA NO.205536 FIRESTONE1T17D-4.3 GART NO.293.0.411 GOODYEAR1R11-703</p>	<p><b>Technical Specification</b></p> <p>Total Weight 4,4 kg</p>
	<p><b>SEM NO.</b> <b>72.941.C</b></p> <p><b>Description</b> Metal Piston</p>	<p><b>REF. NO.</b> 0542940281 0542940591 0542941241</p>	<p><b>Technical Specification</b></p> <p>CONTITECH941 MB TAURUSKR 730 01 FIRESTONE1T17D 8.3 DUNLOPD11B38 FIRESTONEW01 M58 8619 GOODYEAR1R11 762 PHOENIX1 DK 21</p>	<p><b>Technical Specification</b></p> <p>Total Weight 12,3 kg</p>
	<p><b>SEM NO.</b> <b>72.941.CP</b></p> <p><b>Description</b> Plastic Piston</p>	<p><b>REF. NO.</b> 0542943200</p>	<p><b>Technical Specification</b></p> <p>CONTITECH941 MB P30 FIRESTONEW01-M58-8618 PHOENIX1 DK 21-2 GOODYEAR1R11-743 VIBRACOUSTICV1DK21Y1 GY SPRINGRIDED11B33 FIRESTONE1T17D-8.3</p>	<p><b>Technical Specification</b></p> <p>Total Weight 9,4 kg</p>
	<p><b>SEM NO.</b> <b>72.941.S</b></p> <p><b>Description</b> Service Assembly</p>	<p><b>REF. NO.</b> 542940030</p>	<p><b>Technical Specification</b></p> <p>CONTITECH941 MB GY SPRINGRIDED11U30 PHOENIX1 DK 21 CF GOMMA REF.1TC300-36 VIBRACOUSTICV1DK21 CF GOMMA NO.204466 FIRESTONE1T17D-8.3 GART NO.293.0.511</p>	<p><b>Technical Specification</b></p> <p>Total Weight 5 kg</p>
	<p><b>SEM NO.</b> <b>72.942.C1</b></p> <p><b>Description</b> Metal Piston</p>	<p><b>REF. NO.</b> 0542941690</p>	<p><b>Technical Specification</b></p> <p>CONTITECH942 MB FIRESTONEW01 M58 8584 FIRESTONE1T66F-13.5 GOODYEAR1R14-781</p>	<p><b>Technical Specification</b></p> <p>Total Weight 18,7 kg</p>

Technical Specification	REF. NO.		SEM NO.		
Total Weight 6,7 kg	0542940050	CONTITECH942 MB FIRESTONE1T66D13.5 PHOENIX1 DK 32 L FIRESTONEW01-M58-8611 VIBRACOUSTICV1DK32L GOODYEAR1R14-700	<b>72.942.S</b>	<b>Description</b> Service Assembly	
Technical Specification	REF. NO.		SEM NO.		
Total Weight 1,1 kg	0220020500	CONTITECH608 N FIRESTONE20 PHOENIX2 B 20 R FIRESTONEW01-R58-4088 VIBRACOUSTICV2B20R GOODYEAR2B12-425/300 Granning15923	<b>72.2285.M01</b>	<b>Description</b> Convulated Air Spring	

SEM NO.		REF. NO.	Type / Model
12826		0517465130	
 <p><b>Description</b> Brake Slack Adjuster, Manuel</p>			
Ø 14x120/135/150/165/180/195/20x0°/19' LOCK			



SEM NO.		REF. NO.	Type / Model
12831		0517452610	
 <p><b>Description</b> Brake Slack Adjuster, Manuel</p>			
Ø14x120/150/180/220/250x0°/ 19' LOCK			



SEM NO.		REF. NO.	Type / Model
12833		0557482932	0557482552
		0517482633	0517482220
		0557482872	0557482430
		0517482632	0517482212
		0557482682	0557482220
		0517482492	0517482210
		0557482652	0557482190
		0517482222	0517482022
 <p><b>Description</b> Brake Slack Adjuster, Automatic</p>			
Ø14x250/180/165/150/135/120x5°			

SEM NO.		REF. NO.	Type / Model
12850		0517490200	
 <p><b>Description</b> Brake Slack Adjuster, Automatic-Right</p>			
Ø 14x145x0°			

SEM NO.		REF. NO.	Type / Model
12863		0517452340	
 <p><b>Description</b> Brake Slack Adjuster, Manuel</p>			
Ø 14x120/150/180x0° / 19' LOCK			













SEM NO.		REF. NO.	Type / Model
12864		0517454700	
 <p><b>Description</b> Brake Slack Adjuster, Manuel-Right</p>			
Ø 14x145x0° / 19' LOCK			













Type / Model	REF. NO.		SEM NO.	
	0517454690		12865	 <b>Description</b> Brake Slack Adjuster, Manuel-Left Ø 14x145x0° / 19' LOCK
		<i>new product</i>		
Type / Model	REF. NO.		SEM NO.	
	0517482312	0557482200	0517482240	 <b>Description</b> Brake Slack Adjuster, Automatic Ø 14x250/180/165/150/135/120x110°
	0517482470	0517482122	0517482562	
	0517482031	0557482440	0517482242	
	0517482472	0517482140	0557482031	
	0517482120	0557482442	0517482310	
	0517482562	0517482142		
	0517482032	0557482672		
		<i>new product</i>	12876	
Type / Model	REF. NO.		SEM NO.	
	0557482873		12877	 <b>Description</b> Brake Slack Adjuster, Automatic Ø 14x250/180/165/150/135/120x0°
	0517482392			
		<i>new product</i>		













	SEM NO.	REF. NO.	Type / Model
	<b>10683</b>	0980102630	KN TYPE All SB 5..., SB 6..., SB 7..., SN 5... Series
<p><b>Description</b></p> <p>Caliper Repair Kit</p>			
	<b>10684</b>	0980106320	KN TYPE NA 7027, NA 7028, NA 7037, NA 7038, NA 75..., SK 7..., SN 65..., SN 66..., SN 7..., SN 71..., SN 72..., SN 73.. Series
<p><b>Description</b></p> <p>Caliper Repair Kit</p>			
	<b>10690</b>	0980106330	KN TYPE / IVECO TYPE SN 6529, SN 6539, SN 7067, SN 7077 SN 7084, SN 7094, SN 7086, SN 7096 SN 7106, SN 7116, SN 7125, SN 7135 SN 7144, SN 7154, NA 7027, NA 7028 NA 7038, SK 7..., SN 65..., SN 66..., SN 7..., SN 71..., SN 72..., SN 73.. Series
<p><b>Description</b></p> <p>Caliper Repair Kit</p>			





	<b>SEM NO.</b> 12059		<b>REF. NO.</b> 1230100101	<b>Type / Model</b>
	<b>Description</b> Bushing			
	<b>SEM NO.</b> 12091		<b>REF. NO.</b> 0311314030	<b>Type / Model</b>
	<b>Description</b> Bushing			
	<b>SEM NO.</b> 12090		<b>REF. NO.</b> 0311314010	<b>Type / Model</b>
	<b>Description</b> Bushing			
	<b>SEM NO.</b> 12082		<b>REF. NO.</b> 0322902090	<b>Type / Model</b>
	<b>Description</b> Metal Bushing			
	<b>SEM NO.</b> 12083		<b>REF. NO.</b> 0322902100	<b>Type / Model</b>
	<b>Description</b> Metal Bushing			
	<b>SEM NO.</b> 12086		<b>REF. NO.</b> 0322902160	<b>Type / Model</b>
	<b>Description</b> Metal Bushing			

<b>Type / Model</b>	<b>REF. NO.</b>		<b>SEM NO.</b>	
	0322902170		<b>12087</b>	
			<b>Description</b>	
			Metal Bushing	
<b>Type / Model</b>	<b>REF. NO.</b>		<b>SEM NO.</b>	
	0322902180		<b>12088</b>	
			<b>Description</b>	
			Metal Bushing	
<b>Type / Model</b>	<b>REF. NO.</b>		<b>SEM NO.</b>	
	0322902190		<b>12089</b>	
			<b>Description</b>	
			Metal Bushing	
<b>Type / Model</b>	<b>REF. NO.</b>		<b>SEM NO.</b>	
	0322902161		<b>12097</b>	
			<b>Description</b>	
			Metal Bushing	
<b>Type / Model</b>	<b>REF. NO.</b>		<b>SEM NO.</b>	
	0322902010		<b>12084</b>	
			<b>Description</b>	
			Metal Bushing	
<b>Type / Model</b>	<b>REF. NO.</b>		<b>SEM NO.</b>	
	0322902030		<b>12085</b>	
			<b>Description</b>	
			Metal Bushing	

	<b>SEM NO.</b>		<b>REF. NO.</b>	<b>Type / Model</b>
	12061		1230014400	
	<b>Description</b>			
	Bushing			
	<b>SEM NO.</b>		<b>REF. NO.</b>	<b>Type / Model</b>
	12092		0311244300 0311244340 0311244220 0311244120	
	<b>Description</b>			
	Bushing			
	<b>SEM NO.</b>		<b>REF. NO.</b>	<b>Type / Model</b>
	12093		0312063010 0312043090	
	<b>Description</b>			
	Bushing			
	<b>SEM NO.</b>		<b>REF. NO.</b>	<b>Type / Model</b>
	12094		0312043100	
	<b>Description</b>			
	Bushing			
	<b>SEM NO.</b>		<b>REF. NO.</b>	<b>Type / Model</b>
	12095		0312043140	
	<b>Description</b>			
	Bushing			
	<b>SEM NO.</b>		<b>REF. NO.</b>	<b>Type / Model</b>
	12096		0312043120	
	<b>Description</b>			
	Bushing			

Model:	SEM NO.	Description / Repair Kit																								
	12062																									
	REF. NO: 0980100140																									
	12063																									
	REF. NO: 0980100141																									
	12064																									
	REF. NO: 0980100142																									
	12065																									
	REF. NO:																									
<table border="1"> <thead> <tr> <th>Item No</th> <th>Ref. No</th> </tr> </thead> <tbody> <tr><td>1</td><td>1072001701</td></tr> <tr><td>2</td><td>0311314010</td></tr> <tr><td>3</td><td>----</td></tr> <tr><td>4</td><td>----</td></tr> <tr><td>5</td><td>0335030020</td></tr> <tr><td>6</td><td>0268500102</td></tr> <tr><td>7</td><td>0322902090</td></tr> <tr><td>8</td><td>0322902100</td></tr> <tr><td>9</td><td>0311244300</td></tr> <tr><td>10</td><td>0312063010</td></tr> <tr><td>11</td><td>0252021280</td></tr> </tbody> </table>	Item No	Ref. No	1	1072001701	2	0311314010	3	----	4	----	5	0335030020	6	0268500102	7	0322902090	8	0322902100	9	0311244300	10	0312063010	11	0252021280		
Item No	Ref. No																									
1	1072001701																									
2	0311314010																									
3	----																									
4	----																									
5	0335030020																									
6	0268500102																									
7	0322902090																									
8	0322902100																									
9	0311244300																									
10	0312063010																									
11	0252021280																									

Description / Repair Kit	SEM NO.	Model:																							
	12066	<i>new product</i>																							
	REF. NO:	<table border="1"> <thead> <tr> <th>Item No</th> <th>Ref. No</th> </tr> </thead> <tbody> <tr><td>1</td><td>1072001701</td></tr> <tr><td>2</td><td>0311314010</td></tr> <tr><td>3</td><td>0250253082</td></tr> <tr><td>4</td><td>0252021280</td></tr> <tr><td>5</td><td>0268500102</td></tr> <tr><td>6</td><td>0322902090</td></tr> <tr><td>7</td><td>0322902100</td></tr> <tr><td>8</td><td>0311244300</td></tr> <tr><td>9</td><td>0312043090</td></tr> <tr><td>10</td><td>0312043100</td></tr> <tr><td>11</td><td>0256010890</td></tr> </tbody> </table>	Item No	Ref. No	1	1072001701	2	0311314010	3	0250253082	4	0252021280	5	0268500102	6	0322902090	7	0322902100	8	0311244300	9	0312043090	10	0312043100	11
Item No	Ref. No																								
1	1072001701																								
2	0311314010																								
3	0250253082																								
4	0252021280																								
5	0268500102																								
6	0322902090																								
7	0322902100																								
8	0311244300																								
9	0312043090																								
10	0312043100																								
11	0256010890																								

Description / Repair Kit	SEM NO.	Model:																							
	12067	<i>new product</i>																							
	REF. NO:	<table border="1"> <thead> <tr> <th>Item No</th> <th>Ref. No</th> </tr> </thead> <tbody> <tr><td>1</td><td>1072001701</td></tr> <tr><td>2</td><td>0311314010</td></tr> <tr><td>3</td><td>0250253082</td></tr> <tr><td>4</td><td>0252021280</td></tr> <tr><td>5</td><td>0268500102</td></tr> <tr><td>6</td><td>0322902090</td></tr> <tr><td>7</td><td>0322902100</td></tr> <tr><td>8</td><td>0311244340</td></tr> <tr><td>9</td><td>0312043090</td></tr> <tr><td>10</td><td>0312043100</td></tr> <tr><td>11</td><td>0256010890</td></tr> </tbody> </table>	Item No	Ref. No	1	1072001701	2	0311314010	3	0250253082	4	0252021280	5	0268500102	6	0322902090	7	0322902100	8	0311244340	9	0312043090	10	0312043100	11
Item No	Ref. No																								
1	1072001701																								
2	0311314010																								
3	0250253082																								
4	0252021280																								
5	0268500102																								
6	0322902090																								
7	0322902100																								
8	0311244340																								
9	0312043090																								
10	0312043100																								
11	0256010890																								

Description / Repair Kit	SEM NO.	Model:
	12068	<i>new product</i>
	REF. NO:	0980102220

Description / Repair Kit	SEM NO.	Model:
	12069	<i>new product</i>
	REF. NO:	0980100242



Model:	SEM NO.	Description / Repair Kit
	12070	<p>REF. NO: 0980102130 0980102140</p>
	12071	<p>REF. NO: 0980102150</p>
	12072	<p>REF. NO: 0980100430</p>
	12073	<p>REF. NO: 0980106090S</p>

Item No	Ref. No
1	1072001701
2	0322902180
3	0311244340
4	0332011161
5	0312042020
6	0312043140
7	0326014080
8	0331012240
9	-----
10	0331081020

Description / Repair Kit	SEM NO.	Model:
	12074	<i>new product</i>
	REF. NO:	0980106090

Description / Repair Kit	SEM NO.	Model:
	12075	<i>new product</i>
	REF. NO:	0980100370

Description / Repair Kit	SEM NO.	Model:
	12076	<i>new product</i>
	REF. NO:	0980102160

Description / Repair Kit	SEM NO.	Model:																						
	12077	<i>new product</i>																						
	REF. NO:	0311244300S																						
	<table border="1"> <thead> <tr> <th>Item No</th> <th>Ref. No</th> </tr> </thead> <tbody> <tr><td>1</td><td>1072001701</td></tr> <tr><td>2</td><td>0322902030</td></tr> <tr><td>3</td><td>0312063010</td></tr> <tr><td>4</td><td>0311244300</td></tr> <tr><td>5</td><td>0311314010</td></tr> <tr><td>6</td><td>0335030020</td></tr> <tr><td>7</td><td>0331081020</td></tr> <tr><td>8</td><td>0250253082</td></tr> <tr><td>9</td><td>0252021280</td></tr> <tr><td>10</td><td>256010890</td></tr> <tr><td>11</td><td>0268500102</td></tr> </tbody> </table>	Item No	Ref. No	1	1072001701	2	0322902030	3	0312063010	4	0311244300	5	0311314010	6	0335030020	7	0331081020	8	0250253082	9	0252021280	10	256010890	11
Item No	Ref. No																							
1	1072001701																							
2	0322902030																							
3	0312063010																							
4	0311244300																							
5	0311314010																							
6	0335030020																							
7	0331081020																							
8	0250253082																							
9	0252021280																							
10	256010890																							
11	0268500102																							

Model:		SEM NO.	Description / Repair Kit																						
<p><b>new product</b></p> <table border="1"> <thead> <tr> <th>Item No</th> <th>Ref. No</th> </tr> </thead> <tbody> <tr><td>1</td><td>1072001701</td></tr> <tr><td>2</td><td>0311314010</td></tr> <tr><td>3</td><td>0331081020</td></tr> <tr><td>4</td><td>0312042020</td></tr> <tr><td>5</td><td>0331032090</td></tr> <tr><td>6</td><td>0256773742</td></tr> <tr><td>7</td><td>0256792300</td></tr> <tr><td>8</td><td>0256760100</td></tr> <tr><td>9</td><td>0256160590</td></tr> <tr><td>10</td><td>0326014080</td></tr> </tbody> </table>		Item No	Ref. No	1	1072001701	2	0311314010	3	0331081020	4	0312042020	5	0331032090	6	0256773742	7	0256792300	8	0256760100	9	0256160590	10	0326014080	12078	
		Item No	Ref. No																						
		1	1072001701																						
		2	0311314010																						
		3	0331081020																						
		4	0312042020																						
		5	0331032090																						
		6	0256773742																						
		7	0256792300																						
		8	0256760100																						
9	0256160590																								
10	0326014080																								
REF. NO:																									

Model:		SEM NO.	Description / Repair Kit
<p><b>new product</b></p>		12079	
		REF. NO: 0980102230	

Model:		SEM NO.	Description / Repair Kit
<p><b>new product</b></p>		12080	
		REF. NO: 0980100431	

Model:		SEM NO.	Description / Repair Kit
<p><b>new product</b></p>		12081	
		REF. NO: 0980106091	



Description / Repair Kit	SEM NO.	Model:
--------------------------	---------	--------

12119



REF. NO: 9900000093



Description / Repair Kit	SEM NO.	Model:
--------------------------	---------	--------

12124



REF. NO: 9900000071



Description / Repair Kit	SEM NO.	Model:
--------------------------	---------	--------

12125



REF. NO: 9900000088



# SAF GROUP



Engine and Transmission Group .....	:	-
Steering Group .....	:	1068
Suspension Group .....	:	1069 - 1082
Cab Group .....	:	-
Axle / Differential ve Shaft Group.....	:	-
Clutch and Brake Group.....	:	1083 - 1099



**SEM NO.**

**REF. NO.**

**Type / Model**







**10140**

2205000400

**Description**

Rod End

M38x1.5 RHT L=135

<b>Type / Model</b>	<b>REF. NO.</b>	<b>SEM NO.</b>	
	4177301000	7787	
		<b>Description</b>	
		Spring Bushing	
			D=Ø68 d=Ø30 h=104
<b>Type / Model</b>	<b>REF. NO.</b>	<b>SEM NO.</b>	
	4177301600	7976	
		<b>Description</b>	
		Spring Bushing	
			D=Ø65,5 d=Ø36 h=68
<b>Type / Model</b>	<b>REF. NO.</b>	<b>SEM NO.</b>	
		11753	
		<b>Description</b>	
		Rubber Metal Bushing	
			D=Ø62 d=Ø30 h=79
<b>Type / Model</b>	<b>REF. NO.</b>	<b>SEM NO.</b>	
	4177002000	8121	
		<b>Description</b>	
		Spring Eye Bushing	
			D=Ø62 d=Ø20 h=102
<b>Type / Model</b>	<b>REF. NO.</b>	<b>SEM NO.</b>	
	4177302800	9401	
		<b>Description</b>	
		Rubber Buffer	
			D=Ø155 d=Ø31,5 h=114
<b>Type / Model</b>	<b>REF. NO.</b>	<b>SEM NO.</b>	
	4177302600	9402	
		<b>Description</b>	
		Rubber Buffer	
			D=Ø152 d=Ø31,5 h=171

	SEM NO.	REF. NO.	Type / Model
 M30x3.5x205	10242	04343104888	
	<b>Description</b> Spring Bolt		











	SEM NO.	REF. NO.	Type / Model
 M30x3,5x265	10269	4343008088	
	<b>Description</b> Spring Bolt		



	SEM NO.	REF. NO.	Type / Model
 M30x3,5x265	12968	4343205510	
	<b>Description</b> Spring Bolt		

	SEM NO.	REF. NO.	Type / Model
 M30x3.5	10224 (10243)	04247402280	
	<b>Description</b> Nut		

	SEM NO.	REF. NO.	Type / Model
 M22x1,5	10308	4247301200 4247301201	
	<b>Description</b> Nut		

	SEM NO.	REF. NO.	Type / Model
 M22x1,5	12969	4342004710	
	<b>Description</b> Nut		

<b>Type / Model</b>	<b>REF. NO.</b>		<b>SEM NO.</b>	
	01331501201 1331501201		<b>10244</b>	
			<b>Description</b>	
			Metal Plate	
				d=30 80x130
<b>Type / Model</b>	<b>REF. NO.</b>		<b>SEM NO.</b>	
	01022100302 1022100302		<b>10245</b>	
			<b>Description</b>	
			Metal Plate	
				d=30 85x130
<b>Type / Model</b>	<b>REF. NO.</b>		<b>SEM NO.</b>	
	4405207100		<b>12962</b>	
			<b>Description</b>	
			U Metal-sheet (Spring)	
				L=145 d=Ø31
<b>Type / Model</b>	<b>REF. NO.</b>		<b>SEM NO.</b>	
	1101200100		<b>12963</b>	
			<b>Description</b>	
			Distance washer	
				d=Ø31 h=20
<b>Type / Model</b>	<b>REF. NO.</b>		<b>SEM NO.</b>	
	1123000101		<b>12964</b>	
			<b>Description</b>	
			Distance washer	
				d=Ø31 h=20
<b>Type / Model</b>	<b>REF. NO.</b>		<b>SEM NO.</b>	
	4101200200		<b>12970</b>	
			<b>Description</b>	
			Distance washer	
				d=Ø23 h=38

	SEM NO.	REF. NO.	Type / Model
 <p>d=Ø23 h=38</p>	12971	4123000200	
	<p><b>Description</b> Distance washer</p>		
	12972	1331019500	
	<p><b>Description</b> Washer</p>		
 <p>D=Ø170 d=Ø60 h=5</p>	10907	4331502900	
	<p><b>Description</b> Spacer Ring</p>		

Model:	SEM NO.	Description / Repair Kit For Spring
SAUER ACHSEN	<b>9162</b>	
<b>Item No</b>	<b>Ref. No</b>	<b>REF. NO:</b>
1	4343104888	3341104819
2	4247402280	
3		



Model:	SEM NO.	Description / Repair Kit For Spring
SAUER ACHSEN	<b>9163</b>	
<b>Item No</b>	<b>Ref. No</b>	<b>REF. NO:</b>
1	4177301000	3434364300
2	----	
3	----	
4	----	
5	----	

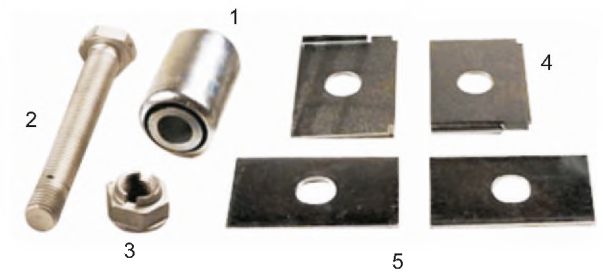

Model:	SEM NO.	Description / Repair Kit For Spring
SAUER ACHSEN	<b>9164</b>	
<b>Item No</b>	<b>Ref. No</b>	<b>REF. NO:</b>
1	4405207100	3434364400
2	4177301000	
3	4343105388	
4	4247402280	
5		



Model:	SEM NO.	Description / Repair Kit For Spring
	<b>12960</b>	
		<b>REF. NO:</b>
		3434364500





**Description / Repair Kit (Spring)**      **SEM NO.**      **Model:**

12961



REF. NO:  
3143100600



**Description / Repair Kit (Spring)**      **SEM NO.**      **Model:**

12965



REF. NO:  
4177302800S

Item No	Ref. No
1	4177302800
2	4331502900
3	4343104888
4	4247402280
5	1101200100
6	1123000101



**Description / Repair Kit (Spring)**      **SEM NO.**      **Model:**

12966



REF. NO:  
3434366100



**Description / Repair Kit (Spring)**      **SEM NO.**      **Model:**



12967



REF. NO:  
4177302600S

Item No	Ref. No
1	4177302600
2	4331502900
3	4343205510
4	4342004710
5	4101200200
6	4123000200
7	1331019500



Type / Model	REF. NO.	SEM NO.	
	1402002000	11390	
			<b>Description</b> Spring Bolt (U) M24x136x307
Type / Model	REF. NO.	SEM NO.	
	3401002000	11392	
			<b>Description</b> Spring Bolt (U) M24x136x302



**SEM NO.**

**REF. NO.**

**Type / Model**

7946

1230004700

**Description**

Bearing

D=Ø35 d=Ø25 h=28

Type / Model	REF. NO.	SEM NO.	
OPEN LENGTH=474 CLOSED LENGTH=314 UPPER MOUNT DIMENSION=20x62 LOWER MOUNT DIMENSION=20x62	2376001002 2376001800 2376001001	<b>9601</b>	  <b>Description</b> Shock Absorber
OPEN LENGTH=540 CLOSED LENGTH=350 UPPER MOUNT DIMENSION=24x55 LOWER MOUNT DIMENSION=24x55	2376003100 MONROE F5012	<b>9605</b>	  <b>Description</b> Shock Absorber
OPEN LENGTH=472 CLOSED LENGTH=332 UPPER MOUNT DIMENSION=24x62 LOWER MOUNT DIMENSION=24x62	2376000500 2376000800 2376000600 2376001000 SACHS 170191 MONROE F5013	<b>9606</b>	  <b>Description</b> Shock Absorber
OPEN LENGTH=413 CLOSED LENGTH=278 UPPER MOUNT DIMENSION=20x78 LOWER MOUNT DIMENSION=20x68	2376007000 2376007001 SACHS 312668 MONROE F5174	<b>11433</b>	  <b>Description</b> Shock Absorber
OPEN LENGTH=491 CLOSED LENGTH=315 UPPER MOUNT DIMENSION=20x78 LOWER MOUNT DIMENSION=20x68	2376007100 2376007101 SACHS 312669 MONROE F5175	<b>11434</b>	  <b>Description</b> Shock Absorber
OPEN LENGTH=532 CLOSED LENGTH=335 UPPER MOUNT DIMENSION=20x78 LOWER MOUNT DIMENSION=20x68	2376007200 2376007201 MONROE F5176 SACHS 312670	<b>11435</b>	  <b>Description</b> Shock Absorber

SEM NO.	REF. NO.	Type / Model
11468	2376007301	OPEN LENGTH=460 CLOSED LENGTH=300 UPPER MOUNT DIMENSION=----- LOWER MOUNT DIMENSION=-----
<b>Description</b>		
Shock Absorber		











Technical Specification	REF. NO.	SEM NO.	
Total Weight 9 kg	2919V 3228104200	72.2919.CP	
		<b>Description</b>	Plastic Piston
Technical Specification	REF. NO.	SEM NO.	
Total Weight 9,3 kg	2229000701 3229000700 2229000700 3229000702 2618 (E5)	CONTITECH 4004 N P05 CF GOMMA 1T 300 33 97722 GOODYEAR 1R11 706 DUNLOP D12B13 / B14 PHOENIX 1DK 22 E5	
		72.4004.C03	<b>Description</b>
			Metal Piston
Technical Specification	REF. NO.	SEM NO.	
Total Weight 6,6 kg	3229000700 3229000702 2618	CONTITECH 4004 N P03 GOODYEAR1R11-713 GOODYEAR1R11-750 GART D278S 278.4.452 CF GOMMA 1T300-37 203715 PHOENIX 1 DK 22 E-8 DUNLOP D12B13 DUNLOP D12B34 FIRESTONE 1T17BS-6	
		72.4004.CP03	<b>Description</b>
			Plastic Piston
Technical Specification	REF. NO.	SEM NO.	
Total Weight 4,9 kg	4284300301	CONTITECH 4004 N P02 FIRESTONE 1T17BS-6 FIRESTONE W01 M58 0919 DUNLOP D12U13 GOODYEAR 1R11-705 PHOENIX 1 DK 22 E-8 NP GART D278S 278.0.451 2618 Service Assembly	
		72.4004.S02	<b>Description</b>
			Service Assembly
Technical Specification	REF. NO.	SEM NO.	
Total Weight 12,3 kg	3229002400	CONTITECH 4008 N P01 Firestone Style 1T19F-12 Firestone Style W01 M58 8765 DUNLOP D13B03 VIBRACOUSTIC V 1 D 28 C-12 PHOENIX 1 D 28 C-12 WW US 07380 F	
		72.4008.C01	<b>Description</b>
			Metal Piston
Technical Specification	REF. NO.	SEM NO.	
Total Weight 9,2 kg	3229002900 3229212900 3229222900 3229242900 2618 V	CONTITECH 4022 N P03 (ST) GOODYEAR 1R11-710 CF GOMMA 1 T 300-37 204677 PHOENIX1 DK 22 E-9 DUNLOPD12B26	
		72.4022.C03	<b>Description</b>
			Metal Piston

	<b>ŞEM NO.</b>	<b>REF. NO.</b>	<b>Technical Specification</b>
	<b>72.4022.CP03</b>	3229002900 3229212900 3229242900 3229222900	CONTITECH 4022 N P03 CF GOMMA 1T 300-37 206340 FIRESTONE 1T17BS-6 DUNLOP D12B14
	<b>Description</b>	2618 V	Total Weight 6,6 kg FIRESTONE W01 M58 6367 GOODYEAR 1R11-714 PHOENIX 1 DK 22 E-9
	Plastic Piston		
	<b>ŞEM NO.</b>	<b>REF. NO.</b>	<b>Technical Specification</b>
	<b>72.4022.CP05</b>	3229003300	CONTITECH 4022 N P05 GART D 278 S 278.1.455 FIRESTONE 1T17BS 6 F GOMMA 1 T 300 37 206585 FIRESTONE W01 M58 8612 VIBRACOUSTIC V 1 DK 22 E 10 GOODYEAR 1R11 781 PHOENIX 1 DK 22 E 11 2619V
	<b>Description</b>		Total Weight 6,7 kg
	Plastic Piston		
	<b>ŞEM NO.</b>	<b>REF. NO.</b>	<b>Technical Specification</b>
	<b>72.4022.CP06</b>	3229003800	VIBRACOUSTIC V 1 DK 22 E-13 PHOENIX 1 DK 22 E-9 (2621V) 2621 V
	<b>Description</b>		Total Weight 6,7 kg
	Plastic Piston		
	<b>ŞEM NO.</b>	<b>REF. NO.</b>	<b>Technical Specification</b>
	<b>72.4022.S02</b>	4284300600 2618VP02 2619VP02	CONTITECH4022 N P02 VIBRACOUSTIC V 1 DK 22 E 9 NP FIRESTONE1T17BS 6 PHOENIX 1DK 22 E 9 NP FIRESTONEW01 M58 0756 DUNLOP D11U40 GOODYEAR1R11 709
	<b>Description</b>		Total Weight 4,8 kg
	Service Assembly		
	<b>ŞEM NO.</b>	<b>REF. NO.</b>	<b>Technical Specification</b>
	<b>72.4023.C03</b>	3229003100 3229213100 3229243100 3229223100	CONTITECH 4023 N P03 GY SPRINGRIDE D13B26 PHOENIX 1 D 28 B-10 CF GOMMA REF. 1T19E-2 TaurusKR622-18 CF GOMMA NO.204676 VIBRACOUSTIC V1D28B-10 Airtech No.130322 FIRESTONE 1T19L-11
	<b>Description</b>		Total Weight 11,9 kg
	Metal Piston		
	<b>ŞEM NO.</b>	<b>REF. NO.</b>	<b>Technical Specification</b>
	<b>72.4023.S</b>	CONTITECH4023 N P06 FIRESTONE1T19L-11 PHOENIX 1 D 28 B-10 NP FIRESTONE W01-M58-6335 2923 V (Service Assembly)	Total Weight 4,5 kg
	<b>Description</b>		
	Service Assembly		

Technical Specification	REF. NO.		ŞEM NO.	
Total Weight 7,1 kg	90557082	CONTITECH 4159 N P12 CONTITECH 9 10-19 P 315 FIRESTONE 1T15M-9 FIRESTONE W01 358 9101 GOODYEAR 1R12-717 TAURUS 6364 TRIANGLE 8315 DAYTON 352-9101 LOADGUARD Sc2038	<b>72.4159.CP12</b>	
			<b>Description</b>	
			Plastic Piston	
Technical Specification	REF. NO.		ŞEM NO.	
Total Weight 7,1 kg	90557086 90557135 90557108 90557136	CONTITECH 4159 N P13 CONTITECH 9 10-19 P 326 FIRESTONE 1T15M-9 FIRESTONE W01 358 9192 GOODYEAR 1R12-167 LOADGUARD SC2120 WATSON&CHALIN AS-0038 WATSON&CHALIN AS-0046 TRIANGLE 8326	<b>72.4159.CP13</b>	
			<b>Description</b>	
			Plastic Piston	
Technical Specification	REF. NO.		ŞEM NO.	
Total Weight 12 kg	3228002700 3229222700 3229002700 3229212700	CONTITECH 4810 N P05 GY SPRINGRIDE D13B25 PHOENIX 1 D 28 A-10 CF GOMMA REF.1T19E-1 Taurus KR621-18 CF GOMMA NO. 205456 VIBRACOUSTIC V1D28A-10 GART NO. 277.4.423 FIRESTONE 1T19L-7	<b>72.4810.C05</b>	
			<b>Description</b>	
			Metal Piston	
Technical Specification	REF. NO.		ŞEM NO.	
Total Weight 10,5 kg	2228000200 2228240200 2228210200 2228260200 2228220200	CONTITECH 810 MB PHOENIX 1 D 28 A-2 Taurus KR621-26 VIBRACOUSTIC V1D28A-2 FIRESTONE 1T19L-7 FIRESTONE W01-M58-6345 FIRESTONE W01-M58-8775 GY SPRINGRIDE D13B20 GY SPRINGRIDE D13B01	<b>72.810.C</b>	
			<b>Description</b>	
			Metal Piston	
Technical Specification	REF. NO.		ŞEM NO.	
		CONTITECH 810 MB/0 PHOENIX 1 D 28 A-5 NP VIBRACOUSTIC V1D28A-5 NP DUNLOP UK PNP307520000 FIRESTONE 1T19L-7 FIRESTONE W01-M58-7237 GOODYEAR 1R14-868	<b>72.810.S</b>	
			<b>Description</b>	
			Service Assembly	
Technical Specification	REF. NO.		ŞEM NO.	
Total Weight 11,6 kg	2229000300 2229240300 2229260300 2229210300 2923	CONTITECH 813 MB PHOENIX 1 D 28 B-2 Taurus KR622-26 VIBRACOUSTIC V1D28B-2 FIRESTONE 1T19L-11 FIRESTONE W01-M58-6364 FIRESTONE W01-M58-6339 GART REF. D277/B GOODYEAR 1R14-705	<b>72.813.C</b>	
			<b>Description</b>	
			Metal Piston	



	<p><b>SEM NO.</b> <b>72.912.C01</b></p> <p><b>Description</b> Metal Piston</p>	<p><b>REF. NO.</b> 3228003000 3229003000</p>	<p><b>Technical Specification</b> CONTITECH 912 N P01 GY SPRINGRIDE D14B52 PHOENIX 1 D 28 D-10 CF GOMMA REF.1T19E2-L VIBRACOUSTIC V1D28D-10 CF GOMMA NO.206333 FIRESTONE 1T19L-14 GART NO.287.4.600</p>	<p><b>Total Weight</b> 14,5 kg</p>
	<p><b>SEM NO.</b> <b>72.912.C02</b></p> <p><b>Description</b> Metal Piston</p>	<p><b>REF. NO.</b> 3229001300</p>	<p><b>Technical Specification</b> CONTITECH 912 N P02 PHOENIX 1 D 28 D-2 VIBRACOUSTIC V1D28D-4 FIRESTONE 1T19L-14 FIRESTONE W01-M58-8766 FIRESTONE W01-M58-7385 GART REF. D287/C GOODYEAR 1R14-758 GY SPRINGRIDE D13B14</p>	<p><b>Total Weight</b> 15 kg</p>
	<p><b>SEM NO.</b> <b>72.2211.P11</b></p> <p><b>Description</b> Convulated Air Spring</p>	<p><b>REF. NO.</b> 4229100400</p>	<p><b>Technical Specification</b> CONTITECH FD 200-19 P04 GOODYEAR 2B9-700 PHOENIX SP 2 B 12 R-5 GY SPRINGRIDE S09201 VIBRACOUSTIC VSP2B12R-5 GART NO.291.2.203 FIRESTONE 20F GART REF.T291/2</p>	<p><b>Total Weight</b> 2,7 kg</p>
	<p><b>SEM NO.</b> <b>72.2211.P12</b></p> <p><b>Description</b> Convulated Air Spring</p>	<p><b>REF. NO.</b> 45980054192</p>	<p><b>Technical Specification</b> CONTITECH FD 200-19 P03 FIRESTONE 20 - 2" Dunlop 9" S09203"</p>	<p><b>Total Weight</b> 2,7 kg</p>
	<p><b>SEM NO.</b> <b>72.3301.P01</b></p> <p><b>Description</b> Convulated Air Spring</p>	<p><b>REF. NO.</b> 3228100201</p>	<p><b>Technical Specification</b> CONTITECH FT 330-29 P01 GRANINNG 17017 GART T 271/S (271.3.296)</p>	<p><b>Total Weight</b> 8,5 kg</p>





<b>Type / Model</b>	<b>REF. NO.</b>		<b>SEM NO.</b>	
	4175023900 2175016900		12833	
				<b>Description</b>
				Brake Slack Adjuster, Automatic
Ø14x250/180/165/150/135/120x5°				
<b>Type / Model</b>	<b>REF. NO.</b>		<b>SEM NO.</b>	
	2100200012 2175029400		12866	
				<b>Description</b>
				Brake Slack Adjuster, Manuel
Ø14x127/152/178/203x0°/19°LOCK				
<b>Type / Model</b>	<b>REF. NO.</b>		<b>SEM NO.</b>	
	4175008501 3434350800		12867	
				<b>Description</b>
				Brake Slack Adjuster, Automatic
Ø 14x250/210/180/150/125x130°				
<b>Type / Model</b>	<b>REF. NO.</b>		<b>SEM NO.</b>	
	4175018400		12876	
				<b>Description</b>
				Brake Slack Adjuster, Automatic
Ø 14x250/180/165/150/135/120x110°				

# 6.4.1

SEM NO.	REF. NO.	Type / Model
<p>10690</p> <p>3434381200</p> <p><b>Description</b> Caliper Repair Kit</p>	<p>KN TYPE / IVECO TYPE SN 6529, SN 6539, SN 7067, SN 7077 SN 7084, SN 7094, SN 7086, SN 7096 SN 7106, SN 7116, SN 7125, SN 7135 SN 7144, SN 7154, NA 7027, NA 7028 NA 7038, SK 7..., SN 65..., SN 66..., SN 7..., SN 71..., SN 72..., SN 73.. Series</p>	
<p>12233</p> <p><i>new product</i></p> <p>3434381500</p> <p><b>Description</b> Caliper Repair Kit</p>	<p>KN TYPE</p>	
<p>12234</p> <p><i>new product</i></p> <p>3434382000</p> <p><b>Description</b> Caliper Repair Kit</p>	<p>KN TYPE</p>	



# 6.4.3













SEM NO.	REF. NO.	Type / Model
<p>10766</p> <p>3434382701</p> <p><b>Description</b> Caliper Repair Kit</p>	<p>WBC TYPE 40 195 001, 40 195 002, 40 195 003, 40 195 004, 40 195 015, 40 195 024 40 195 017, 40 195 020, 40 195 027, 40 195 030, 40 195 035, 40 195 038 40 195 043, 40 195 044, 40 225 007, 40 225 008, 40 225 015, 40 225 016</p>	
<p>10767</p> <p>3434382800</p> <p><b>Description</b> Caliper Repair Kit</p>	<p>WBC TYPE 40 195 017, 40 195 020, 40 195 027, 40 195 030, 40 195 035, 40 195 038, 40 195 043, 40 195 044, 40 225 007, 40 225 008, 40 225 015, 40 225 016</p>	
<p>12559</p> <p><i>new product</i></p> <p>3434382000</p> <p><b>Description</b> Caliper Repair Kit</p>	<p>WBC TYPE 40 195 001, 40 195 002, 40 195 003, 40 195 004, 40 195 015, 40 195 024 40 195 017, 40 195 020, 40 195 027, 40 195 030, 40 195 035, 40 195 038 40 195 043, 40 195 044, 40 225 007, 40 225 008, 40 225 015, 40 225 016</p>	













Type / Model	REF. NO.		SEM NO.	
WBC TYPE	3080001901 3080003320 3080003300		<b>12631</b>	 <b>Description</b> Caliper Repair Kit 19,5" (Left)
WBC TYPE	3080001801 3080003200 3080003220		<b>12632</b>	 <b>Description</b> Caliper Repair Kit 19,5" (Right)
WBC TYPE	3434382900		<b>12533</b>	 <b>Description</b> Caliper Repair Kit

**Clutch and Brake Group**  
Caliper Group / HLX Type

**6.4.4**

Type / Model	REF. NO.		SEM NO.	
HLX TYPE MARK II MARK III	3434385200 3434385500		<b>12634</b>	 <b>Description</b> Caliper Repair Kit
HLX TYPE MARK IV MODUL X	3434385202		<b>12636</b>	 <b>Description</b> Caliper Repair Kit

	<b>SEM NO.</b> 12047		<b>REF. NO.</b> 1230100204 3230100204	<b>Type / Model</b>
<b>Description</b> Bushing				
	<b>SEM NO.</b> 12048		<b>REF. NO.</b> 1230100203	<b>Type / Model</b>
<b>Description</b> Bushing				
	<b>SEM NO.</b> 12049		<b>REF. NO.</b> 1230200101 3230200101	<b>Type / Model</b>
<b>Description</b> Repair Kit				
	<b>SEM NO.</b> 12052		<b>REF. NO.</b> 1072001701	<b>Type / Model</b>
<b>Description</b> Bushing				
	<b>SEM NO.</b> 12053		<b>REF. NO.</b> 1072001800 1072001801	<b>Type / Model</b>
<b>Description</b> Bushing				
	<b>SEM NO.</b> 12059		<b>REF. NO.</b> 1230100100	<b>Type / Model</b>
<b>Description</b> Bushing				

<b>Type / Model</b>	<b>REF. NO.</b>		<b>SEM NO.</b>	
	3268005000		12042	
			<b>Description</b>	
			Repair Kit	
<b>Type / Model</b>	<b>REF. NO.</b>		<b>SEM NO.</b>	
	3268004600 3268005100		12051	
			<b>Description</b>	
			Repair Kit	
<b>Type / Model</b>	<b>REF. NO.</b>		<b>SEM NO.</b>	
	3268004500		12050	
			<b>Description</b>	
			Repair Kit	
<b>Type / Model</b>	<b>REF. NO.</b>		<b>SEM NO.</b>	
	4230017600		12054	
			<b>Description</b>	
			Bushing	
<b>Type / Model</b>	<b>REF. NO.</b>		<b>SEM NO.</b>	
	1230010602 1230010603 1230010604		12055	
			<b>Description</b>	
			Bushing	
<b>Type / Model</b>	<b>REF. NO.</b>		<b>SEM NO.</b>	
	4230018000		12056	
			<b>Description</b>	
			Bushing	





SEM NO.		REF. NO.	Type / Model
12057		4230017201	

**Description**  
Bushing



SEM NO.		REF. NO.	Type / Model
12058		4131000800	

**Description**  
Bushing

Model:		SEM NO.	Description / Repair Kit
		<b>12001</b>	
		REF. NO: 3317000400	
		<b>12002</b>	
		REF. NO: 3317000600	
		<b>12003</b>	
		REF. NO: 3268000702	
		<b>12004</b>	
		REF. NO: 3268000701	



Description / Repair Kit	SEM NO.	Model:
	12005	



REF. NO: 3317000400SMB

Description / Repair Kit	SEM NO.	Model:
	12006	



REF. NO: 3434362000  
3434361800

Description / Repair Kit	SEM NO.	Model:
	12007	



REF. NO: 3434362200

Description / Repair Kit	SEM NO.	Model:
	12008	



REF. NO: 3317001100

<b>Model:</b>		<b>ŞEM NO.</b>	<b>Description / Repair Kit</b>
		12009	
<b>Item No</b>	<b>Ref. No</b>	<b>REF. NO:</b>	
1	1072001701		
2	1072001800		
3	1230200101		
4	1331001500		
5	1133100200		
6	1331005600		
7	4315000300		
8	4348100500		
9	4348100600		
10	4201000500		

<b>Model:</b>		<b>ŞEM NO.</b>	<b>Description / Repair Kit</b>
		12010	
<b>Item No</b>	<b>Ref. No</b>	<b>REF. NO:</b>	
1	1230100204		
2	1350200104		
3	4121000800		
4	4343102204		
5	4342001380		
6	4141000100		

<b>Model:</b>		<b>ŞEM NO.</b>	<b>Description / Repair Kit</b>
		12011	
<b>Item No</b>	<b>Ref. No</b>	<b>REF. NO:</b>	
1	1072001701		
2	1350200201		
3	4342001380		
4	4141000100		
5	4343102204		
6	----		
7	----		

<b>Model:</b>		<b>ŞEM NO.</b>	<b>Description / Repair Kit</b>
		12012	
		<b>REF. NO:</b>	
		3434360100	

Description / Repair Kit	SEM NO.	Model:
	12014	



REF. NO: 3268004700

Description / Repair Kit	SEM NO.	Model:
	12015	



REF. NO: 3434363700

Description / Repair Kit	SEM NO.	Model:
	12016	



REF. NO: 3268000600

Description / Repair Kit	SEM NO.	Model:
	12017	



REF. NO: 3317001000

Model:		SEM NO.	Description / Repair Kit
		12018	
		REF. NO: 3317000900	
		12019	
		REF. NO: 3434363600	
		12020	
		REF. NO: 3434363800	
		12021	
		REF. NO: 3317001600	



Description / Repair Kit	SEM NO.	Model:
--------------------------	---------	--------

12022



REF. NO: 3317003600

Description / Repair Kit	SEM NO.	Model:
--------------------------	---------	--------

12023



REF. NO: 3268003400

Description / Repair Kit	SEM NO.	Model:
--------------------------	---------	--------

12024



REF. NO: 3317000500

Description / Repair Kit	SEM NO.	Model:
--------------------------	---------	--------

12025



REF. NO: 3434360200

Model:		SEM NO.	Description / Repair Kit
		12027	
		REF. NO: 3434363900	
		12028	
		REF. NO: 3268000801	
		12029	
		REF. NO: 3268003300	
		12030	
		REF. NO: 3268003700	

Description / Repair Kit	SEM NO.	Model:
--------------------------	---------	--------



12031   
REF. NO: 3268003200

Description / Repair Kit	SEM NO.	Model:
--------------------------	---------	--------



12032   
REF. NO: 3434361900

Description / Repair Kit	SEM NO.	Model:
--------------------------	---------	--------



12033   
REF. NO: 3434365200

Description / Repair Kit	SEM NO.	Model:
--------------------------	---------	--------



12034   
REF. NO: 3434361400

Model:		SEM NO.	Description / Repair Kit
		12035	
		REF. NO: 3434361300	
		12036	
		REF. NO: 3434361100	
		12037	
		REF. NO: 3434361000	
		12038	
		REF. NO: 3434363400	



Description / Repair Kit	SEM NO.	Model:
--------------------------	---------	--------



12039 

REF. NO: 3434364200

Description / Repair Kit	SEM NO.	Model:
--------------------------	---------	--------



12040 







REF. NO: 3434364000

Description / Repair Kit	SEM NO.	Model:
--------------------------	---------	--------



12041 

REF. NO: 3268003500

<b>Type / Model</b>	<b>REF. NO.</b>		<b>SEM NO.</b>	
	3005017300		12120	
				<b>Description</b> Repair Kit
<b>Type / Model</b>	<b>REF. NO.</b>		<b>SEM NO.</b>	
	3005014700		12126	
				<b>Description</b> Repair Kit
<b>Type / Model</b>	<b>REF. NO.</b>		<b>SEM NO.</b>	
	3005014100		12129	
				<b>Description</b> Repair Kit



## ROR GROUP



Engine and Transmission Group .....	:	-
Steering Group .....	:	1102
Suspension Group .....	:	1103 - 1113
Cab Group .....	:	-
Axle / Differential ve Shaft Group.....	:	-
Clutch and Brake Group.....	:	1114 - 1138



SEM NO.

11977



REF. NO.







21212426

Type / Model

**Description**

Rubber Metal Bushing

D=Ø63 d=Ø22 h=72,5

<b>Type / Model</b>	<b>REF. NO.</b>	<b>ŞEM NO.</b>	
	21226997 21230041	<b>10833</b>	
		<b>Description</b>	
		Spring Bushing	D=Ø150 d=Ø24 h=120
<b>Type / Model</b>	<b>REF. NO.</b>	<b>ŞEM NO.</b>	
	21215601R	<b>7781 (9256)</b>	
		<b>Description</b>	
		Spring Bushing	D=Ø57 d=Ø30 h=102
<b>Type / Model</b>	<b>REF. NO.</b>	<b>ŞEM NO.</b>	
	21222609	<b>7971 (9255)</b>	
		<b>Description</b>	
		Spring Bushing	D=Ø59,5 d=Ø30 h=102
<b>Type / Model</b>	<b>REF. NO.</b>	<b>ŞEM NO.</b>	
	21208093	<b>7972 (9257)</b>	
		<b>Description</b>	
		Spring Bushing	D=Ø100 d=Ø50 h=130
<b>Type / Model</b>	<b>REF. NO.</b>	<b>ŞEM NO.</b>	
	21224663	<b>9254</b>	
		<b>Description</b>	
		Spring Bushing	D=Ø59,5 d=Ø24 h=102
<b>Type / Model</b>	<b>REF. NO.</b>	<b>ŞEM NO.</b>	
	21225103	<b>10990</b>	
		<b>Description</b>	
		Rubber Metal Bushing	D=Ø60 d=Ø24 L=80

	SEM NO.	REF. NO.	Type / Model
	10993	21227205	
<b>Description</b>			
Rubber Metal Bushing			
D=Ø60 d=Ø24 L=45			







	SEM NO.	REF. NO.	Type / Model
	10994	21223742	
<b>Description</b>			
Rubber Metal Bushing			
D=Ø60 d=Ø30 L=45			

	SEM NO.	REF. NO.	Type / Model
	11285	21222234	
<b>Description</b>			
Pivot Bolt			
M30x200			



	SEM NO.	REF. NO.	Type / Model
	10308	21218643	
<b>Description</b>			
Nut			
M22x1,5			

	SEM NO.	REF. NO.	Type / Model
	10900	21228664	
<b>Description</b>			
Metal Plate			
D=Ø90 d=Ø24 h=15			

	SEM NO.	REF. NO.	Type / Model
	10901	21228663	
<b>Description</b>			
Metal Plate			
D=Ø90 d=Ø24 h=15			

Type / Model	REF. NO.	SEM NO.	
	21222221	11283	
		<b>Description</b>	
		Metal Bush (Eccentric)	
			d=Ø30
Type / Model	REF. NO.	SEM NO.	
	21222287	11284	
		<b>Description</b>	
		Metal Bush	
			d=Ø30
Type / Model	REF. NO.	SEM NO.	
	21225162	10902	
		<b>Description</b>	
		Metal Plate	
			D=Ø100 d=Ø24 h=3
Type / Model	REF. NO.	SEM NO.	
	21224386	10903	
		<b>Description</b>	
		Metal Plate	
			D=Ø100 d=Ø24 h=5
Type / Model	REF. NO.	SEM NO.	
	21222223	11286	
		<b>Description</b>	
		Metal Plate	
			d=41
Type / Model	REF. NO.	SEM NO.	
	21222690	11287	
		<b>Description</b>	
		Metal Plate	
			d=Ø30



	SEM NO.	REF. NO.	Type / Model
 D=Ø191 d=Ø64 h=7	10971	21226663	
	<b>Description</b>		
	Spacer Ring		
	SEM NO.	REF. NO.	Type / Model
 d=Ø30	11289	99513008	
	<b>Description</b>		
	Washer		
	SEM NO.	REF. NO.	Type / Model
 M30	11288	99527003	
	<b>Description</b>		
	Nut		

Model:		SEM NO.	Description / Repair Kit
		10808	
<b>Item No</b>	<b>Ref. No</b>	<b>REF. NO:</b>	
1	21222609	21222609S	
2	21222221		
3	21222287		
4	21222234		
5	21222223		
6	21222690		
7	99527003		
8	99513008		



**SEM NO.**

**REF. NO.**

**Type / Model**

**11389**

21206225

**Description**

Spring Bolt (U)



M22x130x452,5

Type / Model	REF. NO.	SEM NO.	
OPEN LENGTH=472	21208363	9606	
CLOSED LENGTH=332	21224034		
UPPER MOUNT DIMENSION=24x62			<b>Description</b> Shock Absorber
LOWER MOUNT DIMENSION=24x62			

	<b>SEM NO.</b> 72.2211.P01	<b>REF. NO.</b> 21221395 21222663	<b>Technical Specification</b> CONTITECH FD 200-19 1/4 M10 GART 291.2.200 DUNLOP UK 01128A-AP FLOOR 13586 GY SPRINGRIDE S09201NB GRANNING 15603 GOODYEAR 2B9-223 GRANNING 1371 PHOENIX SP2B12R	<b>Technical Specification</b> PRIMERIDE 5200 19 A P01 VIBRACOUSTICVSP2B12R GARTT291/1 FIRESTONE20 FIRESTONEW01 M58 6887 FIRESTONEW01 M58 6910 CF GOMMA NO.206797 Airtech No.113001 CF GOMMA REF.T20 Airtech Ref,2B 220	<b>Total Weight</b> 2,7 kg
	<b>Description</b> Convulated Air Spring				
	<b>SEM NO.</b> 72.4008.C01	<b>REF. NO.</b> 21221349	<b>Technical Specification</b> CONTITECH 4008 N P01 Firestone Style 1T19F-12 Firestone Style W01 M58 8765 DUNLOP D13B03 VIBRACOUSTIC V 1 D 28 C-12 PHOENIX 1 D 28 C-12 WW US 07380 F	<b>Technical Specification</b>	<b>Total Weight</b> 12,3 kg
	<b>Description</b> Metal Piston				
	<b>SEM NO.</b> 72.4028.C05	<b>REF. NO.</b> 21222239	<b>Technical Specification</b> CONTITECH 4028 N P05 GOODYEAR 1R14-721 PHOENIX 1 D 28 B-12 GOODYEAR 1R14-710 VIBRACOUSTIC V1D28F-7 GY SPRINGRIDE D14B51 FIRESTONE 1T19L11 GART NO.277.4.520	<b>Technical Specification</b>	<b>Total Weight</b> 11,9 kg
	<b>Description</b> Metal Piston				
	<b>SEM NO.</b> 72.4156.C04	<b>REF. NO.</b> 21208939	<b>Technical Specification</b> CONTITECH 4156 N P04 GOODYEAR 1R12-092 TAURUS KR 506-22SU GRANNING 1359 DUNLOP D12B33 GRANNING 1528	<b>Technical Specification</b>	<b>Total Weight</b> 8,8 kg
	<b>Description</b> Metal Piston				
	<b>SEM NO.</b> 72.4156.C06	<b>REF. NO.</b> 21215761 21216135	<b>Technical Specification</b> CONTITECH 4156 N P06 Taurus KR 506-28 GOODYEAR 1R12-719 DUNLOP D12B19 PHOENIX 1 DK 21 A-2 WW US 35864	<b>Technical Specification</b>	<b>Total Weight</b> 8,8 kg
	<b>Description</b> Metal Piston				
	<b>SEM NO.</b> 72.4156.CP14	<b>REF. NO.</b> 21208939	<b>Technical Specification</b> CONTITECH 4156 N P14 PHOENIX 1 DK 23 K-9082 VIBRACOUSTIC V1DK23K-9082 GOODYEAR 1R12-092 GY SPRINGRIDE D12B33 Transpart 520 728	<b>Technical Specification</b>	<b>Total Weight</b> 6,6 kg
	<b>Description</b> Plastic Piston				

Technical Specification	REF. NO.	SEM NO.		
Total Weight 6,6 kg	2121 5761	CONTITECH 4156 N P15 CF GOMMA REF.1T323-32 PHOENIX 1 DK 23 K-1 CF GOMMA NO.207086 FIRESTONE 1T15M-6 DUNLOP UK 00981B-AP FIRESTONE W01-358-9361 WW US 35864	<b>72.4156.CP15</b>  <b>Description</b> Plastic Piston	
Total Weight 6,6 kg	21221307	CONTITECH 4157 N P04 GOODYEAR 1R11 111 FIRESTONE 1T15MPW 7 TAURUS KR 915 54 FIRESTONE W01 M58 6297 PHOENIX 1DK 21 A 4 DUNLOP D12B18 WW US 06287 WW US 07364	<b>72.4157.CP04</b>  <b>Description</b> Plastic Piston	
Total Weight 6,6 kg	21222442	CONTITECH 4157 N P05 WW US 07074 C WW US 07074 P	<b>72.4157.CP05</b>  <b>Description</b> Plastic Piston	
Total Weight 6,6 kg	21222442	CONTITECH 4157 N P09 WW US 07074 F FIRESTONE 1T15MPW-7 GOODYEAR 1R11-106 FIRESTONE W01 M58 7074 PHOENIX 1 DK 21 A-31 DUNLOP D12B17 TAURUS KR 913-57	<b>72.4157.CP09</b>  <b>Description</b> Plastic Piston	
Total Weight 9,6 kg	21215891	CONTITECH 4159 N P04	<b>72.4159.C06</b>  <b>Description</b> Metal Piston	
Total Weight 7,1 kg	21215762 21226039 21215891	CONTITECH 4159 N P14 PHOENIX 1 DK 21 B-4 VIBRACOUSTIC V1DK21B-4 FIRESTONE 1T15M-9 FIRESTONE W01-M58-7548 Montenegro GOODYEAR 1R12-760 GY SPRINGRIDE D12B01 CF GOMMA REF. 1T323-40	<b>72.4159.CP14</b>  <b>Description</b> Plastic Piston	

	<b>SEM NO.</b> <b>72.6199.C</b>	<b>REF. NO.</b> MLF 7146 GOODYEAR 1R13-744	<b>Technical Specification</b> Total Weight 10,5 kg
	<b>Description</b> Metal Piston		
	<b>SEM NO.</b> <b>72.6200.C</b>	<b>REF. NO.</b> GOODYEAR 1R13-745 MLF 7167	<b>Technical Specification</b> Total Weight 10,7 kg
	<b>Description</b> Metal Piston		
	<b>SEM NO.</b> <b>72.810.C</b>	<b>REF. NO.</b> 21208082 21215632	<b>Technical Specification</b> Total Weight 10,5 kg
	<b>Description</b> Metal Piston	CONTITECH 810 MB PHOENIX 1 D 28 A-2 Taurus KR621-26 VIBRACOUSTIC V1D28A-2 FIRESTONE 1T19L-7 FIRESTONE W01-M58-6345 FIRESTONE W01-M58-8775	
	<b>SEM NO.</b> <b>72.810.S</b>	<b>REF. NO.</b> CONTITECH 810 MB/0 FIRESTONE 1T19L-7 PHOENIX 1 D 28 A-5 NP FIRESTONE W01-M58-7237 VIBRACOUSTIC V1D28A-5 NP GOODYEAR 1R14-868 DUNLOP UK PNP307520000	<b>Technical Specification</b> Total Weight 4,8 kg
	<b>Description</b> Service Assembly		
	<b>SEM NO.</b> <b>72.813.C</b>	<b>REF. NO.</b> 21215633	<b>Technical Specification</b> Total Weight 11,6 kg
	<b>Description</b> Metal Piston	CONTITECH 813 MB PHOENIX 1 D 28 B-2 SAE 8403 / 102 Titan 91687700000 Taurus KR622-26 VIBRACOUSTIC V1D28B-2 FIRESTONE 1T19L-11 FIRESTONE W01-M58-6364 FIRESTONE W01-M58-6339	
	<b>SEM NO.</b> <b>72.912.C02</b>	<b>REF. NO.</b> 21222673	<b>Technical Specification</b> Total Weight 15 kg
	<b>Description</b> Metal Piston	CONTITECH 912 N P02 PHOENIX 1 D 28 D-2 VIBRACOUSTIC V1D28D-4 FIRESTONE 1T19L-14 FIRESTONE W01-M58-8766 FIRESTONE W01-M58-7385 GART REF. D287/C GOODYEAR 1R14-758 GY SPRINGRIDE D13B14	

Technical Specification	REF. NO.	SEM NO.	
	21221356	CONTITECH FD 200-25 1/4 M10 PHOENIX SP 2 B 12 R-A-10 VIBRACOUSTIC VSP2B12RA-10 FIRESTONE 20C-2 Granning 15670	<b>72.2221.P03</b>
		<b>Description</b> Convulated Air Spring	
Technical Specification	REF. NO.	SEM NO.	
	21226068	FIRESTONE W01 M58 6875	<b>72.2304.P05</b>
		<b>Description</b> Convulated Air Spring	





SEM NO.

12845



REF. NO.

21223694  
21229249





Type / Model

**Description**



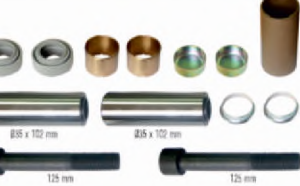
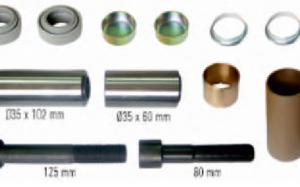

Brake Slack Adjuster, Automatic

Ø 14x205/153/140/127/115x60°





Type / Model	REF. NO.	ŞEM NO.	
MRT TYPE DX.195.51 DX.195.52	MCK1171	10721	<p><b>Description</b> Caliper Repair Kit</p>
MRT TYPE DX.195.52	MCK1291	10728	<p><b>Description</b> Caliper Repair Kit</p>
MRT TYPE DX.195.51	MCK1290	10729	<p><b>Description</b> Caliper Repair Kit</p>
MRT TYPE DX.195.52	MCK1293	10731	<p><b>Description</b> Caliper Repair Kit</p>
MRT TYPE DX.195.51	MCK1292	10732	<p><b>Description</b> Caliper Repair Kit</p>
MRT TYPE LRG 542, 543, 570, 571, 574, 575, 576, 577, 586, 587, 588, 589, 590, 591 616, 617, 632, 633, 642, 643, 704, 705, 752, 753, LUCAS KJ47/JJ47	St1156	10734	<p><b>Description</b> Caliper Repair Kit</p>

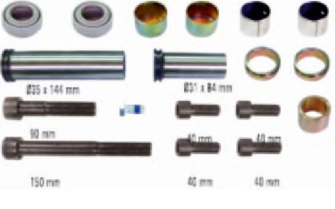

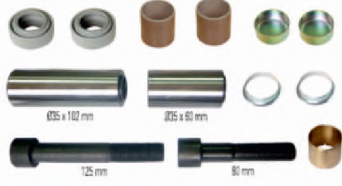
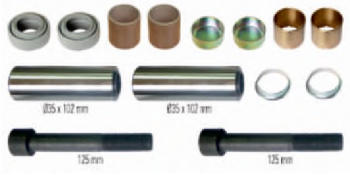
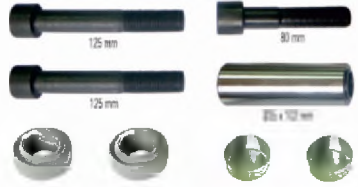

	<b>ŞEM NO.</b>	<b>REF. NO.</b>	<b>Type / Model</b>
	<b>10735</b>	SJ4112	MRT TYPE All LRG Series
	<b>Description</b> Caliper Repair Kit		
	<b>ŞEM NO.</b>	<b>REF. NO.</b>	<b>Type / Model</b>
	<b>10737</b>	SJ4098	MRT TYPE All LRG Series
	<b>Description</b> Caliper Repair Kit		
	<b>ŞEM NO.</b>	<b>REF. NO.</b>	<b>Type / Model</b>
	<b>10746</b>	MCK1118	MRT TYPE LRG 598/599
	<b>Description</b> Caliper Repair Kit		
	<b>ŞEM NO.</b>	<b>REF. NO.</b>	<b>Type / Model</b>
	<b>10747</b>	MCK1116	MRT TYPE LRG 536, 537, 552, 553, 560, 561, 578, 579, 596, 597 648, 649, 650, 651, 652, 653
	<b>Description</b> Caliper Repair Kit		
	<b>ŞEM NO.</b>	<b>REF. NO.</b>	<b>Type / Model</b>
	<b>10748</b>	68324854PK10 MCK1139	MRT TYPE All LRG Series LRG 544, 545, 572, 573, 580, 581, 582, 583, 638, 639, 646, 647, 658, 659 662, 663, 664, 665, 669, 670, 700, 701, 712, 713, 720, 721, 722, 723, 724, 725, 736, 737, 744, 745, 748, 749, 750, 751
	<b>Description</b> Caliper Repair Kit		
	<b>ŞEM NO.</b>	<b>REF. NO.</b>	<b>Type / Model</b>
	<b>10749</b>	MCK1238	MRT TYPE LRG 536, 537, 552, 553, 560, 561 578, 579, 596, 597, 598, 599 648, 649, 650, 651, 652, 653
	<b>Description</b> Caliper Repair Kit		

Type / Model	REF. NO.	ŞEM NO.	
MRT TYPE LRG 536, 560, 578, 597, 648, 650, 652	MCK1236	10750	<p><b>Description</b> Caliper Repair Kit</p>
MRT TYPE LRG 537, 561, 579, 596, 649, 651, 653	MCK1237 MCK1239	10751	<p><b>Description</b> Caliper Repair Kit</p>
MRT TYPE LRG 536, 560, 578, 597, 648, 650, 652	MCK1111	10752	<p><b>Description</b> Caliper Repair Kit</p>
MRT TYPE LRG 537, 561, 562, 563, 579, 596, 598, 599, 649, 651	MCK1112 SJ4110 SJ4103	10753	<p><b>Description</b> Caliper Repair Kit</p>
MRT TYPE LRG 598, 599	MCK1113	10754	<p><b>Description</b> Caliper Repair Kit</p>
MRT TYPE LRG 598, 599	SJ4108	10755	<p><b>Description</b> Caliper Repair Kit</p>

	ŞEM NO.	REF. NO.	Type / Model
 <p><b>Description</b> Caliper Repair Kit</p>	10756	SJ4096 MCK1398	MRT TYPE LRG 578, 579
 <p><b>Description</b> Caliper Repair Kit</p>	10757	SJ4097	MRT TYPE LRG 578, 579
 <p><b>Description</b> Caliper Repair Kit</p>	10758	SJ4109	MRT TYPE LRG 598, 599
 <p><b>Description</b> Caliper Repair Kit</p>	10759	SJ4105	MRT TYPE LRG 536, 537, 578, 579, 596, 597, 652, 653
 <p><b>Description</b> Caliper Repair Kit</p>	10760	MCK1041	MRT TYPE LRG 560, 561, 648, 649, 650, 651
 <p><b>Description</b> Caliper Repair Kit</p>	10761	MCK1243 MCK1140	MRT TYPE LRG 544, 545, 572, 573, 580, 581 582, 583, 638, 639, 646, 647, 658, 659 662, 663, 700, 701, 712, 713, 722, 723 744, 745, 748, 749, 750, 751





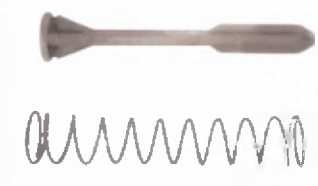







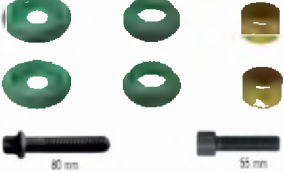

Type / Model	REF. NO.	ŞEM NO.	
MRT TYPE LRG 726, 727, ELSA 195, 225, RADIAL	MCK1317	11813	 <p><b>Description</b> Caliper Repair Kit</p>
MRT TYPE PREMIUM LRG 728, 729, 730, 731, 732, 733, RENAULT PREMIUM 440	MCK1298	11841	 <p><b>Description</b> Caliper Repair Kit</p>
MRT TYPE LRG 536, 537, 552, 553, 560, 561, 578, 579, 596, 597, 598, 599, 648, 649, 650, 651, 652, 653	MCK1134 SJ4094	12286	 <p><b>Description</b> Caliper Repair Kit</p>
MRT TYPE LRG 598/599	MCK1135	12287	 <p><b>Description</b> Caliper Repair Kit</p>
MRT TYPE LRG 536, 537, 552, 553, 560, 561, 578, 579, 596, 597, 598, 599, 648, 649, 650, 651, 652, 653	MCK1299 MCK1066	12288	 <p><b>Description</b> Caliper Repair Kit</p>
MRT TYPE MCK 1050		12293	 <p><b>Description</b> Caliper Repair Kit</p>

	SEM NO.	REF. NO.	Type / Model
 <p><b>Description</b> Caliper Repair Kit</p>	12300	MCK1127	MRT TYPE LRG 537, 561, 579, 596, 649, 651, 653
 <p><b>Description</b> Caliper Repair Kit</p>	12301	MCK1128	MRT TYPE LRG 598, 599
 <p><b>Description</b> Caliper Repair Kit</p>	12302	MCK1048	MRT TYPE LRG 578, 579
 <p><b>Description</b> Caliper Repair Kit</p>	12303	MCK1129	MRT TYPE LRG 648, 649, 650, 651
 <p><b>Description</b> Caliper Repair Kit</p>	12305	MCK1067	MRT TYPE D DUCO
 <p><b>Description</b> Caliper Repair Kit</p>	12306	SJ4111	MRT TYPE LRG 536, 537, 552, 553, 560, 561, 578, 579, 596, 597, 598, 599, 648, 649, 650, 651, 652, 653

Type / Model	REF. NO.	ŞEM NO.	
MRT TYPE LRG 536, 542, 586, 588, 597, 648, 650, 652, 704	68322563PK4	12307	<p><b>Description</b> Caliper Repair Kit</p>
MRT TYPE LRG 537, 543, 560, 587, 589, 596, 598, 599, 649, 651, 653, 705	68322562PK4	12308	<p><b>Description</b> Caliper Repair Kit</p>
MRT TYPE LRG 536, 537, 578, 579, 596, 597, 598, 599, 652, 653	MCK68322900PK10	12309	<p><b>Description</b> Caliper Repair Kit</p>
MRT TYPE LRG 552, 553	MCK1263	12310	<p><b>Description</b> Caliper Repair Kit</p>
MRT TYPE DX.195.51 / DX.195.52	MCK1192	12317	<p><b>Description</b> Caliper Repair Kit</p>
MRT TYPE DX.225	MCK1170	12326	<p><b>Description</b> Caliper Repair Kit</p>



	ŞEM NO.	REF. NO.	Type / Model
 <p><b>Description</b> Caliper Repair Kit</p>	12327	MCK1173	MRT TYPE DX.225
 <p><b>Description</b> Caliper Repair Kit</p>	12328	MCK1171/N	MRT TYPE DX.195
 <p><b>Description</b> Caliper Repair Kit</p>	12329	MCK1193	MRT TYPE DX.195
 <p><b>Description</b> Caliper Repair Kit</p>	12330	MCK1172	MRT TYPE DX.225
 <p><b>Description</b> Caliper Repair Kit</p>	12331	MCK1191	MRT TYPE DX.225
 <p><b>Description</b> Caliper Repair Kit</p>	12336	MCK1160 MCK1175 21224954	MRT TYPE DX.195.51 / DX.195.52

Type / Model	REF. NO.	ŞEM NO.	
MRT TYPE DX.195.51 / DX.195.52	MCK1161	12337	<p><b>Description</b> Caliper Repair Kit</p> 
MRT TYPE DX175	MCK1156	12338	<p><b>Description</b> Caliper Repair Kit</p> 
MRT TYPE DX195	MCK1158	12339	<p><b>Description</b> Caliper Repair Kit</p> 
MRT TYPE DX225	MCK1165	12340	<p><b>Description</b> Caliper Repair Kit</p> 
MRT TYPE DX225	MCK1164	12341	<p><b>Description</b> Caliper Repair Kit</p> 
MRT TYPE LRG 524, 525, 526, 527, 528, 529, 532, 533, 562, 563	SJ4011 SJ1228 MCK1213	12358	<p><b>Description</b> Caliper Repair Kit</p> 

ŞEM NO.	REF. NO.	Type / Model
12359	SJ1213	MRT TYPE LRG 532, 533, 622, 623
 <p><b>Description</b> Caliper Repair Kit</p>		







ŞEM NO.	REF. NO.	Type / Model
12360	SJ4001	MRT TYPE LRG 524, 525, 526, 527, 528, 529, 532, 533, 562, 563
 <p><b>Description</b> Caliper Repair Kit</p>		



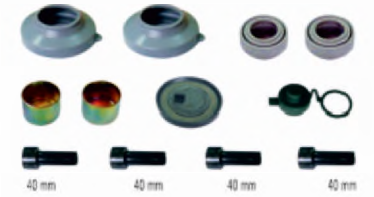

ŞEM NO.	REF. NO.	Type / Model
12380	SJ1212	MRT TYPE LRG 524, 525, 526, 527, 528, 529, 532, 533, 622, 623
 <p><b>Description</b> Caliper Repair Kit</p>		





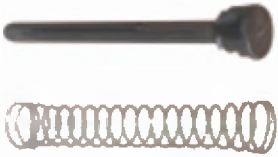

ŞEM NO.	REF. NO.	Type / Model
12396	SJ4000	MRT TYPE
 <p><b>Description</b> Caliper Repair Kit</p>		

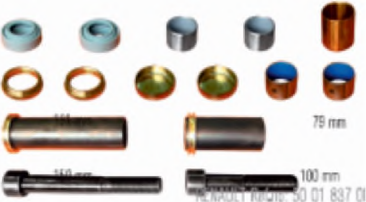
ŞEM NO.	REF. NO.	Type / Model
12398	MCK1103	LRG 573, 574, 575, 590, 591, 704, 705 MRT TYPE
 <p><b>Description</b> Caliper Repair Kit</p>		

ŞEM NO.	REF. NO.	Type / Model
12400	MCK1102	MRT TYPE LRG 542, 543, 570, 571, 576, 577, 586, 587, 588, 589, 616, 617, 632, 633, 642, 643, 752, 753, LUCAS KJ47/JJ47
 <p><b>Description</b> Caliper Repair Kit</p>		

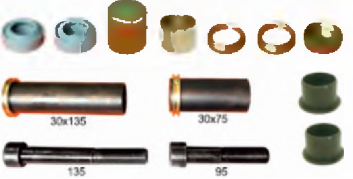
Type / Model	REF. NO.	ŞEM NO.	
MRT TYPE	MCK1086	12431	 <p><b>Description</b> Caliper Repair Kit</p>
MRT TYPE ELSA 2, ELSA 195, ELSA 225		12432	 <p><b>Description</b> Caliper Repair Kit</p>
MRT TYPE LRG 544, 545, 572, 573, 580, 581, 582, 583, 638, 639, 646, 647, 658, 659, 662, 663, 700, 701, 712, 713, 722, 723, 744, 745, 748, 749, 750, 751	MCK1244	12435	 <p><b>Description</b> Caliper Repair Kit</p>
MRT TYPE LRG 582, 583	MCK1088	12437	 <p><b>Description</b> Caliper Repair Kit</p>
MRT TYPE ELSA 2	MCK1253	12438	 <p><b>Description</b> Caliper Repair Kit</p>
MRT TYPE ELSA 2	MCK1254	12439	 <p><b>Description</b> Caliper Repair Kit</p>

	SEM NO.	REF. NO.	Type / Model
 <p><b>Description</b> Caliper Repair Kit</p>	<b>12450</b>	68323746PK10 68323746	MRT TYPE All LRG Series
 <p><b>Description</b> Caliper Repair Kit</p>	<b>12474</b>	MCK1240	MRT TYPE
 <p><b>Description</b> Caliper Repair Kit</p>	<b>12481</b>	MCK1310	MRT TYPE LRG 726, 727, 728, 729, 730, 731, 732, 733
 <p><b>Description</b> Caliper Repair Kit</p>	<b>12490</b>	MCK1311	MRT TYPE LRG 726, 727, 728, 729, 730, 731, 732, 733
 <p><b>Description</b> Caliper Repair Kit</p>	<b>12499</b>	MCK1264	MRT TYPE LRG 544, 545, 572, 573, 580, 581, 582, 583, 638, 639, 646, 647, 658, 659, 662, 663, 664, 665, 669, 670, 700, 701, 712, 713, 720, 721, 722, 723, 724, 725, 736, 737, 744, 745, 748, 749, 750, 751
 <p><b>Description</b> Caliper Repair Kit</p>	<b>12507</b>	SJ4076	MRT TYPE D LISA, LRG 548, 549, 550, 551, 564, 565, 592, 593, 630, 631





Type / Model	REF. NO.	ŞEM NO.	
MRT TYPE D LISA	SJ4021	12508	 <p><b>Description</b> Caliper Repair Kit</p>
MRT TYPE LISA	SJ4053	12509	 <p><b>Description</b> Caliper Repair Kit</p>
MRT TYPE C LISA	SJ4052	12510	 <p><b>Description</b> Caliper Repair Kit</p>
MRT TYPE LRG 548, 550, 554, 564, 592, 630	SJ4074	12511	 <p><b>Description</b> Caliper Repair Kit</p>
MRT TYPE LRG 549, 551, 554, 565, 593, 631	SJ4074	12512	 <p><b>Description</b> Caliper Repair Kit</p>
MRT TYPE LRG 548, 550, 554, 564, 592, 594	MCK 1021 MCK 1151	12519	 <p><b>Description</b> Caliper Repair Kit</p>







	SEM NO.	REF. NO.	Type / Model
	<b>12520</b>	MCK 1022 MCK 1152	MRT TYPE LRG 549, 551, 555, 565, 593, 595
	<b>Description</b> Caliper Repair Kit		
	<b>12523</b>	SJ4078	MRT TYPE LRG 548, 549, 550, 551
	<b>Description</b> Caliper Repair Kit		
	<b>12524</b>	SJ4077	MRT TYPE LISA
	<b>Description</b> Caliper Repair Kit		
	<b>12525</b>	SJ4032	MRT TYPE C LISA D LISA
	<b>Description</b> Caliper Repair Kit		

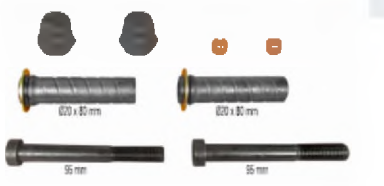











Type / Model	REF. NO.	ŞEM NO.	
HYDRAULIC TYPE LRG 506,LRG 507	SJ1037	12719	<p><b>Description</b> Caliper Repair Kit</p>
HYDRAULIC TYPE LRG 6512, LRG 514, 612, 614, 812, 814, (Rear)	SJ1035	12721	<p><b>Description</b> Caliper Repair Kit</p>
HYDRAULIC TYPE LRG 614, 615	SJ1214	12723	<p><b>Description</b> Caliper Repair Kit</p>
HYDRAULIC TYPE LRG 600,601, 608, 609, 610, 611, 620, 621	SJ1091	12725	<p><b>Description</b> Caliper Repair Kit</p>
HYDRAULIC TYPE LRG 600,601, 602, 603, 608, 609, 610, 611, 628, 629, 634, 635	SJ1092	12726	<p><b>Description</b> Caliper Repair Kit</p>
HYDRAULIC TYPE LRG 500, 501, 502, 503, 504, 505, 508, 509, 518, 519, 534, 535	SP8564	12730	<p><b>Description</b> Caliper Repair Kit</p>















	ŞEM NO.	REF. NO.	Type / Model
 <p><b>Description</b> Caliper Repair Kit</p>	<b>12731</b>	SP8567	HYDRAULIC TYPE LRG 502, 503, 504, 505
 <p><b>Description</b> Caliper Repair Kit</p>	<b>12732</b>	SP8597	HYDRAULIC TYPE LRG 510, 511, 516, 517, 520 521, 566, 567
 <p><b>Description</b> Caliper Repair Kit</p>	<b>12733</b>	SP8566	HYDRAULIC TYPE All Series
 <p><b>Description</b> Caliper Repair Kit</p>	<b>12734</b>	SP9670	HYDRAULIC TYPE LRG 601, 602, 603, 608, 609, 610, 611, 628, 629, 634, 635
 <p><b>Description</b> Caliper Repair Kit</p>	<b>12735</b>	SP8565	HYDRAULIC TYPE LRG 500, 501, 502, 503, 504, 505, 508 509, 512, 513, 514, 518, 519, 534 535, 568, 569, 600, 601, 602, 603 608, 609, 610, 611, 620, 621, 628 629, 634, 635
 <p><b>Description</b> Caliper Repair Kit</p>	<b>12736</b>	SP8902	HYDRAULIC TYPE LRG 510, 511, 516, 517, 520 521, 566 567

Type / Model	REF. NO.	SEM NO.
HYDRAULIC TYPE	ST1154	12737
		<p><b>Description</b> Caliper Repair Kit</p>
HYDRAULIC TYPE	SJ1034	12738
		<p><b>Description</b> Caliper Repair Kit</p>
HYDRAULIC TYPE	SP9669	12739
		<p><b>Description</b> Caliper Repair Kit</p>
HYDRAULIC TYPE	SJ1030	12740
		<p><b>Description</b> Caliper Repair Kit</p>
HYDRAULIC TYPE	SJ1033	12741
		<p><b>Description</b> Caliper Repair Kit</p>









	SEM NO.	REF. NO.	Type / Model
	12767	2257Y1143	IVECO TYPE
	<b>Description</b> Caliper Repair Kit		
	12768	1718D134 2257M1001 2257D108	IVECO TYPE SN 6529, SN 6539, SN 7067, SN 7077, SN 7084, SN 7094, SN 7086, SN 7096 SN 7106, SN 7116, SN 7125, SN 7135, SN 7144, SN 7154, NA 7027, NA 7028, NA 7038,SK 7..., SN 65..., SN 66..., SN 7..., SN 71..., SN 72..., SN 73.. Series
	<b>Description</b> Caliper Repair Kit		
	12776	3280S8131	IVECO TYPE
	<b>Description</b> Caliper Repair Kit		
	12777	2297H8354 2297J8356	IVECO TYPE
	<b>Description</b> Caliper Repair Kit		
	12778	2297J4820 2297K4821	IVECO TYPE
	<b>Description</b> Caliper Repair Kit		

<b>Type / Model</b>	<b>REF. NO.</b>		<b>SEM NO.</b>	
	21006585		12049	
			<b>Description</b>	
			Repair Kit	
<b>Type / Model</b>	<b>REF. NO.</b>		<b>SEM NO.</b>	
	21016722 21204601		12052	
			<b>Description</b>	
			Bushing	
<b>Type / Model</b>	<b>REF. NO.</b>		<b>SEM NO.</b>	
	21016723 21204602		12053	
			<b>Description</b>	
			Bushing	
<b>Type / Model</b>	<b>REF. NO.</b>		<b>SEM NO.</b>	
	21006563		12110	
			<b>Description</b>	
			Bushing	
<b>Type / Model</b>	<b>REF. NO.</b>		<b>SEM NO.</b>	
	15213430		12111	
			<b>Description</b>	
			Repair Kit	
<b>Type / Model</b>	<b>REF. NO.</b>		<b>SEM NO.</b>	
	15220224 15224821		12112	
			<b>Description</b>	
			Repair Kit	

	<b>SEM NO.</b> 12113		<b>REF. NO.</b> 15204595	<b>Type / Model</b>
<b>Description</b> Repair Kit				
	<b>SEM NO.</b> 12114		<b>REF. NO.</b> A23105Q1213	<b>Type / Model</b>
<b>Description</b> Bushing				
	<b>SEM NO.</b> 12115		<b>REF. NO.</b> 21209990	<b>Type / Model</b>
<b>Description</b> Bushing				
	<b>SEM NO.</b> 12118		<b>REF. NO.</b> 21204703	<b>Type / Model</b>
<b>Description</b> Bushing				
	<b>SEM NO.</b> 12116		<b>REF. NO.</b> 21204849	<b>Type / Model</b>
<b>Description</b> Bushing				
	<b>SEM NO.</b> 12117		<b>REF. NO.</b> 21205667	<b>Type / Model</b>
<b>Description</b> Bushing				

Model:		SEM NO.	Description / Repair Kit
		12098	
		REF. NO: AXL132	
		12099	
		REF. NO: AXL122	
		12100	
		REF. NO: 10690588	
		12101	
		REF. NO: AXL112	



Description / Repair Kit	SEM NO.		Model:
	12102		
	REF. NO: AXL111		
	12103		Model:
	REF. NO: AXL140		
	12104		Model:
	REF. NO: AXL124		
	12105		Model:
	REF. NO: AXL131		

Model:	SEM NO.	Description / Repair Kit
1072001701	<b>12106</b>	
	<b>REF. NO:</b> AXL123	

Model:	SEM NO.	Description / Repair Kit																					
1072001701	<b>12107</b>																						
<table border="1"> <thead> <tr> <th>Item No</th> <th>Ref. No</th> </tr> </thead> <tbody> <tr><td>1</td><td>1072001701</td></tr> <tr><td>2</td><td>21006585</td></tr> <tr><td>3</td><td>21204601</td></tr> <tr><td>4</td><td>21204602</td></tr> <tr><td>5</td><td>21006593</td></tr> <tr><td>6</td><td>21006627</td></tr> <tr><td>7</td><td>21006662</td></tr> <tr><td>8</td><td>21006624</td></tr> <tr><td>9</td><td>21219862</td></tr> <tr><td>10</td><td>99507030</td></tr> </tbody> </table>	Item No		Ref. No	1	1072001701	2	21006585	3	21204601	4	21204602	5	21006593	6	21006627	7	21006662	8	21006624	9	21219862	10	99507030
Item No	Ref. No																						
1	1072001701																						
2	21006585																						
3	21204601																						
4	21204602																						
5	21006593																						
6	21006627																						
7	21006662																						
8	21006624																						
9	21219862																						
10	99507030																						

Model:	SEM NO.	Description / Repair Kit																					
1072001701	<b>12108</b>																						
<table border="1"> <thead> <tr> <th>Item No</th> <th>Ref. No</th> </tr> </thead> <tbody> <tr><td>1</td><td>1072001701</td></tr> <tr><td>2</td><td>21209990</td></tr> <tr><td>3</td><td>21016721</td></tr> <tr><td>4</td><td>99507030</td></tr> <tr><td>5</td><td>99070006</td></tr> <tr><td>6</td><td>-----</td></tr> <tr><td>7</td><td>21202756</td></tr> <tr><td>8</td><td>21006627</td></tr> <tr><td>9</td><td>21006662</td></tr> <tr><td>10</td><td>21202757</td></tr> </tbody> </table>	Item No		Ref. No	1	1072001701	2	21209990	3	21016721	4	99507030	5	99070006	6	-----	7	21202756	8	21006627	9	21006662	10	21202757
Item No	Ref. No																						
1	1072001701																						
2	21209990																						
3	21016721																						
4	99507030																						
5	99070006																						
6	-----																						
7	21202756																						
8	21006627																						
9	21006662																						
10	21202757																						

Model:	SEM NO.	Description / Repair Kit																					
1072001701	<b>12109</b>																						
<table border="1"> <thead> <tr> <th>Item No</th> <th>Ref. No</th> </tr> </thead> <tbody> <tr><td>1</td><td>1072001701</td></tr> <tr><td>2</td><td>21219862</td></tr> <tr><td>3</td><td>-----</td></tr> <tr><td>4</td><td>21006662</td></tr> <tr><td>5</td><td>21006627</td></tr> <tr><td>6</td><td>21204601</td></tr> <tr><td>7</td><td>21204602</td></tr> <tr><td>8</td><td>99507030</td></tr> <tr><td>9</td><td>99070006</td></tr> <tr><td>10</td><td>21016720</td></tr> </tbody> </table>	Item No		Ref. No	1	1072001701	2	21219862	3	-----	4	21006662	5	21006627	6	21204601	7	21204602	8	99507030	9	99070006	10	21016720
Item No	Ref. No																						
1	1072001701																						
2	21219862																						
3	-----																						
4	21006662																						
5	21006627																						
6	21204601																						
7	21204602																						
8	99507030																						
9	99070006																						
10	21016720																						



Description / Repair Kit	SEM NO.	Model:
	12122	
	REF. NO: 21224522+15224518	

Description / Repair Kit	SEM NO.	Model:
	12123	
	REF. NO: 21224522+15225842	

Description / Repair Kit	SEM NO.	Model:
	12128	
	REF. NO: 21202329 21202330 2120232930	

# FRUEHAUF GROUP



Engine and Transmission Group .....	:	-
Steering Group .....	:	-
Suspension Group .....	:	1140 - 1146
Cab Group .....	:	-
Axle / Differential ve Shaft Group.....	:	-
Clutch and Brake Group.....	:	1147 - 1148



**SEM NO.**  
11996



**REF. NO.**  
UJA0030001

**Type / Model**

**Description**

Rubber Bushing



**SEM NO.**  
13036











**REF. NO.**  
UJA0033001

**Type / Model**

**Description**

Rubber Bushing

d=ø32 D=ø55-58



Model:		SEM NO.	Description / Repair Kit
		<b>12168</b>	
		REF. NO: 100114	
			'D=Ø90 d=Ø52 h=111,5
		<b>12169</b>	
		REF. NO: 100114S	
			'D=Ø90 d=Ø52 h=111,5
		<b>13037</b>	
		REF. NO: 100113	
			d=Ø32 D=Ø55-58
		<b>13038</b>	
		REF. NO: 100113S	
			d=Ø32 D=Ø55-58

	SEM NO.		REF. NO.	Type / Model
	11395		M001685	
	<p><b>Description</b> Spring Bolt (U)</p>			





M24x128x285

	SEM NO.		REF. NO.	Type / Model
	11396		M008957	
	<p><b>Description</b> Spring Bolt (U)</p>			

M24x128x320

Type / Model	REF. NO.	SEM NO.	
OPEN LENGTH=468 CLOSED LENGTH=330 UPPER MOUNT DIMENSION=20x55 LOWER MOUNT DIMENSION=20x55	SACHS 280498 M076480 MONROE F5084 M200133 M200052 UJB0364 1526855 UJB0563 M001537 UJB0565 M007950	9604	
			<b>Description</b> Shock Absorber
Type / Model	REF. NO.	SEM NO.	
OPEN LENGTH=472 CLOSED LENGTH=332 UPPER MOUNT DIMENSION=24x62 LOWER MOUNT DIMENSION=24x62	10490505651	9606	
			<b>Description</b> Shock Absorber

	<b>SEM NO.</b> <b>72.4008.C01</b>	<b>REF. NO.</b> UJB0305 CONTITECH 4008 N P01 Firestone Style 1T19F-12 Firestone Style W01 M58 8765 DUNLOP D13B03 VIBRACOUSTIC V 1 D 28 C-12 PHOENIX 1 D 28 C-12 WW US 07380 F	<b>Technical Specification</b> Total Weight 12,3 kg
	<b>Description</b> Metal Piston		
	<b>SEM NO.</b> <b>72.4156.C09</b>	<b>REF. NO.</b> UJB0207001 CONTITECH 4156 N P09 FIRESTONE W01 M58 9089 FIRESTONE 1T15M-6 GOODYEAR 1R12-706 BERTOJA 454 02004 DUNLOP D12B16 SMB M00 1472	<b>Technical Specification</b> Total Weight 10 kg
	<b>Description</b> Metal Piston		
	<b>SEM NO.</b> <b>72.4156.CP15</b>	<b>REF. NO.</b> M001472	<b>Technical Specification</b> Total Weight 6,6 kg
	<b>Description</b> Plastic Piston		
	<b>SEM NO.</b> <b>72.4157.CP03</b>	<b>REF. NO.</b> M078580 CONTITECH 4157 N P03 GOODYEAR 1R11-881	<b>Technical Specification</b> Total Weight 6,6 kg
	<b>Description</b> Plastic Piston		
	<b>SEM NO.</b> <b>72.4157.CP10</b>	<b>REF. NO.</b> UJB0975 CONTITECH 4157 NP 10 ACERBI 128 140028 FIRESTONE 1T15MPW-7 ACERBI 800 449526 FIRESTONE W01 M58 6315 SMB M 060924	<b>Technical Specification</b> DUNLOP D12B29 PHOENIX 1 DK 20 A-51 GOODYEAR 1R11-772 TAURUS KR 915-51 Total Weight 6,6 kg
	<b>Description</b> Plastic Piston		
	<b>SEM NO.</b> <b>72.4159.C03</b>	<b>REF. NO.</b> UJA 0894 UJB0203 CONTITECH 4159 N P03 DUNLOP D12B01 FIRESTONE 1T15M-9 PHOENIX 1 DK 21B-4 FIRESTONE W01 M58 8859 CF GOMMA 1 T 323-40	<b>Technical Specification</b> Total Weight 9,6 kg
	<b>Description</b> Metal Piston		

Technical Specification	REF. NO.	SEM NO.	
Total Weight 9,6 kg	UJA0894001	72.4159.C06	 <p><b>Description</b> Metal Piston</p>
Total Weight 12,6 kg	UJB0203001 CONTITECH 4159 N P07 GY SPRINGRIDED12B15 PHOENIX 1 DK 23 L-25 CF GOMMA REF.1T323-40 VIBRACOUSTIC V1DK23B-9 CF GOMMA NO.202302 FIRESTONE 1T15M-9 DUNLOP UK 00982A-AP	FIRESTONE W01-379-9091 GART NO.278.2.511 FIRESTONE W01-M58-8859 GART REF.D278/H GOODYEAR 1R12-702 SMB 1518779 SMB 1520356 SMB 1524873 SMB M001782	 <p><b>Description</b> Metal Piston</p>
Total Weight 7,1 kg	UJA09030 UJB0358001 CONTITECH 4159 N P09 Cardi 58051210 PHOENIX 1 DK 23 L 9131 SAMRO H2500324 VIBRACOUSTIC V1DK23L 9131 SMB 1525199 FIRESTONE 1T15M 9	SMB M001774 FIRESTONE W01 M58 9131 CF GOMMA NO.200751 GOODYEAR 1R12 721 GART NO. 278.1.510 GY SPRINGRIDE D12B04 GART REF.D278/H CF GOMMA REF.1T323 40	 <p><b>Description</b> Plastic Piston</p>
Total Weight 7,1 kg	UJA0894001 CONTITECH 4159 N P14 GOODYEAR 1R12-760 PHOENIX 1 DK 21 B-4 GY SPRINGRIDE D12B01 VIBRACOUSTIC V1DK21B-4 CF GOMMA REF.1T323-40 FIRESTONE 1T15M-9	CF GOMMA NO.204124 FIRESTONE W01-M58-7548 DUNLOP UK PNP311370000 Montenegro	 <p><b>Description</b> Plastic Piston</p>
Total Weight 4,8 kg	CONTITECH 4159 N P05 GOODYEAR 1R12 761 PHOENIX 1 DK 21 B 5 NP GY SPRINGRIDE D12U04 VIBRACOUSTIC V1DK21B 5 CF GOMMA REF.1T323 40 FIRESTONE 1T15M 9 GART NO.278.0.551 FIRESTONE W01 M58 0736 GART REF.D278/H	72.4159.S05	 <p><b>Description</b> Service Assembly</p>
Total Weight 8,5 kg	UJB 0985 CONTITECH FD 412 18 P01 DUNLOP UK 12x2 decentral FIRESTONE 12x2NB Granning 15814 FIRESTONE W01 R58 4073 Lohr A06030601 GOODYEAR 2B12 2457 SMB M063796 GY SPRINGRIDE S12202	72.2302.F02	 <p><b>Description</b> Convulated Air Spring</p>





**SEM NO.**

**72.3303.F02**

**REF. NO.**

CONTITECH FT 412-32 S  
Granning 15897  
DUNLOP SP 2666  
M 002 297

**Technical Specification**

Total Weight 8,5 kg

**Description**

Convulated Air Spring

<b>Type / Model</b>	<b>REF. NO.</b>		<b>SEM NO.</b>	
	CF352283		12833	
				<b>Description</b>
				Brake Slack Adjuster, Automatic
				Ø14x250/180/165/150/135/120x5°
<b>Type / Model</b>	<b>REF. NO.</b>		<b>SEM NO.</b>	
	CF352236 CF352279 CF352557 M042128 M070970		12845	
				<b>Description</b>
				Brake Slack Adjuster, Automatic
				Ø 14x205/153/140/127/115x60°
<b>Type / Model</b>	<b>REF. NO.</b>		<b>SEM NO.</b>	
	CF351827		12867	
				<b>Description</b>
				Brake Slack Adjuster, Automatic
				Ø 14x250/210/180/150/125x130°
<b>Type / Model</b>	<b>REF. NO.</b>		<b>SEM NO.</b>	
	CF252122		12876	
				<b>Description</b>
				Brake Slack Adjuster, Automatic
				Ø 14x250/180/165/150/135/120x110°



**SEM NO.**

12049



**REF. NO.**

CF1001312

**Type / Model**



**Description**

Repair Kit

# HENDRICKSON GROUP



Engine and Transmission Group .....	:	-
Steering Group .....	:	-
Suspension Group .....	:	1150 - 1153
Cab Group .....	:	-
Axle / Differential ve Shaft Group.....	:	-
Clutch and Brake Group.....	:	-

	SEM NO.	REF. NO.	Type / Model
 <p>D=Ø60 d=Ø18 Ax=132</p>	10237 (10239)	45507147	
	<b>Description</b>		
	Rubber Metal Bush		
 <p>D=Ø62 d=Ø18 Ax=132</p>	10880	HS509160	
	<b>Description</b>		
	Spring Bushing		
 <p>D=Ø180 d=Ø60 h=5</p>	10906	B116134	
	<b>Description</b>		
	Spacer Ring		

Technical Specification	REF. NO.	SEM NO.	
Total Weight 11,9 kg	HS251087 FIRESTONE 1T17B-11 FIRESTONE W01M588747 GOODYEAR 1R13-150 SAMRO 2500915 DUNLOP D13B42	<b>72.0081.C</b>	
			<b>Description</b> Metal Piston
Technical Specification	REF. NO.	SEM NO.	
Total Weight 2,7 kg	NA 1827 CONTITECH FD 200-19 1/4 M10 GART 291.2.200 DUNLOP UK 01128A-AP FLOOR 13586 GY SPRINGRIDE S09201NB GRANNING 15603 GOODYEAR 2B9-223	GRANNING 1371 PHOENIX SP2B12R PRIMERIDE 5200-19 A P01          <b>72.2211.P01</b>	
			<b>Description</b> Convulated Air Spring
Technical Specification	REF. NO.	SEM NO.	
Total Weight 6,6 kg	HA 100016 CONTITECH 4156 N P10 FIRESTONE W01 358 8929 FIRESTONE 1T15M-6 GOODYEAR 1R12-461	<b>72.4156.CP10</b>	
			<b>Description</b> Plastic Piston
Technical Specification	REF. NO.	SEM NO.	
Total Weight 6,6 kg	B2066 CONTITECH 4156 N P14 PHOENIX 1 DK 23 K-9082 VIBRACOUSTIC V1DK23K-9082 GOODYEAR 1R12-092 GY SPRINGRIDE D12B33 Transport 520 728 WW US 97306 Granning 1359	<b>72.4156.CP14</b>	
			<b>Description</b> Plastic Piston
Technical Specification	REF. NO.	SEM NO.	
Total Weight 6,6 kg	Ha100001 CONTITECH 4156 N P15 PHOENIX 1 DK 23 K-1 FIRESTONE 1T15M-6 FIRESTONE W01-358-9361 CF GOMMA REF. 1T323-32 CF GOMMA NO. 207086 DUNLOP UK 00981B-AP WW US 35864	<b>72.4156.CP15</b>	
			<b>Description</b> Plastic Piston
Technical Specification	REF. NO.	SEM NO.	
Total Weight 9,6 kg	NA1817 CONTITECH 4159 N P08 GOODYEAR 1R12-281	<b>72.4159.C08</b>	
			<b>Description</b> Metal Piston

	<b>ŞEM NO.</b>  <b>72.4159.CP11</b>	<b>REF. NO.</b>  B3842 CONTITECH 4159 N P11	<b>Technical Specification</b>  Total Weight 7,1 kg
<b>Description</b>  Plastic Piston			
	<b>ŞEM NO.</b>  <b>72.4159.CP12</b>	<b>REF. NO.</b>  B3842 CONTITECH 4159 N P12 DAYTON 352-9101 CONTITECH 9 10-19 P 315 LOADGUARD SC2038 FIRESTONE 1T15M-9 NAVISTAR-FLEETRITE 554768C1 FIRESTONE W01 358 9101	<b>Technical Specification</b>  REYCO 12883-01 GOODYEAR 1R12-717 RIDEWELL S-5828-C TAURUS 6364 RIDEWELL S-4740-C TRIANGLE 8315 WATSON&CHALIN AS-0040  Total Weight 7,1 kg
<b>Description</b>  Plastic Piston			
	<b>ŞEM NO.</b>  <b>72.4159.CP13</b>	<b>REF. NO.</b>  Na1817 S6195 CONTITECH 4159 N P13 LOADGUARD SC2120 CONTITECH 9 10-19 P 326 WATSON&CHALIN AS-0038 FIRESTONE1T15M-9 WATSON&CHALIN AS-0046	<b>Technical Specification</b>  FIRESTONE W01 358 9192 TRIANGLE 8326 GOODYEAR 1R12-167  Total Weight 7,1 kg
<b>Description</b>  Plastic Piston			
	<b>ŞEM NO.</b>  <b>72.810.C</b>	<b>REF. NO.</b>  506243 506243/01 785168	<b>Technical Specification</b>  Total Weight 10,5 kg
<b>Description</b>  Metal Piston			
	<b>ŞEM NO.</b>  <b>72.813.C</b>	<b>REF. NO.</b>  505859 785170 505859/01 CONTITECH 813 MB GOODYEAR 1R14 705 PHOENIX 1 D 28 B 2 GY SPRINGRIDE D13B19 Taurus KR622 26 GY SPRINGRIDE D13B02 VIBRACOUSTIC V1D28B 2	<b>Technical Specification</b>  CF GOMMA REF.1T19E 2 FIRESTONE 1T19L 11 CF GOMMA NO.87408 FIRESTONE W01-M58-6364 DUNLOP UK 00985A-AP FIRESTONE W01-M58-6339 GART NO.277.4.500 GART REF.D277/B Granning 15634
<b>Description</b>  Metal Piston			
	<b>ŞEM NO.</b>  <b>72.912.C02</b>	<b>REF. NO.</b>  507782 CONTITECH 912 N P02 GOODYEAR 1R14-758 PHOENIX 1 D 28 D-2 GY SPRINGRIDE D13B14 VIBRACOUSTIC V1D28D-4 CF GOMMA REF.1T19E-4 FIRESTONE 1T19L-14	<b>Technical Specification</b>  CF GOMMA NO.96997 FIRESTONE W01-M58-8766 CF GOMMA NO.202442 FIRESTONE W01-M58-7385 GART NO.287.4.601 GART REF.D287/C WW US 96681  Total Weight 15 kg
<b>Description</b>  Metal Piston			

Technical Specification	REF. NO.	SEM NO.		
Total Weight 11 kg	S-20010 CONTITECH 9 10-13.5 S 433 GOODYEAR Flex No.566263053 aurus 6385 Automann 1DK23I-9270 FIRESTONE 1T15VM35 Triangle 8433 FIRESTONE W01-358-9270	FleetPride As9270 GOODYEAR 1R13-119 Watson & Chalin AS-0084	<b>72.9270.C</b>	
			<b>Description</b> Metal Piston	
Technical Specification	REF. NO.	SEM NO.		
	S-20127 CONTITECH 10 10-21 S 434 GOODYEAR 1R13-081 FIRESTONE 1T15VLT-105 GOODYEAR 1R13-118 FIRESTONE W01 358 9262 TAURUS 6386 FIRESTONE W01 358 9580 LOADGUARD SC2761		<b>72.9580.C</b>	
			<b>Description</b> Metal Piston	
Technical Specification	REF. NO.	SEM NO.		
	SH 505613		<b>72.2221.P03</b>	
			<b>Description</b> Convulated Air Spring	
Technical Specification	REF. NO.	SEM NO.		
Total Weight 2,7 kg	SH 505613 CONTITECH FD 200-19 P02 CF GOMMA REF.T20L FIRESTONE 20F CF GOMMA NO.207065 FIRESTONE W01-M58-7756		<b>72.2211.P14</b>	
			<b>Description</b> Convulated Air Spring	
Technical Specification	REF. NO.	SEM NO.		
Total Weight 8,5 kg	HS 507906/P PHOENIX SP 2B22-RA-2		<b>72.2301.P01</b>	
			<b>Description</b> Convulated Air Spring	









## GIGANT GROUP





Engine and Transmission Group .....	:	-
Steering Group .....	:	-
Suspension Group .....	:	-
Cab Group .....	:	-
Axle / Differential ve Shaft Group.....	:	-
Clutch and Brake Group.....	:	1156

	SEM NO.		REF. NO.	Type / Model
	12831		09319019	
<b>Description</b>				
Brake Slack Adjuster, Manuel				
Ø14x120/150/180/220/250x0° / 19' LOCK				

	SEM NO.		REF. NO.	Type / Model
	12833		00885374	
<b>Description</b>				
Brake Slack Adjuster, Automatic				
Ø14x250/180/165/150/135/120x5°				

	SEM NO.		REF. NO.	Type / Model
	12863		09319013	
<b>Description</b>				
Brake Slack Adjuster, Manuel				
Ø 14x120/150/180x0° / 19' LUCK				

	SEM NO.		REF. NO.	Type / Model
	12876		09317026	
<b>Description</b>				
Brake Slack Adjuster, Automatic				
Ø 14x250/180/165/150/135/120x110°				

# SCHMITZ GROUP









Engine and Transmission Group .....	:	-
Steering Group .....	:	-
Suspension Group .....	:	1158 - 1162
Cab Group .....	:	-
Axle / Differential ve Shaft Group.....	:	-
Clutch and Brake Group.....	:	-







	SEM NO.	REF. NO.	Type / Model
	11531	1013554	
<b>Description</b>			
Rubber Buffer			
A=65 B=375 h=70			

	SEM NO.	REF. NO.	Type / Model
	11532	1013552	
<b>Description</b>			
Rubber Buffer			
A=125 B=165 h=78			

	SEM NO.	REF. NO.	Type / Model
	11586	751085	
<b>Description</b>			
Rubber Buffer			
A=57 B=310 h=25			

Type / Model	REF. NO.	SEM NO.	
OPEN LENGTH=500 CLOSED LENGTH=328 UPPER MOUNT DIMENSION=24x55 LOWER MOUNT DIMENSION=24x55	013250 MONROE F1113	9597	 <b>Description</b> Shock Absorber
OPEN LENGTH=474 CLOSED LENGTH=314 UPPER MOUNT DIMENSION=20x62 LOWER MOUNT DIMENSION=20x62	012486 014134 SACHS 312979 SACHS 170204 MONROE F5025 SACHS 170198 MONROE F1000	9601	 <b>Description</b> Shock Absorber
OPEN LENGTH=540 CLOSED LENGTH=350 UPPER MOUNT DIMENSION=24x55 LOWER MOUNT DIMENSION=24x55	013290 016271	9605	 <b>Description</b> Shock Absorber
OPEN LENGTH=695 CLOSED LENGTH=425 UPPER MOUNT DIMENSION=24x55 LOWER MOUNT DIMENSION=24x55	013506 MONROE F5007	9607	 <b>Description</b> Shock Absorber
OPEN LENGTH=495 CLOSED LENGTH=325 UPPER MOUNT DIMENSION=24x55 LOWER MOUNT DIMENSION=24x55	1041843 SACHS 312561 MONROE F5083 MONROE F5005	11454	 <b>Description</b> Shock Absorber
OPEN LENGTH=801 CLOSED LENGTH=478 UPPER MOUNT DIMENSION=24x55 LOWER MOUNT DIMENSION=24x55	75273 75278 SACHS 101823 SACHS 106201 MONROE F5002	11505	 <b>Description</b> Shock Absorber

	SEM NO.		REF. NO.	Type / Model
	13001		1008054 SACHS 314765 SABO 8901060	
	<b>Description</b> Shock Absorber			
	12973		1086695	
	<b>Description</b> Bolt  M16x1.5x122			
	12974		1086696	
	<b>Description</b> Nut  M16x1.5			

Technical Specification	REF. NO.		SEM NO.		
Total Weight 2,7 kg	US07394.F 16808 CONTITECH FD 200-19 1/4 M8 GY SPRINGRIDE 9"1/4 S09201 FIRESTONE W01-M58-7679 FIRESTONE W01-M58-6187 FIRESTONE 20 GIGANT 190130	GRANNING 15670 GART NO.291.2.200 GART REF.T291/2	<b>72.2211.P03</b>	<b>Description</b> Convulated Air Spring	
Total Weight 11,9 kg	015323 CONTITECH 4028 N P02 FIRESTONE W01-M58-8106 PHOENIX 1 D 28 F-1 GOODYEAR 1R14-782 VIBRACOUSTIC V1D28F-1 GY SPRINGRIDE D14B47 FIRESTONE 1T19L-12 WW US 04028		<b>72.4028.C02</b>	<b>Description</b> Metal Piston	
Total Weight 7,9 kg	014892 750999 CONTITECH 4158 N P03 FIRESTONE W01-M58-6285 PHOENIX 1 DK 20 B-1 GOODYEAR 1R12-749 VIBRACOUSTIC V1DK20B-1 FIRESTONE 1T15MPW-9	GY SPRINGRIDE D12B22 GART NO.278.1.530 FIRESTONE W01-M58-8185 GART REF.D278/HS WW US 06285	<b>72.4158.CP03</b>	<b>Description</b> Plastic Piston	
Total Weight 14 kg	17924 VIBRACOUSTIC V1DK28F-3 FIRESTONE 1T19L-11 GOODYEAR 1R14-823 FIRESTONE W01 M58 6223 WW US 04030P WW US 04030G FAG041-0087		<b>72.4823.C</b>	<b>Description</b> Metal Piston	
Total Weight 6,2 kg	750570 CONTITECH 4881 NP02 PHOENIX 1 DK 32 K FIRESTONE 1T66D-7 FIRESTONE W01-M58-8601 GART REF. C292/A GOODYEAR 1R14-701 GY SPRINGRIDE D14U37	CF GOMMA REF. 1TC360-40 CF GOMMA NO. 205537 GART NO. 292.0.461 VIBRACOUSTIC V1DK32K 292.0.461	<b>72.4881.S02</b>	<b>Description</b> Service Assembly	
Total Weight 6,5 kg	016512 FIRESTONE 1T15MPW-9 WW US 06318 F FIRESTONE W01 M58 6318		<b>72.6318.CP</b>	<b>Description</b> Plastic Piston	











	<b>ŞEM NO.</b>	<b>REF. NO.</b>	<b>Technical Specification</b>
	<b>72.661.R</b>	750208 CONTITECH 644 N PHOENIX 1 E 21 Taurus BL121 VIBRACOUSTIC V1E21	CF GOMMA NO. 92574 DUNLOP UK PNP301470102 GART NO. 276.0.390 GART REF. D276/B SMB
	<b>Description</b>	FIRESTONE 1R1A390 295 FIRESTONE W01 095 0118 GOODYEAR 8017 GY SPRINGRIDE D11S01 CF GOMMA REF. 1S285 24	BredaMenarini 199 196 Büssing 536 905 265 Büssing 536 905 266 Daewoo 96708659 Hanomag 546 905 134
	<b>ŞEM NO.</b>	<b>REF. NO.</b>	<b>Technical Specification</b>
	<b>72.662.R</b>	750209 VDL Bus 0 578 361 Wackenhut Kögel	FIRESTONE W01-095-0207 Büssing 100 110 200 Büssing 100 112 251 GOODYEAR 9007
	<b>Description</b>	CONTITECH 662 N PHOENIX 1 E 32 VIBRACOUSTIC V1E32 FIRESTONE 1R1D355-355	Total Weight 2,4 kg GY SPRINGRIDE D13S01 CF GOMMA REF. 1SC360-30 CF GOMMA NO. 92594 DUNLOP UK PNP302730101
	<b>ŞEM NO.</b>	<b>REF. NO.</b>	<b>Technical Specification</b>
	<b>72.719.R</b>	750215 SCHMITZ 750215 DAF 818225 BPW 0220024000	VIBRACOUSTIC V1F32B FIRESTONE 1R2D530-360 FIRESTONE W01-095-0192 GOODYEAR 8118
	<b>Description</b>	Kögel 4731032000 GIGANT 196036 GIGANT 166205 CONTITECH 719 N PHOENIX 1 F 32 B	Total Weight 2,8 kg CF GOMMA REF.1SC360-43 CF GOMMA NO. 92593 DUNLOP UK PNP304620101 SMB
	<b>ŞEM NO.</b>	<b>REF. NO.</b>	<b>Technical Specification</b>
	<b>72.728.R</b>	750212 CONTITECH 728 N FIRESTONE W01 095 0419 PHOENIX 1 F 32 A GOODYEAR 8117	Total Weight 2,5 kg
	<b>Description</b>	VIBRACOUSTIC V1F32A CF GOMMA REF.1SC360 34 FIRESTONE 1R2S470 360 CF GOMMA NO.92575 DUNLOP UK PNP306420100	
	<b>ŞEM NO.</b>	<b>REF. NO.</b>	<b>Technical Specification</b>
	<b>72.8185.CP</b>	750999 FIRESTONE 1T15MPW-9 WW US 06285 F FIRESTONE W01 M58 8185	Total Weight 6,7 kg
	<b>Description</b>		Plastic Piston
	<b>ŞEM NO.</b>	<b>REF. NO.</b>	<b>Technical Specification</b>
	<b>72.2221.P03</b>	016808 CONTITECH FD 200-25 1/4 M10 PHOENIX SP 2 B 12 R-A-10 VIBRACOUSTIC VSP2B12RA-10	FIRESTONE W01-M58-7679 FIRESTONE W01-968-6771 GOODYEAR 2B9-269 WW US 07394C
	<b>Description</b>	FIRESTONE 20C-2 Granning 15670	WW US 07394F WW US 07394
			Convulated Air Spring

## TRAILOR / YORK GROUP



Engine and Transmission Group .....	:	-
Steering Group .....	:	-
Suspension Group .....	:	-
Cab Group .....	:	-
Axle / Differential ve Shaft Group.....	:	-
Clutch and Brake Group.....	:	1164 - 1165



	SEM NO.		REF. NO.	Type / Model
	12049		1639000W 500362	
<b>Description</b>				
Repair Kit				
	SEM NO.		REF. NO.	Type / Model
	12052		1655000W	
<b>Description</b>				
Bushing				
	SEM NO.		REF. NO.	Type / Model
	12053		1656000E	
<b>Description</b>				
Bushing				
	SEM NO.		REF. NO.	Type / Model
	12055		6503721R	
<b>Description</b>				
Bushing				

Type / Model	REF. NO.		SEM NO.	
	6504785Y		12121	
				<b>Description</b> Repair Kit
Type / Model	REF. NO.		SEM NO.	
	6504771P		12127	
				<b>Description</b> Repair Kit



**DRIVERS SEAT  
AIR SPRING GROUP**



	SEM NO.	REF. NO.	Type / Model
	8172	CONTITECH SZ 51 - 5	C.O.B.O
	<b>Description</b> Driver Suspension Spring		
	8173	CONTITECH SZ 51 - 10	MÖVE
	<b>Description</b> Driver Suspension Spring		
	8358	CONTITECH SZ 51 - 7	PILOT
	<b>Description</b> Cabin Suspension Spring		

**AIR SPRINGS GROUP**





Description / Metal Piston	SEM NO.	REF. NO:
	<b>72.0081.C</b>	MERCEDES 9463280401 HENDRICKSON Hs251087 FIRESTONE 1T17B-11 FIRESTONE W01M588747 GOODYEAR 1R13-150 SAMRO 2500915 DUNLOP D13B42

Total Weight 11,9 kg

Description / Roll	SEM NO.	REF. NO:
	<b>72.1885.R1</b>	IVECO 98478799 MAN 81436010104 MAN 81436010123 MAN 81436010109 MAN 81436010125 MAN 81436010111 MAN 81436010140 MAN 81436010150
		CONTITECH 1885N1 FIRESTONE 1R2A445-280 PHOENIX 1F20B FIRESTONE W010950429 VIBRACOUSTIC V1F20B CF GOMMA 1SC 270-30 202265 GARTC 289 289.0.450 GOODYEAR 9003

Total Weight 1,6 kg

Description / Roll	SEM NO.	REF. NO:
	<b>72.1888.R</b>	MAN 81436010163 CONTITECH 1888 N

Total Weight 1,8 kg

Description / Convulated Air Spring	SEM NO.	REF. NO:
	<b>72.2211.P01</b>	HENDRICKSON NA 1827 ROR 21221395 - 21222663 CONTITECH FD 200-19 1/4 M10 GART 291.2.200 DUNLOP UK 01128A-AP FLOOR 13586 GY SPRINGRIDE S09201NB GRANNING 15603 GOODYEAR 2B9-223 GRANNING 1371 PHOENIX SP2B12R PRIMERIDE 5200-19 A P01, VIBRACOUSTIC VSP2B12R
		GART T291/1 FIRESTONE 20 FIRESTONE W01-M58-6887 FIRESTONE W01-M58-6910 CF GOMMA NO. 206797 Airtech No. 113001 CF GOMMA REF. T20 Airtech Ref, 2B-220

Total Weight 2,7 kg

REF. NO:	SEM NO.	Description / Convulated Air Spring
SCHMITZ US07394.F SCHMITZ 16808 CONTITECH FD 200-19 1/4 M8 GY SPRINGRIDE 9"1/4 S09201 FIRESTONE W01-M58-7679 FIRESTONE W01-M58-6187 FIRESTONE 20 GIGANT 190130 GRANNING 15670 GART NO. 291.2.200 GART REF. T291/2	<b>72.2211.P03</b>	 <p>Total Weight 2,7 kg</p>

REF. NO:	SEM NO.	Description / Metal Piston
	<b>72.2725.C</b>	 <p>Total Weight 15,7 kg</p>

REF. NO:	SEM NO.	Description / Service Assembly
	<b>72.2725.S</b>	 <p>Total Weight 5,3 kg</p>

REF. NO:	SEM NO.	Description / Plastic Piston
SAF 2919V SAF 3228104200	<b>72.2919.CP</b>	 <p>Total Weight 9 kg</p>

Description / Metal Piston	SEM NO.	REF. NO:
	<b>72.3608.C</b>	SCANIA 1903608 SCANIA 1944314 CONTITECH 6700 N P02 GOODYEAR 1R14-869 FIRESTONE W01-M58-8535
	Total Weight 12 kg	

Description / Metal Piston	SEM NO.	REF. NO:
	<b>72.4004.C03</b>	SAF 2229000701 SAF 2618 (E5) CONTITECH 4004 N P05 CF GOMMA 1T 300 33 97722 GOODYEAR 1R11-706 DUNLOP D12B13 / B14 PHOENIX 1DK 22 E5
	Total Weight 9,3 kg	

Description / Plastic Piston	SEM NO.	REF. NO:
	<b>72.4004.CP03</b>	SAF 3229000700 SAF 3229000702 SAF 2618 GOODYEAR 1R11-713 GOODYEAR 1R11-750 GART D278S 278.4.452 CF GOMMA 1T300-37 203715 PHOENIX 1 DK 22 E-8 DUNLOP D12B13 DUNLOP D12B34 CONTITECH 4004 N P03 FIRESTONE 1T17BS-6 FIRESTONE W01 M58 6366
	Total Weight 6,6 kg	

Description / Service Assembly	SEM NO.	REF. NO:
	<b>72.4004.S02</b>	SAF 4284300301 SAF 2618 Service Assembly CONTITECH 4004 N P02 FIRESTONE 1T17BS-6 FIRESTONE W01 M58 0919 DUNLOP D12U13 GOODYEAR 1R11-705 PHOENIX 1 DK 22 E-8 NP GART D278S 278.0.451
	Total Weight 4,9 kg	

REF. NO:	SEM NO.	Description / Metal Piston
FRUEHAUF UJB0305 ROR 21221349 SAF 3229002400 CONTITECH 4008 N P01 Firestone Style 1T19F-12 Firestone Style W01 M58 8765 DUNLOP D13B03 VIBRACOUSTIC V 1 D 28 C-12 PHOENIX 1 D 28 C-12 WW US 07380 F	<b>72.4008.C01</b>	 <p>Total Weight 12,3 kg</p>

REF. NO:	SEM NO.	Description / Service Assembly
CONTITECH 4008 N	<b>72.4008.S</b>	 <p>Total Weight 5,3 kg</p>

REF. NO:	SEM NO.	Description / Metal Piston
	<b>72.4022.C02</b>	 <p>Total Weight 10 kg</p>

REF. NO:	SEM NO.	Description / Metal Piston
SAF 3229002900 SAF 3229212900 SAF 2618 V CONTITECH 4022 N P03 (ST) GOODYEAR 1R11-710 CF GOMMA 1 T 300-37 204677 PHOENIX 1 DK 22 E-9 DUNLOP D12B26	<b>72.4022.C03</b>	 <p>Total Weight 9,2 kg</p>

**Description / Plastic Piston**

**SEM NO.**

**REF. NO:**

**72.4022.CP02**



Total Weight 6,6 kg

**Description / Plastic Piston**

**SEM NO.**

**REF. NO:**

**72.4022.CP03**



SAF 3229002900  
SAF 3229212900  
SAF 3229242900  
SAF 3229222900  
SAF 2618 V  
CONTITECH 4022 N P03  
CF GOMMA 1T 300-37 206340  
FIRESTONE 1T17BS-6  
DUNLOP D12B14  
FIRESTONE W01 M58 6367  
GOODYEAR 1R11-714  
PHOENIX 1 DK 22 E-9  
VIBRACOUSTIC V 1 DK 22 E-9  
GART D 278S 278.4.454

Total Weight 6,6 kg

**Description / Plastic Piston**

**SEM NO.**

**REF. NO:**

**72.4022.CP05**



SAF 3229003300  
SAF 2619V  
CONTITECH 4022 N P05  
GART D 278 S 278.1.455  
FIRESTONE 1T17BS-6  
CF GOMMA 1 T 300-37 206585  
FIRESTONE W01 M58 8612  
GOODYEAR 1R11-781  
PHOENIX 1 DK 22 E-11"  
VIBRACOUSTIC V 1 DK 22 E-10

Total Weight 6,7 kg

**Description / Plastic Piston**

**SEM NO.**

**REF. NO:**

**72.4022.CP06**





SAF 3229003800  
SAF 2621 V  
VIBRACOUSTIC V 1 DK 22 E-13  
PHOENIX 1 DK 22 E-9 (2621V)

Total Weight 6,7 kg

REF. NO:	SEM NO.	Description / Service Assembly
SAF 4284300600 SAF 2618VP02 CONTITECH 4022 N P02 FIRESTONE 1T17BS-6 PHOENIX 1DK 22 E-9 NP FIRESTONE W01 M58 0756 DUNLOP D11U40 GOODYEAR 1R11-709 VIBRACOUSTIC V 1 DK 22 E-9 NP	<b>72.4022.S02</b>	 <p>Total Weight 4,8 kg</p>

REF. NO:	SEM NO.	Description / Metal Piston
GART NO. 277.4.505 FIRESTONE W01-M58-6348 GART REF. D277 GOODYEAR 1R14-729 SAF 3229003100 SAF 2923V CONTITECH 4023 N P03 GY SPRINGRIDE D13B26 PHOENIX 1 D 28 B-10 CF GOMMA REF.1T19E-2 Taurus KR622-18 CF GOMMA NO. 204676 VIBRACOUSTIC V1D28B-10 Airtech No. 130322 FIRESTONE 1T19L-11	<b>72.4023.C03</b>	 <p>Total Weight 11,9 kg</p>

REF. NO:	SEM NO.	Description / Service Assembly
SAF 2923 V (Service Assembly) CONTITECH 4023 N P06 FIRESTONE 1T19L-11 PHOENIX 1 D 28 B-10 NP FIRESTONE W01-M58-6335	<b>72.4023.S</b>	 <p>Total Weight 4,5 kg</p>

REF. NO:	SEM NO.	Description / Metal Piston
SCHMITZ 015323 CONTITECH 4028 N P02 FIRESTONE W01-M58-8106 PHOENIX 1 D 28 F-1 GOODYEAR 1R14-782 VIBRACOUSTIC V1D28F-1 GY SPRINGRIDE D14B47 FIRESTONE 1T19L-12 WW US 04028	<b>72.4028.C02</b>	 <p>Total Weight 11,9 kg</p>

Description / Metal Piston	SEM NO.	REF. NO:
	<b>72.4028.C05</b>	ROR 21222239 CONTITECH 4028 N P05 GOODYEAR 1R14-721 PHOENIX 1 D 28 B-12 GOODYEAR 1R14-710 VIBRACOUSTIC V1D28F-7 GY SPRINGRIDE D14B51 FIRESTONE 1T19L11 GART NO. 277.4.520 FIRESTONE W01-M58-7370 GART REF. D277/D

Total Weight 11,9 kg

Description / Service Assembly	SEM NO.	REF. NO:
	<b>72.4028.S</b>	CONTITECH 4028 N

Total Weight 4,6 kg

Description / Metal Piston	SEM NO.	REF. NO:
	<b>72.40301.C</b>	SCANIA 470920 SCANIA 1140301 FIRESTONE 1T15VR-3 FIRESTONE W01 S15 8192 GOODYEAR 1R13-746 PHOENIX 1 DF 23 B-1

Total Weight 7,8 kg

Description / Metal Piston	SEM NO.	REF. NO:
	<b>72.40302.C</b>	SCANIA 1440302 SCANIA 470921 FIRESTONE 1T15VPR-3 GOODYEAR 1R12-809 FIRESTONE W01 M58 8193 PHOENIX 1 DF 23 A-1

Total Weight 7,8 kg

REF. NO:	SEM NO.	Description / Metal Piston
SCANIA 1440303 SCANIA 1475106 GOODYEAR 1R11-833 FIRESTONE 1T15L-4 PHOENIX 1 DF 20 C-1 FIRESTONE W01 095 0422	<b>72.40303.C</b>	



Total Weight 7,8 kg

REF. NO:	SEM NO.	Description / Metal Piston
SCANIA 1440304 SCANIA 470922 GOODYEAR 1R11-829 PHOENIX 1 DF 20 A-1	<b>72.40304.C</b>	



Total Weight 7,8 kg

REF. NO:	SEM NO.	Description / Metal Piston
SCANIA 1440305 GOODYEAR 1R11-830 FIRESTONE W01 095 481 PHOENIX 1 DF 20 A-2	<b>72.40305.C</b>	



Total Weight 7,8 kg

REF. NO:	SEM NO.	Description / Metal Piston
SCANIA 1440306 GOODYEAR 1R11-831 PHOENIX 1 DF 20 A-3	<b>72.40306.C</b>	



Total Weight 8,7 kg



Description / Metal Piston	SEM NO.	REF. NO:
	<b>72.40307.C</b>	SCANIA 1440307 SCANIA 475149 VOLVO 3027271 GOODYEAR 1R11-845 FIRESTONE 1T15L-4(3) PHOENIX 1 DF 23 B-2 FIRESTONE W01 095 0405

Total Weight 8,7 kg

Description / Roll	SEM NO.	REF. NO:
	<b>72.415.R25</b>	VOLVO 3027271 CONTITECH RZ 415-25 GOODYEAR 9004 PHOENIX 2 G 20 GY SPRINGRIDE D12S08 VIBRACOUSTIC V2G20 CF GOMMA REF. 1S280-25 FIRESTONE W01-095-0381 CF GOMMA NO. 203001

Total Weight 1,7 kg

Description / Roll	SEM NO.	REF. NO:
	<b>72.415.R28</b>	VOLVO 3027272 CONTITECH RZ 415-28 GOODYEAR 9005 PHOENIX 2 G 20 A GY SPRINGRIDE D12S09 VIBRACOUSTIC V2G20A CF GOMMA REF. 1S280-28 FIRESTONE W01-095-0382 CF GOMMA NO. 203000

Total Weight 1,9 kg

Description / Plastic Piston	SEM NO.	REF. NO:
	<b>72.4154.CP05</b>	RVI 5010239252 RVI 5010488071 CONTITECH 4154 N P05 FIRESTONE W01-358-8172 PHOENIX 1 DK 23 F-1 FIRESTONE W01-M58-8172 GOODYEAR 1R12-069 FIRESTONE 1T15M-3 VIBRACOUSTIC V1DK23F-1

Total Weight 5,1 kg

REF. NO:	SEM NO.	Description / Service Assembly
----------	---------	--------------------------------

72.4154.S01



REF. NO:	SEM NO.	Description / Metal Piston
----------	---------	----------------------------

NEWAY 90557075  
 NEWAY 90557027  
 ROR 21208939  
 CONTITECH 4156 N P04  
 GOODYEAR 1R12-092  
 TAURUS KR 506-22SU  
 GRANNING 1359  
 DUNLOP D12B33  
 GRANNING 1528

72.4156.C04



Total Weight 8,8 kg

REF. NO:	SEM NO.	Description / Metal Piston
----------	---------	----------------------------

NEWAY 90557075  
 ROR 21215761  
 ROR 21216135  
 CONTITECH 4156 N P06  
 Taurus KR 506-28  
 GOODYEAR 1R12-719  
 DUNLOP D12B19  
 PHOENIX 1 DK 21 A-2  
 WW US 35864

72.4156.C06



Total Weight 8,8 kg

REF. NO:	SEM NO.	Description / Metal Piston
----------	---------	----------------------------

CONTITECH 4159 N P07

72.4156.C07



Total Weight 8,8 kg

Description / Metal Piston	SEM NO.	REF. NO:
	<b>72.4156.C09</b>	FRUEHAUF UJB0207001 CONTITECH 4156 N P09 FIRESTONE W01 M58 9089 FIRESTONE 1T15M-6 GOODYEAR 1R12-706 BERTOJA 454 02004 DUNLOP D12B16 SMB M00 1472

Total Weight 11,2 kg

Description / Metal Piston	SEM NO.	REF. NO:
	<b>72.4156.C11</b>	CONTITECH 4156 N P11

Total Weight 10 kg

Description / Plastic Piston	SEM NO.	REF. NO:
	<b>72.4156.CP10</b>	HENDRICKSON HA 100016 CONTITECH 4156 N P10 FIRESTONE W01 358 8929 FIRESTONE 1T15M-6 GOODYEAR 1R12-461

Total Weight 6,6 kg

Description / Plastic Piston	SEM NO.	REF. NO:
	<b>72.4156.CP14</b>	HENDRICKSON B2066 NEWAY 90557075 NEWAY 90557037 ROR 21208939 CONTITECH 4156 N P14 PHOENIX 1 DK 23 K-9082 VIBRACOUSTIC V1DK23K-9082 GOODYEAR 1R12-092 GY SPRINGRIDE D12B33 Transpart 520 728

Total Weight 6,6 kg

REF. NO:	SEM NO.	Description / Plastic Piston
HENDRICKSON HA100001 Fruehauf M001472 ROR 2121 5761 CONTITECH 4156 N P15 PHOENIX 1 DK 23 K-1 FIRESTONE 1T15M-6 FIRESTONE W01-358-9361 CF GOMMA REF. 1T323-32 CF GOMMA NO. 207086 DUNLOP UK 00981B-AP WW US 35864	<b>72.4156.CP15</b>	 <p>Total Weight 6,6 kg</p>

REF. NO:	SEM NO.	Description / Plastic Piston
CONTITECH 4156 N P16	<b>72.4156.CP16</b>	 <p>Total Weight 7 kg</p>

REF. NO:	SEM NO.	Description / Service Assembly
CONTITECH 4156 N P01	<b>72.4156.S01</b>	 <p>Total Weight 4,5 kg</p>

REF. NO:	SEM NO.	Description / Service Assembly
CONTITECH 4156 N P05	<b>72.4156.S05</b>	 <p>Total Weight 4,5 kg</p>

Description / Service Assembly	SEM NO.	REF. NO:
--------------------------------	---------	----------



**72.4156.S12**

Total Weight 3,5 kg

Description / Plastic Piston	SEM NO.	REF. NO:
------------------------------	---------	----------



**72.4157.CP03**

FRUEHAUF M078580  
CONTITECH 4157 N P03  
GOODYEAR 1R11-881

Total Weight 6,6 kg

Description / Plastic Piston	SEM NO.	REF. NO:
------------------------------	---------	----------



**72.4157.CP04**

MERCEDES 9463281401  
ROR 21221307  
CONTITECH 4157 N P04  
FIRESTONE 1T15MPW-7  
FIRESTONE W01 M58 6297  
DUNLOP D12B18  
WW US 07364  
GOODYEAR 1R11-111  
TAURUS KR 915-54  
PHOENIX 1DK 21 A-4  
WW US 06287

Total Weight 6,6 kg

Description / Plastic Piston	SEM NO.	REF. NO:
------------------------------	---------	----------





**72.4157.CP05**

ROR 21222442  
CONTITECH 4157 N P05  
WW US 07074 C  
WW US 07074 P

Total Weight 6,6 kg

REF. NO:	SEM NO.	Description / Plastic Piston
SCHMITZ 751 065 CONTITECH 4157 N P06 FIRESTONE 1T15MPW-7 FIRESTONE W01 M58 8186 PHOENIX 1 DK 20 A-1 Weweler US 06316 GOODYEAR 1R11-764 DUNLOP D11B37	72.4157.CP06	
		Total Weight 6,6 kg

REF. NO:	SEM NO.	Description / Plastic Piston
NEWAY 90557233 CONTITECH 4157 N P08 DUNLOP D12B30 GOODYEAR 1R11-773 FIRESTONE 1T15MPW-7 FIRESTONE W01 M58 6317 PHOENIX 1 DK 20 C-2 SAMRO H 2501869 SMB M 078580	72.4157.CP08	
		Total Weight 6,2 kg

REF. NO:	SEM NO.	Description / Plastic Piston
ROR 21222442 CONTITECH 4157 N P09 FIRESTONE 1T15MPW-7 FIRESTONE W01 M58 7074 DUNLOP D12B17 WW US 07074 F GOODYEAR 1R11-106 PHOENIX 1 DK 21 A-31 TAURUS KR 913-57	72.4157.CP09	
		Total Weight 6,6 kg

REF. NO:	SEM NO.	Description / Plastic Piston
FRUEHAUF UJB0975 CONTITECH 4157 NP 10 FIRESTONE 1T15MPW-7 FIRESTONE W01 M58 6315 DUNLOP D12B29 GOODYEAR 1R11-772 ACERBI 128 140028 ACERBI 800 449526 SMB M 060924 PHOENIX 1 DK 20 A-51 TAURUS KR 915-51	72.4157.CP10	
		Total Weight 6,6 kg

Description / Service Assembly	SEM NO.	REF. NO:
--------------------------------	---------	----------

**72.4157.S**



Total Weight 4,6 kg

Description / Service Assembly	SEM NO.	REF. NO:
--------------------------------	---------	----------

**72.4157.S02**



Total Weight 4,6 kg

Description / Plastic Piston	SEM NO.	REF. NO:
------------------------------	---------	----------

**72.4158.CP03**



Total Weight 7,9 kg

SCHMITZ 014892  
SCHMITZ 750999  
CONTITECH 4158 N P03  
PHOENIX 1 DK 20 B-1  
VIBRACOUSTIC V1DK20B-1  
FIRESTONE 1T15MPW-9  
FIRESTONE W01-M58-8185  
WW US 06285  
FIRESTONE W01-M58-6285  
GOODYEAR 1R12-749  
GY SPRINGRIDE D12B22  
GART NO. 278.1.530  
GART REF. D278/HS

Description / Service Assembly	SEM NO.	REF. NO:
--------------------------------	---------	----------

**72.4158.S02**



Total Weight 4,7 kg

CONTITECH 4158 N P02  
PHOENIX 1 DK 20 B-1 NP  
VIBRACOUSTIC V1DK20B-1 NP  
FIRESTONE 1T15MPW-9  
FIRESTONE W01-M58-6257  
GOODYEAR 1R12-748  
GY SPRINGRIDE D12U23  
GART NO. 278.0.531

REF. NO:	SEM NO.	Description / Metal Piston
FRUEHAUF UJA 0894 FRUEHAUF UJB0203 CONTITECH 4159 N P03 FIRESTONE 1T15M-9 FIRESTONE W01 M58 8859 DUNLOP D12B01 PHOENIX 1 DK 21B-4 CF GOMMA 1 T 323-40	<b>72.4159.C03</b>	

Total Weight 9,6 kg

REF. NO:	SEM NO.	Description / Metal Piston
NEWAY 90557009 CONTITECH 4159 N P04	<b>72.4159.C04</b>	

Total Weight 9,6 kg

REF. NO:	SEM NO.	Description / Metal Piston
NEWAY 90557009 Fruehauf UJA0894001 ROR 21215891 CONTITECH 4159 N P04	<b>72.4159.C06</b>	

Total Weight 9,6 kg

REF. NO:	SEM NO.	Description / Metal Piston
GART NO. 278.2.511 GART REF. D278/H SMB 1518779 SMB 1524873 FRUEHAUF UJB0203001 CONTITECH 4159 N P07 PHOENIX 1 DK 23 L-25 VIBRACOUSTIC V1DK23B-9 FIRESTONE 1T15M-9 FIRESTONE W01-379-9091 FIRESTONE W01-M58-8859 GOODYEAR 1R12-702 SMB 1520356 SMB M001782 GY SPRINGRIDE D12B15 CF GOMMA REF. 1T323-40 CF GOMMA NO. 202302 DUNLOP UK 00982A-AP	<b>72.4159.C07</b>	

Total Weight 12,6 kg



Description / Metal Piston	SEM NO.	REF. NO:
	<b>72.4159.C08</b>	HENDRICKSON NA1817 CONTITECH 4159 N P08 GOODYEAR 1R12-281

Total Weight 9,6 kg

Description / Metal Piston	SEM NO.	REF. NO:
	<b>72.4159.C10</b>	CONTITECH 4159 N P10 FIRESTONE W01 M58 0736 FIRESTONE 1T15M-9

Total Weight 11,4 kg

Description / Metal Piston	SEM NO.	REF. NO:
	<b>72.4159.C15</b>	

Total Weight 11,4 kg

Description / Plastic Piston	SEM NO.	REF. NO:
	<b>72.4159.CP09</b>	Fruehauf UJA09030 Fruehauf UJB0358001 CONTITECH 4159 N P09 PHOENIX 1 DK 23 L-9131 VIBRACOUSTIC V1DK23L-9131 FIRESTONE 1T15M-9 FIRESTONE W01-M58-9131 GOODYEAR 1R12-721 GY SPRINGRIDE D12B04 CF GOMMA REF. 1T323-40 Cardi 58051210 SAMRO H2500324 SMB 1525199 SMB M001774 CF GOMMA NO.200751 GART NO. 278.1.510 GART REF. D278/H

Total Weight 7,1 kg

REF. NO:	SEM NO.	Description / Plastic Piston
HENDRICKSON B3842 CONTITECH 4159 N P11	<b>72.4159.CP11</b>	 <p>Total Weight 7,1 kg</p>

REF. NO:	SEM NO.	Description / Plastic Piston
NAVISTAR-FLEETRITE 554768C1 REYCO 12883-01 RIDEWELL S-5828-C RIDEWELL S-4740-C WATSON&CHALIN AS-0040	HENDRICKSON B3842 SAF 90557082 CONTITECH 4159 N P12 CONTITECH 9 10-19 P 315 FIRESTONE 1T15M-9 FIRESTONE W01 358 9101 GOODYEAR 1R12-717 TAURUS 6364 TRIANGLE 8315 DAYTON 352-9101 LOADGUARD Sc2038	<b>72.4159.CP12</b>   <p>Total Weight 7,1 kg</p>

REF. NO:	SEM NO.	Description / Plastic Piston
HENDRICKSON NA1817 HENDRICKSON S6195 SAF 90557086 SAF 90557135 CONTITECH 4159 N P13 CONTITECH 9 10-19 P 326 FIRESTONE 1T15M-9 FIRESTONE W01 358 9192 GOODYEAR 1R12-167 LOADGUARD SC2120 WATSON&CHALIN AS-0038 WATSON&CHALIN AS-0046 TRIANGLE 8326	<b>72.4159.CP13</b>	 <p>Total Weight 7,1 kg</p>

REF. NO:	SEM NO.	Description / Plastic Piston
Fruehauf UJA0894001 ROR 21215762 ROR 21226039 CONTITECH 4159 N P14 PHOENIX 1 DK 21 B-4 VIBRACOUSTIC V1DK21B-4 FIRESTONE 1T15M-9 FIRESTONE W01-M58-7548 Montenegro GOODYEAR 1R12-760 GY SPRINGRIDE D12B01 CF GOMMA REF. 1T323-40 CF GOMMA NO. 204124 DUNLOP UK PNP311370000	<b>72.4159.CP14</b>	 <p>Total Weight 7,1 kg</p>

Description / Service Assembly	SEM NO.	REF. NO:
	<b>72.4159.S01</b>	CONTITECH 4159 N P01 GOODYEAR 1R12-113

Total Weight 4,8 kg

Description / Service Assembly	SEM NO.	REF. NO:
	<b>72.4159.S05</b>	CONTITECH 4159 N P05 PHOENIX 1 DK 21 B-5 NP VIBRACOUSTIC V1DK21B-5 FIRESTONE 1T15M-9 FIRESTONE W01-M58-0736 GOODYEAR 1R12-761 GY SPRINGRIDE D12U04 CF GOMMA REF. 1T323-40 GART NO. 278.0.551 GART REF. D278/H

Total Weight 4,8 kg

Description / Metal Piston	SEM NO.	REF. NO:
	<b>72.4183.C01</b>	MERCEDES 9423202221 MERCEDES 9423201321 CONTITECH 4183 N P23

Total Weight 8,8 kg

Description / Metal Piston	SEM NO.	REF. NO:
	<b>72.4183.C24</b>	MERCEDES 9423202321 MERCEDES 9423201421 CONTITECH 4183 N P24

Total Weight 8,8 kg

REF. NO:	SEM NO.	Description / Service Assembly
CONTITECH 4183 N2	<b>72.4183.S1</b>	 <p>Total Weight 3,2 kg</p>

REF. NO:	SEM NO.	Description / Service Assembly
MERCEDES 9743280201 CONTITECH 4185 N	<b>72.4185.S1</b>	 <p>Total Weight 3,2 kg</p>

REF. NO:	SEM NO.	Description / Metal Piston
MERCEDES 9423200121 MERCEDES 9423204921 CONTITECH 4390 N P01 PHOENIX 1 KF 21-21 FIRESTONE 1R7Z-440-290 FIRESTONE W01-M58-8514 GOODYEAR 9505 VIBRACOUSTIC V1KF21-1	<b>72.4390.C01</b>	 <p>Total Weight 6,2 kg</p>

REF. NO:	SEM NO.	Description / Metal Piston
MERCEDES 9423200221 MERCEDES 9423202921 CONTITECH 4390 N P02 PHOENIX 1 KF 21-22 FIRESTONE 1R7Z-440-290 FIRESTONE W01-M58-8513 GOODYEAR 9506 VIBRACOUSTIC V1KF21-2	<b>72.4390.C02</b>	 <p>Total Weight 6,6 kg</p>

Description / Metal Piston	SEM NO.	REF. NO:
	<b>72.4390.C03</b>	MERCEDES 9423200421 MERCEDES 9423205221 CONTITECH 4390 N P03 VIBRACOUSTIC V1KF21-4-232 GOODYEAR 9563

Total Weight 6,6 kg

Description / Metal Piston	SEM NO.	REF. NO:
	<b>72.4390.C04</b>	MERCEDES 9423200321 MERCEDES 9423205121 CONTITECH 4390 N P04 GOODYEAR 9564 VIBRACOUSTIC V1KF21-3-232

Total Weight 6,6 kg

Description / Metal Piston	SEM NO.	REF. NO:
	<b>72.4390.C21</b>	MERCEDES 9423200121 MERCEDES 9423204921 CONTITECH 4390 N P21 PHOENIX 1 KF 21-21 FIRESTONE 1R7Z-440-290 FIRESTONE W01-M58-8514 GOODYEAR 9505 VIBRACOUSTIC V1KF21-1

Total Weight 6,6 kg

Description / Metal Piston	SEM NO.	REF. NO:
	<b>72.4390.C22</b>	MERCEDES 9423200221 MERCEDES 9423205021 CONTITECH 4390 N P22 PHOENIX 1 KF 21-22 FIRESTONE 1R7Z-440-290 FIRESTONE W01-M58-8513 GOODYEAR 9506 VIBRACOUSTIC V1KF21-2

Total Weight 6,6 kg

REF. NO:	SEM NO.	Description / Metal Piston
MERCEDES 9423200421 MERCEDES 9423205221 CONTITECH 4390 N P23 GOODYEAR 9563 VIBRACOUSTIC V1KF21-4-232	<b>72.4390.C23</b>	 <p>Total Weight 6,6 kg</p>

REF. NO:	SEM NO.	Description / Metal Piston
MERCEDES 9423200321 MERCEDES 9423205121 CONTITECH 4390 N P04 GOODYEAR 9564 VIBRACOUSTIC V1KF21-3-232	<b>72.4390.C24</b>	 <p>Total Weight 6,6 kg</p>

REF. NO:	SEM NO.	Description / Service Assembly
MERCEDES 9423280001 CONTITECH 4390 N1 PHOENIX 1 KF 21-1 NP FIRESTONE 1R7Z-440-290-B FIRESTONE W01-M58-0904 GOODYEAR 9507 GY SPRINGRIDE D12U25 CF GOMMA REF. 1VSC285-30 CF GOMMA NO. 206782 GART NO. 304.0.440 GART REF. C304 VIBRACOUSTIC V1KF21-1 NP	<b>72.4390.S1</b>	 <p>Total Weight 2,5 kg</p>

REF. NO:	SEM NO.	Description / Service Assembly
MERCEDES 9423280101 CONTITECH 4390 N2 PHOENIX 1 KF 21-2 NP FIRESTONE 1R7Z-440-290-C FIRESTONE W01-M58-0905 GOODYEAR 9508 GY SPRINGRIDE D12U26 CF GOMMA REF. 1VSC285-30 CF GOMMA NO. 206784 GART NO. 304.0.441 GART REF. C304 VIBRACOUSTIC V1KF21-2 NP	<b>72.4390.S2</b>	 <p>Total Weight 2,5 kg</p>

Description / Metal Piston	SEM NO.	REF. NO:
	<b>72.4420.C01</b>	VOLVO 1076075 VOLVO 20554756 CONTITECH 4420 N P01 FIRESTONE 1T17BR-8 FIRESTONE W01-M58-9707 GART NO. 278.1.355 GART REF. D278/V1

Total Weight 8,8 kg

Description / Service Assembly	SEM NO.	REF. NO:
	<b>72.4420.S</b>	

Total Weight 3,9 kg

Description / Roll	SEM NO.	REF. NO:
	<b>72.450.R25</b>	EVOBUS 3563270001 EVOBUS 3563270201 IVECO 93197594 MERCEDES 3563270001 MERCEDES 6133270101 CONTITECH RZ 450-R25 PHOENIX 1 E 23 VIBRACOUSTIC V1E23 GOODYEAR 9050 GY SPRINGRIDE D12S13 CF GOMMA REF. 1S300-27 CF GOMMA NO. 203386

Total Weight 1,5 kg

Description / Service Assembly	SEM NO.	REF. NO:
	<b>72.4644.S</b>	EVOBUS 6293270001 CONTITECH 4644 N GOODYEAR 9561

Total Weight 1,9 kg

REF. NO:	SEM NO.	Description / Service Assembly
MAN 81436010155 CONTITECH 4705 N1 P01 GART NO. 302.0.521 GART REF. C302/B	<b>72.4705.S01</b>	 <p>Total Weight 5,5 kg</p>

REF. NO:	SEM NO.	Description / Metal Piston
VOLVO 1076594 CONTITECH 4713 N P02 PHOENIX 1 DF 22 C-1 FIRESTONE 1T17BR-8 FIRESTONE W01-M58-9706 GOODYEAR 1R12-762 GY SPRINGRIDE D12B24 CF GOMMA REF. 1TS300-28 CF GOMMA NO. 206778 GART NO. 293.1.460 GART REF. 293.1.460 VIBRACOUSTIC V1DF22C-1	<b>72.4713.C02</b>	 <p>Total Weight 8 kg</p>

REF. NO:	SEM NO.	Description / Service Assembly
VOLVO 1076595 CONTITECH 4713 N P04 GOODYEAR 1R12-763 GY SPRINGRIDE D12U24 CF GOMMA REF. 1TS300-28 GART NO. 293.0.461 GART REF. C293/V	<b>72.4713.S</b>	 <p>Total Weight 4 kg</p>

REF. NO:	SEM NO.	Description / Metal Piston
VOLVO 1075363 VOLVO 20554759 CONTITECH 4718 N P01 GOODYEAR 1R12-821 GART NO. 278.1.470 GART REF. D278/V	<b>72.4718.C01</b>	 <p>Total Weight 9,5 kg</p>



Description / Service Assembly	SEM NO.	REF. NO:
	<b>72.4718.S</b>	VOLVO 1079718 CONTITECH 4718 N P02

Total Weight 4,2 kg

Description / Metal Piston	SEM NO.	REF. NO:
	<b>72.4737.C01</b>	MERCEDES 9463200321 CONTITECH 4737 N P01

Total Weight 8,5 kg

Description / Metal Piston	SEM NO.	REF. NO:
	<b>72.4737.C02</b>	MERCEDES 9463200521 CONTITECH 4737 N P02

Total Weight 8,3 kg

Description / Metal Piston	SEM NO.	REF. NO:
	<b>72.4737.C21</b>	MERCEDES 9423203721 CONTITECH 4737 N P21

Total Weight 8,4 kg

REF. NO:	SEM NO.	Description / Metal Piston
MERCEDES 9423203921 CONTITECH 4737 N P22	<b>72.4737.C22</b>	 <p>Total Weight 8 kg</p>

REF. NO:	SEM NO.	Description / Service Assembly
CONTITECH 4737 N	<b>72.4737.S1</b>	 <p>Total Weight 2,4 kg</p>

REF. NO:	SEM NO.	Description / Metal Piston
MERCEDES 9423200117 MERCEDES 9423204321 CONTITECH 4757 N P01 PHOENIX 1 KF 24-21 FIRESTONE 1R7Z-460-305-A FIRESTONE W01-M58-8521 GOODYEAR 9519 GY SPRINGRIDE D13T01 VIBRACOUSTIC V1KF24-1-232	<b>72.4757.C01</b>	 <p>Total Weight 7,7 kg</p>

REF. NO:	SEM NO.	Description / Metal Piston
MERCEDES 9423203221 MERCEDES 9743200217 CONTITECH 4757 N P09 PHOENIX 1 KF 24-29 FIRESTONE 1R7Z-460-305-B FIRESTONE W01-M58-8522 GOODYEAR 9520 GY SPRINGRIDE D13T02 VIBRACOUSTIC V1KF24-2-232	<b>72.4757.C09</b>	 <p>Total Weight 7,5 kg</p>

Description / Metal Piston	SEM NO.	REF. NO:
	<b>72.4757.C21</b>	MERCEDES 9423200117 MERCEDES 9423204321 CONTITECH 4757 N P21 PHOENIX 1 KF 24-21 FIRESTONE 1R7Z-460-305-A FIRESTONE W01-M58-8521 GOODYEAR 9519 GY SPRINGRIDE D13T01 VIBRACOUSTIC V1KF24-1-232

Total Weight 9,3 kg

Description / Metal Piston	SEM NO.	REF. NO:
	<b>72.4757.C29</b>	MERCEDES 9423203221 MERCEDES 9743200217 CONTITECH 4757 N P29 PHOENIX 1 KF 24-29 FIRESTONE 1R7Z-460-305-B FIRESTONE W01-M58-8522 GOODYEAR 9520 GY SPRINGRIDE D13T02 VIBRACOUSTIC V1KF24-2-232

Total Weight 9 kg

Description / Service Assembly	SEM NO.	REF. NO:
	<b>72.4757.S1</b>	MERCEDES 9423270001 CONTITECH 4757 N1 PHOENIX 1 KF 24-1 NP FIRESTONE 1R7Z-460-305-A GART REF. C299/A FIRESTONE W01-M58-0909 GOODYEAR 9517 GY SPRINGRIDE D13U42 GART NO. 299.0.461 VIBRACOUSTIC V1KF24-1-230 NP

Total Weight 2,5 kg

Description / Service Assembly	SEM NO.	REF. NO:
	<b>72.4757.S2</b>	MERCEDES 9743280001 MERCEDES 9743280101 CONTITECH 4757 N2 PHOENIX 1 KF 24-2 NP FIRESTONE 1R7Z-460-305-B FIRESTONE W01-M58-0910 GOODYEAR 9518 GY SPRINGRIDE D13U43 GART NO. 299.0.460 GART REF. C299/A VIBRACOUSTIC V1KF24-2-230 NP

Total Weight 3,3 kg

REF. NO:	SEM NO.	Description / Metal Piston
MERCEDES 9423204821 MERCEDES 9453200017 CONTITECH 4758 N P21	<b>72.4758.C21</b>	 <p>Total Weight 7,4 kg</p>

REF. NO:	SEM NO.	Description / Service Assembly
MERCEDES 9453270001 CONTITECH 4758 N	<b>72.4758.S1</b>	 <p>Total Weight 2,4 kg</p>

REF. NO:	SEM NO.	Description / Metal Piston
MERCEDES 9423200217 CONTITECH 4759 N P01	<b>72.4759.C</b>	

REF. NO:	SEM NO.	Description / Service Assembly
MERCEDES 9423270401 CONTITECH 4759 N P01	<b>72.4759.S1</b>	

Description / Service Assembly	SEM NO.	REF. NO:
--------------------------------	---------	----------

**72.4759.S2**



Description / Metal Piston	SEM NO.	REF. NO:
----------------------------	---------	----------

**72.4760.C**

VOLVO 20554760  
VOLVO 21961472  
CONTITECH 6612 N P01



Total Weight 8,5 kg

Description / Service Assembly	SEM NO.	REF. NO:
--------------------------------	---------	----------

**72.4760.S**



Total Weight 4,5 kg

Description / Metal Piston	SEM NO.	REF. NO:
----------------------------	---------	----------

**72.4810.C05**

SAF 3228002700  
SAF 3229222700  
CONTITECH 4810 N P05  
PHOENIX 1 D 28 A-10  
Taurus KR621-18  
VIBRACOUSTIC V1D28A-10  
FIRESTONE 1T19L-7  
FIRESTONE W01-M58-6338  
GOODYEAR 1R14-730  
GY SPRINGRIDE D13B25  
CF GOMMA REF. 1T19E-1  
CF GOMMA NO. 205456

GART NO. 277.4.423  
GART NO. 277.4.424/1  
GART REF. D277/B





Total Weight 12 kg

REF. NO:	SEM NO.	Description / Service Assembly
	<b>72.4810.S</b>	 <p>Total Weight 5 kg</p>

REF. NO:	SEM NO.	Description / Metal Piston
CF GOMMA REF. 1T19E-2BR CF GOMMA NO. 97764 GART NO. 287.0.520 GART REF. D287	<b>72.4813.C07</b>	 <p>Total Weight 11,5 kg</p>

REF. NO:	SEM NO.	Description / Service Assembly
	<b>72.4813.S</b>	 <p>Total Weight 5,5 kg</p>

REF. NO:	SEM NO.	Description / Metal Piston
SCHMITZ 17924 SCHMITZ FAG041-0087 MERCEDES 9463281501 VIBRACOUSTIC V1DK28F-3 GOODYEAR 1R14-823 WW US 04030P FIRESTONE 1T19L-11 FIRESTONE W01 M58 6223 WW US 04030G	<b>72.4823.C</b>	 <p>Total Weight 14 kg</p>

Description / Metal Piston	SEM NO.	REF. NO:
	<b>72.4838.C01</b>	MERCEDES 9423203821 MERCEDES 9463200421 CONTITECH 4838 N P01 FIRESTONE 1R7Z-595-330-A FIRESTONE W01-M58-8512 VIBRACOUSTIC V1KF25-1-232

Total Weight 8,2 kg

Description / Metal Piston	SEM NO.	REF. NO:
	<b>72.4838.C02</b>	MERCEDES 9423203621 MERCEDES 9463200221 CONTITECH 4838 N P02 VIBRACOUSTIC V1KF25-2-232

Total Weight 9,9 kg

Description / Metal Piston	SEM NO.	REF. NO:
	<b>72.4838.C03</b>	MERCEDES 9423203521 MERCEDES 9463200121 CONTITECH 4838 N P03 VIBRACOUSTIC V1KF25-3-232

Total Weight 10 kg

Description / Metal Piston	SEM NO.	REF. NO:
	<b>72.4838.C21</b>	MERCEDES 9423203821 MERCEDES 9463200421 CONTITECH 4838 N P21 FIRESTONE 1R7Z-595-330-A FIRESTONE W01-M58-8512 VIBRACOUSTIC V1KF25-1-232

Total Weight 8,8 kg

REF. NO:	SEM NO.	Description / Metal Piston
MERCEDES 9423203621 MERCEDES 9463200221 CONTITECH 4838 N P22 VIBRACOUSTIC V1KF25-2-232	<b>72.4838.C22</b>	 <p>Total Weight 10 kg</p>

REF. NO:	SEM NO.	Description / Metal Piston
MERCEDES 9423203521 MERCEDES 9463200121 CONTITECH 4838 N P23 VIBRACOUSTIC V1KF25-3-232	<b>72.4838.C23</b>	 <p>Total Weight 11 kg</p>

REF. NO:	SEM NO.	Description / Service Assembly
CONTITECH 4838 N1	<b>72.4838.S1</b>	 <p>Total Weight 2,9 kg</p>

REF. NO:	SEM NO.	Description / Metal Piston
CONTITECH 4881 MB FIRESTONE 1T66F-7.0 FIRESTONE W01 M58 8602 GOODYEAR 1R14-724 PHOENIX 1 DK 32 K-1 DUNLOP D14B37	<b>72.4881.C</b>	 <p>Total Weight 16 kg</p>



Description / Plastic Piston	SEM NO.	REF. NO:
	<b>72.4881.CP</b>	BPW 0542943410 (36 K) CONTITECH 4881 NP30 PHOENIX 1 DK 32 K-2 FIRESTONE 1T66F-7.0 FIRESTONE W01-M58-8666 GOODYEAR 1R14-757 GY SPRINGRIDE D14B44 VIBRACOUSTIC V1DK32K Y10

Total Weight 12,2 kg

Description / Service Assembly	SEM NO.	REF. NO:
	<b>72.4881.S02</b>	BPW 542941010 SCHMITZ 750570 CONTITECH 4881 NP02 PHOENIX 1 DK 32 K FIRESTONE 1T66D-7 FIRESTONE W01-M58-8601 GART REF. C292/A GOODYEAR 1R14-701 GY SPRINGRIDE D14U37 CF GOMMA REF. 1TC360-40 CF GOMMA NO. 205537 GART NO. 292.0.461 VIBRACOUSTIC V1DK32K

Total Weight 6,2 kg

Description / Metal Piston	SEM NO.	REF. NO:
	<b>72.4882.C05</b>	MAN 81436006036 MAN 81436006056 CONTITECH 4882 N P05 PHOENIX 1 DF 16-2 FIRESTONE 1T17TWR-8 GART REF. C289/M FIRESTONE W01-M58-9880 CF GOMMA REF. 1TS260-28 CF GOMMA NO. 206788 GART NO. 206788 VIBRACOUSTIC V1DF16-2

Total Weight 7,9 kg

Description / Service Assembly	SEM NO.	REF. NO:
	<b>72.4882.S02</b>	MAN 81436010151 MAN 81436010176 CONTITECH 4882 N1 P01 PHOENIX 1 DF 16-2 NP GART REF. C289/M GOODYEAR 1R10-702 GY SPRINGRIDE D10U01 GART NO. 289.0.512 VIBRACOUSTIC V1DF16-2 NP

Total Weight 4,3 kg

REF. NO:	SEM NO.	Description / Metal Piston
MAN 81436006037 CONTITECH 4883 N1 P06 GOODYEAR 1R11-884	<b>72.4883.C05</b>	 <p>Total Weight 10,5 kg</p>

REF. NO:	SEM NO.	Description / Service Assembly
MAN 81436010153 CONTITECH 4883 N1 P01 GOODYEAR 1R11-804 GY SPRINGRIDE D11U47 GART NO. 304.0.513 GART REF. C304/M3 VIBRACOUSTIC V1DF19C-1	<b>72.4883.S02</b>	 <p>Total Weight 5 kg</p>

REF. NO:	SEM NO.	Description / Metal Piston
MAN 81436006035 MAN 81436006055 CONTITECH 4884 N1 P06 PHOENIX 1 DF 19 B-1 VIBRACOUSTIC V1DF19B-1 FIRESTONE 1T17JR-7.2 FIRESTONE W01-M58-9879 CF GOMMA REF. 1TS290-28 CF GOMMA NO. 206787 GART NO. 304.1.510 GART REF. C304/M4 GOODYEAR 1R11-861	<b>72.4884.C06</b>	 <p>Total Weight 10,5 kg</p>

REF. NO:	SEM NO.	Description / Service Assembly
CONTITECH 4884 N1 P01 PHOENIX 1 DF 19 B-1 NP VIBRACOUSTIC V1DF19B-1 NP GOODYEAR 1R11-820 GY SPRINGRIDE D11U48 GART NO. 304.0.511 GART REF. C304/M4	<b>72.4884.S02</b>	

Description / Metal Piston	SEM NO.	REF. NO:
	<b>72.4911.C03</b>	RVI 5010294308 C CONTITECH 4911 N P03 GOODYEAR 1R13-739 GOODYEAR ex 1R13-714 GY SPRINGRIDE D13B41 GART NO. 287.1.540 GART REF. D287/E

Total Weight 13,3 kg

Description / Service Assembly	SEM NO.	REF. NO:
	<b>72.4911.S02</b>	CONTITECH 4911 N P02 GOODYEAR 1R13-715

Total Weight 9,5 kg

Description / Metal Piston	SEM NO.	REF. NO:
	<b>72.4912.C07</b>	RVI 5010294307 CONTITECH 4912 C07 PHOENIX 1 DK 28 F-4 FIRESTONE 1T19L-14 FIRESTONE W01-M58-8786 GOODYEAR 1R13-738 CF GOMMA REF. 1T19E-4 CF GOMMA NO. 206779 GART NO. 287.1.600 GART REF. D287/C GOODYEAR ex 1R13-711 VIBRACOUSTIC V1DK28F-4 GY SPRINGRIDE D13B40

Total Weight 13,2 kg

Description / Metal Piston	SEM NO.	REF. NO:
	<b>72.4912.C10</b>	RVI 5010557355 VOLVO 20722412 CONTITECH 4912 N P10 GOODYEAR 1R13-753 PHOENIX 1 DK 28 F-5

Total Weight 13,7 kg

REF. NO:	SEM NO.	Description / Service Assembly
RVI 5001832067 CONTITECH 4912 N P08 GOODYEAR 1R13-713 CF GOMMA REF. 1T19E-4 CF GOMMA NO. 206780 GART NO. 287.0.601 GART REF. D287/C	<b>72.4912.S08</b>	 <p>Total Weight 6,5 kg</p>

REF. NO:	SEM NO.	Description / Service Assembly
RVI 5010557355 VOLVO 20722412 CONTITECH 4912 N P10 GOODYEAR 1R13-753 PHOENIX 1 DK 28 F-5	<b>72.4912.S10</b>	 <p>Total Weight 12,6 kg</p>

REF. NO:	SEM NO.	Description / Metal Piston
CF GOMMA REF. 1T19E-93 CF GOMMA NO. 206201 DUNLOP UK 00937A-AP GART NO 282.1.600 VIBRACOUSTIC V1D28H-16 GY SPRINGRIDE D14B42	SCANIA 1379392 SCANIA 1440294 CONTITECH 4913 N P02 PHOENIX 1 D 28 H-16 FIRESTONE 1T19L-14 FIRESTONE W01-M58-9881 FIRESTONE W01-095-0500 GART REF. C282/H GOODYEAR 1R14-753	<b>72.4913.C02</b>  <p>Total Weight 12,3 kg</p>

REF. NO:	SEM NO.	Description / Service Assembly
SCANIA 1379393 CONTITECH 4913 N P04 PHOENIX 1 D 28 H-16 NP FIRESTONE 1T19L-14 FIRESTONE W01-095-0365 GOODYEAR 1R14-755 GY SPRINGRIDE D14U42 CF GOMMA REF. 1T19E-93 GART NO. 282.0.601 GART REF. C282/H	<b>72.4913.S04</b>	 <p>Total Weight 8,5 kg</p>

Description / Metal Piston	SEM NO.	REF. NO:
	<b>72.4915.C06</b>	RVI 5010294309 CONTITECH 4915 N P06 PHOENIX 1 DK 19-1 VIBRACOUSTIC V1DK19-1

Total Weight 10,6 kg

Description / Service Assembly	SEM NO.	REF. NO:
	<b>72.4915.S03</b>	RVI 5001855856 CONTITECH 4915 N P03

Total Weight 5,5 kg

Description / Metal Piston	SEM NO.	REF. NO:
	<b>72.4929.C</b>	RVI 7420767358 CONTITECH 4929 N P01 RT

Total Weight 8 kg

Description / Service Assembly	SEM NO.	REF. NO:
	<b>72.4929.S</b>	

Total Weight 4,5 kg

REF. NO:	SEM NO.	Description / Plastic Piston
SCANIA 1434930 FIRESTONE 1T15UR-9 FIRESTONE WQ01 M58 8653	<b>72.4930.CP</b>	

Total Weight 8 kg

REF. NO:	SEM NO.	Description / Metal Piston
SCANIA 1434933 FIRESTONE 1T15UR-9 FIRESTONE WQ01 M58 8633	<b>72.4933.C</b>	

Total Weight 7 kg

REF. NO:	SEM NO.	Description / Service Assembly
BPW 0542941560 BPW TYPE 30 K CONTITECH 4940 N P02 GOODYEAR 1R11-799 GY SPRINGRIDE D11U42	<b>72.4940.S02</b>	

Total Weight 4,5 kg

REF. NO:	SEM NO.	Description / Metal Piston
BPW 0542943250 CONTITECH 4941 MB	<b>72.4941.C</b>	

Total Weight 7,8 kg

Description / Service Assembly	SEM NO.	REF. NO:
	<b>72.4941.S02</b>	BPW 0542941250 BPW TYPE 30 CONTITECH 4941 N P02 GOODYEAR 1R11-802 GY SPRINGRIDE D11U45 GART NO. 293.0.513 GART REF. C293

Total Weight 5 kg

Description / Service Assembly	SEM NO.	REF. NO:
	<b>72.4942.S02</b>	BPW 0542941090 BPW TYPE 36-2 CONTITECH 4942 N P02 GART REF. C293 GART NO. 293.0.514

Total Weight 7,7 kg

Description / Service Assembly	SEM NO.	REF. NO:
	<b>72.4960.S02</b>	BPW 0542941770 BPW TYPE 30 K CONTITECH 4960 N P02 PHOENIX 1 DK 21 K-3 VIBRACOUSTIC V1DK21K-3 GOODYEAR 1R11-801 GY SPRINGRIDE D11U44 GART NO. 293.0.412 GART REF. C292/A

Total Weight 4,5 kg

Description / Service Assembly	SEM NO.	REF. NO:
	<b>72.4961.S02</b>	BPW 0542942040 BPW TYPE 30 K CONTITECH 4961 N P02 GOODYEAR 1R11-800 GY SPRINGRIDE D11U43 GART NO. 292.0.414 GART REF. C292/A

Total Weight 4,7 kg

REF. NO:	SEM NO.	Description / Service Assembly
BPW 0542942030 BPW TYPE 30 CONTITECH 4962 N P02 GOODYEAR 1R11-803 GY SPRINGRIDE D11U46	<b>72.4962.S02</b>	 <p>Total Weight 5,1 kg</p>

REF. NO:	SEM NO.	Description / Metal Piston
ROR MLF 7146 SCANIA 1386199 GOODYEAR 1R13-744	<b>72.6199.C</b>	 <p>Total Weight 10,5 kg</p>

REF. NO:	SEM NO.	Description / Service Assembly
	<b>72.6199.S</b>	 <p>Total Weight 4 kg</p>

REF. NO:	SEM NO.	Description / Metal Piston
ROR MLF 7167 SCANIA 1386200 GOODYEAR 1R13-745	<b>72.6200.C</b>	 <p>Total Weight 10,7 kg</p>



Description / Service Assembly	SEM NO.	REF. NO:
--------------------------------	---------	----------

**72.6200.S**



Total Weight 4,5 kg

Description / Plastic Piston	SEM NO.	REF. NO:
------------------------------	---------	----------

**72.6318.CP**

SCHMITZ 016512  
FIRESTONE 1T15MPW-9  
FIRESTONE W01 M58 6318  
WW US 06318 F



Total Weight 6,5 kg

Description / Service Assembly	SEM NO.	REF. NO:
--------------------------------	---------	----------

**72.6318.S**



Total Weight 4,5 kg

Description / Metal Piston	SEM NO.	REF. NO:
----------------------------	---------	----------

**72.6416.C**

VOLVO 1075891  
VOLVO 20531985  
CONTITECH 6608 N P01  
PHOENIX 1 DF 17 B-1  
VIBRACOUSTIC V1DF16D-1  
FIRESTONE 1T15UR-9  
GART REF. C295/V  
FIRESTONE W01-M58-8474  
GOODYEAR 1R10-704  
GY SPRINGRIDE D10B01  
GART NO. 295.1.465



Total Weight 6,2 kg

REF. NO:	SEM NO.	Description / Service Assembly
----------	---------	--------------------------------

**72.6416.S**



Total Weight 3,7 kg

REF. NO:	SEM NO.	Description / Metal Piston
----------	---------	----------------------------

VOLVO 1076418  
 VOLVO 20582214  
 CONTITECH 6607 N P01  
 PHOENIX 1 DF 17 A-1  
 VIBRACOUSTIC V1DF16C-1  
 FIRESTONE 1T15UR-6  
 FIRESTONE W01-M58-8473  
 GOODYEAR 1R10-707  
 GART NO. 294.1.400  
 GART REF. C294/VA

**72.6418.C**



Total Weight 6 kg

REF. NO:	SEM NO.	Description / Service Assembly
----------	---------	--------------------------------

**72.6418.S**



Total Weight 3 kg

REF. NO:	SEM NO.	Description / Metal Piston
----------	---------	----------------------------

VOLVO 21961447  
 VOLVO 20582212  
 CONTITECH 6606 N P02

**72.6420.C**



Total Weight 5,2 kg

Description / Service Assembly	ŞEM NO.	REF. NO:
--------------------------------	---------	----------

**72.6420.S**



Total Weight 3,2 kg

Description / Roll	ŞEM NO.	REF. NO:
--------------------	---------	----------

**72.644.R**



Total Weight 1,4 kg

BPW 0220024400	CONTITECH 644 N	Büssing 536 905 265
EVOBUS 0003270101	PHOENIX 1 E 21	Büssing 536 905 266
EVOBUS 3273270001	Taurus BL121	Daewoo 96708659
MAN 81436010017	VIBRACOUSTIC V1E21	Hanomag 546 905 134
MERCEDES 0003270101	FIRESTONE 1R1A390 295	Kögel
MERCEDES 6133270001	FIRESTONE W01 095 0118	VDL Bus 0 689 677
NEOPLAN 100110300	GOODYEAR 8017	Temsa
NEOPLAN 100112254	GY SPRINGRIDE D11S01	
VANHOOL 624319 420	CF GOMMA REF. 1S285 24	
VANHOOL 624319 610	CF GOMMA NO. 92574	
VOLVO 1134445	DUNLOP UK PNP301470102	
VOLVO 1622111	GART NO. 276.0.390	
Kässbohrer 4771143000	GART REF. D276/B	
Kässbohrer 4771441000	SMB	
Magirus Deutz 536905265	BredaMenarini 199 196	

Description / Roll	ŞEM NO.	REF. NO:
--------------------	---------	----------

**72.661.R**



Total Weight 1,8 kg

Magirus-Deutz 02498667	CONTITECH 661 N	
Magirus-Deutz 041822247	PHOENIX 1 E 25	
Kässbohrer 4731012000	VIBRACOUSTIC V1E25( 2)	
Kässbohrer 4771427000	FIRESTONE 1R1C390 310	
MERCEDES 6133270201	FIRESTONE W01 095 0021	
VANHOOL 624319670	GOODYEAR 8018	
VANHOOL 624319700	Büssing 831 120 144	
NEOPLAN 100112250	CF GOMMA REF. 1S310 28	
NEOPLAN AA1001001	CF GOMMA NO. 91016	
EvoBus 4103270001	GART NO. 297.0.390	
VOLVO 624319690	GART REF. D297	
SCHMITZ 750208	DUNLOP UK PNP304980101	
IVECO 4746733	GY SPRINGRIDE D12S02	
IVECO 4746733	Büssing 546 905 134	
MAN 90831120144	Hanomag 536 905 265	
	IRISBUS 5001829866	
	RABA	

Description / Roll	ŞEM NO.	REF. NO:
--------------------	---------	----------

**72.662.R**



Total Weight 2,4 kg

MAN 81436010018	GOODYEAR 9007	
MAN 81436010051	GY SPRINGRIDE D13S01	
NEOPLAN 100110200	CF GOMMA REF. 1SC360-30	
NEOPLAN AA1001002	CF GOMMA NO. 92594	
SCHMITZ 750209	DUNLOP UK PNP302730101	
CONTITECH 662 N	Floor 848	
PHOENIX 1 E 32	SMB	
VIBRACOUSTIC V1E32	VDL Bus 0 578 361	
FIRESTONE 1R1D355-355	Kögel	
FIRESTONE W01-095-0207	Wackenhut	
Büssing 100 110 200		
Büssing 100 112 251		

REF. NO:	ŞEM NO.	Description / Roll
FIRESTONE W01-095-0198 BredaMenarini 178 623 GOODYEAR 9051 GY SPRINGRIDE D11S06 CF GOMMA REF. 1SC285-22 CF GOMMA NO. 88786 GART NO. 276.0.370 GART REF. D276/C BredaMenarini 325 993	Magirus-Deutz 02491566 EVOBUS 3833270001 EVOBUS 6213280001 MERCEDES 3833270001 VANHOOL 624319860 VDL Bus CONTITECH 673 N PHOENIX 1 F 21 A Taurus B141 VIBRACOUSTIC V1F21A FIRESTONE 1R1A370-285	<b>72.673.R</b> 

Total Weight 1,5 kg

REF. NO:	ŞEM NO.	Description / Roll
MAN 81436010096 MAN 81436010127 CONTITECH 706 N GOODYEAR 9067 GY SPRINGRIDE D12S16	<b>72.706.R</b> 	

Total Weight 2 kg

REF. NO:	ŞEM NO.	Description / Roll
VOLVO 1622116 VOLVO 6797169 CONTITECH 713 N PHOENIX 1 F 21 D VIBRACOUSTIC V1F21D GOODYEAR 9066 GY SPRINGRIDE D12S15	<b>72.713.R</b> 	

Total Weight 1,7 kg

REF. NO:	ŞEM NO.	Description / Roll
PHOENIX 1 F 25 VIBRACOUSTIC V1F25 FIRESTONE 1R1C335-310 FIRESTONE W01-095-0087 GOODYEAR 8015 CF GOMMA REF. 1SC310-16 CF GOMMA NO. 93518 DUNLOP UK PNP304890101 IRISBUS 5000819517	Magirus-Deutz 04456111 MERCEDES 3633280001 VOLVO 6885533 IVECO 4456111 IVECO 4763473 RVI 5000819517 MAN 81436010059 MAN 81436010083 VDL Bus 0659561 CONTITECH 715 N	<b>72.715.R</b> 

Total Weight 2 kg

Description / Roll	SEM NO.	REF. NO:
 <p>Total Weight 2,2 kg</p>	<b>72.716.R</b>	VOLVO 1593842 MAN 81436010039 MAN 81436010040 CONTITECH 716 N PHOENIX 1 F 26 B-1 VIBRACOUSTIC V1F26B-1 FIRESTONE 1R2A450-305 CF GOMMA NO. 92548 FIRESTONE W01-095-0145 GOODYEAR 9073 GY SPRINGRIDE D12S19 CF GOMMA REF. 1SC300-34

Description / Roll	SEM NO.	REF. NO:
 <p>Total Weight 2,8 kg</p>	<b>72.719.R</b>	Kässbohrer 4731032000 NEOPLAN 100110100 NEOPLAN 102100200 SCHMITZ 750215 DAF 818225 BPW 0220024000 Kögel 4731032000 GIGANT 196036 GIGANT 166205 CONTITECH 719 N PHOENIX 1 F 32 B VIBRACOUSTIC V1F32B FIRESTONE 1R2D530-360 FIRESTONE W01-095-0192 GOODYEAR 8118 CF GOMMA REF.1SC360-43 CF GOMMA NO. 92593 DUNLOP UK PNP304620101 SMB

Description / Roll	SEM NO.	REF. NO:
 <p>Total Weight 1,2 kg</p>	<b>72.720.R</b>	MERCEDES 3873280101 NEOPLAN 100112300 VOLVO 1590136 VOLVO 1629193 BPW 0220024100 MAN 81436010033 MAN 81436010036 Pegaso Jonckheere CONTITECH 720 N PHOENIX 1 F 21 VIBRACOUSTIC V1F21 FIRESTONE 1R2A460-295 DUNLOP UK PNP301000100 FIRESTONE W01-095-0195 GOODYEAR 9008 GY SPRINGRIDE D12S04 CF GOMMA REF. 1SC290-30 CF GOMMA NO. 88802

Description / Metal Piston	SEM NO.	REF. NO:
 <p>Total Weight 10,5 kg</p>	<b>72.724.C02</b>	CONTITECH 724 N P02 GIGANT 166225 3053

REF. NO:	SEM NO.	Description / Metal Piston
CONTITECH 724 N P03 GIGANT 166 259	<b>72.724.C03</b>	 <p>Total Weight 10,5 kg</p>

REF. NO:	SEM NO.	Description / Service Assembly
CONTITECH 724 N P01 GIGANT 246 169 / 3053	<b>72.724.S01</b>	 <p>Total Weight 5,5 kg</p>

REF. NO:	SEM NO.	Description / Metal Piston
CONTITECH 725 N P02 VIBRACOUSTIC V1DF32-166217 FIRESTONE 1T66E-10.8 FIRESTONE W01-M58-896 GOODYEAR 1R14-747 Gigant 3653 compl. GOODYEAR 1R14-813 GY SPRINGRIDE D14B40 GART NO. 292.1.533 GART REF. C292/S Gigant 166217	<b>72.725.C02</b>	 <p>Total Weight 12,5 kg</p>

REF. NO:	SEM NO.	Description / Metal Piston
CONTITECH 725 N P03 VIBRACOUSTIC V1DF32-166252 FIRESTONE 1T66D-10.8 FIRESTONE W01-M58-8610 GART REF. C292/S Gigant 3653 compl. GOODYEAR 1R14-756 GOODYEAR 1R14-814 GY SPRINGRIDE D14B43 GART NO. 292.1.534 Gigant 166252	<b>72.725.C03</b>	 <p>Total Weight 12,5 kg</p>

Description / Service Assembly	ŞEM NO.	REF. NO:
	<b>72.725.S01</b>	CONTITECH 725 N P01 VIBRACOUSTIC V1DF32-246149 GOODYEAR 1R14-704 GY SPRINGRIDE D14U38 CF GOMMA REF. 1TCS360-45 CF GOMMA NO. 202964 GART NO. 292.0.533 GART REF. C292/S Gigant 246149 Gigant 3653

Total Weight 7 kg

Description / Service Assembly	ŞEM NO.	REF. NO:
	<b>72.726.S01</b>	VIBRACOUSTIC V1DF32C-166253 CONTITECH 726 N P01 Gigant 246192 Gigant 3661

Description / Roll	ŞEM NO.	REF. NO:
	<b>72.727.R</b>	VOLVO 1134446 DAF 0638148 MAN 81436010056 MAN 81436010058 Kögel Van Hool 624319-640 VDL Bus 0638148" CONTITECH 727 N PHOENIX 1 F 32 A VIBRACOUSTIC V1F32A FIRESTONE 1R2D460-360 FIRESTONE W01-095-0191 Floor 862 GOODYEAR 8117 GY SPRINGRIDE D13S04 CF GOMMA REF. 1SC360-34 CF GOMMA NO. 92575 DUNLOP UK PNP306420100 Gigant 196043

Total Weight 2,5 kg

Description / Roll	ŞEM NO.	REF. NO:
	<b>72.728.R</b>	SCHMITZ 750212 CONTITECH 728 N PHOENIX 1 F 32 A VIBRACOUSTIC V1F32A FIRESTONE 1R2S470-360 DUNLOP UK PNP306420100 FIRESTONE W01-095-0419 GOODYEAR 8117 CF GOMMA REF. 1SC360-34 CF GOMMA NO. 92575

Total Weight 2,5 kg

REF. NO:	SEM NO.	Description / Roll
MERCEDES 3933280101 CONTITECH 737 N PHOENIX 1 F 26 VIBRACOUSTIC V1F26 FIRESTONE 1R2A480-330 FIRESTONE W01-095-0211 GOODYEAR 9075 GY SPRINGRIDE D13S06 Pegaso MODEL 5316 Pegaso MODEL 5317	<b>72.737.R</b>	 <p>Total Weight 2,4 kg</p>

REF. NO:	SEM NO.	Description / Roll
MERCEDES 3183280001 CONTITECH 746 N GOODYEAR 9076	<b>72.746.R</b>	 <p>Total Weight 1,9 kg</p>

REF. NO:	SEM NO.	Description / Metal Piston
	<b>72.752.C</b>	 <p>Total Weight 18 kg</p>

REF. NO:	SEM NO.	Description / Service Assembly
CONTITECH 752 N P01 GIGANT 247 100 GIGANT 3671 VIBRACOUSTIC V1DF32-166228	<b>72.752.S01</b>	 <p>Total Weight 9,5 kg</p>



Description / Roll	SEM NO.	REF. NO:
	72.757.R	MERCEDES 3633280201 CONTITECH 757 N PHOENIX 1 F 26 C VIBRACOUSTIC V1F26C GY SPRINGRIDE D12S20 FIRESTONE 1R2A380-305 FIRESTONE W01-095-0212 GOODYEAR 9077

Total Weight 2 kg

Description / Roll	SEM NO.	REF. NO:
	72.762.R	Kässbohrer 4731013000 NEOPLAN 102100300 VANHOOL 624319460 VANHOOL 624319680 EVOBUS 3823277101 MAN 81436010049 MAN 81436010052 BPW 0220024200 ikarus CONTITECH 762 N PHOENIX 1 F 32 VIBRACOUSTIC V1F32 FIRESTONE 1R2D390-360 FIRESTONE W01-095-0190 Gigant 196035 GOODYEAR 9010 GY SPRINGRIDE D13S02 CF GOMMA REF. 1SC360-30 CF GOMMA NO. 92594 DUNLOP UK PNP307800100 VDL Bus 0 644 425

Total Weight 2,3 kg

Description / Roll	SEM NO.	REF. NO:
	72.768.R	VOLVO 1612455 RVI 5000954175 CONTITECH 768 N PHOENIX 1 E 27 FIRESTONE 1R2A380-330 FIRESTONE W01-095-0213 GOODYEAR 9078 GY SPRINGRIDE D13S08

Total Weight 2 kg

Description / Roll	SEM NO.	REF. NO:
	72.769.R	VANHOOL 624319-860 Hyundai Scania CONTITECH 769 N PHOENIX 1 E 18 VIBRACOUSTIC V1E18 FIRESTONE 1R1A380-260 BredaMenarini 252 933 Daewoo 96708574 Heuliez 5 000 805 284 FIRESTONE W01-095-0204 GOODYEAR 8053 GY SPRINGRIDE D10S02 DUNLOP UK PNP037690200 IRISBUS 5000786640 IRISBUS 5000786641 IRISBUS 5000805284

Total Weight 1,3 kg

REF. NO:	SEM NO.	Description / Roll
Kässbohrer 4731040000 BPW 0220024700 CONTITECH 775 N Gigant 196038 kögel 4731040000	<b>72.775.R</b>	
		Total Weight 5 kg

REF. NO:	SEM NO.	Description / Metal Piston
VOLVO 1075890 VOLVO 20531984 CONTITECH 6605 N P01 PHOENIX 1 DF 20 D-1 VIBRACOUSTIC V1DF20B-1 FIRESTONE 1T15LNR-6 FIRESTONE W01-M58-8472 GOODYEAR 1R11-805 GART NO. 294.0,431 GART REF. C294/VA	<b>72.7803.C</b>	
		Total Weight 7 kg

REF. NO:	SEM NO.	Description / Service Assembly
	<b>72.7803.S</b>	
		Total Weight 6 kg

REF. NO:	SEM NO.	Description / Metal Piston
VOLVO 20375227 VOLVO 3171694 CONTITECH 6606 N P01 PHOENIX 1 DF 20 E-1 VIBRACOUSTIC V1DF20A-1 FIRESTONE 1T15LNR-3 FIRESTONE W01-M58-8477 GOODYEAR 1R11-848 GART NO. 294.1.370 GART REF. C294/VA	<b>72.7804.C</b>	
		Total Weight 6,7 kg

Description / Service Assembly	SEM NO.	REF. NO:
	<b>72.7804.S</b>	

Total Weight 4 kg

Description / Roll	SEM NO.	REF. NO:
	<b>72.782.R</b>	IVECO 500324098 Hyundai Daewoo Temsa CONTITECH 782 N PHOENIX 1 E 21 D VIBRACOUSTIC V1E21D FIRESTONE 1R1A415-285 FIRESTONE W01-095-0197 GOODYEAR 9013 GY SPRINGRIDE D11S02 IRISBUS 500324098 CF GOMMA REF. 1S290-23V CF GOMMA NO. 204427 CF GOMMA NO. 204493 GART NO. 286.0.420 GART REF. D286 GART REF. D290 IRISBUS 5000954176

Total Weight 1,4 kg

Description / Roll	SEM NO.	REF. NO:
	<b>72.786.R</b>	MAN 81436010053 CONTITECH 786 N PHOENIX 1 F 14 VIBRACOUSTIC V1F14 FIRESTONE 1R1A355-245 FIRESTONE W01-095-0436

Total Weight 1,5 kg

Description / Roll	SEM NO.	REF. NO:
	<b>72.789.R</b>	VOLVO 20540789 VOLVO 21836533 PHOENIX 1 E 21 B GOODYEAR 9131 GOODYEAR 9134

REF. NO:	SEM NO.	Description / Roll
VOLVO 21836531 VOLVO 20540792 MAN 81436010025 MAN 81436010050 PHOENIX 1 E 18 E GOODYEAR 9133 GOODYEAR 9132	<b>72.792.R</b>	

REF. NO:	SEM NO.	Description / Service Assembly
MAN 81436010025 MAN 81436010050 CONTITECH 809 NT PHOENIX 1D23B-2 CF GOMMA 1T320SP FIRESTONE 1T15L-6 FIRESTONE W01 M58 0031	<b>72.809.ST</b>	 Total Weight 3 kg

REF. NO:	SEM NO.	Description / Service Assembly
MAN 81436016002 CONTITECH 809 NTB FIRESTONE 1T15L-6 FIRESTONE W01 M58 0687 GOODYEAR 1R12-709	<b>72.809.STB</b>	 Total Weight 4 kg

REF. NO:	SEM NO.	Description / Metal Piston
Taurus KR621-26 VIBRACOUSTIC V1D28A-2 FIRESTONE 1T19L-7 FIRESTONE W01-M58-6345 FIRESTONE W01-M58-8775 GY SPRINGRIDE D13B20 GY SPRINGRIDE D13B01 CF GOMMA REF. 1T19E-1 CF GOMMA NO. 87413/1 DUNLOP UK 00984A-AP GART NO. 277.4.420 GART REF. D277/B GOODYEAR 1R14-716 Granning 15635	<b>72.810.C</b>	 Total Weight 10,5 kg

Description / Metal Piston	SEM NO.	REF. NO:
	<b>72.810.C1</b>	FIRESTONE 1T19L-7 FIRESTONE W01 M58 6225 WW US 07337 FST2

Total Weight 10,5 kg

Description / Plastic Piston	SEM NO.	REF. NO:
	<b>72.810.CP</b>	FIRESTONE 1T19L-7 FIRESTONE W01 M58 8775

Total Weight 9 kg

Description / Service Assembly	SEM NO.	REF. NO:
	<b>72.810.S</b>	CONTITECH 810 MB/0 PHOENIX 1 D 28 A-5 NP VIBRACOUSTIC V1D28A-5 NP DUNLOP UK PNP307520000 FIRESTONE 1T19L-7 FIRESTONE W01-M58-7237 GOODYEAR 1R14-868

Total Weight 4,8 kg

Description / Service Assembly	SEM NO.	REF. NO:
	<b>72.810.S1</b>	

Total Weight 4,8 kg

REF. NO:	SEM NO.	Description / Service Assembly
MAN 81436010047 CONTITECH 810 NT PHOENIX 1 DK 28 A FIRESTONE 1T19L-7 CF GOMMA REF. 1T19E-1S FIRESTONE W01-M58-0491 GOODYEAR 1R14-714 GY SPRINGRIDE D14U45	<b>72.810.ST</b>	 <p>Total Weight 3,8 kg</p>

REF. NO:	SEM NO.	Description / Service Assembly
MAN 81436016019 CONTITECH 810 NTB PHOENIX 1 DK 28 A-4 FIRESTONE 1T19L-7 FIRESTONE W01-M58-0749 Pegaso 174933 GOODYEAR 1R14-713 CF GOMMA REF. 1T19E-1 CF GOMMA NO. 93702 DUNLOP UK PNP311380000	<b>72.810.STB</b>	 <p>Total Weight 4,3 kg</p>

REF. NO:	SEM NO.	Description / Metal Piston
DAF 1384274 RVI 5000745918 CONTITECH 811 MB GOODYEAR 1R14-718 GY SPRINGRIDE D13B34 CF GOMMA REF. 1T19E-2 CF GOMMA NO. 203878 DUNLOP UK PNP311670000 GART NO. 277.4.506 GART REF. D277/B	<b>72.811.C</b>	 <p>Total Weight 13,3 kg</p>

REF. NO:	SEM NO.	Description / Metal Piston
	<b>72.811.C2</b>	 <p>Total Weight 13,3 kg</p>

Description / Plastic Piston	SEM NO.	REF. NO:
------------------------------	---------	----------

**72.811.CP2**



Total Weight 10,8 kg

Description / Service Assembly	SEM NO.	REF. NO:
--------------------------------	---------	----------

**72.811.S**

CONTITECH 811 MB/0



Total Weight 5,5 kg

Description / Service Assembly	SEM NO.	REF. NO:
--------------------------------	---------	----------

**72.811.S1**



Total Weight 8,5 kg

Description / Service Assembly	SEM NO.	REF. NO:
--------------------------------	---------	----------

**72.811.S2**



Total Weight 6,5 kg

REF. NO:	ŞEM NO.	Description / Service Assembly
KÄSSBOHRER 4731029000 MAN 81436010035 MAN 81436010048 CONTITECH 811 NT FIRESTONE 1T19L-10 FIRESTONE W01 M58 0028 GOODYEAR 1R14-715 PHOENIX 1 DK 28 Taurus UR 622-03	<b>72.811.ST</b>	 <p>Total Weight 4,2 kg</p>

REF. NO:	ŞEM NO.	Description / Service Assembly
KÄSSBOHRER 4731029000 MAN 81436010035 MAN 81436010048 CONTITECH 811 NTB FIRESTONE 1T19L-10 FIRESTONE W01 M58 0747 GOODYEAR 1R14-739 PHOENIX 1 DK 28 B-4	<b>72.811.STB</b>	 <p>Total Weight 4,8 kg</p>

REF. NO:	ŞEM NO.	Description / Metal Piston
Paul NFZ P2700MB0813 Taurus KR622-26 Pegaso 175005 VIBRACOUSTIC V1D28B-2 Traylor 003 6158 E FIRESTONE 1T19L-11 Trouillet ST 225-675 FIRESTONE W01-M58-6364 Viberti 128 147 122 FIRESTONE W01-M58-6339 Viberti 644 285 GART REF. D277/B Traylor 6502 3482 GOODYEAR 1R14-705 WW US 07345 GY SPRINGRIDE D13B19 WW US 87408 GY SPRINGRIDE D13B02 CF GOMMA REF. 1T19E-2 CF GOMMA NO. 87408 DUNLOP UK 00985A-AP GART NO. 277.4.500 Granning 15634	HENDRICKSON 505859 HENDRICKSON 785170 Kässbohrer 4731030000 Kässbohrer 4731033000 Neway 21215633 RVI 5000790692 RVI 5010130925 ROR 21215633 SAF 2229000300 SAF 2229240300 SAE 8403 / 102 Titan 91687700000 CONTITECH 813 MB PHOENIX 1 D 28 B-2	 <p>Total Weight 11,6 kg</p>

REF. NO:	ŞEM NO.	Description / Metal Piston
	<b>72.813.C2</b>	<p>Total Weight 13,5 kg</p>



Description / Metal Piston	SEM NO.	REF. NO:
----------------------------	---------	----------

**72.813.C3**



Total Weight 13,5 kg

Description / Plastic Piston	SEM NO.	REF. NO:
------------------------------	---------	----------

**72.813.CP**

FIRESTONE 1T19L-11  
FIRESTONE W01 M58 6339



Total Weight 8 kg

Description / Service Assembly	SEM NO.	REF. NO:
--------------------------------	---------	----------

**72.813.S**

CONTITECH 813 MB/0  
FIRESTONE 1T19L-11  
PHOENIX 1 D 28 B-5 NP  
FIRESTONE W01-M58-7238  
VIBRACOUSTIC V1D28B-2 NP  
GOODYEAR 1R14-867



Total Weight 5,5 kg

Description / Plastic Piston	SEM NO.	REF. NO:
------------------------------	---------	----------

**72.8185.CP**

SCHMITZ 750999  
FIRESTONE 1T15MPW-9  
FIRESTONE W01 M58 8185  
WW US 06285 F





Total Weight 6,7 kg

REF. NO:	SEM NO.	Description / Service Assembly
FIRESTONE 1T15MPW-9 FIRESTONE W01 M58 6257	<b>72.8185.S</b>	 <p>Total Weight 4,6 kg</p>

REF. NO:	SEM NO.	Description / Metal Piston
DAF 0388167 CONTITECH 836 M2K1 PHOENIX 1 DF 25-13 VIBRACOUSTIC V1DF25-13 FIRESTONE 1T17AR-4.5 FIRESTONE W01-M58-8721 GOODYEAR 1R12-711 GY SPRINGRIDE D13B31	<b>72.836.2C1</b>	 <p>Total Weight 7,8 kg</p>

REF. NO:	SEM NO.	Description / Metal Piston
DAF 0388165 DAF 1697678 CONTITECH 836 MK1 PHOENIX 1 DF 25-11 VIBRACOUSTIC V1DF25-11 FIRESTONE 1T17AR-4.5 FIRESTONE W01-M58-8722 GOODYEAR 1R12-712 GY SPRINGRIDE D13B32	<b>72.836.C1</b>	 <p>Total Weight 7,7 kg</p>

REF. NO:	SEM NO.	Description / Metal Piston
CONTITECH 836 MB K4 PHOENIX 1 DF 25-14 VIBRACOUSTIC V1DF25-14 FIRESTONE 1T17AR-4.5 FIRESTONE W01-D08-8705 FIRESTONE W01-M58-8705 VDL Bus 0377498	<b>72.836.C4</b>	 <p>Total Weight 10,3 kg</p>

Description / Metal Piston	SEM NO.	REF. NO:
	<b>72.836.C6</b>	DAF 0526651 CONTITECH 836 MB K6 PHOENIX 1 DF 25-15 VIBRACOUSTIC V1DF25-15 FIRESTONE 1T17AR-4.5 FIRESTONE W01-M58-8701 GOODYEAR 1R12-768 GY SPRINGRIDE D13B43 VDL Bus 0526651

Total Weight 10,3 kg

Description / Metal Piston	SEM NO.	REF. NO:
	<b>72.836.C7</b>	DAF 0297721 CONTITECH 836 MK7 PHOENIX 1 DF 25-12 VIBRACOUSTIC V1DF25-12 FIRESTONE 1T17AR-4.5 FIRESTONE W01-M58-8715 GOODYEAR 1R12-723 GY SPRINGRIDE D13B33

Total Weight 9,3 kg

Description / Service Assembly	SEM NO.	REF. NO:
	<b>72.836.S</b>	DAF 0067504 CONTITECH 836 M PHOENIX 1 DF 25-1 NP VIBRACOUSTIC V1DF25-1 FIRESTONE 1T17AR-4.5 VDL Bus 0067504 FIRESTONE W01-D08-0776 FIRESTONE W01-M58-0776 GOODYEAR 1R12-700 GY SPRINGRIDE D13U32

Total Weight 3,7 kg

Description / Service Assembly	SEM NO.	REF. NO:
	<b>72.836.S1</b>	DAF 0513985 CONTITECH 836 MB PHOENIX 1 DF 25-4 NP VIBRACOUSTIC V1DF25-4 FIRESTONE 1T17AR-4.5 FIRESTONE W01-M58-0775 GOODYEAR 1R12-764 GY SPRINGRIDE D12U27 VDL Bus 0 513 985

Total Weight 3,7 kg

REF. NO:	SEM NO.	Description / Service Assembly
DAF 0513982 CONTITECH 836 M2 PHOENIX 1 DF 25-3 NP VIBRACOUSTIC V1DF25-3 FIRESTONE 1T17AR-4.5 FIRESTONE W01-D08-0777 FIRESTONE W01-M58-0777 GOODYEAR 1R12-710 GY SPRINGRIDE D13U31 VDL Bus 0513982	<b>72.836.S2</b>	

Total Weight 3,7 kg

REF. NO:	SEM NO.	Description / Roll
MERCEDES 6743280001 CONTITECH 838 N PHOENIX 1 F 26 D VIBRACOUSTIC V1F26D GOODYEAR 9074 GY SPRINGRIDE D13S05	<b>72.838.R</b>	

Total Weight 2,4 kg

REF. NO:	SEM NO.	Description / Roll
MERCEDES 6743280101 CONTITECH 873 N	<b>72.873.R</b>	

Total Weight 2 kg

REF. NO:	SEM NO.	Description / Metal Piston
BPW 0542940081 BPW 0542940540 CONTITECH 881 MB FIRESTONE 1T66F-10.8 FIRESTONE W01 M58 8966 CF GOMMA 1TC 360-45 PHOENIX 1 DK 32-1 Dunlop D14B36 GOODYEAR 1R14-712	<b>72.881.C</b>	

Total Weight 17,5 kg

Description / Plastic Piston	SEM NO.	REF. NO:
	<b>72.881.CP</b>	BPW 0542943510 BPW TYPE 36 CONTITECH 881 MB P30 PHOENIX 1 DK 32-2 VIBRACOUSTIC V1DK32 Y9 FIRESTONE 1T66F-10.8 FIRESTONE W01-M58-8667 GOODYEAR 1R14-748 GY SPRINGRIDE D14B41

Total Weight 13,5 kg

Description / Service Assembly	SEM NO.	REF. NO:
	<b>72.881.S</b>	BPW 542940010 BPW TYPE 36 CONTITECH 881 MB PHOENIX 1 DK 32 VIBRACOUSTIC V1DK32 FIRESTONE 1T66D-10.8 FIRESTONE W01-M58-8978 GART REF. C292 GOODYEAR 1R14-708 GY SPRINGRIDE D14U36 CF GOMMA REF. 1TC360-45 CF GOMMA NO. 204530 GART NO. 292.0.531

Total Weight 6,5 kg

Description / Roll	SEM NO.	REF. NO:
	<b>72.882.R1</b>	MERCEDES 6993280101 MAN 81436010065 MAN 81436010099 CONTITECH 882 N1 PHOENIX 1 F 16 VIBRACOUSTIC V1F16 FIRESTONE 1R4R465-260 FIRESTONE W01-095-0435 GOODYEAR 9048 GY SPRINGRIDE D12S12 CF GOMMA REF. 1SC250-28 CF GOMMA NO. 97042 GART NO. 289.0.400 GART REF. C289/D BredaMenarini D031115

Total Weight 1,8 kg

Description / Roll	SEM NO.	REF. NO:
	<b>72.883.R1</b>	VOLVO 1082085 MAN 81436010071 MAN 81436010128 CONTITECH 883 N1 PHOENIX 1 F 21 C-2 VIBRACOUSTIC V1F21C-2 GOODYEAR 9012 GY SPRINGRIDE D13S03 CF GOMMA REF. 1SC250-29 CF GOMMA NO. 204250 Pegaso

Total Weight 2,5 kg

REF. NO:	ŞEM NO.	Description / Roll
CF GOMMA REF. 1S270-25C CF GOMMA NO. 97608 IRISBUS 5000301452 IRISBUS 5010294385 Pegaso 8188539	IVECO 8188539 IVECO 500301452 MAN 81436010066 MAN 81436010108 CONTITECH 884 N PHOENIX 1 F 20 A VIBRACOUSTIC V1F20A GOODYEAR 9002 GY SPRINGRIDE D12S06	<b>72.884.R1</b>  <p>Total Weight 2 kg</p>

REF. NO:	ŞEM NO.	Description / Metal Piston
DAF 559483 CONTITECH 887 M2K1 FIRESTONE 1T15LNR-3 FIRESTONE W01 D08 8684	<b>72.887.2C1</b>	 <p>Total Weight 8,5 kg</p>

REF. NO:	ŞEM NO.	Description / Metal Piston
DAF 0392022 DAF 0392011 CONTITECH 887 MK1 FIRESTONE 1T15LNR-3 VIBRACOUSTIC V1DF18-2 FIRESTONE W01-M58-8683	<b>72.887.C1</b>	 <p>Total Weight 6,5 kg</p>

REF. NO:	ŞEM NO.	Description / Metal Piston
CONTITECH 887 N P04 VIBRACOUSTIC V1DF18-3 VDL Bus 1 154 761 VDL Bus 41 154 761 VDL Bus 1 141 525 VDL Bus 41 141 525 FIRESTONE W01-M58-5785	<b>72.887.C6</b>	 <p>Total Weight 7,4 kg</p>

Description / Service Assembly	SEM NO.	REF. NO:
	<b>72.887.S</b>	DAF 0513983 CONTITECH 887 M FIRESTONE 1T15LNR-3 FIRESTONE W01-M58-0780 GOODYEAR 1R11-796 GY SPRINGRIDE D11U41 VDL Bus 0 513 983

Total Weight 3 kg

Description / Metal Piston	SEM NO.	REF. NO:
	<b>72.889.C2</b>	DAF 1279141 DAF 1698434 CONTITECH 889 M K2 FIRESTONE 1T15LLR-5 FIRESTONE W01-M58-8679

Total Weight 7,2 kg

Description / Service Assembly	SEM NO.	REF. NO:
	<b>72.889.S</b>	DAF 1276846 CONTITECH 889 M FIRESTONE W01-M58-0781 FIRESTONE 1T15LLR-5

Total Weight 3 kg

Description / Roll	SEM NO.	REF. NO:
	<b>72.896.R</b>	SCANIA 411627 CONTITECH 896 N PHOENIX 2 E 18 A FIRESTONE 1R1J520-285 FIRESTONE W01-095-0173 FIRESTONE W01-095-0245 GOODYEAR 8040 GY SPRINGRIDE SP2191 DUNLOP UK PNP305140100 Dennis 1261 Dennis 806 Dennis 806

Total Weight 1,7 kg

REF. NO:	SEM NO.	Description / Roll
CF GOMMA REF. 1S320-30 CF GOMMA NO. 88788 DUNLOP UK PNP305210101 GART NO. 278.0.430 GART REF. D278 Cardi 58050315 Dennis 800 1/2 Pegaso 794686	SCANIA 411622 SCANIA 411623 LAG CONTITECH 897 N PHOENIX 2 E 23 VIBRACOUSTIC V2E23 FIRESTONE 1R1K440-320 FIRESTONE W01-095-0229 FIRESTONE W01-095-0174 GOODYEAR 8028 GOODYEAR 8313 Pegaso 795097 GY SPRINGRIDE Sp2192	72.897.R  <p>Total Weight 1,8 kg</p>

REF. NO:	SEM NO.	Description / Metal Piston
RVI 5010052722 RVI 5010130683 CONTITECH 901 MB	72.901.C	 <p>Total Weight 15 kg</p>

REF. NO:	SEM NO.	Description / Service Assembly
	72.901.S	 <p>Total Weight 7,5 kg</p>

REF. NO:	SEM NO.	Description / Metal Piston
RVI 5010211724 CONTITECH 902 MB FIRESTONE W01-M58-9910 FIRESTONE 1T19G-12	72.902.C	 <p>Total Weight 14,5 kg</p>



Description / Service Assembly	SEM NO.	REF. NO:
	<b>72.902.S</b>	

Total Weight 6,5 kg

Description / Service Assembly	SEM NO.	REF. NO:
	<b>72.909.ST</b>	NEOPLAN 102100500 NEOPLAN 102121500 MAN 81436010050 MAN 81436010073 CONTITECH 909 NT

Total Weight 2,4 kg

Description / Service Assembly	SEM NO.	REF. NO:
	<b>72.909.STB</b>	CONTITECH 909 NTB FIRESTONE 1T15L-6 FIRESTONE W01 M58 0687 GOODYEAR 1R12-709 PHOENIX 1 D 23 C-1 Taurus B 151 CF GOMMA 1T 320 -SP 89753

Total Weight 3,3 kg

Description / Metal Piston	SEM NO.	REF. NO:
	<b>72.912.C01</b>	SAF 3228003000 SAF 2926V CONTITECH 912 N P01 PHOENIX 1 D 28 D-10 VIBRACOUSTIC V1D28D-10 FIRESTONE 1T19L-14 FIRESTONE W01-M58-8502 GOODYEAR 1R14-728 GY SPRINGRIDE D14B52 CF GOMMA REF. 1T19E2-L CF GOMMA NO. 206333 GART NO. 287.4.600 GART REF. C287/C

Total Weight 14,5 kg

REF. NO:	SEM NO.	Description / Metal Piston
CF GOMMA REF. 1T19E-4 CF GOMMA NO. 96997 CF GOMMA NO. 202442 GART NO. 287.4.601 WW US 96681	<b>72.912.C02</b> HENDRICKSON 507782 ROR 21222673 SAF 3229001300 CONTITECH 912 N P02 PHOENIX 1 D 28 D-2 VIBRACOUSTIC V1D28D-4 FIRESTONE 1T19L-14 FIRESTONE W01-M58-8766 FIRESTONE W01-M58-7385 GART REF. D287/C GOODYEAR 1R14-758 GY SPRINGRIDE D13B14	 <p>Total Weight 15 kg</p>

REF. NO:	SEM NO.	Description / Roll
Taurus B154 VIBRACOUSTIC V1F21C-5 FIRESTONE 2R2A460-295 FIRESTONE W01-095-0555 GOODYEAR 9015 GY SPRINGRIDE D12S05	<b>72.916.R1</b> MAN 81436010095 MAN 81436010105 Optare L5820005 Temsa TE771107Y ZF Sachs 00 17 70 000 160 ZF Sachs 00 17 48 000 160 CONTITECH 916 N1 PHOENIX 1 F 21 C-5 PHOENIX 1 F 21 C-6	 <p>Total Weight 2 kg</p>

REF. NO:	SEM NO.	Description / Roll
GART NO. 276.0.391 GART REF. D276/BS Heuliez 5 000 288 982 IRISBUS 5000288982 IRISBUS 5010151378 IRISBUS 5010151379 Temsa	<b>72.921.R</b> Kässbohrer 4771503000 IVECO 99459166 EVOBUS 0003280001 CONTITECH 921 N PHOENIX 1 E 17 VIBRACOUSTIC V1E17 FIRESTONE 1R1A415-260 FIRESTONE W01-095-0226 GOODYEAR 8043 GY SPRINGRIDE D10S04 CF GOMMA REF. 1S285-23V CF GOMMA NO. 202728	 <p>Total Weight 2 kg</p>

REF. NO:	SEM NO.	Description / Roll
VOLVO 3116354 VOLVO AAU2542 CONTITECH 927 N PHOENIX 2 E 18 B VIBRACOUSTIC V2E18B FIRESTONE 1R1J415-285 Jonckheere FIRESTONE W01-095-0244 GOODYEAR 8037 DUNLOP UK PNP300080100 Dennis 685 2/3	<b>72.927.R</b>	 <p>Total Weight 1,2 kg</p>

Description / Metal Piston	SEM NO.	REF. NO:
 <p>Total Weight 11 kg</p>	<b>72.9270.C</b>	HENDRICKSON S-20010 VOLVO 85101147 CONTITECH 9 10-13.5 S 433 Aurus 6385 FIRESTONE 1T15VM35 FIRESTONE W01-358-9270 GOODYEAR 1R13-119 GOODYEAR Flex No. 566263053 Automann 1DK23I-9270 Triangle 8433 FleetPride AS9270 Watson & Chalin AS-0084

Description / Roll	SEM NO.	REF. NO:
 <p>Total Weight 1,6 kg</p>	<b>72.928.R</b>	VOLVO AAU2544 VOLVO 3116983 IVECO 6453741 CONTITECH 928 N PHOENIX 2 E 23 A VIBRACOUSTIC V2E23A FIRESTONE 1R1K380-320 FIRESTONE W01-095-0228 MCW X 664 1056 GOODYEAR 8042 GY SPRINGRIDE D12S03 DUNLOP UK IC3308 Dennis 686 1/2 Dennis 870 3/4 Dennis 776 1/7

Description / Metal Piston	SEM NO.	REF. NO:
 <p>Total Weight 11,5 kg</p>	<b>72.940.C</b>	BPW 0542941141 BPW 0542942191 CONTITECH 940 MB FIRESTONE 1T17D-4.3 FIRESTONE W01 M58 8609 SPRINGRIDE D11B39 GOODYEAR 1R11-763

Description / Plastic Piston	SEM NO.	REF. NO:
 <p>Total Weight 8,4 kg</p>	<b>72.940.CP</b>	BPW 0542943210 CONTITECH 940 MB P30 PHOENIX 1 DK 21 K-2 VIBRACOUSTIC V1DK21KY4 FIRESTONE 1T17D-4.3 FIRESTONE W01-M58-8585 GOODYEAR 1R11-752

REF. NO:	SEM NO.	Description / Service Assembly
BPW 0542940910 CONTITECH 940 MB PHOENIX 1 DK 21 K VIBRACOUSTIC V1DK21K FIRESTONE 1T17D-4.3 FIRESTONE W01-M58-8613 GOODYEAR 1R11-703 GY SPRINGRIDE D11U31 CF GOMMA REF. 1TC300-30 CF GOMMA NO. 205536 GART NO. 293.0.411 GART REF. C293/A	<b>72.940.S</b>	 <p>Total Weight 4,4 kg</p>

REF. NO:	SEM NO.	Description / Metal Piston
BPW 0542940281 BPW 0542940591 CONTITECH 941 MB FIRESTONE 1T17D-8.3 FIRESTONE W01 M58 8619 PHOENIX 1 DK 21 TAURUS KR 730-01 DUNLOP D11B38 GOODYEAR 1R11-762	<b>72.941.C</b>	 <p>Total Weight 12,3 kg</p>

REF. NO:	SEM NO.	Description / Plastic Piston
BPW 0542943200 CONTITECH 941 MB P30 PHOENIX 1 DK 21-2 VIBRACOUSTIC V1DK21Y1 FIRESTONE 1T17D-8.3 FIRESTONE W01-M58-8618 GOODYEAR 1R11-743 GY SPRINGRIDE D11B33	<b>72.941.CP</b>	 <p>Total Weight 9,4 kg</p>

REF. NO:	SEM NO.	Description / Service Assembly
BPW 542940030 CONTITECH 941 MB PHOENIX 1 DK 21 VIBRACOUSTIC V1DK21 FIRESTONE 1T17D-8.3 FIRESTONE W01-M58-8620 GOODYEAR 1R11-700 GY SPRINGRIDE D11U30 CF GOMMA REF. 1TC300-36 CF GOMMA NO. 204466 GART NO. 293.0.511 GART REF. C293	<b>72.941.S</b>	 <p>Total Weight 5 kg</p>

Description / Metal Piston	SEM NO.	REF. NO:
	<b>72.942.C1</b>	BPW 0542941690 CONTITECH 942 MB FIRESTONE 1T66F-13.5 FIRESTONE W01 M58 8584 GOODYEAR 1R14-781

Total Weight 18,7 kg

Description / Service Assembly	SEM NO.	REF. NO:
	<b>72.942.S</b>	BPW 0542940050 CONTITECH 942 MB PHOENIX 1 DK 32 L VIBRACOUSTIC V1DK32L FIRESTONE 1T66D13.5 FIRESTONE W01-M58-8611 GOODYEAR 1R14-700

Total Weight 6,7 kg

Description / Roll	SEM NO.	REF. NO:
	<b>72.944.R</b>	IVECO 4714025 IVECO 4714025 SCANIA 523229 CONTITECH 944 N PHOENIX 1 E 21-6 VIBRACOUSTIC V1E21-6 VIBRACOUSTIC V1E19 FIRESTONE 1R1B390-270 FIRESTONE W01-095-0121 Inbus 484 0005 Inbus 489 0001 GOODYEAR 9009 GY SPRINGRIDE D11S04 CF GOMMA REF. 1S270-23C CF GOMMA NO. 97619 GART NO. 290.0.390 GART REF. D290/B Sicca 4840 005 Portesi 700 176

Total Weight 1,6 kg

Description / Roll	SEM NO.	REF. NO:
	<b>72.945.R</b>	IVECO 4716989 IVECO 4716989 CONTITECH 945 N PHOENIX 1 E 21 C FIRESTONE 1R1A460-290 FIRESTONE W01-095-0063 GART NO. 276.0.420 GART REF. D276 BredaMenarini 178 741 GOODYEAR 9014 CF GOMMA REF. 1S285-25 CF GOMMA NO. 97555 DUNLOP UK PNP301000101 Pegaso 197145 Pegaso 4716989 Pegaso 769388 Hyundai

Total Weight 1,6 kg

REF. NO:	SEM NO.	Description / Metal Piston
HENDRICKSON S-20127 CONTITECH 10 10-21 S 434 FIRESTONE 1T15VLT-105 FIRESTONE W01 358 9262 FIRESTONE W01 358 9580 GOODYEAR 1R13-081 GOODYEAR 1R13-118 TAURUS 6386 LOADGUARD Sc2761	<b>72.9580.C</b>	

REF. NO:	SEM NO.	Description / Roll
EVOBUS 6993280101 CONTITECH 975 N PHOENIX 1 E 10 VIBRACOUSTIC V1E10 FIRESTONE 1R1T320195 Optare R 5800001 FIRESTONE W01-095-0437 DUNLOP UK 00628A-AP GART NO. 305.0.320 GART REF. D305 ZF Sachs 0501 312 548	<b>72.975.R</b>	

Total Weight 2 kg

REF. NO:	SEM NO.	Description / Convulated Air Spring
	<b>72.2211.P02</b>	

Total Weight 2,7 kg

REF. NO:	SEM NO.	Description / Convulated Air Spring
SCANIA 1319761 SCANIA 1387289 SAF 4229100400 CONTITECH FD 200-19 P04 PHOENIX SP 2 B 12 R-5 VIBRACOUSTIC VSP2B12R-5 FIRESTONE 20F FIRESTONE W01-M58-7894 Kögel 6501706 GOODYEAR 2B9-700 GY SPRINGRIDE S09201 GART NO. 291.2.203 GART REF. T291/2 Granning 15599	<b>72.2211.P11</b>	

Total Weight 2,7 kg

Description / Convulated Air Spring	SEM NO.	REF. NO:
	<b>72.2302.F02</b>	Fruehauf UJB 0985 CONTITECH FD 412-18 P01 FIRESTONE 12x2NB FIRESTONE W01-R58-4073 GOODYEAR 2B12-2457 GY SPRINGRIDE S12202 DUNLOP UK 12x2 decentral Granning 15814 Lohr A06030601 SMB M063796

Total Weight 8,5 kg

Description / Convulated Air Spring	SEM NO.	REF. NO:
	<b>72.1211.P01</b>	GART T291/B (291.1.170)

Total Weight 2 kg

Description / Convulated Air Spring	SEM NO.	REF. NO:
	<b>72.2285.M01</b>	Magirus-Deutz 03422571 Kässbohrer 4731003000 Kässbohrer 4731024000 MAN 88964200217 BPW 0220020500 Granning 15923 CONTITECH 608 N PHOENIX 2 B 20 R VIBRACOUSTIC V2B20R FIRESTONE 20 FIRESTONE W01-R58-4088 GOODYEAR 2B12-425/300

Total Weight 1,1 kg

Description / Convulated Air Spring	SEM NO.	REF. NO:
	<b>72.3303.F01</b>	CONTITECH FT 412-32 1/2 M10 FIRESTONE 12x3 FIRESTONE W01-R58-4062 GOODYEAR 3B12-2452 CF GOMMA REF. T28B CF GOMMA NO. 90559 Gigant 881204 Granning 15816

Total Weight 8,5 kg

REF. NO:	SEM NO.	Description / Convulated Air Spring
Fruehauf M 002 297 CONTITECH FT 412-32 S DUNLOP SP 2666 Granning 15897	<b>72.3303.F02</b>	 <p>Total Weight 8,5 kg</p>
REF. NO:	SEM NO.	Description / Convulated Air Spring
SAF 45980054192 CONTITECH FD 200-19 P03 Dunlop 9" S09203 FIRESTONE 20 - 2	<b>72.2211.P12</b>	 <p>Total Weight 2,7 kg</p>
REF. NO:	SEM NO.	Description / Convulated Air Spring
SCANIA 1387283	<b>72.2211.P08</b>	 <p>Total Weight 2,7 kg</p>
REF. NO:	SEM NO.	Description / Convulated Air Spring
FIRESTONE W01 R58 4038 GT BENALU M078246 DUNLOP SP 2782 NB LOHR A06030622	<b>72.2305.F01</b>	 <p>Total Weight 8,5 kg</p>



Description / Convulated Air Spring	SEM NO.	REF. NO:
	<b>72.2302.F01</b>	CONTITECH FD 412-18 1/2 M10 FIRESTONE W01-R58-4061 GOODYEAR 2B12-2452 GY SPRINGRIDE 12"x2 SP1541 NB Gigant 881202 Granning 15813 WW USN 510011KD

Total Weight 8,5 kg

Description / Convulated Air Spring	SEM NO.	REF. NO:
	<b>72.2221.P03</b>	HENDRICKSON SH 505613 MERCEDES 9423270601 MERCEDES 9463281601 SCHMITZ 016808 ROR 21221356 CONTITECH FD 200-25 1/4 M10 PHOENIX SP 2 B 12 R-A-10 VIBRACOUSTIC VSP2B12RA-10 FIRESTONE 20C-2 Granning 15670
		FIRESTONE W01-M58-7679 FIRESTONE W01-968-6771 GOODYEAR 2B9-269 WW US 07394C WW US 07394F WW US 07394

Description / Convulated Air Spring	SEM NO.	REF. NO:
	<b>72.2211.P14</b>	HENDRICKSON SH 505613 MERCEDES 9423270601 CONTITECH FD 200-19 P02 FIRESTONE 20F FIRESTONE W01-M58-7756 CF GOMMA REF. T20L CF GOMMA NO. 207065

Total Weight 2,7 kg

Description / Convulated Air Spring	SEM NO.	REF. NO:
	<b>72.3301.P01</b>	SAF 3228100201 CONTITECH FT 330-29 P01 GART T 271/S (271.3.296) GRANINNG 17017

Total Weight 8,5 kg

REF. NO:	SEM NO.	Description / Convulated Air Spring
HENDRICKSON HS 507906/P PHOENIX SP 2B22-RA-2	72.2301.P01	

Total Weight 8,5 kg

REF. NO:	SEM NO.	Description / Convulated Air Spring
ROR 21226068 FIRESTONE W01 M58 6875	72.2304.P05	



REF. NO:	SEM NO.	Description / Convulated Air Spring
SCANIA 1387283 FIRESTONE W01 M58 6891	72.2221.P04	



REF. NO:	SEM NO.	Description / COMPLETE WITH STELL PISTON
VOLVO 20554762 VOLVO 20452138 Contitech 6613 N P01	72.4762.C	



---

Description / COMPLETE WITH STEEL PISTON	SEM NO.	REF. NO:
--	---------	----------

**72.6609.C**

VOLVO 1075365  
VOLVO 1629782  
Contitech 6609 N P01



## HOSE GROUP



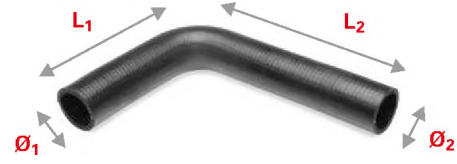

**Soğutma Suyu Hortumu / Cooling Water Hoses**

SEM NO.	DIMENSION	
	Ø	L
10499	14	1000
10473	18	1000
10474	22	1000
10475	25	1000
10476	28	1000
10477	30	1000
10478	32	1000
10479	35	1000
10480	38	1000
10481	40	1000
10482	42	1000
10483	45	1000
10484	48	1000
10485	50	1000
10486	55	1000
10487	60	1000
10488	65	1000
10489	70	1000
*10490	70	1000
*10491	75	1000
10492	75	1000
*10493	80	1000
10494	80	1000
*10495	85	1000
*10496	90	1000
*10497	95	1000
*10498	100	1000

\* Non Braided

**Dirsek Hortumu / Elbow Hoses**

SEM NO.	DIMENSION			
	Ø <sub>1</sub>	Ø <sub>2</sub>	L <sub>1</sub>	L <sub>2</sub>
10500	16		100	100
10501	20		100	150
10502	22		150	250
10503	25		100	200
10504	25		150	300
10505	28		100	200
10506	28		150	300
10507	30		100	100
10508	30		150	200
10509	32		100	100
10510	32		150	200
10511	35		100	100
10512	35		150	200
10513	38		100	100
10514	38		150	250
10515	40		150	250
10516	42		150	250
10517	45		150	300
10518	45	50	150	150
10519	50		150	150
10520	50		150	300
10521	50	55	150	150
10522	50	60	150	150
10523	55		150	300
10524	60		150	300
10525	65		200	350
*10526	70		200	350
*10527	75		150	200
10528	75		150	200
*10529	75		200	400
10530	75		200	400
*10531	80		200	350
10532	80		200	350
*10533	90		250	250
*10534	100		250	250

**CALIPER GROUP**



### KN TYPE CALIPER

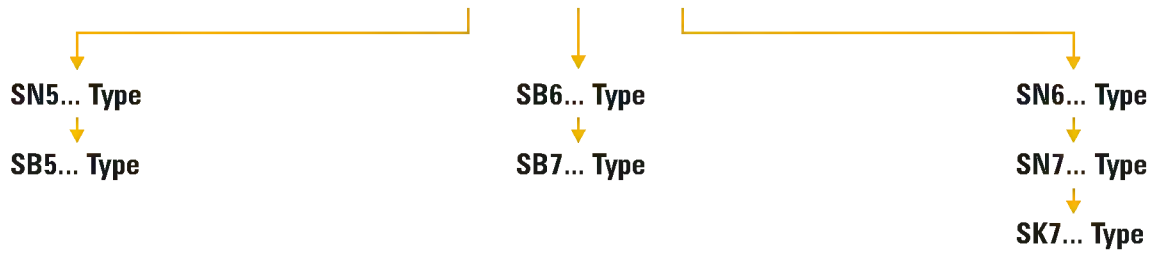

### MRT TYPE CALIPER

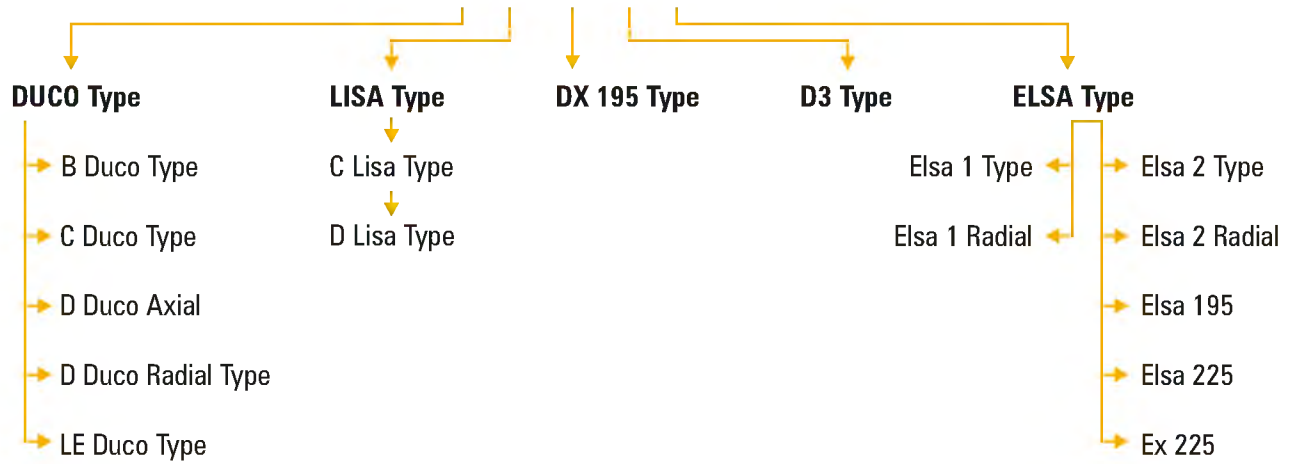

### WBC TYPE CALIPER





**SB 5... / SN 5...**  
Type Caliper Repair Kits



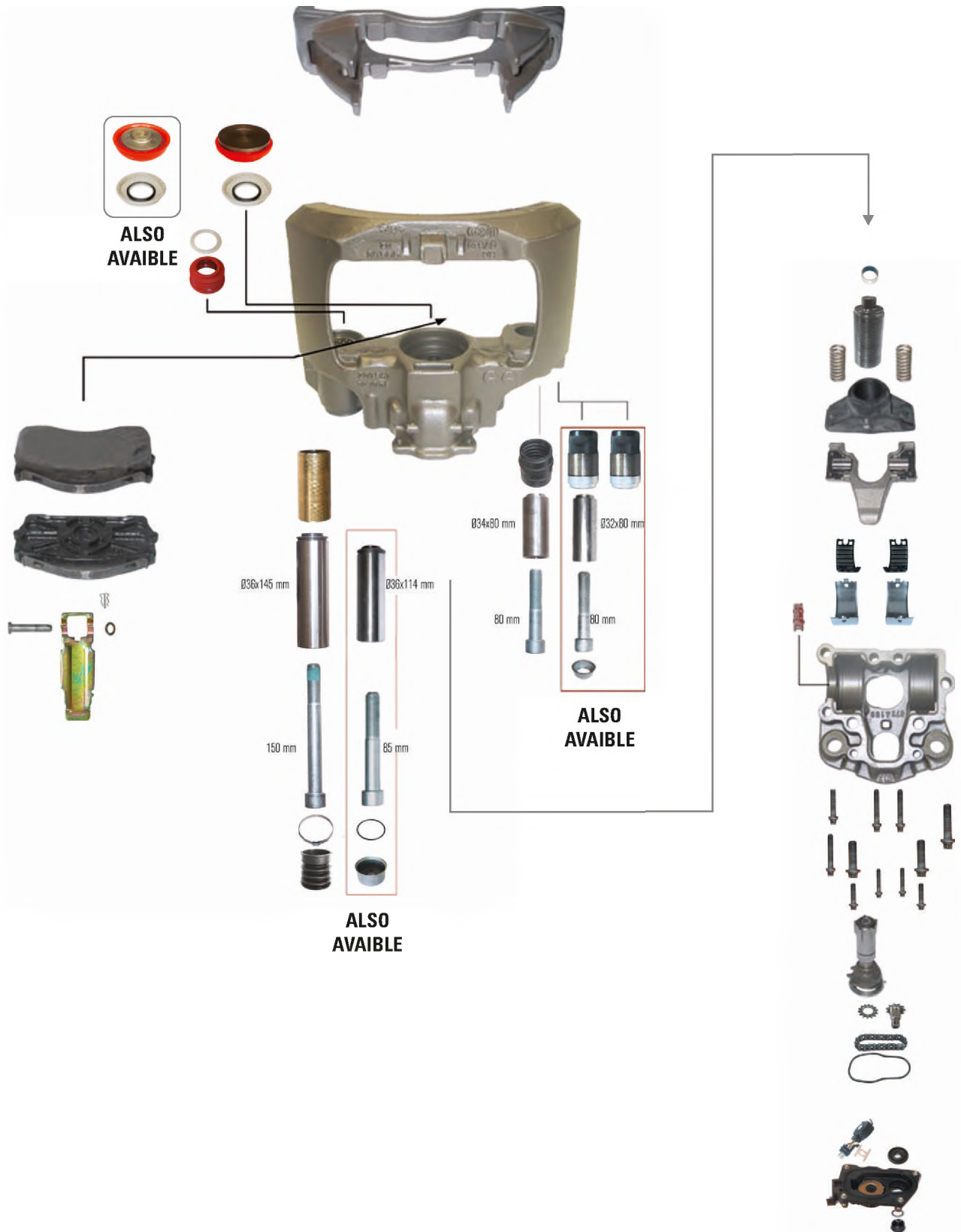

# SB 5... / SN 5... Type Caliper Repair Kits

SB5 TYPE CALIPERS		AXLE // AKS		SEM REPAIR KITS/ /SEM Tamir Takımları			
Vehicles // Araçlar	Models // Modeller	Left // Sol	Right // Sağ				
MERCEDES	Atego 1023,1538,712	SB 5013 K004573	SB 5003 K004572	10683	10688	10691	11816
		SB 5012 K004571	SB 5002 K004570				
GIGANT SAE	17.5" Wheels (98 to 00)	SB 5003 K004572	SB 5013 K004573	12202	12203	12201	
SN5 TYPE CALIPERS		AXLE // AKS		SEM REPAIR KITS/ /SEM Tamir Takımları			
Vehicles // Araçlar	Models // Modeller	Left // Sol	Right // Sağ				
MERCEDES	Atego 1023,1538,712	SN 5016 K004573	SN 5006 K004572	10680	12170	12217	12175
		SN 5015 K004571	SN 5005 K004570				
GIGANT SAE	17.5" Wheels (98 to 00)	SN 5006 K004572	SN 5016 K004573	12202	12203	12201	

**Caliper Piston Repair Kit**  
Kaliper Piston Tamir Takımı

SEM Kit No **10680**

Org. Kit Ref. No K 001929

Application SN 5001, SN 5002, SN 5003, SN 5005, SN 5006, SN 5007, SN 5008, SN 5011, SN 5012, SN 5013, SN 5015, SN 5016, SN 5017, SN 5020, SN 5021, SN 5022, SN 5023, SN 5030, SN 5031, SN 5032, SN 5033



**Caliper Boots & Piston Repair Kit**  
Kaliper Korumak & Piston Tamir Takımı

SEM Kit No **12170**

Org. Kit Ref. No

Application SN 5... Series, SN 6... Series



**Caliper Piston Repair Kit**  
Kaliper Piston Tamir Takımı

SEM Kit No **10681**

Org. Kit Ref. No II 370760065

Application SN 5... Series, SN 6... Series



**Caliper Boots & Piston Repair Kit**  
Kaliper Korumak & Piston Tamir Takımı

SEM Kit No **12171**

Org. Kit Ref. No

Application SB 5... Series, SN 5... Series



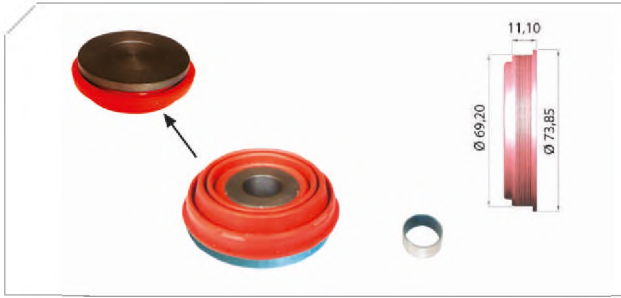

**Caliper Boots & Piston Repair Kit**

Kaliper Körük & Piston Tamir Takımı

SEM Kit No **10682**

Org. Kit Ref. No --

Application SB 5... Series, SN 5... Series



**Caliper Boots & Piston Repair Kit**

Kaliper Körük & Piston Tamir Takımı

SEM Kit No **10685**

Org. Kit Ref. No --

Application SB 5... Series, SN 5... Series



**Caliper Boots & Piston Repair Kit**

Kaliper Körük & Piston Tamir Takımı

SEM Kit No **10686**

Org. Kit Ref. No --

Application SN 5001, SN 5002, SN 5003, SN 5005, SN 5006, SN 5007, SN 5008, SN 5011, SN 5012, SN 5013, SN 5015, SN 5016, SN 5017, SN 5020, SN 5021, SN 5022, SN 5023, SN 5030, SN 5031, SN 5032, SN 5033



**Caliper Boots & Piston Repair Kit**

Kaliper Körük & Piston Tamir Takımı

SEM Kit No **10687**

Org. Kit Ref. No --

Application SB 5... Series, SN 5... Series



**Caliper Boots & Piston Repair Kit**

Kaliper Körük & Piston Tamir Takımı

SEM Kit No **12172**

Org. Kit Ref. No --

Application SB 5... Series, SN 5... Series



**Caliper Boots & Piston Repair Kit**

Kaliper Körük & Piston Tamir Takımı

SEM Kit No **12173**

Org. Kit Ref. No --

Application SN 5001, SN 5002, SN 5003, SN 5005, SN 5006, SN 5007, SN 5008, SN 5011, SN 5012, SN 5013, SN 5015, SN 5016, SN 5017, SN 5020, SN 5021, SN 5022, SN 5023, SN 5030, SN 5031, SN 5032, SN 5033

<b>Caliper Boots &amp; Piston Repair Kit</b> Kaliper K�r�k & Piston Tamir Takımı	
SEM Kit No	<b>12174</b>
Org. Kit Ref. No	--
Application	SB 5... Series, SN 5... Series



<b>Caliper Guides &amp; Seals Repair Kit</b> Kaliper Mil & Ke�e Tamir Takımı	
SEM Kit No	<b>10688</b>
Org. Kit Ref. No	II 32809/0062 • MERCEDES ATEGO Ref.no: 000 420 22 82 - 000 420 07 82
Application	SB 5..., S6 65..., SB 71..., SB 75..., SB 76..., SB 77..



<b>Caliper Outer Boots &amp; Steelcaps Repair Kit</b> Kaliper DıŐ K�r�kleri & Kapları Tamir Takımı	
SEM Kit No	<b>10691</b>
Org. Kit Ref. No	K 001301 / II350470063 MAN Ref.no: 81.50822.6025 • DAF-LEYLAND Ref.no: 1439494
Application	All SB... & SN... Series

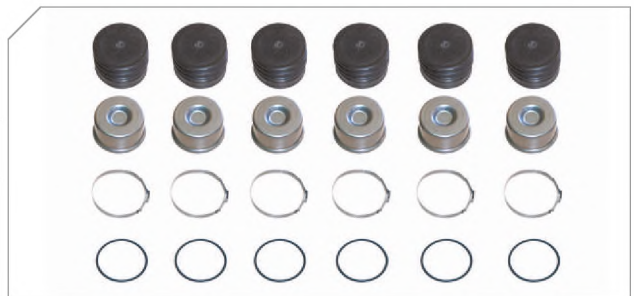

<b>Caliper Guides &amp; Seals Repair Kit</b> Kaliper Mil & Ke�e Tamir Takımı	
SEM Kit No	<b>10692</b>
Org. Kit Ref. No	K 001532
Application	SB 5..., SN 5..., SB 7122, SB 7132, SB 7126, SB 7136, SB 7586, SB 7596 SB 7666, SB 7676, SB 7785, SB 7795, SB 7840, SB 7859, SB 7869



<b>Caliper Rubber Bush Guidance Repair Kit</b> Kaliper Mil Tamir Takımı	
SEM Kit No	<b>11816</b>
Org. Kit Ref. No	II 36847 / 0064
Application	SB 5..., SN 65..., SB 71..., SB 75..., SB 76..., SB 77..., SB 78..., SB 79..



<b>Caliper Caps &amp; Pad Retainer Pins</b> Kaliper Kapları & Balata Tutucu Pimleri	
SEM Kit No	<b>12175</b>
Org. Kit Ref. No	--
Application	All SB..., All SN... Series

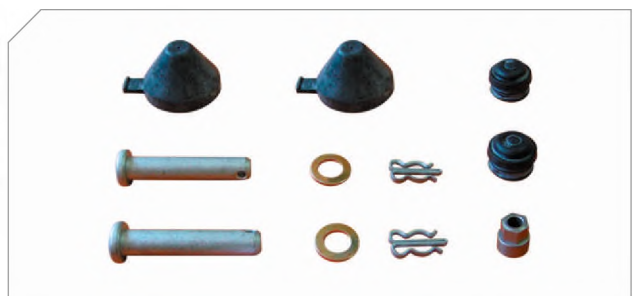





**Caliper Guide & Bush**

Kaliper Mil & Keçe

SEM Kit No **12176**

Org. Kit Ref. No --

Application All SB 5..., SB 6..., SB 7... Series  
All SN 5..., SN 6..., SN 7... Series

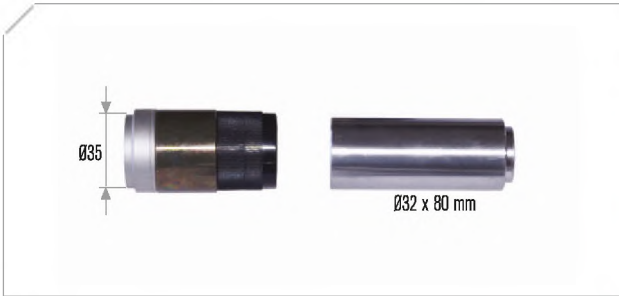

**Caliper Guide & Bush**

Kaliper Mil & Keçe

SEM Kit No **12177**

Org. Kit Ref. No --

Application All SB 5..., SB 6..., SB 7... Series  
All SN 5..., SN 6..., SN 7... Series

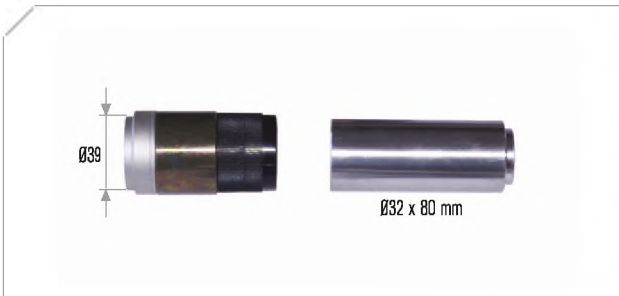

**Caliper Guide & Bush**

Kaliper Mil & Keçe

SEM Kit No **12178**

Org. Kit Ref. No --

Application All SB 5..., SB 6..., SB 7... Series  
All SN 5..., SN 6..., SN 7... Series



**Set of Adjuster Cap**

Ayar Mekanizması Kap Seti

SEM Kit No **10696**

Org. Kit Ref. No K 000945 • DAF Ref.no: 1439493, MAN Ref.no: 81.50822.6021 • 81.50822.6024

Application SB 5..., SB 6..., SB 7... Series



**Set of Adjuster Cap**

Ayar Mekanizması Kap Seti

SEM Kit No **10697**

Org. Kit Ref. No K 003902

Application All SN 5..., SN 6..., SN 7..., SK 7..., NA 7... Series



**Set of Adjuster Cap**

Ayar Mekanizması Kap Seti

SEM Kit No **12179**

Org. Kit Ref. No K 000029

Application All SN 5..., SN 6..., SN 7..., SK 7..., NA 7... Series

<b>Caliper İpat Retainer Repair Kit</b> Kaliper İpat Tutucu Tamir Takımı	
SEM Kit No	<b>12180</b>
Org. Kit Ref. No	K 000884
Application	--

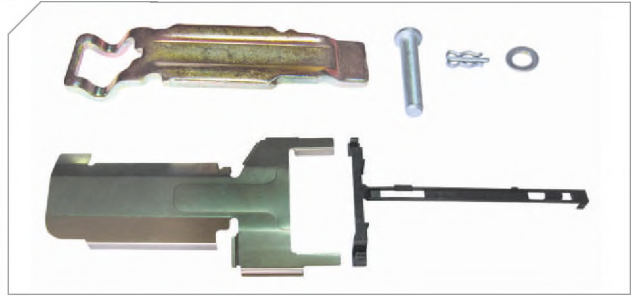

<b>Caliper Guides &amp; Seals Repair Kit</b> Kaliper Mil & Keçe Tamir Takımı	
SEM Kit No	<b>10698</b>
Org. Kit Ref. No	K 001928
Application	SN 5... Series



<b>Caliper Guides &amp; Seals Repair Kit</b> Kaliper Mil & Keçe Tamir Takımı	
SEM Kit No	<b>10699</b>
Org. Kit Ref. No	II 36910/0062 • MERCEDES Ref.no: 000 420 1282
Application	SB 5... Series



<b>Caliper Rubber Bush Guidance Repair Kit</b> Kaliper Kauçuk Burç & Mil Tamir Takımı	
SEM Kit No	<b>12181</b>
Org. Kit Ref. No	--
Application	All SB..., All SN...

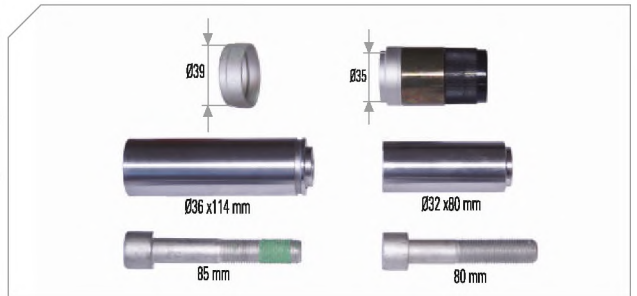

<b>Caliper Guide &amp; Bush Repair Kit</b> Kaliper Burç & Mil Tamir Takımı	
SEM Kit No	<b>12182</b>
Org. Kit Ref. No	K000698 • K000697
Application	SB 6..., All SB 7...

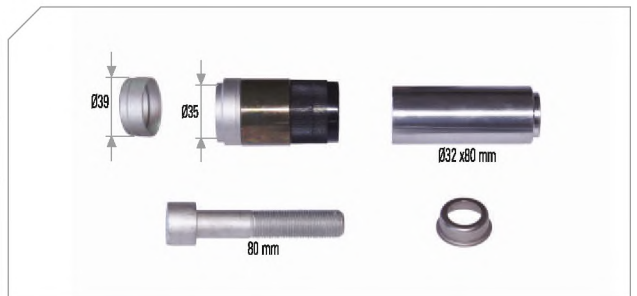

<b>Caliper Guides &amp; Seals Repair Kit</b> Kaliper Mil & Keçe Tamir Takımı	
SEM Kit No	<b>12183</b>
Org. Kit Ref. No	K001274
Application	--



**Caliper Guides & Seals Repair Kit**

Kaliper Mil &amp; Keçe Tamir Takımı

SEM Kit No **12184**

Org. Kit Ref. No II 35810062 • MERCEDES Ref.no: 000 420 1182 • SCANIA Ref.no: 1415149

Application All SB...

**Caliper Guides & Seals Repair Kit**

Kaliper Mil &amp; Keçe Tamir Takımı

SEM Kit No **12185**

Org. Kit Ref. No K 000365

Application All Series

**Caliper Guides & Seals Repair Kit**

Kaliper Mil &amp; Keçe Tamir Takımı

SEM Kit No **12233**

Org. Kit Ref. No SAF Ref.no: 3.434.3815.00

Application --

**Caliper Guides & Seals Repair Kit**

Kaliper Mil &amp; Keçe Tamir Takımı

SEM Kit No **12234**

Org. Kit Ref. No SAF Ref.no: 3.434.3820.00

Application --

**Caliper Guides & Seals Repair Kit**

Kaliper Mil &amp; Keçe Tamir Takımı

SEM Kit No **12186**

Org. Kit Ref. No K 048371K50

Application SB 6547, SB 6557, SB 7884, SB 7984, SB 7907, SB 7020, SB 7022

**Caliper Guides & Seals Repair Kit**

Kaliper Mil &amp; Keçe Tamir Takımı

SEM Kit No **12187**

Org. Kit Ref. No K 048396K50

Application SB 7122, SB 7132, SB 7126, SB 7136, SB 7586, SB 7596, SB 7666, SB 7676, SB 7785, SB 7795, SB 7840, SB 7850, SB 7859, SB 7869



<b>Caliper Seals Repair Kit</b> Kaliper Keçe Tamir Takımı	
SEM Kit No	<b>12188</b>
Org. Kit Ref. No	II 328090061 / MERCEDES Ref.no: 001 420 52 83 • 000 420 30 15
Application	All SB... Series



<b>Caliper Guides &amp; Seals Repair Kit</b> Kaliper Mil & Keçe Tamir Takımı	
SEM Kit No	<b>12189</b>
Org. Kit Ref. No	K 001532
Application	SB 7122, SB 7132, SB 7126, SB 7136, SB 7586, SB 7596, SB 7666, SB 7676 SB 7795, SB 7840, SB 7850, SB 7859, SB 7869



<b>Caliper Guides &amp; Seals Repair Kit</b> Kaliper Keçe Tamir Takımı	
SEM Kit No	<b>12190</b>
Org. Kit Ref. No	--
Application	--



<b>Caliper Adjusting Mechanism Repair Kit</b> Kaliper Ayar Mekanizması Tamir Takımı	
SEM Kit No	<b>10700</b>
Org. Kit Ref. No	--
Application	SN 5..., SB 6..., SB 7..., SN 6..., SN 7..., SK... Series

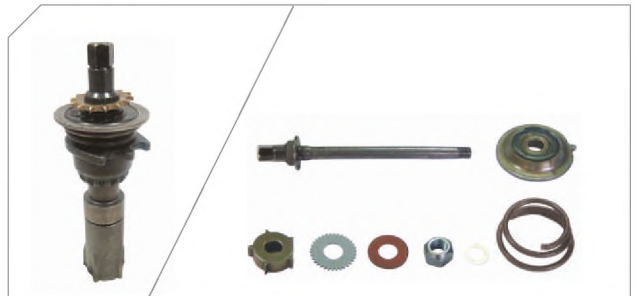

<b>Caliper Adjusting Mechanism Repair Kit</b> Kaliper Ayar Mekanizması Tamir Takımı	
SEM Kit No	<b>12192</b>
Org. Kit Ref. No	--
Application	SN 5... Series





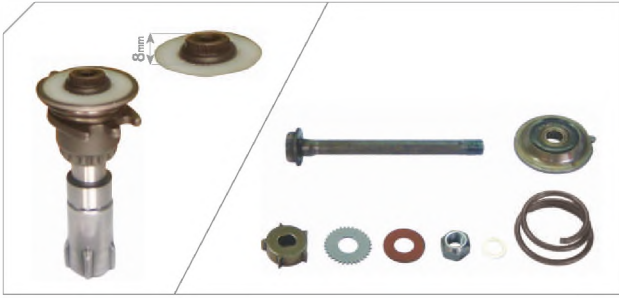

**Caliper Adjusting Mechanism Repair Kit**

Kaliper Ayar Mekanizması Tamir Takımı

SEM Kit No **12193**

Org. Kit Ref. No --

Application SN 5... Series



**Caliper Chain (11 links)**

Kaliper Zinciri (11 bakla)

SEM Kit No **10703**

Org. Kit Ref. No --

Application All SB 5..., All SN 5... Series



**Caliper Chain (13 links)**

Kaliper Zinciri (13 bakla)

SEM Kit No **12194**

Org. Kit Ref. No --

Application All SB 5..., All SN 5... Series



**Caliper Bridge Assembly**

Kaliper Köprü Bağlantısı

SEM Kit No **10707**

Org. Kit Ref. No --

Application All SB 5..., All SN 5... Series



**Caliper Bridge Assembly**

Kaliper Köprü Bağlantısı

SEM Kit No **12195**

Org. Kit Ref. No --

Application --



**Caliper Bridge Assembly**

Kaliper Köprü Bağlantısı

SEM Kit No **12196**

Org. Kit Ref. No --

Application --

<b>Caliper Roller Bearing</b> Kaliper Rulmanları	
SEM Kit No	10710
Org. Kit Ref. No	--
Application	SN 5... Series

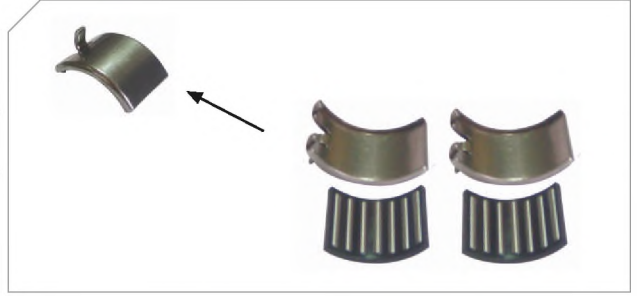

<b>Caliper Calibration Bolt</b> Kaliper Ayar Civatası	
SEM Kit No	10711
Org. Kit Ref. No	--
Application	All SB 5..., SB 6..., SB 7..., All SN 6..., SN 7...



SEM Kod No	Sensor / Sensör	Vehicle / Araç
10713	Caliper Sensor Cover Kaliper Sensör Kapağı	(Without Sensor) (Sensörsüz)
	Caliper Sensor Cover Kaliper Sensör Kapağı	(2 Cable Sensor) (2 Kablolu Sensör)
	Caliper Sensor Cover Kaliper Sensör Kapağı	(3 Cable Sensor) (3 Kablolu Sensör)



SEM Kod No	Sensor / Sensör	Vehicle / Araç
10715	Caliper Sensor Cover Kaliper Sensör Kapağı	(Without Sensor) (Sensörsüz)
	Caliper Sensor Cover Kaliper Sensör Kapağı	(2 Cable Sensor) (2 Kablolu Sensör)
	Caliper Sensor Cover Kaliper Sensör Kapağı	(3 Cable Sensor) (3 Kablolu Sensör)

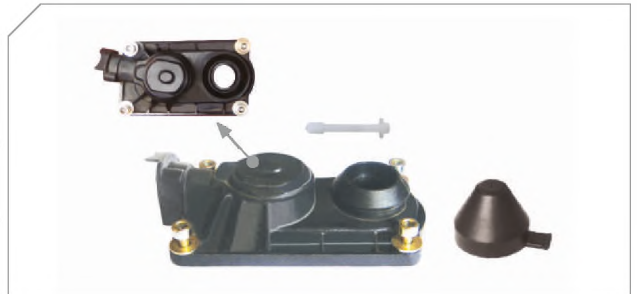

SEM Kod No	OEM Ref No	Description	Length
12197	449 756 020 0	Sensor Cable with Connector Socket/ Bağlantı Soketli Sensör Kablosu	3,5 m



<b>Caliper Lever</b> Kaliper Masura Bilya Yatağı	
SEM Kit No	10720
Org. Kit Ref. No	--
Application	All SB 5..., SN 5..., Series

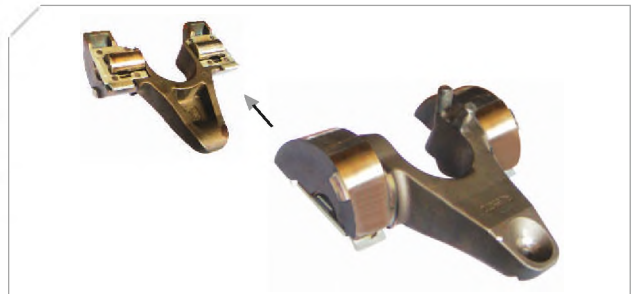

Angle 12°



**Caliper Lever**

Kaliper Masura Bilya Yatağı

SEM Kit No **12198**

Org. Kit Ref. No --

Application --

Angle 0°

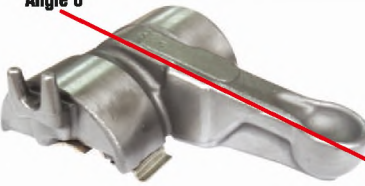

**Caliper Lever**

Kaliper Masura Bilya Yatağı

SEM Kit No **12199**

Org. Kit Ref. No --

Application --

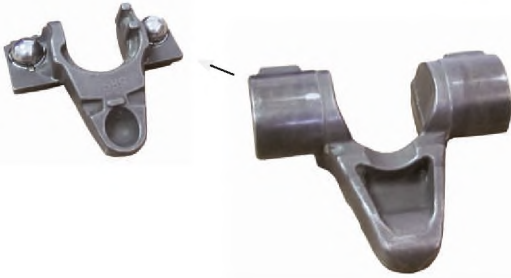

**Caliper Lever**

Kaliper Masura Bilya Yatağı

SEM Kit No **12200**

Org. Kit Ref. No --

Application All SB 5..., SN 5..., Series



**Caliper Bearing Shaft Calibration Nut**

Kaliper Bilyalı Mekanizma Ayar Somunu

SEM Kit No **12201**

Org. Kit Ref. No --

Application All SB ..., All SN ... Series

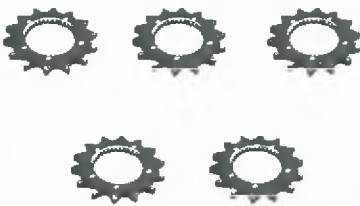

**Caliper Gear Wheel Adjuster Mechanism**

Kaliper Ayar Dişlisi

SEM Kit No **12202**

Org. Kit Ref. No --

Application All SB ..., All SN ... Series



**Caliper Pignon Shaft**

Kaliper Pinyon Dişlisi

SEM Kit No **12203**

Org. Kit Ref. No --

Application All SB 5..., All SN 5... Series

<b>Caliper Pignon Shaft</b> Kaliper Pinyon Dişlisi	
SEM Kit No	12204
Org. Kit Ref. No	--
Application	SN 5... Series



<b>Caliper Cover &amp; Seals Repair Kit</b> Kaliper Kapağı & Keçe Tamir Takımı	
SEM Kit No	12205
Org. Kit Ref. No	--
Application	SN 5



<b>Plastic Shaft</b> Plastik Şaft	
SEM Kit No	12206
Org. Kit Ref. No	--
Application	

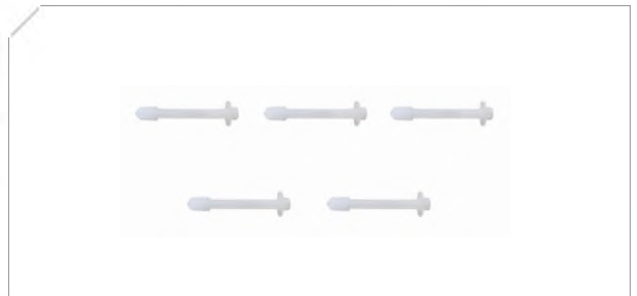

<b>Plastic Shaft</b> Plastik Şaft	
SEM Kit No	12207
Org. Kit Ref. No	--
Application	

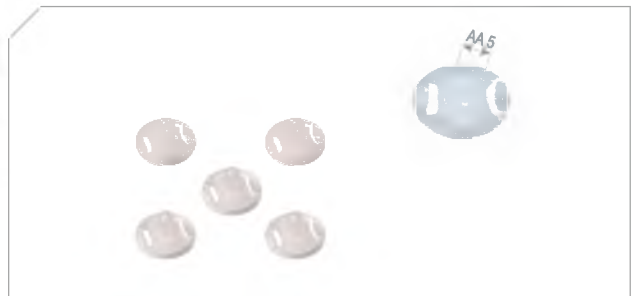

<b>Plastic Shaft</b> Plastik Şaft	
SEM Kit No	12208
Org. Kit Ref. No	--
Application	

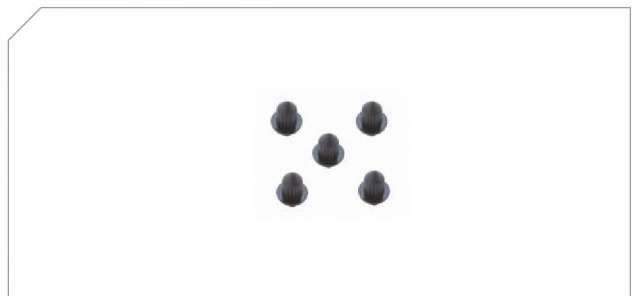

<b>Caliper Lever Support</b> Kaliper Bilya Yatağı Desteği	
SEM Kit No	12209
Org. Kit Ref. No	--
Application	

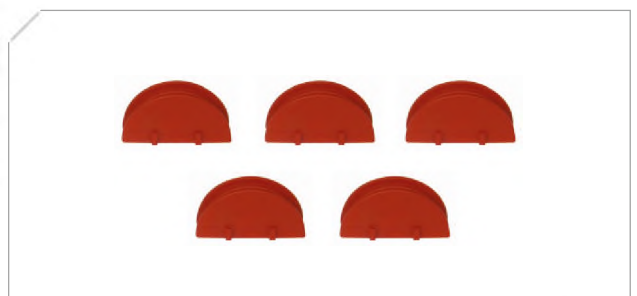



**Caliper Seal**

Kaliper Keçe

SEM Kit No **12210**

Org. Kit Ref. No --

Application



## **SB 6... / SB 7...**

Type Caliper Repair Kits



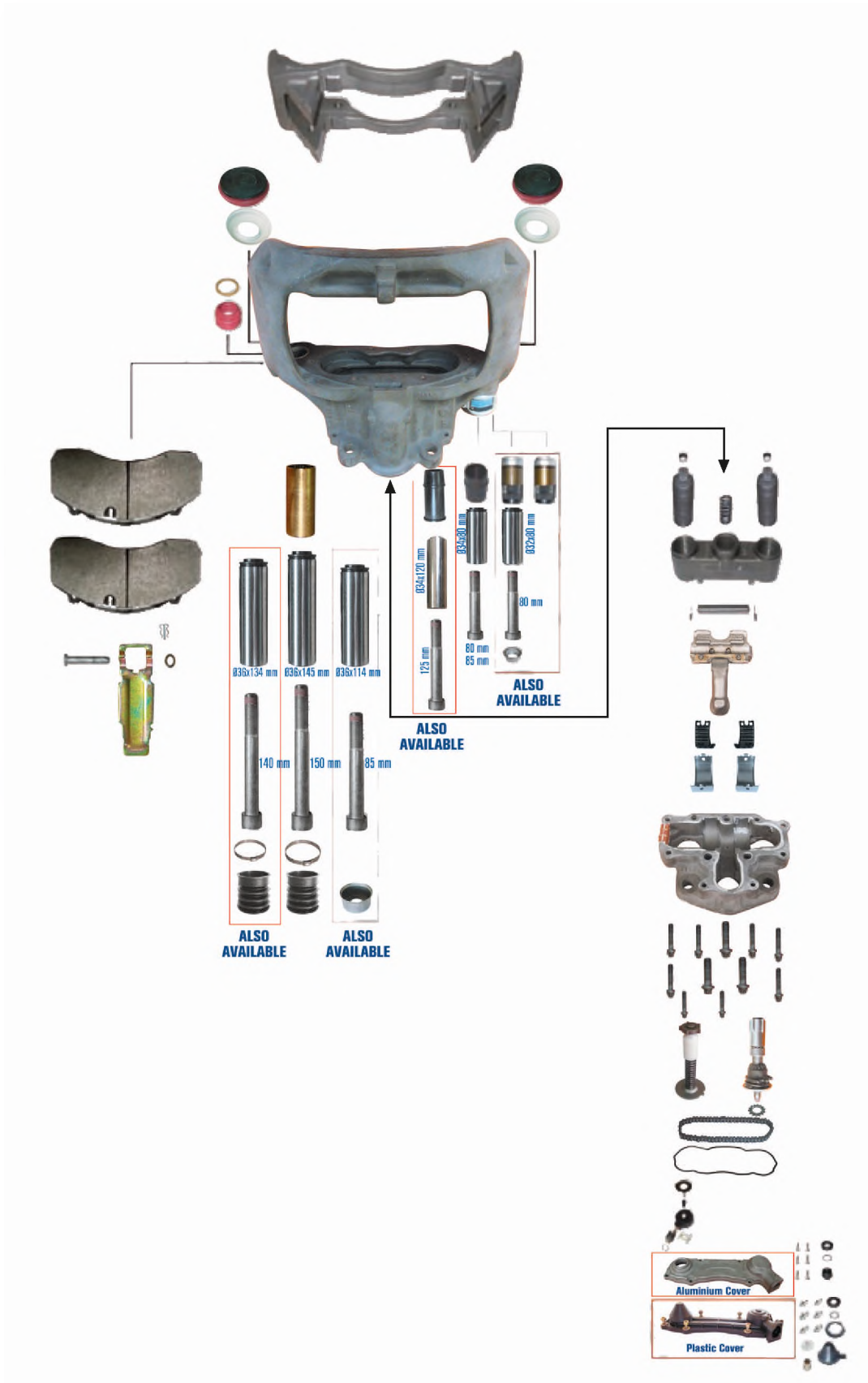

SB6 & SB7 TYPE CALIPERS				AXLE // AKS		SEM REPAIR KITS/ /SEM Tamir Takımları
Vehicles // Araçlar		Models // Modeller		Left // Sol	Right // Sağ	
<b>BOVA</b>	FHD 10	FLD 12		<b>SB 7698</b> K002785	<b>SB 7688</b> K002786	10683 10688 10691 11816 12231
	FHD 12	FLD 14				
	FHD 13	FLD 15		<b>SB 7409</b> K002785	<b>SB 7416</b> K003806	10683 10689
	FHD 14					
	FHD 15					
<b>BPW</b>	Axle 19.5" Wheel +5'			<b>SB 6548</b> K003780	<b>SB 6558</b> K003779	10683 10691 11816 12231
	Axle 19.5" Wheel +15'			<b>SB 6582</b> K002923	<b>SB 6592</b> K002924	10683 10689 10691
	Axle 22.5" Wheel 0'			<b>SB 6401</b> K002923	<b>SB 6411</b> K002924	10683 10689
	Axle 22.5" Wheel 0'			<b>SB 7900</b> K003784	<b>SB 7910</b> K003783	10683 10691 11816 12231
<b>DAF-LEYLAND</b>	SB 120			<b>SB 6556</b> K003825	<b>SB 6546</b> K003826	10683 10688 10691 11816 12231
	CF 65	CF 85	LF 55	<b>SB 7580</b>	<b>SB 7890</b> K003805	10688 10691 11816 12231
	CF 75	F 65	XF 95			
<b>MERCEDES</b>	Powersystems 19.5" Whell (97+)			<b>SB 6540</b> K003780	<b>SB 6550</b> K003779	10683 11816
	Powersystems 22.5" Whell (97+)			<b>SB 7800</b> K003796-K003782	<b>SB 7810</b> K003795-K003781	10683 10688 10691 11816 12231
	Atego 1220, 1528			<b>SB 6535</b> K013175	<b>SB 6525</b> K013176	10683 10688 10691 11816
	Actros (95+), Atego S (01+)			<b>SB 6516</b> K013177	<b>SB 6506</b> K013178	10683 10688 10691 11816 10693
	Axor(98+)			<b>SB 7648</b> K003800	<b>SB 7658</b> K003799	10683 10688 10691 11816 12231
<b>DENNIS</b>	Trident II (01+)			<b>SB 7919</b> K003803	<b>SB 7909</b> K003804	10683 10689 10691
	Trident II (01+)			<b>SB 7211</b> K002962	<b>SB 7201</b> K002963	10683 10689 10691
	Trident II (01+)			<b>SB 7450</b> K002962	<b>SB 7460</b> K002963	10683 10689
<b>EVOBUS (MERCEDES)</b>	CITARO (8 Wheels)			<b>SB 7648</b> K003800	<b>SB 7658</b> K003799	10683 10688 10691 11816 12231
	CITARO (6 Wheels)			<b>SB 7648</b> K003800	<b>SB 7658</b> K003799	10683 10688 10691 11816 12231
	CITARO (6 Wheels)			<b>SB 7190</b> K002964	<b>SB 7180</b> K002965	10683 10689 10691
	CITARO (6 Wheels)			<b>SB 7451</b> K002964	<b>SB 7461</b> K002965	10683 10689
	CITARO (6 Wheels)			<b>SB 7648</b> K003800	<b>SB 7658</b> K003799	10683 10688 10691 11816 12231
	CITO (98+)			<b>SB 7780</b> K003810	<b>SB 7790</b> K003809	10683 10688 10691 11816 12231



SB6 & SB7 TYPE CALIPERS		AXLE // AKS		SEM REPAIR KITS/ /SEM Tamir Takımları
Vehicles // Araçlar	Models // Modeller	Left // Sol	Right // Sağ	
EVOBUS (MERCEDES)	S3 (01.96-06.96)	SB 7790 K003809	SB 7780 K003810	10683 10688 10691 11816 12231
		SB 7113 K002966	SB 7103 K002967	10683 10691
		SB 7452 K002966	SB 7462 K002967	10683 10689
	S3 (07.96-01.99)	SB 7790 K003809	SB 7780 K003810	10683 10688 10691 11816 12231
		SB 7150 K002962	SB 7140 K002963	10683 10691 11816 12225 12231
		SB 7450 K002962	SB 7460 K002963	10683 10689
	S316 HDS, S328 DT	SB 7712 K003796	SB 7702 K003795	10683 10688 10691 11816 12231
	Travego (99+)	SB 7760 K003800	SB 7770 K003799	10683 10688 10691 11816 12231
		SB 7766 K002798	SB 7776 K002797	10683 10688 10691 12231
		SB 7432 K002798	SB 7422 K002797	10683 10689
		SB 7780 K003810	SB 7790 K003809	10683 10688 10691 11816 12231
	GIGANT SAE	19.5" Whells (98+)	SB 6567 K003780	SB 6577 K003779
22.5" Whells		SB 7929 K003782	SB 7939 K003781	10683 10689 10691
IVECO	Eurocargo 120 (01+)	SB 6557 K002920	SB 6547 K002919	10683 10689 10691
	Eurocargo 130 (01+)			
	Eurocargo 150 (01+)	SB 6418 K002920	SB 6408 K002919	10683 10689
	Eurostar (97+) Eurotech (97+)	SB 7906 K002709	SB 7916 K002708	10683 10689 10691
		SB 7902 K002562	SB 7912 K002561	10683 10689 10691
LECINENA	Axle - 19.5" Whell (98+)	SB 6521 K003780	SB 6531 K003779	10683 10688 10691 11816
		SB 6413 K002916	SB 6403 K002915	10683 10689
	Axle - 22.5" Whell (98+)	SB 7904 K003784	SB 7914 K003783	10683 10689 10691
MAN	14 T HOGL TAB A66 (98+)	SB 6508 K003826	SB 6518 K003825	10683 10688 10691 11816 12231
	M2000 (96+)	SB 6503 K003826	SB 6513 K003825	10683 10688 10691 11816 12231
NEOPLAN	Reisbusse (3 Axle)	SB 7893 K010743	SB 7883 K010744	10683 10688 10691
		SB 7793	SB 7783	10683 10688 10691 11816 12231
	Skyliner (3 Axle)	SB 7893 K010743	SB 7883 K010744	10683 10689 10691
		SB 7793	SB 7783	10683 10688 10691 11816 12231
	Skyliner (2 Axle)	SB 7883 K010743	SB 7893 K010744	10683 10689 10691
		SB 7783	SB 7793	10683 10688 10691 11816 12231

SB6 & SB7 TYPE CALIPERS		AXLE // AKS		SEM REPAIR KITS/ /SEM Tamir Takımları
Vehicles // Araçlar	Models // Modeller	Left // Sol	Right // Sağ	
<b>NEOPLAN</b>	Starliner (3 Axle)	SB 7893 K010743	SB 7883 K010744	10683 10689 10691
		SB 7793	SB 7783	10683 10688 10691 11816 12231
	Starliner (2 Axle)	SB 7883 K010744	SB 7893 K010743	10683 10689 10691
		SB 7783	SB 7793	10683 10688 10691 11816 12231
	Controliner (3 Axle)	SB 7883 K010744	SB 7893 K010743	10683 10689 10691
		SB 7123 K002963	SB 7133 K002962	10683 10691 11816 12225 12231
		SB 7460 K002963	SB 7450 K002962	10683 10689
		SB 7783	SB 7793	10683 10691 11816 12225 12231
		SB 7124 K002965	SB 7134 K002964	10683 10689
		SB 7461 K002965	SB 7450 K002962	10683 10689 10691
		SB 7883 K010744	SB 7893 K010743	10683 10688 10691 11816 12231
	Controliner (2 Axle)	SB 7783	SB 7793	10683 10689 10691
		SB 7883 K010744	SB 7893 K010743	10683 10688 10691 11816 12231
	Transliner (2 Axle)	SB 7783	SB 7793	10683 10689 11891
		SB 7883 K010744	SB 7893 K010743	10683 10691 11816 12225 12231
	Linienbus (3 Axle)	SB 7123 K002963	SB 7133 K002962	10683 10689
		SB 7460 K002963	SB 7450 K002962	10683 10688 11816 12231
		SB 7783	SB 7793	10683 10691 11816 12225 12231
		SB 7124 K002965	SB 7134 K002964	10683 10689
		SB 7461 K002965	SB 7450 K002962	10683 10689 10691
		SB 7883 K010744	SB 7893 K010743	10683 10691 11816 12225 12231
	Linienbus (2 Axle)	SB 7123 K002963	SB 7133 K002962	10683 10689
		SB 7460 K002963	SB 7450 K002962	10683 10688 10691 11816 12231
		SB 7783	SB 7793	10683 10691 11816 12225 12231
SB 7124 K002965		SB 7134 K002964	10683 10689	
SB 7461 K002965		SB 7450 K002962	10683 10688 10691 11816 12231	
SB 7883 K010744		SB 7893 K010743	10683 10691 11816 12225 12231	
<b>RABA</b>	Axle, 22.5" Whell	SB 7723 K003783	SB 7733 K003781	10683 10688 10691 11816
<b>SAF</b>	Axle, 19.5" Whell (+5")	SB 6527 K003780	SB 6537 K003779	10683 10688 10691 11816 12231
	Axle, 22.5" Whell (0")	SB 7767 K003784	SB 7777 K003783	

KNORR CALIPERS // SB6... / SB7... Types		AXLE // AKS		SEM REPAIR KITS/ /SEM Tamir Takımları
Vehicles // Araçlar	Models // Modeller	Left // Sol	Right // Sağ	
SAF	Axle, 22.5" Wheel (-12°)	<b>SB 7801</b> K003782	<b>SB 7811</b> K003781	10683 10688 10691 12231
	Axle, 22.5" Wheel (0°) with sensor	<b>SB 7821</b> K003810	<b>SB 7831</b> K003809	10683 10688 10691 11816 12231
SCANIA	114 (Bus, 99 to 01)	<b>SB 7433</b> K003810	<b>SB 7423</b> K003809	
		<b>SB 7888</b> K003804	<b>SB 7898</b> K003803	10683 10689 10691
	114 (Bus, 01+)	<b>SB 7105</b> K002963	<b>SB 7115</b> K002962	10683 10688 10691
		<b>SB 7199</b> K002966	<b>SB 7189</b> K002967	10683 10689 10691
	Irizar (Bus)	<b>SB 7452</b> K002966	<b>SB 7462</b> K002967	10683 10689
		<b>SB 7746</b>	<b>SB 7756</b>	10683 10688 10691 11816 12231
	114 (96+) 144 (96+)	<b>SB 7747</b>	<b>SB 7757</b>	10683 10688 10691 11816 12231
		<b>SB 7889</b> K003810	<b>SB 7899</b> K003809	10683 10689 10691
		<b>SB 7102</b> K003193	<b>SB 7112</b> K003192	10683 10689
		<b>SB 7465</b> K003193	<b>SB 7455</b> K003192	10683 10689
124 (96+)	<b>SB 7105</b> K002963	<b>SB 7115</b> K002962	10683 10688 10691	
SMB	Axle, 19.5" Wheel (+5") 98+	<b>SB 6520</b> K003780	<b>SB 6530</b> K003779	10683 10688 10691 11892 11816 12231
	Axle, 22.5" Wheel (-12") 98+ with sensor	<b>SB 7903</b> K003782	<b>SB 7913</b> K003781	10683 10689 10691
	Axle, 22.5" Wheel (-12") 98+	<b>SB 7649</b> K003800	<b>SB 7659</b> K003799	10683 10688 10691 11816 12231

<b>Caliper Piston Repair Kit</b> Kaliper Piston Tamir Takımı	
SEM Kit No	<b>10678</b>
Org. Kit Ref. No	II 30413/065 / II 179320065
Application	All SB 6..., All SB 7... Series



<b>Caliper Boots &amp; Piston Repair Kit</b> Kaliper Korumak & Piston Tamir Takımı	
SEM Kit No	<b>12211</b>
Org. Kit Ref. No	
Application	All SB... Series



<b>Caliper Piston Repair Kit</b> Kaliper Piston Tamir Takımı	
SEM Kit No	<b>10679</b>
Org. Kit Ref. No	—
Application	SN 6..., SN 7..., SK 7..., NA 7



<b>Caliper Piston Repair Kit</b> Kaliper Piston Tamir Takımı	
SEM Kit No	<b>12212</b>
Org. Kit Ref. No	K 001929
Application	SN 6..., SN 7..., SK 7..., NA 7



<b>Caliper Boots &amp; Piston Repair Kit</b> Kaliper Korumak & Piston Tamir Takımı	
SEM Kit No	<b>10683</b>
Org. Kit Ref. No	K000944 / K 010604 MERCEDES Ref.no: A 000 420 3982 • SCANIA, MAN, BPW
Application	All SB 5..., SB 6..., SB 7..., SN 5... Series



<b>Caliper Boots &amp; Piston Repair Kit</b> Kaliper Korumak & Piston Tamir Takımı	
SEM Kit No	<b>10684</b>
Org. Kit Ref. No	K 001300 / K 010603 / K 000366 MAN Ref.no: 81.50822.6020, MERCEDES Ref.no: A 000 420 2382 / 4082
Application	NA 7027, NA 7028, NA 7037, NA 7038, NA 75..., SK 7..., SN 65..., SN 66.. SN 7..., SN 71..., SN 72., SN 73.. Series





**Caliper Boots & Piston Repair Kit**

Kaliper Korumak & Piston Tamir Takımı

SEM Kit No **12213**

Org. Kit Ref. No K 010606

Application --

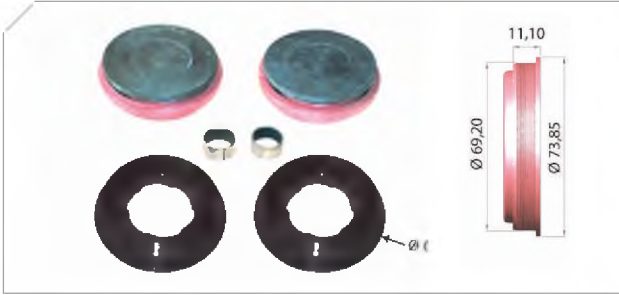

**Caliper Boots & Piston Repair Kit**

Kaliper Korumak & Piston Tamir Takımı

SEM Kit No **12214**

Org. Kit Ref. No K 015542

Application --



**Caliper Guides & Seals Repair Kit**

Kaliper Mil & Keçe Tamir Takımı

SEM Kit No **10689**

Org. Kit Ref. No K 000375 • MAN Ref.no: 81.50822.6023

Application SB 6547, SB 6557, SB 7884, SB 7984, SB 7907, SB 7020, SB 7022



**Caliper Guides & Seals Repair Kit**

Kaliper Mil & Keçe Tamir Takımı

SEM Kit No **12215**

Org. Kit Ref. No K 001470 • MERCEDES Ref.no: A 000 420 34 82

Application --



**Caliper Guides & Seals Repair Kit**

Kaliper Mil & Keçe Tamir Takımı

SEM Kit No **12216**

Org. Kit Ref. No K 000696 / K 004218 / II 310370066 • MERCEDES Ref.no: 002 420 03 83

Application SB 7122, SB 7132, SB 7126, SB 7136, SB 7586, SB 7596, SB 7666, SB 7676



<b>Caliper Guides &amp; Seals Repair Kit</b> Kaliper Mil & Keçe Tamir Takımı	
SEM Kit No	<b>12217</b>
Org. Kit Ref. No	
Application	SB 5..., SB 6..., SB 7..., SN 5... Series



<b>Caliper Guides &amp; Seals Repair Kit</b> Kaliper Mil & Keçe Tamir Takımı	
SEM Kit No	<b>12218</b>
Org. Kit Ref. No	
Application	SB 5..., SB 6..., SB 7..., SN 5... Series



<b>Caliper Guides &amp; Seals Repair Kit</b> Kaliper Mil & Keçe Tamir Takımı	
SEM Kit No	<b>12219</b>
Org. Kit Ref. No	
Application	--



<b>Caliper Guides &amp; Seals Repair Kit</b> Kaliper Mil & Keçe Tamir Takımı	
SEM Kit No	<b>12220</b>
Org. Kit Ref. No	
Application	--



<b>Caliper Guides &amp; Seals Repair Kit</b> Kaliper Mil & Keçe Tamir Takımı	
SEM Kit No	<b>12221</b>
Org. Kit Ref. No	K 000935
Application	SB 7649, SB 7659





**Caliper Guides & Seals Repair Kit**

Kaliper Mil & Keçe Tamir Takımı

SEM Kit No **10692**

Org. Kit Ref. No K 001532

Application SB 7122, SB 7132, SB 7126, SB 7136, SB 7586, SB 7596, SB 7666  
SB 7676, SB 7785, SB 7795, SB 7840, SB 7859, SB 7869



**Caliper Rubber Bush Guidance Repair Kit**

Kaliper Mil Tamir Takımı

SEM Kit No **11816**

Org. Kit Ref. No II 36847 / 0064

Application SB 5..., SN 65..., SB 71..., SB 75..., SB 76..., SB 77..., SB 78..., SB 79...



**Brake Pad Kit**

Disk Fren Balata Tamir Takımı

SEM Kit No **12223**

Org. Kit Ref. No 20928564

Application All SB 6..., SN 6... Series



**Caliper Guides & Seals Repair Kit**

Kaliper Mil & Keçe Tamir Takımı

SEM Kit No **10693**

Org. Kit Ref. No K 000132 / II 197140062 / II 197330062 / II 304130062 / II 350470062

Application SB 7122, SB 7132, SB 7126, SB 7136, SB 7586, SB 7596, SB 7666  
SB 7676, SB 7785, SB 7795, SB 7840, SB 7859, SB 7869



**Caliper Guides & Seals Repair Kit**

Kaliper Mil & Keçe Tamir Takımı

SEM Kit No **12224**

Org. Kit Ref. No II 39769F/0063

Application SB 6537, SB 7821

<b>Caliper Guides &amp; Seals Repair Kit</b> Kaliper Mil & Keçe Tamir Takımı	
SEM Kit No	<b>12225</b>
Org. Kit Ref. No	II 33968/0062 • SCANIA Ref.no: 1390427
Application	SB 7648, SB 7666, SB 6506, SB 7108, SB 7122, SB 71..., SB 7785 SB 7795, SB 7825, SB 7835, SB 7842, SB 7852, SB 7882



<b>Caliper Guides &amp; Seals Repair Kit</b> Kaliper Mil & Keçe Tamir Takımı	
SEM Kit No	<b>12226</b>
Org. Kit Ref. No	II 17932 / 0062
Application	SB 7521, SB 7581, SB 7661, SB 7580, SB 7122, SB 7..., SB 75..., SB 7624, SB 7629, SB 7634, SB 7639, SB 7640, SB 7650, SB 7668, SB 7678



<b>Caliper Caps &amp; Pad Retainer Pins</b> Kaliper Kapları & Balata Tutucu Pimleri	
SEM Kit No	<b>12175</b>
Org. Kit Ref. No	--
Application	All SB..., All SN... Series

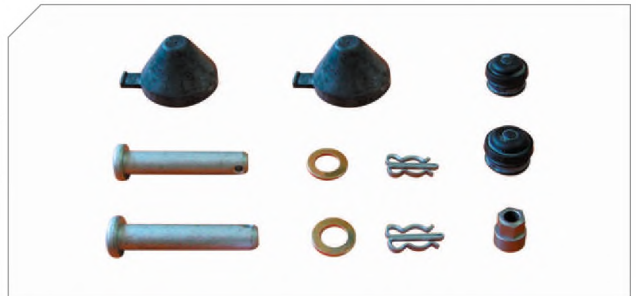

<b>Caliper Guide &amp; Bush</b> Kaliper Mil & Keçe	
SEM Kit No	<b>12176</b>
Org. Kit Ref. No	--
Application	All SB 5..., SB 6..., SB 7... Series All SN 5..., SN 6..., SN 7... Series



<b>Caliper Guide &amp; Bush</b> Kaliper Mili & Keçesi	
SEM Kit No	<b>12228</b>
Org. Kit Ref. No	K 000697
Application	SB 6547, SB 6557, SB 7884, SB 7894, SB 7907, SB 7020, SB 7022 SN 6529, SN 6539, SN 7067, SN 7077, SN 7084, SN 7094, SN 7086, SN 7096 SN 7106, SN 7116, SN 7125, SN 7135, SN 7144, SN 7154, NA 7027, NA 7028 NA 7038, SK 7..., SN 65..., SN 66..., SN 7..., SN 71..., SN 72..., SN 73.. Series

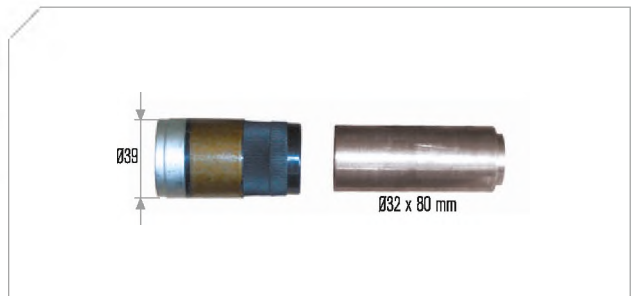



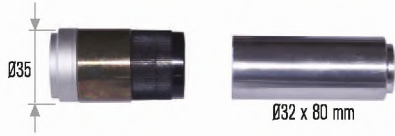

**Caliper Guide & Bush**

Kaliper Mil & Keçe

SEM Kit No **12177**

Org. Kit Ref. No K 000698

Application All SB 5..., SB 6..., SB 7... Series  
All SN 5..., SN 6..., SN 7... Series



**Caliper Guide & Bush**

Kaliper Mil & Keçe

SEM Kit No **12229**

Org. Kit Ref. No --

Application All SB 5..., SB 6..., SB 7... Series  
All SN 5..., SN 6..., SN 7... Series



**Caliper Guide & Bush**

Kaliper Mil & Keçe

SEM Kit No **12230**

Org. Kit Ref. No --

Application SB 7521, SB 7581, SB 7661, SB 7580



**Caliper Guides & Seals Repair Kit**

Kaliper Mil & Keçe Tamir Takımı

SEM Kit No **12231**

Org. Kit Ref. No II 39769F0062

Application SB 65..., SB 71..., SB 75..., SB 76..., SB 77..., SB 78..., SB 79..



**Set of Adjuster Cap**

Ayar Mekanizması Kap Seti

SEM Kit No **10696**

Org. Kit Ref. No K 000945 • DAF Ref.no: 1439493, MAN Ref.no: 81.50822.6021 • 81.50822.6024

Application SB 5..., SB 6..., SB 7... Series



**Caliper Rubber Bush Guidance Repair Kit**

KaliperKauçuk Burç & Mil Tamir Takımı

SEM Kit No **12181**

Org. Kit Ref. No --

Application All SB..., All SN...

<b>Caliper Guide &amp; Bush Repair Kit</b> Kaliper Burç & Mil Tamir Takımı	
SEM Kit No	<b>12182</b>
Org. Kit Ref. No	K000698 • K000697
Application	SB 6..., All SB 7...

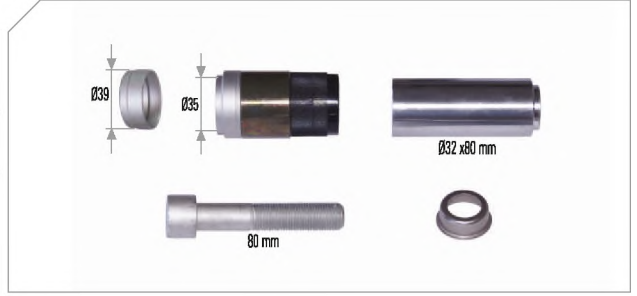

<b>Caliper Guides &amp; Seals Repair Kit</b> Kaliper Mil & Burç Tamir Takımı	
SEM Kit No	<b>12232</b>
Org. Kit Ref. No	K000687 • K000386
Application	SB 7880



<b>Caliper Guides &amp; Seals Repair Kit</b> Kaliper Mil & Keçe Tamir Takımı	
SEM Kit No	<b>12185</b>
Org. Kit Ref. No	K 000365
Application	All Series



<b>Caliper Guides &amp; Seals Repair Kit</b> Kaliper Mil & Keçe Tamir Takımı	
SEM Kit No	<b>12233</b>
Org. Kit Ref. No	K 004168 • SAF Ref.no: 3.434.3815.00
Application	--



<b>Caliper Guides &amp; Seals Repair Kit</b> Kaliper Mil & Keçe Tamir Takımı	
SEM Kit No	<b>12234</b>
Org. Kit Ref. No	K 048434K62 • SAF Ref.no: 3.434.3820.00
Application	--



<b>Caliper Guides &amp; Seals Repair Kit</b> Kaliper Mil & Keçe Tamir Takımı	
SEM Kit No	<b>12186</b>
Org. Kit Ref. No	K 048371K50
Application	SB 6547, SB 6557, SB 7884, SB 7984, SB 7907, SB 7020, SB 7022





**Caliper Guides & Seals Repair Kit**

Kaliper Mil & Keçe Tamir Takımı

SEM Kit No **12187**

Org. Kit Ref. No K 048396K50

Application SB 7122, SB 7132, SB 7126, SB 7136, SB 7586, SB 7596, SB 7666, SB 7676  
SB 7785, SB 7795, SB 7840, SB 7850, SB 7859, SB 7869



**Caliper Dust Boot & Cap Repair Kit**

Kaliper Korumak & Kapak Tamir Takımı

SEM Kit No **12188**

Org. Kit Ref. No II 328090061 / MERCEDES Ref.no: 001 420 52 83 • 000 420 30 15

Application All SB... Series



**Caliper Guides & Seals Repair Kit**

Kaliper Mil & Keçe Tamir Takımı

SEM Kit No **12189**

Org. Kit Ref. No -

Application SB 7122, SB 7132, SB 7126, SB 7136, SB 7586, SB 7596, SB 7666, SB 7676  
SB 7795, SB 7840, SB 7850, SB 7859, SB 7869



**Caliper Guides & Seals Repair Kit**

Kaliper Keçe Tamir Takımı

SEM Kit No **12190**

Org. Kit Ref. No -

Application -



**Caliper Guides & Seals Repair Kit**

Kaliper Mil & Keçe Tamir Takımı

SEM Kit No **12235**

Org. Kit Ref. No II 358510062 • SCANIA Ref.no: 1415149  
MERCEDES Ref.no: 000 420 1182 • 050 121 1047

Application SB 7



**Caliper Guides & Seals Repair Kit**

Kaliper Mil & Keçe Tamir Takımı

SEM Kit No **12236**

Org. Kit Ref. No K 010813

Application SB 7

<b>Caliper Rubber Bush Guidance Kit</b> Kaliper Mil Tamir Takımı	
SEM Kit No	<b>12237</b>
Org. Kit Ref. No	II 339830064
Application	SB 7102

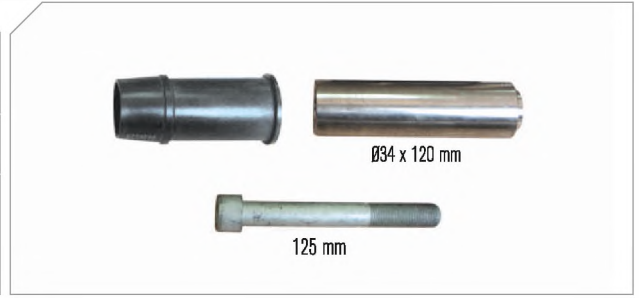

<b>Caliper Pad Retainer Repair Kit</b> Kaliper Balata Tutucu Tamir Takımı	
SEM Kit No	<b>12238</b>
Org. Kit Ref. No	II 19712004 / K000129 • MERCEDES Ref.no: 000 420 0882 • 627 420 0186
Application	SN 5..., SB 6..., SB 7..., SN 7... Series

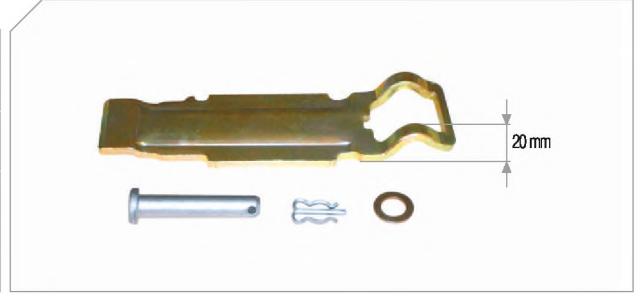

<b>Caliper Pad Retainer Repair Kit</b> Kaliper Balata Tutucu Tamir Takımı	
SEM Kit No	<b>12239</b>
Org. Kit Ref. No	K000133 • MERCEDES Ref.no: A 000 420 2482
Application	SN 6..., SK 7... Series

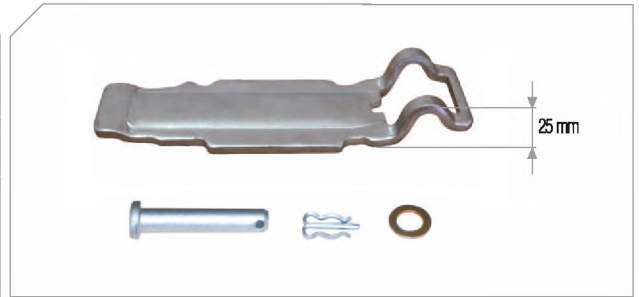

<b>Caliper Adjusting Mechanism Repair Kit</b> Kaliper Ayar Mekanizması Tamir Takımı	
SEM Kit No	<b>12240</b>
Org. Kit Ref. No	--
Application	All SB 6..., SB 7..., SN 6..., SN 7... Series



<b>Caliper Adjusting Mechanism Repair Kit</b> Kaliper Ayar Mekanizması Tamir Takımı	
SEM Kit No	<b>12241</b>
Org. Kit Ref. No	--
Application	All SB 6..., SB 7..., SN 6..., SN 7... Series





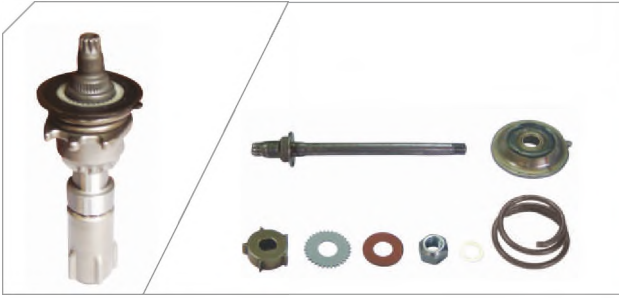

**Caliper Adjusting Mechanism Repair Kit**

Kaliper Ayar Mekanizması Tamir Takımı

SEM Kit No **10700**

Org. Kit Ref. No --

Application SN 5..., SB 6..., SB 7..., SN 6..., SN 7..., SK... Series



**Caliper Adjusting Mechanism Repair Kit**

Kaliper Ayar Mekanizması Tamir Takımı

SEM Kit No **10701**

Org. Kit Ref. No --

Application All SB 6..., SB 7..., SN 6..., SN 7... Series



**Caliper Adjusting Mechanism Repair Kit**

Kaliper Ayar Mekanizması Tamir Takımı

SEM Kit No **12242**

Org. Kit Ref. No --

Application SB 6..., SB 7..., SN 6..., SN 7... SK... Series



**Caliper Chain (28 links)**

Kaliper Zinciri (28 bakla)

SEM Kit No **10702**

Org. Kit Ref. No --

Application All SB 6..., SB 7..., SN 6..., SN 7... Series

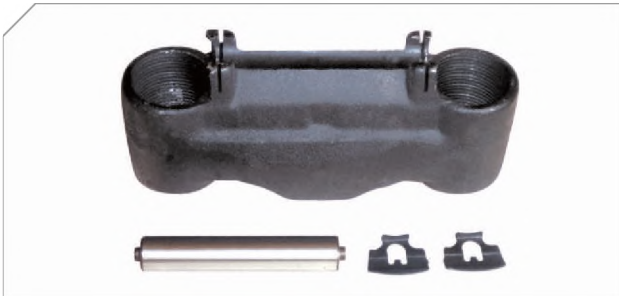

**Caliper Bridge Assembly**

Kaliper Köprü Bağlantısı

SEM Kit No **10704**

Org. Kit Ref. No --

Application SB 6..., SB 7..., SN 6..., SN 7... SK... Series



**Caliper Bridge Assembly**

Kaliper Köprü Bağlantısı

SEM Kit No **10705**

Org. Kit Ref. No --

Application SB 6..., SB 7..., SN 6..., SN 7... SK... Series

<b>Caliper Bridge Assembly</b> Kaliper Köprü Bağlantısı	
SEM Kit No	<b>10706</b>
Org. Kit Ref. No	
Application	SB 6..., SB 7..., SN 6..., SN 7... SK... Series



<b>Caliper Bridge Assembly-Pistons</b> Kaliper Köprü Bağlantısı-Ayar Civatası	
SEM Kit No	<b>12243</b>
Org. Kit Ref. No	--
Application	SB 6..., SB 7..., SN 6..., SN 7... SK... Series



<b>Caliper Bridge Assembly-Pistons</b> Kaliper Köprü Bağlantısı-Ayar Civatası	
SEM Kit No	<b>12244</b>
Org. Kit Ref. No	--
Application	SB 6..., SB 7..., SN 6..., SN 7... SK... Series



<b>Caliper Bridge Assembly-Pistons</b> Kaliper Köprü Bağlantısı-Ayar Civatası	
SEM Kit No	<b>12245</b>
Org. Kit Ref. No	--
Application	SB 6..., SB 7..., SN 6..., SN 7... SK... Series



<b>Caliper Roller Bearing</b> Kaliper Rulmanları	
SEM Kit No	<b>10708</b>
Org. Kit Ref. No	--
Application	All SB 5..., SB 65..., SB 71..., SB 75..., SB 76..., SB 77..., SB 78..., SB 79..., SN 5... Series



<b>Caliper Roller Bearing</b> Kaliper Rulmanları	
SEM Kit No	<b>10709</b>
Org. Kit Ref. No	--
Application	All SB 5..., SB 65..., SB 71..., SB 75..., SB 76..., SB 77..., SB 78..., SB 79..., SN 5... Series





**Caliper Calibration Bolt**

Kaliper Ayar Civatası

SEM Kit No	<b>10711</b>
Org. Kit Ref. No	
Application	All SB 5 ..., SB 6..., SB 7... All SN 6..., SN 7...



SEM Kod No	Sensor / Sensör	Vehicle / Araç
<b>10712</b>	Caliper Sensor Cover Kaliper Sensör Kapağı (Without Sensor) (Sensorsuz)	MERCEDES (ACTROS, ATEGO, AXOR) MAN TGA
	Caliper Sensor Cover Kaliper Sensör Kapağı (2 Cable Sensor) (2 Kablolu Sensör)	MERCEDES ATEGO, AXOR, MAN
	Caliper Sensor Cover Kaliper Sensör Kapağı (3 Cable Sensor) (3 Kablolu Sensör)	MERCEDES ACTROS
	Caliper Sensor Cover Kaliper Sensör Kapağı (MAN Type 3 Cable Sensor) (MAN Tipi 3 Kablolu Sensör)	MAN TGA



**Caliper Sensor Cover (Aluminium)**

Kaliper Sensör Kapağı (Alüminyum)

SEM Kit No	<b>12246</b>
Org. Kit Ref. No	—
Application	—



SEM Kod No	Sensor / Sensör	Vehicle / Araç
<b>10714</b>	Caliper Sensor Cover Kaliper Sensör Kapağı (Without Sensor) (Sensorsüz)	DAF, SCANIA, IVECO
	Caliper Sensor Cover Kaliper Sensör Kapağı (2 Cable Sensor) (2 Kablolu Sensör)	DAF, SCANIA, IVECO
	Caliper Sensor Cover Kaliper Sensör Kapağı (3 Cable Sensor) (3 Kablolu Sensör)	DAF, SCANIA, IVECO



SEM Kod No	OEM Ref No	Description	Length
<b>12197</b>	449 756 020 0	Sensor Cable with Connector Socket/ Bağlantı Soketli Sensör Kablosu	2,0 m
	449 756 020 0	Sensor Cable with Connector Socket/ Bağlantı Soketli Sensör Kablosu	3,5 m
	449 756 020 0	Sensor Cable with Connector Socket/ Bağlantı Soketli Sensör Kablosu	5,0 m
	449 756 020 0	Sensor Cable with Connector Socket/ Bağlantı Soketli Sensör Kablosu	8,0 m
	449 756 020 0	Sensor Cable with Connector Socket/ Bağlantı Soketli Sensör Kablosu	10,0 m
	449 756 020 0	Sensor Cable with Connector Socket/ Bağlantı Soketli Sensör Kablosu	12,0 m

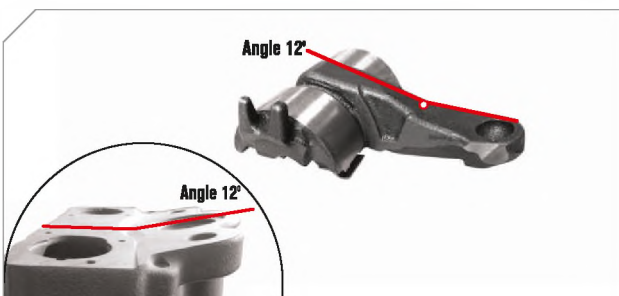

**Caliper Lever (Angle 12°)**

Kaliper Masura Bilya Yatağı (Açı 12°)

SEM Kit No	<b>10716</b>
Org. Kit Ref. No	—
Application	SB 6..., SB 7..., SN 6..., SN 7... SK... Series

<b>Caliper Lever (Angle 0°)</b> Kaliper Masura Bilya Yatağı (Açı 0°)	
SEM Kit No	<b>10717</b>
Org. Kit Ref. No	--
Application	SB 6..., SB 7..., SN 6..., SN 7... SK... Series

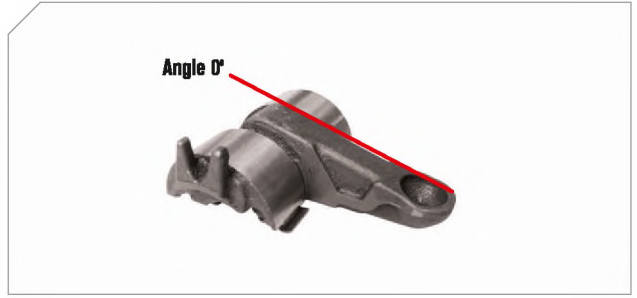

<b>Caliper Lever (Angle 0°)</b> Kaliper Masura Bilya Yatağı (Açı 0°)	
SEM Kit No	<b>10718</b>
Org. Kit Ref. No	--
Application	SB 6..., SB 7..., SN 6..., SN 7... SK... Series

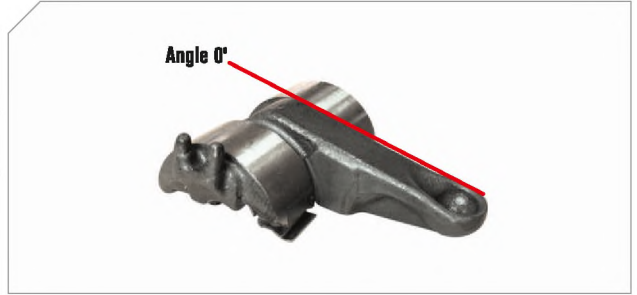

<b>Caliper Lever (Angle 12°)</b> Kaliper Masura Bilya Yatağı (Açı 12°)	
SEM Kit No	<b>10719</b>
Org. Kit Ref. No	--
Application	SB 6..., SB 7..., SN 6..., SN 7... SK... Series

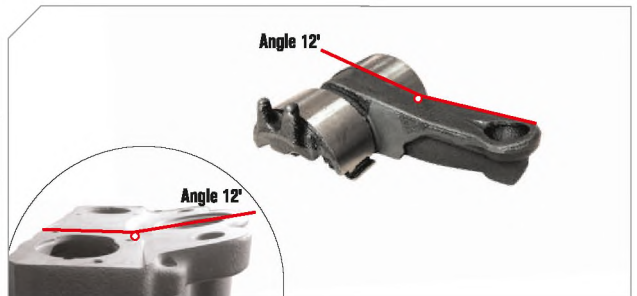

<b>Caliper Lever (Angle 0°)</b> Kaliper Masura Bilya Yatağı (Açı 0°)	
SEM Kit No	<b>12247</b>
Org. Kit Ref. No	--
Application	SB 6..., SB 7..., SN 6..., SN 7... SK... Series SN 6507, SN 6373

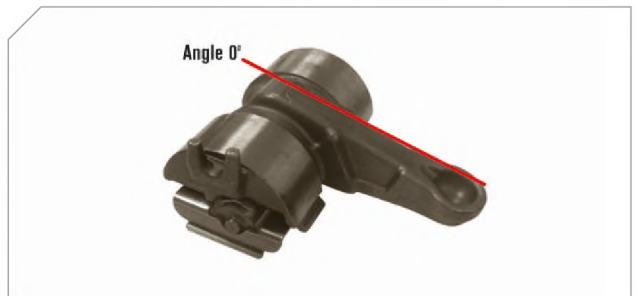

<b>Caliper Lever (Angle 12°)</b> Kaliper Masura Bilya Yatağı (Açı 12°)	
SEM Kit No	<b>12198</b>
Org. Kit Ref. No	--
Application	--

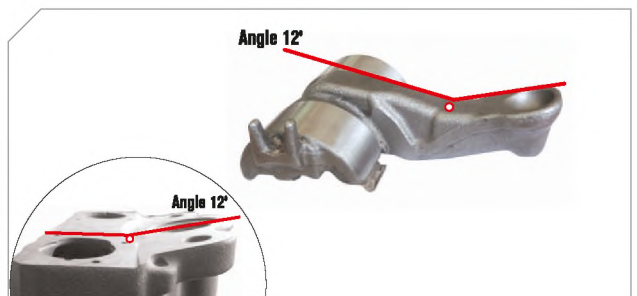

<b>Caliper Lever (Angle 0°)</b> Kaliper Masura Bilya Yatağı (Açı 0°)	
SEM Kit No	<b>12199</b>
Org. Kit Ref. No	--
Application	--

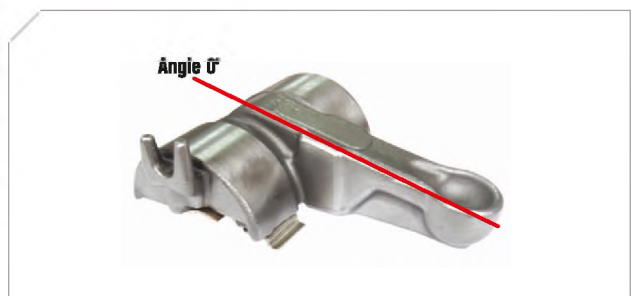





<b>Caliper Lever</b> Kaliper Masura Bilya Yatađı	
SEM Kit No	<b>12248</b>
Org. Kit Ref. No	--
Application	--

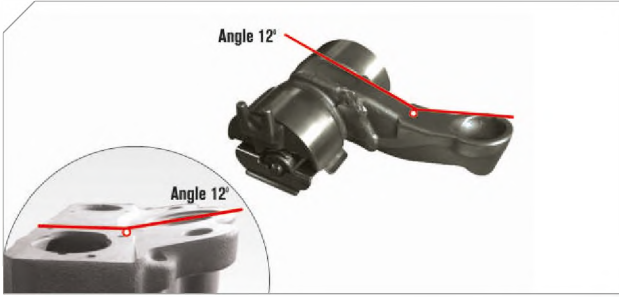

<b>Caliper Lever (Angle 12°)</b> Kaliper Masura Bilya Yatađı (Açı 12°)	
SEM Kit No	<b>12249</b>
Org. Kit Ref. No	--
Application	--



<b>Caliper Lever</b> Kaliper Masura Bilya Yatađı	
SEM Kit No	<b>12250</b>
Org. Kit Ref. No	--
Application	--

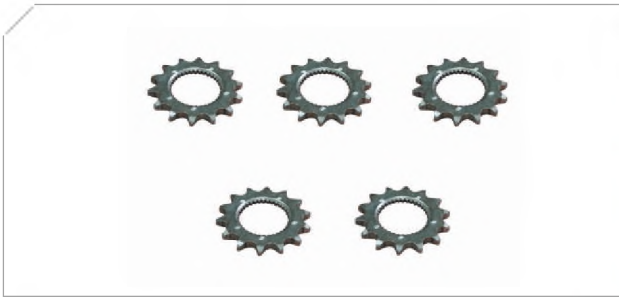

<b>Caliper Gear Wheel Adjusting Mechanism</b> Kaliper Ayar Diđlisi	
SEM Kit No	<b>12202</b>
Org. Kit Ref. No	--
Application	All SB..., SN... Series

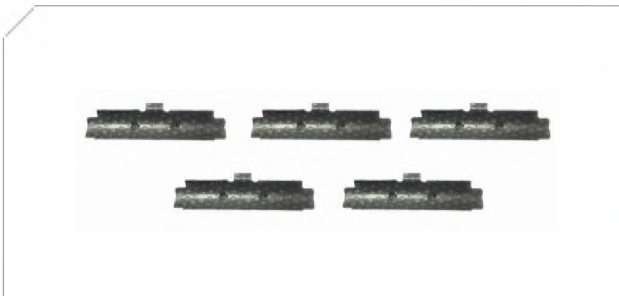

<b>Caliper Lever Bearing</b> Kaliper Masura Yatađı	
SEM Kit No	<b>12252</b>
Org. Kit Ref. No	--
Application	All SB 6..., SB 7..., SN 6..., SN 7... Series

<b>Plastic Shaft</b> Plastik Şaft	
SEM Kit No	<b>12206</b>
Org. Kit Ref. No	--
Application	--

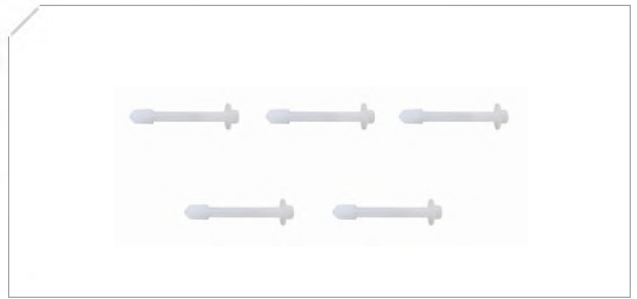

<b>Plastic Shaft</b> Plastik Şaft	
SEM Kit No	<b>12207</b>
Org. Kit Ref. No	--
Application	--



<b>Plastic Shaft</b> Plastik Şaft	
SEM Kit No	<b>12208</b>
Org. Kit Ref. No	--
Application	--





**SN 6... / SN 7...**  
**SK 6... / SK 7...**  
**SL 7... / SM 7...**  
Type Caliper Repair Kits

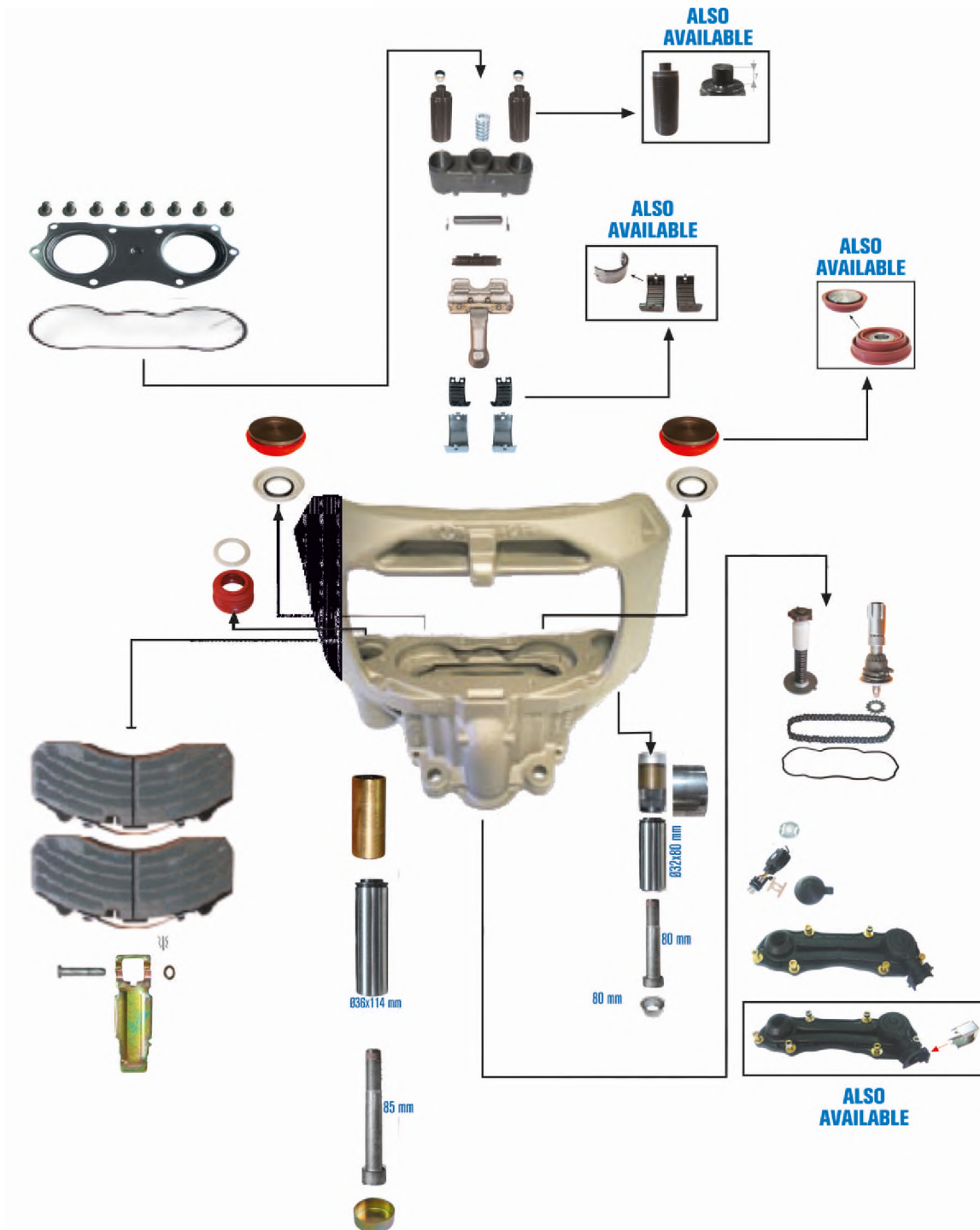

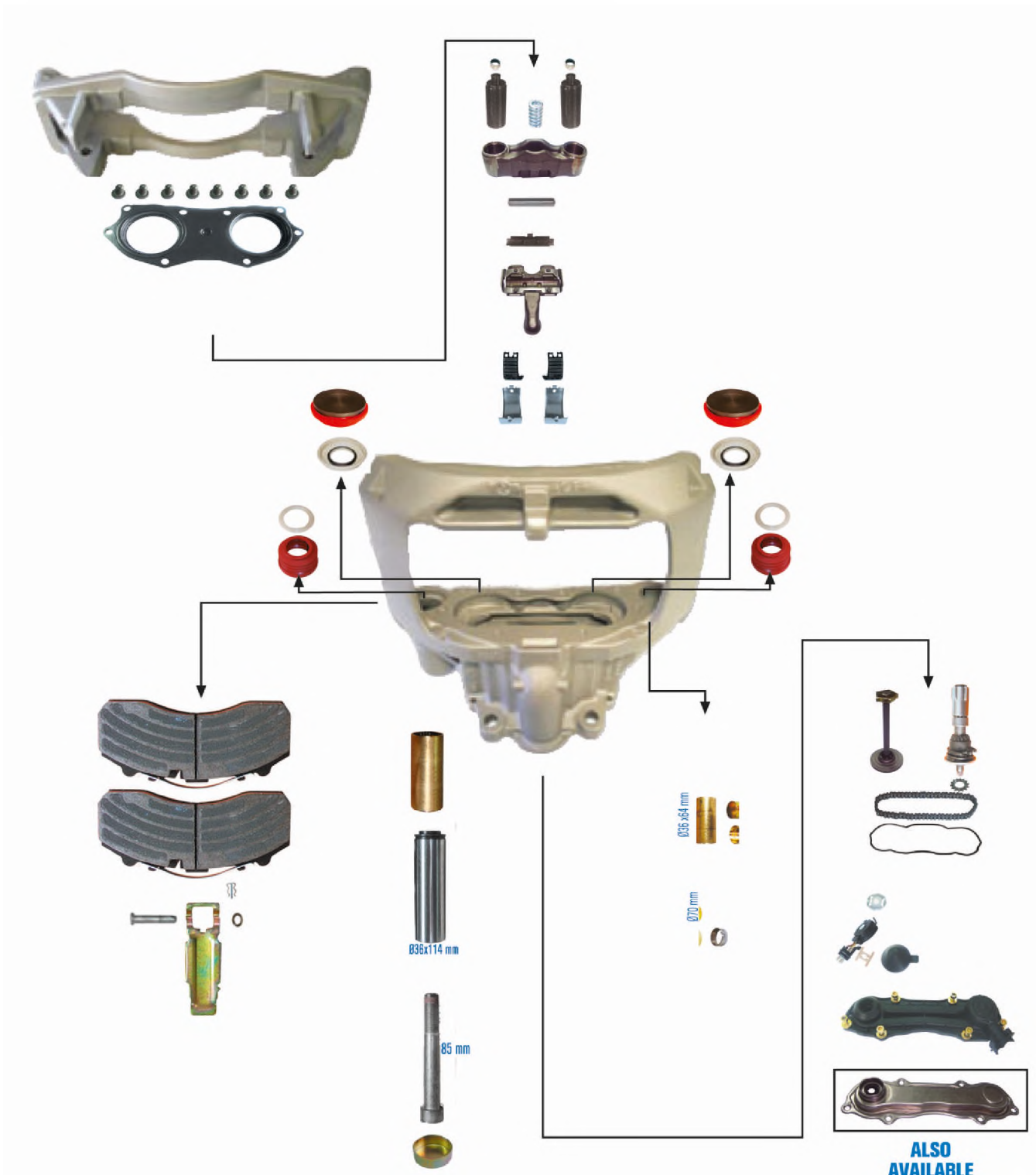

SN6 & SN7 TYPE CALIPERS		AXLE // AKS		SEM REPAIR KITS/ /SEM Tamir Takımları
Vehicles // Araçlar	Models // Modeller	Left // Sol	Right // Sağ	
BOVA	FHD10, 12, 14, 15 FLD 12, 14, 15	SN7186 K003783	SN7196 K003784	10684 10690
BPW	Axle 19.5" Wheel +5'	SN6563 / SN6581 K003780 / K013203	SN6573 / SN6571 K003779 / K013204	10684 10690 10683 10689
	Axle 22.5" Wheel 0'	SN7196 K003784	SN7186 K003783	10684 10690
DAF-LEYLAND	SB 120	SN6555 K003825	SN6565 K003826	10684 10690
	CF 65 F 65 CF 75 LF 55 CF 85 XF 95	SN7214 K003806	SN7204 K003805	10684 10690
	Powersystems 19.5" Whell (97+) Powersystems 22.5" Whell (97+) Atego 1220, 1528 Actros (95+), Atego S (01+) Axor(98+) Econic (02+)	SN6565 K003826 SN7195 K003782 SN6557 K003791 SN7211 K003800	SN6555 K003825 SN7185 K003781 SN6567 K003792 SN7201 K003799	10684 10690 10684 10690 10684 10684 10684 10690
DENNIS	Trident II (01+)	SN7203 K003803	SN7213 K003804	10684 10690
EVOBUS (MERCEDES)	CITARO (8 Wheels)	SN7211 K003800	SN7201 K003799	10684 10690
	CITARO (6 Wheels)	SN7211 / SN7461 K003800 / K002965	SN7201 / SN7461 K003799 / K002965	10684 10690 10683 10689
	CITO (98+)	SN7211 / SN7216 K003800 / K003810	SN7201 / SN7206 K003799 / K003809	10684 10690
	S3 (01.96-06.96)	SN7213 K003804	SN7203 K003803	10684 10690
	S3 (07.96-01.99)	SN7213 K003804	SN7203 K003803	10684 10690
	S316 HDS, S328 DT	SN7199 K003796	SN7189 K003795	10684 10690
	Travego (99+)	SN7211 K003800 SN7216 K003810	SN7201 K003799 SN7206 K003809	10684 10690 10684 10690
GIGANT SAE	19.5" Whells (98+)	SN6563 K003780	SN6573 K003779	10684 10690
	22.5" Whells	SN7195 / SN7196 K003782 / K003784	SN7185 / SN7186 K003781 / K003784	10684 10690
IVECO	Eurostar (97+) Eurotech (97+)	SN7195 / SN7211 K003782 / K003800	SN7185 / SN7201 K003781 / K003799	10684 10690
	Eurocargo 120, 130, 150 (01+)	SN6555 K003825	SN6565 K003826	10684 10690

SN6 & SN7 TYPE CALIPERS		AXLE // AKS		SEM REPAIR KITS/ /SEM Tamir Takımları
Vehicles // Araçlar	Models // Modeller	Left // Sol	Right // Sağ	
LECINENA	Axle - 19.5" Wheel (98+)	SN6565 K003826	SN6555 K003825	10684 10690
	Axle - 22.5" Wheel (98+)	SN7169 K003784	SN7186 K003783	10684 10690
MAN	14 T HOCL TAB A66 (98+)M2000 (96+)	SN6565 K003826	SN6555 K003825	10684 10690
NEOPLAN	Reisbusse (3 Axle) Skyliner (3 Axle) Starliner (3 Axle)	SN7186 / SN7206 K003783 / K003809	SN7196 / SN7216 K003784 / K003810	10684 10690 10684 10690
	Skyliner (2 Axle) - Transliner (2 Axle) Starliner (2 Axle) - Linienbus (2 Axle) Controliner (3 Axle) - Cityliner 2 Controliner (2 Axle)	SN7196 / SN7216 K003784 / K003810	SN7186 / SN7206 K003783 / K003809	10684 10690 10684 10690 10684 10690
	Linienbus (3 Axle)	SN7196 K003784	SN7186 K003783	10684 10690
		SN7461 K002965	SN7461 K002965	10684 10690
		SN7216 K003810	SN7206 K003809	10684 10690
	RABA	Axle, 22.5" Wheel	SN7195 K003782	SN7185 K003781
SAF	Axle, 19.5" Wheel (+5')	SN6565 K003826	SN6555 K003825	10684 10690
	Axle, 22.5" Wheel (0')	SN7196 / SN7216 K003784 / K003810	SN7186 / SN7206 K003783 / K003809	10684 10690
	Axle, 22.5" Wheel (-12')	SN7195 K003782	SN7185 K003781	10684 10690
SCANIA	114 (Bus, 99 to 01)	SN7213 K003804	SN7203 K003803	10684 10690
		SN7196 K003784	SN7186 K003783	10684 10690
	114 (96+) 144 (96+)	SN7216 K003810	SN7206 K003809	10684 10690
	124 (96+)			
	4 Series (Bus)	SN7213 K003804	SN7203 K003803	10684 10690
4 Series (Truck) R Series	SN7208 K003813	SN7218 K003814		
SMB	Axle, 19.5" Wheel (+5") 98+	SN6563 K003780	SN6573 K003779	10684 10690
	Axle, 22.5" Wheel (-12") 98+ with sensor	SN7195 K003782	SN7185 K003781	10684 10690
	Axle, 22.5" Wheel (-12") 98+	SN7211 K003800	SN7201 K003799	10684 10690



<b>Caliper Piston Repair Kit</b> Kaliper Piston Tamir Takımı	
SEM Kit No	<b>10678</b>
Org. Kit Ref. No	II 30413/065 / II 179320065
Application	All SB 6..., All SB 7... Series



<b>Caliper Boots &amp; Piston Repair Kit</b> Kaliper Korumak & Piston Tamir Takımı	
SEM Kit No	<b>12211</b>
Org. Kit Ref. No	
Application	All SB... Series



<b>Caliper Piston Repair Kit</b> Kaliper Piston Tamir Takımı	
SEM Kit No	<b>10679</b>
Org. Kit Ref. No	--
Application	SN 6..., SN 7..., SK 7..., NA 7



<b>Caliper Piston Repair Kit</b> Kaliper Piston Tamir Takımı	
SEM Kit No	<b>12212</b>
Org. Kit Ref. No	K 001929
Application	SN 6..., SN 7..., SK 7..., NA 7



<b>Caliper Piston Repair Kit</b> Kaliper Piston Tamir Takımı	
SEM Kit No	<b>12253</b>
Org. Kit Ref. No	--
Application	SN 6..., SN 7..., SK 7..., NA 7



<b>Caliper Piston Repair Kit</b> Kaliper Piston Tamir Takımı	
SEM Kit No	<b>12254</b>
Org. Kit Ref. No	--
Application	SN 6..., SN 7..., SK 7..., NA 7







### Caliper Boots & Piston Repair Kit

Kaliper Korumak & Piston Tamir Takımı

SEM Kit No **10683**

Org. Kit Ref. No K000944 / K 010604  
MERCEDES Ref.no: A 000 420 3982 • SCANIA, MAN, BPW

Application All SB 5..., SB 6..., SB 7..., SN 5... Series



### Caliper Boots & Piston Repair Kit

Kaliper Korumak & Piston Tamir Takımı

SEM Kit No **10684**

Org. Kit Ref. No K 001300 / K 010603 / K 000366  
MAN Ref.no: 81.50822.6020, MERCEDES Ref.no: A 000 420 2382 / 4082

Application NA 7027, NA 7028, NA 7037, NA 7038, NA 75..., SK 7..., SN 65..., SN 66..., SN 7..., SN 71..., SN 72..., SN 73.. Series



### Caliper Piston Repair Kit

Kaliper Piston Tamir Takımı

SEM Kit No **12255**

Org. Kit Ref. No K046523K50

Application SL 7..., SM 7...



### Caliper Boots & Piston Repair Kit

Kaliper Korumak & Piston Tamir Takımı

SEM Kit No **12213**

Org. Kit Ref. No K 010606

Application -



### Caliper Boots & Piston Repair Kit

Kaliper Korumak & Piston Tamir Takımı

SEM Kit No **12214**

Org. Kit Ref. No K 015542

Application -



### Caliper Guides & Seals Repair Kit

Kaliper Mil & Keçe Tamir Takımı

SEM Kit No **10689**

Org. Kit Ref. No K 000375 • MAN Ref.no: 81.50822.6023

Application SB 6547, SB 6557, SB 7884, SB 7984, SB 7907, SB 7020, SB 7022

<b>Caliper Guides &amp; Seals Repair Kit</b> Kaliper Mil & Keçe Tamir Takımı	
SEM Kit No	<b>12215</b>
Org. Kit Ref. No	K 001470 • MERCEDES Ref.no: A 000 420 34 82
Application	--

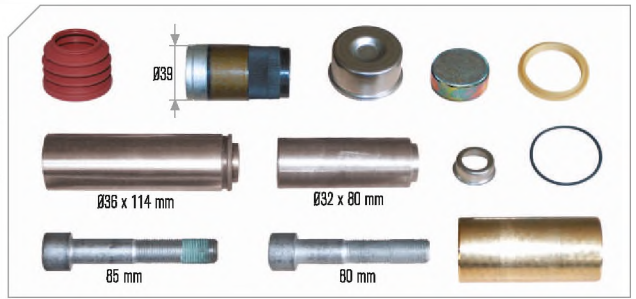

<b>Caliper Guides &amp; Seals Repair Kit</b> Kaliper Mil & Keçe Tamir Takımı	
SEM Kit No	<b>12217</b>
Org. Kit Ref. No	
Application	SB 5..., SB 6..., SB 7..., SN 5... Series



<b>Caliper Guides &amp; Seals Repair Kit</b> Kaliper Mil & Keçe Tamir Takımı	
SEM Kit No	<b>12218</b>
Org. Kit Ref. No	
Application	SB 5..., SB 6..., SB 7..., SN 5... Series



<b>Caliper Guides &amp; Seals Repair Kit</b> Kaliper Mil & Keçe Tamir Takımı	
SEM Kit No	<b>12219</b>
Org. Kit Ref. No	
Application	--



<b>Caliper Guides &amp; Seals Repair Kit</b> Kaliper Mil & Keçe Tamir Takımı	
SEM Kit No	<b>12220</b>
Org. Kit Ref. No	
Application	--



<b>Caliper Guides &amp; Seals Repair Kit</b> Kaliper Mil & Keçe Tamir Takımı	
SEM Kit No	<b>10690</b>
Org. Kit Ref. No	K 000472 • MAN Ref.no: 81.50822.6019
Application	SN 6529, SN 6539, SN 7067, SN 7077, SN 7084, SN 7094, SN 7086, SN 7096, SN 7106, SN 7116, SN 7125, SN 7135, SN 7144, SN 7154, NA 7027, NA 7028, NA 7038, SK 7..., SN 65..., SN 66..., SN 7..., SN 71..., SN 72..., SN 73.. Series



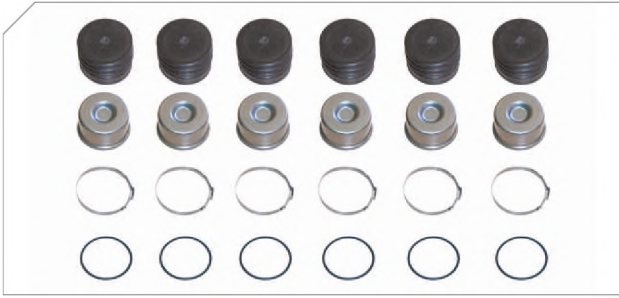

### Caliper Outer Boots & Steelcaps Repair Kit

Kaliper Dış Körtükleri & Kapları Tamir Takımı

SEM Kit No **10691**

Org. Kit Ref. No K 001301 / II350470063  
MAN Ref.no: 81.50822.6025 • DAF-LEYLAND Ref.no: 1439494

Application All SB... & SN... Series



### Brake Pad Kit

Disk Fren Balata Tamir Takımı

SEM Kit No **12223**

Org. Kit Ref. No 20928564

Application All SB 6..., SN 6... Series



### Caliper Guides & Seals Repair Kit

Kaliper Mil & Keçe Tamir Takımı

SEM Kit No **10694**

Org. Kit Ref. No K 001915 / K 028451

Application SN 6508, SN 6518, SN 6504, SN 6514, SN 6548, SN 6558, SN 7020, SN 7021  
SN 7030, NSN 7031, SN 7022, SN 7032, SN 7060, SN 7070, SN 7... Series

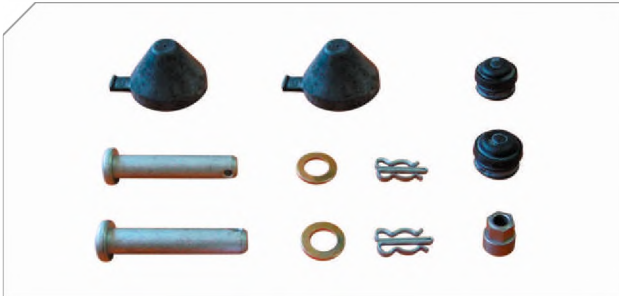

### Caliper Caps & Pad Retainer Pins

Kaliper Kapları & Balata Tutucu Pimleri

SEM Kit No **12175**

Org. Kit Ref. No -

Application All SB..., All SN... Series

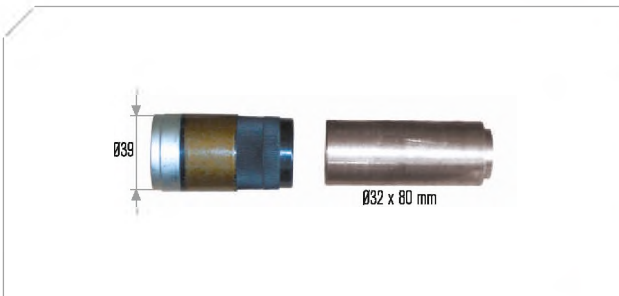

### Caliper Guide & Bush (Long)

Kaliper Mili & Keçesi (Uzun)

SEM Kit No **12228**

Org. Kit Ref. No -

Application SB 6547, SB 6557, SB 7884, SB 7894, SB 7907, SB 7020, SB 7022  
SN 6529, SN 6539, SN 7067, SN 7077, SN 7084, SN 7094, SN 7086, SN 7096  
SN 7106, SN 7116, SN 7125, SN 7135, SN 7144, SN 7154, NA 7027, NA 7028  
NA 7038, SK 7..., SN 65..., SN 66..., SN 7..., SN 71..., SN 72..., SN 73... Series



<b>Caliper Guide &amp; Bush</b> Kaliper Mil & Keçe	
SEM Kit No	<b>12177</b>
Org. Kit Ref. No	K 000698
Application	All SB 5..., SB 6..., SB 7... Series All SN 5..., SN 6..., SN 7... Series



<b>Caliper Guide &amp; Bush</b> Kaliper Mil & Keçe	
SEM Kit No	<b>12178</b>
Org. Kit Ref. No	--
Application	All SB 5..., SB 6..., SB 7... Series All SN 5..., SN 6..., SN 7... Series

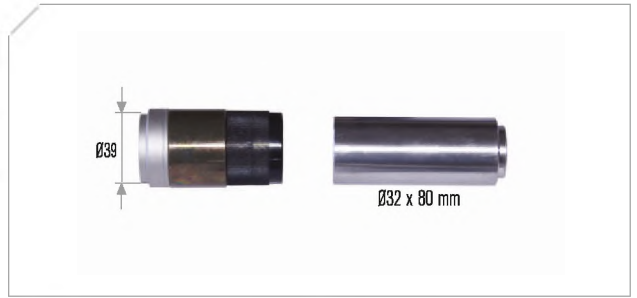

<b>Caliper Guide &amp; Bush</b> Kaliper Mil & Keçe	
SEM Kit No	<b>12229</b>
Org. Kit Ref. No	--
Application	All SB 5..., SB 6..., SB 7... Series All SN 5..., SN 6..., SN 7... Series



<b>Caliper Guide &amp; Bush (Short)</b> Kaliper Mili & Keçesi (Kısa)	
SEM Kit No	<b>12256</b>
Org. Kit Ref. No	--
Application	SN 6508, SN 6518, SN 6504, SN 6514, SN 6548, SN 6558, SN 7020, SN 7021 SN 7030, NSN 7031, SN 7022, SN 7032, SN 7060, SN 7070, SN 7... Series



<b>Caliper Caps</b> Kaliper Kapları	
SEM Kit No	<b>12257</b>
Org. Kit Ref. No	
Application	All SN... Series



<b>Caliper Guide Repair Kit</b> Kaliper Mil Tamir Takımı	
SEM Kit No	<b>12258</b>
Org. Kit Ref. No	K 013007
Application	SK... Series

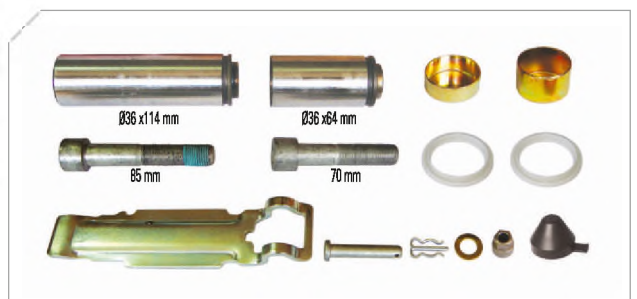



### Caliper Guides & Seals Repair Kit

Kaliper Mil & Keçe Tamir Takımı

SEM Kit No **10695**

Org. Kit Ref. No K 004100

Application SK... Series



### Set of Adjuster Cap

Ayar Mekanizması Kap Seti

SEM Kit No **10697**

Org. Kit Ref. No K 003902

Application All SN 5..., SN 6..., SN 7..., SK 7..., NA 7... Series



### Set of Adjuster Cap

Ayar Mekanizması Kap Seti

SEM Kit No **12179**

Org. Kit Ref. No K 000029

Application All SN 5..., SN 6..., SN 7..., SK 7..., NA 7... Series



### Caliper Rubber Bush Guidance Repair Kit

KaliperKauçuk Burç & Mil Tamir Takımı

SEM Kit No **12181**

Org. Kit Ref. No --

Application All SB..., All SN...

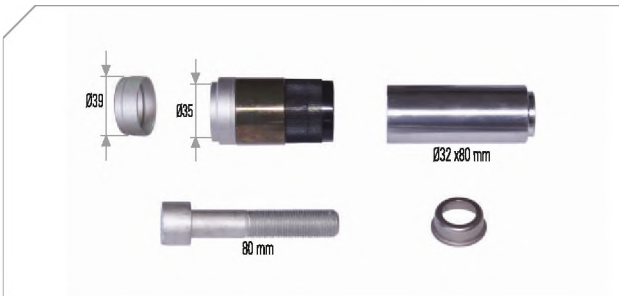

### Caliper Guide & Bush Repair Kit

Kaliper Burç & Mil Tamir Takımı

SEM Kit No **12182**

Org. Kit Ref. No K000698 • K000697

Application SB 6..., All SB 7...



### Caliper Guides & Seals Repair Kit

Kaliper Mil & Keçe Tamir Takımı

SEM Kit No **11814**

Org. Kit Ref. No K 011117 / K031844K50 • SCANIA Ref.no: 1906779 • 1756390

Application SN 7

<b>Caliper Guide &amp; Bush</b> Kaliper Mil & Keçe	
SEM Kit No	<b>12259</b>
Org. Kit Ref. No	--
Application	--

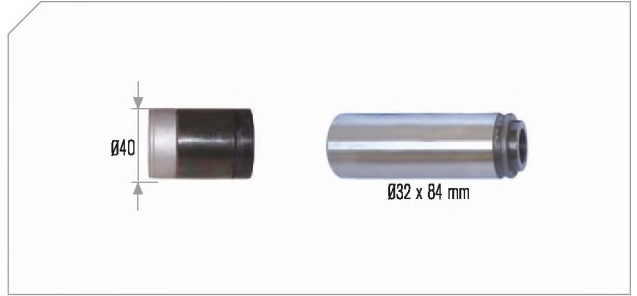

<b>Caliper Guides &amp; Seals Repair Kit</b> Kaliper Mil & Keçe Tamir Takımı	
SEM Kit No	<b>12260</b>
Org. Kit Ref. No	K 001925 • MERCEDES Ref.no: 000 420 43 82
Application	SN 6504, SN 6515



<b>Caliper Pad Retainer Repair Kit</b> Kaliper Balata Tutucu Tamir Takımı	
SEM Kit No	<b>12261</b>
Org. Kit Ref. No	K 002311 • IVECO Ref.no: 42541464
Application	--

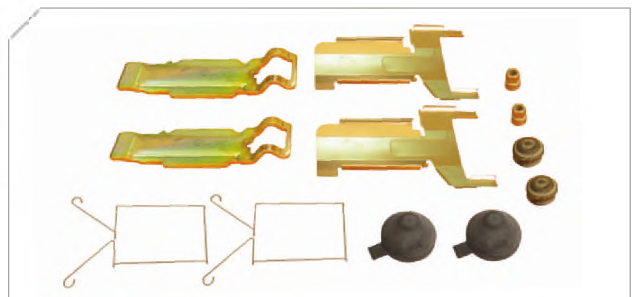

<b>Caliper Guides &amp; Seals Repair Kit</b> Kaliper Mil & Keçe Tamir Takımı	
SEM Kit No	<b>12185</b>
Org. Kit Ref. No	K 000365
Application	All Series



<b>Caliper Guides &amp; Seals Repair Kit</b> Kaliper Mil & Keçe Tamir Takımı	
SEM Kit No	<b>12233</b>
Org. Kit Ref. No	K 004168 • SAF Ref.no: 3.434.3815.00
Application	--



<b>Caliper Guides &amp; Seals Repair Kit</b> Kaliper Mil & Keçe Tamir Takımı	
SEM Kit No	<b>12234</b>
Org. Kit Ref. No	K 048434K62 • SAF Ref.no: 3.434.3820.00
Application	--

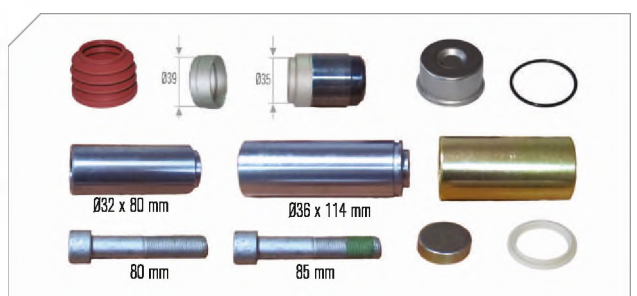



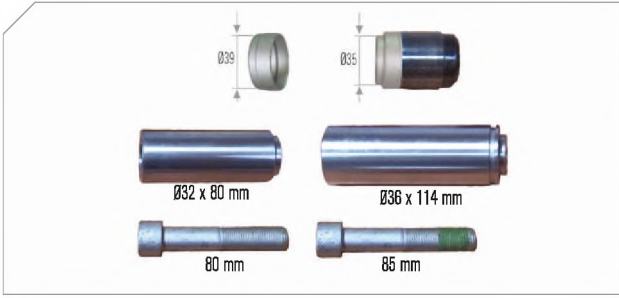

**Caliper Rubber Bush Guidance Repair Kit**

Kaliper Kauçuk Burç & Mil Tamir Takımı

SEM Kit No **12262**

Org. Kit Ref. No --

Application --



**Caliper Guides & Seals Repair Kit**

Kaliper Mil & Keçe Tamir Takımı

SEM Kit No **12186**

Org. Kit Ref. No K 048371K50

Application SB 6547, SB 6557, SB 7884, SB 7984, SB 7907, SB 7020, SB 7022



**Caliper Guides & Seals Repair Kit**

Kaliper Mil & Keçe Tamir Takımı

SEM Kit No **12187**

Org. Kit Ref. No K 048396K50

Application SB 7122, SB 7132, SB 7126, SB 7136, SB 7586, SB 7596, SB 7666, SB 7676, SB 7785, SB 7795, SB 7840, SB 7850, SB 7859, SB 7869



**Caliper Guides & Seals Repair Kit**

Kaliper Mil & Keçe Tamir Takımı

SEM Kit No **12263**

Org. Kit Ref. No K 012912

Application SL 7..., SM 7..



**Caliper Guides & Seals Repair Kit**

Kaliper Mil & Keçe Tamir Takımı

SEM Kit No **12264**

Org. Kit Ref. No --

Application SL 7..., SM 7..



**Caliper Guides & Seals Repair Kit**

Kaliper Mil & Keçe Tamir Takımı

SEM Kit No **12265**

Org. Kit Ref. No --

Application SL 7..., SM 7..

<b>Caliper Guides &amp; Seals Repair Kit</b> Kaliper Mil & Keçe Tamir Takımı	
SEM Kit No	<b>12189</b>
Org. Kit Ref. No	K 001532
Application	SB 7122, SB 7132, SB 7126, SB 7136, SB 7586, SB 7596, SB 7666, SB 7676 SB 7795, SB 7840, SB 7850, SB 7859, SB 7869



<b>Caliper Guides &amp; Seals Repair Kit</b> Kaliper Keçe Tamir Takımı	
SEM Kit No	<b>12190</b>
Org. Kit Ref. No	--
Application	--



<b>Caliper Pad Retainer Repair Kit</b> Kaliper Balata Tutucu Tamir Takımı	
SEM Kit No	<b>12238</b>
Org. Kit Ref. No	II 19712004 / K000129 • MERCEDES Ref.no: 000 420 0882 • 627 420 0186
Application	SN 5..., SB 6..., SB 7..., SN 7... Series



<b>Caliper Pad Retainer Repair Kit</b> Kaliper Balata Tutucu Tamir Takımı	
SEM Kit No	<b>12239</b>
Org. Kit Ref. No	K000133 • MERCEDES Ref.no: A 000 420 2482
Application	SN 6..., SK 7... Series

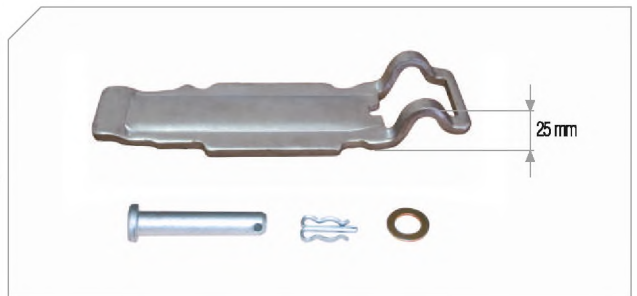

<b>Caliper Adjusting Mechanism Repair Kit</b> Kaliper Ayar Mekanizması Tamir Takımı	
SEM Kit No	<b>12240</b>
Org. Kit Ref. No	--
Application	All SB 6..., SB 7..., SN 6..., SN 7... Series



<b>Caliper Adjusting Mechanism Repair Kit</b> Kaliper Ayar Mekanizması Tamir Takımı	
SEM Kit No	<b>12241</b>
Org. Kit Ref. No	--
Application	All SB 6..., SB 7..., SN 6..., SN 7... Series





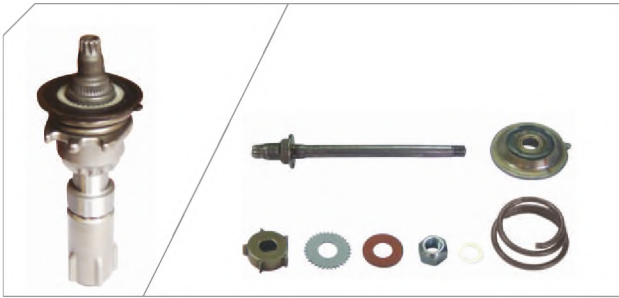

**Caliper Adjusting Mechanism Repair Kit**

Kaliper Ayar Mekanizması Tamir Takımı

SEM Kit No **10700**

Org. Kit Ref. No --

Application SN 5..., SB 6..., SB 7..., SN 6..., SN 7..., SK... Series



**Caliper Adjusting Mechanism Repair Kit**

Kaliper Ayar Mekanizması Tamir Takımı

SEM Kit No **10701**

Org. Kit Ref. No --

Application All SB 6..., SB 7..., SN 6..., SN 7... Series



**Caliper Adjusting Mechanism Repair Kit**

Kaliper Ayar Mekanizması Tamir Takımı

SEM Kit No **12242**

Org. Kit Ref. No --

Application SB 6..., SB 7..., SN 6..., SN 7... SK... Series



**Caliper Adjusting Mechanism Repair Kit**

Kaliper Ayar Mekanizması Tamir Takımı

SEM Kit No **12266**

Org. Kit Ref. No

Application SK 6..., SK 7... Series



**Caliper Chain (28 links)**

Kaliper Zinciri (28 bakla)

SEM Kit No **10702**

Org. Kit Ref. No --

Application All SB 6..., SB 7..., SN 6..., SN 7... Series

<b>Caliper Bridge Assembly</b> Kaliper Köprü Bağlantısı	
SEM Kit No	<b>10704</b>
Org. Kit Ref. No	--
Application	SB 6..., SB 7..., SN 6..., SN 7... SK... Series

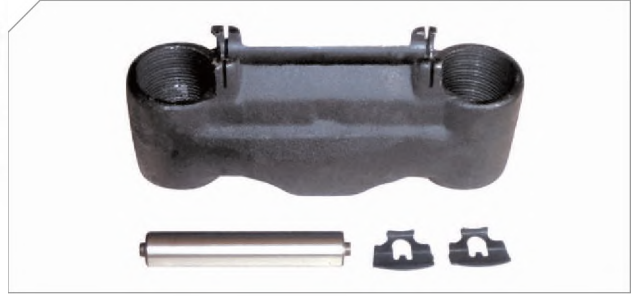

<b>Caliper Bridge Assembly</b> Kaliper Köprü Bağlantısı	
SEM Kit No	<b>10705</b>
Org. Kit Ref. No	--
Application	SB 6..., SB 7..., SN 6..., SN 7... SK... Series



<b>Caliper Bridge Assembly</b> Kaliper Köprü Bağlantısı	
SEM Kit No	<b>10706</b>
Org. Kit Ref. No	--
Application	SB 6..., SB 7..., SN 6..., SN 7... SK... Series

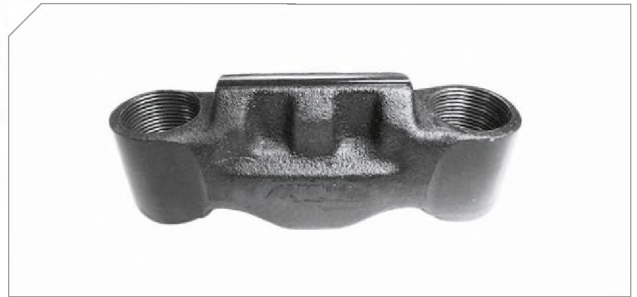

<b>Caliper Bridge Assembly-Pistons</b> Kaliper Köprü Bağlantısı-Ayar Civatası	
SEM Kit No	<b>12243</b>
Org. Kit Ref. No	--
Application	SB 6..., SB 7..., SN 6..., SN 7... SK... Series



<b>Caliper Bridge Assembly-Pistons</b> Kaliper Köprü Bağlantısı-Ayar Civatası	
SEM Kit No	<b>12244</b>
Org. Kit Ref. No	--
Application	SB 6..., SB 7..., SN 6..., SN 7... SK... Series



<b>Caliper Bridge Assembly-Pistons</b> Kaliper Köprü Bağlantısı-Ayar Civatası	
SEM Kit No	<b>12245</b>
Org. Kit Ref. No	--
Application	SB 6..., SB 7..., SN 6..., SN 7... SK... Series





**Caliper Bridge Assembly-Pistons**

Kaliper Kopru Baglantısı-Ayar Civatası

SEM Kit No **12267**

Org. Kit Ref. No --

Application SL 7..., SM 7...



**Caliper Roller Bearing**

Kaliper Rulmanları

SEM Kit No **10708**

Org. Kit Ref. No --

Application All SB 5..., SB 65..., SB 71..., SB 75..., SB 76..., SB 77..., SB 78..., SB 79...  
SN 5... Series



**Caliper Roller Bearing**

Kaliper Rulmanları

SEM Kit No **10709**

Org. Kit Ref. No --

Application All SB 5..., SB 65..., SB 71..., SB 75..., SB 76..., SB 77..., SB 78..., SB 79...  
SN 5... Series



**Caliper Roller Bearing**

Kaliper Rulmanları

SEM Kit No **12268**

Org. Kit Ref. No --

Application SL 7..., SM 7...



**Caliper Calibration Bolt**

Kaliper Ayar Civatası

SEM Kit No **10711**

Org. Kit Ref. No

Application All SB 5 ..., SB 6..., SB 7...  
All SN 6..., SN 7...



**Caliper Calibration Bolt**

Kaliper Ayar Civatası

SEM Kit No **12269**

Org. Kit Ref. No

Application SL 7..., SM 7...

SEM Kod No	Sensor /Sensör	Vehicle /Araç
10712	Caliper Sensor Cover Kaliper Sensör Kapağı (Without Sensor) (Sensörsüz)	MERCEDES (ACTROS, ATEGO, AXOR) MAN TGA
	Caliper Sensor Cover Kaliper Sensör Kapağı (2 Cable Sensor) (2 Kablolu Sensör)	MERCEDES ATEGO, AXOR, MAN
	Caliper Sensor Cover Kaliper Sensör Kapağı (3 Cable Sensor) (3 Kablolu Sensör)	MERCEDES ACTROS
	Caliper Sensor Cover Kaliper Sensör Kapağı (MAN Type 3 Cable Sensor) (MAN Tipi 3 Kablolu Sensör)	MAN TGA



Caliper Sensor Cover (Aluminium)	
Kaliper Sensör Kapağı (Alüminyum)	
SEM Kit No	12246
Org. Kit Ref. No	--
Application	--



SEM Kod No	Sensor /Sensör	Vehicle /Araç
10714	Caliper Sensor Cover Kaliper Sensör Kapağı (Without Sensor) (Sensörsüz)	DAF, SCANIA, IVECO
--	Caliper Sensor Cover Kaliper Sensör Kapağı (2 Cable Sensor) (2 Kablolu Sensör)	DAF, SCANIA, IVECO
	Caliper Sensor Cover Kaliper Sensör Kapağı (3 Cable Sensor) (3 Kablolu Sensör)	DAF, SCANIA, IVECO



SEM Kod No	Sensor /Sensör	Vehicle /Araç
12270	Caliper Sensor Cover Kaliper Sensör Kapağı (Without Sensor) (Sensörsüz)	MERCEDES
--	Caliper Sensor Cover Kaliper Sensör Kapağı (2 Cable Sensor) (2 Kablolu Sensör)	MERCEDES
	Caliper Sensor Cover Kaliper Sensör Kapağı (3 Cable Sensor) (3 Kablolu Sensör)	MERCEDES, CAPACITY CITARO



SEM Kod No	Sensor /Sensör	Vehicle /Araç
12271	Caliper Sensor Cover Kaliper Sensör Kapağı (Without Sensor) (Sensörsüz)	
--	Caliper Sensor Cover Kaliper Sensör Kapağı (2 Cable Sensor) (2 Kablolu Sensör)	
	Caliper Sensor Cover Kaliper Sensör Kapağı (3 Cable Sensor) (3 Kablolu Sensör)	



SEM Kod No	OEM Ref No	Description	Length
	449 756 020 0	Sensor Cable with Connector Socket/ Bağlantı Soketli Sensör Kablosu	2,0 m
12197	449 756 020 0	Sensor Cable with Connector Socket/ Bağlantı Soketli Sensör Kablosu	3,5 m
	449 756 020 0	Sensor Cable with Connector Socket/ Bağlantı Soketli Sensör Kablosu	5,0 m
	449 756 020 0	Sensor Cable with Connector Socket/ Bağlantı Soketli Sensör Kablosu	8,0 m
	449 756 020 0	Sensor Cable with Connector Socket/ Bağlantı Soketli Sensör Kablosu	10,0 m
	449 756 020 0	Sensor Cable with Connector Socket/ Bağlantı Soketli Sensör Kablosu	12,0 m





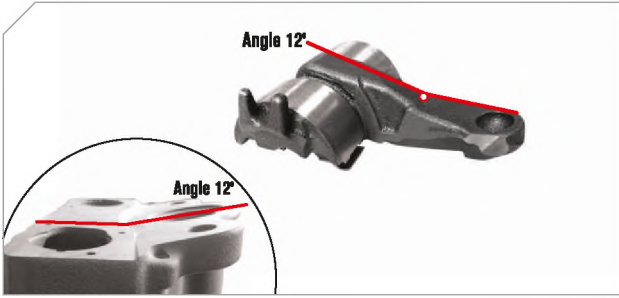

**Caliper Lever (Angle 12°)**  
Kaliper Masura Bilya Yatağı (Açı 12°)

SEM Kit No	<b>10716</b>
Org. Kit Ref. No	--
Application	SB 6..., SB 7..., SN 6..., SN 7... SK... Series

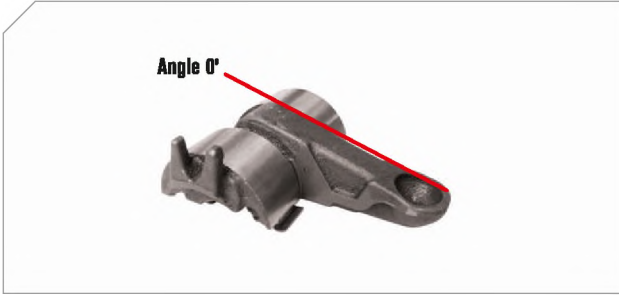

**Caliper Lever (Angle 0°)**  
Kaliper Masura Bilya Yatağı (Açı 0°)

SEM Kit No	<b>10717</b>
Org. Kit Ref. No	--
Application	SB 6..., SB 7..., SN 6..., SN 7... SK... Series

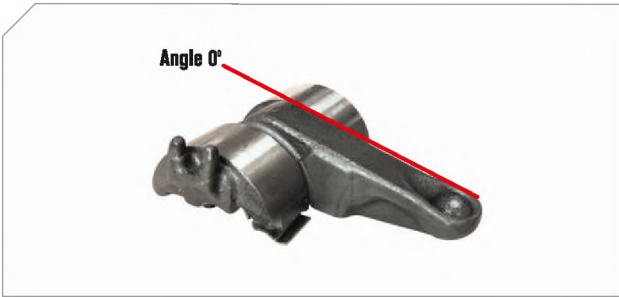

**Caliper Lever (Angle 0°)**  
Kaliper Masura Bilya Yatağı (Açı 0°)

SEM Kit No	<b>10718</b>
Org. Kit Ref. No	--
Application	SB 6..., SB 7..., SN 6..., SN 7... SK... Series

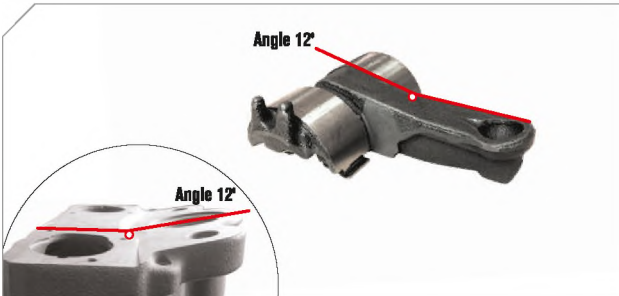

**Caliper Lever (Angle 12°)**  
Kaliper Masura Bilya Yatağı (Açı 12°)

SEM Kit No	<b>10719</b>
Org. Kit Ref. No	--
Application	SB 6..., SB 7..., SN 6..., SN 7... SK... Series



**Caliper Lever (Angle 0°)**  
Kaliper Masura Bilya Yatağı (Açı 0°)

SEM Kit No	<b>12247</b>
Org. Kit Ref. No	--
Application	SB 6..., SB 7..., SN 6..., SN 7... SK... Series SN 6507, SN 6373

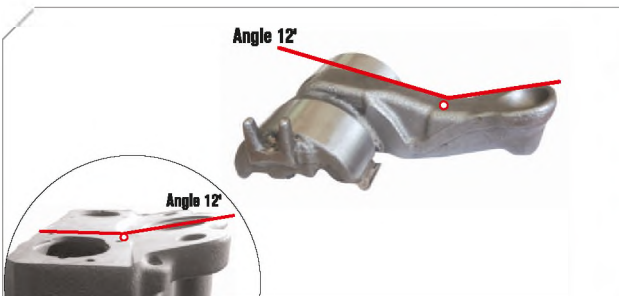

**Caliper Lever (Angle 12°)**  
Kaliper Masura Bilya Yatağı (Açı 12°)

SEM Kit No	<b>12198</b>
Org. Kit Ref. No	--
Application	--

<b>Caliper Lever (Angle 0°)</b> Kaliper Masura Bilya Yatağı (Açı 0°)	
SEM Kit No	<b>12199</b>
Org. Kit Ref. No	--
Application	--

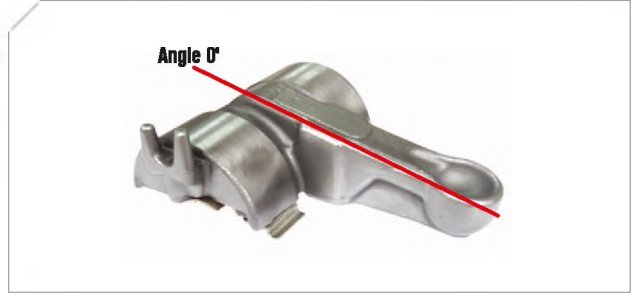

<b>Caliper Lever</b> Kaliper Masura Bilya Yatağı	
SEM Kit No	<b>12248</b>
Org. Kit Ref. No	--
Application	--



<b>Caliper Lever (Angle 12°)</b> Kaliper Masura Bilya Yatağı (Açı 12°)	
SEM Kit No	<b>12249</b>
Org. Kit Ref. No	
Application	--

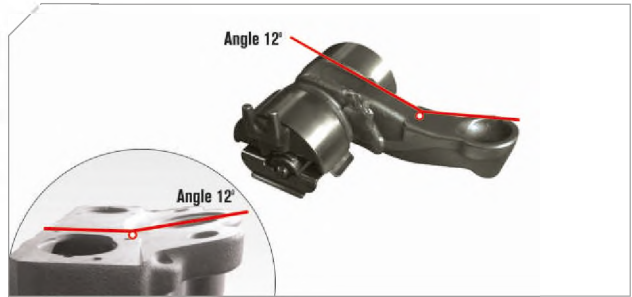

<b>Caliper Lever (Angle 12°)</b> Kaliper Masura Bilya Yatağı (Açı 12°)	
SEM Kit No	<b>12272</b>
Org. Kit Ref. No	
Application	SN 7107, SN 7117, SN 7213, SN 7203, BENDIX ADB22X, DAF-LEYLAND

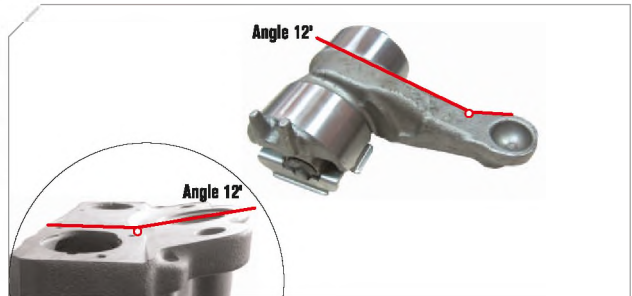

<b>Caliper Lever</b> Kaliper Masura Bilya Yatağı	
SEM Kit No	<b>12250</b>
Org. Kit Ref. No	--
Application	



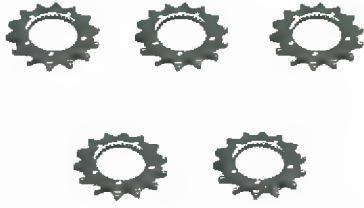

**Caliper Gear Wheel Adjusting Mechanism**

Kaliper Ayar Dişlisi

SEM Kit No **12202**

Org. Kit Ref. No --

Application All SB..., SN... Series



**Caliper Lever Bearing**

Kaliper Masura Yatağı

SEM Kit No **12252**

Org. Kit Ref. No --

Application All SB 6..., SB 7..., SN 6..., SN 7... Series



**Caliper Cover**

Kaliper Kapağı

SEM Kit No **12273**

Org. Kit Ref. No --

Application All SN 6..., SN 7... Series



**Caliper Cover**

Kaliper Kapağı

SEM Kit No **12274**

Org. Kit Ref. No --

Application All SN 6..., SN 7... Series



**Plastic Shaft**

Plastik Şaft

SEM Kit No **12206**

Org. Kit Ref. No --

Application --



**Plastic Shaft**

Plastik Şaft

SEM Kit No **12207**

Org. Kit Ref. No --

Application --

<b>Plastic Shaft</b> Plastik Şaft	
SEM Kit No	<b>12208</b>
Org. Kit Ref. No	
Application	--

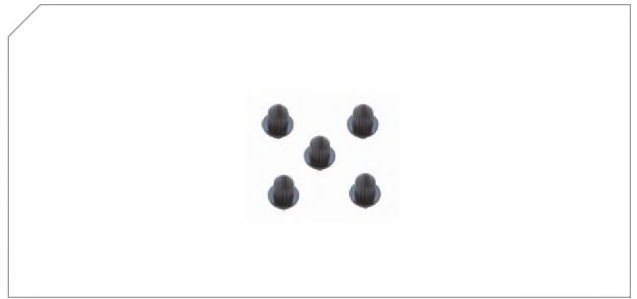

<b>Plastic Shaft</b> Plastik Şaft	
SEM Kit No	<b>12275</b>
Org. Kit Ref. No	--
Application	SK 6..., SK 7... Series

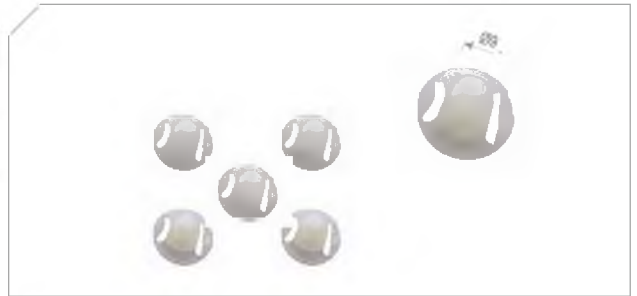

<b>Caliper Caps</b> Kaliper Kapları	
SEM Kit No	<b>12276</b>
Org. Kit Ref. No	--
Application	All SB 6..., SB 7..., SN 6..., SN 7... Series



<b>Caliper Caps</b> Kaliper Kapları	
SEM Kit No	<b>XXXXXX</b>
Org. Kit Ref. No	--
Application	All SB 6..., SB 7..., SN 6..., SN 7... Series



<b>Complete Caliper Repair Kit</b> Kaliper Komple Tamir Takımı	
SEM Kit No	<b>12277</b>
Org. Kit Ref. No	K052390K51 / K052380K51 • MERCEDES Ref.no: A004 420 71 83 / 75 83
Application	SL 7..., SM 7... Series



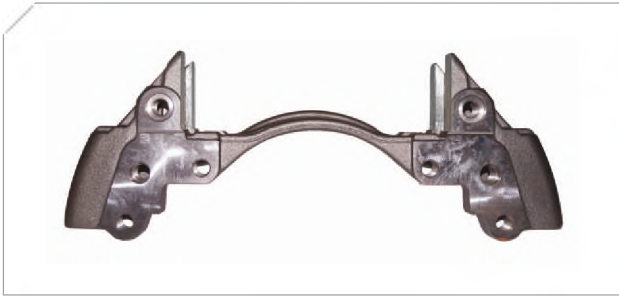

**Caliper Carrier 22,5"**

Kaliper Semer 22,5"

SEM Kit No **12278**

Org. Kit Ref. No K 000027 MERCEDES ACTROS, AXOR Ref.no: 000 423 0606

Application MERCEDES ACTROS, AXOR



**Caliper Carrier 22,5" (Front)**

Kaliper Semer 22,5" (On)

SEM Kit No **12279**

Org. Kit Ref. No K 000026

Application MERCEDES AXOR



**Caliper Carrier 22,5" (Front-Rear)**

Kaliper Semer 22,5" (On-Arka)

SEM Kit No **12280**

Org. Kit Ref. No K 001278

Application MAN TGA ZF-AXLE

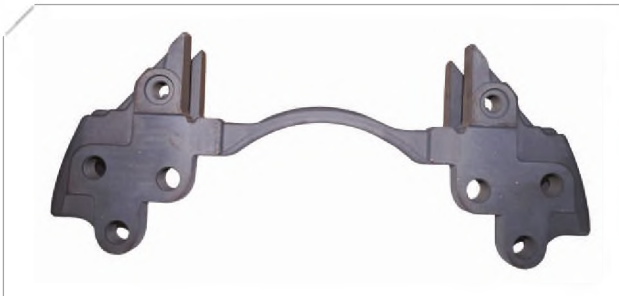

**Caliper Carrier 22,5"**

Kaliper Semer 22,5"

SEM Kit No **12281**

Org. Kit Ref. No K 001510

Application IVECO



**Caliper Carrier 22,5"**

Kaliper Semer 22,5"

SEM Kit No **12282**

Org. Kit Ref. No K 11479

Application DAF



**Caliper Carrier 22,5"**

Kaliper Semer 22,5"

SEM Kit No **12283**

Org. Kit Ref. No K 010765

Application SB 7..., SN 7..., SCANIA

<b>Caliper Carrier 19,5"</b> Kaliper Semeer 19,5"	
<b>SEM Kit No</b>	<b>12284</b>
<b>Org. Kit Ref. No</b>	K 001926 • MERCEDES ATEGO Ref.no: 000 421 3106
<b>Application</b>	SN 6..., SN 7...,





**B / C DUCO**  
**D DUCO AXIAL / RADIAL**  
**LE DUCO**  
Type Caliper Repair Kits

### B DUCO Type Caliper



### C DUCO Type Caliper



### LE DUCO Type Caliper



## D DUCO AXIAL Type Caliper



## D DUCO RADIAL Type Caliper



<b>DUCO SERIES CALIPERS</b> RG 536/537/552/553/560/561/578/579/596/597/598/599/648/649/650/561/652/653		<b>AXLE // AKS</b>		<b>SEM REPAIR KITS/ /SEM Tamir Takımları</b>		
<b>Vehicles // Araçlar</b>	<b>Models // Modeller</b>	<b>Left // Sol</b>	<b>Right // Sağ</b>			
<b>ROR</b>	LM, TA SERIES	LRG578	LRG579	10746		
<b>VOLVO</b>	FL6 H Midium	LRG648	LRG649	10747		
	FL6 L Midium (01+)	LRG552	LRG553	12285		
	Europa FL (01+) Truck	LRG561	LRG560	10748		
	FM9 TBRA, P, PA	LRG561	LRG560	10749		
	FH12 (01+)	LRG536	LRG537	10750		
	FL6 E Midium 4x2 (-06.00) Front Axle			10751		
	Europe FL (Front)	LRG648	LRG649	12294		
	FL6 E Midium 4x2 (07.00 to 09.01)	LRG596	LRG597	12295		
	FH12 (Generation 2-3-4)	LRG598 LRG536	LRG599 LRG537	12296		
	FH16 (Generation 2-3-4)			12297		
	FM12 (Genaration 2-3-4)			10755		
	FM7 (Genaration 2-3-4)			12303		
	FM9 (FAA 10)			12306		
	FL6 BLF (-06.00) B			LRG536	LRG537	12309
	FL6 E (07.01+)			LRG598	LRG599	12311
	FM 12 (Generation 2-3-4)			LRG598 LRG596	LRG599 LRG597	12313
	FH 12 (Generation 2-3-4)					12314
	FM 16 (Generation 2-3-4)					10735
	FH 16 (Generation 2-3-4)	10736				
	FM 10 (Generation 2-3-4)					
FM 12 (Generation 2-3-4)						
FM 7 (Generation 2-3-4)						
FM9 (FAA 20) Front	LRG596	LRG597				





**Caliper Guides & Seals Repair Kit**

Kaliper Mil & Keçe Tamir Takımı

SEM Kit No **10746**

Org. Kit Ref. No MCK 1118 • VOLVO Ref.no: 85102092

Application LRG 598/599

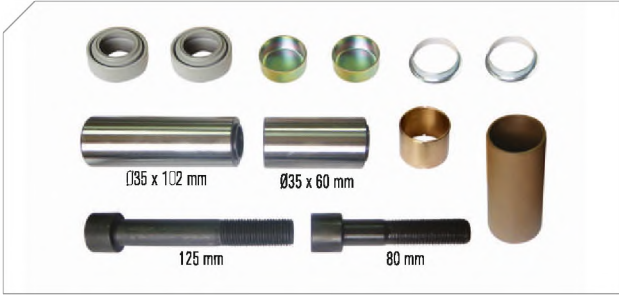

**Caliper Guides & Seals Repair Kit**

Kaliper Mil & Keçe Tamir Takımı

SEM Kit No **10747**

Org. Kit Ref. No MCK 1116 • VOLVO Ref.no: 85102094

Application LRG 536, 537, 552, 553, 560, 561, 578, 579, 596, 597, 648, 649, 650, 651, 652, 653



**Caliper Guides & Dust Cover Repair Kit**

Kaliper Mil & Toz Kapağı Tamir Takımı

SEM Kit No **12285**

Org. Kit Ref. No --

Application --



**Caliper Tappet Dust Cover**

Kaliper Toz Lastiği

SEM Kit No **10748**

Org. Kit Ref. No 68324854PK10 / MCK 1139 • MAN Ref.no: 81.50802.6024

Application All LRG Series



**Caliper Tappet Head Repair Kit**

Kaliper Toz Lastiği Komple Tamir Takımı

SEM Kit No **10749**

Org. Kit Ref. No MCK 1238 • VOLVO Ref.no: 3092264 / 85107718

Application LRG 536, 537, 552, 553, 560, 561, 578, 579, 596, 597, 598, 599, 648, 649, 650, 651, 652, 653



**Caliper Guides & Dust Cover Repair Kit**

Kaliper Mil & Toz Kapağı Tamir Takımı

SEM Kit No **12286**

Org. Kit Ref. No MCK 1134 / SJ 4094

Application LRG 536, 537, 552, 553, 560, 561, 578, 579, 596, 597, 598, 599, 648, 649, 650, 651, 652, 653

<b>Caliper Guides &amp; Dust Cover Repair Kit</b> Kaliper Mil & Toz Kapağı Tamir Takımı	
SEM Kit No	<b>12287</b>
Org. Kit Ref. No	MCK 1135
Application	LRG 598/599



<b>Caliper Guides &amp; Dust Cover Repair Kit</b> Kaliper Mil & Toz Kapağı Tamir Takımı	
SEM Kit No	<b>12288</b>
Org. Kit Ref. No	MCK 1299 / MCK 1066 / 85107718 • VOLVO Ref.no: 3095628
Application	LRG 536, 537, 552, 553, 560, 561, 578, 579, 596, 597, 598, 599, 648, 649, 650, 651, 652, 653



<b>Caliper Guides &amp; Seals Repair Kit</b> Kaliper Mil & Keçe Tamir Takımı	
SEM Kit No	<b>12289</b>
Org. Kit Ref. No	--
Application	LRG 578/579



<b>Caliper Tappet Dust Cover</b> Kaliper Toz Lastiği	
SEM Kit No	<b>12290</b>
Org. Kit Ref. No	--
Application	All LRG Series



<b>Caliper Adjusting Tappet Repair Kit (Left)</b> Kaliper Ayar Mekanizması Tamir Takımı (Sol)	
SEM Kit No	<b>10750</b>
Org. Kit Ref. No	MCK 1236 • VOLVO Ref.no: 3092262
Application	LRG 536, 560, 578, 597, 648, 650, 652



<b>Caliper Adjusting Tappet Repair Kit (Right)</b> Kaliper Ayar Mekanizması Tamir Takımı (Sağ)	
SEM Kit No	<b>10751</b>
Org. Kit Ref. No	MCK 1237 / MCK 1239 • VOLVO Ref.no: 3092263
Application	LRG 537, 561, 579, 596, 649, 651, 653







**Caliper Adjusting Tappet Repair Kit (Left) - Half Kit**  
Kaliper Ayar Mekanizması Tamir Takımı (Sol) - Yarım Takım

SEM Kit No	<b>12291</b>
Org. Kit Ref. No	
Application	LRG 536, 560, 578, 597, 648, 650, 652



**Caliper Adjusting Tappet Repair Kit (Right) - Half Kit**  
Kaliper Ayar Mekanizması Tamir Takımı (Sağ) - Yarım Takım

SEM Kit No	<b>12292</b>
Org. Kit Ref. No	
Application	LRG 537, 561, 579, 596, 649, 651, 653



**Caliper Adjusting Mechanism (Rear-Left)**  
Kaliper Ayar Mekanizması (Arka-Sol)

SEM Kit No	<b>10752</b>
Org. Kit Ref. No	MCK 1111 / SJ 4102 • VOLVO Ref.no: 85102095 / 3092265
Application	LRG 536, 560, 578, 597, 648, 650, 652



**Caliper Adjusting Mechanism (Rear-Right)**  
Kaliper Ayar Mekanizması (Arka-Sağ)

SEM Kit No	<b>10753</b>
Org. Kit Ref. No	MCK 1112 / SJ 4103 / SJ 4110 • VOLVO Ref.no: 85102096 / 3092266
Application	LRG 537, 561, 562, 563, 579, 596, 598, 599, 649, 651



**Caliper Adjusting Mechanism (Front)**  
Kaliper Ayar Mekanizması (Ön)

SEM Kit No	<b>10754</b>
Org. Kit Ref. No	MCK 1113 • VOLVO Ref.no: 85102093
Application	LRG 598, 599



**Caliper Adjusting Mechanism**  
Kaliper Ayar Mekanizması

SEM Kit No	<b>12293</b>
Org. Kit Ref. No	MCK 1050
Application	--

<b>Caliper Gear (Left)</b> Kaliper Dişlisi (Sol)	
SEM Kit No	12294
Org. Kit Ref. No	
Application	LRG 536, 560, 578, 597, 648, 650, 652



<b>Caliper Gear (Right)</b> Kaliper Dişlisi (Sağ)	
SEM Kit No	12295
Org. Kit Ref. No	
Application	LRG 537, 561, 579, 596, 649, 651, 653



<b>Caliper Bolt (Left)</b> Kaliper Civatası (Sol)	
SEM Kit No	12296
Org. Kit Ref. No	--
Application	LRG 536, 560, 578, 597, 648, 650, 652



<b>Caliper Bolt (Right)</b> Kaliper Civatası (Sağ)	
SEM Kit No	12297
Org. Kit Ref. No	--
Application	LRG 537, 561, 579, 596, 649, 651, 653



<b>Caliper Lever, Seal &amp; Bearings</b> Kaliper Masura Bilya Yatağı, Keçe & Rulmanları	
SEM Kit No	10755
Org. Kit Ref. No	SJ 4108
Application	LRG 598, 599



<b>Caliper Lever (Right)</b> Kaliper Masura Bilya Yatağı (Sağ)	
SEM Kit No	10756
Org. Kit Ref. No	SJ 4096
Application	LRG 578, 579





**Caliper Lever (Left)**  
Kaliper Masura Bilya Yatađı (Sol)

SEM Kit No	<b>10757</b>
Org. Kit Ref. No	SJ 4097
Application	LRG 578, 579



**Caliper Lever (Right)**  
Kaliper Masura Bilya Yatađı (Sađ)

SEM Kit No	<b>12298</b>
Org. Kit Ref. No	
Application	C DUCO, LE DUCO



**Caliper Lever (Left)**  
Kaliper Masura Bilya Yatađı (Sol)

SEM Kit No	<b>12299</b>
Org. Kit Ref. No	-
Application	C DUCO, LE DUCO



**Caliper Lever (Left)**  
Kaliper Masura Bilya Yatađı (Sol)

SEM Kit No	<b>12300</b>
Org. Kit Ref. No	MCK 1127
Application	LRG 537, 561, 579, 596, 649, 651, 653



**Caliper Lever (Right)**  
Kaliper Masura Bilya Yatađı (Sađ)

SEM Kit No	<b>12301</b>
Org. Kit Ref. No	MCK 1128
Application	LRG 598, 599

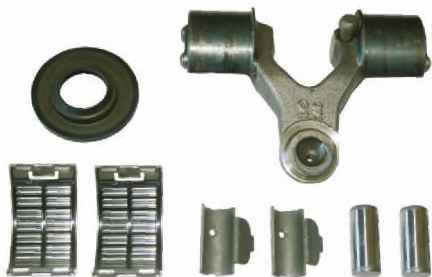

**Caliper Lever**  
Kaliper Masura Bilya Yatađı

SEM Kit No	<b>12302</b>
Org. Kit Ref. No	MCK 1048
Application	LRG 578, 579

<b>Caliper Gear &amp; Springs Kit</b> Kaliper Merkez Dişlisi & Yayları Takımı	
SEM Kit No	<b>12303</b>
Org. Kit Ref. No	MCK 1129
Application	LRG 648, 649, 650, 651

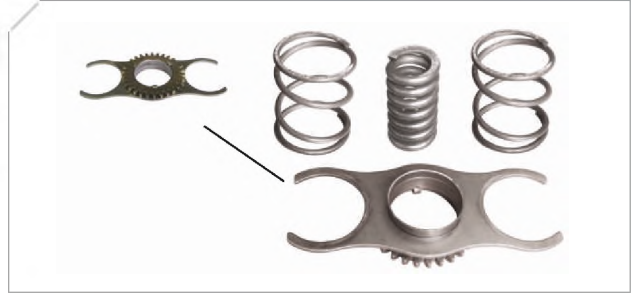

<b>Caliper Gear &amp; Springs Kit</b> Kaliper Merkez Dişlisi & Yayları Takımı	
SEM Kit No	<b>12304</b>
Org. Kit Ref. No	
Application	LE DUCO



<b>Caliper Gear &amp; Springs Kit</b> Kaliper Merkez Dişlisi & Yayları Takımı	
SEM Kit No	<b>12305</b>
Org. Kit Ref. No	MCK 1067 • VOLVO Ref.no:Y 3095626
Application	D DUCO



<b>Caliper Visual Pad Wear Assembly</b> Kaliper Fren Pabucu Seviye Gösterge Çubuğu	
SEM Kit No	<b>12306</b>
Org. Kit Ref. No	SJ 4111
Application	LRG 536, 537, 552, 553, 560, 561, 578, 579, 596, 597, 598, 599 648, 649, 650, 651, 652, 653



<b>Small Gear Mechanism (Right)</b> Küçük Ayar Mekanizması (Sağ)	
SEM Kit No	<b>12307</b>
Org. Kit Ref. No	68322563PK4
Application	LRG 536, 542, 586, 588, 597, 648, 650, 652, 704



<b>Small Gear Mechanism (Left)</b> Küçük Ayar Mekanizması (Sol)	
SEM Kit No	<b>12308</b>
Org. Kit Ref. No	68322562PK4
Application	LRG 537, 543, 560, 587, 589, 596, 598, 599, 649, 651, 653, 705







**Caliper Tappet Anti Rotation Plate**

Kaliper Sabitleme Sacı

SEM Kit No **12309**

Org. Kit Ref. No MCK 68322900PK10

Application LRG 536, 537, 578, 579, 596, 597, 598, 599, 652, 653



**Caliper Pad Retainer Repair Kit**

Kaliper İpat Tutucu Tamir Takımı

SEM Kit No **12310**

Org. Kit Ref. No MCK 1263

Application LRG 552, 553



**Caliper Adjuster Dust Boot**

Kaliper Ayar Mekanizması Toz Lastiği

SEM Kit No **12311**

Org. Kit Ref. No --

Application All LRG Series



**Caliper Adjuster Dust Boot**

Kaliper Ayar Mekanizması Toz Lastiği

SEM Kit No **12312**

Org. Kit Ref. No 68322655PK10

Application All LRG Series



**Caliper Cover Plate Gasket**

Kaliper Kapak Contası

SEM Kit No **12313**

Org. Kit Ref. No --

Application LRG 598, 599

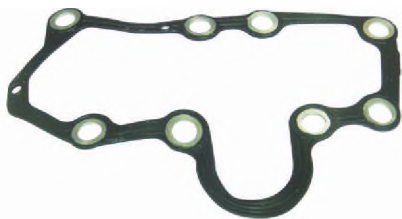

**Caliper Cover Plate Gasket**

Kaliper Kapak Contası

SEM Kit No **12314**

Org. Kit Ref. No 68322774PK4

Application LRG 536, 537, 578, 579, 596, 597, 652, 653

<b>Caliper Cover Plate Gasket</b> Kaliper Kapak Contası	
SEM Kit No	<b>12315</b>
Org. Kit Ref. No	
Application	LRG 560, 561, 648, 649, 650, 651



<b>Caliper Cover Plate Gasket</b> Kaliper Kapak Contası	
SEM Kit No	<b>10758</b>
Org. Kit Ref. No	SJ 4109 • VOLVO Ref.no: 3092270
Application	LRG 598, 599



<b>Caliper Cover Plate Gasket</b> Kaliper Kapak Contası	
SEM Kit No	<b>10759</b>
Org. Kit Ref. No	SJ 4105 VOLVO Ref.no: 3095669
Application	LRG 536, 537, 578, 579, 596, 597, 652, 653

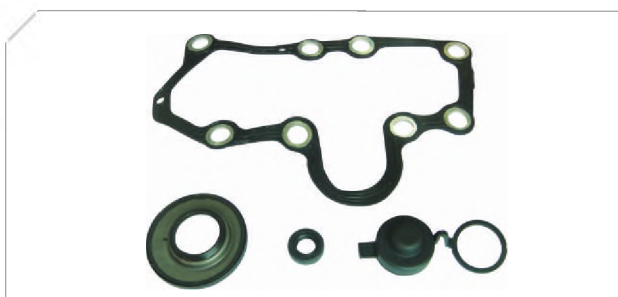

<b>Caliper Cover Plate Gasket</b> Kaliper Kapak Contası	
SEM Kit No	<b>10760</b>
Org. Kit Ref. No	MCK 1041 • VOLVO Ref.no: 3092269
Application	LRG 560, 561, 648, 649, 650, 651



<b>Caliper Bearings</b> Kaliper Rulmanları	
SEM Kit No	<b>10736</b>
Org. Kit Ref. No	--
Application	All LRG Series



<b>Caliper Bearing Repair Kit</b> Kaliper Rulman Tamir Takımı	
SEM Kit No	<b>10737</b>
Org. Kit Ref. No	SJ 4098 VOLVO Ref.no: 3092329
Application	All LRG Series





**Caliper Carrier**

Kaliper Taşıyıcı

SEM Kit No **12316**

Org. Kit Ref. No --

Application DUCO



**DX 175**

**DX 195**

**DX 225**

Type Caliper Repair Kits



## DX 175, DX 195, DX 225 Type Caliper

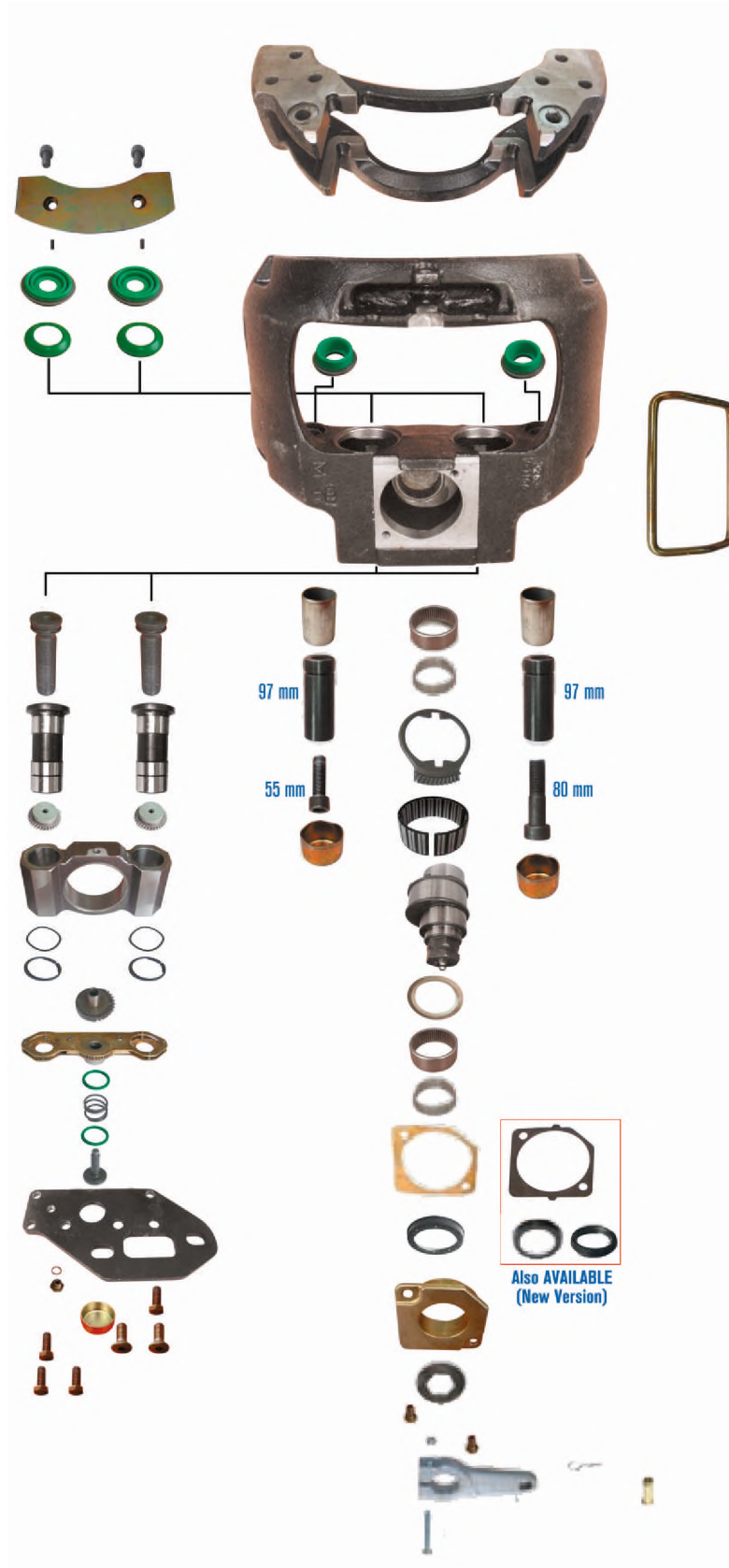

<b>DX 195 SERIES CALIPERS</b> DX195.51 / DX195.52		<b>AXLE // AKS</b>		<b>SEM REPAIR KITS/ /SEM Tamir Takımları</b>
<b>Vehicles // Araçlar</b>	<b>Models // Modeller</b>	<b>Left // Sol</b>	<b>Right // Sağ</b>	
<b>ROR</b>	<b>Axle (Trailer) 19.5" Wheel</b>	<b>DX.195.51</b>	<b>DX.195.52</b>	12317 12356 12357

<b>Caliper Boots, Caps &amp; Bolts Repair Kit</b> Kaliper Korumak & Civata Tamir Takımı	
<b>SEM Kit No</b>	<b>12317</b>
<b>Org. Kit Ref. No</b>	MCK 1192
<b>Application</b>	DX.195.51 / DX.195.52



<b>Caliper Boots &amp; Bolts Repair Kit</b> Kaliper Korumak & Civata Tamir Takımı	
<b>SEM Kit No</b>	<b>12318</b>
<b>Org. Kit Ref. No</b>	--
<b>Application</b>	DX.195.51 / DX.195.52

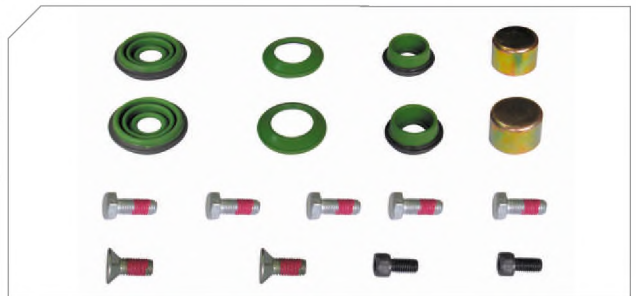

<b>Caliper Boots Repair Kit</b> Kaliper Korumak Tamir Takımı	
<b>SEM Kit No</b>	<b>12319</b>
<b>Org. Kit Ref. No</b>	--
<b>Application</b>	DX.195.51 / DX.195.52



<b>Caliper Boots Repair Kit</b> Kaliper Korumak Tamir Takımı	
<b>SEM Kit No</b>	<b>12320</b>
<b>Org. Kit Ref. No</b>	--
<b>Application</b>	DX.175



<b>Caliper Boots Repair Kit</b> Kaliper Korumak Tamir Takımı	
<b>SEM Kit No</b>	<b>12321</b>
<b>Org. Kit Ref. No</b>	--
<b>Application</b>	DX.225



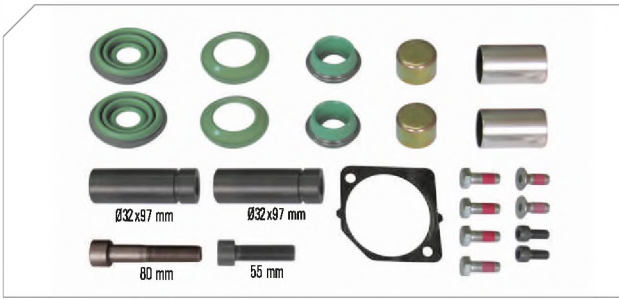

**Caliper Guides & Seals Repair Kit**

Kaliper Mil & Keçe Tamir Takımı

SEM Kit No **12322**

Org. Kit Ref. No

Application DX.195.51 / DX.195.52

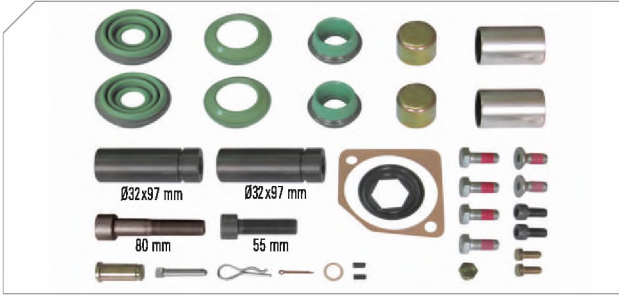

**Caliper Complete Overhaul Repair Kit**

Kaliper Komple Tamir Takımı

SEM Kit No **10721**

Org. Kit Ref. No MCK 1171

Application DX.195.51 / DX.195.52



**Caliper Guides & Seals Repair Kit**

Kaliper Mil & Keçe Tamir Takımı

SEM Kit No **12323**

Org. Kit Ref. No -

Application DX.175



**Caliper Guides & Seals Repair Kit**

Kaliper Mil & Keçe Tamir Takımı

SEM Kit No **12324**

Org. Kit Ref. No -

Application DX.225

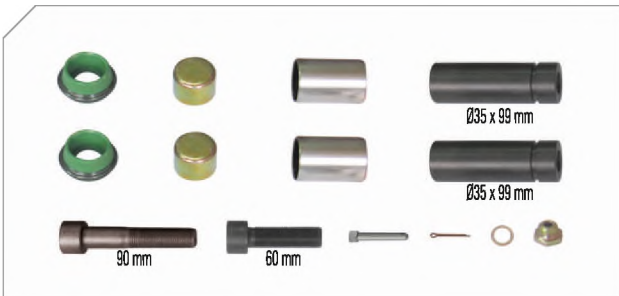

**Caliper Guides & Seals Repair Kit**

Kaliper Mil & Keçe Tamir Takımı

SEM Kit No **12325**

Org. Kit Ref. No DSB 7

Application DX.195



**Caliper Guides & Seals Repair Kit**

Kaliper Mil & Keçe Tamir Takımı

SEM Kit No **12326**

Org. Kit Ref. No MCK 1170

Application DX.225

<b>Caliper Guides &amp; Seals Repair Kit</b> Kaliper Mil & Keçe Tamir Takımı	
SEM Kit No	<b>12327</b>
Org. Kit Ref. No	MCK 1173
Application	DX.225



<b>Caliper Complete Overhaul Repair Kit</b> Kaliper Komple Tamir Takımı	
SEM Kit No	<b>12328</b>
Org. Kit Ref. No	MCK 1171/N
Application	DX.195



<b>Caliper Dust Boots &amp; Bolts Repair Kit</b> Kaliper Toz K�r�g� & Civata Tamir Takımı	
SEM Kit No	<b>12329</b>
Org. Kit Ref. No	MCK 1193
Application	DX.195

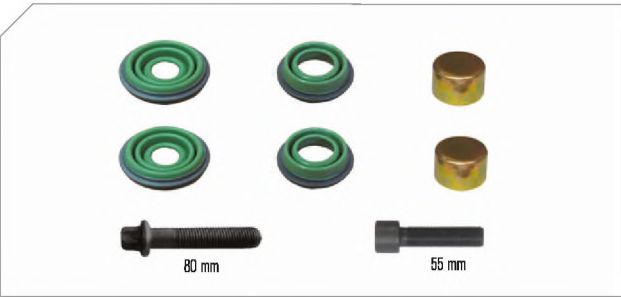

<b>Caliper Guides &amp; Seals Repair Kit</b> Kaliper Mil & Keçe Tamir Takımı	
SEM Kit No	<b>12330</b>
Org. Kit Ref. No	MCK 1172
Application	DX.225



<b>Caliper Dust Boots &amp; Bolts Repair Kit</b> Kaliper T&oz K�r�g� & Civata Tamir Takımı	
SEM Kit No	<b>12331</b>
Org. Kit Ref. No	MCK 1191
Application	DX.225



<b>Caliper Shaft</b> Kaliper Őaftı	
SEM Kit No	<b>10722</b>
Org. Kit Ref. No	--
Application	DX.195.51 / DX.195.52







**Caliper Shaft**

Kaliper Şaftı

SEM Kit No **12332**

Org. Kit Ref. No

Application DX.195.51 / DX.195.52



**Caliper Roller Bearings**

Kaliper Rulmanları

SEM Kit No **12333**

Org. Kit Ref. No --

Application DX.195.51 / DX.195.52



**Caliper Roller Bearings**

Kaliper Rulmanları

SEM Kit No **12334**

Org. Kit Ref. No --

Application DX.195.51 / DX.195.52



**Caliper Roller Bearings Kit**

Kaliper Rulmanları Takımı

SEM Kit No **10723**

Org. Kit Ref. No --

Application DX.195.51 / DX.195.52



**Caliper Shaft Fittings Repair Kit**

Kaliper Şaft Bağlantı Tamir Takımı

SEM Kit No **12335**

Org. Kit Ref. No --

Application DX.195.51 / DX.195.52



**Caliper Lever Kit**

Kaliper İtici Kol

SEM Kit No **12336**

Org. Kit Ref. No MCK 1160 / MCK 1175 / 21224954

Application DX.195.51 / DX.195.52

<b>Caliper Lever Kit</b> Kaliper İtici Kol	
SEM Kit No	<b>12337</b>
Org. Kit Ref. No	MCK 1161
Application	DX.195.51 / DX.195.52



<b>Caliper Lever Kit</b> Kaliper İtici Kol	
SEM Kit No	<b>12338</b>
Org. Kit Ref. No	MCK 1156
Application	DX175



<b>Caliper Lever Kit</b> Kaliper İtici Kol	
SEM Kit No	<b>12339</b>
Org. Kit Ref. No	MCK 1158
Application	DX195



<b>Caliper Lever Kit</b> Kaliper İtici Kol	
SEM Kit No	<b>12340</b>
Org. Kit Ref. No	MCK 1165
Application	DX225



<b>Caliper Lever Kit</b> Kaliper İtici Kol	
SEM Kit No	<b>12341</b>
Org. Kit Ref. No	MCK 1164
Application	DX225



<b>Caliper Bridge &amp; Tubes Repair Kit (Right)</b> Kaliper Köprü & Tüpleri Tamir Takımı (Sağ)	
SEM Kit No	<b>10724</b>
Org. Kit Ref. No	DSL6R
Application	DX.195.52





**Caliper Bridge & Tubes Repair Kit (Right)**

Kaliper Köprü & Tüpleri Tamir Takımı (Sağ)

SEM Kit No **10725**

Org. Kit Ref. No DSL6L

Application DX.195.51



**Caliper Push Plate Repair Kit (Right)**

Kaliper İtici Pleyt Tamir Takımı (Sağ)

SEM Kit No **10726**

Org. Kit Ref. No --

Application DX.195.52



**Caliper Push Plate Repair Kit (Left)**

Kaliper İtici Pleyt Tamir Takımı (Sol)

SEM Kit No **10727**

Org. Kit Ref. No --

Application DX.195.51



**Caliper Push Plate Repair Kit (Right)**

Kaliper İtici Pleyt Tamir Takımı (Sağ)

SEM Kit No **12342**

Org. Kit Ref. No --

Application DX.225



**Caliper Push Plate Repair Kit (Left)**

Kaliper İtici Pleyt Tamir Takımı (Sol)

SEM Kit No **12343**

Org. Kit Ref. No --

Application DX.225







**Caliper Adjusting Mechanism Minor Repair Kit (Right)**

Kaliper Ayar Mekanizması Yarım Tamir Takımı (Sağ)

SEM Kit No **12344**

Org. Kit Ref. No DSL5R

Application DX.195.52

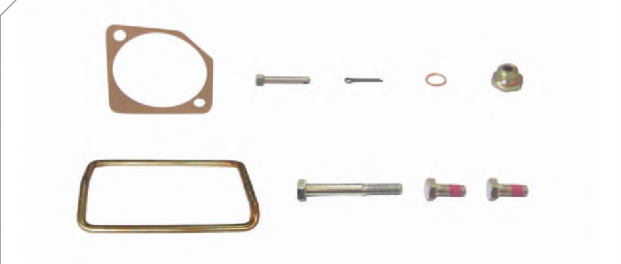
<p><b>Caliper Adjusting Mechanism Minor Repair Kit (Left)</b> Kaliper Ayar Mekanizması Yarım Tamir Takımı (Sol)</p> <p>SEM Kit No <b>12345</b></p> <p>Org. Kit Ref. No DSL5L</p> <p>Application DX.195.51</p>	
<p><b>Caliper Adjusting Mechanism Major Repair Kit (Right)</b> Kaliper Ayar Mekanizması Komple Tamir Takımı (Sağ)</p> <p>SEM Kit No <b>10728</b></p> <p>Org. Kit Ref. No MCK 1291</p> <p>Application DX.195.52</p>	
<p><b>Caliper Adjusting Mechanism Major Repair Kit (Left)</b> Kaliper Ayar Mekanizması Komple Tamir Takımı (Sol)</p> <p>SEM Kit No <b>10729</b></p> <p>Org. Kit Ref. No MCK 1290</p> <p>Application DX.195.51</p>	
<p><b>Caliper Shaft Fittings Repair Kit</b> Kaliper Şaft Bağlantı Tamir Takımı</p> <p>SEM Kit No <b>10730</b></p> <p>Org. Kit Ref. No --</p> <p>Application DX.195.51 / DX.195.52</p>	
<p><b>Caliper Shaft Fittings Repair Kit</b> Kaliper Şaft Bağlantı Tamir Takımı</p> <p>SEM Kit No <b>12346</b></p> <p>Org. Kit Ref. No MCK 1294 / MCK 1168 / MCK 1169</p> <p>Application DX.195.51 / DX.195.52</p>	
<p><b>Caliper Shaft Fittings Repair Kit</b> Kaliper Şaft Bağlantı Tamir Takımı</p> <p>SEM Kit No <b>12347</b></p> <p>Org. Kit Ref. No MCK 1153</p> <p>Application DX.175</p>	



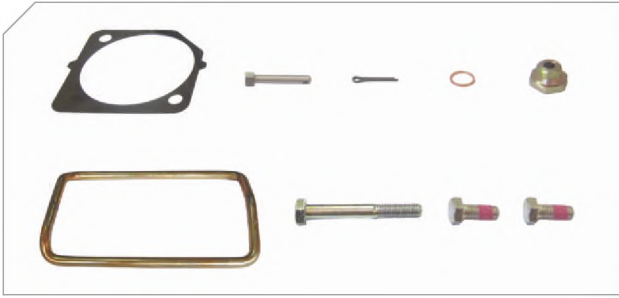

**Caliper Shaft Fittings Repair Kit**

Kaliper Şaft Bağlantı Tamir Takımı

SEM Kit No **12348**

Org. Kit Ref. No MCK 1154

Application DX.195

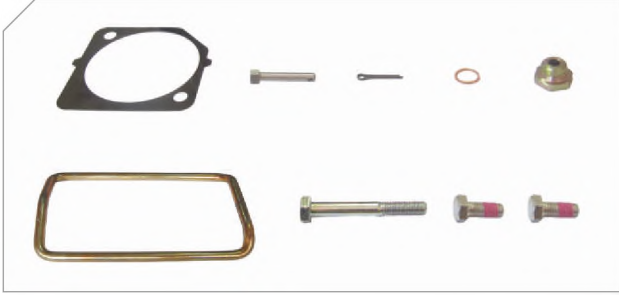

**Caliper Shaft Fittings Repair Kit**

Kaliper Şaft Bağlantı Tamir Takımı

SEM Kit No **12349**

Org. Kit Ref. No MCK 1155

Application DX.225



**Caliper Adjuster Sleeve & Thrust Plate Repair Kit (Right)**

Kaliper Ayar & Taşıyıcı Pleyt Tamir Takımı (Sağ)

SEM Kit No **10731**

Org. Kit Ref. No MCK 1293

Application DX.195.52



**Caliper Adjuster Sleeve & Thrust Plate Repair Kit (Left)**

Kaliper Ayar & Taşıyıcı Pleyt Tamir Takımı (Sol)

SEM Kit No **10732**

Org. Kit Ref. No MCK 1292

Application DX.195.51



**Caliper Bridge & Inner Bearing**

Kaliper Köprü & Yatakama Burcu

SEM Kit No **12350**

Org. Kit Ref. No --

Application DX.195.51 / DX.195.52



**Caliper Pistons & Pignons Repair Kit (Right)**

Kaliper Piston & Pinyon Tamir Takımı (Sağ)

SEM Kit No **12351**

Org. Kit Ref. No --

Application DX.195.52

<b>Caliper Pistons &amp; Pignons Repair Kit (Left)</b> Kaliper Piston & Pinyon Tamir Takımı (ol)	
SEM Kit No	<b>12352</b>
Org. Kit Ref. No	
Application	DX.195.51



<b>Caliper Pistons &amp; Pignons Repair Kit (Right)</b> Kaliper Piston & Pinyon Tamir Takımı (Sağ)	
SEM Kit No	<b>12353</b>
Org. Kit Ref. No	--
Application	DX.195.52



<b>Caliper Pistons &amp; Pignons Repair Kit (Left)</b> Kaliper Piston & Pinyon Tamir Takımı (ol)	
SEM Kit No	<b>12354</b>
Org. Kit Ref. No	--
Application	DX.195.51



<b>Caliper Central Fork &amp; Pignon</b> Kaliper Merkez Dişlisi & Pinyon	
SEM Kit No	<b>12355</b>
Org. Kit Ref. No	--
Application	DX.195.51 / DX.195.52



<b>Caliper Pad Retainer</b> Kaliper Balata Tutucu	
SEM Kit No	<b>12356</b>
Org. Kit Ref. No	--
Application	DX.195.51 / DX.195.52



<b>Caliper Pad Retainer</b> Kaliper Balata Tutucu	
SEM Kit No	<b>12357</b>
Org. Kit Ref. No	--
Application	DX.225

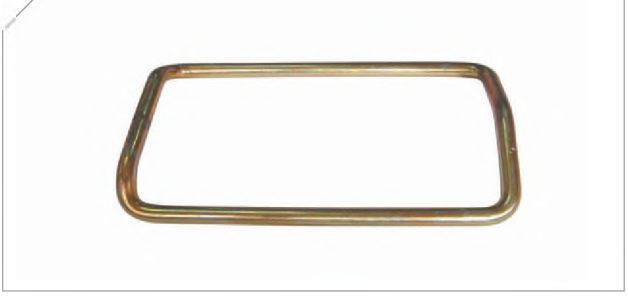





## **D3** Type Caliper Repair Kits

# D3 Type Caliper

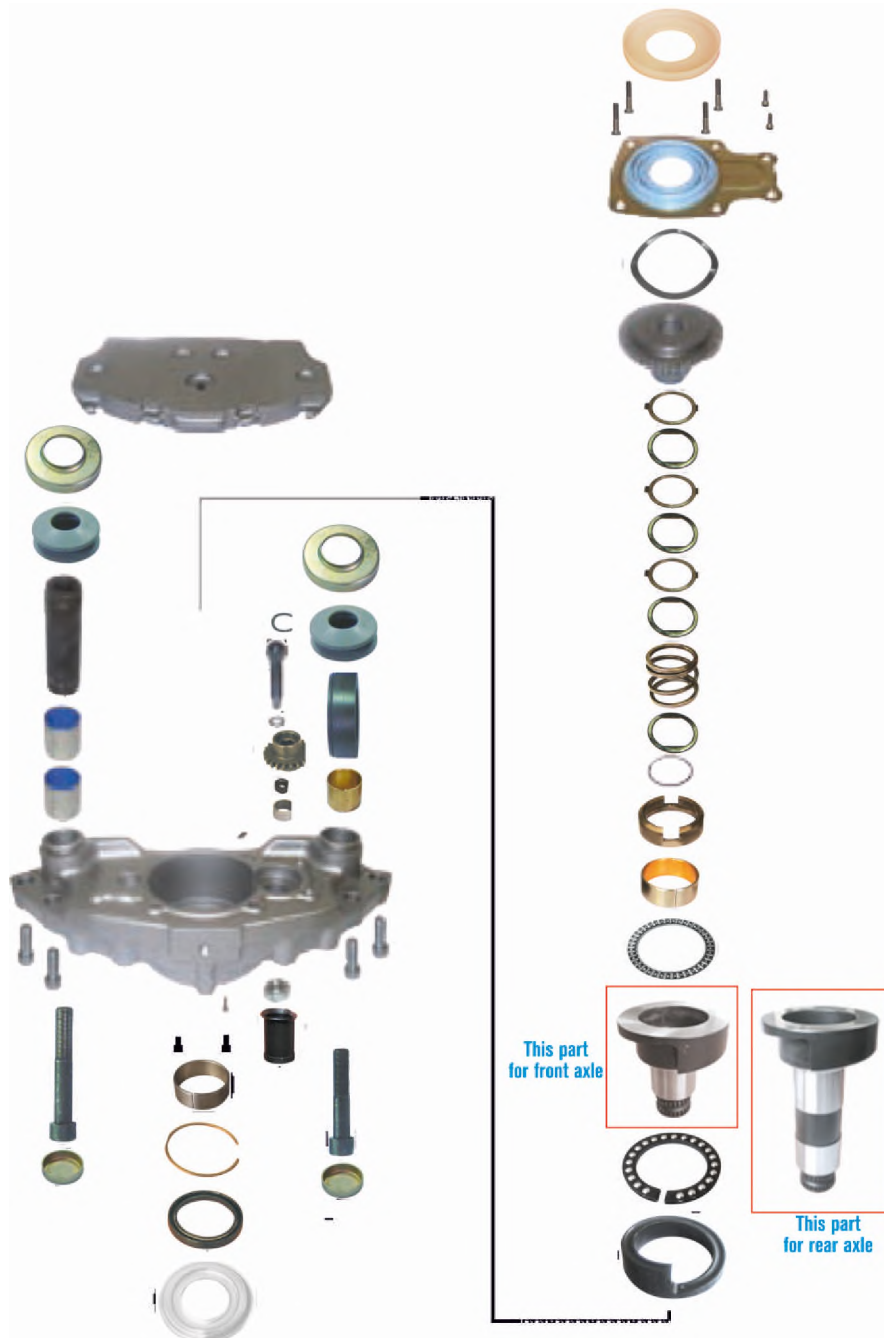

<b>D3 SERIES CALIPERS</b> LRG524/525/526/527/528/529/532/533/562/563/622/623		<b>AXLE // AKS</b>		<b>SEM REPAIR KITS/ /SEM Tamir Takımları</b>
<b>Vehicles // Araçlar</b>	<b>Models // Modeller</b>	<b>Left // Sol</b>	<b>Right // Sağ</b>	
<b>MERCEDES</b>	Omnibus (D350, D403, D404) Travego	LRG532 LRG622	LRG533 LRG623	12358 12376 12383 12387 12362 12377 12384 12388 12374 12378 12385 12389 12375 12379 12386 12390
<b>DENNIS</b>	Lance 2F Axle	LRG528	LRG529	12358 12374 12379 12387 12362 12375 12383 12388 12363 12376 12384 12389 12368 12377 12385 12390 12369 12378 12386
<b>KASSBOHRER</b>	S215HDH, S215NR, S300NC S315HD, Setra City Bus	LRG528	LRG529	
<b>MAN</b>	FRH422	LRG524	LRG525	
<b>MAN</b>	F2000 (94 to 96), F90 (93+)	LRG524	LRG525	12358 12374 12379 12387 12362 12375 12383 12388 12363 12376 12384 12389 12370 12377 12385 12390 12371 12378 12386
<b>RVI (RENAULT)</b>	MAGNUM AE (92 to 97) PREMIUM (96 to 97)	LRG526	LRG527	

<b>Caliper Guides &amp; Seals Repair Kit</b> Kaliper Mil & Keçe Tamir Takımı	
<b>SEM Kit No</b>	<b>12358</b>
<b>Org. Kit Ref. No</b>	SJ4011 / MCK 1213 / SJ 1228
<b>Application</b>	LRG 524, 525, 526, 527, 528, 529, 532, 533, 562, 563

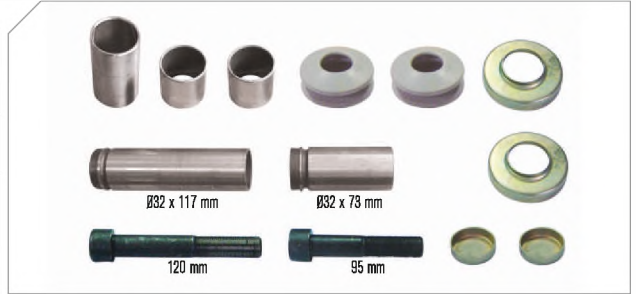

<b>Caliper Guides &amp; Seals Repair Kit</b> Kaliper Mil & Keçe Tamir Takımı	
<b>SEM Kit No</b>	<b>12359</b>
<b>Org. Kit Ref. No</b>	SJ 1213 • MERCEDES Ref.no: A000 420 0676
<b>Application</b>	LRG 532, 533, 622, 623

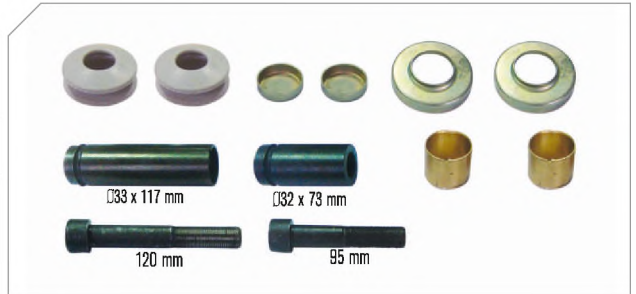

<b>Caliper Guides &amp; Seals Repair Kit</b> Kaliper Mil & Keçe Tamir Takımı	
<b>SEM Kit No</b>	<b>12360</b>
<b>Org. Kit Ref. No</b>	SJ 4001
<b>Application</b>	LRG 524, 525, 526, 527, 528, 529, 532, 533, 562, 563



<b>Caliper Tappet Cover Repair Kit</b> Kaliper Toz K�r�g� Tamir Takımı	
<b>SEM Kit No</b>	<b>12361</b>
<b>Org. Kit Ref. No</b>	--
<b>Application</b>	--







**Caliper Repair Kit Front (Left)**

Kaliper Tamir Takımı Ön (Sol)

SEM Kit No **12362**

Org. Kit Ref. No

Application LRG 524, 526



**Caliper Repair Kit Front (Right)**

Kaliper Tamir Takımı Ön (Sağ)

SEM Kit No **12363**

Org. Kit Ref. No --

Application LRG 525, 527



**Caliper Repair Kit Rear (Left)**

Kaliper Tamir Takımı Arka (Sol)

SEM Kit No **12364**

Org. Kit Ref. No --

Application LRG 622

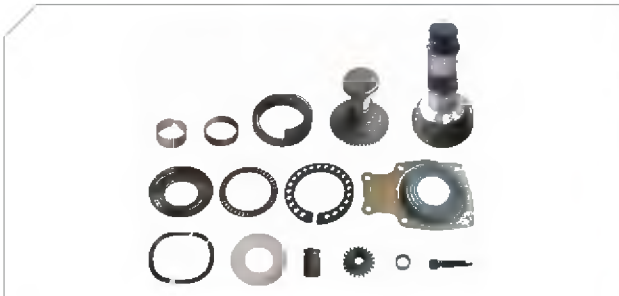

**Caliper Repair Kit Rear (Right)**

Kaliper Tamir Takımı Arka (Sağ)

SEM Kit No **12365**

Org. Kit Ref. No --

Application LRG 623



**Caliper Repair Kit Front (Left)**

Kaliper Tamir Takımı Ön (Sol)

SEM Kit No **12366**

Org. Kit Ref. No --

Application LRG 528, 532, 562



**Caliper Repair Kit Front (Right)**

Kaliper Tamir Takımı Ön (Sağ)

SEM Kit No **12367**

Org. Kit Ref. No --

Application LRG 529, 533, 563

<b>Caliper Shaft Short (Left)</b> Kaliper Şaftı Kısa (Sol)	
SEM Kit No	<b>12368</b>
Org. Kit Ref. No	
Application	LRG 528, 532, 562

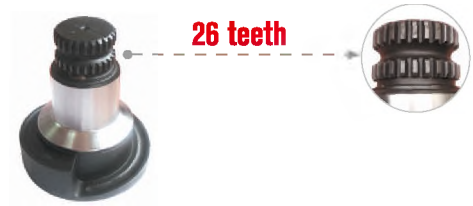

<b>Caliper Shaft Short (Right)</b> Kaliper Şaftı Kısa (Sağ)	
SEM Kit No	<b>12369</b>
Org. Kit Ref. No	--
Application	LRG 529, 533, 563



<b>Caliper Shaft Short (Left)</b> Kaliper Şaftı Kısa (Sol)	
SEM Kit No	<b>12370</b>
Org. Kit Ref. No	--
Application	LRG 524, 526



<b>Caliper Shaft Short (Right)</b> Kaliper Şaftı Kısa (Sağ)	
SEM Kit No	<b>12371</b>
Org. Kit Ref. No	--
Application	LRG 525, 527



<b>Caliper Shaft Long (Left)</b> Kaliper Şaftı Uzun (Sol)	
SEM Kit No	<b>12372</b>
Org. Kit Ref. No	--
Application	LRG 622



<b>Caliper Shaft Long (Right)</b> Kaliper Şaftı Uzun (Sağ)	
SEM Kit No	<b>12373</b>
Org. Kit Ref. No	--
Application	LRG 623

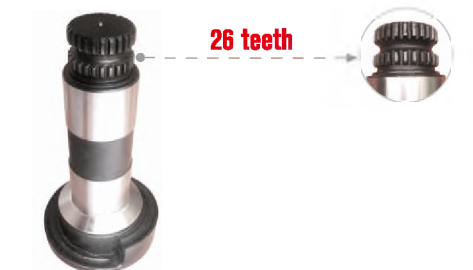





**Caliper Shaft Bearing Lever (Left)**

Kaliper Şaftı Bilya Yatağı (Sol)

SEM Kit No **12374**

Org. Kit Ref. No

Application LRG 524, 526, 528, 532, 562, 622



**Caliper Shaft Bearing Lever (Right)**

Kaliper Şaftı Bilya Yatağı (Sağ)

SEM Kit No **12375**

Org. Kit Ref. No --

Application LRG 525, 527, 529, 533, 563, 623



**Caliper Gear Big (Left)**

Kaliper Dişlisi Büyük (Sol)

SEM Kit No **12376**

Org. Kit Ref. No --

Application LRG 524, 526, 528, 532, 562, 622



**Caliper Gear Big (Right)**

Kaliper Dişlisi Büyük (Sağ)

SEM Kit No **12377**

Org. Kit Ref. No --

Application LRG 525, 527, 529, 533, 563, 623



**Caliper Cover**

Kaliper Kapağı

SEM Kit No **12378**

Org. Kit Ref. No --

Application LRG 524, 525, 526, 527, 528, 529, 532, 533, 562, 563, 622, 623



**Caliper Cover & Boots**

Kaliper Kapağı & Korükleri

SEM Kit No **12379**

Org. Kit Ref. No --

Application LRG 524, 525, 526, 527, 528, 529, 532, 533, 622, 623

<b>Caliper Cover &amp; Bolts</b> Kaliper Kapağı ve Civataları	
SEM Kit No	<b>12380</b>
Org. Kit Ref. No	SJ1212
Application	LRG 524, 525, 526, 527, 528, 529, 532, 533, 622, 623



<b>Caliper Bush &amp; Seals</b> Kaliper Burç & Keçeler	
SEM Kit No	<b>12381</b>
Org. Kit Ref. No	--
Application	LRG 524, 525, 526, 527, 528, 529, 532, 533, 622, 623



<b>Caliper Cover &amp; Bolts</b> Kaliper Kapağı ve Civataları	
SEM Kit No	<b>12382</b>
Org. Kit Ref. No	--
Application	--



<b>Caliper Gear</b> Kaliper Dişlisi	
SEM Kit No	<b>12383</b>
Org. Kit Ref. No	--
Application	LRG 524, 525, 526, 527, 528, 529, 532, 533, 622, 623



<b>Caliper Shaft Roller Bearing</b> Kaliperr Şaft Rulmanı	
SEM Kit No	<b>12384</b>
Org. Kit Ref. No	--
Application	LRG 524, 525, 526, 527, 528, 529, 532, 533, 622, 623



<b>Caliper Shaft Roller Bearing</b> Kaliperr Şaft Rulmanı	
SEM Kit No	<b>12385</b>
Org. Kit Ref. No	--
Application	LRG 524, 525, 526, 527, 528, 529, 532, 533, 622, 623





**Caliper Wavy Washer**

Kaliper Yay Rayneli

SEM Kit No **12386**

Org. Kit Ref. No

Application LRG 524, 525, 526, 527, 528, 529, 532, 533, 622, 623



**Caliper Shaft Bush**

Kaliper Şaft Burcu

SEM Kit No **12387**

Org. Kit Ref. No --

Application LRG 524, 525, 526, 527, 528, 529, 532, 533, 622, 623



**Caliper Adjuster Calibration Bolt**

Kaliper Ayar Civatası

SEM Kit No **12388**

Org. Kit Ref. No --

Application LRG 524, 525, 526, 527, 528, 529, 532, 533, 622, 623



**Caliper Spring Set (Left)**

Kaliper Yay Seti (Sol)

SEM Kit No **12389**

Org. Kit Ref. No --

Application LRG 524, 526, 528, 532, 622



**Caliper Spring Set (Right)**

Kaliper Yay Seti (Sağ)

SEM Kit No **12390**

Org. Kit Ref. No --

Application LRG 525, 527, 529, 533, 623



**Clutch System Repair Kit (Left)**

Debriyaj Sistemi Tamir Takımı (Sol)

SEM Kit No **12391**

Org. Kit Ref. No --

Application LRG 524, 525, 526, 527, 528, 529, 532, 533, 622, 623

<b>Clutch System Repair Kit (Right)</b> Debriyaj Sistemi Tamir Takımı (Sağ)	
SEM Kit No	12392
Org. Kit Ref. No	
Application	LRG 524, 525, 526, 527, 528, 529, 532, 533, 622, 623



<b>Small Clutch System Repair Kit (Left)</b> Küçük Debriyaj Sistemi Tamir Takımı (Sol)	
SEM Kit No	12393
Org. Kit Ref. No	--
Application	LRG 526, 528, 532, 562



<b>Small Clutch System Repair Kit (Right)</b> Küçük Debriyaj Sistemi Tamir Takımı (Sağ)	
SEM Kit No	12394
Org. Kit Ref. No	--
Application	LRG 527, 529, 533, 563



<b>Caliper Push Plate</b> Kaliper Balata Tutucu	
SEM Kit No	12395
Org. Kit Ref. No	--
Application	D3 Type



<b>Disc Carrier Sockets Repair Kit</b> Disk Tamir Takımı	
SEM Kit No	12396
Org. Kit Ref. No	SJ 4000 • RENAULT Ref.no: 5001 823 001
Application	--



<b>Caliper Carrier</b> Kaliper Taşıyıcı	
SEM Kit No	12397
Org. Kit Ref. No	68320717-7
Application	LRG 524, LEG 525





**ELSA 1, ELSA 1 RADIAL**  
**ELSA 2, ELSA 2 RADIAL**  
**ELSA 195, ELSA 225**  
Type Caliper Repair Kits



# ELSA 1 Type Caliper



# ELSA 1 RADIAL Type Caliper



<b>ELSA1 SERIES CALIPERS</b> LRG 542/543/570/571/574/575/576/577/586/587/588/589/590/591/610/617/ 632/633/642/643/704/705/752/753		<b>AXLE // AKS</b>		<b>SEM REPAIR KITS/ /SEM Tamir Takımları</b>
<b>Vehicles // Araçlar</b>	<b>Models // Modeller</b>	<b>Left // Sol</b>	<b>Right // Sağ</b>	
<b>MAN</b>	A13 (99+), A32 (99+), A33 (99+) Rear Axle	LRG 704	LRG 705	12398
	A01 (99+), A03 (99+), A04 (99+) Rear Axle			10733
	TGA H02,05,09,12,17,20,23,25	LRG 586 LRG 588	LRG 587 LRG 589	12399
<b>IRISBUS</b>	Agora (97+) (Rear Axle)	LRG642	LRG643	10734
	Cronus (98+)	LRG642	LRG643	12400
	Chronos City Bus (With ZF Axle)	LRG642	LRG643	12431
<b>MAN</b>	Citybus A25 (05.01 to 09.02) Rear Axle	LRG 632	LRG 633	10736
	Citybus A26 (05.01 to 09.02) Rear Axle			10738
	Citybus A30 (05.01 to 09.02) Rear Axle			10739
	Citybus A35 (05.01 to 09.02) Rear Axle			10740
	FH322 (95+) Front Axle	LRG570	LRG571	10741
	FH422 (95+) Front Axle			10742
	Lionstar (95+) Front Axle	LRG632	LRG633	10743
	NG 313 (99+)			12419
	NG 223 (99+)			12420
	NG 353, Rear Axle	LRG632	LRG633	10744
	F2000 (96+) FRH 322, 422	LRG570	LRG571	10745
<b>RVI (RENAULT)</b>	Agora (97+) Rear Axle	LRG642	LRG643	12421
<b>VAN HOOL</b>	A320	LRG642	LRG643	12422
				12425
				12426



**Caliper Guides & Seals Repair Kit**

Kaliper Mil & Keçe Tamir Takımı

SEM Kit No **12398**

Org. Kit Ref. No MCK 1103 MAN TGA FORTUNA Ref.no: 81.50802.6022

Application LRG 573, 574, 575, 590, 591, 704, 705

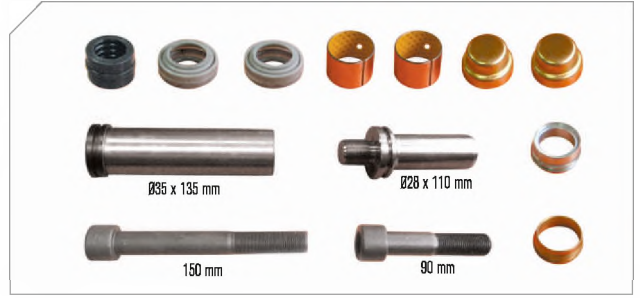

**Caliper Guides & Bushing Repair Kit**

Kaliper Mil & Keçe Tamir Takımı

SEM Kit No **10733**

Org. Kit Ref. No MAN Ref.no: 81.50802.6021

Application --



**Caliper Guides & Bushing Repair Kit**

Kaliper Mil & Keçe Tamir Takımı

SEM Kit No **12399**

Org. Kit Ref. No --

Application LRG 542, 543, 570, 571, 576, 577, 586, 587, 588, 589, 616, 617, 632, 633, 642, 643, 752, 753, LUCAS KJ47/JJ47



**Caliper Tappet Cover Kit**

Kaliper Toz Körüğü Tamir Takımı

SEM Kit No **10734**

Org. Kit Ref. No ST 1156

Application LRG 542, 543, 570, 571, 574, 575, 576, 577, 586, 587, 588, 589, 590, 591, 616, 617, 632, 633, 642, 643, 704, 705, 752, 753, LUCAS KJ47/JJ47



**Caliper Guides & Bushing Repair Kit**

Kaliper Mil & Keçe Tamir Takımı

SEM Kit No **12400**

Org. Kit Ref. No MCK 1102

Application LRG 542, 543, 570, 571, 576, 577, 586, 587, 588, 589, 616, 617, 632, 633, 642, 643, 752, 753, LUCAS KJ47/JJ47



**Caliper Tappet Cover Kit**

Kaliper Toz Körüğü Tamir Takımı

SEM Kit No **12401**

Org. Kit Ref. No --

Application --





**Caliper Half Bearing Repair Kit**

Kaliper Yarım Rulman Tamir Takımı

SEM Kit No	<b>10735</b>
Org. Kit Ref. No	SJ 4112
Application	All LRG Series



**Caliper Bearings**

Kaliper Rulmanları

SEM Kit No	<b>10736</b>
Org. Kit Ref. No	--
Application	--



**Caliper Adjusting Mechanism Clutch System Repair Kit (Right)**

Kaliper Ayar Mekanizması Tamir Takımı (Sağ)

SEM Kit No	<b>10738</b>
Org. Kit Ref. No	--
Application	LUCAS J47



**Caliper Adjusting Mechanism Clutch System Repair Kit (Left)**

Kaliper Ayar Mekanizması Tamir Takımı (Sol)

SEM Kit No	<b>10739</b>
Org. Kit Ref. No	--
Application	LRG 702, LUCAS KJ47



**Caliper Adjusting Mechanism Clutch System Repair Kit (Right)**

Kaliper Ayar Mekanizması Tamir Takımı (Sağ)

SEM Kit No	<b>12402</b>
Org. Kit Ref. No	--
Application	--



**Caliper Adjusting Mechanism Clutch System Repair Kit (Left)**

Kaliper Ayar Mekanizması Tamir Takımı (Sol)

SEM Kit No	<b>12403</b>
Org. Kit Ref. No	--
Application	--

<b>Caliper Adjustment Mechanism</b> Kaliper Ayar Mekanizması	
SEM Kit No	<b>10740</b>
Org. Kit Ref. No	SJ 4112
Application	LRG 542, 543, 570, 571, 586, 587, 588, 589, 590, 591, 632, 633, 642, 643 LUCAS KJ47/JJ47



<b>Caliper Gear (Right)</b> Kaliper Dişlisi (Sağ)	
SEM Kit No	<b>12404</b>
Org. Kit Ref. No	--
Application	LRG 542, 570, 574, 576, 586, 588, 589, 590, 616, 632, 642, 704, 752



<b>Caliper Gear (Left)</b> Kaliper Dişlisi (Sol)	
SEM Kit No	<b>12405</b>
Org. Kit Ref. No	--
Application	LRG 543, 571, 575, 577, 587, 589, 591, 617, 633, 643, 705, 753



<b>Caliper Adjusting Mechanism Tappers Repair Kit (Right)</b> Kaliper Ayar Mekanizması Tamir Takımı (Sağ)	
SEM Kit No	<b>10741</b>
Org. Kit Ref. No	--
Application	LRG 542, 570, 574, 576, 586, 588, 589, 590, 616, 632, 642, 704, 752



<b>Caliper Adjusting Mechanism Tappers Repair Kit (Left)</b> Kaliper Ayar Mekanizması Tamir Takımı (Sol)	
SEM Kit No	<b>10742</b>
Org. Kit Ref. No	--
Application	LRG 543, 571, 575, 577, 587, 589, 591, 617, 633, 643, 705, 753



<b>Caliper Adjusting Mechanism Tappers Repair Kit (Right)</b> Kaliper Ayar Mekanizması Tamir Takımı (Sağ) Ø 37,5	
SEM Kit No	<b>12406</b>
Org. Kit Ref. No	--
Application	--





**Caliper Adjusting Mechanism Tappers Repair Kit (Right)**

Kaliper Ayar Mekanizması Tamir Takımı (Sağ) Ø 37,5

SEM Kit No **12407**

Org. Kit Ref. No --

Application --



**Caliper Gear (Right)**

Kaliper Dişlisi (Sağ)

SEM Kit No **12408**

Org. Kit Ref. No --

Application LRG 542, 570, 574, 576, 586, 588, 589, 590, 616, 632, 642, 704, 752



**Caliper Gear (Left)**

Kaliper Dişlisi (Sol)

SEM Kit No **12409**

Org. Kit Ref. No --

Application LRG 543, 571, 575, 577, 587, 589, 591, 617, 633, 643, 705, 753

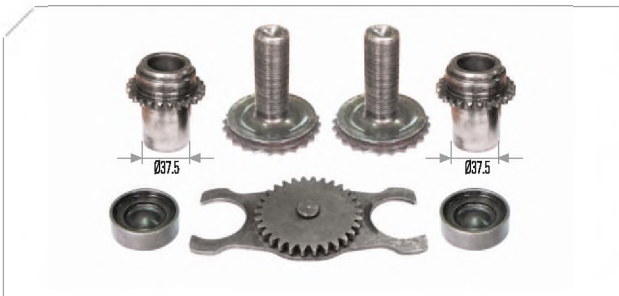

**Caliper Adjusting Mechanism Tappers Repair Kit (Right)**

Kaliper Ayar Mekanizması Tamir Takımı (Sağ)

SEM Kit No **12410**

Org. Kit Ref. No --

Application LRG 542, 570, 574, 576, 586, 588, 589, 590, 616, 632, 642, 704, 752

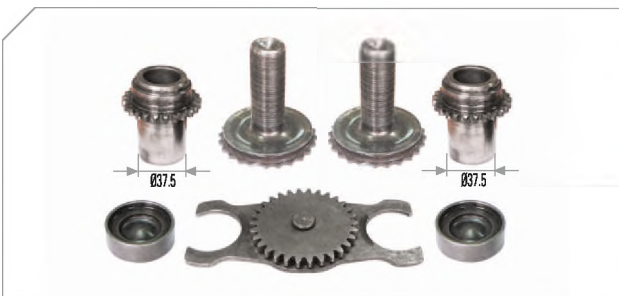

**Caliper Adjusting Mechanism Tappers Repair Kit (Left)**

Kaliper Ayar Mekanizması Tamir Takımı (Sol)

SEM Kit No **12411**

Org. Kit Ref. No --

Application LRG 543, 571, 575, 577, 587, 589, 591, 617, 633, 643, 705, 753



**Caliper Adjusting Mechanism Tappers Repair Kit (Right)**

Kaliper Ayar Mekanizması Tamir Takımı (Sağ) Ø 35

SEM Kit No **12412**

Org. Kit Ref. No --

Application --



**Caliper Adjusting Mechanism Tappers Repair Kit (Left)**

Kaliper Ayar Mekanizması Tamir Takımı (Sol) Ø 35

SEM Kit No **12413**

Org. Kit Ref. No

Application LRG 543, 571, 575, 577, 587, 589, 591, 617, 633, 643, 705, 753

**Caliper Adjusting Gear Bush (35 mm)**

Kaliper Ayar Mekanizması Burcu (35 mm)

SEM Kit No **12414**

Org. Kit Ref. No --

Application ELSA 1

**Caliper Adjusting Gear Bush (37.5 mm)**

Kaliper Ayar Mekanizması Burcu (37.5 mm)

SEM Kit No **12415**

Org. Kit Ref. No --

Application ELSA 1

**Caliper Adjusting Gear Sheet (35 mm)**

Kaliper Ayar Dişli Sacı (35 mm)

SEM Kit No **12416**

Org. Kit Ref. No --

Application ELSA 1

**Caliper Adjusting Gear Sheet (37.5 mm)**

Kaliper Ayar Dişli Sacı (37.5 mm)

SEM Kit No **12417**

Org. Kit Ref. No --

Application ELSA 1

**Metal Cap**

Metal Kapak

SEM Kit No **12418**

Org. Kit Ref. No --

Application ELSA 1





**Caliper Locking Shim Repair Kit**

Kaliper Sac Kapağı Tamir Takımı

SEM Kit No **10743**

Org. Kit Ref. No 68321678PK10

Application LRG 542, 543, 570, 571, 586, 587, 588, 589, 590, 591, 632, 633, 642, 643  
LUCAS KJ47/JJ47



**Caliper Spring Retainers Thrust Repair Kit (Right)**

Kaliper Geri Dönüş Yayı Tamir Takımı (Sağ)

SEM Kit No **12419**

Org. Kit Ref. No --

Application LRG 570, 574, 576, 586, 588, 590, 616, 704



**Caliper Spring Retainers Thrust Repair Kit (Left)**

Kaliper Geri Dönüş Yayı Tamir Takımı (Sol)

SEM Kit No **12420**

Org. Kit Ref. No --

Application LRG 571, 575, 577, 587, 589, 591, 617, 705

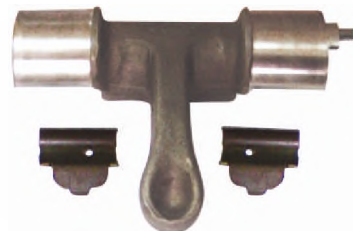

**Caliper Lever (Right)**

Kaliper Masura Bilya Yatağı (Sağ)

SEM Kit No **10744**

Org. Kit Ref. No --

Application LRG 570, 574, 576, 586, 588, 590, 616, 704

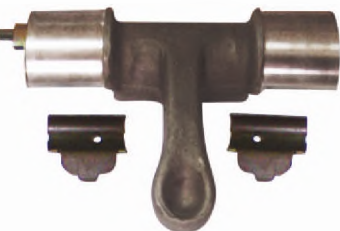

**Caliper Lever (Left)**

Kaliper Masura Bilya Yatağı (Sol)

SEM Kit No **10745**

Org. Kit Ref. No --

Application LRG 571, 575, 577, 587, 589, 591, 617, 705

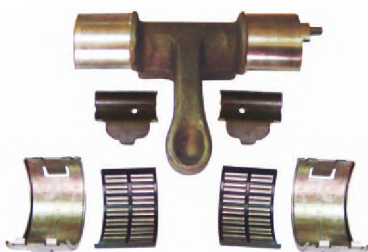

**Caliper Lever (Right)**

Kaliper Masura Bilya Yatağı (Sağ)

SEM Kit No **12421**

Org. Kit Ref. No --

Application LRG 570, 574, 576, 586, 588, 590, 616, 704

<b>Caliper Lever (Left)</b> Kaliper Masura Bilya Yatađı (Sol)	
SEM Kit No	12422
Org. Kit Ref. No	
Application	LRG 571, 575, 577, 587, 589, 591, 617, 705

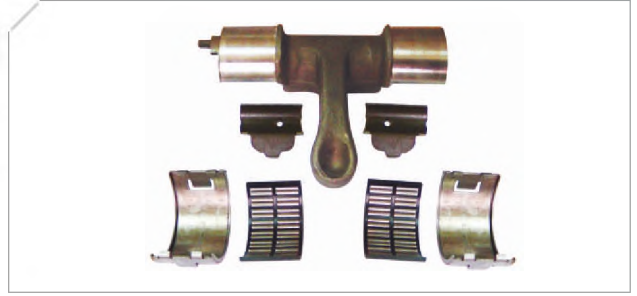

<b>Caliper Lever</b> Kaliper Masura Bilya Yatađı	
SEM Kit No	12423
Org. Kit Ref. No	--
Application	D ELSA 1, RADIAL



<b>Caliper Lever</b> Kaliper Masura Bilya Yatađı	
SEM Kit No	12424
Org. Kit Ref. No	--
Application	D ELSA 1, RADIAL



<b>Caliper Cover Plate Gasket</b> Kaliper Kapak Contası	
SEM Kit No	12425
Org. Kit Ref. No	--
Application	--



<b>Caliper Cover Plate Gasket</b> Kaliper Kapak Contası	
SEM Kit No	12426
Org. Kit Ref. No	--
Application	--



<b>Caliper Cover Plate Gasket</b> Kaliper Kapak Contası	
SEM Kit No	12427
Org. Kit Ref. No	--
Application	--

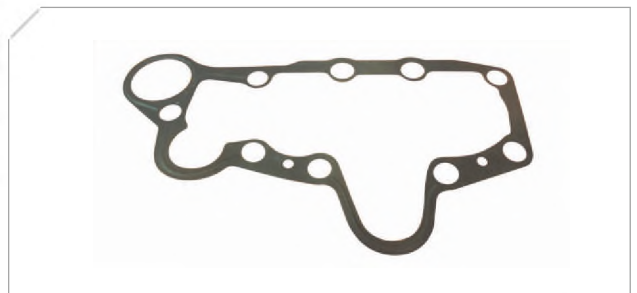





<b>Caliper Seals &amp; Caps Repair Kit</b> Kaliper Keçe Tamir Takımı	
SEM Kit No	<b>12428</b>
Org. Kit Ref. No	68322300PK10
Application	LRG 452/43



<b>Caliper Carrier</b> Kaliper Taşıyıcı	
SEM Kit No	<b>12429</b>
Org. Kit Ref. No	KJ47 • MAN Ref.no: 81508046199
Application	LRG 570



<b>Caliper Carrier</b> Kaliper Taşıyıcı	
SEM Kit No	<b>12430</b>
Org. Kit Ref. No	JJ47 • MAN Ref.no: 81508046200
Application	LRG 571

# **ELSA 2, ELSA 2 RADIAL ELSA 195, ELSA 225**

Type Caliper Repair Kits

## ELSA 2 Type Caliper



## ELSA 2 RADIAL Type Caliper



## ELSA 195 Type Caliper



## ELSA 225 Type Caliper



<b>ELSA 2 SERIES CALIPERS</b> LRG544/545/546/547/572/573/580/581/582/583/630/639/646/647/650/659/662/663/664/665/ 700/701/702/703/712/713/720/721/722/723/724/725/736/737/744/745/748/749/750/751		<b>AXLE // AKS</b>		<b>SEM REPAIR KITS/ /SEM Tamir Takımları</b>
<b>Vehicles // Araçlar</b>	<b>Models // Modeller</b>	<b>Left // Sol</b>	<b>Right // Sağ</b>	
<b>ERF</b>	ECS, ECX ALL MODELS	LRG544	LRG545	12434
<b>MAN</b>	TGA H12, 17	LRG638	LRG639	10761
	F2000	LRG546	LRG547	12435
	STADT CITYBUS	LRG662 LRG720	LRG663 LRG721	12436 10762
	STADT CITYBUS (0°)	LRG722	LRG723	12485 10764
<b>ROR</b>	LM, TA	LRG572	LRG573	12445
	LM, TM	LRG702	LRG703	12446
<b>VOLVO</b>	CITYBUS B7LA (CENTRAL AXLE) CITYBUS B7LA, B7TL, B9TL, B7L, B9 SALE (REAR)	LRG669	LRG670	12447 12449 10735
<b>RENAULT</b>	Magnum AE Range Premium	LRG580	LRG581	10736
		LRG582	LRG583	10748
<b>VAN HOOL</b>	Coach & Intercity 915CL, 9158CL, 915TL, T911, T915, T917, T916, T918, T924, T927	LRG722 LRG748	LRG723 LRG749	12311
				12312
				12450
				12451
				12452
12453				
10765				



**Caliper Guides & Bushing Repair Kit**

Kaliper Mil & Keçe Tamir Takımı

SEM Kit No **12431**

Org. Kit Ref. No MCK 1086

Application --



**Caliper Dust Boots Repair Kit**

Kaliper Toz Lastiği Tamir Takımı

SEM Kit No **12432**

Org. Kit Ref. No SJ4053

Application ELSA 2, ELSA 195, ELSA 225



**Caliper Guides & Bushing Repair Kit**

Kaliper Mil & Keçe Tamir Takımı

SEM Kit No **12433**

Org. Kit Ref. No --

Application --



**Caliper Dust Boots Repair Kit**

Kaliper Toz Lastiği Tamir Takımı

SEM Kit No **10748**

Org. Kit Ref. No 68324854PK10 / MCK 1139 • MAN Ref.no: 81.50802.6024

Application LRG 544, 545, 572, 573, 580, 581, 582, 583, 638, 639, 646, 647, 658, 659, 662, 663, 664, 665, 669, 670, 700, 701, 712, 713, 720, 721, 722, 723, 724, 725, 736, 737, 744, 745, 748, 749, 750, 751



**Caliper Tappet Head Repair Kit**

Kaliper Toz Lastiği Komple Tamir Takımı

SEM Kit No **10749**

Org. Kit Ref. No MCK 1238

Application LRG 536, 537, 552, 553, 560, 561, 578, 579, 596, 597, 598, 599, 648, 649, 650, 651, 652, 653



**Caliper Dust Boots Repair Kit**

Kaliper Toz Lastiği Tamir Takımı

SEM Kit No **12290**

Org. Kit Ref. No --

Application All LRG Series

<b>Caliper Guides &amp; Bushing Repair Kit</b> Kaliper Mil & Keçe Tamir Takımı	
SEM Kit No	<b>12434</b>
Org. Kit Ref. No	--
Application	--

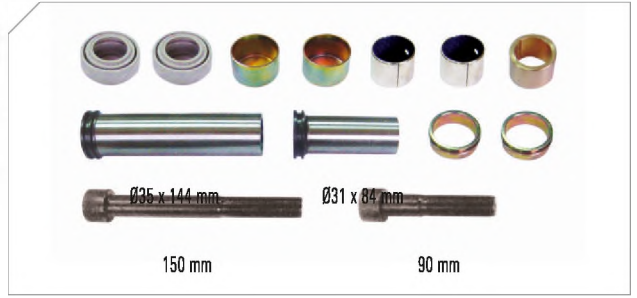

<b>Caliper Guides &amp; Bushing Repair Kit</b> Kaliper Mil & Keçe Tamir Takımı	
SEM Kit No	<b>10761</b>
Org. Kit Ref. No	MCK 1243 RENAULT Ref.no: 5001 860 791 • MAN Ref.no: 81508026025
Application	LRG 544, 545, 572, 573, 580, 581, 582, 583, 638, 639, 646, 647, 658, 659 662, 663, 700, 701, 712, 713, 722, 723, 744, 745, 748, 749, 750, 751

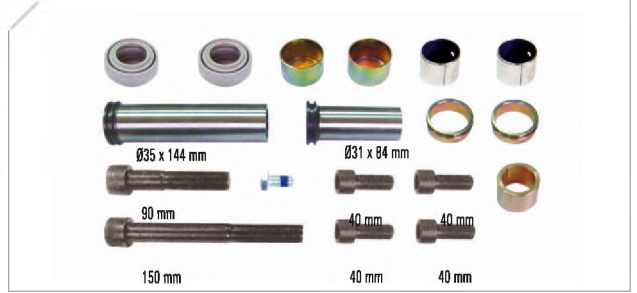

<b>Caliper Dust Boots Repair Kit</b> Kaliper Toz Korumaları Tamir Takımı	
SEM Kit No	<b>12435</b>
Org. Kit Ref. No	MCK 1244
Application	LRG 544, 545, 572, 573, 580, 581, 582, 583, 638, 639, 646, 647, 658, 659 662, 663, 700, 701, 712, 713, 722, 723, 744, 745, 748, 749, 750, 751

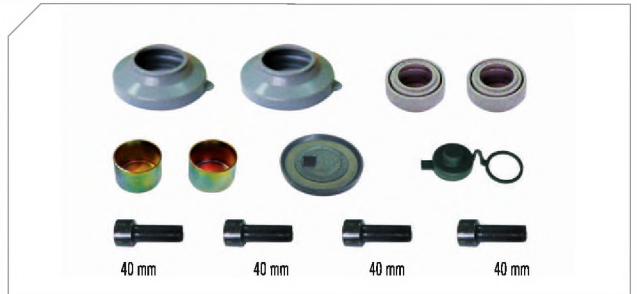

<b>Caliper Guides &amp; Bushing Repair Kit</b> Kaliper Mil & Keçe Tamir Takımı	
SEM Kit No	<b>12436</b>
Org. Kit Ref. No	--
Application	--



<b>Caliper Dust Boots Repair Kit</b> Kaliper Toz Korumaları Tamir Takımı	
SEM Kit No	<b>12437</b>
Org. Kit Ref. No	MCK 1088
Application	LRG 582, 583



<b>Caliper Dust Boots &amp; Caps Repair Kit</b> Kaliper Toz Koruması & Tapa Tamir Takımı	
SEM Kit No	<b>12438</b>
Org. Kit Ref. No	MCK 1253
Application	ELSA 2







**Caliper Guides & Bushing Repair Kit**

Kaliper Mil & Keçe Tamir Takımı

SEM Kit No **12439**

Org. Kit Ref. No MCK 1254

Application ELSA 2



**Caliper Adjuster Mechanism Repair Kit**

Kaliper Ayar Mekanizması Tamir Takımı

SEM Kit No **10762**

Org. Kit Ref. No --

Application LRG 544, 545, 572, 573, 580, 581, 582, 583, 638, 639, 646, 647, 658, 659, 662, 663, 664, 665, 669, 670, 700, 701, 712, 713, 720, 721, 722, 723, 724, 725, 736, 737, 744, 745, 748, 749, 750, 751



**Caliper Brake Lining Calibration Gear (New Model)**

Kaliper Fren Ayar Dişlisi (Yeni Model)

SEM Kit No **10763**

Org. Kit Ref. No --

Application LRG 544, 545, 572, 573, 580, 581, 582, 583, 638, 639, 646, 647, 658, 659, 662, 663, 664, 665, 669, 670, 700, 701, 712, 713, 720, 721, 722, 723, 724, 725, 736, 737, 744, 745, 748, 749, 750, 751



**Caliper Brake Lining Calibration Gear (Old Model)**

Kaliper Fren Ayar Dişlisi (Eski Model)

SEM Kit No **12440**

Org. Kit Ref. No --

Application LRG 544, 545, 572, 573, 580, 581, 582, 583, 638, 639, 646, 647, 658, 659, 662, 663, 664, 665, 669, 670, 700, 701, 712, 713, 720, 721, 722, 723, 724, 725, 736, 737, 744, 745, 748, 749, 750, 751



**Caliper Adjusting Mechanism Clutch System Repair Kit**

Kaliper Ayar Mekanizması Tamir Takımı

SEM Kit No **12441**

Org. Kit Ref. No --

Application LRG 544, 545, 572, 573, 580, 581, 582, 583, 638, 639, 646, 647, 658, 659, 662, 663, 664, 665, 669, 670, 700, 701, 712, 713, 720, 721, 722, 723, 724, 725, 736, 737, 744, 745, 748, 749, 750, 751



**Caliper Adjusting Mechanism Clutch System Repair Kit**

Kaliper Ayar Mekanizması Tamir Takımı

SEM Kit No **12442**

Org. Kit Ref. No --

Application --



<b>Caliper Piston Repair Kit</b> Kaliper Piston Tamir Takımı	
SEM Kit No	<b>12443</b>
Org. Kit Ref. No	MCK 1309 • RENAULT Ref.no: 5001866398
Application	LRG 638, 639



<b>Caliper Calibration Mechanism Cap (Aluminium) &amp; Gasket</b> Kaliper Ayar Mekanizması Kapağı (Alüminyum) ve Contası	
SEM Kit No	<b>10764</b>
Org. Kit Ref. No	--
Application	LRG 544, 545, 572, 573, 580, 581, 582, 583, 638, 639, 646, 647, 658, 659, 662, 663, 664, 665, 669, 670, 700, 701, 712, 713, 720, 721, 722, 723, 724, 725, 736, 737, 744, 745, 748, 749, 750, 751



<b>Caliper Calibration Mechanism Kit</b> Kaliper Ayar Mekanizması Seti	
SEM Kit No	<b>12444</b>
Org. Kit Ref. No	--
Application	--

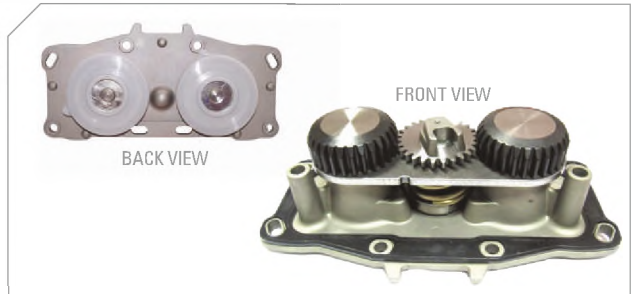

<b>Caliper Adjusting Gear (Left)</b> Kaliper Ayar Dişlisi (Sol)	
SEM Kit No	<b>12445</b>
Org. Kit Ref. No	--
Application	LRG 544, 545, 572, 573, 580, 581, 582, 583, 638, 639, 646, 647, 658, 659, 662, 663, 664, 665, 669, 670, 700, 701, 712, 713, 720, 721, 722, 723, 724, 725, 736, 737, 744, 745, 748, 749, 750, 751



<b>Caliper Adjusting Gear (Right)</b> Kaliper Ayar Dişlisi (Sağ)	
SEM Kit No	<b>12446</b>
Org. Kit Ref. No	--
Application	LRG 544, 545, 572, 573, 580, 581, 582, 583, 638, 639, 646, 647, 658, 659, 662, 663, 664, 665, 669, 670, 700, 701, 712, 713, 720, 721, 722, 723, 724, 725, 736, 737, 744, 745, 748, 749, 750, 751



<b>Caliper Adjusting Mechanism Sealings</b> Kaliper Ayar Mekanizması Keçeleri	
SEM Kit No	<b>12447</b>
Org. Kit Ref. No	--
Application	LRG 544, 545, 572, 573, 580, 581, 582, 583, 638, 639, 646, 647, 658, 659, 662, 663, 664, 665, 669, 670, 700, 701, 712, 713, 720, 721, 722, 723, 724, 725, 736, 737, 744, 745, 748, 749, 750, 751



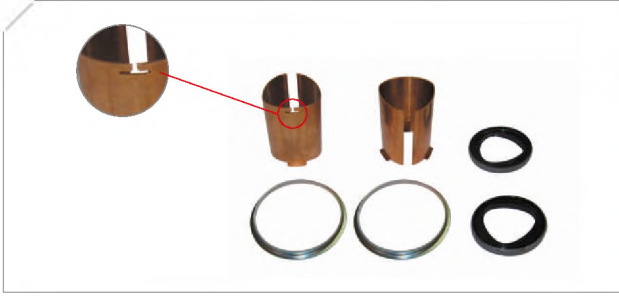

**Caliper Adjusting Mechanism Sealings**

Kaliper Ayar Mekanizması Keçeleri

SEM Kit No **12448**

Org. Kit Ref. No --

Application --



**Caliper Bearing Cap**

Kaliper Bilya Yatağı

SEM Kit No **12449**

Org. Kit Ref. No --

Application LRG 544, 545, 572, 573, 580, 581, 582, 583, 638, 639, 646, 647, 658, 659, 662, 663, 664, 665, 669, 670, 700, 701, 712, 713, 720, 721, 722, 723, 724, 725, 736, 737, 744, 745, 748, 749, 750, 751

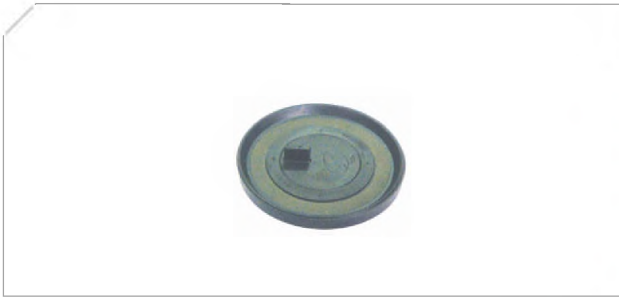

**Caliper Dust Cover**

Kaliper Toz Lastiği

SEM Kit No **12450**

Org. Kit Ref. No 68323746PK10

Application All LRG Series

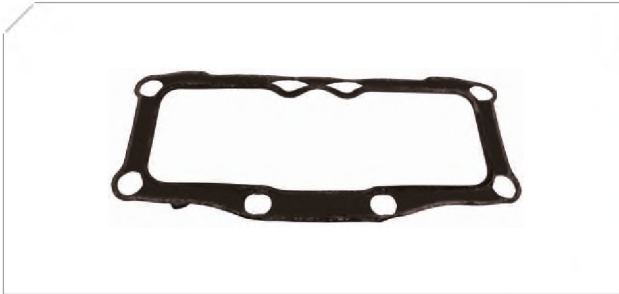

**Caliper Cover Gasket**

Kaliper Kapak Contası

SEM Kit No **12451**

Org. Kit Ref. No --

Application LRG 544, 545, 546, 547, 572, 573, 580, 581, 582, 583, 638, 639, 646, 647, 658, 659, 662, 663, 664, 665, 669, 670, 700, 701, 712, 713, 720, 721, 722, 723, 724, 725, 744, 745, 748, 749, 750, 751

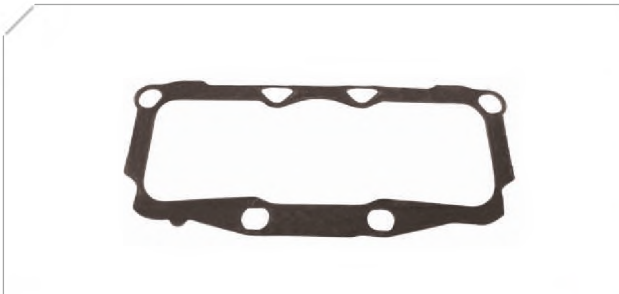

**Caliper Cover Gasket**

Kaliper Kapak Contası

SEM Kit No **12452**

Org. Kit Ref. No --

Application --



**Pad Wear Indicator**

Balata Sinyal İndikatorü

SEM Kit No **12453**

Org. Kit Ref. No MCK 1147

Application LRG 547, 548, 638, 639

<b>Pad Wear Indicator (Front Right)</b> Balata Sinyal İndikatoru (Sağ Ön)	
SEM Kit No	<b>12454</b>
Org. Kit Ref. No	--
Application	RENAULT PREMIUM 420: 5001 856 032



<b>Pad Wear Indicator (Back Right)</b> Balata Sinyal İndikatoru (Sağ Arka)	
SEM Kit No	<b>12455</b>
Org. Kit Ref. No	--
Application	RENAULT PREMIUM 420: 5001 856 034



<b>Pad Wear Indicator (Front Left)</b> Balata Sinyal İndikatoru (Sol Ön)	
SEM Kit No	<b>12456</b>
Org. Kit Ref. No	--
Application	RENAULT PREMIUM 420: 5001 856 031



<b>Pad Wear Indicator (Back Left)</b> Balata Sinyal İndikatoru (Sol Arka)	
SEM Kit No	<b>12457</b>
Org. Kit Ref. No	--
Application	RENAULT PREMIUM 420: 5001 856 033



<b>Pad Wear Indicator (Front Right)</b> Balata Sinyal İndikatoru (Sağ Ön)	
SEM Kit No	<b>12458</b>
Org. Kit Ref. No	--
Application	VOLVO FH, RENAULT PREMIUM 440: 7420 928 560



<b>Pad Wear Indicator (Back Right)</b> Balata Sinyal İndikatoru (Sağ Arka)	
SEM Kit No	<b>12459</b>
Org. Kit Ref. No	--
Application	VOLVO FH, RENAULT PREMIUM 440: 7420 928 553





**Pad Wear Indicator (Front Left)**

Balata Sinyal İndikatoru (Sol Ön)

SEM Kit No **12460**

Org. Kit Ref. No --

Application VOLVO FH, RENAULT PREMIUM 440, 430: 7420 928 559



**Pad Wear Indicator (Back Left)**

Balata Sinyal İndikatoru (Sol Arka)

SEM Kit No **12461**

Org. Kit Ref. No --

Application VOLVO FH, RENAULT PREMIUM 440: 7420 928 552



**Pad Wear Indicator (Front)**

Balata Sinyal İndikatoru (Ön)

SEM Kit No **12462**

Org. Kit Ref. No --

Application VOLVO FH: 20928533



**Pad Wear Indicator (Back)**

Balata Sinyal İndikatoru (Arka)

SEM Kit No **12463**

Org. Kit Ref. No --

Application VOLVO FH: 20928532



**Pad Wear Indicator (Front Left-Right)**

Balata Sinyal İndikatoru (Ön Sağ-Sol)

SEM Kit No **12464**

Org. Kit Ref. No --

Application MAN TGA: 81 25937 6015



**Pad Wear Indicator (Back Left)**

Balata Sinyal İndikatoru (Sol Arka)

SEM Kit No **12465**

Org. Kit Ref. No --

Application MAN TGA: 81 25937 6041



<b>Pad Wear Indicator (Back Right)</b> Balata Sinyal İndikatorü (Sağ Arka)	
SEM Kit No	<b>12466</b>
Org. Kit Ref. No	--
Application	MAN TGA: 81 25937 6044



<b>Pad Wear Indicator</b> Balata Sinyal İndikatorü	
SEM Kit No	<b>12467</b>
Org. Kit Ref. No	--
Application	VOLVO : 20928541



<b>Pad Wear Indicator</b> Balata Sinyal İndikatorü	
SEM Kit No	<b>12468</b>
Org. Kit Ref. No	--
Application	VOLVO : 21390374



SEM Kod No	OEM Ref No	Description
<b>12469</b>	VOLVO Ref.no: 21390375	Pad Wear Indicator Balata Sinyal İndikatorü
<b>12191</b>	VOLVO Ref.no: 21390376 / 20928545	Pad Wear Indicator Balata Sinyal İndikatorü
<b>12251</b>	VOLVO Ref.no: 21390372 / 20928356	Pad Wear Indicator Balata Sinyal İndikatorü
<b>12476</b>	VOLVO Ref.no: 21390373 / 20928537	Pad Wear Indicator Balata Sinyal İndikatorü
<b>12484</b>	VOLVO Ref.no: 20928547	Pad Wear Indicator Balata Sinyal İndikatorü
<b>12495</b>	VOLVO Ref.no: 20928548	Pad Wear Indicator Balata Sinyal İndikatorü
<b>12477</b>	VOLVO Ref.no: 20928563	Pad Wear Indicator Balata Sinyal İndikatorü
<b>12223</b>	VOLVO Ref.no: 20928564	Pad Wear Indicator Balata Sinyal İndikatorü



<b>Caliper Lever</b> Kaliper Masura Bilya Yatağı	
SEM Kit No	<b>10765</b>
Org. Kit Ref. No	--
Application	--





**Caliper Lever**

Kaliper Masura Bilya Yatağı

SEM Kit No **12470**

Org. Kit Ref. No --

Application --



**Caliper Lever**

Kaliper Masura Bilya Yatağı

SEM Kit No **12471**

Org. Kit Ref. No --

Application --



**Caliper Lever**

Kaliper Masura Bilya Yatağı

SEM Kit No **12472**

Org. Kit Ref. No --

Application --



**Caliper Lever**

Kaliper Masura Bilya Yatağı

SEM Kit No **12473**

Org. Kit Ref. No --

Application --



**Caliper Visual Pad Wear & Screw Repair Kit**

Kaliper Fren Pabucu Seviye Gösterge Çubuğu Tamir Takımı

SEM Kit No **12474**

Org. Kit Ref. No MCK 1240

Application --



**Half Bearing Repair Kit**

Kaliper Yarım rulman Tamir Takımı

SEM Kit No **10735**

Org. Kit Ref. No SJ 4112

Application LRG 544, 545, 572, 573, 580, 581, 582, 583, 638, 639, 646, 647, 658, 659, 662, 663, 664, 665, 669, 670, 700, 701, 712, 713, 720, 721, 722, 723, 724, 725, 736, 737, 744, 745, 748, 749, 750, 751

<b>Caliper Bearings</b> Kaliper Rulmanları	
SEM Kit No	<b>10736</b>
Org. Kit Ref. No	--
Application	LRG 544, 545, 572, 573, 580, 581, 582, 583, 638, 639, 646, 647, 658, 659, 662, 663, 664, 665, 669, 670, 700, 701, 712, 713, 720, 721, 722, 723, 724, 725, 736, 737, 744, 745, 748, 749, 750, 751



<b>Half Bearing Repair Kit</b> Kaliper Yarım rulman Tamir Takımı	
SEM Kit No	<b>12476</b>
Org. Kit Ref. No	--
Application	--



<b>Caliper Pad Retainer Repair Kit</b> Kaliper İpat Tutucu Tamir Takımı	
SEM Kit No	<b>12477</b>
Org. Kit Ref. No	MCK 1264
Application	LRG 544, 545, 572, 573, 580, 581, 582, 583, 638, 639, 646, 647, 658, 659, 662, 663, 664, 665, 669, 670, 700, 701, 712, 713, 720, 721, 722, 723, 724, 725, 736, 737, 744, 745, 748, 749, 750, 751



<b>Caliper Pad Retainer Repair Kit</b> Kaliper İpat Tutucu Tamir Takımı	
SEM Kit No	<b>12310</b>
Org. Kit Ref. No	MCK 1263
Application	--



<b>Caliper Adjuster Dust Bolot</b> Kaliper Ayar Mekanizması Toz Lastiği	
SEM Kit No	<b>12312</b>
Org. Kit Ref. No	68322655PK10
Application	All LRG Series

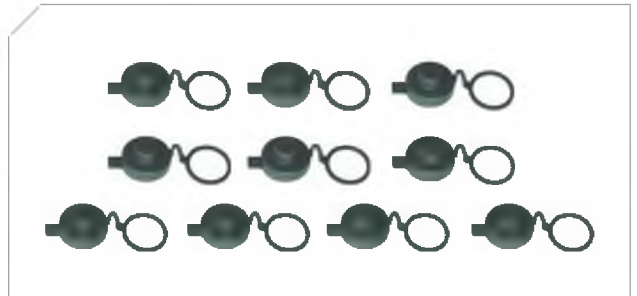





**Caliper Carrier 22,5"**

Kaliper Taşıyıcı 22,5"

SEM Kit No **12478**

Org. Kit Ref. No --

Application ELSA 2



**Caliper Carrier**

Kaliper Taşıyıcı

SEM Kit No **12479**

Org. Kit Ref. No --

Application ELSA 195, ELSA 225



**Caliper Carrier**

Kaliper Taşıyıcı

SEM Kit No **12480**

Org. Kit Ref. No MAN Ref.no: 81508046238

Application LRG 639



# EX 225

## Type Caliper Repair Kits



**Caliper Guides & Seals Repair Kit**

Kaliper Mil & Keçe Tamir Takımı

SEM Kit No **11841**

Org. Kit Ref. No MCK 1298 • VOLVO Ref.no: 85109890 • RENAULT PREMIUM Ref.no: 5001866989

Application LRG 728, 729, 730, 731, 732, 733, RENAULT PREMIUM 440



**Caliper Dust Boots & Bolts Repair Kit**

Kaliper Toz Körüğü & Civata Tamir Takımı

SEM Kit No **12481**

Org. Kit Ref. No MCK 1310 VOLVO Ref.no: 85109892

Application LRG 726, 727, 728, 729, 730, 731, 732, 733

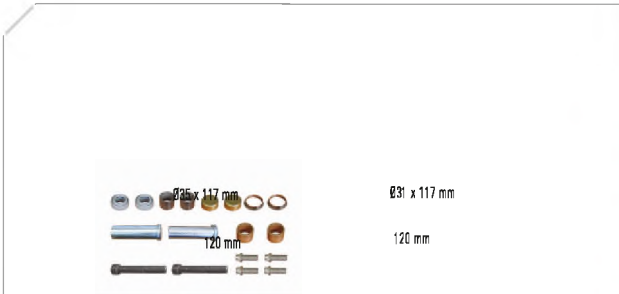

**Caliper Guides & Seals Repair Kit**

Kaliper Mil & Keçe Tamir Takımı

SEM Kit No **11813**

Org. Kit Ref. No MCK 1317 VOLVO Ref.no: 85109889

Application LRG 726, 727, ELSA 195, 225, RADIAL



**Caliper Dust Boots & Bolts Repair Kit**

Kaliper Toz Körüğü & Civata Tamir Takımı

SEM Kit No **12482**

Org. Kit Ref. No 225201

Application --

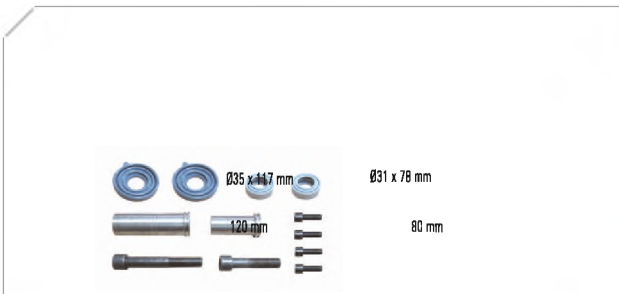

**Caliper Guides & Seals Repair Kit**

Kaliper Mil & Keçe Tamir Takımı

SEM Kit No **12483**

Org. Kit Ref. No 225200

Application --



**Caliper Tappet Dust Cover**

Kaliper Toz Lastiği

SEM Kit No **12432**

Org. Kit Ref. No SJ4053

Application ELSA 2, ELSA 195, ELSA 225

<b>Caliper Dust Boots &amp; Caps Repair Kit</b> Kaliper Toz K�r�g� & Kapak Tamir Takımı	
SEM Kit No	<b>12438</b>
Org. Kit Ref. No	MCK 1253
Application	ELSA 2



<b>Caliper Guides &amp; Bushing Repair Kit</b> Kaliper Mil & Kee Tamir Takımı	
SEM Kit No	<b>12439</b>
Org. Kit Ref. No	MCK 1254
Application	ELSA 2



<b>Caliper Adjuster Mechanism Repair Kit</b> Kaliper Ayar mekanizması Tamir Takımı	
SEM Kit No	<b>12485</b>
Org. Kit Ref. No	--
Application	LRG 544, 545, 572, 573, 580, 581, 582, 583, 638, 639, 646, 647, 658, 659, 662, 663, 664, 665, 669, 670, 700, 701, 712, 713, 720, 721, 722, 723, 724, 725, 736, 737, 744, 745, 748, 749, 750, 751



<b>Caliper Brake Lining Calibration Gear (New Model)</b> Kaliper Fren Ayar Diřlisi (Yeni Model)	
SEM Kit No	<b>12486</b>
Org. Kit Ref. No	--
Application	LRG 544, 545, 572, 573, 580, 581, 582, 583, 638, 639, 646, 647, 658, 659, 662, 663, 664, 665, 669, 670, 700, 701, 712, 713, 720, 721, 722, 723, 724, 725, 736, 737, 744, 745, 748, 749, 750, 751



<b>Caliper Adjusting Mechanism Clutch System Repair Kit</b> Kaliper Ayar Mekanizması Tamir Takımı	
SEM Kit No	<b>12487</b>
Org. Kit Ref. No	--
Application	LRG 544, 545, 572, 573, 580, 581, 582, 583, 638, 639, 646, 647, 658, 659, 662, 663, 664, 665, 669, 670, 700, 701, 712, 713, 720, 721, 722, 723, 724, 725, 736, 737, 744, 745, 748, 749, 750, 751





**Caliper Calibration Mechanism Cap (Aluminium) & Gasket**

Kaliper Ayar Mekanizması Kapağı (Alüminyum) & Contası

SEM Kit No **12488**

Org. Kit Ref. No --

Application --

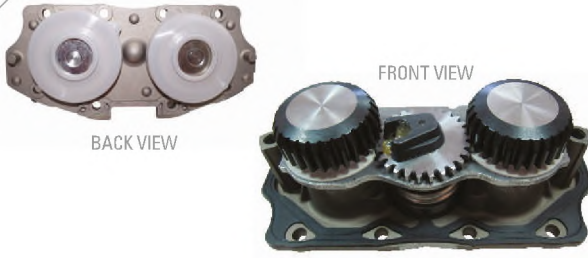

**Caliper Complete Calibration Mechanism Cap (Aluminium)**

Kaliper Ayar Mekanizması Kapağı (Alüminyum)

SEM Kit No **12489**

Org. Kit Ref. No --

Application --



**Caliper Visual Pad Wear Assembly**

Kaliper Fren Pabucu Seviye Gösterge Çubuğu

SEM Kit No **12490**

Org. Kit Ref. No MCK 1311 • VOLVO Ref.no: 85109893

Application LRG 726, 727, 728, 729, 730, 731, 732, 733



**Caliper Adjusting Gear**

Kaliper Ayar Dişlisi

SEM Kit No **12491**

Org. Kit Ref. No --

Application --

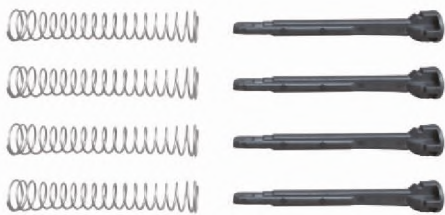

**Caliper Visual Pad Wear Assembly**

Kaliper Fren Pabucu Seviye Gösterge Çubuğu

SEM Kit No **12492**

Org. Kit Ref. No 225207

Application --

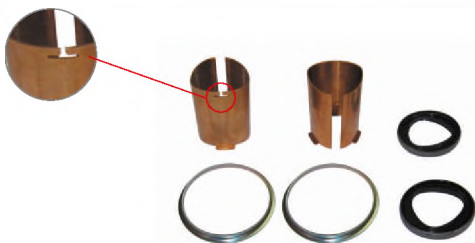

**Caliper Adjusting Mechanism Sealings**

Kaliper Ayar Mekanizması Keçeleri

SEM Kit No **12493**

Org. Kit Ref. No --

Application --

<b>Caliper Bearing Cap</b> Kaliper Bilya Yatađı	
SEM Kit No	<b>12494</b>
Org. Kit Ref. No	--
Application	LRG 544, 545, 572, 573, 580, 581, 582, 583, 638, 639, 646, 647, 658, 659, 662, 663, 664, 665, 669, 670, 700, 701, 712, 713, 720, 721, 722, 723, 724, 725, 736, 737, 744, 745, 748, 749, 750, 751



<b>Caliper Dust Cover</b> Kaliper Toz Lastiđı	
SEM Kit No	<b>12495</b>
Org. Kit Ref. No	68323746PK10
Application	All LRG Series



<b>Caliper Calibration Mechanism Gasket</b> Kaliper Ayar Mekanizması Contası	
SEM Kit No	<b>12496</b>
Org. Kit Ref. No	--
Application	--



<b>Caliper Bearings</b> Kaliper Rulmanları	
SEM Kit No	<b>12497</b>
Org. Kit Ref. No	--
Application	All LRG Series



<b>Caliper Bearing Repair Kit</b> Kaliper Rulman Tamir Takımı	
SEM Kit No	<b>12498</b>
Org. Kit Ref. No	--
Application	LRG 544, 545, 572, 573, 580, 581, 582, 583, 638, 639, 646, 647, 658, 659, 662, 663, 664, 665, 669, 670, 700, 701, 712, 713, 720, 721, 722, 723, 724, 725, 736, 737, 744, 745, 748, 749, 750, 751



<b>Caliper Pad Retainer Repair Kit</b> Kaliper Balata Tutucu Tamir Takımı	
SEM Kit No	<b>12499</b>
Org. Kit Ref. No	MCK 1264
Application	LRG 544, 545, 572, 573, 580, 581, 582, 583, 638, 639, 646, 647, 658, 659, 662, 663, 664, 665, 669, 670, 700, 701, 712, 713, 720, 721, 722, 723, 724, 725, 736, 737, 744, 745, 748, 749, 750, 751





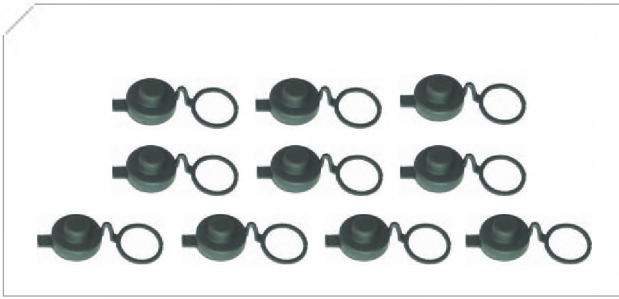

**Caliper Adjuster Dust Boot**

Kaliper Ayar Mekanizması Toz Lastiği

SEM Kit No **12312**

Org. Kit Ref. No 68322655PK10

Application All LRG Series



**Caliper Sensor Cover Repair Kit**

Kaliper Sensör Kapağı Tamir Takımı

SEM Kit No **12500**

Org. Kit Ref. No --

Application --



**Caliper Lever**

Kaliper Masura Bilya Yatağı

SEM Kit No **12501**

Org. Kit Ref. No --

Application --



**Caliper Lever**

Kaliper Masura Bilya Yatağı

SEM Kit No **12502**

Org. Kit Ref. No --

Application EX 225



**Caliper Lever**

Kaliper Masura Bilya Yatağı

SEM Kit No **12503**

Org. Kit Ref. No --

Application --



**Caliper Lever**

Kaliper Masura Bilya Yatağı

SEM Kit No **12504**

Org. Kit Ref. No --

Application EX 225



**Caliper Carrier 19,5"**

Kaliper Taşıyıcı 19,5"

SEM Kit No **12505**

Org. Kit Ref. No 51K

Application EX 195

**Caliper Carrier 22,5"**

Kaliper Taşıyıcı 22,5"

SEM Kit No **12506**

Org. Kit Ref. No --

Application EX 225





# **C LISA** **D LISA**

Type Caliper Repair Kits

# C LISA

Type Caliper



# D LISA

Type Caliper

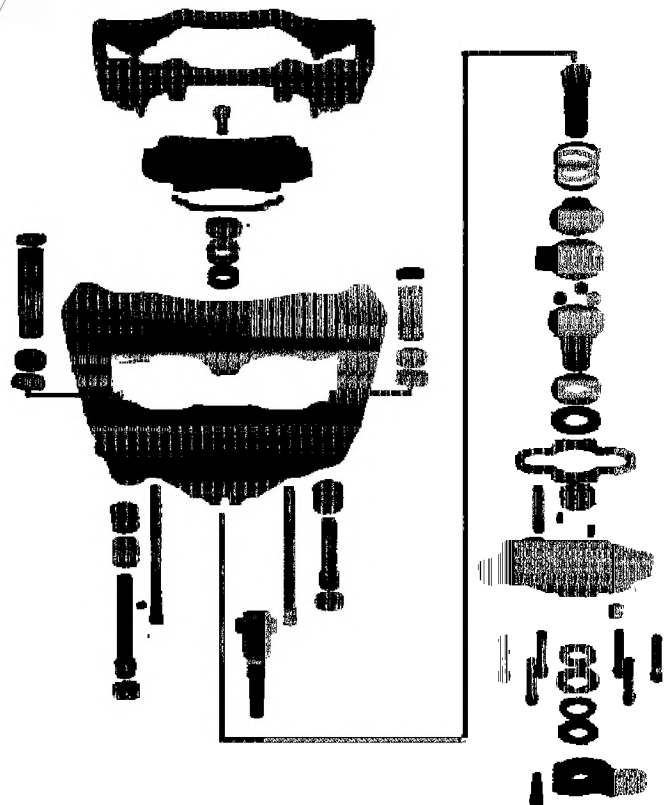

LISA SERIES CALIPERS LRG548/549/550/551/554/555/564/565/592/593/594/595/630/631		AXLE // AKS		SEM REPAIR KITS/ /SEM Tamir Takımları
Vehicles // Araçlar	Models // Modeller	Left // Sol	Right // Sağ	
DENNIS	Javelin MK 111 (95+) Front Axle	LRG550	LRG551	12507
	Elite (02+)	LRG630	LRG631	
	Sabre Fire Engine (95+) Front Axle	LRG550	LRG551	12511
IRISBUS	Agora (97+) Front Axle	LRG548	LRG549	
MCI	E - Series Renaissance (Rear)	LRG630	LRG631	12512
RVI (RENAULT)	Agora (97+) Front Axle	LRG548	LRG549	
	Magnum AE (97 to 00) Premium AE (97 to 00)	LRG548	LRG549	12513
	Midliner M250	LRG554	LRG555	12514
VOLVO	B7L, B10B, B10BLE, B10L, B10LE Olympi B9TL, B7LA, B7RLE, B9SALE, B12BLE	LRG592	LRG593	

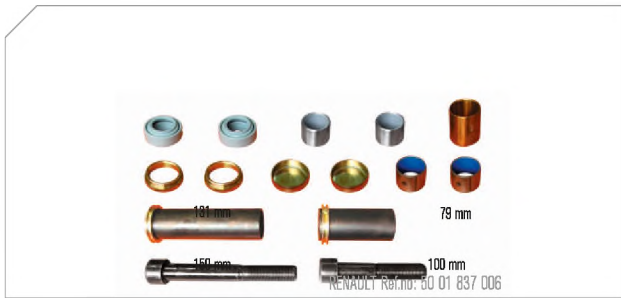

### Caliper Guides & Seals Repair Kit

Kaliper Mil & Keçe Tamir Takımı

SEM Kit No **12507**

Org. Kit Ref. No SJ 4076 • MAN Ref.no: 5001 837 006

Application D LISA, LRG 548, 549, 550, 551, 564, 565, 592, 593, 630, 631



### Caliper Guides & Seals Repair Kit

Kaliper Mil & Keçe Tamir Takımı

SEM Kit No **12508**

Org. Kit Ref. No SJ 4021 • VOLVO Ref.no: 8550881

Application D LISA



### Caliper Tappet Dust Cover

Kaliper Toz Lastiği

SEM Kit No **12509**

Org. Kit Ref. No SJ4053

Application LISA



### Caliper Tappet Dust Cover

Kaliper Toz Lastiği

SEM Kit No **12510**

Org. Kit Ref. No SJ4052

Application C LISA

**Caliper Gear Small (Left)**

Kaliper Dişlisi Küçük (Sol)

SEM Kit No **12511**

Org. Kit Ref. No SJ 4074

Application LRG 548, 550, 554, 564, 592, 630

**Caliper Gear Small (Right)**

Kaliper Dişlisi Küçük (Sağ)

SEM Kit No **12512**

Org. Kit Ref. No SJ 4074

Application LRG 549, 551, 554, 565, 593, 631

**Caliper Adjusting Mechanism (Left)**

Kaliper Ayar Mekanizması (Sol)

SEM Kit No **12513**

Org. Kit Ref. No SJ 4113

Application LRG 548, 550, 554, 564, 592, 594, 630

**Caliper Adjusting Mechanism (Right)**

Kaliper Ayar Mekanizması (Sağ)

SEM Kit No **12514**

Org. Kit Ref. No SJ4114

Application LRG 549, 551, 554, 565, 593, 631

**Caliper Shaft (Left)**

Kaliper Şaft (Sol)

SEM Kit No **12515**

Org. Kit Ref. No

Application LRG 548, 550, 554, 564, 592, 594

**Caliper Shaft (Right)**

Kaliper Şaft (Sağ)

SEM Kit No **12516**

Org. Kit Ref. No

Application LRG 549, 551, 554, 565, 593, 631





**Caliper Shaft Base (Left)**

Kaliper Şaft Karşılığı (Sol)

SEM Kit No **12517**

Org. Kit Ref. No

Application LRG 548, 550, 554, 564, 592, 594



**Caliper Shaft Base (Right)**

Kaliper Şaft Karşılığı (Sağ)

SEM Kit No **12518**

Org. Kit Ref. No

Application LRG 549, 551, 555, 565, 593, 595



**Caliper Operating Shaft (Left)**

Kaliper Kilit Mekanizması (Sol)

SEM Kit No **12519**

Org. Kit Ref. No MCK 1021 / MCK 1151

Application LRG 548, 550, 554, 564, 592, 594



**Caliper Operating Shaft (Right)**

Kaliper Kilit Mekanizması (Sağ)

SEM Kit No **12520**

Org. Kit Ref. No MCK 1022 / MCK 1152

Application LRG 549, 551, 555, 565, 593, 595



**Caliper Need & Roller Bearings**

Kaliper Rulman Takımı

SEM Kit No **12521**

Org. Kit Ref. No SJ 4031

Application LRG 548, 549, 550, 551, 554, 555, 564, 565, 592, 593, 594, 595, 630, 631



**Caliper Boot & Seal Kit**





Kaliper Korumak & Keçe Takımı

SEM Kit No **12522**

Org. Kit Ref. No SJ4061

Application LRG 554, 555, 594, 595



<b>Caliper Boot &amp; Seal Kit</b> Kaliper K�r�k & Kee Takımı	
SEM Kit No	12523
Org. Kit Ref. No	SJ4078
Application	LRG 548, 549, 550, 551
<b>Caliper Tappet Dust Cover</b> Kaliper Toz Lastiđi	
SEM Kit No	12524
Org. Kit Ref. No	SJ4077
Application	LISA
<b>Caliper Boot &amp; Seal Kit</b> Kaliper K�r�k & Kee Takımı	
SEM Kit No	12525
Org. Kit Ref. No	SJ4032
Application	C LISA, D LISA
<b>Caliper Push Plate</b> Kaliper Balata Tutucu	
SEM Kit No	12526
Org. Kit Ref. No	--
Application	--
<b>Caliper Carrier 22,5"</b> Kaliper Tařıyıcı 22,5"	
SEM Kit No	12506
Org. Kit Ref. No	--
Application	D LISA







**10.0" / 17.5"**  
**19.5" / 22.5"**  
**MAXX 22**

Type Caliper Repair Kits

**Caliper Guides & Seals Repair Kit//Kaliper Mil & Keçe Tamir Tk.**

SEM Kit No	12527
Org. Kit Ref.No	W 12 999 729
Application	--

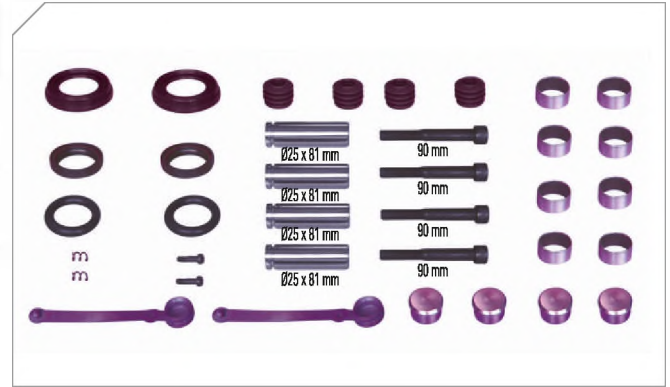



# 17.5"

## Type Caliper Repair Kits

# 17.5'' Type Caliper

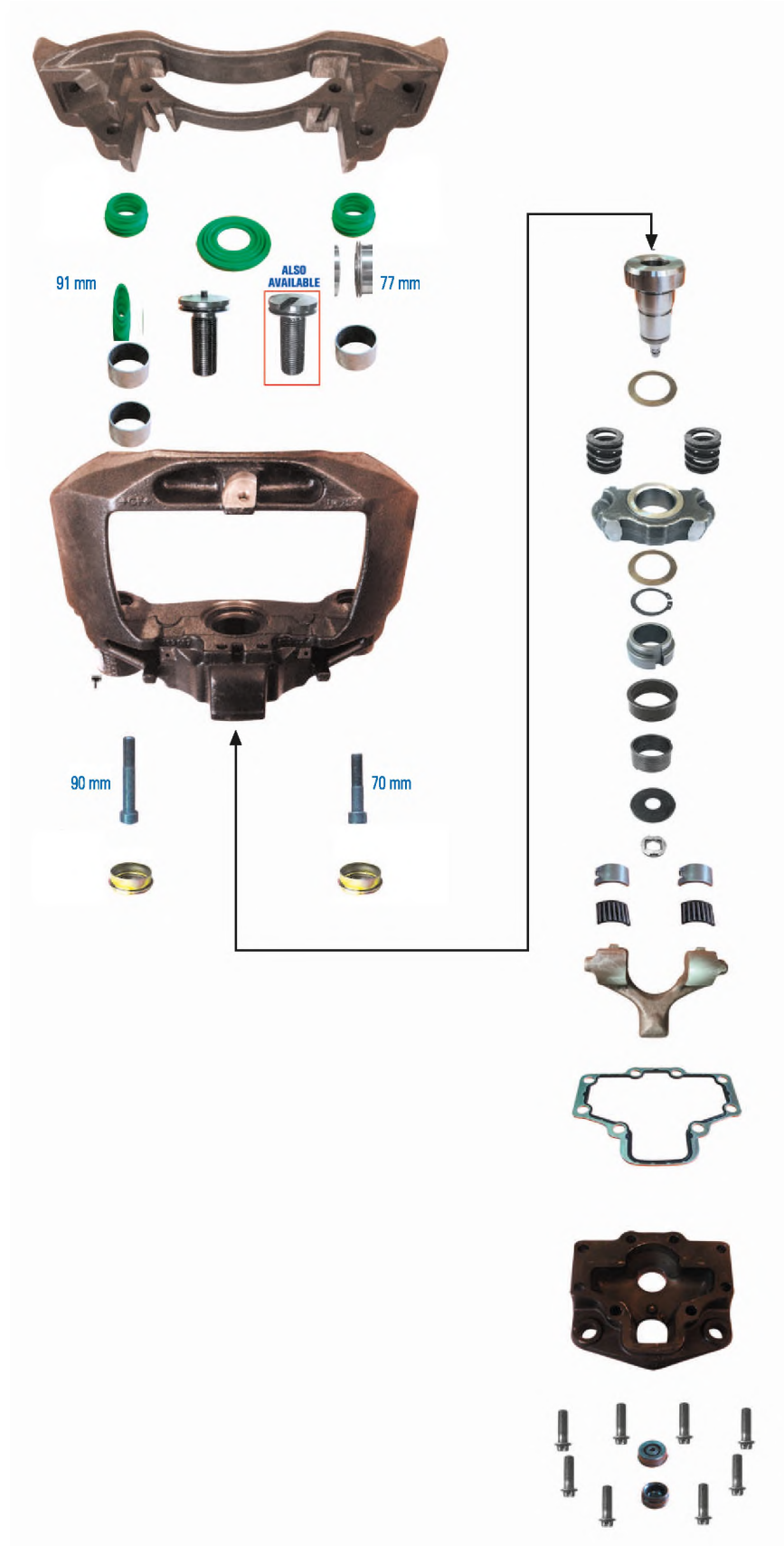

17.5" TYPE CALIPERS		AXLE // AKS		SEM REPAIR KITS/ /SEM Tamir Takımları		
Vehicles // Araçlar	Models // Modeller	Left // Sol	Right // Sağ			
DAF - LEYLAND	LF 45 (11.00+)	40 175 070	40 175 071	10768	12546	10771
IVECO	LKW Eurocargo (120 EL)	40 175 058	40 175 059	10775	12529	12549
MAN	L2000 (Types 6.153 to 11.153) M2000	40 175 051	40 175 052	10769	12547	12542
RVI (Renault)	- Midlum M112	40 175 062	40 175 063	10776	12530	12550
				12528	12548	12543

**Caliper Guides & Seals Repair Kit**  
Kaliper Mil & Keçe Tamir Takımı

SEM Kit No **10768**

Org. Kit Ref. No 12 999 699

Application 40 175 025, 026, 027, 028, 049, 050, 051, 056, 057, 058, 059, 060, 061, 062, 063, 064, 065, 069, 070, 071, 072, 073, 078, 079, 080, 081, 090, 091



**Caliper Seals & Boots Repair Kit**  
Kaliper Keçe & Korumak Tamir Takımı

SEM Kit No **10769**

Org. Kit Ref. No 12 999 580 • MAN Ref.no: 81508226003

Application 40 175 025, 026, 027, 028, 049, 050, 051, 052



**Caliper Seals & Boots Repair Kit**  
Kaliper Keçe & Korumak Tamir Takımı

SEM Kit No **12528**

Org. Kit Ref. No 12 999 704

Application 40 175 062, 40 175 063, 40 175 064, 40 175 065

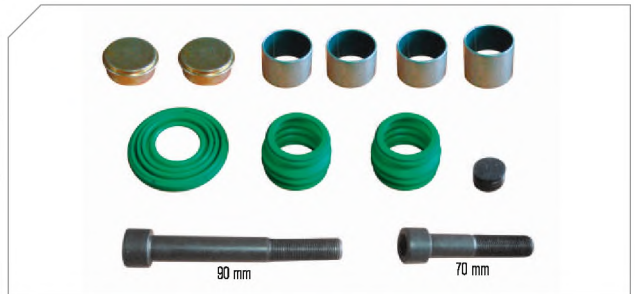

**Caliper Seals & Boots Repair Kit**  
Kaliper Keçe & Korumak Tamir Takımı

SEM Kit No **12529**

Org. Kit Ref. No --

Application 40 175 051, 40 175 052, 40 175 070, 40 175 071



**Caliper Guides & Screws Repair Kit**  
Kaliper Mil & Civata Tamir Takımı

SEM Kit No **12530**

Org. Kit Ref. No --

Application 40 175 051, 40 175 052, 40 175 070, 071

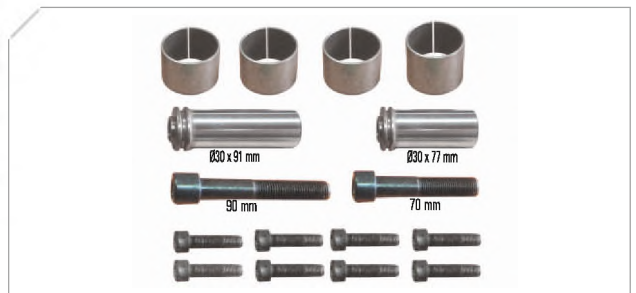

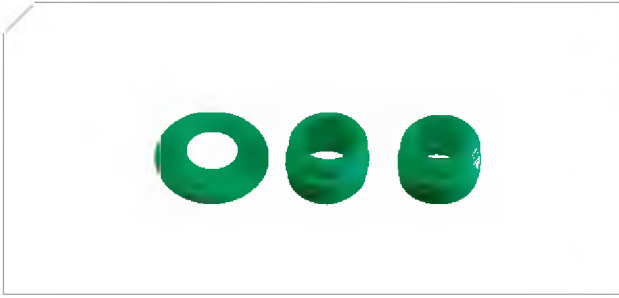

**Caliper Seals & Boots Repair Kit**

Kaliper Keçe & K r k Tamir Takımı

SEM Kit No **12531**

Org. Kit Ref. No --

Application 40 175 051, 40 175 052, 40 175 070, 071



**Caliper Seals & Boots Repair Kit**

Kaliper Keçe & K r k Tamir Takımı

SEM Kit No **12532**

Org. Kit Ref. No --

Application 40 175 051, 40 175 052, 40 175 070, 071



**Caliper Seals & Boots Repair Kit**

Kaliper Keçe & K r k Tamir Takımı

SEM Kit No **12533**

Org. Kit Ref. No 640 175 920.2

Application --



**Caliper Adjusting Mechanism (New Model)**

Kaliper Ayar Mekanizması (Yeni Model)

SEM Kit No **10771**

Org. Kit Ref. No --

Application --



**Caliper Adjusting Mechanism (Eski Model)**

Kaliper Ayar Mekanizması (Eski Model)

SEM Kit No **10772**

Org. Kit Ref. No --

Application --



**Caliper Adjusting Mechanism (New Model-Slotted)**

Kaliper Ayar Mekanizması (Yeni Model-Yarıklı)

SEM Kit No **10773**

Org. Kit Ref. No --

Application --



<p><b>Caliper Adjusting Mechanism (Old Model-Slotted)</b> Kaliper Ayar Mekanizması (Eski Model-Yarıklı)</p> <p>SEM Kit No <b>10774</b></p> <p>Org. Kit Ref. No --</p> <p>Application --</p>	
<p><b>Caliper Adjusting Mechanism (New Model-with Pin)</b> Kaliper Ayar Mekanizması (Yeni Model-Pimli)</p> <p>SEM Kit No <b>12534</b></p> <p>Org. Kit Ref. No --</p> <p>Application --</p>	
<p><b>Caliper Adjusting Mechanism (Old Model-with Pin)</b> Kaliper Ayar Mekanizması (Eski Model-Pimli)</p> <p>SEM Kit No <b>12535</b></p> <p>Org. Kit Ref. No --</p> <p>Application --</p>	
<p><b>Caliper Adjusting Mechanism (Old Model-Slotted)</b> Kaliper Ayar Mekanizması (Eski Model-Yarıklı)</p> <p>SEM Kit No <b>12536</b></p> <p>Org. Kit Ref. No --</p> <p>Application --</p>	
<p><b>Caliper Adjusting Mechanism (New Model-Slotted)</b> Kaliper Ayar Mekanizması (Yeni Model-Yarıklı)</p> <p>SEM Kit No <b>12537</b></p> <p>Org. Kit Ref. No --</p> <p>Application --</p>	
<p><b>Caliper Adjusting Mechanism with Guides &amp; Boots Repair Kit (with Pin)</b> Kaliper Ayar Mekanizması ve Mil &amp; Korumak Tamir Takımı (Pimli)</p> <p>SEM Kit No <b>12538</b></p> <p>Org. Kit Ref. No --</p> <p>Application 17,5"</p>	



**Caliper Adjusting Mechanism with Guides & Boots Repair Kit (with Pin)**  
Kaliper Ayar Mekanizması ve Mil & Korumak Tamir Takımı (Pimli)

SEM Kit No **12539**

Org. Kit Ref. No --

Application 17,5"



**Caliper Adjusting Mechanism with Guides & Boots Repair Kit (Slotted)**  
Kaliper Ayar Mekanizması ve Mil & Korumak Tamir Takımı (Yarıklı)

SEM Kit No **12540**

Org. Kit Ref. No --

Application 17,5"



**Caliper Adjusting Mechanism with Guides & Boots Repair Kit (Slotted)**  
Kaliper Ayar Mekanizması ve Mil & Korumak Tamir Takımı (Yarıklı)

SEM Kit No **12541**

Org. Kit Ref. No --

Application 17,5"



**Caliper Calibration Bolt (With Pin)**  
Kaliper Ayar Civatası (Pimli)

SEM Kit No **12542**

Org. Kit Ref. No --

Application All Models



**Caliper Calibration Bolt (Slotted)**  
Kaliper Ayar Civatası (Yarıklı)

SEM Kit No **12543**

Org. Kit Ref. No --

Application All Models



**Caliper Calibration Bolt (With Pin)**  
Kaliper Ayar Civatası (Pimli)

SEM Kit No **12544**

Org. Kit Ref. No --

Application All Models

<b>Caliper Calibration Bolt (Slotted)</b> Kaliper Ayar Civatası (Yarıklı)	
SEM Kit No	12545
Org. Kit Ref. No	--
Application	All Models



<b>Caliper Roller Bearings</b> Kaliper Rulmanları	
SEM Kit No	10775
Org. Kit Ref. No	--
Application	40.160..., 40.175...,40.195...

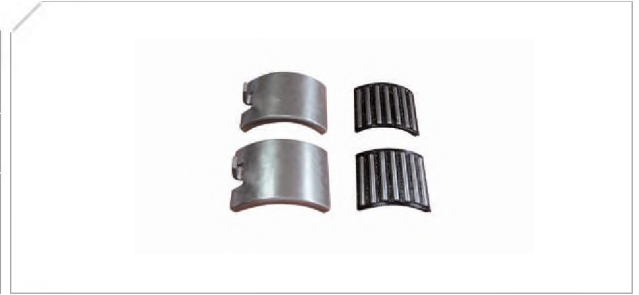

<b>Caliper Lever &amp; Pin Repair Kit</b> Kaliper Masura Bilya Yatağı Repair Kit	
SEM Kit No	10776
Org. Kit Ref. No	--
Application	40.160..., 40.175...,40.195...



<b>Caliper Joint &amp; Seals Repair Kit</b> Kaliper Conta & Keçeleri Tamir Takımı	
SEM Kit No	12546
Org. Kit Ref. No	--
Application	40.160..., 40.175...,40.195...



<b>Caliper Push Plate Slotted (Left)</b> Kaliper Balata Tutucusu Yarıklı (Sol)	
SEM Kit No	12547
Org. Kit Ref. No	--
Application	40 175 051, 40 175 070, 40 195 036



<b>Caliper Push Plate Slotted (Right)</b> Kaliper Balata Tutucusu Yarıklı (Sağ)	
SEM Kit No	12548
Org. Kit Ref. No	--
Application	40 175 052, 40 175 071





**Caliper Push Plate with Pin (Left)**

Kaliper Balata Tutucusu Pimli (Sol)

SEM Kit No **12549**

Org. Kit Ref. No --

Application --



**Caliper Push Plate with Pin (Right)**

Kaliper Balata Tutucusu Pimli (Sağ)

SEM Kit No **12550**

Org. Kit Ref. No --

Application --



**Caliper Spring Kitt**

Kaliper Yay Kiti

SEM Kit No **12551**

Org. Kit Ref. No --

Application All Models

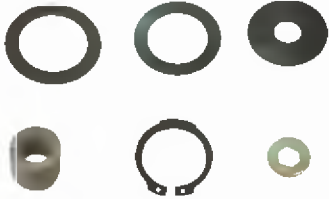

**Caliper Adjusting Mechanism Clutch System Repair Kit**

Kaliper Ayar Mekanizması Tamir Takımı

SEM Kit No **12552**

Org. Kit Ref. No --

Application All Models



**Caliper Adjusting Mechanism Housing (Thick)**

Kaliper Ayar Mekanizması Yatağı (Kalın)

SEM Kit No **12553**

Org. Kit Ref. No --

Application --



**Caliper Adjusting Mechanism Housing (Thin)**

Kaliper Ayar Mekanizması Yatağı (İnce)

SEM Kit No **12554**

Org. Kit Ref. No --

Application --

**Caliper Adjusting Mechanism Housing (Thick) 80.4mm Pin**

Kaliper Ayar Mekanizması Yatağı (Kalın) 80.4mm/114mm Pimli

SEM Kit No **12555**

Org. Kit Ref. No --

Application --

**Caliper Adjusting Mechanism Housing (Thick) 80.4mm Slotted**

Kaliper Ayar Mekanizması Yatağı (Kalın) 80.4mm/114mm Yarıklı

SEM Kit No **12556**

Org. Kit Ref. No --

Application --

**Caliper Adjusting Mechanism Housing (Thin) 76mm Pin**

Kaliper Ayar Mekanizması Yatağı (İnce) 76mm/109mm Pimli

SEM Kit No **12557**

Org. Kit Ref. No --

Application --

**Caliper Adjusting Mechanism Housing (Thin) 76mm Slotted**

Kaliper Ayar Mekanizması Yatağı (İnce) 76mm/109mm Yarıklı

SEM Kit No **12558**

Org. Kit Ref. No --

Application --





**19.5"**  
**(Single Piston)**  
Type Caliper Repair Kits

# 19.5" (Single Piston) Type Caliper





19.5" TYPE CALIPERS		AXLE // AKS		SEM REPAIR KITS/ /SEM Tamir Takımları
Vehicles // Araçlar	Models // Modeller	Left // Sol	Right // Sağ	
DAF - LEYLAND	LF 55 (12 to Ton) (00 to 03)	40 195 007	40 195 008	12559 10771 10776 10766 12542 12546 10767 12543 12573 12560 10775 12574
	LF 55 (12 to Ton) (03+)	40 195 043	40 195 044	
SAF	19" Wheels, Front Axle	40 195 017	40 195 018	
		40 195 037	40 195 038	

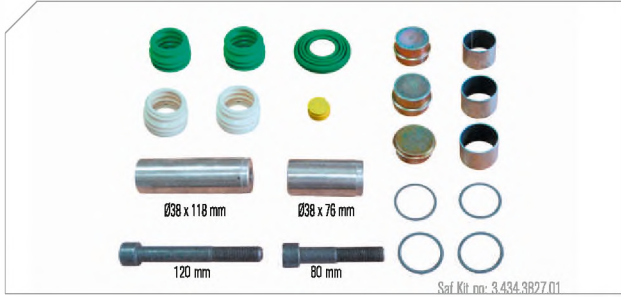

### Caliper Guides & Seals Repair Kit

Kaliper Mil & Keçe Tamir Takımı

SEM Kit No **12559**

Org. Kit Ref. No

Application

40 195 001, 40 195 002, 40 195 003, 40 195 004, 40 195 015, 40 195 024  
40 195 017, 40 195 020, 40 195 027, 40 195 030, 40 195 035, 40 195 038  
40 195 043, 40 195 044, 40 225 007, 40 225 008, 40 225 015, 40 225 016

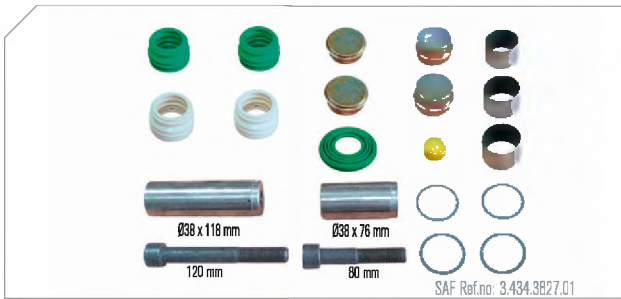

### Caliper Guides & Seals Repair Kit

Kaliper Mil & Keçe Tamir Takımı

SEM Kit No **10766**

Org. Kit Ref. No 12 999 738

Application

40 195 001, 40 195 002, 40 195 003, 40 195 004, 40 195 015, 40 195 024  
40 195 017, 40 195 020, 40 195 027, 40 195 030, 40 195 035, 40 195 038  
40 195 043, 40 195 044, 40 225 007, 40 225 008, 40 225 015, 40 225 016



### Caliper Guides & Seals Repair Kit

Kaliper Mil & Keçe Tamir Takımı

SEM Kit No **10767**

Org. Kit Ref. No 12 999 776

Application

40 195 017, 40 195 020, 40 195 027, 40 195 030, 40 195 035, 40 195 038  
40 195 043, 40 195 044, 40 225 007, 40 225 008, 40 225 015, 40 225 016



### Caliper Boots & Caps Repair Kit

Kaliper Koruk & Kapları Tamir Takımı

SEM Kit No **12560**

Org. Kit Ref. No --

Application

40 195 ..., 40 225 ...

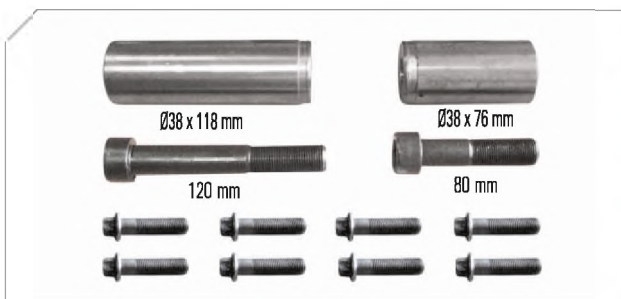

### Caliper Guides & Screws Repair Kit

Kaliper Mil & Civata Tamir Takımı

SEM Kit No **12561**

Org. Kit Ref. No --

Application

40 195 ...

<b>Caliper Tappet Cover Repair Kit</b> Kaliper Toz K�r�g� Tamir Takımı	
SEM Kit No	<b>12562</b>
Org. Kit Ref. No	--
Application	40 195 001, 40 195 002, 40 195 003, 40 195 004



<b>Caliper Tappet Cover Repair Kit</b> Kaliper Toz K�r�g� Tamir Takımı	
SEM Kit No	<b>12563</b>
Org. Kit Ref. No	
Application	All 17,5"



<b>Caliper Guides &amp; Seals Repair Kit</b> Kaliper Mil & Kee Tamir Takımı	
SEM Kit No	<b>12564</b>
Org. Kit Ref. No	12 999 746
Application	40 195 001, 40 195 002, 40 195 003, 40 195 004



<b>Caliper Seals &amp; Boots Repair Kit</b> Kaliper Kee & K�r�k Tamir Takımı	
SEM Kit No	<b>12532</b>
Org. Kit Ref. No	
Application	40 175 051, 40 175 052, 40 175 070, 40 175 071



<b>Caliper Seals &amp; Boots Repair Kit</b> Kaliper Kee & K�r�k Tamir Takımı	
SEM Kit No	<b>12533</b>
Org. Kit Ref. No	640 175 920.2
Application	--



<b>Caliper Adjusting Mechanism (New Model)</b> Kaliper Ayar Mekanizması (Yeni Model)	
SEM Kit No	<b>10771</b>
Org. Kit Ref. No	--
Application	--





**Caliper Adjusting Mechanism (Eski Model)**

Kaliper Ayar Mekanizması (Eski Model)

SEM Kit No **10772**

Org. Kit Ref. No --

Application --



**Caliper Adjusting Mechanism (New Model-Slotted)**

Kaliper Ayar Mekanizması (Yeni Model-Yarıklı)

SEM Kit No **10773**

Org. Kit Ref. No --

Application --



**Caliper Adjusting Mechanism (Old Model-Slotted)**

Kaliper Ayar Mekanizması (Eski Model-Yarıklı)

SEM Kit No **10774**

Org. Kit Ref. No --

Application --



**Caliper Adjusting Mechanism (New Model-with Pin)**

Kaliper Ayar Mekanizması (Yeni Model-Pimli)

SEM Kit No **12534**

Org. Kit Ref. No --

Application --



**Caliper Adjusting Mechanism (Old Model-with Pin)**

Kaliper Ayar Mekanizması (Eski Model-Pimli)

SEM Kit No **12535**

Org. Kit Ref. No --

Application --



**Caliper Adjusting Mechanism (Old Model-Slotted)**







Kaliper Ayar Mekanizması (Eski Model-Yarıklı)

SEM Kit No **12536**

Org. Kit Ref. No --

Application --



<p><b>Caliper Adjusting Mechanism (New Model-Slotted)</b> Kaliper Ayar Mekanizması (Yeni Model-Yarıklı)</p> <p>SEM Kit No <b>12537</b></p> <p>Org. Kit Ref. No --</p> <p>Application --</p>	
<p><b>Caliper Adjusting Mechanism with Guides &amp; Boots Repair Kit (with Pin)</b> Kaliper Ayar Mekanizması ve Mil &amp; Korumak Tamir Takımı (Pimli)</p> <p>SEM Kit No <b>12565</b></p> <p>Org. Kit Ref. No --</p> <p>Application 19,5", 22,5"</p>	
<p><b>Caliper Adjusting Mechanism with Guides &amp; Boots Repair Kit (with Pin)</b> Kaliper Ayar Mekanizması ve Mil &amp; Korumak Tamir Takımı (Pimli)</p> <p>SEM Kit No <b>12566</b></p> <p>Org. Kit Ref. No --</p> <p>Application 19,5", 22,5"</p>	
<p><b>Caliper Adjusting Mechanism with Guides &amp; Boots Repair Kit (Slotted)</b> Kaliper Ayar Mekanizması ve Mil &amp; Korumak Tamir Takımı (Yarıklı)</p> <p>SEM Kit No <b>12567</b></p> <p>Org. Kit Ref. No --</p> <p>Application 19,5", 22,5"</p>	
<p><b>Caliper Adjusting Mechanism with Guides &amp; Boots Repair Kit (Slotted)</b> Kaliper Ayar Mekanizması ve Mil &amp; Korumak Tamir Takımı (Yarıklı)</p> <p>SEM Kit No <b>12568</b></p> <p>Org. Kit Ref. No --</p> <p>Application 19,5", 22,5"</p>	
<p><b>Caliper Calibration Bolt (With Pin)</b> Kaliper Ayar Civatası (Pimli)</p> <p>SEM Kit No <b>12542</b></p> <p>Org. Kit Ref. No --</p> <p>Application All Models</p>	



**Caliper Calibration Bolt (Slotted)**

Kaliper Ayar Civatası (Yarıklı)

SEM Kit No **12543**

Org. Kit Ref. No --

Application All Models



**Caliper Calibration Bolt (With Pin)**

Kaliper Ayar Civatası (Pimli)

SEM Kit No **12544**

Org. Kit Ref. No --

Application All Models



**Caliper Calibration Bolt (Slotted)**

Kaliper Ayar Civatası (Yarıklı)

SEM Kit No **12545**

Org. Kit Ref. No --

Application All Models



**Caliper Roller Bearings**

Kaliper Rulmanları

SEM Kit No **10775**

Org. Kit Ref. No

Application 40.160..., 40.175...,40.195...

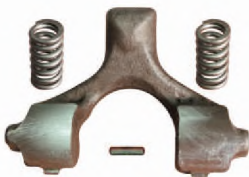

**Caliper Lever & Pin Repair Kit**

Kaliper Masura Bilya Yatağı Repair Kit

SEM Kit No **10776**

Org. Kit Ref. No --

Application 40.160..., 40.175...,40.195...



**Caliper Joint & Seals Repair Kit**

Kaliper Conta & Keçeleri Tamir Takımı

SEM Kit No **12546**

Org. Kit Ref. No --

Application 40.160..., 40.175...,40.195...

<b>Caliper Tappet Cover Repair Kit</b> Kaliper Toz K�r�g� Tamir Takımı	
SEM Kit No	12569
Org. Kit Ref. No	
Application	All 19,5", 22,5"



<b>Caliper Tappet Cover Repair Kit</b> Kaliper Toz K�r�g� Tamir Takımı	
SEM Kit No	12570
Org. Kit Ref. No	
Application	--



<b>Caliper Tappet Cover Repair Kit</b> Kaliper Toz K�r�g� Tamir Takımı	
SEM Kit No	12571
Org. Kit Ref. No	
Application	--



<b>Caliper Tappet Cover Repair Kit</b> Kaliper Toz K�r�g� Tamir Takımı	
SEM Kit No	12572
Org. Kit Ref. No	
Application	--



<b>Caliper Push Plate (Left)</b> Kaliper Balata Tutucusu (Sol)	
SEM Kit No	12573
Org. Kit Ref. No	
Application	40 195 002, 40 195 018, 40 195 015, 40 195 037



<b>Caliper Push Plate (Right)</b> Kaliper Balata Tutucusu (Sağ)	
SEM Kit No	12574
Org. Kit Ref. No	
Application	40 195 001, 40 195 017, 40 195 038





**Caliper Push Plate (Left)**

Kaliper Balata Tutucusu (Sol)

SEM Kit No **12575**

Org. Kit Ref. No

Application --



**Caliper Push Plate (Right)**

Kaliper Balata Tutucusu (Sağ)

SEM Kit No **12576**

Org. Kit Ref. No

Application --



**Caliper Spring Kit**

Kaliper Yay Kiti

SEM Kit No **12551**

Org. Kit Ref. No --

Application All Models

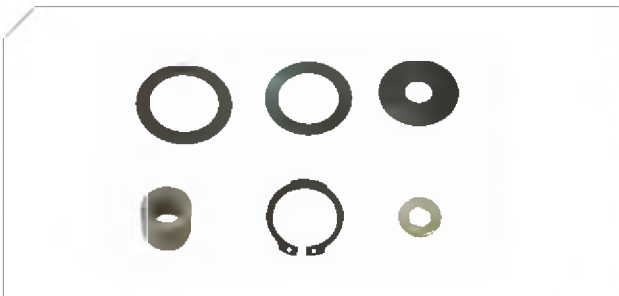

**Caliper Adjusting Mechanism Clutch System Repair Kit**

Kaliper Ayar Mekanizması Tamir Takımı

SEM Kit No **12552**

Org. Kit Ref. No --

Application All Models

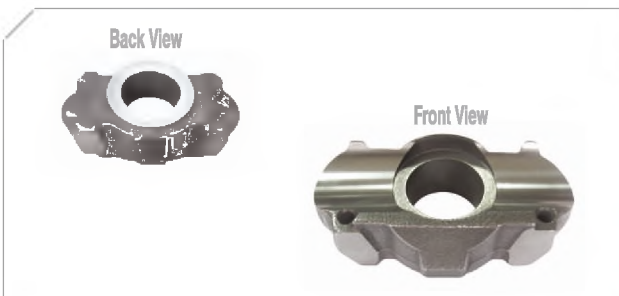

**Caliper Adjusting Mechanism Housing (Thick)**

Kaliper Ayar Mekanizması Yatağı (Kalın)

SEM Kit No **12553**

Org. Kit Ref. No --

Application --



**Caliper Adjusting Mechanism Housing (Thin)**

Kaliper Ayar Mekanizması Yatağı (İnce)

SEM Kit No **12554**

Org. Kit Ref. No --

Application --



**Caliper Adjusting Mechanism Housing (Thick 80.4mm Pin)**

Kaliper Ayar Mekanizması Yatağı (Kalın) 80.4mm/114mm Pimli

SEM Kit No **12555**

Org. Kit Ref. No --

Application --

**Caliper Adjusting Mechanism Housing (Thick 80.4mm Slotted)**

Kaliper Ayar Mekanizması Yatağı (Kalın) 80.4mm/114mm Yarıklı

SEM Kit No **12556**

Org. Kit Ref. No --

Application --

**Caliper Adjusting Mechanism Housing (Thin 76mm Pin)**

Kaliper Ayar Mekanizması Yatağı (İnce) 76mm/109mm Pimli

SEM Kit No **12557**

Org. Kit Ref. No --

Application --

**Caliper Adjusting Mechanism Housing (Thin 76mm Slotted)**

Kaliper Ayar Mekanizması Yatağı (İnce) 76mm/109mm Yarıklı

SEM Kit No **12558**

Org. Kit Ref. No --

Application --





**19.5" / 22.5"**  
**(Double Piston)**

Type Caliper Repair Kits

# 19.5" / 22.5 (Double Piston) Type Caliper

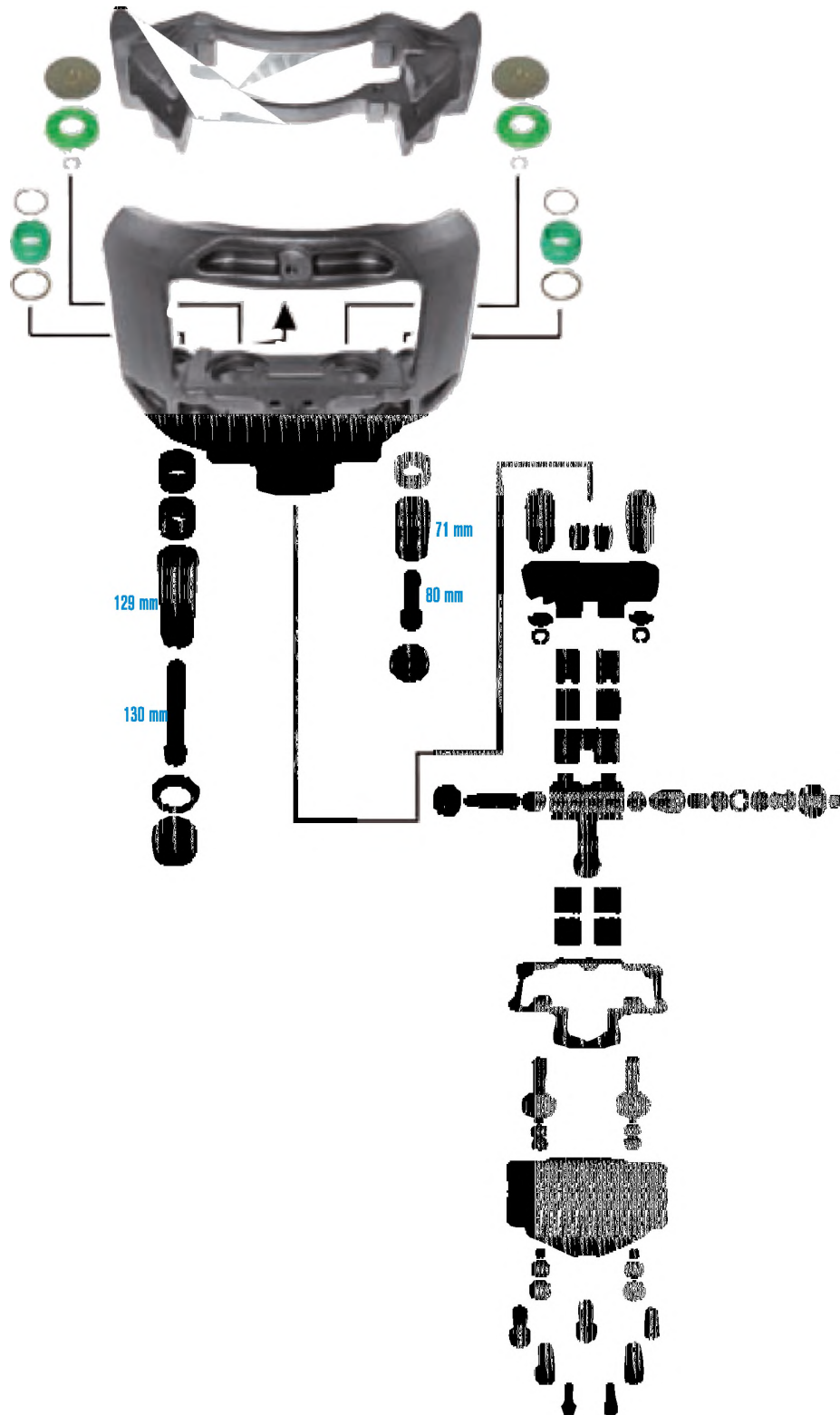

		AXLE // AKS		SEM REPAIR KITS/ /SEM Tamir Takımları
Vehicles // Araçlar	Models // Modeller	Left // Sol	Right // Sağ	
RVI (Renault)	Midlum	40 195 021	40 195 022	



### Caliper Guides & Seals Repair Kit

Kaliper Mil & Keçe Tamir Takımı

SEM Kit No **12564**

Org. Kit Ref. No 12.999.746

Application 40 195 001, 40 195 002, 40 195 003, 40 195 004, 40 195 021, 40 195 022



### Caliper Guides & Seals Repair Kit

Kaliper Mil & Keçe Tamir Takımı

SEM Kit No **12577**

Org. Kit Ref. No 12 999 678

Application 40 225 003, 40 225 004



### Caliper Tappet & Seals Repair Kit

Kaliper Piston & Keçe Tamir Takımı

SEM Kit No **10770**

Org. Kit Ref. No 12 999 667

Application 40 225 003, 40 225 004

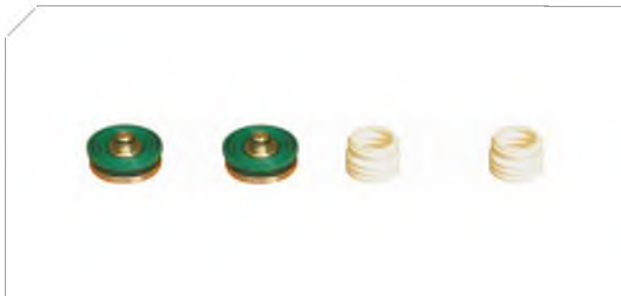

### Caliper Tappet Cover Repair Kit

Kaliper Toz K r ğ  Tamir Takımı

SEM Kit No **12578**

Org. Kit Ref. No --

Application 40 195 001, 40 195 002, 40 195 003, 40 195 004, 40 195 021, 40 195 022



### Caliper Guides & Seals Repair Kit

Kaliper Mil & Keçe Tamir Takımı

SEM Kit No **12579**

Org. Kit Ref. No --

Application 40 195 001, 40 195 002, 40 195 003, 40 195 004, 40 195 021, 40 195 022

<b>Caliper Seals &amp; Boots Repair Kit</b> Kaliper Keçe & K�r�k Tamir Takımı	
SEM Kit No	12532
Org. Kit Ref. No	
Application	40 175 051, 40 175 052, 40 175 070, 40 175 071



<b>Caliper Seals &amp; Boots Repair Kit</b> Kaliper Keçe & K�r�k Tamir Takımı	
SEM Kit No	12533
Org. Kit Ref. No	640 175 920.2
Application	--



<b>Caliper Calibration Bolt (Right)</b> Kaliper Ayar Civatası (Sağ)	
SEM Kit No	12580
Org. Kit Ref. No	--
Application	40 195 021, 40 195 022



<b>Caliper Calibration Bolt (Left)</b> Kaliper Ayar Civatası (Left)	
SEM Kit No	12581
Org. Kit Ref. No	--
Application	40 195 021, 40 195 022



<b>Caliper Calibration Bolt (Right)</b> Kaliper Ayar Civatası (Sağ)	
SEM Kit No	12582
Org. Kit Ref. No	--
Application	40 195 021, 40 195 022



<b>Caliper Calibration Bolt (Left)</b> Kaliper Ayar Civatası (Sol)	
SEM Kit No	12583
Org. Kit Ref. No	--
Application	40 195 021, 40 195 022



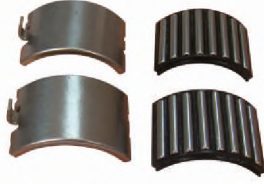

**Caliper Roller Bearings**

Kaliper Rulmanları

SEM Kit No **12584**

Org. Kit Ref. No

Application 40 195 021, 40 195 022

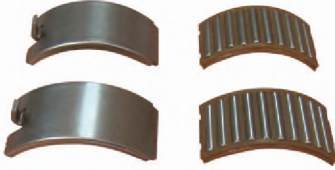

**Caliper Roller Bearings**

Kaliper Rulmanları

SEM Kit No **12585**

Org. Kit Ref. No --

Application 40 195 021, 40 195 022



**Caliper Roller Bearings**

Kaliper Rulmanları

SEM Kit No **12586**

Org. Kit Ref. No --

Application 40 195 021, 40 195 022



**Caliper Joint & Seals Repair Kit**

Kaliper Conta & Keçeleri Tamir Takımı

SEM Kit No **12587**

Org. Kit Ref. No --

Application 40 195 021, 40 195 022



**Caliper Push Plate Slotted (Right)**

Kaliper Balata Tutucusu Yarıklı (Sağ)

SEM Kit No **12588**

Org. Kit Ref. No --

Application 40 195 021, 40 195 022



**Caliper Push Plate Slotted (Right)**

Kaliper Balata Tutucusu Yarıklı (Sağ)

SEM Kit No **12589**

Org. Kit Ref. No --

Application 40 195 021, 40 195 022



<b>Caliper Gear (Left)</b> Kaliper Dişlisi (Sol)	
SEM Kit No	<b>12590</b>
Org. Kit Ref. No	
Application	40 195 021, 40 195 022



<b>Caliper Gear (Right)</b> Kaliper Dişlisi (Sağ)	
SEM Kit No	<b>12591</b>
Org. Kit Ref. No	--
Application	40 195 021, 40 195 022

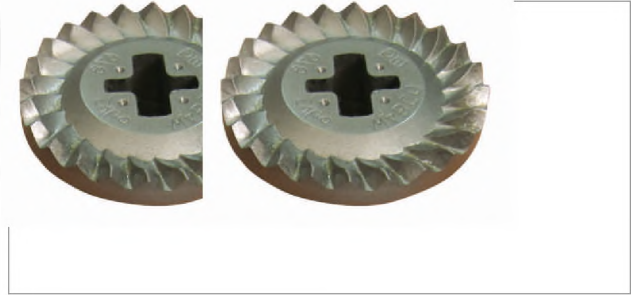

<b>Caliper Adjusting Mechanism Pin</b> Kaliper Ayar Mekanizması Pimi	
SEM Kit No	<b>12592</b>
Org. Kit Ref. No	--
Application	40 195 021, 40 195 022



<b>Caliper Gear Wheel Adjusting Mechanism Repair Kit (Right)</b> Kaliper Ayar Dişlisi Tamir Takımı (Sağ)	
SEM Kit No	<b>12593</b>
Org. Kit Ref. No	--
Application	40 195 021, 40 195 022

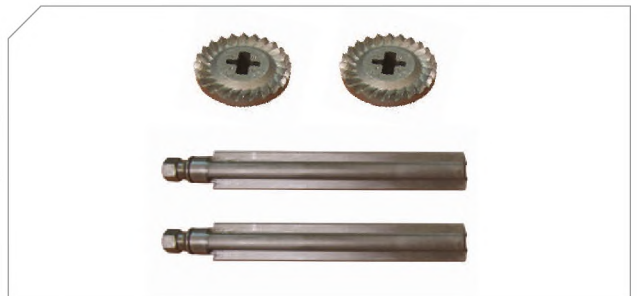

<b>Caliper Gear Wheel Adjusting Mechanism Repair Kit (Left)</b> Kaliper Ayar Dişlisi Tamir Takımı (Sol)	
SEM Kit No	<b>12594</b>
Org. Kit Ref. No	--
Application	40 195 021, 40 195 022

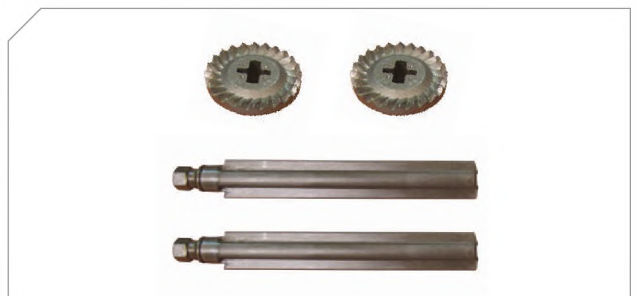

<b>Caliper Gear Wheel Adjusting Mechanism Repair Kit (Right)</b> Kaliper Ayar Dişlisi Tamir Takımı (Sağ)	
SEM Kit No	<b>12595</b>
Org. Kit Ref. No	--
Application	40 195 021, 40 195 022





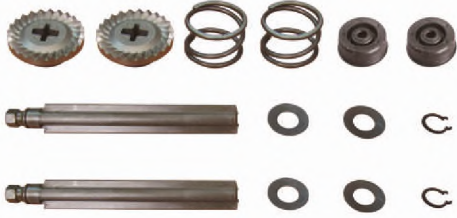

**Caliper Gear Wheel Adjusting Mechanism Repair Kit (Left)**

Kaliper Ayar Dişlisi Tamir Takımı (Sol)

SEM Kit No **12596**

Org. Kit Ref. No

Application 40 195 021, 40 195 022



**Caliper Gear Wheel Adjusting Mechanism Repair Kit**

Kaliper Ayar Dişlisi Tamir Takımı

SEM Kit No **12597**

Org. Kit Ref. No --

Application 40 195 021, 40 195 022

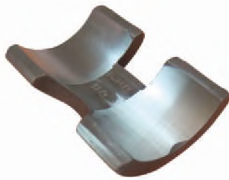

**Caliper Adjusting Mechanism Housing**

Kaliper Ayar Mekanizması Yatağı

SEM Kit No **12598**

Org. Kit Ref. No --

Application 40 195 021, 40 195 022



**Caliper Lever**

kaliper Masura Bilya Yatağı

SEM Kit No **12599**

Org. Kit Ref. No --

Application 40 195 021, 40 195 022



**Caliper Lever**

kaliper Masura Bilya Yatağı

SEM Kit No **12600**

Org. Kit Ref. No --

Application 40 195 021, 40 195 022



**Caliper Lever Repair Kit**

Kaliper Masura Bilya Yatağı Tamir Takımı

SEM Kit No **12601**

Org. Kit Ref. No --

Application 40 195 021, 40 195 022

<b>Caliper Lever Repair Kit</b> Kaliper Masura Bilya Yatađı Tamir Takımı	
SEM Kit No	<b>12602</b>
Org. Kit Ref. No	--
Application	40 195 021, 40 195 022



<b>Caliper Lever</b> kaliper Masura Bilya Yatađı	
SEM Kit No	<b>12603</b>
Org. Kit Ref. No	--
Application	40 195 021, 40 195 022

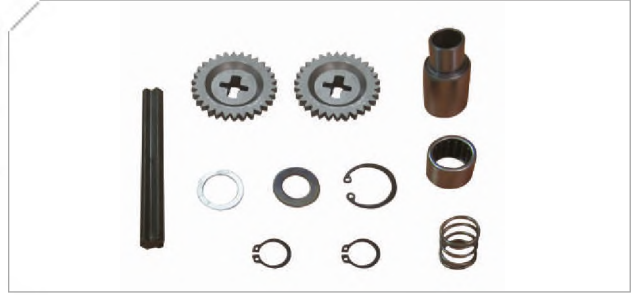

<b>Caliper Lever</b> kaliper Masura Bilya Yatađı	
SEM Kit No	<b>12604</b>
Org. Kit Ref. No	--
Application	40 195 021, 40 195 022

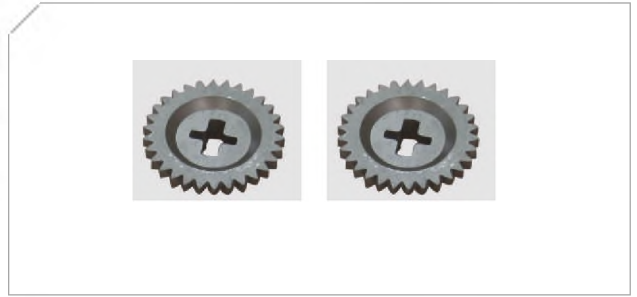

<b>Caliper Lever Repair Kit</b> Kaliper Masura Bilya Yatađı Tamir Takımı	
SEM Kit No	<b>12605</b>
Org. Kit Ref. No	--
Application	40 195 021, 40 195 022





**22.5"**  
Type Caliper Repair Kits

# 22.5" (Double Piston) Type Caliper

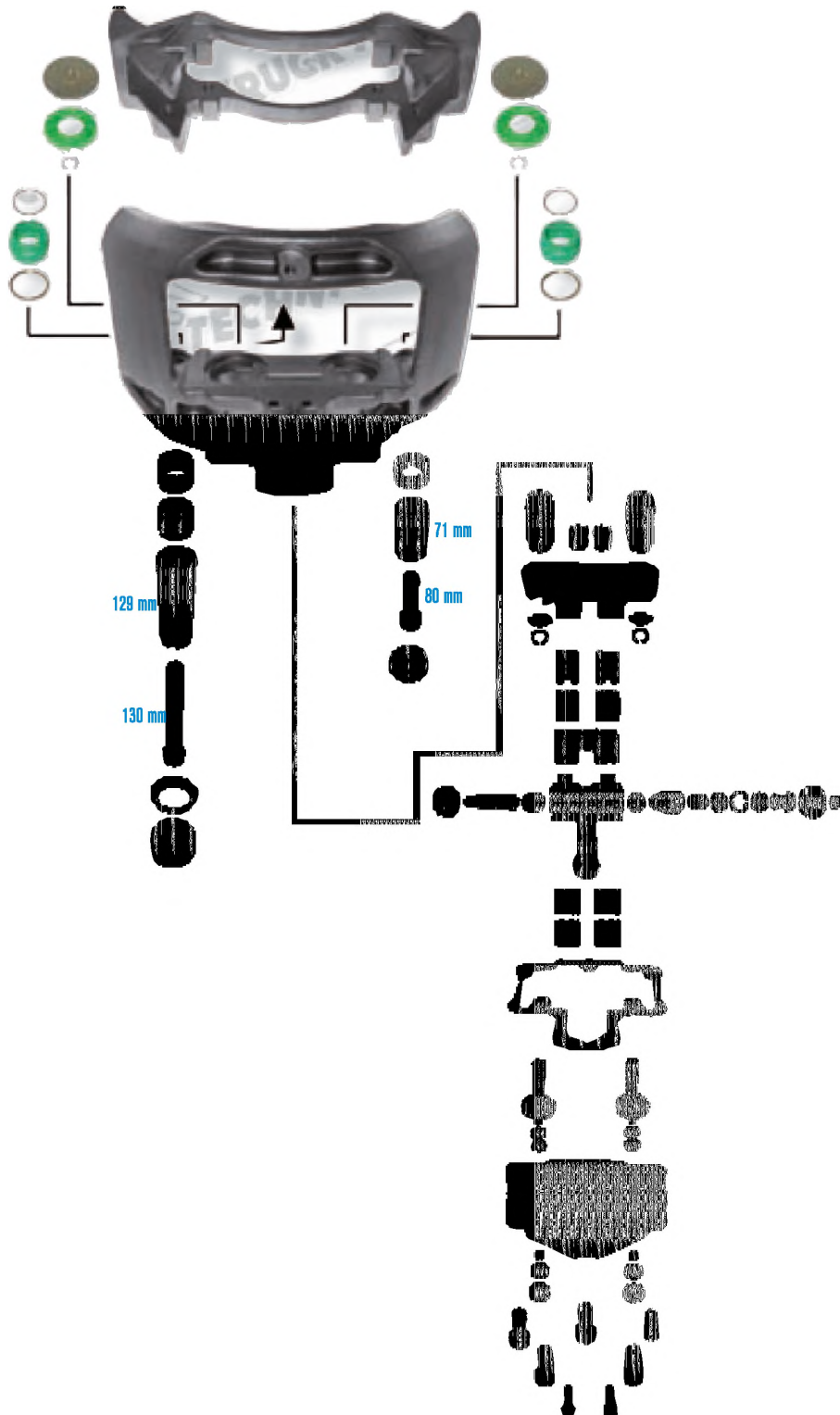

# 22.5" (Single Piston) Type Caliper



22.5 TYPE CALIPERS		AXLE // AKS		SEM REPAIR KITS/ /SEM Tamir Takımları
Vehicles // Araçlar	Models // Modeller	Left // Sol	Right // Sağ	
SAF	22.5" Wheels, 9 Ton, Front Axle	40 225 007	40 225 008	12559 10771 10776 10766 12542 12546 10767 12543 12606 12560 10775 12607
	22.5" Wheels, 11 Ton, Front Axle	40 225 015	40 225 016	
SMB	22.5" Wheels, Front Axle	40 225 003	40 225 004	

Caliper Guides & Seals Repair Kit Kaliper Mil & Keçe Tamir Takımı	
SEM Kit No	<b>12559</b>
Org. Kit Ref. No	
Application	40 195 001, 40 195 002, 40 195 003, 40 195 004, 40 195 015, 40 195 024 40 195 017, 40 195 020, 40 195 027, 40 195 030, 40 195 035, 40 195 038 40 195 043, 40 195 044, 40 225 007, 40 225 008, 40 225 015, 40 225 016

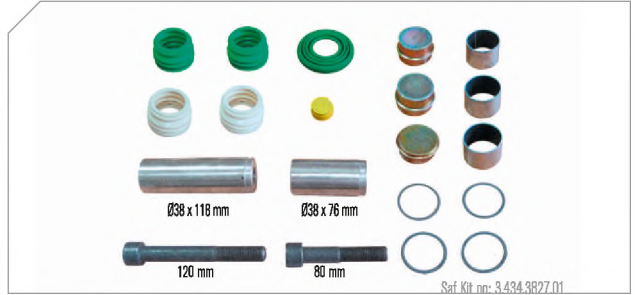

Caliper Guides & Seals Repair Kit Kaliper Mil & Keçe Tamir Takımı	
SEM Kit No	<b>10766</b>
Org. Kit Ref. No	12 999 738
Application	40 195 001, 40 195 002, 40 195 003, 40 195 004, 40 195 015, 40 195 024 40 195 017, 40 195 020, 40 195 027, 40 195 030, 40 195 035, 40 195 038 40 195 043, 40 195 044, 40 225 007, 40 225 008, 40 225 015, 40 225 016



Caliper Guides & Seals Repair Kit Kaliper Mil & Keçe Tamir Takımı	
SEM Kit No	<b>10767</b>
Org. Kit Ref. No	12 999 776
Application	40 195 017, 40 195 020, 40 195 027, 40 195 030, 40 195 035, 40 195 038 40 195 043, 40 195 044, 40 225 007, 40 225 008, 40 225 015, 40 225 016

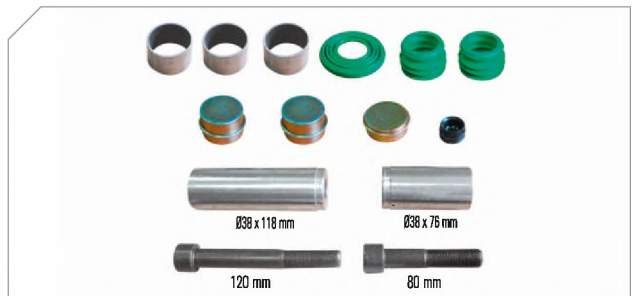

Caliper Boots & Caps Repair Kit Kaliper Korumak & Kapları Tamir Takımı	
SEM Kit No	<b>12560</b>
Org. Kit Ref. No	--
Application	40 195 ..., 40 225 ...



Caliper Guides & Screws Repair Kit Kaliper Mil & Civata Tamir Takımı	
SEM Kit No	<b>12561</b>
Org. Kit Ref. No	--
Application	40 195 ...

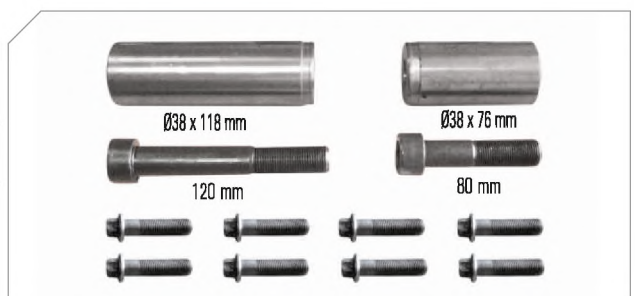





### Caliper Tappet Cover Repair Kit

Kaliper Toz Körüğü Tamir Takımı

SEM Kit No **12562**

Org. Kit Ref. No --

Application 40 195 001, 40 195 002, 40 195 003, 40 195 004



### Caliper Tappet Cover Repair Kit

Kaliper Toz Körüğü Tamir Takımı

SEM Kit No **12563**

Org. Kit Ref. No

Application All 17,5"



### Caliper Guides & Seals Repair Kit

Kaliper Mil & Keçe Tamir Takımı

SEM Kit No **12577**

Org. Kit Ref. No 12 999 678

Application 40 225 003, 40 225 004



### Caliper Tappet & Seals Repair Kit

Kaliper Piston & Keçe Tamir Takımı

SEM Kit No **10770**

Org. Kit Ref. No 12 999 667

Application 40 225 003, 40 225 004



### Caliper Seals & Boots Repair Kit

Kaliper Keçe & Körük Tamir Takımı

SEM Kit No **12532**

Org. Kit Ref. No

Application 40 175 051, 40 175 052, 40 175 070, 40 175 071



### Caliper Seals & Boots Repair Kit

Kaliper Keçe & Körük Tamir Takımı

SEM Kit No **12533**

Org. Kit Ref. No 640 175 920.2

Application --



<b>Caliper Adjusting Mechanism (New Model)</b> Kaliper Ayar Mekanizması (Yeni Model)	
SEM Kit No	<b>10771</b>
Org. Kit Ref. No	--
Application	--



<b>Caliper Adjusting Mechanism (Eski Model)</b> Kaliper Ayar Mekanizması (Eski Model)	
SEM Kit No	<b>10772</b>
Org. Kit Ref. No	--
Application	--



<b>Caliper Adjusting Mechanism (New Model-Slotted)</b> Kaliper Ayar Mekanizması (Yeni Model-Yarıklı)	
SEM Kit No	<b>10773</b>
Org. Kit Ref. No	--
Application	--



<b>Caliper Adjusting Mechanism (Old Model-Slotted)</b> Kaliper Ayar Mekanizması (Eski Model-Yarıklı)	
SEM Kit No	<b>10774</b>
Org. Kit Ref. No	--
Application	--



<b>Caliper Adjusting Mechanism (New Model-with Pin)</b> Kaliper Ayar Mekanizması (Yeni Model-Pimli)	
SEM Kit No	<b>12534</b>
Org. Kit Ref. No	--
Application	--



<b>Caliper Adjusting Mechanism (Old Model-with Pin)</b> Kaliper Ayar Mekanizması (Eski Model-Pimli)	
SEM Kit No	<b>12535</b>
Org. Kit Ref. No	--
Application	--





### Caliper Adjusting Mechanism (Old Model-Slotted)

Kaliper Ayar Mekanizması (Eski Model-Yarıklı)

SEM Kit No **12536**

Org. Kit Ref. No --

Application --



### Caliper Adjusting Mechanism (New Model-Slotted)

Kaliper Ayar Mekanizması (Yeni Model-Yarıklı)

SEM Kit No **12537**

Org. Kit Ref. No --

Application --



### Caliper Adjusting Mechanism with Guides & Boots Repair Kit (with Pin)

Kaliper Ayar Mekanizması ve Mil & Koruk Tamir Takımı (Pimli)

SEM Kit No **12565**

Org. Kit Ref. No --

Application 19,5", 22,5"



### Caliper Adjusting Mechanism with Guides & Boots Repair Kit (with Pin)

Kaliper Ayar Mekanizması ve Mil & Koruk Tamir Takımı (Pimli)

SEM Kit No **12566**

Org. Kit Ref. No --

Application 19,5", 22,5"



### Caliper Adjusting Mechanism with Guides & Boots Repair Kit (Slotted)

Kaliper Ayar Mekanizması ve Mil & Koruk Tamir Takımı (Yarıklı)

SEM Kit No **12567**

Org. Kit Ref. No --

Application 19,5", 22,5"



### Caliper Adjusting Mechanism with Guides & Boots Repair Kit (Slotted)

Kaliper Ayar Mekanizması ve Mil & Koruk Tamir Takımı (Yarıklı)

SEM Kit No **12568**

Org. Kit Ref. No --

Application 19,5", 22,5"

<b>Caliper Calibration Bolt (With Pin)</b> Kaliper Ayar Civatası (Pimli)	
SEM Kit No	<b>12542</b>
Org. Kit Ref. No	--
Application	All Models



<b>Caliper Calibration Bolt (Slotted)</b> Kaliper Ayar Civatası (Yarıklı)	
SEM Kit No	<b>12543</b>
Org. Kit Ref. No	--
Application	All Models



<b>Caliper Calibration Bolt (With Pin)</b> Kaliper Ayar Civatası (Pimli)	
SEM Kit No	<b>12544</b>
Org. Kit Ref. No	--
Application	All Models



<b>Caliper Calibration Bolt (Slotted)</b> Kaliper Ayar Civatası (Yarıklı)	
SEM Kit No	<b>12545</b>
Org. Kit Ref. No	--
Application	All Models



<b>Caliper Roller Bearings</b> Kaliper Rulmanları	
SEM Kit No	<b>10775</b>
Org. Kit Ref. No	
Application	40.160..., 40.175...,40.195...



<b>Caliper Lever &amp; Pin Repair Kit</b> Kaliper Masura Bilya Yatağı Repair Kit	
SEM Kit No	<b>10776</b>
Org. Kit Ref. No	--
Application	40.160..., 40.175...,40.195...





**Caliper Joint & Seals Repair Kit**

Kaliper Conta & Keçeleri Tamir Takımı

SEM Kit No	12546
Org. Kit Ref. No	--
Application	40.160..., 40.175...,40.195...



**Caliper Tappet Cover Repair Kit**

Kaliper Toz Körüğü Tamir Takımı

SEM Kit No	12569
Org. Kit Ref. No	
Application	All 19,5", 22,5"



**Caliper Tappet Cover Repair Kit**

Kaliper Toz Körüğü Tamir Takımı

SEM Kit No	12570
Org. Kit Ref. No	
Application	--



**Caliper Tappet Cover Repair Kit**

Kaliper Toz Körüğü Tamir Takımı

SEM Kit No	12571
Org. Kit Ref. No	
Application	--



**Caliper Tappet Cover Repair Kit**

Kaliper Toz Körüğü Tamir Takımı

SEM Kit No	12572
Org. Kit Ref. No	
Application	--



**Caliper Push Plate (Left)**

Kaliper Balata Tutucusu (Sol)

SEM Kit No	12606
Org. Kit Ref. No	
Application	40 225 003, 40 225 007, 40 225 015



<b>Caliper Push Plate (Right)</b> Kaliper Balata Tutucusu (Sağ)	
SEM Kit No	<b>12607</b>
Org. Kit Ref. No	
Application	40 225 004, 40 225 008, 40 225 016



<b>Caliper Spring Kitt</b> Kaliper Yay Kiti	
SEM Kit No	<b>12551</b>
Org. Kit Ref. No	--
Application	All Models



<b>Caliper Adjusting Mechanism Clutch System Repair Kit</b> Kaliper Ayar Mekanizması Tamir Takımı	
SEM Kit No	<b>12552</b>
Org. Kit Ref. No	--
Application	All Models

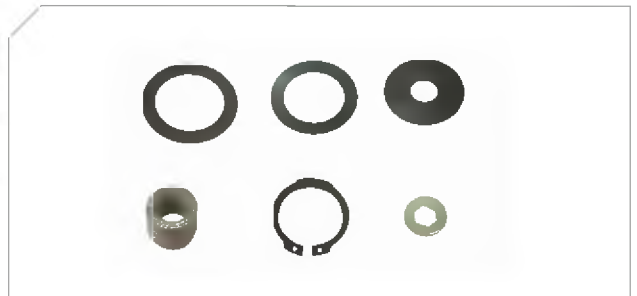

<b>Caliper Adjsuting Mechanism Housing (Thick)</b> Kaliper Ayar Mekanizması Yatağı (Kalın)	
SEM Kit No	<b>12553</b>
Org. Kit Ref. No	--
Application	--



<b>Caliper Adjsuting Mechanism Housing (Thin)</b> Kaliper Ayar Mekanizması Yatağı (İnce)	
SEM Kit No	<b>12554</b>
Org. Kit Ref. No	--
Application	--



<b>Caliper Adjsuting Mechanism Housing (Thick) 80.4mm Pin</b> Kaliper Ayar Mekanizması Yatağı (Kalın) 80.4mm/114mm Pimli	
SEM Kit No	<b>12555</b>
Org. Kit Ref. No	--
Application	--





**Caliper Adjusting Mechanism Housing (Thick) 80.4mm Slotted**  
Kaliper Ayar Mekanizması Yatağı (Kalın) 80.4mm/114mm Yarıklı

SEM Kit No **12556**

Org. Kit Ref. No

Application --



**Caliper Adjusting Mechanism Housing (Thin) 76mm Pin**  
Kaliper Ayar Mekanizması Yatağı (İnce) 76mm/109mm Pimli

SEM Kit No **12557**

Org. Kit Ref. No --

Application --



**Caliper Adjusting Mechanism Housing (Thin) 76mm Slotted**  
Kaliper Ayar Mekanizması Yatağı (İnce) 76mm/109mm Yarıklı

SEM Kit No **12558**

Org. Kit Ref. No --

Application --



# **MAXX 22**

Type Caliper Repair Kits





<b>Caliper Seals &amp; Guide Bolts Repair Kit</b> Kaliper Mil & Keçe Tamir Takımı	
SEM Kit No	<b>12608</b>
Org. Kit Ref. No	6403229262 • MAN Ref.no: 81.50822.6038
Application	MAXX 22

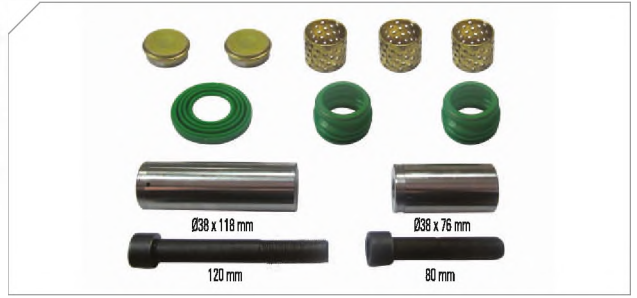

<b>Caliper Sealing Set</b> Kaliper Keçe Takımı	
SEM Kit No	<b>12609</b>
Org. Kit Ref. No	6403229322 • MAN Ref.no: 81.50822.6042
Application	MAXX 22



<b>Caliper Seals &amp; Boots Repair Kit</b> Kaliper Keçe & Kırık Tamir Takımı	
SEM Kit No	<b>12531</b>
Org. Kit Ref. No	--
Application	40 175 051,40 175 052,40 175 070,40 175 071



<b>Caliper Adjusting Mechanism (with Pin)</b> Kaliper Ayar Mekanizması (Pimli)	
SEM Kit No	<b>12610</b>
Org. Kit Ref. No	--
Application	MAXX 22



<b>Caliper Adjusting Repair Kit</b> Kaliper Ayar Tamir Takımı	
SEM Kit No	<b>12611</b>
Org. Kit Ref. No	6403229272MAN Ref.no: 81.50822.6039
Application	MAXX 22



<b>Caliper Calibration Bolt (with Pin)</b> Kaliper Ayar Cıvatası (Pimli)	
SEM Kit No	<b>12612</b>
Org. Kit Ref. No	--
Application	MAXX 22





**Caliper Roller Bearings**

Kaliper Rulmanları

SEM Kit No **12613**

Org. Kit Ref. No --

Application MAXX 22



**Caliper Lever Repair Kit**

Kaliper Masura Bilya Yatağı Tamir Takımı

SEM Kit No **12614**

Org. Kit Ref. No --

Application MAXX 22

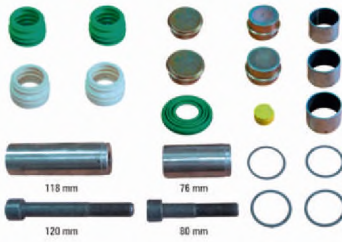

**Caliper Push Plate - Slotted (Left)**

Kaliper Balata Tutucu - Yarıklı (Sol)

SEM Kit No **10766**

Org. Kit Ref. No 6403229312 - MAN Ref.no: 81.50822.6041

Application MAXX 22

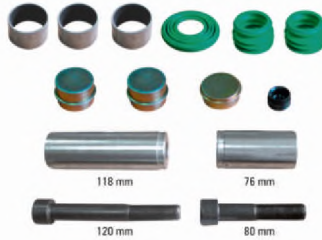

**Caliper Push Plate - Slotted (Right)**

Kaliper Balata Tutucu - Yarıklı (Sağ)

SEM Kit No **10767**

Org. Kit Ref. No --

Application MAXX 22



**Caliper Spring Kit**

kaliper Yay Kiti

SEM Kit No **12615**

Org. Kit Ref. No --

Application MAXX 22



**Caliper Adjusting Mechanism Clutch System Repair Kit**

Kaliper Ayar Mekanizması Tamir Takımı

SEM Kit No **12616**

Org. Kit Ref. No --

Application MAXX 22

**Caliper Adjusting Mechanism Housing**

Kaliper Ayar Mekanizması Yatađı

SEM Kit No **12617**

Org. Kit Ref. No --

Application MAXX 22

Back View



Front View

**Caliper Adjusting Mechanism (with Pin)**

Kaliper Ayar Mekanizması (Pimli)

SEM Kit No **12618**

Org. Kit Ref. No --

Application MAXX 22

**Caliper Roller & Bearing**

Kaliper Masura &amp; Yatađı

SEM Kit No **12619**

Org. Kit Ref. No --

Application MAXX 22

**Caliper Cover**

Kaliper Kapađı

SEM Kit No **12620**

Org. Kit Ref. No --

Application MAXX 22

**Caliper Cover with Sensor**

Sensorl Kaliper Kapađı

SEM Kit No **12621**

Org. Kit Ref. No 6403229282 • MAN Ref.no: 81.50822.6040

Application MAXX 22



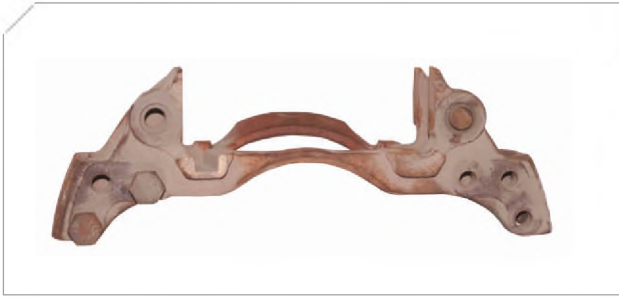

**Caliper Carrier 17,5" (Left)**

Kaliper Taşıyıcı 17,5" (Sol)

SEM Kit No	<b>12622</b>
Org. Kit Ref. No	40175049 MAN Ref.no:81508046087/6071/6089/6355/9071/9087 • DAF Ref.no:1505372
Application	--



**Caliper Carrier 17,5" (Right)**

Kaliper Taşıyıcı 17,5" (Sağ)

SEM Kit No	<b>12623</b>
Org. Kit Ref. No	40175050 MAN Ref.no:81508046070/6354/9070/9088 • DAF Ref.no:1505373
Application	--



**Caliper Carrier 19,5" (Left)**

Kaliper Taşıyıcı 19,5" (Sol)

SEM Kit No	<b>12624</b>
Org. Kit Ref. No	40195037 • DAF Ref.no:877930
Application	--



**Caliper Carrier 19,5" (Right)**

Kaliper Taşıyıcı 19,5" (Sağ)

SEM Kit No	<b>12625</b>
Org. Kit Ref. No	40195038 • DAF Ref.no:877931
Application	--



**Caliper Carrier 19,5" Double Piston**

Kaliper Taşıyıcı 19,5" Çift Piston

SEM Kit No	<b>12626</b>
Org. Kit Ref. No	--
Application	RENAULT MIDLUM



**Caliper Carrier 22,5" (Left)**

Kaliper Taşıyıcı 22,5" (Sol)

SEM Kit No	<b>12627</b>
Org. Kit Ref. No	--
Application	--



<b>Caliper Carrier 22,5" (Right)</b> Kaliper Taşıyıcı 22,5" (Sağ)	
SEM Kit No	12628
Org. Kit Ref. No	--
Application	--



<b>Caliper Carrier 19,5" (Left)</b> Kaliper Taşıyıcı 19,5" (Sol)	
SEM Kit No	12629
Org. Kit Ref. No	6403220310 • MAN Ref.no:81508046579
Application	MAXX 22



<b>Caliper Carrier 19,5" (Right)</b> Kaliper Taşıyıcı 19,5" (Sağ)	
SEM Kit No	12630
Org. Kit Ref. No	6403220350 • MAN Ref.no:81508046582
Application	MAXX 22



<b>Caliper Carrier 19,5" (Left)</b> Kaliper Taşıyıcı 19,5" (Sol)	
SEM Kit No	12631
Org. Kit Ref. No	40195017 • SAF Ref.no:3080001901/3300/3320 • DAF Ref.no: 866216
Application	--



<b>Caliper Carrier 19,5" (Right)</b> Kaliper Taşıyıcı 19,5" (Sağ)	
SEM Kit No	12632
Org. Kit Ref. No	40195018 • SAF Ref.no:3080001801/3200/3220 • DAF Ref.no: 866217
Application	--





**MARK II, III, IV  
MODUL X  
MODUL T**

Type Caliper Repair Kits



## MARK II Type Caliper

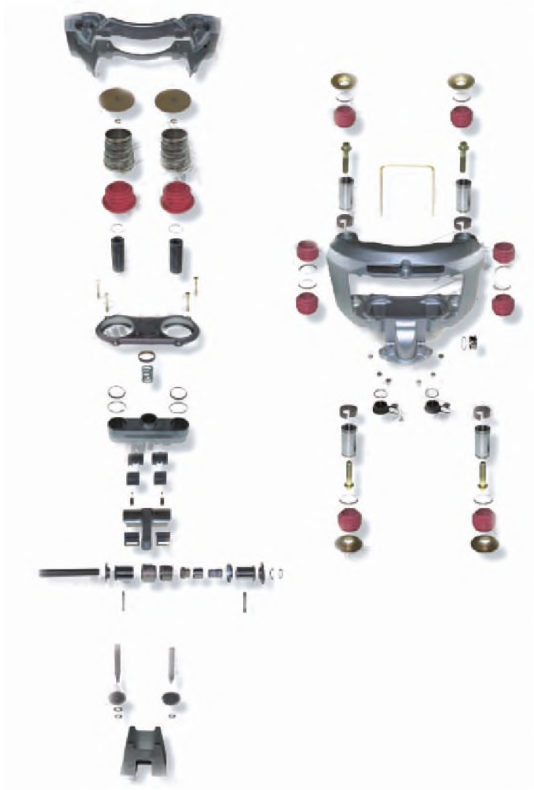

## MARK I II Type Caliper

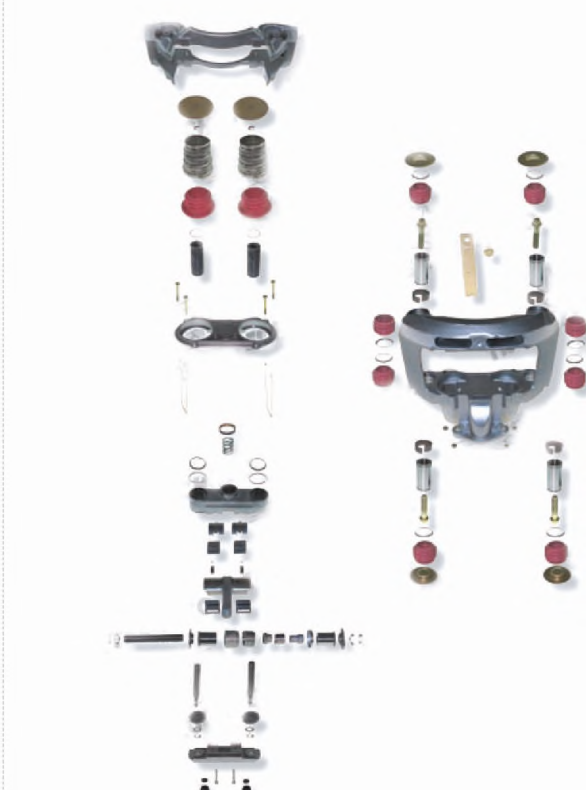

## MARK IV DB 22 Type Caliper





**Adjustment Screw Sealing**  
Ayar Civatası Toz K r g  & Koruması

SEM Kit No **12633**

Org. Kit Ref. No 89794

Application MARK II, MARK III, MARK IV, MODUL X



**Adjustment Screw Sealing**  
Ayar Civatası Toz K r g  & Koruması

SEM Kit No **12634**

Org. Kit Ref. No 87405

Application MARK II, MARK III



**Application Unit Sealing Repair Kit**  
Toz K r g  & Tapa Tamir Takımı

SEM Kit No **12635**

Org. Kit Ref. No 94663

Application MARK II, MARK III, MARK IV, MODUL X



**Application Unit Sealing Repair Kit**  
Toz K r g  & Tapa Tamir Takımı

SEM Kit No **12636**

Org. Kit Ref. No 94662

Application MARK IV, MODUL X



**Thrust Plate & Sealing Repair Kit**  
Balata Tutucusu & Kee Tamir Takımı

SEM Kit No **12637**

Org. Kit Ref. No 94664

Application MARK IV, MODUL X



**Caliper Guide & Seals Repair Kit**  
Kaliper Mil & kee Tamir Takımı

SEM Kit No **12638**

Org. Kit Ref. No 89541

Application MARK II, MARK III, MARK IV

<b>Application Unit Sealing Repair Kit</b> Toz K�r�g� & Tapa Tamir Takımı	
SEM Kit No	12639
Org. Kit Ref. No	
Application	MARK II, MARK III, MARK IV



<b>Caliper Guide &amp; Seals Repair Kit</b> Kaliper Mil & Kee Tamir Takımı	
SEM Kit No	12640
Org. Kit Ref. No	87406
Application	MARK II, MARK III, MARK IV

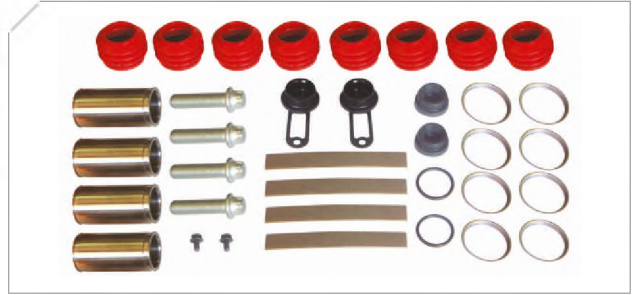

<b>Application Unit Sealing Repair Kit</b> Toz K�r�g� & Tapa Tamir Takımı	
SEM Kit No	12641
Org. Kit Ref. No	94663
Application	MARK II, MARK III, MARK IV

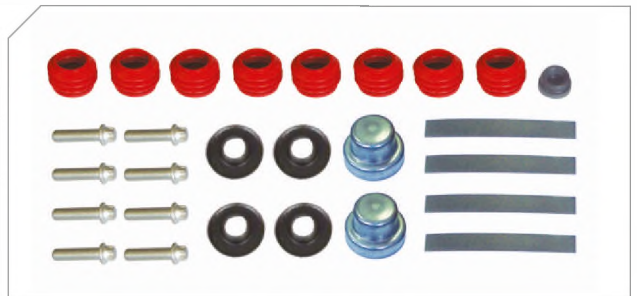

<b>Plugs</b> Toz Kapakları	
SEM Kit No	12642
Org. Kit Ref. No	
Application	MARK II, MARK III, MARK IV



<b>Caps</b> Kapaklar	
SEM Kit No	12643
Org. Kit Ref. No	899927
Application	MARK II, MARK III, MARK IV



<b>Adjustment Shaft</b> Ayar �aftı	
SEM Kit No	12644
Org. Kit Ref. No	90693
Application	MARK II, MARK III, MARK IV, MODUL X





**Adjustment Shaft Sealing Kit**

Ayar Şaftı Tamir Takımı

SEM Kit No **12645**

Org. Kit Ref. No 89925

Application MARK II, MARK III



**Pad Retainer**

Balata Tutucusu

SEM Kit No **12646**

Org. Kit Ref. No 87916S

Application MARK III, MARK IV



**Thrust Plate (2xClips)**

Balata Tutucusu

SEM Kit No **12647**

Org. Kit Ref. No 92731

Application MARK III, MARK IV



**Thrust Plate (2xClips)**

Balata Tutucusu

SEM Kit No **12648**

Org. Kit Ref. No 91236

Application MARK IV

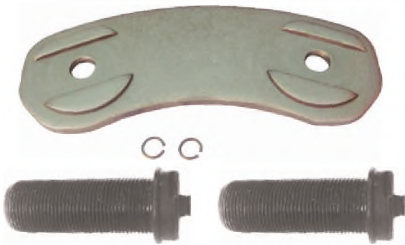

**Thrust Plate with Calibration Bolt**

Balata Tutucusu & Ayar Civatası

SEM Kit No **12649**

Org. Kit Ref. No --

Application MARK III, MARK IV



**Calibration Bolt**

Ayar Civatası

SEM Kit No **12650**

Org. Kit Ref. No --

Application MARK II, MARK III, MARK IV



<b>Caliper Roller Bearing</b> Calper Rulmanları	
SEM Kit No	12651
Org. Kit Ref. No	89925
Application	MARK II, MARK III, MARK IV



<b>Caliper Roller Bearing</b> Calper Rulmanları	
SEM Kit No	12652
Org. Kit Ref. No	
Application	MARK II, MARK III, MARK IV



<b>Caliper Lever</b> Kaliper Masura Bilya Yatađı	
SEM Kit No	12653
Org. Kit Ref. No	
Application	MARK II, MARK III, MARK IV DB 22



<b>Caliper Bridge Assembly</b> Kaliper Köprü Bağlantısı	
SEM Kit No	12654
Org. Kit Ref. No	--
Application	MARK II, MARK III, MARK IV DB 22

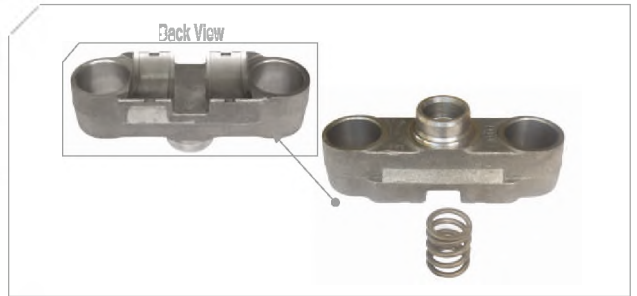

<b>Caliper Cover</b> Kaliper Kapađı	
SEM Kit No	12655
Org. Kit Ref. No	--
Application	MARK II, MARK III, MARK IV DB 22



<b>Caliper Spring Kit</b> Kaliper Yay Kiti	
SEM Kit No	12656
Org. Kit Ref. No	--
Application	MARK II, MARK III, MARK IV DB 22





**Caliper Gear**

Calper Dişlisi

SEM Kit No **12657**

Org. Kit Ref. No

Application MARK II, MARK III, MARK IV DB 22



**Caliper Gear Wheel Adjusting Mechanism**

Kaliper Ayar Dişlisi

SEM Kit No **12658**

Org. Kit Ref. No

Application MARK II, MARK III, MARK IV DB 22



**Caliper Adjusting Mechanism Kit**

Kaliper Ayar Mekanizması Kiti

SEM Kit No **12659**

Org. Kit Ref. No --

Application MARK II, MARK III, MARK IV DB 22

# MODUL X

## Type Caliper







**Adjustment Screw Sealing**

Ayar Civatası Toz K r g  & Koruması

SEM Kit No **12633**

Org. Kit Ref. No 89794

Application MARK II, MARK III, MARK IV, MODUL X



**Adjustment Screw Sealing**

Ayar Civatası Toz K r g  & Koruması

SEM Kit No **12660**

Org. Kit Ref. No 91011

Application MODUL X

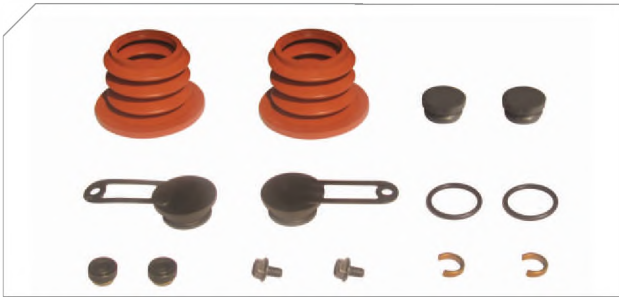

**Application Unit Sealing Repair Kit**

Toz K r g  & Tapa Tamir Takımı

SEM Kit No **12635**

Org. Kit Ref. No 94663

Application MARK II, MARK III, MARK IV, MODUL X



**Application Unit Sealing Repair Kit**

Toz K r g  & Tapa Tamir Takımı

SEM Kit No **12636**

Org. Kit Ref. No 94662

Application MARK IV, MODUL X



**Thrust Plate & Sealing Repair Kit**

Balata Tutucusu & Kee Tamir Takımı

SEM Kit No **12637**

Org. Kit Ref. No 94664

Application MARK IV, MODUL X

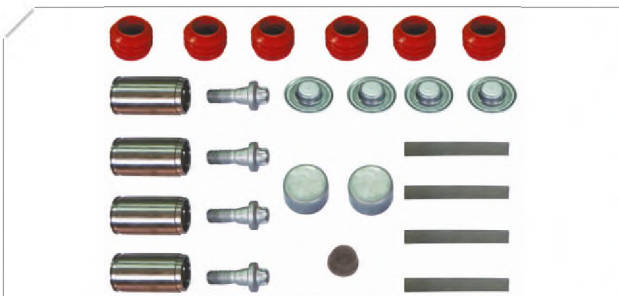

**Caliper Guide & Seals Repair Kit**

Kaliper Mil & kee Tamir Takımı

SEM Kit No **12661**

Org. Kit Ref. No 91012

Application MODUL X

<b>Caliper Boot &amp; Caps</b> Kaliper Toz K�r�g� & Kapları	
SEM Kit No	<b>12662</b>
Org. Kit Ref. No	91013
Application	MODUL X

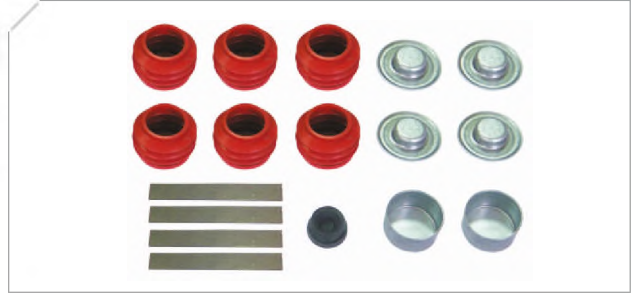

<b>Caliper Boot &amp; Caps</b> Kaliper Toz K�r�g� & Kapları	
SEM Kit No	<b>12663</b>
Org. Kit Ref. No	91014
Application	MODUL X



<b>Caliper Guide &amp; Seals Repair Kit</b> Kaliper Mil & Kee Tamir Takımı	
SEM Kit No	<b>12664</b>
Org. Kit Ref. No	91012
Application	MODUL X 19"



<b>Caliper Guide &amp; Seals Repair Kit</b> Kaliper Mil & Kee Tamir Takımı	
SEM Kit No	<b>12665</b>
Org. Kit Ref. No	93299
Application	MODUL X



<b>Caliper Guide &amp; Seals Repair Kit</b> Kaliper Mil & Kee Tamir Takımı	
SEM Kit No	<b>12666</b>
Org. Kit Ref. No	94660
Application	MODUL X



<b>Caps</b> Kapaklar	
SEM Kit No	<b>12667</b>
Org. Kit Ref. No	91019
Application	MODUL X





**Adjustment Shaft**

Ayar Şaftı

SEM Kit No **12644**

Org. Kit Ref. No 90693

Application MARK II, MARK III, MARK IV, MODUL X



**Pad Retainer**

Balata Tutucusu

SEM Kit No **12668**

Org. Kit Ref. No 90673

Application MODUL X



**Caliper Calibration Bolt**

Kaliper Ayar Civatası

SEM Kit No **12669**

Org. Kit Ref. No --

Application MODUL X

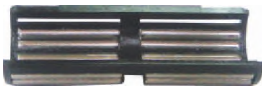

**Caliper Roller Bearing**

Kaliper Rulmanı

SEM Kit No **12670**

Org. Kit Ref. No --

Application MODUL X

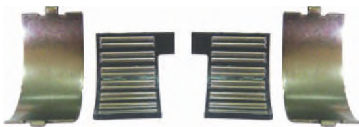

**Caliper Roller Bearing**

Kaliper Rulmanı

SEM Kit No **12671**

Org. Kit Ref. No --

Application MODUL X



**Caliper Roller Bearing**

Kaliper Rulmanı

SEM Kit No **12672**

Org. Kit Ref. No --

Application MODUL X

<b>Caliper Wavy Washer</b> Kaliper Yay Pulu	
SEM Kit No	12673
Org. Kit Ref. No	
Application	MODUL X

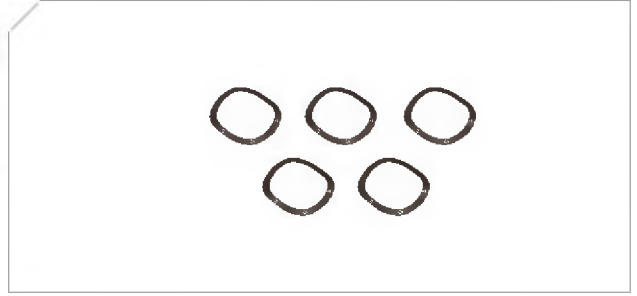

<b>Caliper Lever</b> Kaliper Masura Bilya Yatađı	
SEM Kit No	12674
Org. Kit Ref. No	
Application	MODUL X



<b>Caliper Lever</b> Kaliper Masura Bilya Yatađı	
SEM Kit No	12675
Org. Kit Ref. No	--
Application	MODUL X

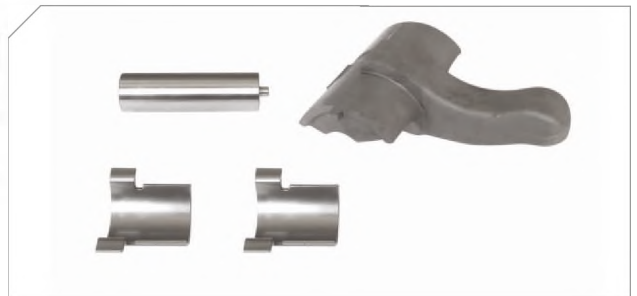

<b>Caliper Lever</b> Kaliper Masura Bilya Yatađı	
SEM Kit No	12676
Org. Kit Ref. No	--
Application	MODUL X



<b>Caliper Bridge Assembly</b> Kaliper Kpr Bađlantısı	
SEM Kit No	12677
Org. Kit Ref. No	--
Application	MODUL X

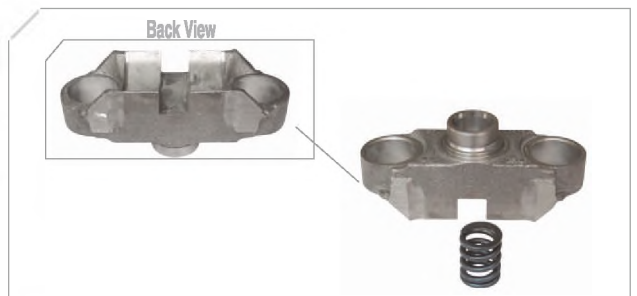

<b>Caliper Cover</b> Kaliper Kapađı	
SEM Kit No	12678
Org. Kit Ref. No	--
Application	MODUL X





**Caliper Gear**

Caliper Dişlisi

SEM Kit No **12657**

Org. Kit Ref. No

Application MARK II, MARK III, MARK IV DB 22, MODUL X



**Caliper Gear Wheel Adjusting Mechanism**

Caliper Ayar Dişlisi

SEM Kit No **12679**

Org. Kit Ref. No

Application MODUL X



**Caliper Adjusting Mechanism**

Kaliper Ayar Mekanizması

SEM Kit No **12680**

Org. Kit Ref. No --

Application MODUL X



**Caliper Mechanism Stand**

Kaliper Mekanizma Sehpası

SEM Kit No **12681**

Org. Kit Ref. No --

Application MODUL X



**Caliper Mechanism Steel**

Kaliper Mekanizma Sacı

SEM Kit No **12682**

Org. Kit Ref. No --

Application MODUL X



**Caliper Adjusting Mechanism Kit**

Kaliper Ayar Mekanizma Seti

SEM Kit No **12683**

Org. Kit Ref. No --

Application MODUL X





## **MODUL T-HALDEX 22,5"**

Caliper Repair Kits

# MODUL T-HALDEX 22,5'' Type Caliper

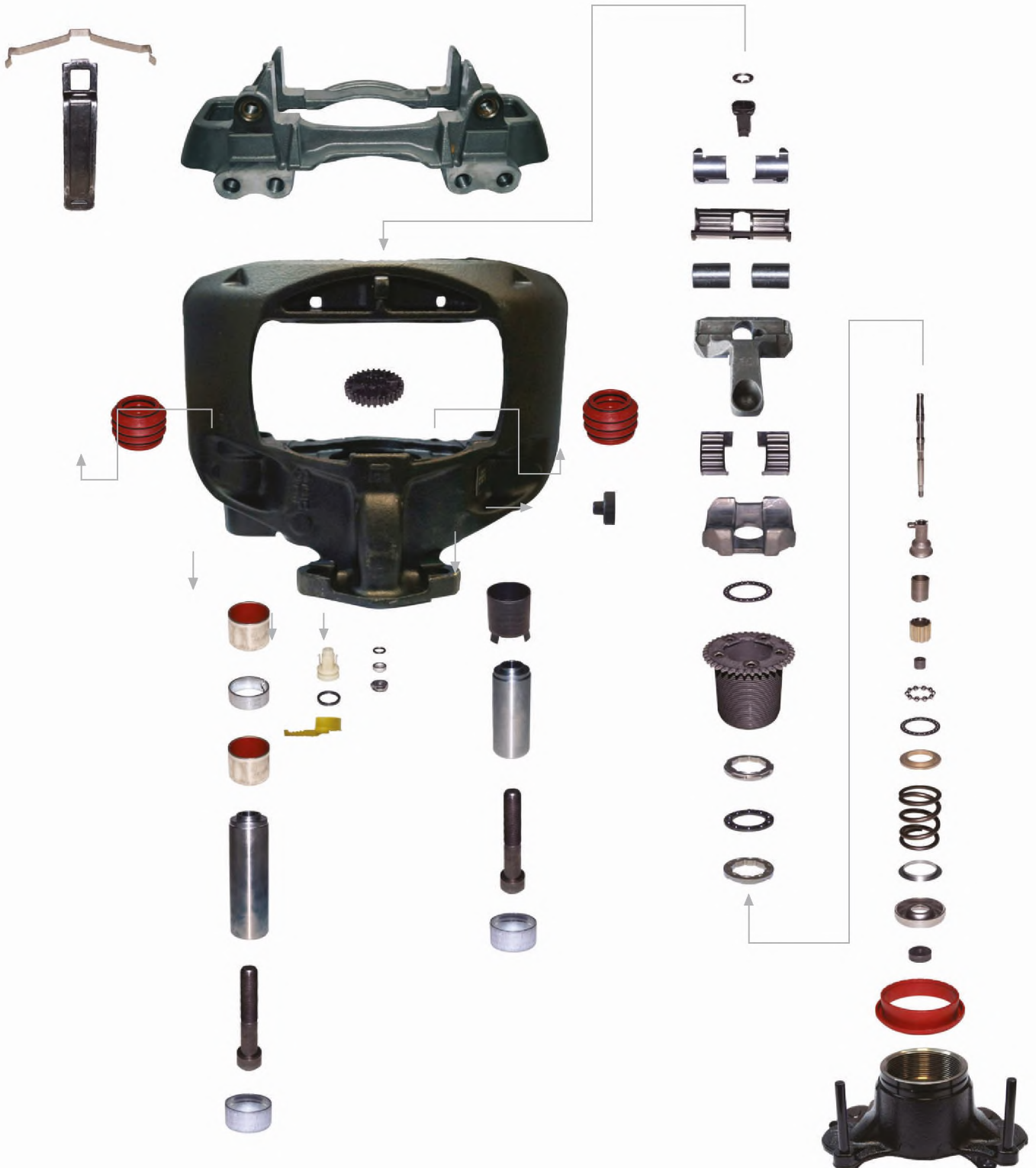



<b>Caliper Guide &amp; Seals Repair Kit</b> Kaliper Mil & Keçe Tamir Takımı	
SEM Kit No	<b>12684</b>
Org. Kit Ref. No	
Application	MODUL T-HALDEX 22,5"



<b>Caliper Seals &amp; Bush Repair Kit</b> Kaliper Keçe & Burç Tamir Takımı	
SEM Kit No	<b>12685</b>
Org. Kit Ref. No	
Application	MODUL T-HALDEX 22,5"



<b>Caliper Seals Repair Kit</b> Kaliper Keçe Tamir Takımı	
SEM Kit No	<b>12686</b>
Org. Kit Ref. No	
Application	MODUL T-HALDEX 22,5"



<b>Caliper Guide &amp; Seals Repair Kit</b> Kaliper Mil & Keçe Tamir Takımı	
SEM Kit No	<b>12687</b>
Org. Kit Ref. No	
Application	MODUL T-HALDEX 22,5"



<b>Caliper Guide &amp; Bolt Repair Kit</b> Kaliper Mil & Civata Tamir Takımı	
SEM Kit No	<b>12688</b>
Org. Kit Ref. No	--
Application	MODUL T-HALDEX 22,5"



<b>Caliper Adjusting Mechanism Repair Kit</b> Kaliper Ayar Mekanizması Tamir Takımı	
SEM Kit No	<b>12689</b>
Org. Kit Ref. No	--
Application	MODUL T-HALDEX 22,5"





**Caliper Adjusting Mechanism Repair Kit**

Kaliper Ayar Mekanizması Tamir Takımı

SEM Kit No **12690**

Org. Kit Ref. No --

Application MODUL T-HALDEX 22,5"



**Caliper Caps Repair Kit**

Kaliper Tapa Tamir Takımı

SEM Kit No **12691**

Org. Kit Ref. No --

Application MODUL T-HALDEX 22,5"

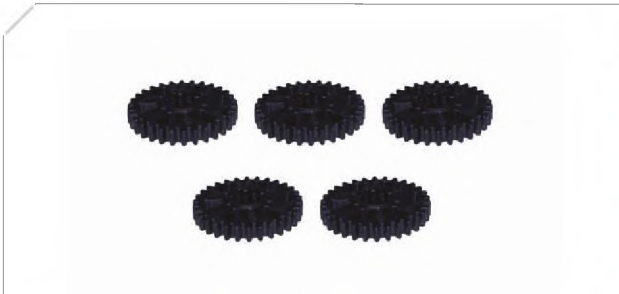

**Caliper Mechanism Gear Set**

Kaliper Mekanizma Dişlisi Tamir Takımı

SEM Kit No **12692**

Org. Kit Ref. No --

Application MODUL T-HALDEX 22,5"



**Caliper Mechanism Metal Gear Set**

Kaliper Mekanizma Metal Dişlisi Tamir Takımı

SEM Kit No **12693**

Org. Kit Ref. No --

Application MODUL T-HALDEX 22,5"



**Caliper Cap Repair Kit**

Kaliper Tapa Tamir Takımı

SEM Kit No **12694**

Org. Kit Ref. No --

Application MODUL T-HALDEX 22,5"



**Caliper Plastic Adjusting Mechanism Repair Kit**

Kaliper Plastik Soket Tamir Takımı

SEM Kit No **12695**

Org. Kit Ref. No --

Application MODUL T-HALDEX 22,5"

<b>Caliper Adjusting Mechanism Kit</b> Kaliper Ayar Mekanizması Set	
SEM Kit No	12696
Org. Kit Ref. No	
Application	MODUL T-HALDEX 22,5"



<b>Caliper Ball Bearing Repair Kit</b> Bilyalı Rulman Tamir Takımı	
SEM Kit No	12697
Org. Kit Ref. No	
Application	MODUL T-HALDEX 22,5"



<b>Caliper Adjusting Mechanism Bearing</b> Kaliper Ayar Mekanizması Yatağı	
SEM Kit No	12698
Org. Kit Ref. No	
Application	MODUL T-HALDEX 22,5"

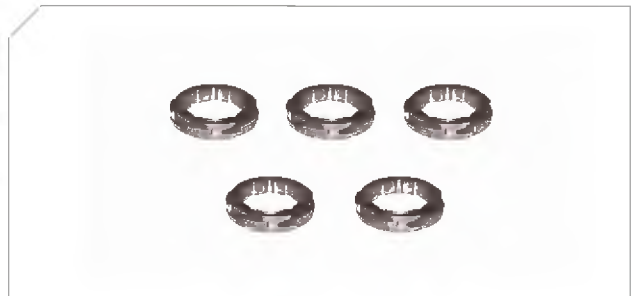

<b>Caliper Gear Adjusting Mechanism</b> Kaliper Ayar Mekanizması Dişlisi	
SEM Kit No	12699
Org. Kit Ref. No	--
Application	MODUL T-HALDEX 22,5"



<b>Caliper Adjusting Mechanism Housing</b> Kaliper Ayar Mekanizması Yatağı	
SEM Kit No	12700
Org. Kit Ref. No	--
Application	MODUL T-HALDEX 22,5"



<b>Caliper Lever</b> Kaliper Masura Bilya Yatağı	
SEM Kit No	12701
Org. Kit Ref. No	--
Application	MODUL T-HALDEX 22,5"





**Caliper Lever**

Kaliper Masura Bilya Yatağı

SEM Kit No **12702**

Org. Kit Ref. No

Application MODUL T-HALDEX 22,5"



**Caliper Cover**

Kaliper Kapağı

SEM Kit No **12703**

Org. Kit Ref. No --

Application MODUL T-HALDEX 22,5"



**Caliper Roller Bearing**

Kaliper Rulmanları

SEM Kit No **12704**

Org. Kit Ref. No --

Application MODUL T-HALDEX 22,5"



**Caliper Roller Bearing Kit**

Kaliper Rulmanları Takımı

SEM Kit No **12705**

Org. Kit Ref. No --

Application MODUL T-HALDEX 22,5"



**Caliper Roller Bearing Kit**

Kaliper Rulmanları Takımı

SEM Kit No **12706**

Org. Kit Ref. No --

Application MODUL T-HALDEX 22,5"



**Pad Retainer Kit**

Balata Tutucusu Takımı

SEM Kit No **12707**

Org. Kit Ref. No --

Application MODUL T-HALDEX 22,5"

<b>Caliper Adjusting Mechanism Kit</b> Kaliper Ayar Mekanizma Seti	
SEM Kit No	12708
Org. Kit Ref. No	--
Application	MODUL T-HALDEX 22,5"



<b>Caliper Carrier</b> Kaliper Taşıyıcı	
SEM Kit No	12709
Org. Kit Ref. No	--
Application	MARK IV DB 22



<b>Caliper Carrier</b> Kaliper Taşıyıcı	
SEM Kit No	12710
Org. Kit Ref. No	92559
Application	SAF



<b>Caliper Carrier</b> Kaliper Taşıyıcı	
SEM Kit No	12711
Org. Kit Ref. No	92502
Application	SAF



<b>Caliper Carrier</b> Kaliper Taşıyıcı	
SEM Kit No	12712
Org. Kit Ref. No	94861
Application	SBS 2220



# HYDRAULIC

## Type Caliper Repair Kits



<b>Hydraulic Caliper Boots &amp; Caps Repair Kit</b> Hidrolik Kaliper K�r�k & Kapları Tamir Takımı	
SEM Kit No	<b>12713</b>
Org. Kit Ref. No	KN 381.413
Application	T 4300 131.720, T 4300 131.721, T 4300 131.766, T 4300 131.767



<b>Hydraulic Caliper Piston Repair Kit</b> Hidrolik Kaliper Piston Tamir Takımı	
SEM Kit No	<b>12714</b>
Org. Kit Ref. No	KN 352798
Application	--

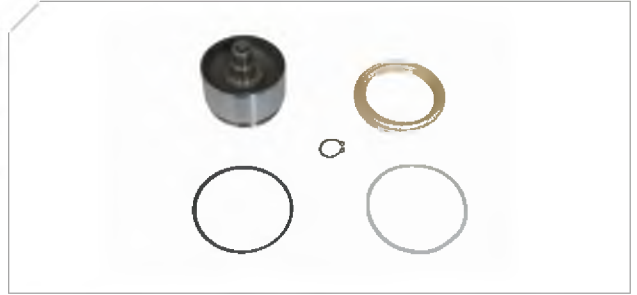

<b>Hydraulic Caliper Tappet Cover Repair Kit</b> Hidrolik Kaliper Toz K�r�g� Tamir Takımı	
SEM Kit No	<b>12715</b>
Org. Kit Ref. No	BRB 93161928
Application	--

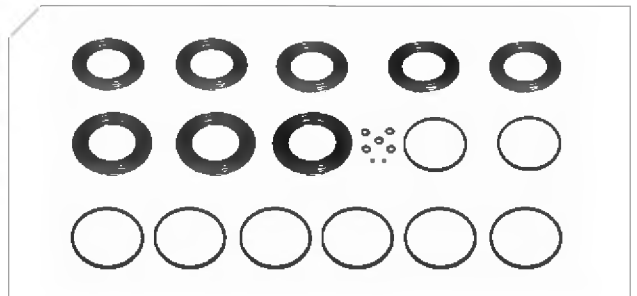

<b>Hydraulic Caliper Tappet Cover Repair Kit</b> Hidrolik Kaliper Toz K�r�g� Tamir Takımı	
SEM Kit No	<b>12716</b>
Org. Kit Ref. No	--
Application	--



<b>Hydraulic Caliper Guides &amp; Seals Repair Kit</b> Hidrolik Kaliper Mil & Kee Tamir Takımı	
SEM Kit No	<b>12717</b>
Org. Kit Ref. No	VRG RRFD 0042.7 / 244.3 z003.013
Application	--

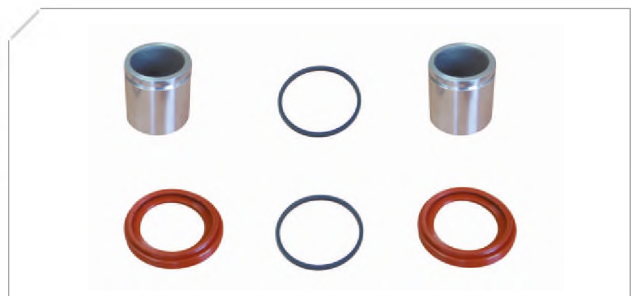

<b>Hydraulic Caliper Tappet Cover Repair Kit</b> Hidrolik Kaliper Toz K�r�g� Tamir Takımı	
SEM Kit No	<b>12718</b>
Org. Kit Ref. No	VRG RRFD 0044.3 / 244.3 Z0044.3
Application	--

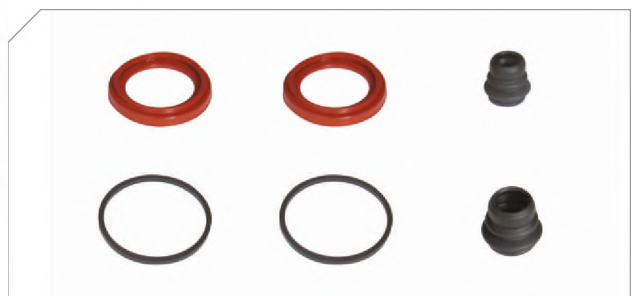





**Hydraulic Caliper Tappet Cover Repair Kit**

Hidrolik Kaliper Toz K r g  Tamir Takımı

SEM Kit No **12719**

Org. Kit Ref. No SJ1037

Application LRG 506,LRG 507



**Hydraulic Caliper Guides & Seals Repair Kit**

Hidrolik Kaliper Mil & Ke e Tamir Takımı

SEM Kit No **12720**

Org. Kit Ref. No SJ 1022

Application LRG 614, LRG 615



**Hydraulic Caliper Tappet Cover Repair Kit**

Hidrolik Kaliper Toz K r g  Tamir Takımı

SEM Kit No **12721**

Org. Kit Ref. No SJ 1035

Application LRG 6512, LRG 514, 612, 614, 812, 814, (Rear)



**Hydraulic Caliper Tappet Cover Repair Kit**

Hidrolik Kaliper Toz K r g  Tamir Takımı

SEM Kit No **12722**

Org. Kit Ref. No --

Application --



**Hydraulic Caliper Piston Repair Kit**

Hidrolik Kaliper Piston Tamir Takımı

SEM Kit No **12723**

Org. Kit Ref. No SJ1214

Application LRG 614, 615



**Hydraulic Caliper Piston Repair Kit**

Hidrolik Kaliper Piston Tamir Takımı

SEM Kit No **12724**

Org. Kit Ref. No

Application LRG 612, 613

<b>Hydraulic Caliper Piston Repair Kit</b> Hidrolik Kaliper Piston Tamir Takımı	
SEM Kit No	<b>12725</b>
Org. Kit Ref. No	SJ 1091
Application	LRG 600,601, 608, 609, 610, 611, 620, 621



<b>Hydraulic Caliper Piston Repair Kit</b> Hidrolik Kaliper Piston Tamir Takımı	
SEM Kit No	<b>12726</b>
Org. Kit Ref. No	SJ 1092
Application	LRG 600,601, 602, 603, 608, 609, 610, 611, 628, 629, 634, 635



<b>Hydraulic Caliper Seals Repair Kit</b> Hidrolik Kaliper Keçe Tamir Takımı	
SEM Kit No	<b>12727</b>
Org. Kit Ref. No	VOLVO Ref.no: 6212908 • 11994196
Application	--

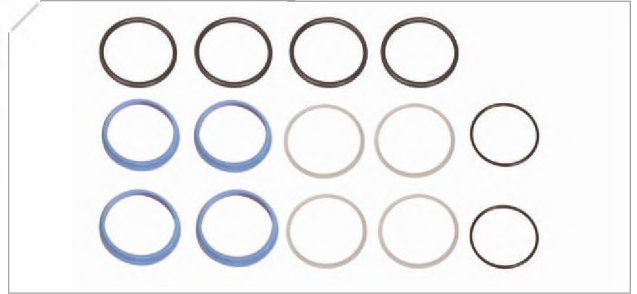

<b>Hydraulic Caliper Piston</b> Hidrolik Kaliper Piston	
SEM Kit No	<b>12728</b>
Org. Kit Ref. No	VOLVO Ref.no: 6211532
Application	--



<b>Hydraulic Caliper Seals Repair Kit</b> Hidrolik Kaliper Keçe Tamir Takımı	
SEM Kit No	<b>12729</b>
Org. Kit Ref. No	VOLVO Ref.no: 6213565 • 11994197
Application	--

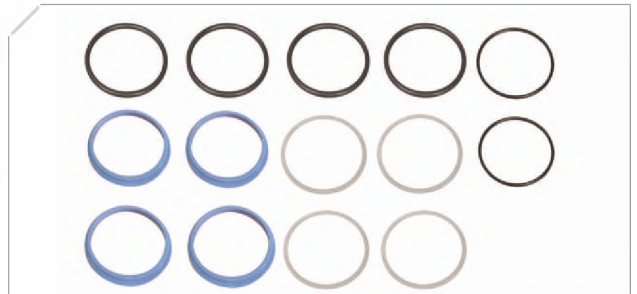

<b>Hydraulic Caliper Tappet Cover Repair Kit</b> Hidrolik Kaliper Toz K�r�g� Tamir Takımı	
SEM Kit No	<b>12730</b>
Org. Kit Ref. No	SP 8564
Application	LRG 500, 501, 502, 503, 504, 505, 508, 509, 518, 519, 534, 535





**Hydraulic Caliper Tappet Cover Repair Kit**

Hidrolik Kaliper Toz K r g  Tamir Takımı

SEM Kit No **12731**

Org. Kit Ref. No SP 8567

Application LRG 502, 503, 504, 505



**Hydraulic Caliper Tappet Cover Repair Kit**

Hidrolik Kaliper Toz K r g  Tamir Takımı

SEM Kit No **12732**

Org. Kit Ref. No SP 8597

Application LRG 510, 511, 516, 517, 520 521, 566, 567



**Hydraulic Caliper Tappet Cover Repair Kit**

Hidrolik Kaliper Toz K r g  Tamir Takımı

SEM Kit No **12733**

Org. Kit Ref. No SP 8566

Application All Series



**Hydraulic Caliper Tappet Cover Repair Kit**

Hidrolik Kaliper Toz K r g  Tamir Takımı

SEM Kit No **12734**

Org. Kit Ref. No SP 9670

Application LRG 601, 602, 603, 608, 609, 610, 611, 628, 629, 634, 635

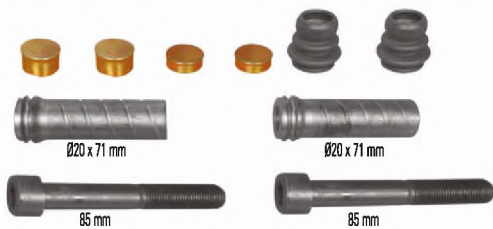

**Hydraulic Caliper Guide & Seal Repair Kit**

Hidrolik Kaliper Toz K r g  Tamir Takımı

SEM Kit No **12735**

Org. Kit Ref. No SP 8565

Application LRG 500, 501, 502, 503, 504, 505, 508, 509, 512, 513, 514, 518, 519, 534, 535, 568, 569, 600, 601, 602, 603, 608, 609, 610, 611, 620, 621, 628, 629, 634, 635

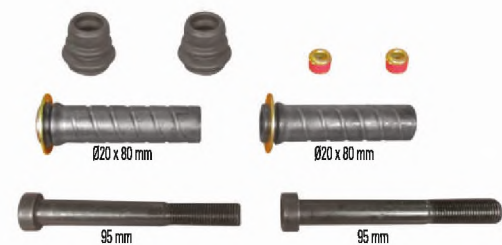

**Hydraulic Caliper Guide & Seal Repair Kit**

Hidrolik Kaliper Toz K r g  Tamir Takımı

SEM Kit No **12736**

Org. Kit Ref. No SP 8902

Application LRG 510, 511, 516, 517, 520 521, 566, 567

<b>Caliper Guide &amp; Seals Repair Kit</b> Kaliper Mil & Keçe Tamir Takımı	
SEM Kit No	<b>12737</b>
Org. Kit Ref. No	ST 1154
Application	--



<b>Caliper Seals &amp; Bush Repair Kit</b> Kaliper Keçe & Burç Tamir Takımı	
SEM Kit No	<b>12738</b>
Org. Kit Ref. No	SJ 1034
Application	--



<b>Caliper Guide &amp; Seals Repair Kit</b> Kaliper Mil & Keçe Tamir Takımı	
SEM Kit No	<b>12739</b>
Org. Kit Ref. No	SP 9669
Application	--



<b>Caliper Guide &amp; Bolt Repair Kit</b> Kaliper Mil & Civata Tamir Takımı	
SEM Kit No	<b>12740</b>
Org. Kit Ref. No	SJ 1030
Application	--



<b>Caliper Adjusting Mechanism Repair Kit</b> Kaliper Ayar Mekanizması Tamir Takımı	
SEM Kit No	<b>12741</b>
Org. Kit Ref. No	SJ 1033
Application	--



**IVECO**  
Type Caliper Repair Kits



<b>Caliper Piston Repair Kit</b> Kaliper Piston Tamir Takımı	
SEM Kit No	<b>10678</b>
Org. Kit Ref. No	II 30413/065 / II 179320065 • IVECO Ref.no: 42541413
Application	All SB 6..., All SB 7... Series



<b>Caliper Boots &amp; Piston Repair Kit</b> Kaliper Korumak & Piston Tamir Takımı	
SEM Kit No	<b>12211</b>
Org. Kit Ref. No	IVECO Ref.no: 42538002
Application	All SB... Series



<b>Caliper Guides &amp; Seals Repair Kit</b> Kaliper Mil & Keçe Tamir Takımı	
SEM Kit No	<b>10689</b>
Org. Kit Ref. No	K 000375 • MAN Ref.no: 81.50822.6023
Application	SB 6547, SB 6557, SB 7884, SB 7984, SB 7907, SB 7020, SB 7022



<b>Caliper Guides &amp; Seals Repair Kit</b> Kaliper Mil & Keçe Tamir Takımı	
SEM Kit No	<b>10690</b>
Org. Kit Ref. No	K 000472 • MAN Ref.no: 81.50822.6019 • IVECO Ref.no: 42541412
Application	SN 6529, SN 6539, SN 7067, SN 7077, SN 7084, SN 7094, SN 7086, SN 7096, SN 7106, SN 7116, SN 7125, SN 7135, SN 7144, SN 7154, NA 7027, NA 7028, NA 7038, SK 7..., SN 65..., SN 66..., SN 7..., SN 71..., SN 72..., SN 73.. Series



<b>Caliper Pad Retainer Repair Kit</b> Kaliper Balata Tutucu Tamir Takımı	
SEM Kit No	<b>12261</b>
Org. Kit Ref. No	K 002311 • IVECO Ref.no: 42541464
Application	--

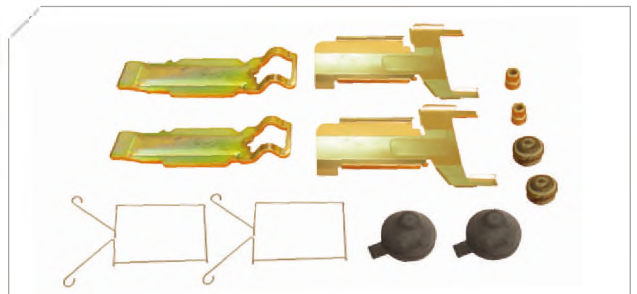

<b>Hydraulic Caliper Boots &amp; Caps Repair Kit</b> Hidrolik Kaliper Korumak & Kapları Tamir Takımı	
SEM Kit No	<b>12713</b>
Org. Kit Ref. No	KN 381.413 • IVECO Ref.no: 63161192
Application	T 4300 131.720, T 4300 131.721, T 4300 131.766, T 4300 131.767





**Hydraulic Caliper Tappet Cover Repair Kit**

Hidrolik Kaliper Toz K r   Tamir Takımı

SEM Kit No **12715**

Org. Kit Ref. No BRB 120320323 IVECO Ref.no: 93161928

Application --



**Adjusting Mechanism Repair Kit**

Ayar Mekanizması Tamir Takımı

SEM Kit No **12742**

Org. Kit Ref. No IVECO Ref.no: 42537365

Application --



**Adjusting Mechanism Repair Kit**

Ayar Mekanizması Tamir Takımı

SEM Kit No **12743**

Org. Kit Ref. No IVECO Ref.no: 42537366

Application --



**Adjusting Mechanism Repair Kit**

Ayar Mekanizması Tamir Takımı

SEM Kit No **12744**

Org. Kit Ref. No IVECO Ref.no: 93161254

Application --



**Adjusting Mechanism Repair Kit**

Ayar Mekanizması Tamir Takımı

SEM Kit No **12745**

Org. Kit Ref. No IVECO Ref.no: 93161623

Application --



**Adjusting Mechanism Repair Kit**

Ayar Mekanizması Tamir Takımı

SEM Kit No **12746**

Org. Kit Ref. No IVECO Ref.no: 42536195

Application --



**Adjusting Mechanism Repair Kit**

Ayar Mekanizması Tamir Takımı

SEM Kit No **12747**

Org. Kit Ref. No IVECO Ref.no: 42531676

Application --

**Caliper Guide & Seals Repair Kit**

Kaliper Mil &amp; Keçe Tamir Takımı

SEM Kit No **12748**

Org. Kit Ref. No KN 381.391 • IVECO Ref.no: 93161189

Application 131.720, 131.774, 131.776, 131.721, 131.775, 131.777

**Caliper Pad Retainer Repair Kit**

Kaliper Balata Tutucu Tamir Takımı

SEM Kit No **12749**

Org. Kit Ref. No KN 381.419 • IVECO Ref.no: 93161560

Application 131.720, 131.774, 131.776, 131.721, 131.775, 131.777

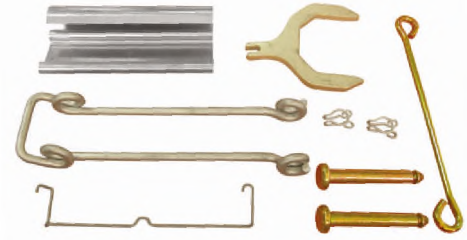
**Caliper Pad Retainer Repair Kit**

Kaliper Balata Tutucu Tamir Takımı

SEM Kit No **12750**

Org. Kit Ref. No II 33692

Application --

**Adjuster Repair Kit**

Ayar Mekanizması Tamir Takımı

SEM Kit No **12751**

Org. Kit Ref. No IVECO Ref.no: 42491974

Application 42101841, 42101842, 42102123

**Adjuster Repair Kit**

Ayar Mekanizması Tamir Takımı

SEM Kit No **12752**

Org. Kit Ref. No IVECO Ref.no: 7980406

Application 42101841, 42101842, 42102123





**Adjuster Repair Kit**  
Ayar Mekanizması Tamir Takımı

SEM Kit No	<b>12753</b>
Org. Kit Ref. No	IVECO Ref.no: 7980405
Application	42101841, 42101842, 42102123



**Adjuster Repair Kit**  
Ayar Mekanizması Tamir Takımı

SEM Kit No	<b>12754</b>
Org. Kit Ref. No	IVECO Ref.no: 42491950
Application	42101841, 42101842, 42102123



**Adjuster Repair Kit**  
Ayar Mekanizması Tamir Takımı

SEM Kit No	<b>12755</b>
Org. Kit Ref. No	IVECO Ref.no: 93161622 / 93161114 / 42558430
Application	41000981, 41000982



**Adjuster Repair Kit**  
Ayar Mekanizması Tamir Takımı

SEM Kit No	<b>12756</b>
Org. Kit Ref. No	IVECO Ref.no: 93161256
Application	41000981, 41000982



**Adjuster Repair Kit**  
Ayar Mekanizması Tamir Takımı

SEM Kit No	<b>12757</b>
Org. Kit Ref. No	IVECO Ref.no: 93161621
Application	41000981, 41000982



**Adjuster Repair Kit**  
Ayar Mekanizması Tamir Takımı

SEM Kit No	<b>12758</b>
Org. Kit Ref. No	IVECO Ref.no: 42480062
Application	42101841, 42101842, 42102123

<b>Return Spring</b> Geri Dönüş Yayı	
SEM Kit No	12759
Org. Kit Ref. No	--
Application	--

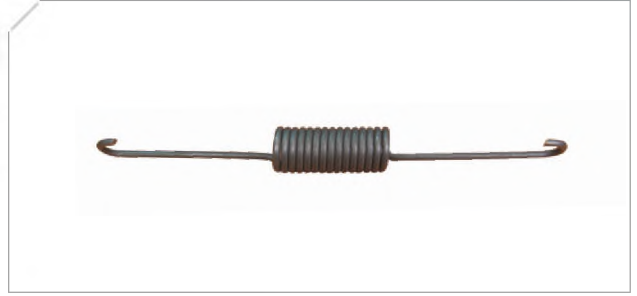

<b>Return Spring</b> Geri Dönüş Yayı	
SEM Kit No	12760
Org. Kit Ref. No	--
Application	--



<b>Dust Boot</b> Toz K�r�g�	
SEM Kit No	12761
Org. Kit Ref. No	IVECO Ref.no: 93161625
Application	41000981, 41000982



<b>Dust Boot</b> Toz K�r�g�	
SEM Kit No	12762
Org. Kit Ref. No	IVECO Ref.no: 7980408
Application	42101841, 42101842, 42102123



<b>Dust Boot</b> Toz K�r�g�	
SEM Kit No	12763
Org. Kit Ref. No	IVECO Ref.no: 93161257
Application	41000981, 41000982



<b>Caliper Pad Retainer Repair Kit</b> Kaliper Balata Tutucu Tamir Takımı	
SEM Kit No	12764
Org. Kit Ref. No	IVECO Ref.no: 42537841
Application	--





**Adjust Screw**

Kaliper Piston Tamir Takımı

SEM Kit No	<b>12765</b>
Org. Kit Ref. No	IVECO Ref.no: 93161624
Application	41000981, 41000982



**Hold Down Clip**

Baskı Kelepçesi

SEM Kit No	<b>12766</b>
Org. Kit Ref. No	IVECO Ref.no: 8121441
Application	41000981, 41000982



**Hold Down Clip**

Baskı Kelepçesi

SEM Kit No	<b>12767</b>
Org. Kit Ref. No	2257Y1143
Application	--



**Hold Down Clip**

Baskı Kelepçesi

SEM Kit No	<b>12768</b>
Org. Kit Ref. No	2257D108
Application	SN 6529, SN 6539, SN 7067, SN 7077, SN 7084, SN 7094, SN 7086, SN 7096, SN 7106, SN 7116, SN 7125, SN 7135, SN 7144, SN 7154, NA 7027, NA 7028, NA 7038, SK 7..., SN 65..., SN 66..., SN 7..., SN 71..., SN 72..., SN 73.. Series



**Hold Down Clip**

Baskı Kelepçesi







SEM Kit No	<b>12769</b>
Org. Kit Ref. No	2257P1004
Application	--

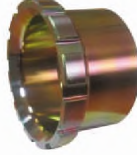

**Locknut (Short)**

Körük Boğaz Somunu (Kısa)

SEM Kit No	<b>12770</b>
Org. Kit Ref. No	165005
Application	--

<b>Locknut (Long)</b> Körük Boğaz Somunu (Uzun)	
SEM Kit No	12771
Org. Kit Ref. No	165004
Application	--
	
<b>Locknut (Short)</b> Körük Boğaz Somunu (Kısa)	
SEM Kit No	12772
Org. Kit Ref. No	165062
Application	--
	
<b>Locknut (Long)</b> Körük Boğaz Somunu (Uzun)	
SEM Kit No	12773
Org. Kit Ref. No	165017
Application	--
	
<b>Actuator Bush</b> Tahrik Burcu	
SEM Kit No	12774
Org. Kit Ref. No	3280V8368
Application	--
	
<b>Actuator Bush</b> Tahrik Burcu	
SEM Kit No	12775
Org. Kit Ref. No	3280T8964
Application	--
	
<b>Actuator Bush</b> Tahrik Burcu	
SEM Kit No	12776
Org. Kit Ref. No	3280S8131
Application	--
	



**Anchor Plunger**

Bağlantı Pistonu

SEM Kit No **12777**

Org. Kit Ref. No 2297H8354 / 2297J8356

Application --



**Anchor Plunger**

Bağlantı Pistonu

SEM Kit No **12778**

Org. Kit Ref. No 2297J4820 / 2297K4821

Application --



**Anchor Plunger**

Bağlantı Pistonu

SEM Kit No **12779**

Org. Kit Ref. No 3280W8163

Application --



**Anchor Plunger**

Bağlantı Pistonu

SEM Kit No **12780**

Org. Kit Ref. No --

Application --



**Adjusting Bolt - Green**

Ayar Civatası - Yeşil

SEM Kit No **12781**

Org. Kit Ref. No

Application A2297L3158



**Guide Pawl Assy.**

Yaylı Ayar Mandalı

SEM Kit No **12782**

Org. Kit Ref. No

Application A2297N6358



<b>Guide Pawl Assy.</b> Yaylı Ayar Mandali	
SEM Kit No	12783
Org. Kit Ref. No	--
Application	A2297U4597



<b>Guide Screw</b> Klavuz Mandal Komple	
SEM Kit No	12784
Org. Kit Ref. No	--
Application	A3280K8435



<b>Rubber Plug</b> Tapa	
SEM Kit No	12785
Org. Kit Ref. No	--
Application	1250L532



<b>Sensor Plug</b> Sensor Tapası	
SEM Kit No	12786
Org. Kit Ref. No	--
Application	1250Y1013



<b>Rubber Plug</b> Tapa	
SEM Kit No	12787
Org. Kit Ref. No	
Application	1250Z1014



<b>Adjuster Repair Kit</b> Ayar Mekanizması Tamir Takımı	
SEM Kit No	12788
Org. Kit Ref. No	IVECO Ref.no: 7980407
Application	42101841, 42101842, 42102123





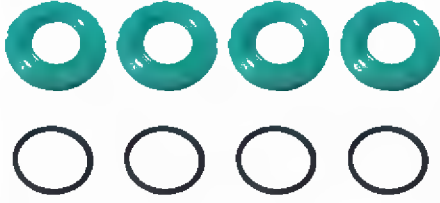

**Dust Boot**

Toz K r g 

SEM Kit No **12789**

Org. Kit Ref. No 12 999 199VT • IVECO Ref.no: 93161181

Application --



**Adjuster Repair Kit**

Ayar Mekanizması Tamir Takımı

SEM Kit No **12790**

Org. Kit Ref. No 42536197

Application --



**Adjuster Repair Kit**

Ayar Mekanizması Tamir Takımı

SEM Kit No **12791**

Org. Kit Ref. No 42536194

Application --



# **BPW**

## Type Caliper Repair Kits



<b>Caliper Guides &amp; Bush Repair Kit</b> Kaliper Mil & Burç Tamir Takımı	
SEM Kit No	<b>12792</b>
Org. Kit Ref. No	09.801.07.61.0
Application	SH, SK, S.,LL

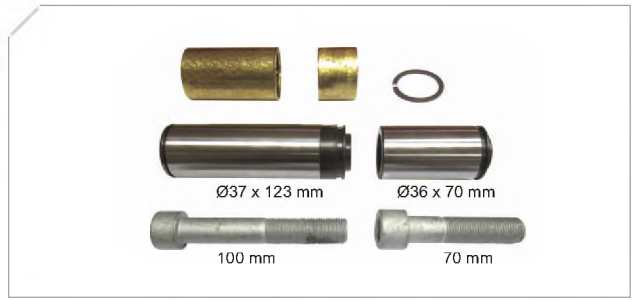

<b>Caliper Calibration Bolt &amp; Boots Repair Kit</b> Kaliper Korum & Ayar Civatası Tamir Takımı	
SEM Kit No	<b>12793</b>
Org. Kit Ref. No	09.801.07.63.0
Application	SH, SK, S.,LL



<b>Caliper Boots &amp; Cap Repair Kit</b> Kaliper Korum & Kapak Tamir Takımı	
SEM Kit No	<b>12794</b>
Org. Kit Ref. No	09.801.07.63.0
Application	SH, SK, S.,LL



<b>Caliper Guides Repair Kit</b> Kaliper Mil Tamir Takımı	
SEM Kit No	<b>12795</b>
Org. Kit Ref. No	09.801.05.81.0
Application	SH, SK, S.,LL



<b>Caliper Guides Repair Kit</b> Kaliper Mil Tamir Takımı	
SEM Kit No	<b>12796</b>
Org. Kit Ref. No	--
Application	SH, SK, S.,LL



<b>Caliper Pad Retainer Repair Kit</b> Kaliper Balata Tutucu Tamir Takımı	
SEM Kit No	<b>12797</b>
Org. Kit Ref. No	05.801.05.81.0
Application	SH, SK, S.,LL

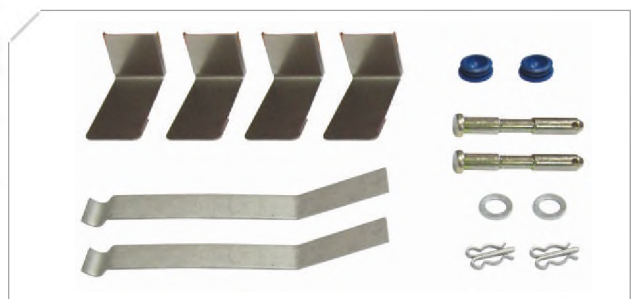



**Adjusting Mechanism Repair Kit**

Ayar Mekanizması Tamir Takımı

SEM Kit No **12798**

Org. Kit Ref. No --

Application SH, SK, S.,LL



**Caliper Roller Bearing Cap**

Kaliper Rulman Yatakları

SEM Kit No **12799**

Org. Kit Ref. No --

Application SH, SK, S.,LL



**Caliper Roller Bearing**

Kaliper Rulman

SEM Kit No **12800**

Org. Kit Ref. No --

Application SH, SK, S.,LL



**Caliper Roller Bearing**

Kaliper Rulman

SEM Kit No **12801**

Org. Kit Ref. No --

Application SH, SK, S.,LL

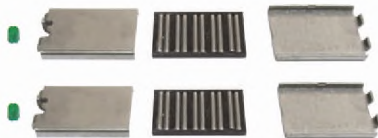

**Caliper Roller Bearing**

Kaliper Rulman

SEM Kit No **12802**

Org. Kit Ref. No --

Application SH, SK, S.,LL



**Caliper Roller Bearing**

Kaliper Rulman

SEM Kit No **12803**

Org. Kit Ref. No --

Application SH, SK, S.,LL

<b>Caliper Lever</b> Kaliper Masura Bilya Yatađı	
SEM Kit No	12804
Org. Kit Ref. No	--
Application	SH, SK, S.,LL



<b>Caliper Lever &amp; Guide</b> Kaliper Masura Bilya Yatađı & Mili	
SEM Kit No	12805
Org. Kit Ref. No	--
Application	SH, SK, S.,LL



<b>Caliper Adjusting Mechanism Lever</b> Kaliper Ayar Mekanizması Yatađı	
SEM Kit No	12806
Org. Kit Ref. No	--
Application	SH, SK, S.,LL



<b>Caliper Adjusting Mechanism Lever &amp; Roller Bearings</b> Kaliper Ayar Mekanizması Yatađı & Rulmanları	
SEM Kit No	12807
Org. Kit Ref. No	--
Application	SH, SK, S.,LL



<b>Caliper Adjusting Mechanism Lever</b> Kaliper Ayar Mekanizması Yatađı	
SEM Kit No	12808
Org. Kit Ref. No	--
Application	SH, SK, S.,LL



<b>Caliper Bridge Assembly</b> Kaliper Köprü Bađlantısı	
SEM Kit No	12809
Org. Kit Ref. No	--
Application	SH, SK, S.,LL







**Caliper Cover & Adjusting Mechanism**

Kaliper Kapağı & Ayar Mekanizması

SEM Kit No **12810**

Org. Kit Ref. No --

Application SH, SK, S.,LL



**Caliper Cover & Adjusting Mechanism**

Kaliper Kapağı & Ayar Mekanizması

SEM Kit No **12811**

Org. Kit Ref. No --

Application SH, SK, S.,LL



**Caliper Gear Adjusting Mechanism**

Kaliper Ayar Mekanizması Dişlisi

SEM Kit No **12812**

Org. Kit Ref. No --

Application SH, SK, S.,LL

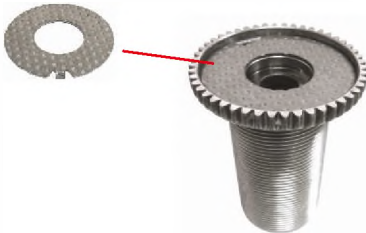

**Caliper Gear Adjusting Mechanism & Washer Lock**

Kaliper Ayar Mekanizması Dişlisi & Kilit Pulu

SEM Kit No **12813**

Org. Kit Ref. No --

Application SH, SK, S.,LL



**Adjustment Mechanism Washer Lock**

Ayar Mekanizması Kilit Pulu

SEM Kit No **12814**

Org. Kit Ref. No --

Application SH, SK, S.,LL



**Caliper Adjusting Mechanism Housing**

Kaliper Ayar Mekanizması Yatağı

SEM Kit No **12815**

Org. Kit Ref. No --

Application SH, SK, S.,LL