



SACHS is a
brand of ZF



2018 | 2019



Kupplungen ***für Nfz*** ***Mit Euro6 Teilen***

Clutches ***for CV*** ***Including Euro6 Parts***

DE EN

FR ES

PT IT

NL NO

SV FI

PL RU

HU CS

RO HR

EL TR

ZH



SACHS

	DE	FR	PT	NL	SV
	EN	ES	IT	NO	FI
	Produkte Products	Produits Productos	Produtos Prodotti	Producten Produkter	Produkter Tuotteet
	Kit plus CSC Kit plus CSC	Kit plus CSC Kit plus CSC	Kit plus CSC Kit plus CSC	Kit plus CSC Kit plus CSC	Kit plus CSC Kit plus CSC
	Kupplungssatz Clutch kit	Kit d'embrayage Kit de embrague	Conjunto de embreagem Kit frizione	Koppelingsset Clutchset	Kopplingsatts Kytkinpaketti
	Druckplatte Pressure plate	Mécanisme d'embrayage Plato de presión	Placa de pressão Spingidisco	Drukgroep Trykkplate	Tryckplatta Kytkinasennelma
	Kupplungsscheibe Clutch disc	Disque d'embrayage Disco de embrague	Disco de embreagem Disco frizione	Koppelingsplaat Clutchlamell	Kopplingsskiva Kytkinlevy
	Torsionsdämpfer Torsion damper	Amortisseur de torsion Amortiguador de torsión	Amortecedores da rotação Smorzatore torsionale	Torsiedemper Torsjonsdemper	Torsionsdämpare Vääntövaimennin
	Ausrücker Releaser	Butée Dispositivo de desembrague	Dispositivo de desengate Cuscinetto reggispinta	Koppelingsdruklager Utløser	Urtrampningsdon Irrotin
	Haltefeder Retaining spring	Ressort de retenue Muelle de retención	Mola de fixação Molla di fermo	Steuerveer Holdefjær	Låsfjäder Lukitusjousi
	Führungslager Pilot bearing	Palier de guidage Cojinete guía	Rolamento de guia Cuscinetto di guida	Geleidingslager Styrelager	Styrlager Ohjainlaakeri
	Schraubensatz Bolt kit	Jeu de vis Kit de tornillos	Conjunto de parafusos Kit viti	Boutenset Skruesett	Bultsats Ruuvisarja
	Zweimassenschwungrad Dual-mass flywheel	Volant bimasse Volante bimasa	Volante de inércia de dupla massa Volano a doppia massa	Tweemassavliegwiel Todelt svinghjul	Tvåmassesvånghjul Kaksimassavauhtipyörä
	Zwischenring Intermediate ring	Bague intermédiaire Anillo intermedio	Anel intermediário Anello intermedio	Tussenring Mellomring	Mellanläggsbricka Välpainelevy
	Montagesatz Assembly kit	Kit de montage Kit de montaje	Kit de montagem Kit di montaggio	Montageset Monteringssett	Monteringsatts Asennussarja
	Ausrückgabel Release Fork	Fourchette de débrayage Horquilla de desembrague	Garfo de embreagem Forcella di disinnesto	Ontkoppelingsvork Utløsergaffel	Urkopplingsgaffel Irrotinhaarukka
	Zentralausrücker (CSC) Concentric slave cylinder (CSC)	Butée Hydraulique (CSC) Dispositivo de desembrague (CSC)	Dispositivo central de engate (CSC) Cuscinetto reggispinta coassiale (CSC)	Centrale releaser (CSC) Sentralutløser (CSC)	Centralt urtrampningsdon (CSC) Irrotinlaakeri-työsylinteri-yhdistelmä (CSC)
	Geberzylinder Master cylinder	Cylindre émetteur Cilindro principal	Cilindro mestre Pompa idraulica	Commandocylinder Hovedsylinder	Huvudcylinder Pääsylinteri
	Nehmerzylinder Slave cylinder	Cylindre récepteur Cilindro receptor	Cilindro escravo Cilindro ricevitore	Werkcilinder Arbeidssylinder	Slavcylinder Työsylinteri
	Kupplungsseil Clutch cable	Câble d'embrayage Cable del embrague	Cabo de embreagem Cavo della frizione	Koppelingskabel Clutchvaier	Kopplingsvajer Kytkinvääjeri
	Produktinweise Product information	Indications de produit Indicaciones del producto	Indicações do produto Indicazioni prodotto	Productinstructies Produktinformasjon	Produktanvisningar Tuoteohjeet
	Nur als Satz lieferbar Only available as kit	Uniquement disponible en kit Solo disponible como kit	Disponível apenas como conjunto Disponibile solo come kit	Alleen als set leverbaar Leveres kun som sett	Levereras bara som sats Saatavilla vain sarjana
	Ausrücker montiert mit Druckplatte Releaser fitted to the cover assembly	Butée montée sur le plateau de pression Dispositivo de desembrague incorporado en el plato de presión	Dispositivo de desengate montado como placa de pressão Cuscinetto reggispinta montato con spingidisco	Releaser gemonteerd in drukgroep Utløserlager monteret på trykkplate	Monterat urtrampningsdon med tryckplatta Irrotin asennettu kytkinasennelman kanssa
	Ohne Ausrücker Without releaser	Sans butée Sin dispositivo de desembrague	Sem dispositivo de desengate Senza cuscinetto reggispinta	Zonder koppelingsdruklager Uten utløser	Utan urtrampningsdon Ilman irrotinta
	Auslaufartikel Article to be discontinued	Article jusqu'à épuisement Hasta agotar existencias	Artigo descontinuado Articolo fuori produzione	Artikel in uitloop Utgått artikkel	Utgående artikel Tuotteen valmistus lopetettu
	Wahlweise Alternatively	Alternative Opcional	Opcionalmente A scelta	Naar keuze Alternativt	Alternativt Valinnaisesti
	Verstärkte Ausführung Heavy duty version	Modèle renforcé Versión reforzada	Versão reforçada Versione rinforzata	Versterkte uitvoering Forsterket utførelse	Förstärkt modell Vahvistettu malli
	Austauschteil Remanufactured part	Élément de rechange Pieza reacondicionada	Peça remanufaturada Componente intercambiabile	Gereviseerd onderdeel Byttedel	Reservdel Vaihdeosa

	DE	FR	PT	NL	SV
	EN	ES	IT	NO	FI
	Fahrzeuginweise Vehicle information	Indications de véhicule Indicaciones del vehículo	Indicações sobre o veículo Indicazioni veicolo	Voertuigaanwijzingen Kjøretøyhenvisning	Fordonsanvisningar Ajoneuvo-ohjeet
	Mit Schaltgetriebe With manual transmission	Avec boîte de vitesses manuelle Con caja de cambios	Com caixa de câmbio manual Con cambio manuale	Met handgeschakelde versnellingsbak Med manuell girkasse	Med växellåda Manuaalivaihteistolla
	Mit Schaltgetriebe, automatisch betätigt With automated manual transmission	Avec boîte de vitesses à actionnement automatique Con caja de cambios manual, automatizada	Com caixa de câmbio manual, acionada automaticamente Con cambio manuale, automatizzato	Met handgeschakelde versnellingsbak met automatische bediening Med manuell girkasse, automatisert	Med växellåda, automatisk utlösning Käsivaihteistolla, automatisoitu
	Mit Schaltgetriebe 5 Gang With manual transmission 5-speed	Avec boîte de vitesses manuelle à 5 vitesses Con caja de cambios de 5 marchas	Com caixa de câmbio manual 5 marchas Con cambio a 5 marce	Met handgeschakelde versnellingsbak 5 versnellingen Med manuell girkasse 5-trinns	Manuell 5-växlad låda Käsivaihteistolla 5-vaihteinen
	Mit Schaltgetriebe 6 Gang With manual transmission 6-speed	Avec boîte de vitesses manuelle à 6 vitesses Con caja de cambios de 6 marchas	Com caixa de câmbio manual 6 marchas Con cambio a 6 marce	Met handgeschakelde versnellingsbak 6 versnellingen Med manuell girkasse 6-trinns	Manuell 6-växlad låda Käsivaihteistolla 6-vaihteinen
	Bestückungswechsel Fitting change	Remplacement des composants Cambio de equipamiento	Substituição de equipamento Sostituzione equipaggiamento	Uitrustingswissel Skifte av utstyr	Monteringsbyte Varustuksen vaihto
	Komplettbestückung Complete fitting	Ensemble des composants Equipamiento completo	Montagem completa Equipaggiamento completo	Complete uitrusting Komplett utstyr	Komplettmontering Kokonaisvarustus
	Getriebeseitig Transmission side	Côté transmission Lado de la caja de cambios	Do lado da caixa de câmbio Lato trasmissione	Versnellingsbakzijde Girside	På växellådan Vaihteistonpuoleinen
	Motorseitig Engine side	Côté moteur Lado del motor	Do lado do motor Lato motore	Motorzijde Motorside	På motorn Moottorinpuoleinen
	Für Linkslenker For left-hand drive vehicles	Pour véhicules avec direction à gauche Para volante a la izquierda	Para volante do lado esquerdo Per veicoli con guida a sinistra	Voor linksgestuurde voertuigen For vensterratt	För vänsterstyrning Vasemmanpuoleinen ohjais
	Für Rechtslenker For right-hand drive vehicles	Pour véhicules avec direction à droite Para volante a la derecha	Para volante do lado direito Per veicoli con guida a destra	Voor rechtsgestuurde voertuigen For høyrreratt	För högerstyrning Oikeanpuoleinen ohjais
	Spalte i Column i	Colonne i Columna i	Coluna i Colonna i	Kolom i Spalte i	Spalt i Sarake i
Chass. ...	Fahrgestellnummer Chassis number	Numéro de châssis Número de chasis	Número do chassis Numero di telaio	Chassisnummer Chassisnummer	Chassinummer Alustanumero
->Chass. ...	Bis Fahrgestellnummer To chassis number	Jusqu'au numéro de châssis Hasta número de chasis	Até ao número do chassis Fino al numero di telaio	Tot chassisnummer Til chassisnummer	Till chassinummer Päätyen alustanumeroon
Chass. ...->	Ab Fahrgestellnummer From chassis number	À partir du numéro de châssis Desde número de chasis	A partir do número do chassis Da numero di telaio	Vanaf chassisnummer Fra chassisnummer	Från chassinummer Alkaen alustanumerosta
->02.2005	Bis Baujahr To construction year	Jusqu'à l'année de fabrication Hasta año de construcción	Até ao ano de fabricação Fino all'anno di costruzione	Tot bouwjaar Til produksjonsår	Till tillverkningsår Päätyen valmistusvuoteen
03.2005->	Ab Baujahr From construction year	À partir de l'année de fabrication Desde año de construcción	A partir do ano de fabricação Da anno di costruzione	Vanaf bouwjaar Fra produksjonsår	Från tillverkningsår Alkaen valmistusvuodesta
GBox ...	Getriebetyp Transmission type	Type de transmission Tipo de caja de cambios	Tipo de transmissão Tipo di trasmissione	Transmissietype Girtype	Växeltyp Vaihteistotyyppi
XTend	Mit automatischer Nachstellung With automatic adjustment	Avec ajustement automatique Con ajuste automático	Com ajuste automático Con regolazione automatica	Met automatische nastelling Med automatisk justering	Med automatisk justering Automaattisella säädöllä

PL	HU	RO	EL	ZH	
RU	CS	HR	TR		
Informacje o pojeździe Указания по автомобилю	Járműinformációk Pokyny týkající se vozidla	Indicații despre vehicul Napomene uz vozilo	Υποδείξεις οχήματος Taşıt uyarıları	车辆说明	
Z mechaniczną skrzynią biegów С механической коробкой передач	Sebességváltóval S převodovkou	Cu cutie de viteze manuală S ručnim mjenjačem	Με μηχανικό κιβώτιο ταχυτήτων Manuel şanziman ile	带变速箱	
Z automatyczną skrzynią biegów С механической коробкой передач с автоматическим управлением	Kézi sebességváltóval, automatikusan működtetve S převodovkou, automaticky ovládanou	Cu cutie de viteze, automatizată S automatskim mjenjačem	Με μηχανικό κιβώτιο ταχυτήτων, ημιαυτόματο Manuel şanziman ile, otomatikleştirilmiş	带机械自动变速箱	
Z 5-biegową mechaniczną skrzynią biegów С 5-ступенчатой механической коробкой передач	5 sebességes sebességváltóval S 5-ti stupňovou převodovkou	Cu cutie de viteze manuală cu 5 trepte S 5-stupanjskim ručnim mjenjačem	Με μηχανικό κιβώτιο 5 ταχυτήτων Manuel şanzimanlı, 5 vitesli	5 档手动变速箱	
Z 6-biegową mechaniczną skrzynią biegów С 6-ступенчатой механической коробкой передач	6 sebességes sebességváltóval S 6-ti stupňovou převodovkou	Cu cutie de viteze manuală cu 6 trepte S 6-stupanjskim ručnim mjenjačem	Με μηχανικό κιβώτιο 6 ταχυτήτων Manuel şanzimanlı, 6 vitesli	6 档手动变速箱	
Wymiana uzbrojenia Смена комплектующих	Felszerelésváltás Výměna osazení	Schimbare echipare Izmjena sastavnica	Αλλαγή εξοπλισμού Donanım değiştirme	完全配备	
Kompletne wyposażenie Комплектное оснащение	Komplett felszerelés Kompletní osazení	Echipare completă Kompletno opremanje	Πλήρης εξοπλισμός Komple donanım	完全装备	1888 055 247
Po stronie skrzyni biegów Со стороны коробки передач	Hajtásoldali Strana převodu	Pe partea cutiei de viteze Na strani mjenjača	Αφορά στο κιβώτιο ταχυτήτων Şanziman tarafı	变速箱侧	
Po stronie silnika Со стороны двигателя	Motoroldali Na straně motoru	Pe partea motorului Sa strane motora	Από την πλευρά του κινητήρα Motor tarafı	发动机侧	
Do ruchu lewostronnego Для автомобилей с левым расположением руля	Balkormányos járművekhez Pro vozidla s levostranným řízením	Pentru vehicule cu volan pe partea stângă Za vozila s upravljačem na lijevoj strani	Για αριστεροτίμονα Soldan direksiyonlular için	用于左侧驾驶车辆	
Do ruchu prawostronnego Для автомобилей с правым расположением руля	Jobbkormányos járművekhez Pro vozidla s pravostranným řízením	Pentru vehicule cu volan pe partea dreaptă Za vozila s upravljačem na desnoj strani	Για δεξιοτίμονα Sağdan direksiyonlular için	用于右侧驾驶车辆	
Kolumna i Столбец i	i oszlop Sloupec i	Coloana i Stupac i	Στήλη i i sütunu	i 栏	
Numer nadwozia Номер шасси	Alvázsámv Číslo podvozku	Serie de şasiu Broja šasije	Αριθμός πλαισίου Şasi numarası	底盘号码	Chass. ...
Do numeru nadwozia До номера шасси	Alvázsámig Do čísla podvozku	Până la seria de şasiu Do broja šasije	Μέχρι αριθμό πλαισίου Şasi numarasına kadar	至底盘号码	->Chass. ...
Od numeru nadwozia Начиная с номера шасси	Alvázsámtól Od čísla podvozku	Începând de la seria de şasiu Od broja šasije	Από αριθμό πλαισίου Şasi numarasından itibaren	从底盘号码	Chass. ...->
Do roku produkcji До года изготовления	Gyártási évig Do roku výroby	Până în anul de fabricație Do godine proizvodnje	Μέχρι έτος κατασκευής Model yılına kadar	至制造年份	->02.2005
Od roku produkcji Начиная с года изготовления	Gyártási évtől Od roku výroby	Începând cu anul de fabricație Od godine proizvodnje	Από έτος κατασκευής Minimum model yılı	从制造年份	03.2005->
Typ skrzyni biegów Тип коробки передач	Sebességváltó típus Typ převodovky	Tip cutie de viteze Tip mjenjača	Τύπος κιβωτίου ταχυτήτων Şanziman tipi	变速箱类型	GBox ...
Z automatycznym nastawianiem С автоматической регулировкой	Automatikus utánállítással S automatickým nastavením	Cu reajustare automată S automatskim podešavanjem	Με αυτόματη ρύθμιση Otomatik ayarlarla ile	带自动调整	XTend

PL	HU	RO	EL	ZH	
RU	CS	HR	TR		
Produkty Продукты	Termékek Produkty	Produse Proizvodi	Προϊόντα Ürünler	产品	
Kit plus CSC Kit plus CSC	Kit plus CSC Kit plus CSC	Kit plus CSC Kit plus CSC	Kit plus CSC Kit plus CSC	Kit plus CSC	
Zestaw sprzęgła Комплект сцепления	Kuplungkészlet Spojková sada	Set de ambreiaj Komplet spojki	Σετ συμπλέκτη Debriyaj seti	离合器套件	
Płytką dociskowa Нажимной диск	Nyomólap Přítlačná deska	Placă de presiune Potisna ploča	Πλατό Baski plakası	压盘总成	
Tarcza sprzęgła Ведомый диск сцепления	Kuplungtárcsa Kotouč spojky	Disc de ambreiaj Disk spojke	Δίσκος συμπλέκτη Debriyaj diski	离合器从动盘	
Tłumik drgań skrętnych Гаситель крутильных колебаний	Torziós csillapító Torzní tlumič	Amortizor de torsiune Torzijski ublaživač	Αποσβεστήρας στρέψης Torsiyon söndümlerici	扭振减振器	
Wyrzętnik Выжимной подшипник	Kinyomócsapágy Vypínací ústrojí	Dispozitiv de debreiere Isključivač	Έδρανο αποσύμπλεξης Debriyaj rulmanı	分离轴承	
Sprężyna ustalająca Удерживающая пружина	Tartórugó Přidržná pružina	Arc de reținere Přidržna opruga	Ελατήριο συγκράτησης Tutma klipsi	止动弹簧	
Łożysko jezdne Центрирующий подшипник	Vezetőcsapágy Vodící ložisko	Lagăr de ghidare Vodecí ležaj	Έδρανο οδηγός Kılavuz yatak	导向轴承	
Zestaw śrub Комплект винтов	Csavarkészlet Sada šroubů	Set de șuruburi Komplet vijaka	Σετ βιδών Civata seti	螺栓套件	
Podwójne koło zamachowe Двухмассовый маховик	Kettős tömegű lendkerék Dvouhmotový setrvačnik	Volantă cu masă dublă Dvomasen zamašnjak	Σφόνδουλος διπλής μάζας Çift kütleli volan	双质量飞轮	
Pierścień pośredni Прокладочное кольцо	Kőzbenső gyűrű Vložený kroužek	Inel intermediar Međuprsten	Ενδιάμεσος δακτύλιος Ara halkası	间隔环	
Zestaw montażowy Монтажный комплект	Szerelőkészlet Montážní sada	Set de montaj Komplet za ugradnju	Σετ συναρμολόγησης Montaj seti	安装套件	
Widelki wyrzęgające Вилка выключения сцепления	Kinyomóvilla Vysouvací vidlice	Furcă de debreiere Otpusna vilica	Δίχαλο αποσύμπλεξης Baski çatalı	分离拨叉	
Centralny wyrzętnik (CSC) Муфта выключения (CSC)	Központi kinyomócsapágy (CSC) Koncentrický pracovní válec (CSC)	Dispozitiv central de debreiere (CSC) Središnji isključivač (CSC)	Κεντρικό έδρανο αποσύμπλεξης (CSC) Merkezi debriyaj rulmanı (CSC)	液壓分离轴承 (CSC)	
Pompa sprzęgłowa Главный цилиндр	Elsődleges kuplunghengere Hlavní válec	Pompă de ambreiaj Glavni cilindar	Εντολοδότης κύλινδρος Debriyaj merkezi	主泵	
Cylinder odbiorczy Рабочий цилиндр	Másodlagos kuplunghengere Pracovní válec	Cilindru receptor de ambreiaj Radni cilindar	Εντολοδόχος κύλινδρος Alt debriyaj merkezi	分泵	
Linka sprzęgła Трос привода сцепления	Kuplungbowden Lanovod spojky	Cablu de ambreiaj Uže spojke	Ντίτζα συμπλέκτη Debriyaj telı	离合器拉索	
Informacje o produkcie Указание к изделию	Termékre vonatkozó útmutatások Poznámky k výrobku	Indicații pentru produs Napomene o proizvodu	Υποδείξεις προϊόντος Ürün bilgileri	产品说明	
Dostarczany tylko w komplecie Поставляется только в комплекте	Csak készletként szállítható Dodává se pouze v sadě	Se livrează numai ca set Isporučiv samo u kompletu	Παραδοτέο μόνο ως σετ Sadece set olarak sipariş edilebilir	仅作为组件供货	
Wyrzętnik zamontowany z płytką dociskową Выжимной подшипник смонтирован вместе с нажимным диском	Kinyomócsapágy nyomólappal Vypínací ústrojí montováno s přítlačným kotoučem	Dispozitiv de debreiere montat cu placă de presiune Isključivač ugrađen sa potisnom pločom	Έδρανο αποσύμπλεξης τοποθετημένο με πλατό Debriyaj rulmanı plakası ile monte edildi	安装于压盘上的分离轴承	
Bez wyrzętnika Без выжимного подшипника	Kinyomócsapágy nélkül Bez vypínacího ústrojí	Fără dispozitiv de debreiere Bez isključivača	Χωρίς εξάρτημα αποσύμπλεξης Debriyaj rulmanı yok	无分离轴承	
Artykuł już nieprodukowany Снятое с производства изделие	Kifutó cikkszám Výběhový výrobek	Articol care nu se va mai produce Proizvod koji se prestaje proizvoditi	Υπο κατάργηση Üretim durdurulan ürün	停产零件	
Do wyboru На выбор	Választható Voliteľné	Alternativ Po izboru	Κατ' επιλογή Isteğe bağlı	可选	
Wersja wzmocniona Усиленное исполнение	Megerősített kivitel Zesílené provedení	Varianta consolidată Pojačana izvedba	Ενισχυμένος τύπος Güçlendirilmiş tip	重载配置	HD
Część wymienna Сменяемая деталь	Cserealkatrész Výměnná součást	Piesă de schimb recondiționată Zamjenski dio	Εξάρτημα αντικατάστασης Değiştirme parça	更换零件	#

DE	Deutsch	V3
EN	English	V5
FR	Français	V7
ES	Español	V13
PT	Português	V19
IT	Italiano	V25
NL	Nederlands	V31
NO	Norsk	V37
SV	Svenska	V43
FI	Suomi	V49
PL	Polski	V55
RU	Русский	V61
HU	Magyar	V67
CS	Česky	V73
RO	Română	V79
HR	Hrvatski	V85
EL	Ελληνικά	V91
TR	Türkçe	V97
ZH	中文	V103

Allgemeine Informationen



Sämtliche in diesem Katalog aufgeführten Produkte dürfen nur durch ausgebildetes Personal einer Kfz-Fachwerkstatt verbaut werden.

Für Ihre Anforderungen benötigen wir die vollständige Bestellnummer, zum Beispiel:

Kupplungskit	3400 122 201
Kupplungsdruckplatte	3482 083 032
Kupplungsscheibe	1878 004 832
Ausrücker	3151 000 034

Im Zweifelsfall Typenbezeichnung und Baujahr des Fahrzeugs angeben, für das der gewünschte Artikel bestimmt ist.

Dieser Katalog stellt einen Auszug aus unserem Produktprogramm dar, eine vollständige Übersicht finden sie auf unseren elektronischen Medien.

Alle Rechte vorbehalten. Vervielfältigungen oder die Mitbenutzung dieses Kataloges, auch auszugsweise, für die Erstellung eines Eigenkataloges sind ohne ausdrückliche Zustimmung unzulässig.

Ersatzteilnummern der Fahrzeughersteller dienen nur zu Vergleichszwecken. Eine Verwendung derartiger Angaben in Rechnungen an den Fahrzeugbesitzer ist nicht statthaft.

Die aktuellen allgemeinen Geschäftsbedingungen finden Sie unter www.zf.com/aftermarket/dokumente

www.zf.com/aftermarket/katalog

WebCat
Online Katalog

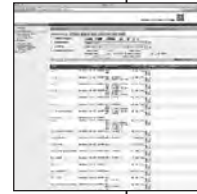

InCat
Elektronischer Katalog



PrintCat
Gedruckte Kataloge



Inhaltsverzeichnis

Index	U2
Symbole	U3 - U4
Allgemeine Informationen	V3
Katalogaufbau	V4
Kenngrößen	V4
Arithmetische Liste	938 - 984
Vergleichsliste	985 - 1028
Neuaufnahmen	1029 - 1034
Geänderte Bestellnummer	1034 - 1035
Gestrichene Nummern	1036
Maßtabelle für Nabenprofile	1037
Maßtabelle für Schwungscheiben	1038 - 1039
Stückliste für Zweis Scheibenkupplung	1040

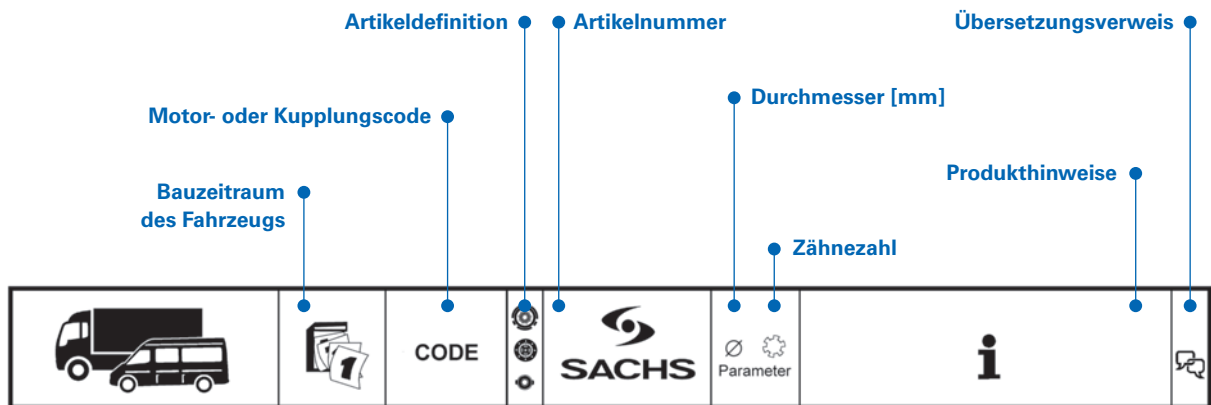

DAF

LF	05.13 -					
FA 180	05.13-	PX-5135	3400 700 465 3482 000 859 1878 005 601 3151 000 651	362 10 MF362 362WGTZ KZIS-4	Getr. / GBox: 6 S 700 Getr. / GBox: 6 AS 700 Euro 6 / Euro 6	(18)
			3400 700 464 3482 000 859 1878 005 600 3151 000 651	362 10 MF362 362WGTZ KZIS-4	Getr. / GBox: 6 S 800 Getr. / GBox: 6 AS 800 Euro 6 / Euro 6	(18)
			3400 700 603 3482 001 166 1878 007 172 3151 000 397	350 MF350 350WGTZ KZIS-4	Getr. / GBox: S5-42 Euro 6 / Euro 6	(18)
FA 210	05.13-	PX-5157	3400 700 465 3482 000 859 1878 005 601 3151 000 651	362 10 MF362 362WGTZ KZIS-4	Getr. / GBox: 6 S 700 Getr. / GBox: 6 AS 700 Euro 6 / Euro 6	(18)
			3400 700 464 3482 000 859 1878 005 600 3151 000 651	362 10 MF362 362WGTZ KZIS-4	Getr. / GBox: 6 S 800 Getr. / GBox: 6 AS 800 Euro 6 / Euro 6	(18)
			3400 700 603 3482 001 166 1878 007 172 3151 000 397	350 MF350 350WGTZ KZIS-4	Getr. / GBox: S5-42 Euro 6 / Euro 6	(18)

Kenngrößen

Kupplungsdruckplatten

Z/	Für Zweischeibenausführung
400	Reibflächenaußendurchmesser 400 mm
Do	Doppelkupplung, abhängige Ausrückung
Du	Doppelkupplung, unabhängige Ausrückung
/E	XTend
F	Flaches Schwungrad
G	Kupplung mit Gußgehäuse
K	Schraubenfederkupplung
KM	Mit Membranfeder und Hebelsystem
M	Membranfederkupplung
N	Nebenantrieb
S	Schwenkbolzenausführung
T	Mit Tellerfeder
XTend	Mit automatischer Nachstellung
Z	Ausrückung auf Zug

Kupplungsscheiben

200	Außendurchmesser 200 mm
CE	Anorganischer Sinterbelag
B/D/E/Z	Belagfederungen
BH/GS/GT/GV	Torsionsdämpfer für Nfz
/E	XTend
W/V	Vordämpfer für Nfz

Ausrücklager

...A	Außenring mitlaufend
G	Grafitanlaufring
GK	Grafitanlaufring und Kugellager
GR	Kugellager mit Blechkappe
GZ	Geberzylinder
HHIS	Konzentrischer Nehmerzylinder
...I	Innenring mitlaufend
KT	Teflonanlaufscheibe
KZ	Kugellager, zentralgeführt
NZ	Nehmerzylinder
...S	Selbstzentrierender Innenring
...Z	Ausrückung auf Zug

General Information



The products listed in this catalog must be installed in a workshop by qualified personnel only.

To fulfill your request, we need the complete order number, for example:

Clutch kit	3400 122 201
Clutch pressure plate	3482 083 032
Clutch disk	1878 004 832
Releaser	3151 000 034

In case of doubt, please provide the type description and the model year of the vehicle for which the desired item is intended.

This catalog is only an excerpt of our product range - our electronic media provide a complete overview.

All rights reserved. Duplication or joint use of this catalog, even in extracts, for the creation of your own catalog is prohibited, unless explicit consent is given.

Replacement part numbers from the vehicle manufacturer serve only for purposes of comparison. Use of such information in invoices to the vehicle owner is not permitted.

Current terms and conditions are available at www.zf.com/aftermarket/documents

www.zf.com/aftermarket/catalog

WebCat

Online catalog

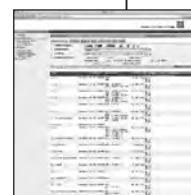

InCat

Electronic catalog



PrintCat

Printed catalogs



Contents

Index	U2
Symbols	U3 - U4
General Information	V5
Catalog structure	V6
Parameters	V6
Part number list	938 - 984
Cross reference list	985 - 1028
New to range	1029 - 1034
Amended part number	1034 - 1035
Deleted numbers	1036
Measure table for hub profiles	1037
Measure table for flywheels	1038 - 1039
Parts List for double disc clutch	1040

Catalog structure

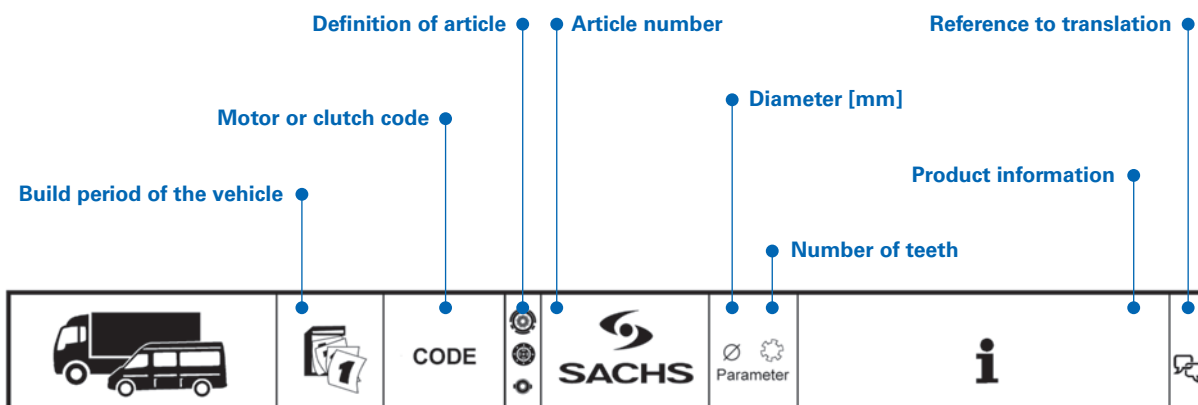

DAF

LF		05.13 -					
FA 180	05.13-	PX-5135	3400 700 465 ⊗ 3482 000 859 ⊗ 1878 005 601 ⊕ 3151 000 651	362 10 MF362 362WGTZ KZIS-4	Getr. / GBox: 6 S 700 Getr. / GBox: 6 AS 700 Euro 6 / Euro 6	(18)	
			3400 700 464 ⊗ 3482 000 859 ⊗ 1878 005 600 ⊕ 3151 000 651	362 10 MF362 362WGTZ KZIS-4	Getr. / GBox: 6 S 800 Getr. / GBox: 6 AS 800 Euro 6 / Euro 6	(18)	
			3400 700 603 ⊗ 3482 001 166 ⊗ 1878 007 172 ⊕ 3151 000 397	350 MF350 350WGTZ KZIS-4	Getr. / GBox: S5-42 Euro 6 / Euro 6	(18)	
FA 210	05.13-	PX-5157	3400 700 465 ⊗ 3482 000 859 ⊗ 1878 005 601 ⊕ 3151 000 651	362 10 MF362 362WGTZ KZIS-4	Getr. / GBox: 6 S 700 Getr. / GBox: 6 AS 700 Euro 6 / Euro 6	(18)	
			3400 700 464 ⊗ 3482 000 859 ⊗ 1878 005 600 ⊕ 3151 000 651	362 10 MF362 362WGTZ KZIS-4	Getr. / GBox: 6 S 800 Getr. / GBox: 6 AS 800 Euro 6 / Euro 6	(18)	
			3400 700 603 ⊗ 3482 001 166 ⊗ 1878 007 172 ⊕ 3151 000 397	350 MF350 350WGTZ KZIS-4	Getr. / GBox: S5-42 Euro 6 / Euro 6	(18)	

Parameters

Clutch pressure plates	
Z/	For twin disk design
400	Outer friction surface diameter = 400 mm
Do	Double clutch, dependent disengagement
Du	Double clutch, independent disengagement
/E	XTend
F	Flat flywheel
G	Clutch with cast iron housing
K	Coil spring clutch
KM	With diaphragm spring and lever system
M	Diaphragm spring clutch
N	Power take-off
S	Eye bolt design
T	With plate spring
XTend	With automatic adjustment
Z	Pull-type release

Clutch disks	
200	Outer diameter 200 mm
CE	Non-organic sinter lining
B/D/E/Z	Cushion
BH/GS/GT/GV	Torsion dampers for CV
/E	XTend
W/V	Preliminary dampers for CV

Predamper	
...A	Running outer ring
G	Graphite thrust ring
GK	Graphite thrust ring and ball bearing
GR	Ball bearing with metal cap
GZ	Master cylinder
HHIS	Concentric slave cylinder
...I	Running inner ring
KT	Teflon thrust washer
KZ	Ball bearing, central feed
NZ	Slave cylinder
...S	Self-centering inner ring
...Z	Pull-type release

Informations générales



Tous les produits mentionnés dans ce catalogue doivent exclusivement être montés par le personnel formé d'un atelier automobile qualifié.

Pour répondre à vos exigences, nous avons besoin de connaître le numéro de commande complet, par exemple :

Kit d'embrayage	3400 122 201
Mécanisme d'embrayage	3482 083 032
Disque d'embrayage	1878 004 832
Butée	3151 000 034

En cas de doute, indiquez la désignation du modèle et l'année de construction du véhicule pour lequel la pièce souhaitée est destinée.

Ce catalogue représente un extrait de notre gamme de produits. Vous trouverez un aperçu complet sur nos médias électroniques.

Tous droits réservés. La reproduction ou l'utilisation, même partielle, de ce catalogue pour l'élaboration de son propre catalogue est interdite sans notre autorisation expresse.

Les numéros de pièces détachées des constructeurs de véhicules sont uniquement indiqués aux fins de comparaison. Le report de ces données sur les factures destinées au propriétaire du véhicule est illicite.

Vous trouverez les conditions générales sur Internet www.zf.com/aftermarket/documents

www.zf.com/aftermarket/catalog

WebCat

Catalogue en ligne

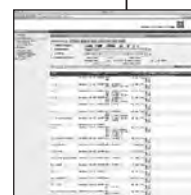

InCat

Catalogue électronique



PrintCat

Catalogues papier



Sommaire

Index	U2
Symboles	U3 - U4
Informations générales	V7
Structure du catalogue	V8
Caractéristiques	V8
Traductions	V9 - V11
Liste des pièces	938 - 984
Liste comparative	985 - 1028
Nouveautés	1029 - 1034
Références modifiées	1034 - 1035
Numéros barrés	1036
Table métrologique pour cannelures de moyeu	1037
Table métrologique pour volants moteurs	1038 - 1039
Nomenclatures pour embrayages bi-disques	1040

Structure du catalogue

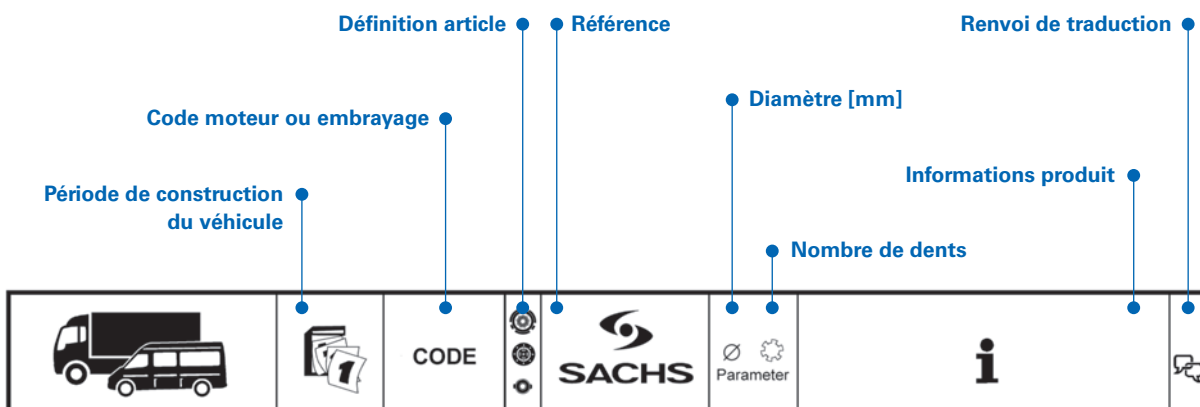

DAF

LF		05.13 -					
FA 180	05.13-	PX-5135		3400 700 465	362 10	Getr. / GBox: 6 S 700	(18)
				3482 000 859	MF362	Getr. / GBox: 6 AS 700	
				1878 005 601	362WGTZ	Euro 6 / Euro 6	
				3151 000 651	KZIS-4		
				3400 700 464	362 10	Getr. / GBox: 6 S 800	(18)
				3482 000 859	MF362	Getr. / GBox: 6 AS 800	
				1878 005 600	362WGTZ	Euro 6 / Euro 6	
				3151 000 651	KZIS-4		
				3400 700 603	350	Getr. / GBox: S5-42	(18)
				3482 001 166	MF350	Euro 6 / Euro 6	
				1878 007 172	350WGTZ		
				3151 000 397	KZIS-4		
FA 210	05.13-	PX-5157		3400 700 465	362 10	Getr. / GBox: 6 S 700	(18)
				3482 000 859	MF362	Getr. / GBox: 6 AS 700	
				1878 005 601	362WGTZ	Euro 6 / Euro 6	
				3151 000 651	KZIS-4		
				3400 700 464	362 10	Getr. / GBox: 6 S 800	(18)
				3482 000 859	MF362	Getr. / GBox: 6 AS 800	
				1878 005 600	362WGTZ	Euro 6 / Euro 6	
				3151 000 651	KZIS-4		
				3400 700 603	350	Getr. / GBox: S5-42	(18)
				3482 001 166	MF350	Euro 6 / Euro 6	
				1878 007 172	350WGTZ		
				3151 000 397	KZIS-4		

Caractéristiques

Mécanismes d'embrayage

2/	Pour version bidisque
400	Diamètre extérieur surface de frottement 400 mm
Do	Embrayage double, débrayage dépendant
Du	Embrayage double, débrayage indépendant
/E	XTend
F	Volant moteur plat
G	Avec carter en fonte
K	Embrayage à levier
KM	Avec ressort diaphragme et système levier
M	Embrayage à diaphragme
N	Prise de force
S	Modèle axe de pivotement
T	Avec rondelles-ressorts
XTend	Avec ajustement automatique
Z	Embrayage version tiré

Disques d'embrayage

200	Diamètre extérieur 200 mm
CE	Garniture frittée non-organique
B/D/E/Z	Lamelles de progressivité
BH/GS/GT/GV	Amortisseur de torsion pour véhicules industriels
/E	XTend
W/V	Pré-amortisseur pour véhicules industriels

Butée de débrayage

...A	Bague extérieure entraînée
G	Bague de friction en graphite
GK	Bague de friction en graphite et roulement à billes
GR	Roulement à billes avec cache en tôle
GZ	Cylindre émetteur
HHIS	Cylindre récepteur concentrique
...I	Bague intérieure entraînée
KT	Rondelle de friction en téflon
KZ	Roulement à billes, guidage central
NZ	Cylindre récepteur
...S	Bague intérieure à centrage automatique
...Z	Embrayage version tiré

Traductions

(1)	Nombre d'alésages de fixation sur CSC : 2
(2)	Nombre d'alésages de fixation sur CSC : 3
(3)	Nombre de garnitures
(4)	Fourche de débrayage suspendue [mm]
(5)	Fourche de débrayage debout [mm]
(6)	Élément de rechange remplacé par 3400 121 002
(7)	Diamètre extérieur [mm]
(8)	En cas de problèmes de bruit
(9)	Contient butée et kit de montage
(10)	Contient volant bimasse ZMS, plateau de pression, disque d'embrayage et débrayeur
(11)	Contient volant bimasse ZMS, plateau de pression, disque d'embrayage et butée hydraulique
(12)	Largeur [mm]
(13)	Diesel
(14)	Diamètre du raccord de la conduite de pression [mm]
(15)	Euro 3
(16)	Euro 4 (D4)
(17)	Euro 5
(18)	Euro 6
(19)	Euro 3 / Euro 4
(20)	Euro 4 / Euro 5
(21)	Euro 5 / Euro 6
(22)	Le véhicule peut être monté avec différentes tailles d'embrayages
(23)	Les véhicules peuvent être équipés de différents composants
(24)	Transmission Fuller
(25)	Fluide : liquide de frein
(26)	Fluide : huile minérale
(27)	Pour export
(28)	Numéro de transmission
(29)	Longueur de manchon [mm]
(30)	Renouveler systématiquement
(31)	Compris dans 1888
(32)	Compris dans 3483/3488
(33)	Compris dans 3488
(34)	Diamètre intérieur [mm]
(35)	Avec embrayage différent selon le choix du client
(36)	Longueur de câble [mm]
(37)	Caractéristique
(38)	Roulement à billes
(39)	Disque d'embrayage avec pré-amortisseur
(40)	Puissance [kW]
(41)	Disque d'embrayage amovible
(42)	Version nationale : Grande-Bretagne
(43)	Version nationale : Turquie
(44)	Longueur de tige de piston [mm]
(45)	Longueur [mm]
(46)	Type de montage : non pré-assemblé
(47)	Kit de montage pour butée d'embrayage
(48)	Cannelure de moyeu
(49)	Roulement à aiguilles

Traductions

- (50) ID de prise de force
- (51) Disponible uniquement en cas de retour de pièce usagée (réparation; usine Bielefeld)
- (52) Ne monter que si le véhicule est équipé d'un embrayage M
- (53) À monter ensemble uniquement
- (54) Numéro de production
- (55) À partir du numéro de production
- (56) Jusqu'au numéro de production
- (57) Empattement [mm]
- (58) Modèle de rouleau
- (59) Boîte de vitesses séquentielle
- (60) Modèle spécial
- (61) Disque d'embrayage avec ressorts de torsion
- (62) Transmission ZF
- (63) Kit de réparation alternatif
- (65) Comprend des vis de fixation pour plateau de pression
- (66) Comprend des vis de fixation pour le volant moteur
- (67) Comprend un disque d'embrayage
- (68) Comprend deux disques d'embrayage
- (69) Pour
- (70) Pour fourche d'embrayage avec cames
- (71) Pour fourche d'embrayage avec rouleaux
- (72) Pour véhicules avec embrayage monodisque
- (73) Pour véhicules avec multiplicateur d'effort d'embrayage
- (74) Pour véhicules avec système de freinage à basse pression
- (75) Pour véhicules avec ralentisseur
- (76) Pour véhicules avec embrayage de pontage de convertisseur
- (77) Pour véhicules avec embrayage bi-disques
- (78) Pour diamètre intérieur de ressort à diaphragme 100 mm
- (79) Pour diamètre intérieur de ressort à diaphragme 120 mm
- (80) Pour moteurs avec volant bimasse
- (81) Pour moteurs sans volant bimasse
- (82) Pour prise de force
- (83) Pour numéro OE
- (84) Pour profondeur volant [mm]
- (85) Selon le modèle avec embrayage différent
- (86) Étrier long
- (87) Couple moteur maximum transmissible [Nm]
- (88) Avec bague de friction
- (89) Avec lubrification permanente
- (90) Avec ralentisseur VR 115E
- (91) Avec raccord pour tuyau de graissage
- (92) Avec capteur
- (93) Avec accessoires
- (94) Avec bague intermédiaire
- (95) Avec ajustement automatique
- (96) Pas pour
- (97) Pas pour numéro de châssis
- (98) Pas pour numéro de moteur
- (99) Pas en combinaison avec disque d'embrayage de remplacement

Traductions

(100) Uniquement comme remplacement des n° OE indiqués

(101) Uniquement en combinaison avec

(102) Sans bague de friction

(103) Sans raccord pour tuyau de graissage

(104) Sans vis de fixation pour le volant moteur

(105) Sans capteur

(106) Sans bague intermédiaire

DE

EN

FR

ES

PT

IT

NL

NO

SV

FI

PL

RU

HU

CS

RO

HR

EL

TR

ZH

DE

EN

FR

ES

PT

IT

NL

NO

SV

FI

PL

RU

HU

CS

RO

HR

EL

TR

ZH

Memo

Información general



Los productos indicados en este catálogo sólo los puede montar el personal cualificado de un taller mecánico.

Para poder tramitar su solicitud necesitamos el número de pedido completo, por ejemplo:

Kit de embrague	3400 122 201
Plato de presión del embrague	3482 083 032
Disco de embrague	1878 004 832
Dispositivo de desembrague	3151 000 034

En caso de duda, se deberá indicar la designación del tipo y el año de construcción del vehículo, para el que se requiere el artículo deseado.

Este catálogo es un extracto de nuestra gama de productos. Podrá ver una versión completa en nuestros medios electrónicos.

Quedan reservados todos los derechos.

Queda prohibida la reproducción o el uso de este catálogo (también de forma parcial) para la elaboración de un catálogo propio sin consentimiento expreso.

Los números de las piezas de recambio del fabricante solo se usan para compararlos. No está permitido el empleo de este tipo de datos en las facturas emitidas al propietario del vehículo.

Puede encontrar las condiciones generales de contratación en www.zf.com/aftermarket/documents

www.zf.com/aftermarket/catalog

WebCat
Catálogo online

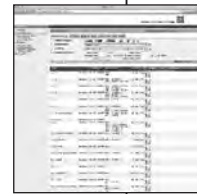

InCat
Catálogo electrónico



PrintCat
Catálogos impresos



Índice

Index	U2
Símbolos	U3 - U4
Información general	V13
Estructura del catálogo	V14
Parámetros	V14
Traducciones	V15 - V17
Lista aritmética	938 - 984
Lista comparativa	985 - 1028
Novedades	1029 - 1034
Número de pedido modificado	1034 - 1035
Referencias eliminadas	1036
Tabla de medidas para perfiles del cubo	1037
Tabla de medidas para volantes motor	1038 - 1039
Listas de piezas para embragues bidisco	1040

Estructura del catálogo

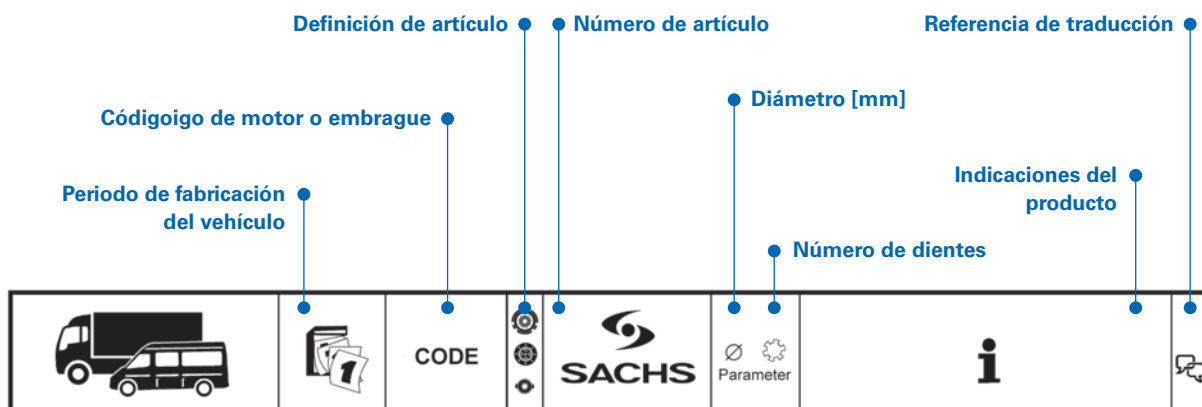

DAF

LF		05.13 -					
FA 180	05.13-	PX-5135		3400 700 465	362 10	Getr. / GBox: 6 S 700	(18)
				3482 000 859	MF362	Getr. / GBox: 6 AS 700	
				1878 005 601	362WGTZ	Euro 6 / Euro 6	
				3151 000 651	KZIS-4		
				3400 700 464	362 10	Getr. / GBox: 6 S 800	(18)
				3482 000 859	MF362	Getr. / GBox: 6 AS 800	
				1878 005 600	362WGTZ	Euro 6 / Euro 6	
				3151 000 651	KZIS-4		
				3400 700 603	350	Getr. / GBox: S5-42	(18)
				3482 001 166	MF350	Euro 6 / Euro 6	
				1878 007 172	350WGTZ		
				3151 000 397	KZIS-4		
FA 210	05.13-	PX-5157		3400 700 465	362 10	Getr. / GBox: 6 S 700	(18)
				3482 000 859	MF362	Getr. / GBox: 6 AS 700	
				1878 005 601	362WGTZ	Euro 6 / Euro 6	
				3151 000 651	KZIS-4		
				3400 700 464	362 10	Getr. / GBox: 6 S 800	(18)
				3482 000 859	MF362	Getr. / GBox: 6 AS 800	
				1878 005 600	362WGTZ	Euro 6 / Euro 6	
				3151 000 651	KZIS-4		
				3400 700 603	350	Getr. / GBox: S5-42	(18)
				3482 001 166	MF350	Euro 6 / Euro 6	
				1878 007 172	350WGTZ		
				3151 000 397	KZIS-4		

Parámetros

Platos de presión del embrague	
Z/	Para modelo con disco doble
400	Diámetro exterior de las superficies de fricción 400 mm
Do	Doble embrague, desembrague dependiente
Du	Doble embrague, desembrague independiente
/E	XTend
F	Volante motor plano
G	Embrague con cárter de fundición
K	Embrague de muelle helicoidal
KM	Con muelle de membrana y sistema de palanca
M	Embrague de muelle de membrana
N	Mando auxiliar
S	Modelo de pasador pivote
T	Con muelle belleville
XTend	Con ajuste automático
Z	Desembrague de tracción

Discos de embrague	
200	Diámetro exterior 200 mm
CE	Revestimiento sinterizado inorgánico
B/D/E/Z	Apoyos flexibles del revestimiento
BH/GS/GT/GV	Amortiguador de torsión para vehículos industriales
/E	XTend
W/V	Pre-amortiguador para vehículos industriales

Cojinete de desembrague	
...A	Anillo exterior seguidor
G	Anillo de empuje de grafito
GK	Anillo de empuje de grafito y rodamiento de bolas
GR	Rodamiento de bolas con tapa de chapa
GZ	Cilindro principal
HHIS	Cilindro receptor concéntrico
...I	Anillo interior seguidor
KT	Arandela de tope de teflón
KZ	Rodamiento de bolas, centrado
NZ	Cilindro receptor
...S	Anillo interior autocentrante
...Z	Desembrague de tracción

Traducciones

(1)	Número de agujeros de montaje del CSC: 2
(2)	Número de agujeros de montaje del CSC: 3
(3)	Número de forros
(4)	Horquilla de desembrague suspendida [mm]
(5)	Horquilla de desembrague vertical [mm]
(6)	Pieza de repuesto sustituida por 3400 121 002
(7)	Diámetro exterior [mm]
(8)	En caso de problemas de ruidos
(9)	Contiene dispositivo de desembrague y kit de montaje
(10)	Contiene volante bimasa (ZMS), plato de presión, disco de embrague y dispositivo de desembrague
(11)	Contiene volante bimasa (ZMS), plato de presión, disco de embrague y CSC
(12)	Ancho [mm]
(13)	Gasóleo
(14)	Diámetro de la conexión de la tubería de presión [mm]
(15)	Euro 3
(16)	Euro 4 (D4)
(17)	Euro 5
(18)	Euro 6
(19)	Euro 3 / Euro 4
(20)	Euro 4 / Euro 5
(21)	Euro 5 / Euro 6
(22)	El vehículo se puede montar con diversos tamaños de embrague
(23)	Los vehículos se pueden equipar con distintos componentes
(24)	Caja de cambios Fuller
(25)	Medio de llenado: líquido de frenos
(26)	Medio de llenado: aceite mineral
(27)	Para exportación
(28)	Número de caja de cambios
(29)	Longitud del manguito
(30)	Sustituir siempre
(31)	Incluido en 1888
(32)	Incluido en 3483/3488
(33)	Incluido en 3488
(34)	Diámetro interior [mm]
(35)	Equipado con diferente embrague (según petición del cliente)
(36)	Longitud de cable [mm]
(37)	Parámetro
(38)	Rodamiento de bolas
(39)	Disco de embrague con amortiguador previo
(40)	Potencia [kW]
(41)	Disco de embrague suelto
(42)	Modelo nacional: Gran Bretaña
(43)	Modelo nacional: Turquía
(44)	Longitud del vástago de pistón [mm]
(45)	Longitud [mm]
(46)	Tipo de montaje: no premontado
(47)	Juego de montaje para cojinete de desembrague
(48)	Perfil del buje

DE

EN

FR

ES

PT

IT

NL

NO

SV

FI

PL

RU

HU

CS

RO

HR

EL

TR

ZH

Traducciones

- (49) Cojinete de agujas
- (50) ID de mando auxiliar
- (51) Sólo disponible para devolución de piezas usadas (reparación, fábrica en Bielefeld)
- (52) Montar solamente si el vehículo está equipado con embrague de tipo M
- (53) Montar solamente en conjunto
- (54) Número de producción
- (55) Desde número de producción
- (56) Hasta número de producción
- (57) Distancia entre ejes [mm]
- (58) Versión de rodillo
- (59) Caja de cambios manual, secuencial
- (60) Modelo especial
- (61) Disco de embrague con amortiguador de torsión
- (62) Caja de cambios ZF
- (63) Kit de reparación opcional
- (65) Incluye los tornillos de fijación del plato de presión
- (66) Incluye tornillos de fijación de motor volante
- (67) Incluye un disco de embrague
- (68) Incluye dos discos de embrague
- (69) Para
- (70) Para horquilla de desembrague con levas
- (71) Para horquilla de desembrague con rodillos
- (72) Para vehículos con embrague monodisco
- (73) Para vehículos con servoembrague
- (74) Para vehículos con sistema de frenado de baja presión
- (75) Para vehículos con retardador
- (76) Para vehículos con convertidor de par
- (77) Para vehículos con embrague de disco doble
- (78) Para un diámetro interior del muelle de diafragma de 100 mm
- (79) Para un diámetro interior del muelle de diafragma de 120 mm
- (80) Para motores con volante bimasa
- (81) Para motores sin volante bimasa
- (82) Para mando auxiliar
- (83) Para número OE
- (84) Para profundidad de volante [mm]
- (85) Con diferente embrague según versión
- (86) Brida de fijación larga
- (87) Par del motor máximo transmisible [Nm]
- (88) Con anillo de empuje
- (89) Con lubricación permanente
- (90) Con retardador VR 115E
- (91) Con conexión para tubo de engrase
- (92) Con sensor
- (93) Con accesorios
- (94) Con anillo intermedio
- (95) Con ajuste automático
- (96) No para
- (97) No para número de chasis
- (98) No para número de motor

Traducciones

(99) No en conexión con el disco de embrague de recambio

(100) Solo como recambio para los n.º OE indicados

(101) Solo en conexión con

(102) Sin anillo de empuje

(103) Sin conexión para tubo de engrase

(104) Sin tornillos de fijación de volante

(105) Sin sensor

(106) Sin anillo intermedio

DE

EN

FR

ES

PT

IT

NL

NO

SV

FI

PL

RU

HU

CS

RO

HR

EL

TR

ZH

DE

EN

FR

ES

PT

IT

NL

NO

SV

FI

PL

RU

HU

CS

RO

HR

EL

TR

ZH

Memo

Informações gerais



Todos os produtos listados neste catálogo podem ser montados apenas por pessoal qualificado de uma oficina especializada.

Para responder aos seus requisitos, precisamos do número de referência completo, por exemplo:

Kit de embreagem	3400 122 201
Placa de pressão da embreagem	3482 083 032
Disco de embreagem	1878 004 832
Dispositivo de desengate	3151 000 034

Em caso de dúvidas, indicar a designação do tipo e o ano de fabricação do veículo para o qual o artigo pretendido se destina.

O presente catálogo representa um excerto da nossa gama de produtos; para uma visão geral completa consulte os nossos mídias eletrônicas.

Todos os direitos reservados.

Não é permitida a reprodução ou o compartilhamento deste catálogo, mesmo que em parte, para a criação de um catálogo próprio sem a autorização expressa.

Os números das peças sobresselentes do fabricante de veículos destinam-se apenas a fins comparativos. Não é permitida uma utilização de indicações deste tipo nas faturas enviadas ao proprietário do veículo.

As condições gerais de venda atualmente em vigor podem ser consultadas em www.zf.com/aftermarket/documents

www.zf.com/aftermarket/catalog

WebCat
Catálogo online

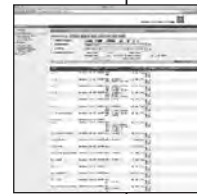

InCat
Catálogo eletrônico



PrintCat
Catálogos impresso



Índice

Index	U2
Símbolos	U3 - U4
Informações gerais	V19
Estrutura do catálogo	V20
Parâmetros	V20
Traduções	V21 - V23
Lista aritmética	938 - 984
Lista comparativa	985 - 1028
Novas adições	1029 - 1034
Número de pedido alterado	1034 - 1035
Números eliminados	1036
Tabela de dimensões para perfis do cubo	1037
Tabela de dimensões para volantes	1038 - 1039
Listas de peças para embreagens de dois discos	1040

Estrutura do catálogo

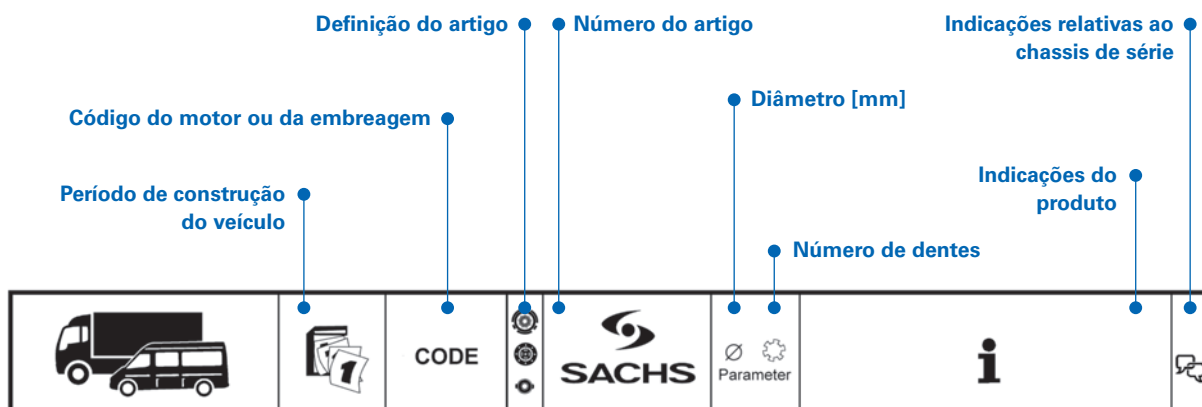

DAF

LF		05.13 -					
FA 180	05.13-	PX-5135		3400 700 465	362 10	Getr. / GBox: 6 S 700	(18)
				3482 000 859	MF362	Getr. / GBox: 6 AS 700	
				1878 005 601	362WGTZ	Euro 6 / Euro 6	
				3151 000 651	KZIS-4		
				3400 700 464	362 10	Getr. / GBox: 6 S 800	(18)
				3482 000 859	MF362	Getr. / GBox: 6 AS 800	
				1878 005 600	362WGTZ	Euro 6 / Euro 6	
				3151 000 651	KZIS-4		
				3400 700 603	350	Getr. / GBox: S5-42	(18)
				3482 001 166	MF350	Euro 6 / Euro 6	
				1878 007 172	350WGTZ		
				3151 000 397	KZIS-4		
FA 210	05.13-	PX-5157		3400 700 465	362 10	Getr. / GBox: 6 S 700	(18)
				3482 000 859	MF362	Getr. / GBox: 6 AS 700	
				1878 005 601	362WGTZ	Euro 6 / Euro 6	
				3151 000 651	KZIS-4		
				3400 700 464	362 10	Getr. / GBox: 6 S 800	(18)
				3482 000 859	MF362	Getr. / GBox: 6 AS 800	
				1878 005 600	362WGTZ	Euro 6 / Euro 6	
				3151 000 651	KZIS-4		
				3400 700 603	350	Getr. / GBox: S5-42	(18)
				3482 001 166	MF350	Euro 6 / Euro 6	
				1878 007 172	350WGTZ		
				3151 000 397	KZIS-4		

Parâmetros

Placas de pressão da embreagem	
Z/	Para versão de dois pratos
400	Diâmetro exterior da superfície de atrito 400 mm
Do	Embreagem dupla, desengate dependente
Du	Embreagem dupla, desengate independente
/E	XTend
F	Volante de inércia plano
G	Embreagem com carcaça fundida
K	Embreagem de mola helicoidal
KM	Com mola de diafragma e sistema de alavancas
M	Embreagem de mola de diafragma
N	Acionamento auxiliar
S	Versão de pino rotativo
T	Com mola tipo prato
XTend	Com ajuste automático
Z	Desengate por tração

Discos de embreagem	
200	Diâmetro exterior 200 mm
CE	Revestimento sinterizado inorgânico
B/D/E/Z	Suspensões do revestimento
BH/GS/GT/GV	Amortecedores da rotação para veículos utilitários
/E	XTend
W/V	Pré-amortecedor para veículos utilitários

Rolamento de embreagem	
...A	Anel exterior em rotação
G	Anel de encosto de grafite
GK	Anel de encosto de grafite e rolamento de esferas
GR	Rolamento de esferas com capa de chapa
GZ	Cilindro mestre
HHIS	Cilindro escravo concêntrico
...I	Anel interior em rotação
KT	Disco de partida em teflon
KZ	Rolamento de esferas, com controle central
NZ	Cilindro escravo
...S	Anel interior com centralização automática
...Z	Desengate por tração

Traduções

(1)	Número de orifícios de fixação no CSC (cilindro escravo concêntrico): 2
(2)	Número de orifícios de fixação no CSC (cilindro escravo concêntrico): 3
(3)	Número de revestimentos
(4)	Garfo de embreagem suspenso [mm]
(5)	Garfo de embreagem parado [mm]
(6)	Peça de substituição substituída por 3400 121 002
(7)	Diâmetro externo [mm]
(8)	Em caso de problemas de ruído
(9)	Contém dispositivo de engate e kit de montagem
(10)	Contém VDM, placa de pressão, disco de embreagem e dispositivo de engate
(11)	Contém VDM, placa de pressão, disco de embreagem e CSC
(12)	Largura [mm]
(13)	Diesel
(14)	Diâmetro Conexão de tubulação de pressão [mm]
(15)	Euro 3
(16)	Euro 4 (D4)
(17)	Euro 5
(18)	Euro 6
(19)	Euro 3 / Euro 4
(20)	Euro 4 / Euro 5
(21)	Euro 5 / Euro 6
(22)	O veículo pode estar equipado com acoplamentos de diferentes tamanhos
(23)	Os veículos podem estar equipados com diferentes componentes
(24)	Caixa de câmbio Fuller
(25)	Meio de enchimento: líquido de frenagem
(26)	Meio de enchimento: óleo mineral
(27)	Para exportação
(28)	Número da caixa de câmbio
(29)	Comprimento da manga [mm]
(30)	Substituir sempre
(31)	Incluído em 1888... ..
(32)	Incluído em 3483/3488... ..
(33)	Incluído em 3488... ..
(34)	Diâmetro interior [mm]
(35)	Com embreagem diferente consoante o desejo do cliente
(36)	Meio de enchimento: líquido de frenagem
(37)	Parâmetro
(38)	Rolamento de esferas
(39)	Disco de embreagem com amortecedor prévio
(40)	Potência [kW]
(41)	Disco de embreagem solto
(42)	Versão do país: Grã-Bretanha
(43)	Versão do país: Turquia
(44)	Comprimento biela do pistão [mm]
(45)	Comprimento [mm]
(46)	Tipo de montagem: sem pré-instalação
(47)	Kit de montagem para rolamento de embreagem
(48)	Perfil do cubo
(49)	Rolamento de agulhas

DE

EN

FR

ES

PT

IT

NL

NO

SV

FI

PL

RU

HU

CS

RO

HR

EL

TR

ZH

Traduções

- (50) Identificação do acionamento auxiliar
- (51) Apenas disponível na devolução da peça antiga (reparo; fábrica Bielefeld)
- (52) Montar apenas se o veículo estiver equipado com embreagem M
- (53) Montar apenas em conjunto
- (54) Número de produção
- (55) A partir do número de produção
- (56) Até o número de produção
- (57) Distância entre eixos [mm]
- (58) Versão com rolos
- (59) Caixa de câmbio manual sequencial
- (60) Versão especial
- (61) Disco de embreagem com molas de torção
- (62) Caixa de câmbio ZF
- (63) Conjunto de reparo alternativo
- (65) Contém parafusos de fixação da placa de pressão
- (66) Contém parafusos de fixação do volante de inércia
- (67) Inclui um disco de embreagem
- (68) Inclui dois discos de embreagem
- (69) Para
- (70) Para garfo de embreagem com cames
- (71) Para garfo de embreagem com rolos
- (72) Para veículos com embreagem monodisco
- (73) Para veículos com reforço da pressão da embreagem
- (74) Para veículos com sistema de frenagem de baixa pressão
- (75) Para veículos com retarder
- (76) Para veículos com embreagem do conversor de torque
- (77) Para veículos com embreagem de disco duplo
- (78) Para diâmetros internos da mola de diafragma de 100 mm
- (79) Para diâmetros internos da mola de diafragma de 120 mm
- (80) Para motores com volante de dupla massa
- (81) Para motores sem volante de dupla massa
- (82) Para o acionamento auxiliar
- (83) Para número OE
- (84) Para profundidade do volante de inércia [mm]
- (85) Consoante a versão, com embreagem diferente
- (86) Alça comprida
- (87) Torque do motor máximo transferível [Nm]
- (88) Com anel de encosto
- (89) Com lubrificação permanente
- (90) Com retarder VR 115E
- (91) Com conexão ao tubo de lubrificante
- (92) Com sensor
- (93) Com acessórios
- (94) Com anel intermediário
- (95) Com ajuste automático
- (96) Não para
- (97) Não para número do chassis
- (98) Não para número do motor
- (99) Não em conjunto com disco de embreagem-de substituição

Traduções

- (100) Apenas como substituição para o nº OE indicado
- (101) Apenas em conjunto com
- (102) Sem anel de encosto
- (103) Sem conexão ao tubo de lubrificante
- (104) Sem parafusos de fixação do volante de inércia
- (105) Sem sensor
- (106) Sem anel intermediário

DE

EN

FR

ES

PT

IT

NL

NO

SV

FI

PL

RU

HU

CS

RO

HR

EL

TR

ZH

DE

EN

FR

ES

PT

IT

NL

NO

SV

FI

PL

RU

HU

CS

RO

HR

EL

TR

ZH

Memo

Informazioni generali



Tutti i prodotti riportati in questo catalogo possono essere impiegati solo dal personale qualificato di una autofficina.

Per soddisfare le vostre richieste, abbiamo bisogno del numero di ordine completo, ad esempio:

Kit frizione	3400 122 201
Spingidisco della frizione	3482 083 032
Disco frizione	1878 004 832
Cuscinetto reggispinta	3151 000 034

In caso di dubbio fornire il nome del modello e l'anno di costruzione del veicolo per il quale è destinato l'articolo desiderato.

Questo catalogo rappresenta un estratto della nostra gamma di prodotti, una panoramica completa è disponibile sui nostri siti web.

Tutti i diritti riservati. La riproduzione o la condivisione di questo catalogo, anche parziale, per la realizzazione di un proprio catalogo non sono consentite previo consenso espresso.

I numeri dei ricambi del produttore di veicoli servono solo a scopi comparativi. Un utilizzo di tali dati in fatture inviate ai proprietari dei veicoli non è consentito.

Le condizioni commerciali generali aggiornate sono reperibili all'indirizzo www.zf.com/aftermarket/documents

www.zf.com/aftermarket/catalog

WebCat
Catalogo online

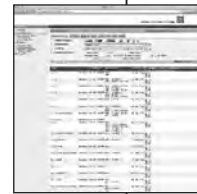

InCat
Catalogo elettronico



PrintCat
Cataloghi stampati



Indice

Index	U2
Simboli	U3 - U4
Informazioni generali	V25
Struttura del catalogo	V26
Grandezze caratteristiche	V26
Traduzioni	V27 - V29
Lista aritmetica	938 - 984
Elenco di confronto	985 - 1028
Nuove acquisizioni	1029 - 1034
Numero d'ordine modificato	1034 - 1035
Numeri eliminati	1036
Tabella misure per profili mozzo	1037
Tabella misure per dischi del volante	1038 - 1039
Distinte base per frizione a due dischi	1040

Struttura del catalogo

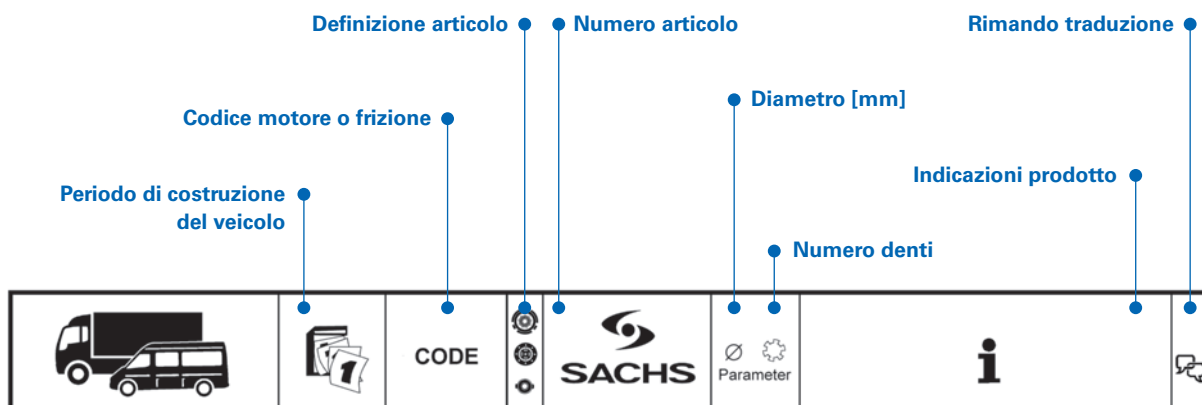

DAF

LF		05.13 -					
FA 180	05.13-	PX-5135		3400 700 465	362 10	Getr. / GBox: 6 S 700	(18)
				3482 000 859	MF362	Getr. / GBox: 6 AS 700	
				1878 005 601	362WGTZ	Euro 6 / Euro 6	
				3151 000 651	KZIS-4		
				3400 700 464	362 10	Getr. / GBox: 6 S 800	(18)
				3482 000 859	MF362	Getr. / GBox: 6 AS 800	
				1878 005 600	362WGTZ	Euro 6 / Euro 6	
				3151 000 651	KZIS-4		
				3400 700 603	350	Getr. / GBox: S5-42	(18)
				3482 001 166	MF350	Euro 6 / Euro 6	
				1878 007 172	350WGTZ		
				3151 000 397	KZIS-4		
FA 210	05.13-	PX-5157		3400 700 465	362 10	Getr. / GBox: 6 S 700	(18)
				3482 000 859	MF362	Getr. / GBox: 6 AS 700	
				1878 005 601	362WGTZ	Euro 6 / Euro 6	
				3151 000 651	KZIS-4		
				3400 700 464	362 10	Getr. / GBox: 6 S 800	(18)
				3482 000 859	MF362	Getr. / GBox: 6 AS 800	
				1878 005 600	362WGTZ	Euro 6 / Euro 6	
				3151 000 651	KZIS-4		
				3400 700 603	350	Getr. / GBox: S5-42	(18)
				3482 001 166	MF350	Euro 6 / Euro 6	
				1878 007 172	350WGTZ		
				3151 000 397	KZIS-4		

Grandezze caratteristiche

Spingidisco della frizione	
Z/	Solo per modello con due dischi
400	Diametro esterno superficie di attrito 400 mm
Do	Doppia frizione, disinnesto azionato in modo dipendente
Du	Doppia frizione, disinnesto azionato in modo indipendente
/E	XTend
F	Volano piatto
G	Frizione con scatola in ghisa
K	Frizione a molla elicoidale
KM	Con molla a diaframma e sistema di leve
M	Frizione con molla a diaframma
N	Presca di forza
S	Esecuzione perno oscillante
T	Con molla a tazza
XTend	Con regolazione automatica
Z	Disinnesto in trazione

Dischi frizione	
200	Diametro esterno 200 mm
CE	Pastiglia sinterizzata in materiale inorganico
B/D/E/Z	Sospensione pastiglia freno
BH/GS/GT/GV	Smorzatore torsionale per veicoli commerciali
/E	XTend
W/V	Preammortizzatore per veicoli commerciali

Cuscinetto di disinnesto	
...A	Anello esterno mobile
G	Anello di guida in grafite
GK	Anello di guida in grafite e cuscinetto a sfere
GR	Cuscinetto a sfere con calotta in lamiera
GZ	Pompa idraulica
HHIS	Cilindro ricevitore concentrico
...I	Anello interno mobile
KT	Disco di scorrimento in teflon
KZ	Cuscinetto a sfere, centrante
NZ	Cilindro ricevitore
...S	Anello interno autocentrante
...Z	Disinnesto in trazione

Traduzioni

(1)	Numero dei fori di fissaggio sul CSC: 2
(2)	Numero dei fori di fissaggio sul CSC: 3
(3)	Numero delle guarnizioni
(4)	Forcella di disinnesto sospesa [mm]
(5)	Forcella di disinnesto verticale [mm]
(6)	Componente intercambiabile sostituito da 3400 121 002
(7)	Diametro esterno [mm]
(8)	In caso di problemi di rumorosità
(9)	Comprende cuscinetto reggispinta e kit di montaggio
(10)	Contiene volano bimassa, spingidisco, disco e sistema di disinnesto
(11)	Contiene volano bimassa, spingidisco, disco e CSC
(12)	Larghezza [mm]
(13)	Diesel
(14)	Diametro collegamento tubo di mandata [mm]
(15)	Euro 3
(16)	Euro 4 (D4)
(17)	Euro 5
(18)	Euro 6
(19)	Euro 3 / Euro 4
(20)	Euro 4 / Euro 5
(21)	Euro 5 / Euro 6
(22)	Il veicolo può essere equipaggiato con frizioni di diversi diametri
(23)	I veicoli possono essere dotati di diversi componenti
(24)	Cambio Fuller
(25)	Fluido di riempimento: liquido freni
(26)	Fluido di riempimento: olio minerale
(27)	Per l'esportazione
(28)	Numero cambio
(29)	Lunghezza guaina [mm]
(30)	Sostituire sempre
(31)	Contenuto in 1888
(32)	Contenuto in 3483/3488
(33)	Contenuto in 3488
(34)	Diametro interno [mm]
(35)	Su richiesta del cliente fornito con frizione diversa
(36)	Lunghezza cavo [mm]
(37)	Grandezza caratteristica
(38)	Cuscinetto a sfere
(39)	Disco frizione con ammortizzatore anteriore
(40)	Potenza [kW]
(41)	Disco frizione sciolto
(42)	Versione paese: Gran Bretagna
(43)	Versione paese: Turchia
(44)	Lunghezza asta del pistone [mm]
(45)	Lunghezza [mm]
(46)	Tipo di montaggio: non preassemblato
(47)	Kit di montaggio per cuscinetto di disinnesto
(48)	Profilo mozzo
(49)	Cuscinetti a rullini

Traduzioni

- (50) ID presa di forza
- (51) Consegnabile solo in caso di restituzione del pezzo vecchio (riparazioni; stabilimento di Bielefeld)
- (52) Da montare solo se il veicolo è equipaggiato con una frizione M
- (53) Solo da utilizzare congiuntamente
- (54) Numero di produzione
- (55) Da numero produzione
- (56) Fino a numero di produzione
- (57) Passo [mm]
- (58) Esecuzione a rulli
- (59) Cambio sequenziale
- (60) Versione speciale
- (61) Disco frizione con molla torsionale
- (62) Cambio ZF
- (63) Kit riparazione alternativo
- (65) Comprende le viti di fissaggio per spingidisco
- (66) Comprende le viti di fissaggio per volano
- (67) Comprende un dischi frizione
- (68) Comprende due dischi frizione
- (69) Per
- (70) Per forcella di disinnesto con camme
- (71) Per forcella di disinnesto con rulli
- (72) Per veicoli con frizione monodisco
- (73) Per veicoli con servofrizione
- (74) Per veicoli con impianto frenante a bassa pressione
- (75) Per veicoli con retarder
- (76) Per veicoli con convertitore di coppia-frizione
- (77) Per veicoli con frizione bidisco
- (78) Per molle della membrana con diametro interno di 100 mm
- (79) Per molle della membrana con diametro interno di 120 mm
- (80) Per motori con volano a doppia massa
- (81) Per motori senza volano a doppia massa
- (82) Per presa di forza
- (83) Per codice OE
- (84) Per profondità volano [mm]
- (85) A seconda della versione con frizione diversa
- (86) Staffa lunga
- (87) Coppia massima del motore trasferibile [Nm]
- (88) Con anello di guida
- (89) Con lubrificazione permanente
- (90) Con retarder VR 115E
- (91) Con raccordo lubrificazione
- (92) Con sensore
- (93) Con accessori
- (94) Con anello intermedio
- (95) Con regolazione automatica
- (96) Non per
- (97) Non per numero telaio
- (98) Non per numero motore

Traduzioni

(99) Non in abbinamento a disco della frizione di ricambio

(100) Solo come ricambio per il n° OE indicato

(101) Solo in combinazione con

(102) Senza anello di guida

(103) Senza raccordo lubrificazione

(104) Senza viti di fissaggio per volano

(105) Senza sensore

(106) Senza anello intermedio

DE

EN

FR

ES

PT

IT

NL

NO

SV

FI

PL

RU

HU

CS

RO

HR

EL

TR

ZH

DE

EN

FR

ES

PT

IT

NL

NO

SV

FI

PL

RU

HU

CS

RO

HR

EL

TR

ZH

Memo

Algemene informatie



Alle in deze catalogus vermeldde producten mogen alleen door opgeleid personeel van een autowerkplaats ingebouwd worden.

Voor uw aanvragen hebben wij het volledige bestelnummer nodig, bijvoorbeeld:

Koppelingskit	3400 122 201
Drukgroep	3482 083 032
Koppelingsplaat	1878 004 832
Koppelingsdrukklager	3151 000 034

Bij twijfel dienen de typeaanduiding en het bouwjaar van het voertuig te worden opgegeven, waarvoor het gewenste artikel bestemd is.

Deze catalogus vormt een uittreksel van ons productprogramma, een volledig overzicht vindt u op onze elektronische media.

Alle rechten voorbehouden. Vermenigvuldigingen of het medegebruik van deze catalogus, ook bij wijze van uittreksel, voor het maken van een eigen catalogus zijn zonder uitdrukkelijke toestemming niet toegestaan.

Onderdeelnummers van het voertuig van de fabrikant zijn alleen bedoeld om te vergelijken. Het gebruik van dergelijke gegevens op facturen voor de eigenaar van het voertuig is niet toegestaan.

De actuele algemene voorwaarden vindt u op www.zf.com/aftermarket/documents

www.zf.com/aftermarket/catalog

WebCat
Onlinecatalogus

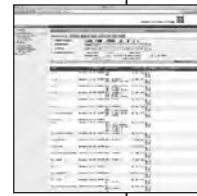

InCat
Elektronische catalogus



PrintCat
Gedrukte catalogi



Inhoudsopgave

Index	U2
Symbolen	U3 - U4
Algemene informatie	V31
Opbouw van de catalogus	V32
Parameters	V32
Vertalingen	V33 - V35
Aritmetische lijst	938 - 984
Vergelijkingslijst	985 - 1028
Nieuwe opnames	1029 - 1034
Gewijzigd bestelnummer	1034 - 1035
Doorgestreepte nummers	1036
Maattabel voor naafprofielen	1037
Maattabel voor vliegwielen	1038 - 1039
Stuklijsten voor tweevoudige plaatkoppelingen	1040

Opbouw van de catalogus

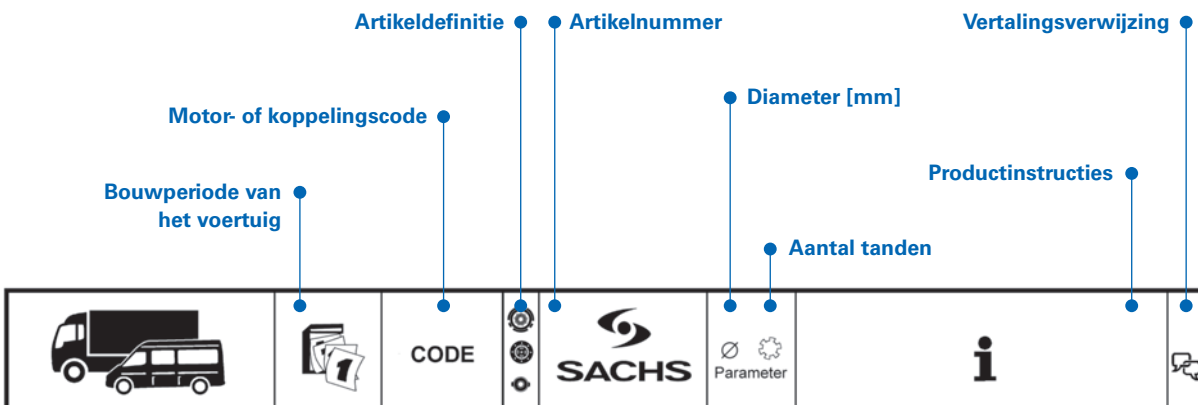

DAF

LF		05.13 -					
FA 180	05.13-	PX-5135		3400 700 465	362 10	Getr. / GBox: 6 S 700	(18)
				3482 000 859	MF362	Getr. / GBox: 6 AS 700	
				1878 005 601	362WGTZ	Euro 6 / Euro 6	
				3151 000 651	KZIS-4		
				3400 700 464	362 10	Getr. / GBox: 6 S 800	(18)
				3482 000 859	MF362	Getr. / GBox: 6 AS 800	
				1878 005 600	362WGTZ	Euro 6 / Euro 6	
				3151 000 651	KZIS-4		
				3400 700 603	350	Getr. / GBox: S5-42	(18)
				3482 001 166	MF350	Euro 6 / Euro 6	
				1878 007 172	350WGTZ		
				3151 000 397	KZIS-4		
FA 210	05.13-	PX-5157		3400 700 465	362 10	Getr. / GBox: 6 S 700	(18)
				3482 000 859	MF362	Getr. / GBox: 6 AS 700	
				1878 005 601	362WGTZ	Euro 6 / Euro 6	
				3151 000 651	KZIS-4		
				3400 700 464	362 10	Getr. / GBox: 6 S 800	(18)
				3482 000 859	MF362	Getr. / GBox: 6 AS 800	
				1878 005 600	362WGTZ	Euro 6 / Euro 6	
				3151 000 651	KZIS-4		
				3400 700 603	350	Getr. / GBox: S5-42	(18)
				3482 001 166	MF350	Euro 6 / Euro 6	
				1878 007 172	350WGTZ		
				3151 000 397	KZIS-4		

Parameters

Koppelingsdrukgroepen	
Z/	Voor uitvoering met dubbele platen
400	Buitendiameter wrijvingsvlak 400 mm
Do	Dubbele koppeling, afhankelijke ontkoppeling
Du	Dubbele koppeling, onafhankelijke ontkoppeling
/E	XTend
F	Vlak vliegwiel
G	Koppeling met gegoten behuizing
K	Schroefveerkoppeling
KM	Met membraanveer en hendelsysteem
M	Membraanveerkoppeling
N	Power take-off
S	Draaipenuitvoering
T	Met schotelveer
XTend	Met automatische nastelling
Z	Getrokken ontkoppeling

Koppelingsplaten	
200	Buitendiameter 200 mm
CE	Anorganische sinterbekleding
B/D/E/Z	Bekledingsveren
BH/GS/GT/GV	Torsiedempers voor bedrijfswagens
/E	XTend
W/V	Voordempers voor bedrijfswagens

Koppelingsdrukager	
...A	Buitenring meelopend
G	Grafietaanloopring
GK	Grafietaanloopring en kogellager
GR	Kogellager met plaatkap
GZ	Commandocilinder
HHIS	Concentrische werkcilinder
...I	Binnenring meelopend
KT	Teflonaanloopring
KZ	Kogellager, centraal geleid
NZ	Werkcilinder
...S	Zelfcentrerende binnenring
...Z	Getrokken ontkoppeling

Vertalingen

(1)	Aantal bevestigingsgaten in de CSC: 2
(2)	Aantal bevestigingsgaten in de CSC: 3
(3)	Aantal voeringen
(4)	Ontkoppelingsvork hangend [mm]
(5)	Ontkoppelingsvork staand [mm]
(6)	Ruildeel vervangen door 3400 121 002
(7)	Buitendiameter [mm]
(8)	Bij geluidsproblemen
(9)	Bevat koppelingsdrukklager en montageset
(10)	Bevat dubbel vliegwiel, drukgroep, koppelingsplaat en ontkoppelaar
(11)	Bevat dubbel vliegwiel, drukgroep, koppelingsplaat en CSC
(12)	Breedte [mm]
(13)	Diesel
(14)	Diameter aansluiting drukleiding [mm]
(15)	Euro 3
(16)	Euro 4 (D4)
(17)	Euro 5
(18)	Euro 6
(19)	Euro 3 / Euro 4
(20)	Euro 4 / Euro 5
(21)	Euro 5 / Euro 6
(22)	Het voertuig kan met verschillende koppelingsgroottes worden uitgerust
(23)	Voertuigen kunnen met verschillende componenten zijn uitgerust
(24)	Fuller-versnellingsbak
(25)	Vulmedium: remvloeistof
(26)	Vulmedium: minerale olie
(27)	Voor export
(28)	Versnellingsbaknummer
(29)	Lengte omhulling [mm]
(30)	Altijd vernieuwen
(31)	Inbegrepen in 1888
(32)	Inbegrepen in 3483/3488
(33)	Inbegrepen in 3488
(34)	Binnendiameter [mm]
(35)	Op verzoek van klant met verschillende types koppelingen uitgevoerd
(36)	Kabellengte [mm]
(37)	Parameter
(38)	Kogellager
(39)	Koppelingsplaat met voordemper
(40)	Vermogen [kW]
(41)	Losse koppelingsplaat
(42)	Landuitvoering: Groot-Brittannië
(43)	Landuitvoering: Turkije
(44)	Lengte zuigerstang [mm]
(45)	Lengte [mm]
(46)	Montagewijze: niet voorgemonteerd
(47)	Montageset voor koppelingsdrukklager
(48)	Naafprofiel
(49)	Naaldlager

Vertalingen

- (50) ID power take-off
- (51) Alleen leverbaar bij teruggave van het oude onderdeel (reparatie; fabriek Bielefeld)
- (52) Alleen inbouwen als voertuig met M-koppeling uitgerust is
- (53) Alleen samen inbouwen
- (54) Productienummer
- (55) Vanaf productienummer
- (56) Tot productienummer
- (57) Wielbasis [mm]
- (58) Uitvoering met rollen
- (59) Handgeschakelde versnellingsbak sequentieel
- (60) Speciale uitvoering
- (61) Torsiegeveerde koppelingsplaat
- (62) ZF-versnellingsbak
- (63) Alternatieve reparatieset
- (65) Bevat bevestigingsbouten drukgroep
- (66) Bevat bevestigingsbouten vliegwiel
- (67) Bevat één koppelingsplaat
- (68) Bevat twee koppelingsplaten
- (69) Voor
- (70) Voor ontkoppelingsvork met nokken
- (71) Voor ontkoppelingsvork met rollen
- (72) Voor voertuigen met enkelvoudige plaatkoppeling
- (73) Voor voertuigen met koppelingskrachtversterker
- (74) Voor voertuigen met lagedrukremstelsel
- (75) Voor voertuigen met retarder
- (76) Voor voertuigen met koppelomvormer-koppeling
- (77) Voor voertuigen met tweevoudige plaatkoppeling
- (78) Voor binnendiameter membraanveer 100 mm
- (79) Voor binnendiameter membraanveer 120 mm
- (80) Voor motoren met tweemassavliegwiel
- (81) Voor motoren zonder tweemassavliegwiel
- (82) Voor power take-off
- (83) Voor OE-nummer
- (84) Voor vliegwieldiepte [mm]
- (85) Met verschillende types koppelingen uitgevoerd
- (86) Lange beugel
- (87) Overdraagbare maximale motorkoppel [Nm]
- (88) Met aanloopring
- (89) Met permanente smering
- (90) Met retarder VR 115E
- (91) Met smeerbuisaansluiting
- (92) Met sensor
- (93) Met accessoires
- (94) Met tussenring
- (95) Met automatische instelling
- (96) Niet voor
- (97) Niet voor chassisnummer
- (98) Niet voor motornummer
- (99) Niet in combinatie met reservekoppelingsplaat

Vertalingen

(100) Alleen ter vervanging van vermelde OE-nr.

(101) Enkel in combinatie met

(102) Zonder aanloopring

(103) Zonder smeerbuisaansluiting

(104) Zonder bevestigingsbouten vliegwiel

(105) Zonder sensor

(106) Zonder tussenring

DE

EN

FR

ES

PT

IT

NL

NO

SV

FI

PL

RU

HU

CS

RO

HR

EL

TR

ZH

DE

EN

FR

ES

PT

IT

NL

NO

SV

FI

PL

RU

HU

CS

RO

HR

EL

TR

ZH

Memo

Generelle opplysninger



Alle produkter i denne katalogen må kun monteres av personell ved et bilverksted med relevant utdanning.

For å kunne oppfylle dine krav trenger vi hele bestillingsnummeret, for eksempel:

Clutch-sett	3400 122 201
Clutchtrykkplate	3482 083 032
Clutchlamell	1878 004 832
Utløser	3151 000 034

Hvis en er i tvil må en angi typebetegnelse og byggeår til kjøretøyet, som ønsket artikkel er ment for.

Denne katalogen er et utdrag av produktprogrammet vårt. En komplett oversikt finner du på våre elektroniske medier.

Alle rettigheter forbeholdt. Kopiering eller felles bruk av denne katalogen, også delvis, for å opprette en egen katalog er forbudt uten skriftlig tillatelse.

Reservedelsnummer til kjøretøyprodusenter brukes for sammenligning. Det er ikke tillatt å bruke slik informasjon i fakturaer til kjøretøyets eier.

Aktuelle generelle vilkår og betingelser finner du på www.zf.com/aftermarket/documents

www.zf.com/aftermarket/catalog

WebCat
Nettkatalog

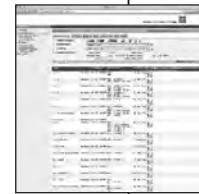

InCat
Elektronisk katalog



PrintCat
Trykte kataloger



Innholdsfortegnelse

Index	U2
Symboler	U3 - U4
Generelle opplysninger	V37
Katalogoppsett	V38
Prametere	V38
Oversettelser	V39 - V41
Aritmetisk liste	938 - 984
Sammenligningsliste	985 - 1028
Nye oppføringer	1029 - 1034
Endret bestillingsnummer	1034 - 1035
Utgåtte numre	1036
Måltabell for navprofiler	1037
Måltabell for svinghjul	1038 - 1039
Stykklister for koblinger med dobbeltskive	1040

Katalogoppsett

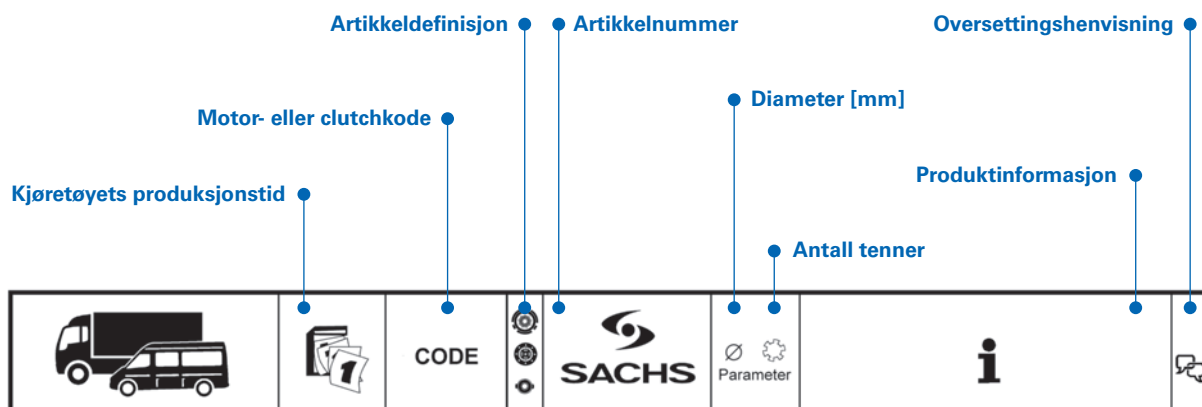

DAF

LF		05.13 -					
FA 180	05.13-	PX-5135		3400 700 465	362 10	Getr. / GBox: 6 S 700	(18)
				3482 000 859	MF362	Getr. / GBox: 6 AS 700	
				1878 005 601	362WGTZ	Euro 6 / Euro 6	
				3151 000 651	KZIS-4		
				3400 700 464	362 10	Getr. / GBox: 6 S 800	(18)
				3482 000 859	MF362	Getr. / GBox: 6 AS 800	
				1878 005 600	362WGTZ	Euro 6 / Euro 6	
				3151 000 651	KZIS-4		
				3400 700 603	350	Getr. / GBox: S5-42	(18)
				3482 001 166	MF350	Euro 6 / Euro 6	
				1878 007 172	350WGTZ		
				3151 000 397	KZIS-4		
FA 210	05.13-	PX-5157		3400 700 465	362 10	Getr. / GBox: 6 S 700	(18)
				3482 000 859	MF362	Getr. / GBox: 6 AS 700	
				1878 005 601	362WGTZ	Euro 6 / Euro 6	
				3151 000 651	KZIS-4		
				3400 700 464	362 10	Getr. / GBox: 6 S 800	(18)
				3482 000 859	MF362	Getr. / GBox: 6 AS 800	
				1878 005 600	362WGTZ	Euro 6 / Euro 6	
				3151 000 651	KZIS-4		
				3400 700 603	350	Getr. / GBox: S5-42	(18)
				3482 001 166	MF350	Euro 6 / Euro 6	
				1878 007 172	350WGTZ		
				3151 000 397	KZIS-4		

Prametere

Clutchtrykkplater

Z/	For dobbeltskiveutførelse
400	Friksjonsflatediameter 400 mm
Do	Dobbelclutch, avhengig utløsning
Du	Dobbelclutch, uavhengig utløsning
/E	XTend
F	Flatt svinghjul
G	Clutch med støpt hus
K	Skruefjærkobling
KM	Med membranfjær og spaksystem
M	Membranfjærkobling
N	Kraftuttak
S	Svingboltutførelse
T	Med fjærskive
XTend	Med automatisk justering
Z	Trekkfrigjøring

Clutchlameller

200	Utvendig diameter 200 mm
CE	Uorganisk sinterbelegg
B/D/E/Z	Koblingsfjærer
BH/GS/GT/GV	Torsjonsdemper for nyttekjøretøy
/E	XTend
W/V	Fordemper for nyttekjøretøy

Utløserlager

...A	Medløpende ytterring
G	Grafittløpering
GK	Grafittløpering og kulelager
GR	Kulelager med platekappe
GZ	Hovedsylinder
HHIS	Konsentrisk arbeidssylinder
...I	Medløpende innerring
KT	Teflonstartskive
KZ	Kulelager, sentralført
NZ	Arbeidssylinder
...S	Selvsentrerende innerring
...Z	Trekkfrigjøring

Översättelser

(1)	Antall festehull på CSC: 2
(2)	Antall festehull på CSC: 3
(3)	Antall belegg
(4)	Utløsergaffel hengende [mm]
(5)	Utløsergaffel stående [mm]
(6)	Byttedel erstattet av 3400 121 002
(7)	Utvendig diameter [mm]
(8)	Ved støypoblemer
(9)	Inneholder utløser og monteringssett
(10)	Inneholder dobbelt massesvinghjul, trykkplate, clutchskive og utløser
(11)	Inneholder dobbelt massesvinghjul, trykkplate, clutchskive og CSC
(12)	Bredde [mm]
(13)	Diesel
(14)	Diameter trykkledningstilkobling [mm]
(15)	Euro 3
(16)	Euro 4 (D4)
(17)	Euro 5
(18)	Euro 6
(19)	Euro 3 / Euro 4
(20)	Euro 4 / Euro 5
(21)	Euro 5 / Euro 6
(22)	Kjøretøyet kan utstyres med forskjellige clutchstørrelser
(23)	Kjøretøyene kan ha forskjellige komponenter
(24)	Fuller-gir
(25)	Fyllemedium: Bremsvæske
(26)	Fyllemedium: Mineralolje
(27)	For eksport
(28)	Girnummer
(29)	Skallengde [mm]
(30)	Skiftes alltid
(31)	Inkludert i 1888
(32)	Inkludert i 3483/3488
(33)	Inkludert i 3488
(34)	Innvendig diameter [mm]
(35)	Alt etter kundens ønske utstyrt med forskjellig clutch
(36)	Kabellengde [mm]
(37)	Parameter
(38)	Kulelager
(39)	Clutchskive med fordemper
(40)	Effekt [kW]
(41)	Løs clutchlamell
(42)	Landsversjon: Storbritannia
(43)	Landsversjon: Tyrkia
(44)	Lengde stempelstang [mm]
(45)	Lengde [mm]
(46)	Monteringsmåte: Ikke forhåndsmontert
(47)	Monteringssett for utløserlager
(48)	Navprofil
(49)	Nålelager

DE

EN

FR

ES

PT

IT

NL

NO

SV

FI

PL

RU

HU

CS

RO

HR

EL

TR

ZH

Översättelser

- (50) Kraftuttaks-ID
- (51) Leveres kun ved retur av den gamle delen (reparasjon; fabrikk Bielefeld)
- (52) Må kun monteres hvis kjøretøyet har en M-clutch
- (53) Må kun monteres sammen
- (54) Produksjonsnummer
- (55) Fra produksjonsnummer
- (56) Til produksjonsnummer
- (57) Akselavstand [mm]
- (58) Rullutførelse
- (59) Manuell girkasse, sekvensiell
- (60) Spesialutførelse
- (61) Torsjonsfjæret clutchlamell
- (62) ZF-gir
- (63) Alternativt reparasjonssett
- (65) Inneholder festeskruer til trykkplatene
- (66) Inneholder festeskruer til svinghjul
- (67) Inneholder én clutchlamell
- (68) Inneholder to clutchlameller
- (69) For
- (70) For utløsergaffel med kam
- (71) For utløsergaffel med ruller
- (72) For kjøretøy med clutch med én lamell
- (73) For kjøretøy med clutchkraftforsterker
- (74) For kjøretøy med lavtrykk-bremsesystem
- (75) For kjøretøy med retarder
- (76) For kjøretøy med omformerclutch
- (77) For kjøretøy med clutch med to lameller
- (78) For membranfjær med innvendig diameter 100 mm
- (79) For membranfjær med innvendig diameter 120 mm
- (80) For motorer med todelt svinghjul
- (81) For motorer uten todelt svinghjul
- (82) For kraftuttak
- (83) For OE-nummer
- (84) For svinghjuldybde [mm]
- (85) Alt etter modell utstyrt med forskjellig clutch
- (86) Lang bøyle
- (87) Maksimal motormoment [Nm] som kan overføres
- (88) Med trykkskive
- (89) Med kontinuerlig smøring
- (90) Med retarder VR 115E
- (91) Med smørerørtilkobling
- (92) Med sensor
- (93) Med tilbehør
- (94) Med mellomring
- (95) Med automatisk justering
- (96) Ikke for
- (97) Ikke for chassisnummer
- (98) Ikke for motornummer
- (99) Ikke i forbindelse med clutchskiver til utveksling

Översettelser

(100) Kun som erstatning for de angitte OE-nr.

(101) Kun i forbindelse med

(102) Uten trykkskive

(103) Uten smørerørtilkobling

(104) Uten festeskruer til svinghjul

(105) Uten sensor

(106) Uten mellomring

DE

EN

FR

ES

PT

IT

NL

NO

SV

FI

PL

RU

HU

CS

RO

HR

EL

TR

ZH

DE

EN

FR

ES

PT

IT

NL

NO

SV

FI

PL

RU

HU

CS

RO

HR

EL

TR

ZH

Memo

Allmän information



Alla produkter som anges i den här katalogen får endast monteras av behörig, utbildad personal i en bil-/fordonsverkstad.

För din förfrågan behöver vi det fullständiga beställningsnumret, till exempel:

Kopplingsats	3400 122 201
Kopplingstryckplatta	3482 083 032
Kopplingskiva	1878 004 832
Urtrampningsdon	3151 000 034

Om du är osäker, ange typbeteckning och årsmodell för det fordon som den önskade artikeln är avsedd för.

Den här katalogen är ett urval från vårt produktprogram, en komplett översikt finns i våra elektroniska medier.

Alla rättigheter förbehålls. Mångfaldiganden eller med användning av den här katalogen, även utdragsvis, för framställning av en egen katalog är ej tillåtet utan uttryckligt godkännande.

Fordonstillverkarnas reservdelsnummer är endast till för jämförelse. Det är inte tillåtet att använda dylika uppgifter på fakturor till fordonsägarna.

De aktuella allmänna affärsvillkoren finns på www.zf.com/aftermarket/documents

www.zf.com/aftermarket/catalog

WebCat
Online-katalog

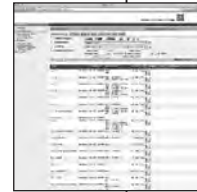

InCat
Elektronisk katalog



PrintCat
Tryckta kataloger



Innehållsförteckning

Index	U2
Symboler	U3 - U4
Allmän information	V43
Katalogstruktur	V44
Parametrar	V44
Översättningar	V45 - V47
Aritmetisk lista	938 - 984
Jämförelselista	985 - 1028
Nyinlagda	1029 - 1034
Ändrade beställningsnummer	1034 - 1035
Strukna nummer	1036
Måttabell för navprofil	1037
Måttabell för svänghjul	1038 - 1039
Materialförteckningar för dubbellamellkopplingar	1040

Katalogstruktur

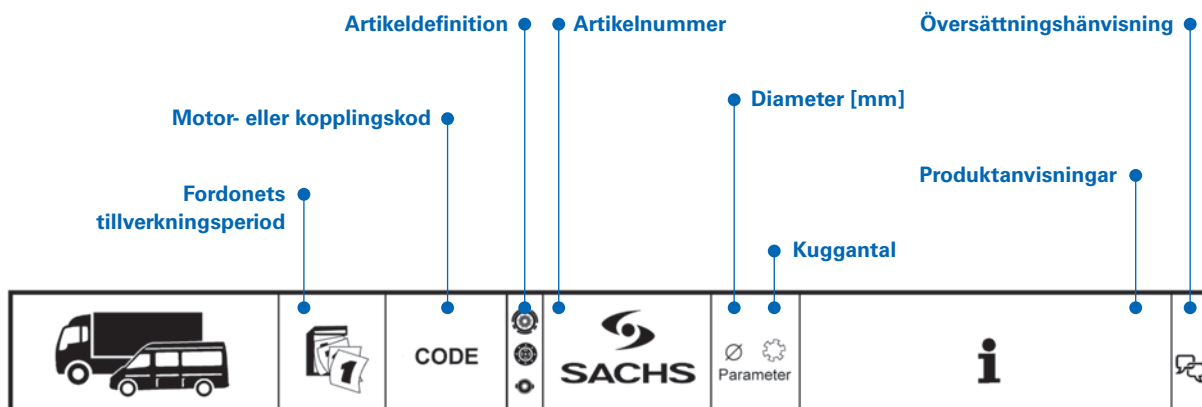

DAF

LF		05.13 -					
FA 180	05.13-	PX-5135	⊗ 3400 700 465	362 10	Getr. / GBox: 6 S 700	(18)	
			⊗ 3482 000 859	MF362	Getr. / GBox: 6 AS 700		
			⊗ 1878 005 601	362WGTZ	Euro 6 / Euro 6		
			⊗ 3151 000 651	KZIS-4			
			⊗ 3400 700 464	362 10	Getr. / GBox: 6 S 800	(18)	
			⊗ 3482 000 859	MF362	Getr. / GBox: 6 AS 800		
			⊗ 1878 005 600	362WGTZ	Euro 6 / Euro 6		
			⊗ 3151 000 651	KZIS-4			
			⊗ 3400 700 603	350	Getr. / GBox: S5-42	(18)	
			⊗ 3482 001 166	MF350	Euro 6 / Euro 6		
			⊗ 1878 007 172	350WGTZ			
			⊗ 3151 000 397	KZIS-4			
FA 210	05.13-	PX-5157	⊗ 3400 700 465	362 10	Getr. / GBox: 6 S 700	(18)	
			⊗ 3482 000 859	MF362	Getr. / GBox: 6 AS 700		
			⊗ 1878 005 601	362WGTZ	Euro 6 / Euro 6		
			⊗ 3151 000 651	KZIS-4			
			⊗ 3400 700 464	362 10	Getr. / GBox: 6 S 800	(18)	
			⊗ 3482 000 859	MF362	Getr. / GBox: 6 AS 800		
			⊗ 1878 005 600	362WGTZ	Euro 6 / Euro 6		
			⊗ 3151 000 651	KZIS-4			
			⊗ 3400 700 603	350	Getr. / GBox: S5-42	(18)	
			⊗ 3482 001 166	MF350	Euro 6 / Euro 6		
			⊗ 1878 007 172	350WGTZ			
			⊗ 3151 000 397	KZIS-4			

Parametrar

⊗ Kopplingstryckplattor

Z/	För utförande med dubbelskivor
400	Ytterdiameter rivyta 400 mm
Do	Dubbelkoppling, beroende urkoppling
Du	Dubbelkoppling, oberoende urkoppling
/E	XTend
F	Platt svänghjul
G	Koppling med gjutet hus
K	Skruvfjäderkoppling
KM	Med membranfjäder och spaksystem
M	Membranfjäderkoppling
N	Kraftuttag
S	Vridtappsutförande
T	Med fjäderbricka
XTend	Med automatisk justering
Z	Urkoppling på drag

⊗ Kopplingskivor

200	Utvändig diameter 200 mm
CE	Oorganisk sintrad beläggning
B/D/E/Z	Beläggingsfjädrar
BH/GS/GT/GV	Torsionsdämpare för nyttofordon
/E	XTend
W/V	Fördämpare för nyttofordon

⊗ Urkopplingslager

...A	Yttering medlöpande
G	Tryckring av grafit
GK	Tryckring av grafit och kullager
GR	Kullager med plåtkåpa
GZ	Huvudcylinder
HHIS	Koncentrisk slavcylinder
...I	Inre ring medlöpande
KT	Teflonlöpskiva
KZ	Kullager, centralstyrt
NZ	Slavcylinder
...S	Självcenterande inre ring
...Z	Urkoppling på drag

Översättningar

(1)	Antal monteringshål på CSC: 2
(2)	Antal monteringshål på CSC: 3
(3)	Antal beläggningar
(4)	Urkopplingsgaffel, hängande [mm]
(5)	Urkopplingsgaffel, stående [mm]
(6)	Reservdel utbytt mot 3400 121 002
(7)	Ytterdiameter [mm]
(8)	Vid ljudproblem
(9)	Innehåller urtrampningsdon och monteringsats
(10)	Innehåller dubbelmassesvänghjul, tryckplatta, kopplingslamell och urtrampningsdon
(11)	Innehåller dubbelmassesvänghjul, tryckplatta, kopplingslamell och CSC
(12)	Bredd [mm]
(13)	Diesel
(14)	Diameter tryckslangens anslutning [mm]
(15)	Euro 3
(16)	Euro 4 (D4)
(17)	Euro 5
(18)	Euro 6
(19)	Euro 3 / Euro 4
(20)	Euro 4 / Euro 5
(21)	Euro 5 / Euro 6
(22)	Fordonet kan utrustas med olika kopplingsstorlekar
(23)	Fordonen kan vara utrustade med olika komponenter
(24)	Fuller-transmission
(25)	Påfyllningsmedium: bromsvätska
(26)	Påfyllningsmedium: mineralolja
(27)	För export
(28)	Transmissionsnummer
(29)	Höljets längd [mm]
(30)	Skall alltid bytas
(31)	Ingår i 1888
(32)	Ingår i 3483/3488
(33)	Ingår i 3488
(34)	Invändig diameter [mm]
(35)	Olika kopplingar, beroende på kundens önskemål
(36)	Kabellängd [mm]
(37)	Parameter
(38)	Kullager
(39)	Kopplingslamell med fördämpare
(40)	Effekt [kW]
(41)	Lös kopplingskiva
(42)	Landversion: Storbritannien
(43)	Landversion: Turkiet
(44)	Längd kolvstång [mm]
(45)	Längd [mm]
(46)	Monteringssätt: ej förmonterat
(47)	Monteringssats för urkopplingslager
(48)	Navprofil
(49)	Nållager

DE

EN

FR

ES

PT

IT

NL

NO

SV

FI

PL

RU

HU

CS

RO

HR

EL

TR

ZH

Översättningar

(50) ID extra drivkraft

(51) Kan endast levereras vid retur av kasserad del (reparation; fabriken i Bielefeld)

(52) Får endast monteras om fordonet är utrustat med M-koppling

(53) Får bara monteras tillsammans

(54) Produktionsnummer

(55) Från produktionsnummer

(56) Till produktionsnummer

(57) Hjulbas [mm]

(58) Rullutförande

(59) Sekventiell växellåda

(60) Specialutförande

(61) Torsionsfjädrad kopplingskiva

(62) ZF-transmission

(63) Alternativ reparationssats

(65) Innehåller fästskruvar för tryckplatta

(66) Innehåller fästskruvar för svänghjul

(67) Innehåller en kopplingskiva

(68) Innehåller två kopplingskivor

(69) För

(70) För urkopplingsgaffel med kam

(71) För urkopplingsgaffel med rullar

(72) För fordon med enkellamellkoppling

(73) För fordon med kopplingskraftförstärkare

(74) För fordon med lågtrycks-bromssystem

(75) För fordon med retarder

(76) För fordon med momentomvandlare

(77) För fordon med dubbellamellkoppling

(78) För membranfjäderinnerdiameter 100 mm

(79) För membranfjäderinnerdiameter 120 mm

(80) För motorer med tvåmassesvänghjul

(81) För motorer utan tvåmassesvänghjul

(82) För kraftuttag

(83) För OE-nummer

(84) För svänghjulsdjup [mm]

(85) Olika kopplingar beroende på modell

(86) Lång bygel

(87) Maximalt överförbart motorvridmoment [Nm]

(88) Med tryckring

(89) Med permanent smörjning

(90) Med retarder VR 115E

(91) Med smörjrörsanslutning

(92) Med sensor

(93) Med tillbehör

(94) Med mellanläggsbricka

(95) Med automatisk justering

(96) Ej för

(97) Ej för chassinummer

(98) Ej för motornummer

(99) Ej i kombination med reservkopplingskiva

Översättningar

(100) Enbart som ersättning för angivet OE-nr.

(101) Endast i samband med

(102) Utan tryckring

(103) Utan smörjrörsanslutning

(104) Utan fästskruvar för svänghjul

(105) Utan sensor

(106) Utan mellanläggsbricka

DE

EN

FR

ES

PT

IT

NL

NO

SV

FI

PL

RU

HU

CS

RO

HR

EL

TR

ZH

DE

EN

FR

ES

PT

IT

NL

NO

SV

FI

PL

RU

HU

CS

RO

HR

EL

TR

ZH

Memo

Yleiset tiedot



Kaikki tässä luettelossa mainitut tuotteet saa asentaa vain autokorjaamon koulutettu henkilöstö.

Vaativuusi varten tarvitsemme täydellisen tilausnumeron, esimerkiksi:

Kytkinsarja	3400 122 201
Kytkinasennelma	3482 083 032
Kytkinlevy	1878 004 832
Irrotin	3151 000 034

Epävarmoissa tapauksissa ilmoita sen auton tyyppinimike ja vuosimalli, johon haluttu tuote on tarkoitettu.

Tämä luettelo on ote tuotevalikoimastamme, täydellisen valikoiman löydät sähköisistä tietovälineistämme.

Kaikki oikeudet pidätetään. Tämän luettelon osittainenkin monistaminen tai käyttäminen oman luettelon laatimiseen on ilman nimenomaista lupaa kiellettyä.

Ajoneuvojen valmistajien varaosanumerot on tarkoitettu vain vertailutarkoituksiin. Tällaisten tietojen käyttö auton omistajalle menevissä laskuissa ei ole sallittua.

Voimassa olevat yleiset myyntiehdot löytyvät osoitteesta www.zf.com/aftermarket/documents

www.zf.com/aftermarket/catalog

WebCat

Online-luettelo

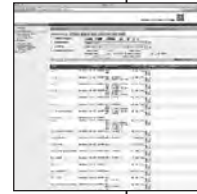

InCat

Sähköinen luettelo



PrintCat

Painetut luettelot



Sisällysluettelo

Index	U2
Symbolit	U3 - U4
Yleiset tiedot	V49
Luettelon rakenne	V50
Tunnusluvut	V50
Käännökset	V51 - V53
Aritmeettinen lista	938 - 984
Vertailulista	985 - 1028
Uudelleen vastaanotetut	1029 - 1034
Muutettu tilausnumero	1034 - 1035
Pyyhityt numerot	1036
Mittataulukko navan urituksille	1037
Mittataulukko vauhtipyörille	1038 - 1039
Kappaleluettelo kaksilevykytkimille	1040

Luettelon rakenne

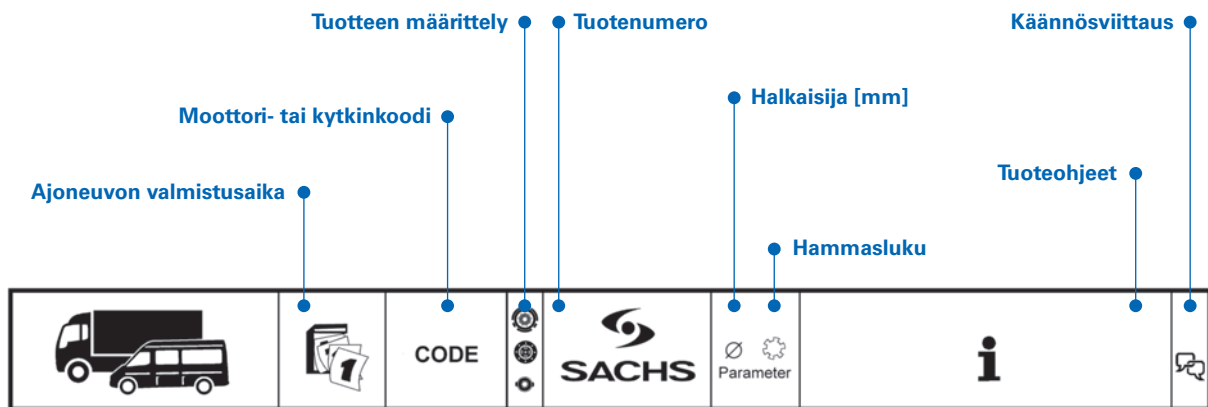

DAF

LF		05.13 -					
FA 180	05.13-	PX-5135		3400 700 465	362 10	Getr. / GBox: 6 S 700	(18)
				3482 000 859	MF362	Getr. / GBox: 6 AS 700	
				1878 005 601	362WGTZ	Euro 6 / Euro 6	
				3151 000 651	KZIS-4		
				3400 700 464	362 10	Getr. / GBox: 6 S 800	(18)
				3482 000 859	MF362	Getr. / GBox: 6 AS 800	
				1878 005 600	362WGTZ	Euro 6 / Euro 6	
				3151 000 651	KZIS-4		
				3400 700 603	350	Getr. / GBox: S5-42	(18)
				3482 001 166	MF350	Euro 6 / Euro 6	
				1878 007 172	350WGTZ		
				3151 000 397	KZIS-4		
FA 210	05.13-	PX-5157		3400 700 465	362 10	Getr. / GBox: 6 S 700	(18)
				3482 000 859	MF362	Getr. / GBox: 6 AS 700	
				1878 005 601	362WGTZ	Euro 6 / Euro 6	
				3151 000 651	KZIS-4		
				3400 700 464	362 10	Getr. / GBox: 6 S 800	(18)
				3482 000 859	MF362	Getr. / GBox: 6 AS 800	
				1878 005 600	362WGTZ	Euro 6 / Euro 6	
				3151 000 651	KZIS-4		
				3400 700 603	350	Getr. / GBox: S5-42	(18)
				3482 001 166	MF350	Euro 6 / Euro 6	
				1878 007 172	350WGTZ		
				3151 000 397	KZIS-4		

Tunnusluvut

Kytkinasennemat	
Z/	Kaksikammioiseen malliin
400	Kitkapinnan ulkohalkaisija 400 mm
Do	Kaksoiskytkin, riippuvainen irrotus
Du	Kaksoiskytkin, riippumaton irrotus
/E	XTend
F	Litteä vauhtipyörä
G	Kytkin valetulla rungolla
K	Kierrejousiskytkin
KM	Kalvojosella ja vipujärjestelmällä
M	Kalvojosiskytkin
N	Voiman ulosotto
S	Kääntöpulttivarustus
T	Lautasjosella
XTend	Automaattisella säädöllä
Z	Irrotus vetämällä

Kytkinlevyt	
200	Ulkohalkaisija 200 mm
CE	Epäorgaaninen sintterilevy
B/D/E/Z	Levyjousitukset
BH/GS/GT/GV	Vääntövaimennin hyötyajoneuvoon
/E	XTend
W/V	Esivaimennin hyötyajoneuvoon

Irrotinlaakeri	
...A	Ulkorengas samaan suuntaan kulkeva
G	Grafiittirengas
GK	Grafiittirengas ja kuulalaakeri
GR	Kuulalaakeri peltikannella
GZ	Pääsylinteri
HHIS	Konsentrinen työsylinteri
...I	Sisärengas samaan suuntaan kulkeva
KT	Teflonpainelevy
KZ	Kuulalaakeri, keskusohjattu
NZ	Työsylinteri
...S	Itsestään keskittyvä sisärengas
...Z	Irrotus vetämällä

Käännökset

(1)	CSC:n kiinnitysreikien määrä: 2
(2)	CSC:n kiinnitysreikien määrä: 3
(3)	Pintojen määrä
(4)	Irrotinhaarukka riippuva [mm]
(5)	Irrotinhaarukka pystyssä [mm]
(6)	Vaihdeettava osa, jonka korvaa 3400 121 002
(7)	Ulkohalkaisija [mm]
(8)	Häiriöääniongelmassa
(9)	Sisältää irrotin ja asennussarjan
(10)	Sisältää kaksoismassavauhtipyörän, kytkimen painelevyn, kytkinlevyn ja irrotinlaakerin
(11)	Sisältää kaksoismassavauhtipyörän, kytkimen painelevyn, kytkinlevyn ja CSC:n
(12)	Leveys [mm]
(13)	Diesel
(14)	Painejohtimen liitännän halkaisija [mm]
(15)	Euro 3
(16)	Euro 4 (D4)
(17)	Euro 5
(18)	Euro 6
(19)	Euro 3 / Euro 4
(20)	Euro 4 / Euro 5
(21)	Euro 5 / Euro 6
(22)	Ajoneuvo voi olla varustettu erikokoisilla kytkimillä
(23)	Ajoneuvot voivat olla varustettuja erilaisilla komponenteilla
(24)	Fuller-vaihteisto
(25)	Täyttöaine: jarruneste
(26)	Täyttöaine: mineraaliöljy
(27)	Vientiin
(28)	Vaihteistonumero
(29)	Suojuksen pituus [mm]
(30)	Uusittava aina
(31)	Malleissa 1888 mukana
(32)	Malleissa 3483/3488 mukana
(33)	Malleissa 3488 mukana
(34)	Sisähalkaisija [mm]
(35)	Varustettu erilaisella kytkimellä asiakkaan toivomuksen mukaisesti
(36)	Johtopituus [mm]
(37)	Tunnusluku
(38)	Kuulalaakeri
(39)	Kytkinlevy esivaimentimella
(40)	Teho [kW]
(41)	Avoin kytkinlevy
(42)	Maaversio: Iso-Britannia
(43)	Maaversio: Turkki
(44)	Pituus männänvarsi [mm]
(45)	Pituus [mm]
(46)	Asennustapa: ei esiasennettu
(47)	Asennussarja irrotinlaakerille
(48)	Navan uritus
(49)	Neulalaakeri

Käännökset

- (50) Voiman ulosoton tunniste
- (51) Toimitettavissa vain käytetyn osan palautuksen kanssa (korjaus; Bielefeldin tehdas)
- (52) Asennettavissa vain, jos ajoneuvossa on M-kytkin
- (53) Asennettava yhdessä
- (54) Valmistenumero
- (55) Alkaen valmistusnumerosta
- (56) Päätyen valmistenumeroon
- (57) Akseliväli [mm]
- (58) Rullamalli
- (59) Käsivaihteisto peräkkäinen
- (60) Erikoismalli
- (61) Jousivaimenteinen kytkinlevy
- (62) ZF-vaihteisto
- (63) Vaihtoehtoinen korjaussarja
- (65) Sisältää painelevyn kiinnitysruuvit
- (66) Sisältää vauhtipyörän kiinnitysruuvit
- (67) Sisältää yhden kytkinlevyn
- (68) Sisältää kaksi kytkinlevyä
- (69) Käyttö
- (70) Irrotinhaarukka, jossa nokka
- (71) Irrotinhaarukka, jossa rullat
- (72) Ajoneuvot, joissa yksilevykytkin
- (73) Ajoneuvot, joissa kytkintehostin
- (74) Ajoneuvot, joissa matalapaineinen jarrujärjestelmä
- (75) Ajoneuvot, joissa hidastin
- (76) Ajoneuvot, joissa nestekytkin
- (77) Ajoneuvot, joissa kaksilevykytkin
- (78) Membraanijouselle, sisähalkaisija 100 mm
- (79) Membraanijouselle, sisähalkaisija 120 mm
- (80) Moottorit, joissa kaksimassavauhtipyörä
- (81) Moottorit, ilman kaksimassavauhtipyörää
- (82) Voiman ulosotto
- (83) Alkuperäisnumero
- (84) Vauhtipyörän syvyys [mm]
- (85) Varustettu erilaisella kytkimellä mallin mukaisesti
- (86) Pitkä sanko
- (87) Maksimi siirrettävä vääntömomentti [Nm]
- (88) Vasterenkaalla
- (89) Kestovoitelulla
- (90) Hidastimella VR 115E
- (91) Voiteluputkiliitännällä
- (92) Anturilla
- (93) Varusteilla
- (94) Välipainelevyillä
- (95) Automaattisella säädöllä
- (96) Paitsi
- (97) Ei alustanumerolle
- (98) Paitsi moottorinumerot
- (99) Ei yhdessä vaihdettavan kytkinlevyn kanssa

Käännökset

(100) Vain korvata määritetyt OE numero

(101) Vain yhdessä

(102) Ilman vasterengasta

(103) Ilman voiteluputkiliitäntää

(104) Ilman vauhtipyörän kiinnitysruuveja

(105) Ilman anturia

(106) Ilman välipainerengasta

DE

EN

FR

ES

PT

IT

NL

NO

SV

FI

PL

RU

HU

CS

RO

HR

EL

TR

ZH

DE

EN

FR

ES

PT

IT

NL

NO

SV

FI

PL

RU

HU

CS

RO

HR

EL

TR

ZH

Memo

A large rectangular area filled with horizontal grey lines, serving as a template for writing a memo. The lines are evenly spaced and cover the majority of the page's width and height.

Ogólna informacja



Wszystkie produkty wymienione w tym katalogu mogą być montowane wyłącznie przez wykwalifikowany personel serwisu samochodowego.

W przypadku zamówień niezbędny jest pełny numer zamówieniowy, na przykład:

Zestaw sprzęgowy	3400 122 201
Tarcza dociskowa sprzęgła	3482 083 032
Tarcza sprzęgła	1878 004 832
Wyprzęgnik	3151 000 034

W razie wątpliwości proszę podawać oznaczenie typu i rok produkcji pojazdu, dla którego przeznaczony jest żądany artykuł.

Ten katalog to wyciąg z naszego programu produktów, pełny przegląd znajdują Państwo na naszych mediach elektronicznych.

Wszelkie prawa zastrzeżone. Powielanie lub wykorzystywanie niniejszego katalogu, w całości lub częściowo, do sporządzenia innego katalogu jest niedozwolone bez uzyskania wyraźnej zgody. Numery części zamiennych producentów samochodów służą tylko do celów porównawczych.

Wykorzystywanie tego rodzaju danych na rachunkach wystawianych pod adresem posiadacza samochodu jest zabronione.

Aktualne ogólne warunki handlowe można znaleźć tutaj www.zf.com/aftermarket/documents

www.zf.com/aftermarket/catalog

WebCat

Katalog online

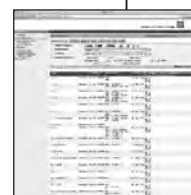

InCat

Katalog elektroniczny



PrintCat

Drukowane katalogi



Spis treści

Index	U2
Symbole	U5 - U6
Ogólna informacja	V55
Struktura katalogu	V56
Parametry	V56
Tłumaczenia	V57 - V59
Lista z numerami	938 - 984
Lista porównawcza	985 - 1028
Nowe produkty	1029 - 1034
Zmieniony numer części	1034 - 1035
Numery skreślone	1036
Tabela wymiarów profili piasty	1037
Tabela wymiarów tarcz zamachowych	1038 - 1039
Wykazy części dla sprzęgieł dwutarczowych	1040

Struktura katalogu

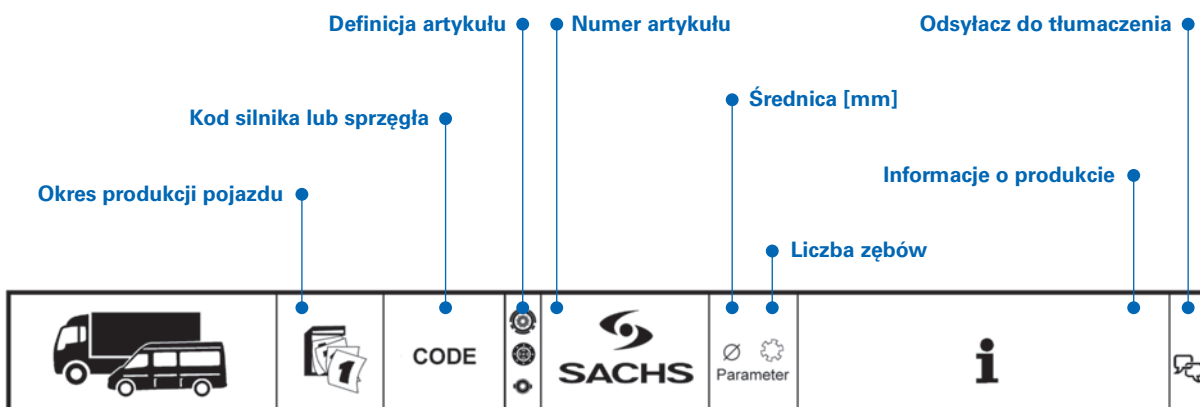

DAF

LF		05.13 -					
FA 180	05.13-	PX-5135		3400 700 465	362 10	Getr. / GBoX: 6 S 700	(18)
				3482 000 859	MF362	Getr. / GBoX: 6 AS 700	
				1878 005 601	362WGTZ	Euro 6 / Euro 6	
				3151 000 651	KZIS-4		
				3400 700 464	362 10	Getr. / GBoX: 6 S 800	(18)
				3482 000 859	MF362	Getr. / GBoX: 6 AS 800	
				1878 005 600	362WGTZ	Euro 6 / Euro 6	
				3151 000 651	KZIS-4		
				3400 700 603	350	Getr. / GBoX: S5-42	(18)
				3482 001 166	MF350	Euro 6 / Euro 6	
				1878 007 172	350WGTZ		
				3151 000 397	KZIS-4		
FA 210	05.13-	PX-5157		3400 700 465	362 10	Getr. / GBoX: 6 S 700	(18)
				3482 000 859	MF362	Getr. / GBoX: 6 AS 700	
				1878 005 601	362WGTZ	Euro 6 / Euro 6	
				3151 000 651	KZIS-4		
				3400 700 464	362 10	Getr. / GBoX: 6 S 800	(18)
				3482 000 859	MF362	Getr. / GBoX: 6 AS 800	
				1878 005 600	362WGTZ	Euro 6 / Euro 6	
				3151 000 651	KZIS-4		
				3400 700 603	350	Getr. / GBoX: S5-42	(18)
				3482 001 166	MF350	Euro 6 / Euro 6	
				1878 007 172	350WGTZ		
				3151 000 397	KZIS-4		

Parametry

	Tarcze dociskowe sprzęgła
Z/	Do wersji z dwoma tarczami
400	Średnica zewnętrzna powierzchni tarcia 400 mm
Do	Podwójne sprzęgło, wyprężanie zależne
Du	Podwójne sprzęgło, wyprężanie niezależne
/E	XTend
F	Płaskie koło zamachowe
G	Sprzęgło z odlewaną obudową
K	Sprzęgło ze sprężyną śrubową
KM	Z sprężyną membranową i systemem dźwigniowym
M	Sprzęgło ze sprężyną membranową
N	Napęd dodatkowy
S	Wersja ze sworzniem obrotowym
T	Z sprężyną talerzową
XTend	Z automatycznym nastawianiem
Z	Wyprężanie z ciągnem

	Tarcza sprzęgła
200	Średnica zewnętrzna 200 mm
CE	Nieorganiczna powłoka spiekana
B/D/E/Z	Elastyczne okładziny
BH/GS/GT/GV	Tłumiki drgań skrętnych dla pojazdów użytkowych
/E	XTend
W/V	Tłumiki wstępne dla pojazdów użytkowych

	Łożysko wyciskowe
...A	Pierścień zewnętrzny współbieżny
G	Pierścień oporowy grafitowy
GK	Pierścień oporowy grafitowy i łożysko kulkowe
GR	Łożysko kulkowe z osłoną blaszaną
GZ	Pompa sprzęgłowa
HHIS	Koncentryczny cylinder odbiorczy
...I	Pierścień wewnętrzny współbieżny
KT	Teflonowa podkładka oporowa
KZ	Łożysko kulkowe, prowadzone centralnie
NZ	Cylinder odbiorczy
...S	Pierścień wewnętrzny samocentrujący
...Z	Wyprężanie z ciągnem

Tłumaczenia

(1)	Liczba otworów do mocowania w CSC: 2
(2)	Liczba otworów do mocowania w CSC: 3
(3)	Liczba okładzin
(4)	Widelki wyprzęgające, wiszące [mm]
(5)	Widelki wyprzęgające, stojące [mm]
(6)	Część wymienna zamieniona na 3400 121 002
(7)	Średnica zewnętrzna [mm]
(8)	W razie problemów z niepożądanymi odgłosami
(9)	Zawiera wyprzęgnik i zestaw montażowy
(10)	Zawiera koło dwumasowe, tarczę dociskową, tarczę sprzęgła i wyprzęgnik
(11)	Zawiera koło dwumasowe, tarczę dociskową, tarczę sprzęgła i CSC
(12)	Szerokość [mm]
(13)	Diesel
(14)	Średnica przyłącza przewodu ciśnieniowego [mm]
(15)	Euro 3
(16)	Euro 4 (D4)
(17)	Euro 5
(18)	Euro 6
(19)	Euro 3 / Euro 4
(20)	Euro 4 / Euro 5
(21)	Euro 5 / Euro 6
(22)	Pojazd może zostać wyposażony w sprzęgła o różnej wielkości
(23)	Pojazdy mogą być wyposażone w różne komponenty
(24)	Przekładnia Fullera
(25)	Czynnik wypełniający: płyn hamulcowy
(26)	Czynnik wypełniający: olej mineralny
(27)	Na eksport
(28)	Numer przekładni
(29)	Długość osłony [mm]
(30)	Zawsze wymieniać
(31)	Zawarte w 1888
(32)	Zawarte w 3483/3488
(33)	Zawarte w 3483
(34)	Średnica wewnętrzna [mm]
(35)	Wyposażone w różne sprzęgła według życzenia klienta
(36)	Długość przewodu [mm]
(37)	Parametry
(38)	Łożysko kulkowe
(39)	Tarcza sprzęgła ze wstępnym tłumikiem drgań
(40)	Moc [kW]
(41)	Wolna tarcza sprzęgła
(42)	Wersja krajowa: Wielka Brytania
(43)	Wersja krajowa: Turcja
(44)	Długość tłoczyska [mm]
(45)	Długość [mm]
(46)	Rodzaj montażu: niezamontowany wstępnie
(47)	Zestaw do montażu łożyska wyprzęgnika
(48)	Profil piasty
(49)	Łożysko igiełkowe

Переводы

- (50) ID napędu dodatkowego
- (51) Dostępne tylko w przypadku zwrotu zużytej części (naprawa; zakład Bielefeld)
- (52) Montować tylko wtedy, gdy pojazd jest wyposażony w sprzęgło M
- (53) Montować tylko razem
- (54) Numer seryjny
- (55) Od numeru seryjnego
- (56) Do numeru seryjnego
- (57) Rozstaw kół [mm]
- (58) Wersja rolkowa
- (59) Sekwencyjna skrzynia biegów
- (60) Wersja specjalna
- (61) Tarcza sprzęgła z tłumikiem drgań skrętnych
- (62) Przekładnia ZF
- (63) Alternatywny zestaw naprawczy
- (65) W zestawie śruby do mocowania tarczy dociskającej
- (66) W zestawie śruby do mocowania koła zamachowego
- (67) Zawiera jedną tarczę sprzęgła
- (68) Zawiera dwie tarcze sprzęgła
- (69) Do
- (70) Do widełek wyprzęgających z krzywką
- (71) Do widełek wyprzęgających z rolkami
- (72) Do pojazdów z sprzęgłem jednotarczowym
- (73) Do pojazdów z silownikiem sprzęgła
- (74) Do pojazdów z niskociśnieniowym układem hamulcowym
- (75) Do pojazdów z retarderem
- (76) Do pojazdów z przekładnią hydrokinetyczną ze sprzęgłem ciernym
- (77) Do pojazdów z sprzęgłem dwutarczowym
- (78) Do sprężyny membranowej o średnicy wewnętrznej 100 mm
- (79) Do sprężyny membranowej o średnicy wewnętrznej 120 mm
- (80) Do silników z podwójnym kołem zamachowym
- (81) Do silników bez podwójnego koła zamachowego
- (82) Do napędu dodatkowego
- (83) Do numeru OE
- (84) Do koła zamachowego o głębokości [mm]
- (85) W zależności od wykonania z różnymi sprzęgłami
- (86) Długi kabłąk
- (87) Maksymalny przenoszony moment silnika [Nm]
- (88) Z pierścieniem rozruchowym
- (89) Z smarowaniem długoterminowym
- (90) Z retarderem VR 115E
- (91) Z przyłączem rury smarowania
- (92) Z czujnikiem
- (93) Z wyposażeniem
- (94) Z pierścieniem pośrednim
- (95) Z automatycznym nastawianiem
- (96) Nie do
- (97) Nie do podwozi o numerze
- (98) Nie do silników o numerze
- (99) Nie w połączeniu z wymienną tarczą sprzęgła

Переводы

(100) Tylko jako zamiennik dla podanego nr OE

(101) Tylko w połączeniu z

(102) Bez pierścienia rozruchowego

(103) Bez przyłącza rury smarowania

(104) Bez śrub do mocowania koła zamachowego

(105) Bez czujnika

(106) Bez pierścienia pośredniego

DE

EN

FR

ES

PT

IT

NL

NO

SV

FI

PL

RU

HU

CS

RO

HR

EL

TR

ZH

DE

EN

FR

ES

PT

IT

NL

NO

SV

FI

PL

RU

HU

CS

RO

HR

EL

TR

ZH

Memo

Общая информация



Все приведенные в данном каталоге продукты разрешается устанавливать только обученному персоналу автомобильной мастерской.

Для удовлетворения вашего запроса нам необходим полный номер для заказа, например:

Комплект сцепления	3400 122 201
Нажимной диск сцепления	3482 083 032
Ведомый диск сцепления	1878 004 832
Выжимной подшипник	3151 000 034

В случае сомнений необходимо указать обозначение типа и год выпуска автомобиля, для которого предназначено заказываемое изделие.

В данном каталоге представлена часть нашего ассортимента продукции. Полный список вы найдете в наших электронных изданиях.

Все права защищены. Копирование либо совместное использование данного каталога в том числе частичное для составления собственного каталога недопустимо без особого на то согласия.

Номера запасных частей производителей автомобилей указаны исключительно в целях сравнения. Использование подобных данных в счетах, выставляемых владельцам автомобилей, недопустимо.

Действующие общие условия заключения сделок приведены на сайте www.zf.com/aftermarket/documents

www.zf.com/aftermarket/catalog

WebCat

Онлайн-каталог

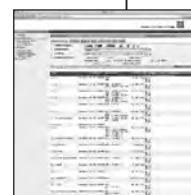

InCat

Электронный каталог



PrintCat

Печатные каталоги



Оглавление

Index	U2
Символы	U5 - U6
Общая информация	V61
Структура каталога	V62
Характеристики	V62
Переводы	V63 - V65
Арифметический список сравнительная таблица	938 - 984 985 - 1028
Новинки	1029 - 1034
Измененный номер для заказа	1034 - 1035
Зачеркнутые номера	1036
Таблица размеров профилей ступиц	1037
Таблица размеров дисковых маховиков	1038 - 1039
Спецификации для двухдисковых сцеплений	1040

Структура каталога

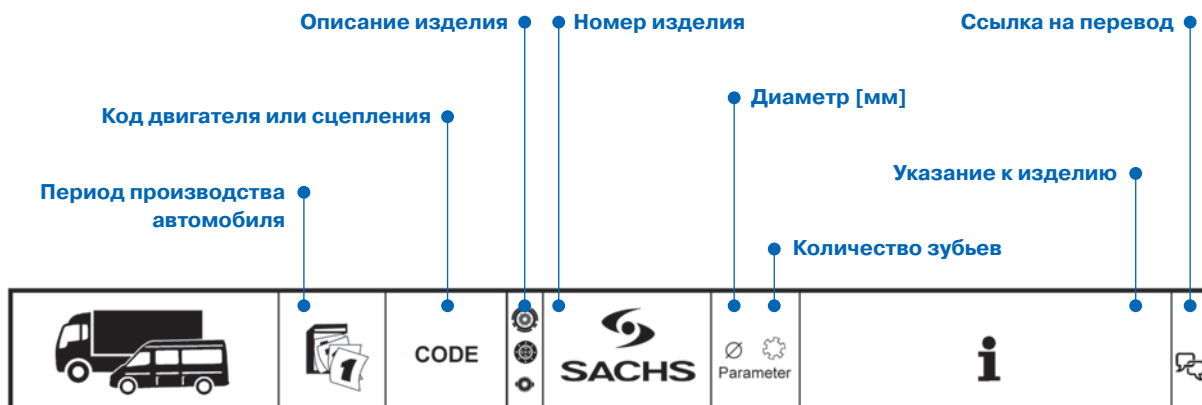

DAF

LF		05.13 -					
FA 180	05.13-	PX-5135		3400 700 465	362 10	Getr. / GBox: 6 S 700	(18)
				3482 000 859	MF362	Getr. / GBox: 6 AS 700	
				1878 005 601	362WGTZ	Euro 6 / Euro 6	
				3151 000 651	KZIS-4		
				3400 700 464	362 10	Getr. / GBox: 6 S 800	(18)
				3482 000 859	MF362	Getr. / GBox: 6 AS 800	
				1878 005 600	362WGTZ	Euro 6 / Euro 6	
				3151 000 651	KZIS-4		
				3400 700 603	350	Getr. / GBox: S5-42	(18)
				3482 001 166	MF350	Euro 6 / Euro 6	
				1878 007 172	350WGTZ		
				3151 000 397	KZIS-4		
FA 210	05.13-	PX-5157		3400 700 465	362 10	Getr. / GBox: 6 S 700	(18)
				3482 000 859	MF362	Getr. / GBox: 6 AS 700	
				1878 005 601	362WGTZ	Euro 6 / Euro 6	
				3151 000 651	KZIS-4		
				3400 700 464	362 10	Getr. / GBox: 6 S 800	(18)
				3482 000 859	MF362	Getr. / GBox: 6 AS 800	
				1878 005 600	362WGTZ	Euro 6 / Euro 6	
				3151 000 651	KZIS-4		
				3400 700 603	350	Getr. / GBox: S5-42	(18)
				3482 001 166	MF350	Euro 6 / Euro 6	
				1878 007 172	350WGTZ		
				3151 000 397	KZIS-4		

Характеристики

Нажимные диски сцепления

2/	Для исполнения с двумя шайбами
400	Наружный диаметр поверхности трения 400 мм
Do	Двойное сцепление, зависимое выключение
Du	Двойное сцепление, независимое выключение
/E	XTend
F	Плоский маховик
G	Сцепление с литым картером
K	Сцепление с витой пружиной
KM	С мембранной пружиной и системой рычагов
M	Сцепление с мембранной пружиной
N	Механизм отбора мощности
S	Исполнение откидного болта
T	С тарельчатой пружиной
XTend	С автоматической регулировкой
Z	Выключение при обратном выжиме

Ведомые диски сцепления

200	Наружный диаметр 200 мм
CE	Накладка из неорганического спеченного материала
B/D/E/Z	Подпружинивание накладки
BH/GS/GT/GV	Гасители крутильных колебаний для грузовых автомобилей
/E	XTend
W/V	Первичный гаситель для грузовых автомобилей

Выжимной подшипник

...A	Наружное кольцо, вращающееся совместно
G	Графитовое упорное кольцо
GK	Графитовое упорное кольцо и шарикоподшипник
GR	Шарикоподшипник с колпачком
GZ	Главный цилиндр
HHIS	Концентрический рабочий цилиндр
...I	Внутреннее кольцо, вращающееся совместно
KT	Тefлоновая регулировочная шайба
KZ	Шарикоподшипник, с центральным направлением
NZ	Рабочий цилиндр
...S	Самоцентрирующееся внутреннее кольцо
...Z	Выключение при обратном выжиме

Переводы

- (1) Количество крепежных отверстий на CSC: 2
- (2) Количество крепежных отверстий на CSC: 3
- (3) Количество накладок
- (4) Вилка выключения сцепления висящая мм
- (5) Вилка выключения сцепления стоящая мм
- (6) Обратная деталь заменена на 3400 121 002
- (7) Наружный диаметр мм
- (8) В случае возникновения шумов
- (9) Включает выжимной подшипник и монтажный комплект
- (10) Включает ДМ, нажимной, ведомый диски сцепления и выжимной подшипник
- (11) Включает ДМ, нажимной, ведомый диски сцепления и CSC
- (12) Ширина мм
- (13) Дизель
- (14) Диаметр патрубка напорного трубопровода мм
- (15) Евро-3
- (16) Евро-4 (D4)
- (17) Евро-5
- (18) Евро-6
- (19) Евро-3 / Евро-4
- (20) Евро-4 / Евро-5
- (21) Евро-5 / Евро-6
- (22) На автомобиле может быть установлено сцепление разного размера
- (23) Автомобили могут быть оснащены различными компонентами
- (24) Коробка передач Fuller
- (25) Рабочая среда: тормозная жидкость
- (26) Рабочая среда: минеральное масло
- (27) Для экспорта
- (28) Номер коробки передач
- (29) Длина кожуха мм
- (30) Всегда заменять
- (31) Содержится в 1888
- (32) Содержится в 3483/3488
- (33) Содержится в 3488
- (34) Внутренний диаметр мм
- (35) С разным сцеплением по желанию заказчика
- (36) Длина кабеля мм
- (37) Характеристика
- (38) Шарикоподшипник
- (39) Ведомый диск сцепления с первичным гасителем
- (40) Мощность, кВт
- (41) Незакрепленный ведомый диск сцепления
- (42) Экспортное исполнение: Великобритания
- (43) Экспортное исполнение: Турция
- (44) Длина штока амортизатора, мм
- (45) Длина мм
- (46) Вид монтажа: без предварительной сборки
- (47) Монтажный комплект для выжимного подшипника
- (48) Профиль ступицы
- (49) Игольчатый подшипник

Переводы

- (50) Идентификатор механизма отбора мощности
- (51) Поставляется только при возврате старой детали (ремонт; завод в Билефельде)
- (52) Устанавливать только в том случае, если автомобиль оснащен сцеплением M
- (53) Устанавливать только совместно
- (54) Производственный номер
- (55) Начиная с производственного номера
- (56) До производственного номера
- (57) Колесная база мм
- (58) Роликовое исполнение
- (59) Секвентальная коробка передач
- (60) Специальное исполнение
- (61) Ведомый диск сцепления с торсионным демпфером
- (62) Коробка передач ZF
- (63) Альтернативный ремкомплект
- (65) включает винты крепления нажимного диска
- (66) Включает в себя винты крепления нажимного диска
- (67) Включает один диск сцепления
- (68) Включает два диска сцепления
- (69) Для
- (70) Для вилки выключения сцепления с кулачками
- (71) Для вилки выключения сцепления с роликами
- (72) Для автомобилей с однодисковым сцеплением
- (73) Для автомобилей с усилителем привода управления сцеплением
- (74) Для автомобилей с тормозной системой низкого давления
- (75) Для автомобилей с ретардером
- (76) Для автомобилей с блокировочной муфтой трансформатора
- (77) Для автомобилей с двухдисковым сцеплением
- (78) Для диафрагменных пружин с внутренним диаметром 100 мм
- (79) Для диафрагменных пружин с внутренним диаметром 120 мм
- (80) Для двигателей с двухмассовым маховиком
- (81) Для двигателей без двухмассового маховика
- (82) Для механизма отбора мощности
- (83) Для оригинального номера детали
- (84) Для глубины маховика мм
- (85) В зависимости от исполнения с различным сцеплением
- (86) Длинный зажим
- (87) Максимальный передаваемый крутящий момент двигателя Нм
- (88) С упорным кольцом
- (89) С постоянной смазкой
- (90) С ретардером VR 115E
- (91) С подключением трубопровода для смазочной линии
- (92) С датчиком
- (93) С принадлежностями
- (94) С прокладочным кольцом
- (95) С автоматической регулировкой
- (96) Не для
- (97) Не для шасси номера
- (98) Не для номера двигателя
- (99) Не в сочетании с обратным ведомым диском сцепления

Переводы

(100) Не только заменить указанный OE нет.

(101) Только в комбинации с

(102) Без упорного кольца

(103) Без подключения трубопровода для смазочной линии

(104) Без крепежных болтов маховика

(105) Без датчика

(106) Без прокладочного кольца

DE

EN

FR

ES

PT

IT

NL

NO

SV

FI

PL

RU

HU

CS

RO

HR

EL

TR

ZH

Memo

Általános információk



A jelen katalógusban feltüntetett valamennyi terméket csak gépjárműjavító szakműhely szakképzett személyzete építheti be.

A rendelésekhez szükségünk van a teljes alvázszámra, például:

Tengelykapcsoló-készlet	3400 122 201
Tengelykapcsoló nyomólap	3482 083 032
Kuplungtárcsa	1878 004 832
Kinyomócsapágy	3151 000 034

Kétely esetén adja meg a cikkhez illő jármű típus-megnevezését és gyártási évét.

Ez a katalógus a termékskálánk kivonatát képezi, a teljes áttekintés elektronikus médiumainkon található.

Minden jog fenntartva. Tilos a tulajdonos kifejezett engedély nélkül a katalógus sokszorosítása vagy közös használata, akár kivonatolva is, saját katalógus készítése céljából.

A járműgyártók pótalkatrész-számai csak az összehasonlítást szolgálják. Ezen adatok használata a jármű tulajdonosának kiállított számlájában nem megengedett.

Az aktuális általános üzleti feltételeket a következő címen találja meg www.zf.com/aftermarket/documents

www.zf.com/aftermarket/catalog

WebCat

Online katalógus

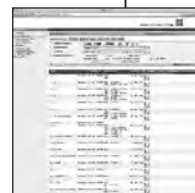

InCat

Elektronikus katalógus



PrintCat

Nyomtatott katalógusok



Tartalomjegyzék

Index	U2
Szimbólumok	U5 - U6
Általános információk	V67
A katalógus felépítése	V68
Jellemzők	V68
Fordítások	V69 - V71
Aritmetikai lista	938 - 984
Összehasonlító lista	985 - 1028
Új tételek	1029 - 1034
Módosított megrendelési szám	1034 - 1035
Törölt számok	1036
Mérettáblázat bordázathoz	1037
Mérettáblázat lendkerekekhez	1038 - 1039
Darablisták kéttárcsás tengelykapcsolóhoz	1040

A katalógus felépítése

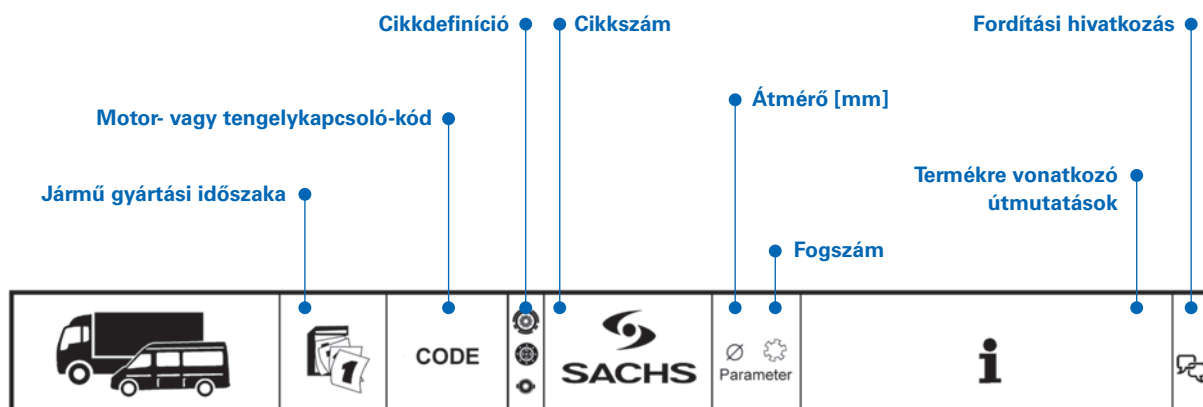

DAF

LF		05.13 -					
FA 180	05.13-	PX-5135		3400 700 465	362 10	Getr. / GBox: 6 S 700	(18)
				3482 000 859	MF362	Getr. / GBox: 6 AS 700	
				1878 005 601	362WGTZ	Euro 6 / Euro 6	
				3151 000 651	KZIS-4		
				3400 700 464	362 10	Getr. / GBox: 6 S 800	(18)
				3482 000 859	MF362	Getr. / GBox: 6 AS 800	
				1878 005 600	362WGTZ	Euro 6 / Euro 6	
				3151 000 651	KZIS-4		
				3400 700 603	350	Getr. / GBox: S5-42	(18)
				3482 001 166	MF350	Euro 6 / Euro 6	
				1878 007 172	350WGTZ		
				3151 000 397	KZIS-4		
FA 210	05.13-	PX-5157		3400 700 465	362 10	Getr. / GBox: 6 S 700	(18)
				3482 000 859	MF362	Getr. / GBox: 6 AS 700	
				1878 005 601	362WGTZ	Euro 6 / Euro 6	
				3151 000 651	KZIS-4		
				3400 700 464	362 10	Getr. / GBox: 6 S 800	(18)
				3482 000 859	MF362	Getr. / GBox: 6 AS 800	
				1878 005 600	362WGTZ	Euro 6 / Euro 6	
				3151 000 651	KZIS-4		
				3400 700 603	350	Getr. / GBox: S5-42	(18)
				3482 001 166	MF350	Euro 6 / Euro 6	
				1878 007 172	350WGTZ		
				3151 000 397	KZIS-4		

Jellemzők

Kuplung nyomólapok

Z/	Kéttárcsás kivitelhez
400	Dörzsfelület külső átmérője 400 mm
Do	Dupla kuplung, függő kinyomás
Du	Dupla kuplung, független kinyomás
/E	XTend
F	Lapos lendkerék
G	Kuplung öntvényházzal
K	Spirálrugós kuplung
KM	Membránrugóval és emelőrendszerrel
M	Tányérrugós kuplung
N	Mellékajtás
S	Önbeálló csatlakozásos kivitel
T	Tányérrugóval
XTend	Automatikus utánállítással
Z	Kinyomás húzásra

Kuplungtárcsák

200	Külső átmérő 200 mm
CE	Szeretlen fémbevonat
B/D/E/Z	Burkolatrugózások
BH/GS/GT/GV	Torziós csillapító haszongépjárművekhez
/E	XTend
W/V	Előlenegcsillapító haszongépjárművekhez

Kinyomócsapágó

...A	Együtt mozgó külső gyűrű
G	Grafit indítógyűrű
GK	Grafit indítógyűrű és golyóscsapó
GR	Golyóscsapó lemezkupakkal
GZ	Elsődleges kuplunghenger
HHIS	Koncentrikus másodlagos kuplung henger
...I	Együtt mozgó belső gyűrű
KT	Teflon indítótarcsa
KZ	Golyóscsapó, központi vezetésű
NZ	Másodlagos kuplunghenger
...S	Öncentrírozó belső gyűrű
...Z	Kinyomás húzásra

Fordítások

(1)	Rögzítőfuratok száma a CSC-n: 2
(2)	Rögzítőfuratok száma a CSC-n: 3
(3)	Betétek száma
(4)	Függő kinyomó villa [mm]
(5)	Álló kinyomó villa [mm]
(6)	A cserealkatrészt a 3400 121 002 váltja fel
(7)	Külső átmérő [mm]
(8)	Zajproblémáknál
(9)	Kinyomócsapágyat és szerelőkészletet tartalmaz
(10)	Kéttömegű lendkereket, nyomólapot, kuplungtárcsát és kinyomócsapágyat tartalmaz
(11)	Kéttömegű lendkereket, nyomólapot, kuplungtárcsát és CSC-t tartalmaz
(12)	Szélesség [mm]
(13)	Dízel
(14)	Nyomásvezeték csatlakozójának az átmérője [mm]
(15)	Euro 3
(16)	Euro 4 (D4)
(17)	Euro 5
(18)	Euro 6
(19)	Euro 3 / Euro 4
(20)	Euro 4 / Euro 5
(21)	Euro 5 / Euro 6
(22)	A jármű eltérő kuplungmérettel is rendelkezhethet
(23)	A járművek különböző alkatrészekkel lehetnek felszerelve
(24)	Fuller váltó
(25)	Töltőközeg: fékfolyadék
(26)	Töltőközeg: ásványolaj
(27)	Exportra
(28)	Váltó száma
(29)	Palásthossz [mm]
(30)	Mindig cserélendő
(31)	A 1888 tartalmazza
(32)	A 3483/3488 tartalmazza
(33)	A 3488... .. tartalmazza
(34)	Belső átmérő [mm]
(35)	Vevő kérésére különböző kuplunggal
(36)	Kábelhossz [mm]
(37)	Jellemző érték
(38)	Golyóscsapágy
(39)	Kuplungtárcsa előcsillapítóval
(40)	Teljesítmény [kW]
(41)	Szabad kuplungtárcsa
(42)	Országra jellemző kivitel: Nagy-Britannia
(43)	Országra jellemző kivitel: Törökország
(44)	Dugattyúrúd hosszúsága [mm]
(45)	Hosszúság [mm]
(46)	Szerelési mód: nem előreszerelt
(47)	Szerelőkészlet a kinyomócsapágyhoz
(48)	Bordázat
(49)	Tűcsapágy

Fordítások

- (50) Mellékhajtás-ID
- (51) Csak régi alkatrész visszaszolgáltatása esetén szállítható (javítás; Bielefeld üzem)
- (52) Csak akkor építhető be, ha a jármű M-kuplunggal van ellátva
- (53) Csak együtt lehet beépíteni
- (54) Gyártási szám
- (55) Gyártási számtól
- (56) Gyártási számig
- (57) Tengelytáv [mm]
- (58) Görgős kivitel
- (59) Szekvenciális váltó
- (60) Különleges kivitel
- (61) Torziósrugózású kuplungtárcsa
- (62) ZF váltó
- (63) Alternatív javítókészlet
- (65) Nyomólap-rögzítőcsavarokat tartalmaz
- (66) Lendkerék-rögzítőcsavarokat tartalmaz
- (67) Egy kuplungtárcsát tartalmaz
- (68) Két kuplungtárcsát tartalmaz
- (69) Ehhez
- (70) Büttykös kinyomóvilla
- (71) Görgős kinyomóvilla
- (72) Egytárcsás kuplunggal szerelt járművekhez
- (73) Kuplungerősítővel szerelt járművekhez
- (74) Alacsony nyomású fékrendszerrel szerelt járművekhez
- (75) Retarderrel szerelt járművekhez
- (76) Nyomatékmódosító kuplunggal szerelt járművekhez
- (77) Kéttárcsás kuplunggal szerelt járművekhez
- (78) 100 mm belső átmérőjű membránrugóhoz
- (79) 120 mm belső átmérőjű membránrugóhoz
- (80) Kétsúlyos lendkerékkel rendelkező motorokhoz
- (81) Kétsúlyos lendkerék nélküli motorokhoz
- (82) Mellékhajtáshoz
- (83) OE számhoz
- (84) Lendkerék-mélységhez [mm]
- (85) Kivitel szerint különböző kuplunggal
- (86) Hosszú kengyel
- (87) Maximum átvihető motornyomaték [Nm]
- (88) Indítógyűrűvel
- (89) Tartós kenéssel
- (90) VR 115E retarderrel
- (91) Kenőcső csatlakozóval
- (92) Érzékelővel
- (93) Tartozékokkal
- (94) Közbenső gyűrűvel
- (95) Automatikus utánállítással
- (96) Ezekhez nem
- (97) Nem a következő alvázszámhoz
- (98) Ehhez a motorszámhoz nem
- (99) Nem csere-kuplungtárcsával együtt

Fordítások

(100) Csak csereként a megadott OE-sz.

(101) Csak ezzel kapcsolatban

(102) Indítógyűrű nélkül

(103) Kenőcsőcsatlakozó nélkül

(104) Lendkerék-rögzítőcsavarok nélkül

(105) Érzékelő nélkül

(106) Közbenső gyűrű nélkül

DE

EN

FR

ES

PT

IT

NL

NO

SV

FI

PL

RU

HU

CS

RO

HR

EL

TR

ZH

DE

EN

FR

ES

PT

IT

NL

NO

SV

FI

PL

RU

HU

CS

RO

HR

EL

TR

ZH

Memo

Všeobecné informace



Všechny výrobky uvedené v tomto katalogu smí instalovat pouze školený personál odborného autoservisu.

Pro vaše požadavky potřebujeme úplné objednací číslo, např.:

Spojková sada	3400 122 201
Přítlačná deska spojky	3482 083 032
Kotouč spojky	1878 004 832
Vypínací ústrojí	3151 000 034

V případě pochybností udejte typové označení a rok výroby vozidla, pro které je požadovaný výrobek určen.

Tento katalog představuje výběr z našeho výrobního programu, úplný přehled najdete na našich elektronických médiích.

Všechna práva vyhrazena. Rozmnožování nebo využití tohoto katalogu nebo jeho částí pro výrobu vlastního katalogu nejsou bez výslovného souhlasu dovoleny.

Číslo náhradních dílů výrobců vozidel slouží jen pro účely srovnávání. Použití takových údajů ve fakturách vlastníkům vozidel není dovoleno.

Aktuální obecné obchodní podmínky najdete na www.zf.com/aftermarket/documents

www.zf.com/aftermarket/catalog

WebCat

Katalog online

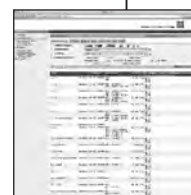

InCat

Elektronický katalog



PrintCat

Tištěné katalogy



Obsah

Index	U2
Symboly	U5 - U6
Všeobecné informace	V73
Struktura katalogu	V74
Parametry	V74
Překlady	V75 - V77
Aritmetický soupis	938 - 984
Srovnávací seznam	985 - 1028
Nové výrobky	1029 - 1034
Změněné objednací číslo	1034 - 1035
Vyřazená čísla	1036
Tabulka rozměrů profilů nábojů	1037
Tabulka rozměrů setrvačnickových kol	1038 - 1039
Kusovníky pro dvoukotoučové spojky	1040

Struktura katalogu

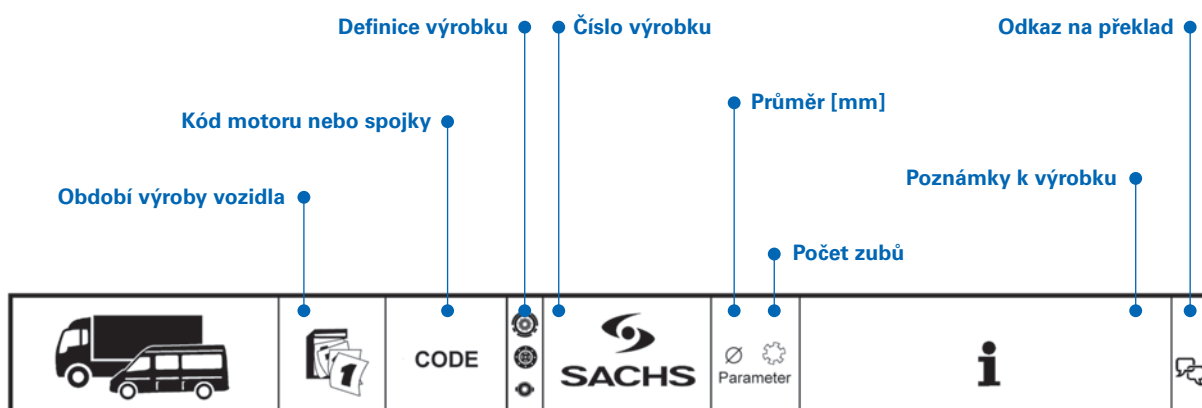

DAF

LF		05.13 -					
FA 180	05.13-	PX-5135		3400 700 465	362 10	Getr. / GBox: 6 S 700	(18)
				3482 000 859	MF362	Getr. / GBox: 6 AS 700	
				1878 005 601	362WGTZ	Euro 6 / Euro 6	
				3151 000 651	KZIS-4		
				3400 700 464	362 10	Getr. / GBox: 6 S 800	(18)
				3482 000 859	MF362	Getr. / GBox: 6 AS 800	
				1878 005 600	362WGTZ	Euro 6 / Euro 6	
				3151 000 651	KZIS-4		
				3400 700 603	350	Getr. / GBox: S5-42	(18)
				3482 001 166	MF350	Euro 6 / Euro 6	
				1878 007 172	350WGTZ		
				3151 000 397	KZIS-4		
FA 210	05.13-	PX-5157		3400 700 465	362 10	Getr. / GBox: 6 S 700	(18)
				3482 000 859	MF362	Getr. / GBox: 6 AS 700	
				1878 005 601	362WGTZ	Euro 6 / Euro 6	
				3151 000 651	KZIS-4		
				3400 700 464	362 10	Getr. / GBox: 6 S 800	(18)
				3482 000 859	MF362	Getr. / GBox: 6 AS 800	
				1878 005 600	362WGTZ	Euro 6 / Euro 6	
				3151 000 651	KZIS-4		
				3400 700 603	350	Getr. / GBox: S5-42	(18)
				3482 001 166	MF350	Euro 6 / Euro 6	
				1878 007 172	350WGTZ		
				3151 000 397	KZIS-4		

Parametry

Přítlačné desky spojky

Z/	Pro dvoukotoučové provedení
400	Vnější průměr třecích ploch 400 mm
Do	Dvojitá spojka, závislé rozpojení
Du	Dvojitá spojka, nezávislé rozpojení
/E	XTend
F	Plochý setrvačnick
G	Spojka s litým tělem
K	Šroubová pružinová spojka
KM	S membránovou pružinou a pákovým systémem
M	Membránová pružná spojka
N	Pomocný pohon
S	Provedení kyvného čepu
T	S taliřovou pružinou
XTend	S automatickým nastavením
Z	Rozpojení tahem

Spojkové kotouče

200	Vnější průměr 200 mm
CE	Anorganické sintrované obložení
B/D/E/Z	Odpružení obložení
BH/GS/GT/GV	Torzni tlumiče pro užitková vozidla
/E	XTend
W/V	Vstupní potrubí tlumiče pro užitková vozidla

Výsuvná ložiska

...A	Vnější kroužek otáčivý
G	Grafitový přítlačný kroužek
GK	Grafitový přítlačný kroužek a kuličkové ložisko
GR	Kuličkové ložisko s plechovým víčkem
GZ	Hlavní válec
HHIS	Koncentrický pracovní válec
...I	Vnitřní kroužek otáčivý
KT	Teflonová opěrná podložka
KZ	Kuličkové ložisko, s centrálním vedením
NZ	Pracovní válec
...S	Samostředící vnitřní kroužek
...Z	Rozpojení tahem

Překlady

- (1) Počet upevňovacích otvorů na CSC: 2
- (2) Počet upevňovacích otvorů na CSC: 3
- (3) Počet obložení
- (4) Vysouvací vidlice zavěšená [mm]
- (5) Vysouvací vidlice stojatá [mm]
- (6) Výměnná součást nahrazená 3400 121 002
- (7) Vnější průměr [mm]
- (8) Při problémech s hlukem
- (9) Obsahuje vypínací ústrojí a montážní sadu
- (10) Obsahuje ZMS, přítlačný kotouč, spojkovou lamelu a vypínací ústrojí
- (11) Obsahuje ZMS, přítlačný kotouč, spojkovou lamelu a CSC
- (12) Šířka [mm]
- (13) Diesel
- (14) Průměr přípojky výtlačného potrubí [mm]
- (15) Euro 3
- (16) Euro 4 (D4)
- (17) Euro 5
- (18) Euro 6
- (19) Euro 3 / Euro 4
- (20) Euro 4 / Euro 5
- (21) Euro 5 / Euro 6
- (22) Vozidlo může být vybaveno různými velikostmi spojky
- (23) Vozidla mohou být vybavena různými komponentami
- (24) Převodovky Fuller
- (25) Plnicí médium: Brzdová kapalina
- (26) Plnicí médium: Minerální olej
- (27) Pro export
- (28) Číslo převodovky
- (29) Délka obálky [mm]
- (30) Vždy vyměňte
- (31) V 1888 ... je obsaženo ...
- (32) V 3483/3488 ... je obsaženo ...
- (33) V 3488 ... je obsaženo ...
- (34) Vnitřní průměr [mm]
- (35) Podle přání zákazníka osazení různými spojkami
- (36) Délka kabelu [mm]
- (37) Parametr
- (38) Kuličkové ložisko
- (39) Spojková lamela s předřazeným tlumičem
- (40) Výkon [kW]
- (41) Volný kotouč spojky
- (42) Provedení pro zemi: Velká Británie
- (43) Provedení pro zemi: Turecko
- (44) Dlouhá pístnice [mm]
- (45) Délka [mm]
- (46) Druh montáže: Není předmontován
- (47) Montážní sada pro výsuvné ložisko
- (48) Profil náboje
- (49) Jehlové ložisko

Překlady

- (50) ID pomocného pohonu
- (51) Lze dodat jen při vrácení starého dílu (oprava; závod Bielefeld)
- (52) Montujte pouze když je vozidlo vybaveno spojkou M
- (53) Montujte pouze společně
- (54) Číslo výroby
- (55) Od čísla výrobku
- (56) Do čísla výroby
- (57) Rozvor kol [mm]
- (58) Válečkové provedení
- (59) Sekvenční manuální převodovka
- (60) Speciální provedení
- (61) Torzně odpružený kotouč spojky
- (62) Pevodovky ZF
- (63) Alternativní sada pro opravy
- (65) Obsahuje upevňovací šrouby přítlačné desky
- (66) Obsahuje upevňovací šrouby setrvačníku
- (67) Obsahuje jeden kotouč spojky
- (68) Obsahuje dva kotouče spojky
- (69) Pro
- (70) Pro vysouvací vidlici s výstupky
- (71) Pro vysouvací vidlici s válečky
- (72) Pro vozidla s jednokotoučovou spojkou
- (73) Pro vozidla s spojkou s posilovačem
- (74) Pro vozidla s nízkotlakým brzdovým systémem
- (75) Pro vozidla s retardérem
- (76) Pro vozidla s řadicí spojkou měniče točivého momentu
- (77) Pro vozidla s dvoukotoučovou spojkou
- (78) Pro membránové pružiny s vnitřním průměrem 100 mm
- (79) Pro membránové pružiny s vnitřním průměrem 120 mm
- (80) Pro motory s dvuhmotovým setrvačnickem
- (81) Pro motory bez dvuhmotového setrvačnicku
- (82) Pro pomocný pohon
- (83) Pro číslo dílu O
- (84) Pro hloubku setrvačnicku [mm]
- (85) Podle provedení s různými spojkami
- (86) Dlouhý třmen
- (87) Maximální přenášený moment motoru [Nm]
- (88) S přítlačným kroužkem
- (89) S trvalým mazáním
- (90) S retardérem VR 115E
- (91) S přípojkou mazací trubky
- (92) Se snímačem
- (93) S příslušenstvím
- (94) S vloženým kroužkem
- (95) S automatickým nastavením
- (96) Ne pro
- (97) Ne pro číslo podvozku
- (98) Ne pro číslo motoru
- (99) Ne ve spojení s výměnným kotoučem spojky

Překlady

(100) Jen jako náhrada za uvedené č. OE

(101) Jen ve spojení s

(102) Bez přitlačného kroužku

(103) Bez přípojky mazací trubky

(104) Bez upevňovacích šroubů setrvačnicku

(105) Bez snímače

(106) Bez vloženého kroužku

DE

EN

FR

ES

PT

IT

NL

NO

SV

FI

PL

RU

HU

CS

RO

HR

EL

TR

ZH

DE

EN

FR

ES

PT

IT

NL

NO

SV

FI

PL

RU

HU

CS

RO

HR

EL

TR

ZH

Memo

Informații generale



Montarea tuturor produselor prezentate în acest catalog este permisă numai personalului instruit al unui atelier de specialitate auto.

Pentru solicitarea dvs. avem nevoie de numărul complet al comenzii, de exemplu:

Kit ambreiaj	3400 122 201
Placă de presiune la ambreiaj	3482 083 032
Disc de ambreiaj	1878 004 832
Dispozitiv de debreiere	3151 000 034

În caz de dubii indicați denumire tipului și anul fabricației vehiculului aferent articolului dorit.

Acest catalog reprezintă un extras din gama de produse. O vedere de ansamblu găsiți pe mijloacele noastre de informare electronice.

Toate drepturile rezervate. Sunt interzise multiplicarea sau utilizarea comună a catalogului, chiar și în extras, pentru elaborarea unui catalog propriu, dacă se fac fără o aprobare expres în acest sens.

Numărul pieselor de schimb ale producătorului autovehiculului servesc numai pentru comparare. Nu este admisă folosirea unor astfel de date în facturile emise proprietarului vehiculului.

Condițiile comerciale actuale veți găsi la www.zf.com/aftermarket/documents

www.zf.com/aftermarket/catalog

WebCat
Catalog online

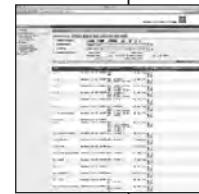

InCat
Catalog electronic



PrintCat
Cataloage tipărite



Cuprins

Index	U2
Simboluri	U5 - U6
Informații generale	V79
Structura catalogului	V80
Caracteristici	V80
Traduceri	V81 - V83
Listă aritmetică	938 - 984
Listă de comparație	985 - 1028
Înregistrări noi	1029 - 1034
Număr de comandă modificat	1034 - 1035
Număr barat	1036
Tabel de cote pentru profile de butuc	1037
Tabel de cote pentru volante	1038 - 1039
Liste de piese pentru ambreiajele cu două discuri	1040

Structura catalogului

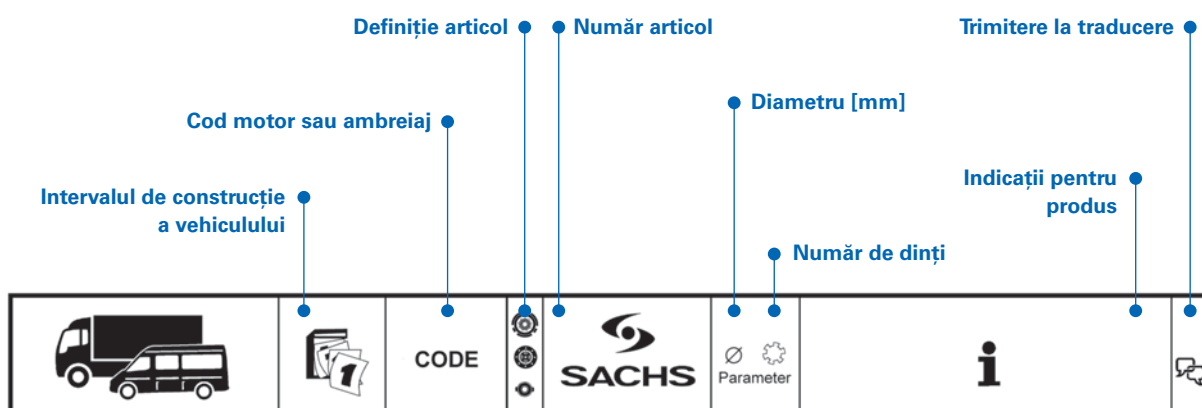

DAF

LF		05.13 -					
FA 180	05.13-	PX-5135		3400 700 465	362 10	Getr. / GBox: 6 S 700	(18)
				3482 000 859	MF362	Getr. / GBox: 6 AS 700	
				1878 005 601	362WGTZ	Euro 6 / Euro 6	
				3151 000 651	KZIS-4		
				3400 700 464	362 10	Getr. / GBox: 6 S 800	(18)
				3482 000 859	MF362	Getr. / GBox: 6 AS 800	
				1878 005 600	362WGTZ	Euro 6 / Euro 6	
				3151 000 651	KZIS-4		
				3400 700 603	350	Getr. / GBox: S5-42	(18)
				3482 001 166	MF350	Euro 6 / Euro 6	
				1878 007 172	350WGTZ		
				3151 000 397	KZIS-4		
FA 210	05.13-	PX-5157		3400 700 465	362 10	Getr. / GBox: 6 S 700	(18)
				3482 000 859	MF362	Getr. / GBox: 6 AS 700	
				1878 005 601	362WGTZ	Euro 6 / Euro 6	
				3151 000 651	KZIS-4		
				3400 700 464	362 10	Getr. / GBox: 6 S 800	(18)
				3482 000 859	MF362	Getr. / GBox: 6 AS 800	
				1878 005 600	362WGTZ	Euro 6 / Euro 6	
				3151 000 651	KZIS-4		
				3400 700 603	350	Getr. / GBox: S5-42	(18)
				3482 001 166	MF350	Euro 6 / Euro 6	
				1878 007 172	350WGTZ		
				3151 000 397	KZIS-4		

Caracteristici

Plăci de presiune la ambreiaj

2/	Pentru execuția cu volanță dublă
400	Diametru exterior al suprafeței de fricțiune 400 mm
Do	Ambreiaj dublu, dispozitiv de debreiere dependent
Du	Ambreiaj dublu, dispozitiv de debreiere independent
/E	XTend
F	Volanță plată
G	Ambreiaj cu carcasă turnată
K	Ambreiaj cu arc elicoidal
KM	Cu arc cu membrană și sistem de pârghii
M	Ambreiaj cu arc cu membrană
N	Priză de putere
S	Variantă cu bolț pivotant
T	Cu arc cu rondelă
XTend	Cu reajustare automată
Z	Dispozitiv de debreiere pe cablu

Discuri de ambreiaj

200	Diametru exterior 200 mm
CE	Garnitură sinterizată anorganică
B/D/E/Z	Suspensii cu garnitură
BH/GS/GT/GV	Amortizor de torsiune pentru autoutilitare
/E	XTend
W/V	Preamortizor pentru autoutilitare

Rulment de debreiere

...A	Inel exterior antrenat sincron
G	Inel de atac cu grafit
GK	Inel de atac cu grafit și rulment cu bile
GR	Rulment cu bile și cu căpăcel din tablă
GZ	Pompă de ambreiaj
HHIS	Cilindru receptor de ambreiaj, concentric
...I	Inel interior antrenat sincron
KT	Disc de atac cu teflon
KZ	Rulment cu bile, central
NZ	Cilindru receptor de ambreiaj
...S	Rulment interior autocentrant
...Z	Dispozitiv de debreiere pe cablu

Traduceri

- (1) Numărul de găuri de fixare la CSC: 2
- (2) Numărul de găuri de fixare la CSC: 3
- (3) Numărul de garnituri
- (4) Furcă de debreiere, suspendată [mm]
- (5) Furcă de debreiere, verticală [mm]
- (6) Piesă de schimb înlocuită cu 3400 121 002
- (7) Diametrul exterior [mm]
- (8) În caz de zgomote
- (9) Conține dispozitiv de debreiere și set montaj
- (10) Conține volanta cu masă dublă, placa de presiune ambreiaj, discul de ambreiaj și dispozitivul de debreiere
- (11) Conține volanta cu masă dublă, placa de presiune ambreiaj, discul de ambreiaj și CSC
- (12) Lățime [mm]
- (13) Diesel
- (14) Diametrul racordului conductei de presiune [mm]
- (15) Euro 3
- (16) Euro 4 (D4)
- (17) Euro 5
- (18) Euro 6
- (19) Euro 3 / Euro 4
- (20) Euro 4 / Euro 5
- (21) Euro 5 / Euro 6
- (22) Vehiculul poate fi echipat cu ambreiaje de mărimi diferite
- (23) Vehiculele pot fi dotate cu componente diferite
- (24) Transmisie Fuller
- (25) Mediu de alimentare: lichid de frână
- (26) Mediu de alimentare: ulei mineral
- (27) Pentru export
- (28) Număr transmisie
- (29) Lungime manșon [mm]
- (30) Se va înnoi de fiecare dată
- (31) Conținut în 1888
- (32) Conținut în 3483/3488
- (33) Conținut în 3488
- (34) Diametru interior [mm]
- (35) Echipat cu ambreiaje diferite, în funcție de cerințele clientului
- (36) Lungime cablu [mm]
- (37) Caracteristică
- (38) Rulment cu bile
- (39) Disc ambreiaj cu preamortizor
- (40) Putere [kW]
- (41) Disc de ambreiaj desprins
- (42) Varianta de țară: Marea Britanie
- (43) Varianta de țară: Turcia
- (44) Lungimea tijei pistonului [mm]
- (45) Lungime [mm]
- (46) Tipul montării: fără premontare
- (47) Set de montaj pentru rulment de ambreiaj
- (48) Profil butuc roată

Traduceri

- (49) Rulment cu ace
- (50) ID priză de putere
- (51) Disponibil numai cu predarea piesei uzate (reparație, uzina Bielefeld)
- (52) Montați numai dacă vehiculul este echipat cu ambreiaj de tip M
- (53) Nu se montează decât împreună
- (54) Număr de producție
- (55) De la numărul de producție
- (56) Până la numărul de producție
- (57) Ampatament [mm]
- (58) Varianta cu role
- (59) Cutie de viteze manuală secvențială
- (60) Construcție specială
- (61) Disc de ambreiaj rezistent la torsiune
- (62) Transmisie ZF
- (63) Set reparație alternativ
- (65) Conține șuruburi de fixare pentru placa de presiune
- (66) Conține șuruburi de fixare pentru volantă
- (67) Conține un disc de ambreiaj
- (68) Conține două discuri de ambreiaj
- (69) Pentru
- (70) Pentru furca de debreiere cu came
- (71) Pentru furca de debreiere cu role
- (72) Pentru vehicule cu ambreiaj cu un disc
- (73) Pentru vehicule cu servo-ambreiaj
- (74) Pentru vehicule cu instalație de frână de joasă presiune
- (75) Pentru vehicule cu Retarder
- (76) Pentru vehicule cu ambreiaj cu convertor de cuplu
- (77) Pentru vehicule cu ambreiaj cu două discuri
- (78) Pentru arc membrană cu diametru interior de 100 mm
- (79) Pentru arc membrană cu diametru interior de 120 mm
- (80) Pentru motoare cu volantă cu masă dublă
- (81) Pentru motoare fără volantă cu masă dublă
- (82) Pentru priză de putere
- (83) Pentru număr OE
- (84) Pentru grosimea volantei [mm]
- (85) Echipat cu ambreiaje diferite în funcție de variantă
- (86) Cadru lung
- (87) Cuplul motor maxim transmisibil [Nm]
- (88) Cu inel de atac
- (89) Cu lubrifiere permanentă
- (90) Cu Retarder VR 115E
- (91) Cu racord pentru tub de lubrifiere
- (92) Cu senzor
- (93) Cu accesorii
- (94) Cu inel intermediar
- (95) Cu reajustare automată
- (96) Nu pentru
- (97) Nu și pentru număr șasiu
- (98) Nu pentru serie motor

Traduceri

(99) Nu în combinație cu disc de ambreiaj de schimb

(100) Numai ca înlocuitor pentru nr. OE indicate

(101) Numai în combinație cu

(102) Fără inel de atac

(103) Fără racord pentru tub de lubrifiere

(104) Fără șuruburi de fixare pentru volantă

(105) Fără senzor

(106) Fără inel intermediar

DE

EN

FR

ES

PT

IT

NL

NO

SV

FI

PL

RU

HU

CS

RO

HR

EL

TR

ZH

DE

EN

FR

ES

PT

IT

NL

NO

SV

FI

PL

RU

HU

CS

RO

HR

EL

TR

ZH

Memo

Opće informacije



Sve proizvode navedene u ovom katalogu smiju ugrađivati samo školovani mehaničari u servisnoj radionici za motorna vozila.

Za vaše zahtjeve potreban nam je potpuni broj narudžbe, primjerice:

Komplet spojki	3400 122 201
Kompresijska ploča spojke	3482 083 032
Disk spojke	1878 004 832
Isključivač	3151 000 034

Ako ste u nedoumici, navedite oznaku tipa i godinu proizvodnje vozila za koje je namijenjen željeni artikl.

Ovaj katalog predstavlja izvadak iz našeg proizvodnog programa, a potpuni pregled možete naći na našim elektroničkim medijima.

Sva prava pridržana. Umnožavanje ili dijeljenje ovog kataloga, djelomično ili u cijelosti, radi izrade vlastita kataloga zabranjeno je bez izričitog pristanka njegova vlasnika.

Brojevi rezervnih dijelova proizvođača vozila služe samo za usporedbu. Primjena takvih podataka u računima izdanim vlasnicima vozila nije dopuštena.

Aktualne opće uvjete poslovanja naći ćete na adresi www.zf.com/aftermarket/documents

www.zf.com/aftermarket/catalog

WebCat

Online katalog

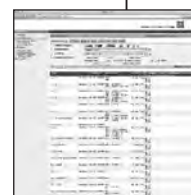

InCat

Elektronički katalog



PrintCat

Tiskani katalogi



Kazalo

Index	U2
Simboli	U5 - U6
Opće informacije	V85
Struktura kataloga	V86
Karakteristične veličine	V86
Prijevodni	V87 - V89
Aritmetička lista	938 - 984
Usporedni popis	985 - 1028
Novi unos	1029 - 1034
Izmijenjeni broj narudžbe	1034 - 1035
Precrtani brojevi	1036
Mjerna tablica za profil glavčine	1037
Mjerna tablica za zamašne ploče	1038 - 1039
Popisi dijelova za spojke s dvostrukim diskom	1040

Struktura kataloga

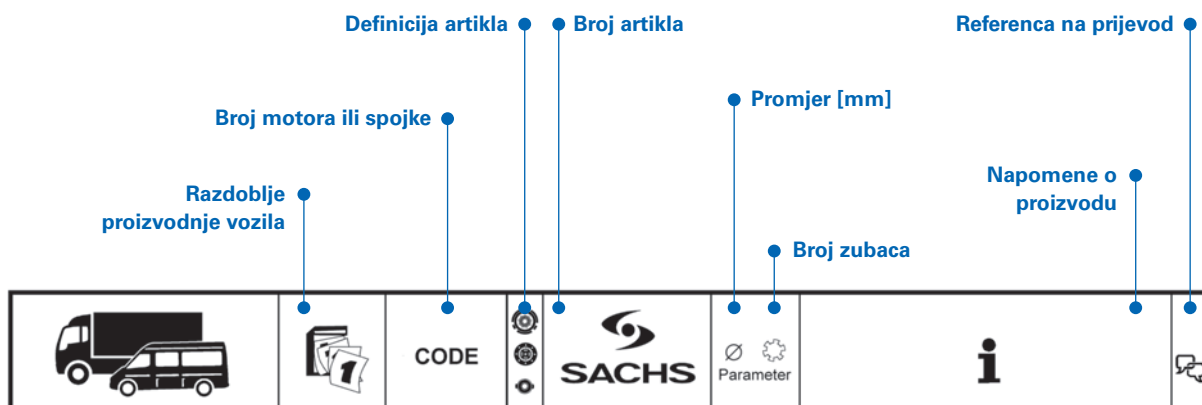

DAF

LF		05.13 -					
FA 180	05.13-	PX-5135	3400 700 465	362 10	Getr. / GBox: 6 S 700	(18)	
			3482 000 859	MF362	Getr. / GBox: 6 AS 700		
			1878 005 601	362WGTZ	Euro 6 / Euro 6		
			3151 000 651	KZIS-4			
			3400 700 464	362 10	Getr. / GBox: 6 S 800	(18)	
			3482 000 859	MF362	Getr. / GBox: 6 AS 800		
			1878 005 600	362WGTZ	Euro 6 / Euro 6		
			3151 000 651	KZIS-4			
			3400 700 603	350	Getr. / GBox: S5-42	(18)	
			3482 001 166	MF350	Euro 6 / Euro 6		
			1878 007 172	350WGTZ			
			3151 000 397	KZIS-4			
FA 210	05.13-	PX-5157	3400 700 465	362 10	Getr. / GBox: 6 S 700	(18)	
			3482 000 859	MF362	Getr. / GBox: 6 AS 700		
			1878 005 601	362WGTZ	Euro 6 / Euro 6		
			3151 000 651	KZIS-4			
			3400 700 464	362 10	Getr. / GBox: 6 S 800	(18)	
			3482 000 859	MF362	Getr. / GBox: 6 AS 800		
			1878 005 600	362WGTZ	Euro 6 / Euro 6		
			3151 000 651	KZIS-4			
			3400 700 603	350	Getr. / GBox: S5-42	(18)	
			3482 001 166	MF350	Euro 6 / Euro 6		
			1878 007 172	350WGTZ			
			3151 000 397	KZIS-4			

Karakteristične veličine

⊙ Kompresijske ploče spojke

2/	Za izvedbu s dva diska
400	Vanjski promjer tarne površine 400 mm
Do	Dvostruka spojka, ovisno isključivanje
Du	Dvostruka spojka, neovisno isključivanje
/E	XTend
F	Ravni zamašnjak
G	Spojka s lijevanim kućištem
K	Spojka sa zavojnim oprugama
KM	S membranskom oprugom i polužnim sustavom
M	Spojka s membranskom oprugom
N	Prigon
S	Izvedba sa zakretnim svornjakom
T	S tanjurastom oprugom
XTend	S automatskim podešavanjem
Z	Isključivanje na potez

⊙ Diskovi spojke

200	Vanjski promjer 200 mm
CE	Anorganska sinterirana obloga
B/D/E/Z	Elastičnost obloge
BH/GS/GT/GV	Torzijski prigušivač za gospodarska vozila
/E	XTend
W/V	Predublaživač za gospodarska vozila

⊙ Ležaj isključivača

...A	Istohodni vanjski prsten
G	Grafitni potporni prsten
GK	Grafitni potporni prsten i kuglični ležaj
GR	Kuglični ležaj s limenim poklopcem
GZ	Glavni cilindar
HHIS	Koncentrični prihvatni cilindar
...I	Prateći unutarnji prsten
KT	Teflonska potisna ploča
KZ	Kuglični ležaj, središnje vodeni
NZ	Radni cilindar
...S	Samocentrirajući unutarnji prsten
...Z	Isključivanje na potez

Prijevodi

- (1) Broj pričvrstnih bušotina na koncentričnom prihvatnom cilindru: 2
- (2) Broj pričvrstnih bušotina na koncentričnom prihvatnom cilindru: 3
- (3) Broj obloga
- (4) Vilica za isključivanje ovjesna [mm]
- (5) Vilica za isključivanje stojeća [mm]
- (6) Izmijenjivi dio zamijenjen s 3400 121 002
- (7) Vanjski promjer [mm]
- (8) Kod problema s bukom
- (9) Sadrži isključivač i komplet za montažu
- (10) Sadrži dvomaseni zamašnjak, potisnu ploču, disk spojke i isključivač
- (11) Sadrži dvomaseni zamašnjak, potisnu ploču, disk spojke i CSC
- (12) Širina [mm]
- (13) Dizel
- (14) Promjer priključka tlačnog voda [mm]
- (15) Euro 3
- (16) Euro 4 (D4)
- (17) Euro 5
- (18) Euro 6
- (19) Euro 3 / Euro 4
- (20) Euro 4 / Euro 5
- (21) Euro 5 / Euro 6
- (22) Vozilo može biti opremljeno spojkom različitih veličina
- (23) Vozila mogu biti opremljena s različitim komponentama
- (24) Pogon punjača
- (25) Medij za punjenje: tekućina za kočnice
- (26) Medij za punjenje: mineralno ulje
- (27) Za izvoz
- (28) Broj mjenjača
- (29) Duljina ovitka [mm]
- (30) Uvijek izmjenjivati
- (31) Sadržano u 1888
- (32) Sadržano u 3483/3488
- (33) Sadržano u 3488
- (34) Unutarnji promjer [mm]
- (35) Po želji kupca s različitom spojkom
- (36) Duljina kabela [mm]
- (37) Karakteristična veličina
- (38) Kuglični ležaj
- (39) Disk spojke s prigušivačem vibracija
- (40) Snaga [kW]
- (41) Labavi disk spojke
- (42) Verzija za određenu zemlju: Velika Britanija
- (43) Verzija za određenu zemlju: Turska
- (44) Duljina klipnjače [mm]
- (45) Duljina [mm]
- (46) Vrsta montaže: nije prethodno montirano
- (47) Komplet za montažu ležaja odvajanja
- (48) Profil glavčine
- (49) Ležaj glavčine

Prijevodi

(50) ID-sporednog pogona

(51) Može se isporučiti samo uz povrat starih dijelova (reparatura; pogon Bielefeld)

(52) Ugraditi samo, ako je vozilo opremljeno s M-spojkom

(53) Ugraditi samo skupa

(54) Serijski broj

(55) Od serijskog broja

(56) Do serijskog broja

(57) Međuosovinski razmak [mm]

(58) Model valjaka

(59) Slijedni ručni mjenjač

(60) Specijalna izvedba

(61) Disk spojke s torzijskim oprugama

(62) ZF-pogon

(63) Alternativna garnitura za popravke

(65) Sadrži pričvrzne vijke za kompresijsku ploču

(66) Sadrži pričvrzne vijke za zamašnjak

(67) Sadrži jedan disk spojke

(68) Sadrži dva diska spojke

(69) Za

(70) Za vilicu za isključivanje s brijegom

(71) Za vilicu za isključivanje s valjcima

(72) Za vozila sa spojkom s jednim diskom

(73) Za vozila s pojačalom snage spojke

(74) Za vozila s niskotlačnim kočionim uređajem

(75) Za vozila s retarderom

(76) Za vozila s ključnom spojkom pretvarača

(77) Za vozila s spojkom s dva diska

(78) Za unutarnji promjer tanjuraste opruge 100 mm

(79) Za unutarnji promjer tanjuraste opruge 120 mm

(80) Za motore s dvomasenim zamašnjakom

(81) Za motore bez dvomasenog zamašnjaka

(82) Za sporedni pogon

(83) Za OE-broj

(84) Za dubinu zamašnjaka [mm]

(85) Ovisno o izvedbi s različitom spojkom

(86) Dugi stremen

(87) Maksimalna prenosivi moment motora [Nm]

(88) S zaletnim prstenom

(89) S trajnim podmazivanjem

(90) S usporivačem VR 115E

(91) S cijevnim priključkom za podmazivanje

(92) S osjetnikom

(93) S priborom

(94) S međuprstenom

(95) S automatskim podešavanjem

(96) Ne za

(97) Nije za broj voznog postroja

(98) Nije za kòd motora

(99) Ne u spoju sa zamjenskim diskom spojke

Prijevod

(100) Samo kao zamjena za navedeni OE br.

(101) Samo u kombinaciji s

(102) Bez zaletnog prstena

(103) Bez cijevnog priključka za podmazivanje

(104) Bez pričvrstnih vijaka zamašnjaka

(105) Bez osjetnika

(106) Bez međuprstena

DE

EN

FR

ES

PT

IT

NL

NO

SV

FI

PL

RU

HU

CS

RO

HR

EL

TR

ZH

DE

EN

FR

ES

PT

IT

NL

NO

SV

FI

PL

RU

HU

CS

RO

HR

EL

TR

ZH

Memo

Γενικές πληροφορίες



Όλα τα εξαρτήματα αυτού του καταλόγου επιτρέπεται να τοποθετούνται μόνο από το εκπαιδευμένο προσωπικό ενός συνεργείου αυτοκινήτου.

Για τις απαιτήσεις σας χρειαζόμαστε τον πλήρη αριθμό παραγγελίας, για παράδειγμα:

Σετ συμπλέκτη	3400 122 201
Πλατό συμπλέκτη	3482 083 032
Δίσκος συμπλέκτη	1878 004 832
Έδρανο αποσύμπλεξης	3151 000 034

Εάν έχετε αμφιβολίες, δώστε την ονομασία τύπου και το έτος κατασκευής του οχήματος για το οποίο προορίζεται το επιθυμητό εξάρτημα.

Σ' αυτό τον κατάλογο παρουσιάζεται μόνο μια επιλογή από την γκάμα των προϊόντων μας. Για τον πλήρη κατάλογο, συμβουλευθείτε τα ηλεκτρονικά μας μέσα.

Με την επιφύλαξη παντός δικαιώματος. Δεν επιτρέπεται η αναπαραγωγή ή η χρήση του παρόντος καταλόγου εν όλω ή εν μέρει για τη δημιουργία προσωπικού καταλόγου, χωρίς ρητή άδεια.

Οι κωδικοί εξαρτημάτων των κατασκευαστών οχημάτων παρέχονται μόνο για σκοπούς σύγκρισης. Δεν επιτρέπεται η αναφορά τέτοιου είδους στοιχείων σε παραστατικά αγοράς που απευθύνονται στον κάτοχο του οχήματος.

Οι ισχύοντες γενικοί όροι λειτουργίας υπάρχουν στη διεύθυνση www.zf.com/aftermarket/documents

www.zf.com/aftermarket/catalog

WebCat

Κατάλογος online

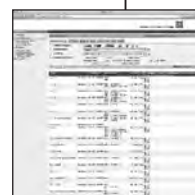

InCat

Ηλεκτρονικός κατάλογος



PrintCat

Τυπωμένοι κατάλογοι



Περιεχόμενα

Index	U2
Σύμβολα	U5 - U6
Γενικές πληροφορίες	V91
Δομή καταλόγου	V92
Κύρια μεγέθη	V92
Μεταφράσεις	V93 - V95
Αριθμητικός κατάλογος	938 - 984
Συγκριτικός κατάλογος	985 - 1028
Νέες καταχωρίσεις	1029 - 1034
Αλλαγμένος αριθμός παραγγελίας	1034 - 1035
Διεγραμμένοι αριθμοί	1036
Πίνακας διαστάσεων για προφίλ πλήμνης	1037
Πίνακας διαστάσεων για δίσκους σφονδύλου	1038 - 1039
Λίστες εξαρτημάτων για συμπλέκτες διπλού δίσκου	1040

Δομή καταλόγου

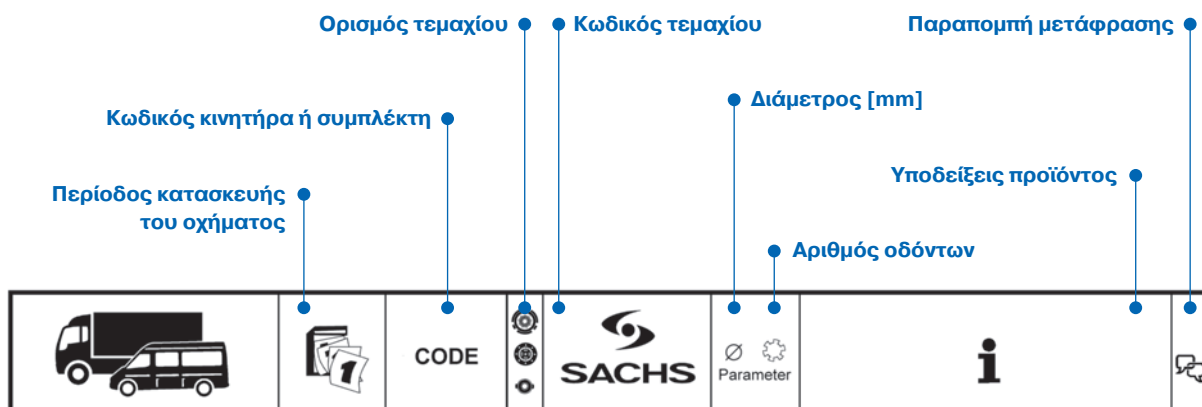

DAF

LF		05.13 -					
FA 180	05.13-	PX-5135		3400 700 465 ⊗ 3482 000 859 ⊗ 1878 005 601 ⊕ 3151 000 651	362 10 MF362 362WGTZ KZIS-4	Getr. / GBox: 6 S 700 Getr. / GBox: 6 AS 700 Euro 6 / Euro 6	(18)
				3400 700 464 ⊗ 3482 000 859 ⊗ 1878 005 600 ⊕ 3151 000 651	362 10 MF362 362WGTZ KZIS-4	Getr. / GBox: 6 S 800 Getr. / GBox: 6 AS 800 Euro 6 / Euro 6	(18)
				3400 700 603 ⊗ 3482 001 166 ⊗ 1878 007 172 ⊕ 3151 000 397	350 MF350 350WGTZ KZIS-4	Getr. / GBox: S5-42 Euro 6 / Euro 6	(18)
FA 210	05.13-	PX-5157		3400 700 465 ⊗ 3482 000 859 ⊗ 1878 005 601 ⊕ 3151 000 651	362 10 MF362 362WGTZ KZIS-4	Getr. / GBox: 6 S 700 Getr. / GBox: 6 AS 700 Euro 6 / Euro 6	(18)
				3400 700 464 ⊗ 3482 000 859 ⊗ 1878 005 600 ⊕ 3151 000 651	362 10 MF362 362WGTZ KZIS-4	Getr. / GBox: 6 S 800 Getr. / GBox: 6 AS 800 Euro 6 / Euro 6	(18)
				3400 700 603 ⊗ 3482 001 166 ⊗ 1878 007 172 ⊕ 3151 000 397	350 MF350 350WGTZ KZIS-4	Getr. / GBox: S5-42 Euro 6 / Euro 6	(18)

Κύρια μεγέθη

Πλατό συμπλέκτη

Z/	Για έκδοση διπλού δίσκου
400	Εξωτερική διάμετρος επιφάνειας τριβής 400 mm
Do	Διπλός συμπλέκτης, εξαρτώμενη αποσύμπλεξη
Du	Διπλός συμπλέκτης, ανεξάρτητη αποσύμπλεξη
/E	XTend
F	Λεπτός σφόνδυλος
G	Συμπλέκτης με χυτό κέλυφος
K	Συμπλέκτης ελικοειδών ελατηρίων
KM	Με ελατήριο μεμβράνης και μοχλικό σύστημα
M	Συμπλέκτης ελατηρίων μεμβράνης
N	Δυναμοδότης
S	Τύπος με πείρο στρέψης
T	Με δισκοειδές ελατήριο
XTend	Με αυτόματη ρύθμιση
Z	Αποσύμπλεξη με έλξη

Δίσκος συμπλέκτη

200	Εξωτερική διάμετρος 200 mm
CE	Ανόργανη επένδυση επίτηξης
B/D/E/Z	Ελατήρια επενδύσεων
BH/GS/GT/GV	Αποσβεστήρας στρέψης για φορτηγά
/E	XTend
W/V	Αποσβεστήρας για φορτηγά

Ρουλεμάν αποσύμπλεξης

...A	Παρασυρόμενος εξωτερικός δακτύλιος
G	Δακτύλιος εκκίνησης από γραφίτη
GK	Δακτύλιος εκκίνησης από γραφίτη με ρουλεμάν
GR	Ρουλεμάν με μεταλλικό πώμα
GZ	Εντολοδόχος κύλινδρος
HHIS	Ομόκεντρος εντολοδόχος κύλινδρος
...I	Παρασυρόμενος εσωτερικός δακτύλιος
KT	Ροδέλα τεφλόν
KZ	Ρουλεμάν, κεντρικής οδήγησης
NZ	Εντολοδόχος κύλινδρος
...S	Αυτοκεντραριζόμενος εσωτερικός δακτύλιος
...Z	Αποσύμπλεξη με έλξη

Μεταφράσεις

- (1) Αριθμός διατρήσεων στερέωσης στο CSC: 2
- (2) Αριθμός διατρήσεων στερέωσης στο CSC: 3
- (3) Αριθμός των επενδύσεων
- (4) Δίχαλο αποσύμπλεξης αναρτημένο [mm]
- (5) Δίχαλο αποσύμπλεξης όρθιο [mm]
- (6) Ανταλλακτικό εξάρτημα, αντικατεστημένο από το 3400 121 002
- (7) Εξωτερική διάμετρος [mm]
- (8) Σε περίπτωση προβλημάτων από θορύβους
- (9) Περιέχει έδρανο αποσύμπλεξης και κιτ τοποθέτησης
- (10) Περιέχει σφόνδυλο διπλής μάζας (ZMS), πλατό συμπλέκτη, δίσκο συμπλέκτη και έδρανο αποσύμπλεξης
- (11) Περιέχει σφόνδυλο διπλής μάζας (ZMS), πλατό συμπλέκτη, δίσκο συμπλέκτη και CSC
- (12) Πλάτος [mm]
- (13) Ντίτζελ
- (14) Διάμετρος σύνδεσης αγωγού πίεσης [mm]
- (15) Euro 3
- (16) Euro 4 (D4)
- (17) Euro 5
- (18) Euro 6
- (19) Euro 3 / Euro 4
- (20) Euro 4 / Euro 5
- (21) Euro 5 / Euro 6
- (22) Το όχημα ενδέχεται να είναι εξοπλισμένο με διαφορετικές διαστάσεις συμπλέκτη
- (23) Τα οχήματα ενδέχεται να είναι εξοπλισμένα με διαφορετικά εξαρτήματα
- (24) Κιβώτιο ταχυτήτων Fuller
- (25) Μέσο πλήρωσης: Υγρό φρένων
- (26) Μέσο πλήρωσης: Ορυκτέλαιο
- (27) Για εξαγωγή
- (28) Κωδικός κιβωτίου ταχυτήτων
- (29) Μήκος περιβλήματος [mm]
- (30) Πάντοτε ανανέωση
- (31) Στο 1888 περιλαμβάνεται
- (32) Στο 3483/3488 περιλαμβάνεται
- (33) Στο 3488 περιλαμβάνεται
- (34) Εσωτερική διάμετρος [mm]
- (35) Ανάλογα με την επιθυμία του πελάτη με διαφορετικό συμπλέκτη
- (36) Μήκος καλωδίου [mm]
- (37) Κύριο μέγεθος
- (38) Ρουλεμάν
- (39) Δίσκος συμπλέκτη με προαποσβεστήρα
- (40) Ίσχύς [kW]
- (41) Λασκαρισμένος δίσκος συμπλέκτη
- (42) Έκδοση χώρας: Μεγάλη Βρετανία
- (43) Έκδοση χώρας: Τουρκία
- (44) Μήκος στελέχους εμβόλου [mm]
- (45) Μήκος [mm]
- (46) Τρόπος συναρμολόγησης: Μη προεγκατεστημένο
- (47) Σετ συναρμολόγησης με ρουλεμάν αποσύμπλεξης
- (48) Προφίλ πλήμνης

Μεταφράσεις

- (49) Βελονοφόρο έδρανο
- (50) ID δυναμοδότη (PTO)
- (51) Προσφέρεται μόνο σε επιστροφή παλαιού εξαρτήματος (επισκευή, εργοστάσιο Bielefeld)
- (52) Τοποθέτηση μόνο όταν το όχημα είναι εξοπλισμένο με συμπλέκτη M
- (53) Τοποθέτηση μόνο μαζί
- (54) Κωδικός παραγωγής
- (55) Από αριθμό παραγωγής
- (56) Έως αριθμό παραγωγής
- (57) Μεταξόνιο [mm]
- (58) Έκδοση με ράουλα
- (59) Σειριακό μηχανικό κιβώτιο
- (60) Ειδική έκδοση
- (61) Δίσκος με ελατήρια στρέψης
- (62) Κιβώτιο ταχυτήτων ZF
- (63) Εναλλακτικό σετ επισκευής
- (65) Περιλαμβάνει βίδες στερέωσης του πλατό
- (66) Περιλαμβάνει βίδες στερέωσης σφονδύλου
- (67) Περιλαμβάνει ένα δίσκο συμπλέκτη
- (68) Περιλαμβάνει δύο δίσκους συμπλέκτη
- (69) Για
- (70) Για δίχαλο αποσύμπλεξης με έκκεντρο
- (71) Για δίχαλο αποσύμπλεξης με ράουλα
- (72) Για οχήματα με μονόδισκο συμπλέκτη
- (73) Για οχήματα με ενισχυτή δύναμης συμπλέκτη
- (74) Για οχήματα με σύστημα πέδησης χαμηλής πίεσης
- (75) Για οχήματα με επιβραδυντή
- (76) Για οχήματα με μονάδα μετατροπέα-συμπλέκτη
- (77) Για οχήματα με συμπλέκτη διπλού δίσκου
- (78) Για εσωτερική διάμετρο ελατηριωτού διαφράγματος 100 mm
- (79) Για εσωτερική διάμετρο ελατηριωτού διαφράγματος 120 mm
- (80) Για κινητήρες με σφόνδυλο διπλής μάζας
- (81) Για κινητήρες χωρίς σφόνδυλο διπλής μάζας
- (82) Για δυναμοδότη
- (83) Για αριθμό ΟΕ
- (84) Για βάθος σφονδύλου [mm]
- (85) Ανάλογα με την έκδοση με διαφορετικό συμπλέκτη
- (86) Μακρύ δίχαλο
- (87) Μέγιστη ωφέλιμη ροπή κινητήρα [Nm]
- (88) Με δακτύλιο εκκίνησης
- (89) Με λίπανση διαρκείας
- (90) Με επιβραδυντή VR 115E
- (91) Με λιπαινόμενο σύνδεσμο σωλήνα
- (92) Με αισθητήρα
- (93) Με αξεσουάρ
- (94) Με ενδιάμεσο δακτύλιο
- (95) Με αυτόματη ρύθμιση
- (96) Όχι για
- (97) Όχι για αριθμό πλαισίου
- (98) Όχι για αριθμό κινητήρα

Μεταφράσεις

(99) Όχι σε συνδυασμό με ανταλλακτικό δίσκο συμπλέκτη

(100) Μόνο ως αντικατάσταση για τους αναφερόμενους αρ. ΟΕ (γνήσια ανταλλακτικά)

(101) Μόνο σε συνδυασμό με

(102) Χωρίς δακτύλιο εκκίνησης

(103) Χωρίς λιπαινόμενο σύνδεσμο σωλήνα

(104) Χωρίς βίδες στερέωσης σφονδύλου

(105) Χωρίς αισθητήρα

(106) Χωρίς ενδιάμεσο δακτύλιο

DE

EN

FR

ES

PT

IT

NL

NO

SV

FI

PL

RU

HU

CS

RO

HR

EL

TR

ZH

Memo

Genel bilgiler



Bu katalogta belirtilen tüm ürünler sadece atölyede ve eğitilmiş personel tarafından monte edilmelidir.

Talepleriniz için tam sipariş numarası gereklidir, örneğin:

Debriyaj kiti	3400 122 201
Debriyaj baskı plakası	3482 083 032
Debriyaj diskisi	1878 004 832
Debriyaj rulmanı	3151 000 034

Kararsızlık durumunda istenilen ürün için tespit edilmiş olan tip tanımını ve aracın model yılını belirtin.

Bu katalog ürün programımızdan sadece bir alıntıdır; tam ürün programını elektronik ortamlarımızda bulabilirsiniz.

Tüm hakları saklıdır. Açık bir onay alınmadığı sürece bu kataloğun çoğaltılmasına veya başka bir katalog oluşturmak için kısmen de olsa kullanılmasına izin verilmez.

Araç üreticilerinin yedek parça numaraları sadece karşılaştırma amaçlıdır. Bu tür bilgilerin araç sahibi için oluşturulan faturalarda kullanılmasına izin verilmez.

Güncel genel iş şartlarını
www.zf.com/aftermarket/documents
adresini altında bulabilirsiniz.

www.zf.com/aftermarket/catalog

WebCat
Online katalog

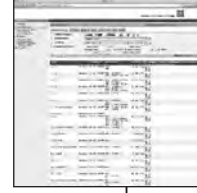

InCat
Elektronik katalog



PrintCat
Basılı kataloglar



İçindekiler

Index	U2
Semboller	U5 - U6
Genel bilgiler	V97
Kataloğun yapısı	V98
Karakteristik değerler	V98
Çeviriler	V99 - V101
Aritmetik liste	938 - 984
Karşılaştırma listesi	985 - 1028
Yeni kayıtlar	1029 - 1034
Değiştirilen sipariş numarası	1034 - 1035
İptal edilen numaralar	1036
Göbek profilleri için ölçüm tablosu	1037
Volan diskleri için ölçüm tablosu	1038 - 1039
İki diskli debriyajlar için parça listesi	1040

Katalogun yapısı

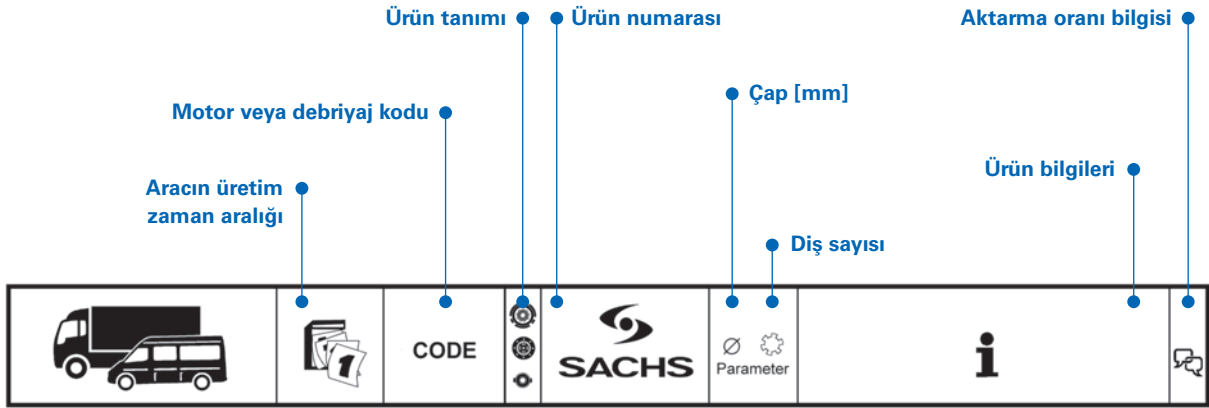

DAF

LF	05.13 -						
FA 180	05.13-	PX-5135	3400 700 465	362 10	Getr. / GBox: 6 S 700	(18)	
			3482 000 859	MF362	Getr. / GBox: 6 AS 700		
			1878 005 601	362WGTZ	Euro 6 / Euro 6		
			3151 000 651	KZIS-4			
			3400 700 464	362 10	Getr. / GBox: 6 S 800	(18)	
			3482 000 859	MF362	Getr. / GBox: 6 AS 800		
			1878 005 600	362WGTZ	Euro 6 / Euro 6		
			3151 000 651	KZIS-4			
			3400 700 603	350	Getr. / GBox: S5-42	(18)	
			3482 001 166	MF350	Euro 6 / Euro 6		
			1878 007 172	350WGTZ			
			3151 000 397	KZIS-4			
FA 210	05.13-	PX-5157	3400 700 465	362 10	Getr. / GBox: 6 S 700	(18)	
			3482 000 859	MF362	Getr. / GBox: 6 AS 700		
			1878 005 601	362WGTZ	Euro 6 / Euro 6		
			3151 000 651	KZIS-4			
			3400 700 464	362 10	Getr. / GBox: 6 S 800	(18)	
			3482 000 859	MF362	Getr. / GBox: 6 AS 800		
			1878 005 600	362WGTZ	Euro 6 / Euro 6		
			3151 000 651	KZIS-4			
			3400 700 603	350	Getr. / GBox: S5-42	(18)	
			3482 001 166	MF350	Euro 6 / Euro 6		
			1878 007 172	350WGTZ			
			3151 000 397	KZIS-4			

Karakteristik değerler

Debriyaj baskı plakaları	
Z/	İki diskli model
400	Sürtünme yüzeyi dış çapı 400 mm
Do	Çift debriyaj, bağımlı ayırmalı
Du	Çift debriyaj, bağımsız ayırmalı
/E	XTend
F	Düz volan
G	Döküm mahfazalı debriyaj
K	Helezoni yaylı debriyaj
KM	Membran yay ve kol sistemli
M	Membran yaylı debriyaj
N	Yardımcı tahrik
S	Döner saplamalı tip
T	Yaylı plakalı
XTend	Otomatik ayarlama ile
Z	Telle ayırmalı

Debriyaj diskleri	
200	Dış çap 200 mm
CE	Anorganik sinter kaplama
B/D/E/Z	Balata yayları
BH/GS/GT/GV	Ticari araçlar için torsiyon sönümleyici
/E	XTend
W/V	Ticari araçlar için ön sönümleyici

Ayırma rulmanı	
...A	Birlikte dönen dış halka
G	Grafit baskı halkası
GK	Grafit baskı halkası ve rulman
GR	Sac kapaklı rulman
GZ	Debriyaj merkezi
HHIS	Konsantrik alt debriyaj merkezi
...I	Birlikte dönen iç halka
KT	Teflon yol verme diski
KZ	Rulman, merkezi kılavuzlu
NZ	Alt debriyaj merkezi
...S	Kendinden merkezlemeli iç halka
...Z	Telle ayırmalı

Çeviriler

(1)	CSC'deki tespit deliği sayısı: 2
(2)	CSC'deki tespit deliği sayısı: 3
(3)	Balata adeti
(4)	Asılı debriyaj rulmanı çatalı [mm]
(5)	Sabit debriyaj rulmanı çatalı [mm]
(6)	Değiştirme parça, 3400 121 002 ile değiştirildi
(7)	Dış çap [mm]
(8)	Ses problemlerinde
(9)	Debriyaj rulmanı ve montaj setini içerir
(10)	ZMS, debriyaj baskı plakası, debriyaj diski ve debriyaj rulmanı içerir
(11)	ZMS, debriyaj baskı plakası, debriyaj diski ve CSC içerir
(12)	Genişlik [mm]
(13)	Dizel
(14)	Basınç hattı bağlantısının çapı [mm]
(15)	Euro 3
(16)	Euro 4 (D4)
(17)	Euro 5
(18)	Euro 6
(19)	Euro 3 / Euro 4
(20)	Euro 4 / Euro 5
(21)	Euro 5 / Euro 6
(22)	Araç farklı debriyaj boyutlarıyla donatılmış olabilir
(23)	Araçlar farklı komponentlerle donatılmış olabilir
(24)	Fuller şanzıman
(25)	Dolum sıvısı: fren hidroliği
(26)	Dolum sıvısı: madeni yağ
(27)	İhracat için
(28)	Şanzıman numarası
(29)	Zıvana uzunluğu [mm]
(30)	Her zaman yenileyin
(31)	1888 içeriğine dahil
(32)	3483/3488 içeriğine dahil
(33)	3488 içeriğine dahil
(34)	İç çap [mm]
(35)	Müşteri talebine göre farklı debriyaj ile
(36)	Kablo uzunluğu [mm]
(37)	Karakteristik değer
(38)	Rulman
(39)	Ön tamponlu debriyaj diski
(40)	Güç [kW]
(41)	Gevşek debriyaj diski
(42)	Ülkere özgü tasarım: İngiltere
(43)	Ülkere özgü tasarım: Türkiye
(44)	Piston kolu uzunluğu [mm]
(45)	Uzunluk [mm]
(46)	Montaj türü: önceden monte edilmemiş
(47)	Ayırma rulmanı için montaj seti
(48)	Göbek profili
(49)	İğneli yatak

DE

EN

FR

ES

PT

IT

NL

NO

SV

FI

PL

RU

HU

CS

RO

HR

EL

TR

Çeviriler

- (50) PTO ID'si
- (51) Yalnızca eski parça iadesinde teslim edilebilir (tamir; Bielefeld fabrikası)
- (52) Sadece, araç M debriyaj ile donatılmış ise monte edilmelidir
- (53) Sadece birlikte monte edin
- (54) Üretim numarası
- (55) Minimum üretim numarası
- (56) Üretim numarasına kadar
- (57) Dingil mesafesi [mm]
- (58) Makaralı varyant
- (59) Manuel şanzıman, ardışık
- (60) Özel tasarım
- (61) Burulma kirişli debriyaj diskisi
- (62) ZF şanzıman
- (63) Alternatif onarım seti
- (65) Baskı plakası tespit vidalarını içerir
- (66) Volan dişlisi tespit vidalarını içerir
- (67) Bir debriyaj diskisi içerir
- (68) İki debriyaj diskisi içerir
- (69) İçin
- (70) Kamlı ayırma çatalı için
- (71) Makaralı ayırma çatalı için
- (72) Tek diskli taşıtlar için
- (73) Servo debriyajlı taşıtlar için
- (74) Vakumlu fren tertibatlı taşıtlar için
- (75) Retarderli taşıtlar için
- (76) Konvertör ve debriyaj üniteli taşıtlar için
- (77) İki diskli debriyajlı taşıtlar için
- (78) Membran yayı iç çapı 100 mm için
- (79) Membran yayı iç çapı 120 mm için
- (80) Çift kütleli volanı olan motorlar için
- (81) Çift kütleli volanı olmayan motorlar için
- (82) Yardımcı tahrik sistemi için
- (83) OE numarası için
- (84) Volan derinliği için [mm]
- (85) Tipine göre farklı debriyaj ile
- (86) Uzun kol
- (87) Aktarılabilen maksimum motor torku [Nm]
- (88) Baskı halkası ile
- (89) Sürekli yağlamalı
- (90) Retarder VR 115E ile
- (91) Yağlama borusu bağlantısı ile
- (92) Sensör ile
- (93) Aksesuar ile
- (94) Ara halkası ile
- (95) Otomatik ayarlama ile
- (96) Uygun değildir
- (97) Şasi numarası için değildir
- (98) Motor numarası için uygun değil
- (99) Yedek parça debriyaj diskisi ile değil

ZH

Çeviriler

(100) Sadece belirtilen OE num. için

(101) Sadece birlikte kullanılabilir

(102) Baskı halkası yok

(103) Yağlama borusu bağlantısı yok

(104) Volan dişlisi tespit vidaları hariç

(105) Sensör yok

(106) Ara halkası yok

DE

EN

FR

ES

PT

IT

NL

NO

SV

FI

PL

RU

HU

CS

RO

HR

EL

TR

ZH

DE

EN

FR

ES

PT

IT

NL

NO

SV

FI

PL

RU

HU

CS

RO

HR

EL

TR

ZH

Memo

概况



本目录中列出的所有产品只允许由汽车专业维修厂的专业人员进行安装。

为满足您的需求，请提供完整的订单信息，例如：

离合器套件	3400 122 201
离合器压盘	3482 083 032
离合器从动盘	1878 004 832
分离轴承	3151 000 034

如有疑问，请给出车辆型号和制造年份，
以此可以确定您想要的零件。

该产品目录册为我们产品系列的摘录，
您可在我们的电子媒体上找到完整总览。

保留所有权利。未获得明确许可的情况下，
不得复印或者分享此目录创建自有目录（包括节选）。

车辆制造商的备件编号仅用于比较目的。
不允许使用车辆所有者发票中的此类信息。

目前的一般商业条款请参见
www.zf.com/aftermarket/documents

www.zf.com/aftermarket/catalog

WebCat

在线目录

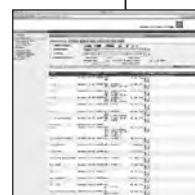

InCat

电子目录



PrintCat

印刷式目录



索引

Index	U2
符号	U5 - U6
概况	V103
目录结构	V104
特征值	V104
译文	V105 - V107
零件号列表	938 - 984
号码对应关系表	985 - 1028
产品增补表	1029 - 1034
修订版零件号	1034 - 1035
停产部件表	1036
轮毂断面的尺寸表	1037
飞轮的尺寸表	1038 - 1039
双片式离合器零件明细表	1040

目录结构

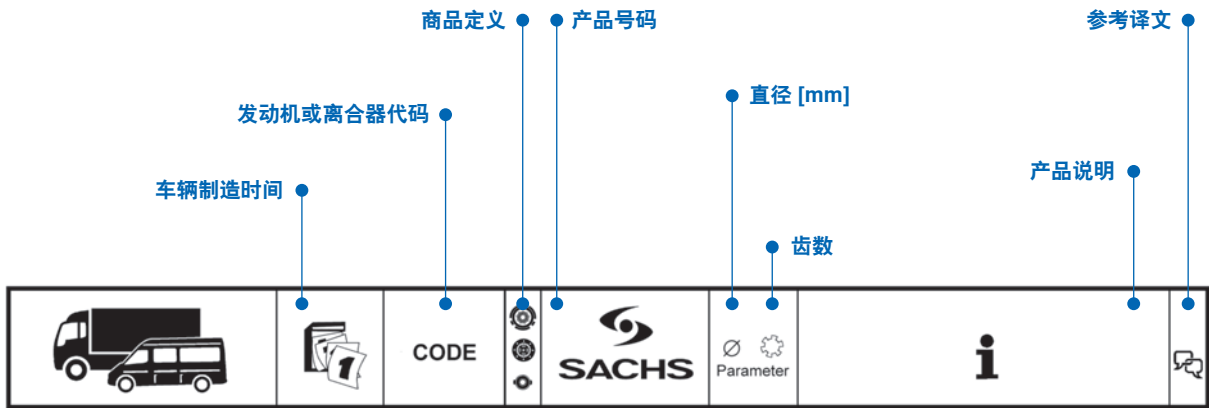

DAF

LF		05.13 -					
FA 180	05.13 -	PX-5135		3400 700 465	362 10	Getr. / GBox: 6 S 700	(18)
				3482 000 859	MF362	Getr. / GBox: 6 AS 700	
				1878 005 601	362WGTZ	Euro 6 / Euro 6	
				3151 000 651	KZIS-4		
				3400 700 464	362 10	Getr. / GBox: 6 S 800	(18)
				3482 000 859	MF362	Getr. / GBox: 6 AS 800	
				1878 005 600	362WGTZ	Euro 6 / Euro 6	
				3151 000 651	KZIS-4		
				3400 700 603	350	Getr. / GBox: S5-42	(18)
				3482 001 166	MF350	Euro 6 / Euro 6	
				1878 007 172	350WGTZ		
				3151 000 397	KZIS-4		
FA 210	05.13 -	PX-5157		3400 700 465	362 10	Getr. / GBox: 6 S 700	(18)
				3482 000 859	MF362	Getr. / GBox: 6 AS 700	
				1878 005 601	362WGTZ	Euro 6 / Euro 6	
				3151 000 651	KZIS-4		
				3400 700 464	362 10	Getr. / GBox: 6 S 800	(18)
				3482 000 859	MF362	Getr. / GBox: 6 AS 800	
				1878 005 600	362WGTZ	Euro 6 / Euro 6	
				3151 000 651	KZIS-4		
				3400 700 603	350	Getr. / GBox: S5-42	(18)
				3482 001 166	MF350	Euro 6 / Euro 6	
				1878 007 172	350WGTZ		
				3151 000 397	KZIS-4		

特征值

离合器压盘

Z/	用于双皮带轮的型号
400	摩擦面外直径 400 mm
Do	复式离合器, 依赖性断联
Du	复式离合器, 独立性断联
/E	XTend
F	平面飞轮
G	带铸铁外壳的离合器
K	螺旋弹簧离合器
KM	带膜片弹簧和杠杆系统
M	膜片弹簧离合器
N	取力器
S	吊环螺栓配置
T	带碟形弹簧
XTend	带自动调整
Z	拉式

离合器从动盘

200	外径 200 mm
CE	无机烧结敷层
B/D/E/Z	面片弹性
BH/GS/GT/GV	用于商用车的扭转减振器
/E	XTend
W/V	用于载货汽车的预减震器

分离轴承

...A	旋转外环
G	石墨止推环
GK	石墨起动环和球轴承
GR	球轴承带板盖
GZ	主泵
HHIS	同心分泵
...I	旋转内环
KT	四氟乙烯起动盘
KZ	球轴承, 中央配置
NZ	分泵
...S	自行居中内环
...Z	拉式

译文

- (1) CSC 上的固定孔数量：2
- (2) CSC 上的固定孔数量：3
- (3) 制动片个数
- (4) 悬置的分离拨叉 [毫米]
- (5) 竖立的分离拨叉 [毫米]
- (6) 使用 3400 121 002 替代更换零件
- (7) 外径 [mm]
- (8) 当出现噪声问题时
- (9) 包含分离轴承和安装套件
- (10) 包含双质量飞轮、离合器压盘、从动盘和分离轴承
- (11) 包含双质量飞轮、离合器压盘、从动盘和 CSC
- (12) 宽度 [mm]
- (13) 柴油
- (14) 压力管接头直径[毫米]
- (15) 欧 3
- (16) 欧 4 (D4)
- (17) 欧 5
- (18) 欧 6
- (19) 欧3 / 欧4
- (20) 欧4 / 欧5
- (21) 欧5 / 欧6
- (22) 车辆可配备不同尺寸的离合器
- (23) 车辆可配备不同的零部件
- (24) Fuller 变速箱
- (25) 填充介质：制动液
- (26) 填充介质：矿物油
- (27) 用于出口
- (28) 变速箱号码
- (29) 套筒长度[毫米]
- (30) 始终更换
- (31) 包含在1888 之内
- (32) 包含在3483/3488 之内
- (33) 包含在3488... .. 之内
- (34) 内径 [mm]
- (35) 根据客户需求，选用不同的离合器
- (36) 电缆长度 [mm]
- (37) 参数
- (38) 球轴承
- (39) 带预减震器的离合器从动盘
- (40) 功率[千瓦]
- (41) 可滑动的离合器从动盘
- (42) 国家规格：英国
- (43) 国家规格：土耳其
- (44) 活塞杆长度 [mm]
- (45) 长度[mm]
- (46) 安装类型：未预安装
- (47) 用于分离轴承的安装套件
- (48) 轴毂花键
- (49) 滚针轴承

译文

- (50) 分动箱代码
- (51) 只有在旧部件返还情况下才能供货 (修理; Bielefeld工厂)
- (52) 仅安装于配备M型离合器的车辆
- (53) 仅可共同安装
- (54) 生产号码
- (55) 从产品号码
- (56) 至生产号码
- (57) 轴距[毫米]
- (58) 轮辋结构
- (59) 顺序式手动变速箱
- (60) 特殊配置
- (61) 带扭转减振器的离合器从动盘
- (62) ZF变速箱
- (63) 可选维修包
- (65) 包含压盘固定螺钉
- (66) 包含飞轮固定螺钉
- (67) 包括 1 个离合器从动盘
- (68) 包括 2 个离合器从动盘
- (69) 用于
- (70) 用于带凸轮的分离拨叉
- (71) 对带滚轮的分离拨叉
- (72) 用于配备单盘式离合器的车辆
- (73) 用于配备离合器增压装置的车辆
- (74) 用于配备低压制动装置的车辆
- (75) 用于配备减速器的车辆
- (76) 用于配备变矩离合器的车辆
- (77) 用于配备双片式离合器的车辆
- (78) 用于膜片弹簧内径为 100 mm 的型号
- (79) 用于膜片弹簧内径为 120 mm 的型号
- (80) 用于配备双质量飞轮的发动机
- (81) 用于无双质量飞轮的发动机
- (82) 用于分动箱
- (83) 用于原厂号码
- (84) 用于飞轮厚度[毫米]
- (85) 根据具体配置, 选用不同的离合器
- (86) 长手柄
- (87) 最大可传输发动机扭矩 [Nm]
- (88) 带启动环
- (89) 永久润滑
- (90) 配备VR 115E减速器
- (91) 带润滑管连接
- (92) 带传感器
- (93) 带附件
- (94) 带间隔环
- (95) 带自动调整
- (96) 不适用于
- (97) 不适用于底盘号码
- (98) 不适用于发动机号码
- (99) 不能与更换离合器从动盘结合

译文

(100) 仅可替代列明原厂号的部件

(101) 仅连接与

(102) 无启动环

(103) 无润滑管连接

(104) 无飞轮固定螺钉

(105) 无传感器

(106) 无间隔环

DE

EN

FR

ES

PT

IT

NL

NO

SV

FI

PL

RU

HU

CS

RO

HR

EL





































TR

ZH

Memo





























ASTRA









BE-Serie							
BE 8440 F		Fiat8210		1878 001 136	420 10		
					420GTZ		
Betonmischer / Concrete Mixer 304 F/FP/M/MP				3151 000 515	KZIS-4		
					3482 124 516	430	
					1878 002 878	420 10	
					3151 208 001	420GTZ	
					KZI-5		

HD 7							
01.96 -							
42.42	01.96 -	8210.42L		3400 117 801	430 10	für Ausrückgabel mit Nocken / for release fork with cams (70)	
42.42 T	01.96 -				3482 083 032	MFZ430	
44.34	01.96 -				1878 085 741	430WGTZ	
44.38	01.96 -				3151 000 144	KZISZ-5	
44.38 T	01.96 -	8460.41K., 8210.42M, 8210.42K., 8210.42L.		3400 700 435	430 10	für Ausrückgabel mit Rollen / for release fork with rollers (71)	
44.42 T	01.96 -				3482 083 032	MFZ430	
64.34	01.96 -				1878 085 741	430WGTZ	
64.42	01.96 -				3151 000 493	KZISZ-5	
64.42 T	01.96 -			3189 600 004		Getr. / GBox: ZF AS Tronic Rollenausführung / roller version (58)	
66.42 T	01.96 -						
84.47	01.96 -						
86.42	01.96 -						
64.38	01.96 -	8210.42K		3400 117 801	430 10	für Ausrückgabel mit Nocken / for release fork with cams (70)	
64.38 T	01.96 -				3482 083 032	MFZ430	
66.38	01.96 -				1878 085 741	430WGTZ	
					3151 000 144	KZISZ-5	
				3400 700 435	430 10	für Ausrückgabel mit Rollen / for release fork with rollers (71)	
					3482 083 032	MFZ430	
					1878 085 741	430WGTZ	
					3151 000 493	KZISZ-5	
				3189 600 004		Getr. / GBox: ZF AS Tronic Rollenausführung / roller version (58)	
64.45	01.96 -	8280.42B		3400 117 801	430 10	für Ausrückgabel mit Nocken / for release fork with cams (70)	
64.45 T	01.96 -				3482 083 032	MFZ430	
64.47	01.96 -				1878 085 741	430WGTZ	
66.45	01.96 -				3151 000 144	KZISZ-5	
66.45 T	01.96 -			3400 700 435	430 10	für Ausrückgabel mit Rollen / for release fork with rollers (71)	
86.45	01.96 -				3482 083 032	MFZ430	
					1878 085 741	430WGTZ	
					3151 000 493	KZISZ-5	
				3189 600 004		Getr. / GBox: ZF AS Tronic Rollenausführung / roller version (58)	
64.52	01.96 -	8280.42S		3400 117 801	430 10	für Ausrückgabel mit Nocken / for release fork with cams (70)	
64.52 T	01.96 -				3482 083 032	MFZ430	
66.52	01.96 -				1878 085 741	430WGTZ	
66.52 T	01.96 -				3151 000 144	KZISZ-5	
84.52	01.96 -			3400 700 435	430 10	für Ausrückgabel mit Rollen / for release fork with rollers (71)	
86.52	01.98 -				3482 083 032	MFZ430	
					1878 085 741	430WGTZ	
					3151 000 493	KZISZ-5	
				3189 600 004		Getr. / GBox: ZF AS Tronic Rollenausführung / roller version (58)	
66.42	01.96 -	8210.42L.		3400 117 801	430 10	für Ausrückgabel mit Nocken / for release fork with cams (70)	
					3482 083 032	MFZ430	
					1878 085 741	430WGTZ	
					3151 000 144	KZISZ-5	
				3400 700 435	430 10	für Ausrückgabel mit Rollen / for release fork with rollers (71)	
					3482 083 032	MFZ430	
					1878 085 741	430WGTZ	
					3151 000 493	KZISZ-5	
				3189 600 004		Getr. / GBox: ZF AS Tronic Rollenausführung / roller version (58)	









		CODE				
--	--	------	--	---	---	---

ASTRA





HD 7-C		01.00 -							
42.36	01.00-	8210.42L		3400 117 801	430 10	für Ausrückgabel mit Nocken / for release fork with cams	(70)		
42.36 T	01.00-			 3482 083 032	MFZ430				
42.40	01.00-			 1878 085 741	430WGTZ				
42.40 T	01.00-			 3151 000 144	KZISZ-5				
42.45	01.00-			3400 700 435	430 10	für Ausrückgabel mit Rollen / for release fork with rollers	(71)		
42.45 T	01.00-			 3482 083 032	MFZ430				
44.36	01.00-	F3BE0681D, F3BE0681J, F3BE0681H		3189 600 004		Getr. / GBox: ZF AS Tronic Rollenausführung / roller version	(58)		
44.36 T	01.00-								
44.40	01.00-								
44.40 T	01.00-								
44.45	01.00-								
44.45 T	01.00-								
64.40	01.00-								
64.40 T	01.00-								
84.42	01.00-								
42.38	01.00-	8210.42K		3400 117 801	430 10	für Ausrückgabel mit Nocken / for release fork with cams	(70)		
64.36	01.00-			 3482 083 032	MFZ430				
64.36 T	01.00-			 1878 085 741	430WGTZ				
66.36	01.00-			 3151 000 144	KZISZ-5				
84.38	01.00-			3400 700 435	430 10	für Ausrückgabel mit Rollen / for release fork with rollers	(71)		
66.36 T	01.00-			 3482 083 032	MFZ430				
	01.00-			 1878 085 741	430WGTZ				
	01.00-			 3151 000 493	KZISZ-5				
		F3BE0681J		3189 600 004		Getr. / GBox: ZF AS Tronic Rollenausführung / roller version	(58)		
64.45	01.00-	8280.42B		3400 117 801	430 10	für Ausrückgabel mit Nocken / for release fork with cams	(70)		
64.45 T	01.00-			 3482 083 032	MFZ430				
84.50	01.00-			 1878 085 741	430WGTZ				
86.40	01.00-			 3151 000 144	KZISZ-5				
86.45	01.00-			3400 700 435	430 10	für Ausrückgabel mit Rollen / for release fork with rollers	(71)		
	01.00-			 3482 083 032	MFZ430				
	01.00-			 1878 085 741	430WGTZ				
	01.00-			 3151 000 493	KZISZ-5				
		F3BE0681D, F3BE0681H, F3BE0681F		3189 600 004		Getr. / GBox: ZF AS Tronic Rollenausführung / roller version	(58)		
64.50	01.00-	8280.42S		3400 117 801	430 10	für Ausrückgabel mit Nocken / for release fork with cams	(70)		
64.50 T	01.00-			 3482 083 032	MFZ430				
84.36	01.00-			 1878 085 741	430WGTZ				
84.40	01.00-			 3151 000 144	KZISZ-5				
66.40	01.00-			3400 700 435	430 10	für Ausrückgabel mit Rollen / for release fork with rollers	(71)		
84.45	01.00-			 3482 083 032	MFZ430				
66.40 T	01.00-			 1878 085 741	430WGTZ				
66.45	01.00-			 3151 000 493	KZISZ-5				
66.45 T	01.00-			3189 600 004		Getr. / GBox: ZF AS Tronic Rollenausführung / roller version	(58)		
66.50	01.00-								
66.50 T	01.00-								
88.45	01.00-								
88.50	01.00-								

HD 8		01.05 -					
42.33	06.07-	F2BE3681A, F2BE3681B		3400 700 365	430 10	Getr. / GBox: AS Tronic für Ausrückgabel mit Rollen / for release fork with rollers	(71)
42.36	06.07-			 3482 000 573	MFZ430		
44.33	06.07-			 1878 004 133	430WGTZ		
44.36	06.07-			 3151 000 493	KZISZ-5		
				3400 700 378	430 10	Getr. / GBox: Ecosplit, AS Tronic für Ausrückgabel mit Nocken / for release fork with cams	(70)
				 3482 000 573	MFZ430		
				 1878 004 133	430WGTZ		
				 3151 000 144	KZISZ-5		
				3189 600 004		Getr. / GBox: ZF AS Tronic Rollenausführung / roller version	(58)









ASTRA









HD 8		01.05 -					
42.36	01.05-	F3BE0681K,	 3400 117 801  3482 083 032  1878 085 741  3151 000 144	430 10 MFZ430 430WGTZ KZISZ-5	Getr. / GBox: Ecosplit für Ausrückgabel mit Nocken / for release fork with cams	(70)	
42.36 T	01.05-	F3BE0681D,					
42.40	01.05-	F3BE0681J,					
42.40 T	01.05-	F3BE3681G,	3400 700 435  3482 083 032  1878 085 741  3151 000 493	430 10 MFZ430 430WGTZ KZISZ-5	Getr. / GBox: Ecosplit für Ausrückgabel mit Rollen / for release fork with rollers	(71)	
42.41	03.07-	F3BE3681F,					
42.45	01.05-	F3BE0681H,					
42.45 T	01.05-	F3BE0681A	 3189 600 004		Getr. / GBox: ZF AS Tronic Rollenausführung / roller version	(58)	
42.50	01.05-						
42.50 T	01.05-						
42.48	03.07-						
44.36	01.05-						
44.36 T	01.05-						
44.40, 44.41	01.05-						
44.40 T	01.05-						
44.45 T	01.05-						
44.50	01.05-						
44.50 T	01.05-						
64.36	01.05-						
64.36 T	01.05-						
64.40	01.05-						
64.40 T	01.05-						
64.45	01.05-						
64.45 T	01.05-						
64.50	01.05-						
64.50 T	01.05-						
66.36	01.05-						
66.36 T	01.05-						
66.40	01.05-						
66.40 T	01.05-						
66.45	01.05-						
66.45 T	01.05-						
66.50	01.05-						
66.50 T	01.05-						
84.36	01.05-						
84.40, 84.41	01.05-						
84.50	01.05-						
84.54	01.05-						
86.54	01.05-						
86.40	01.05-						
86.44, 86.45	01.05-						
88.45	01.05-						
88.50	01.05-						
88.54	01.05-						

ASTRA



HD 8		01.05 -				
42.41 T	03.07-	F3BE3681G,		3400 700 461 ⊗ 3482 000 572 ⊗ 1878 004 132 ⊙ 3151 000 144	430 10 MFZ430 430WGTZ KZISZ-5	Getr. / GBox: Ecosplit
42.44	03.07-	F3BE0681K,				
42.44 T	03.07-	F3BE0681D,				
42.48 T	03.07-	F3BE3681E,				
42.52 T	03.07-	F3BE3681A,				
42.56 T	03.07-	F3BE3681F,				
44.44, 44.45	01.05-	F3BE3681D				
44.44 T	03.07-					
44.48	03.07-					
44.48 T	03.07-					
44.52 T	03.07-					
44.56 T	03.07-					
64.41	03.07-					
64.41 T	03.07-					
64.44	03.07-					
64.44 T	03.07-					
64.48	03.07-					
64.48 T	03.07-					
64.52	03.07-					
64.52 T	03.07-					
64.56	03.07-					
64.56 T	03.07-					
66.41	03.07-					
66.41 T	03.07-					
66.44	03.07-					
66.44 T	03.07-					
66.48	03.07-					
66.48 T	03.07-					
66.52	03.07-					
66.52 T	03.07-					
66.56	03.07-					
66.56 T	03.07-					
84.44, 84.45	01.05-					
84.48	03.07-					
84.52	03.07-					
84.56	03.07-					
86.48	03.07-					
86.50	01.05-					
86.52	03.07-					
86.56	03.07-					
88.48	03.07-					
88.52	03.07-					
88.56	03.07-					
44.41 T	03.07-	F3BE3681		3400 700 366 ⊗ 3482 000 572 ⊗ 1878 004 132 ⊙ 3151 000 493	430 10 MFZ430 430WGTZ KZISZ-5	Getr. / GBox: 12AS2330TO für Ausrückgabel mit Rollen / for release fork with rollers (71)
66.54	03.07-					
				3400 700 461 ⊗ 3482 000 572 ⊗ 1878 004 132 ⊙ 3151 000 144	430 10 MFZ430 430WGTZ KZISZ-5	Getr. / GBox: 16S2220TO Getr. / GBox: 12AS2330TO
		F3BE0681A, F3BE3681D		3189 600 004		Getr. / GBox: ZF AS Tronic Rollenausführung / roller version (58)

AVIA



D-Line		10.01 -					
D 100	10.01 -	ISBe150, ISBe170		3482 125 512	362		
D 100	10.01 -				MF362		
D 120	10.01 -			1878 019 001	362 10		
D 120	10.01 -			3151 199 001		KZIS-3	
D 60	10.01 -	CumminsISB15 0/170, Euro3		3482 000 461	362	Getr. / GBox: ZF S5-42	
D 60	10.01 -				MF362		
D 75	10.01 -			1878 019 001	362 10	->Chass. 5A003732	
D 75	10.01 -				362TB	Getr. / GBox: ZF S5-42	
D 75 T	10.01 -			1878 000 515	362 10	Chass. 5A003733->	
D 75 T	10.01 -			362GTZ	Getr. / GBox: ZF S5-42		
D 90	10.01 -	CumminsISB15 0/170, Euro3		3482 000 461	362	Getr. / GBox: ZF 6S850	
D 90	10.01 -				MF362		
				1878 019 001	362 10	->Chass. 5A003732	
				362TB	Getr. / GBox: ZF 6S850		
			1878 000 515	362 10	Chass. 5A003733->		
				362GTZ	Getr. / GBox: ZF 6S850		

TRUCK							
D 60 / D75 (zgg.6200kg)		CumminsISB15 0, Euro3		3482 000 461	362	Getr. / GBox: ZF S5-42	
					MF362		
				1878 019 001	362 10	->Chass. 5A003732	
				362TB	Getr. / GBox: ZF S5-42		
			1878 000 515	362 10	Chass. 5A003733->		
				362GTZ	Getr. / GBox: ZF S5-42		
D 60 / D75 (zgg.7490kg) D 75 T Urban Tractor (zgg.10990kg)		CumminsISB15 0/170, Euro3		3482 000 461	362	Getr. / GBox: ZF S5-42	
					MF362		
				1878 019 001	362 10	->Chass. 5A003732	
				362TB	Getr. / GBox: ZF S5-42		
			1878 000 515	362 10	Chass. 5A003733->		
				362GTZ	Getr. / GBox: ZF S5-42		
D 90 (zgg. 9000kg)		CumminsISB15 0/170, Euro3		3482 000 461	362	Getr. / GBox: ZF 6S850	
					MF362		
				1878 019 001	362 10	->Chass. 5A003732	
				362TB	Getr. / GBox: ZF 6S850		
			1878 000 515	362 10	Chass. 5A003733->		
				362GTZ	Getr. / GBox: ZF 6S850		

BMC

PROFESSIONAL		09.96 -					
625 VHX	09.08 -	ISBe4250B, ISBe5250B, ISBe5285		3482 000 474	395		
628 DHZ	09.08 -					MF395	
				1878 003 899	395 10		
					395WGTZ		
938 EDB	09.08 -	ISLe5380		3482 083 113	430		
938 EDE	09.08 -					MFZ430	
938 EDE	09.08 -						
938 ETB	09.08 -						
938 ETE	09.08 -						

DAF

200-Serie						
1,7	04.89 - 08.92			1850 480 049	240	Getr. / GBox: 5 Gang / 5-speed
2,0	04.89 -				M240	
2,0 D	04.89 -			1878 600 863	242 23	Getr. / GBox: 5 Gang / 5-speed
					242TP	
				1863 600 128	GR1	Getr. / GBox: 5 Gang / 5-speed







		CODE				
--	--	------	--	---	---	---



DAF







F 900						
FA 900 BDF	11.81 - 11.88	DT615,		3400 124 901 ⊗ 3482 060 132 ⊗ 1861 777 037 ⊙ 3151 199 001	350 10 MF350 350GTD KZIS-3	Nabenprofil / Hub Profile: 1 1/2"-10N (48)
FA 900 BDT	11.83 - 11.88	DF615				

F 1100						
FA 1100 DD	01.78 - 12.81	DD575,		3400 124 901 ⊗ 3482 060 132 ⊗ 1861 777 037 ⊙ 3151 199 001	350 10 MF350 350GTD KZIS-3	Nabenprofil / Hub Profile: 1 1/2"-10N (48)
FA 1100 DF	11.81 - 11.88	DT615,				
FA 1100 DNTD	12.86 - 11.90	DNTD620,				
FA 1100 DT	11.83 - 11.88	DF615				

























F 1200						
FA 1200 DD	01.69 - 12.81	DD575		3400 124 901 ⊗ 3482 060 132 ⊗ 1861 777 037 ⊙ 3151 199 001	350 10 MF350 350GTD KZIS-3	Nabenprofil / Hub Profile: 1 1/2"-10N (48)



F 1300						
F 1300				3400 124 901 ⊗ 3482 060 132 ⊗ 1861 777 037 ⊙ 3151 199 001	350 10 MF350 350GTD KZIS-3	Getr. / GBox: ZF 6S-36 Nabenprofil / Hub Profile: 1 1/2"-10N (48)
F 1300 DF				3482 008 034 #	310 MF310	
FA 1300				3482 008 034 #	310 MF310	Getr. / GBox: DF615
				3482 002 234	350 GMF350X	
				1878 001 071	350 10 350GTZ	
				3400 124 901 ⊗ 3482 060 132 ⊗ 1861 777 037 ⊙ 3151 199 001	350 10 MF350 350GTD KZIS-3	Getr. / GBox: ZF 6S-36 Nabenprofil / Hub Profile: 1 1/2"-10N (48)
FA 1300 DF	07.78 - 10.88	DNT620,		3400 124 901 ⊗ 3482 060 132 ⊗ 1861 777 037 ⊙ 3151 199 001	350 10 MF350 350GTD KZIS-3	Getr. / GBox: ZF S6-36 Nabenprofil / Hub Profile: 1 1/2"-10N (48)
FA 1300 DNT,FA 1300 NT	12.86 - 12.92	DT615,				
FA 1300 DNTD,FA 1300 NB	12.86 - 12.92	NT116,				
FA 1300 DT	07.78 - 02.90	DNTD620,				
FA 1305 DT	07.78 - 02.90	NT133,				
FA 1300 DT-B	07.78 - 02.90	DF615				

F 1400						
F 1400 DF		D615		1882 137 307 #	310 GF310	
FA 1400 DD	02.72 - 12.81	DD575		3400 124 901 ⊗ 3482 060 132 ⊗ 1861 777 037 ⊙ 3151 199 001	350 10 MF350 350GTD KZIS-3	Nabenprofil / Hub Profile: 1 1/2"-10N (48)

F 1500 07.78 -						
F 1500 DF				3400 124 901 ⊗ 3482 060 132 ⊗ 1861 777 037 ⊙ 3151 199 001	350 10 MF350 350GTD KZIS-3	Getr. / GBox: ZF 6S-36 Nabenprofil / Hub Profile: 1 1/2"-10N (48)
				3482 008 034 #	310 MF310	
FA 1500				3482 008 034 #	310 MF310	Getr. / GBox: DF615
				3482 002 234	350 GMF350X	
				1878 001 071	350 10 350GTZ	
FA 1500 DF,FD 1500 DF	07.78 - 08.91	DT615,		3400 124 901 ⊗ 3482 060 132 ⊗ 1861 777 037 ⊙ 3151 199 001	350 10 MF350 350GTD KZIS-3	Getr. / GBox: ZF S6-36 Nabenprofil / Hub Profile: 1 1/2"-10N (48)
FA 1500 DT,FD 1500 DT	07.78 - 08.91	DF615				
FT 1500 DT	07.78 - 05.86					





DAF







F 1600							
F 1600				1878 001 071	350 10 350GTZ	Getr. / GBox: ZF 6S-36 nur als Ersatz für angegebene OE-Nr. / only for the listed OE-Numbers (100)	
				1861 777 043	350 10 350GTD	Getr. / GBox: ZF 6S-36 nur als Ersatz für angegebene OE-Nr. / only for the listed OE-Numbers (100)	
				3151 199 001	KZIS-3	Getr. / GBox: ZF 6S-36	
			DH825		1882 110 542 ▲	350 GF350	Getr. / GBox: S 8-45-2
					1878 001 070	350 10 350GTZ	Getr. / GBox: S 8-45-2
FA 1600 DT FA 1600 DF FA 1600 DF 420 FA 1605 DF FAS 1600 DF FT 1600 DF	01.70-08.91	DF615		1878 001 071	350 10 350GTZ	Getr. / GBox: ZF 6S-36 nur als Ersatz für angegebene OE-Nr. / only for the listed OE-Numbers (100)	
				1861 777 043	350 10 350GTD	Getr. / GBox: ZF 6S-36 nur als Ersatz für angegebene OE-Nr. / only for the listed OE-Numbers (100)	
				3151 199 001	KZIS-3	Getr. / GBox: ZF 6S-36	
				1882 137 307 #	310 GF310		
FA 1600 DT FGG 1600 DT, FGG 1621 DT FT 1600 DT	01.73-08.91 01.73-08.91 01.73-08.91	DT615		1878 001 071	350 10 350GTZ	Getr. / GBox: ZF S6-36	
				1861 777 043	350 10 350GTD	Getr. / GBox: ZF S6-36	
				3151 199 001	KZIS-3	Getr. / GBox: ZF S6-36	
FA 1600 DTD FAS 1600 DTD FH 1600 DTD FM 1600 DF FT 1600 DTD				1878 001 071	350 10 350GTZ	Getr. / GBox: ZF 6S-36 nur als Ersatz für angegebene OE-Nr. / only for the listed OE-Numbers (100)	
				1861 777 043	350 10 350GTD	Getr. / GBox: ZF 6S-36 nur als Ersatz für angegebene OE-Nr. / only for the listed OE-Numbers (100)	
				3151 199 001	KZIS-3	Getr. / GBox: ZF 6S-36	
				1882 110 542 ▲	350 GF350		
				1878 001 071	350 10 350GTZ		
FA 1605 DT FA 1605 DTD				1878 001 071	350 10 350GTZ	Getr. / GBox: ZF 6S-36 nur als Ersatz für angegebene OE-Nr. / only for the listed OE-Numbers (100)	
				1861 777 043	350 10 350GTD	Getr. / GBox: ZF 6S-36 nur als Ersatz für angegebene OE-Nr. / only for the listed OE-Numbers (100)	
				3151 199 001	KZIS-3	Getr. / GBox: ZF 6S-36	
				1882 110 542 ▲	350 GF350	Getr. / GBox: AK/S 5-35-2	
				1878 001 071	350 10 350GTZ	Getr. / GBox: AK/S 5-35-2	
		DH825		1882 110 542 ▲	350 GF350	Getr. / GBox: S 8-45-2	
				1878 001 070	350 10 350GTZ	Getr. / GBox: S 8-45-2	





F 1700						
FA 1700 DNS FA 1700 DNT, FA 1700 NT FA 1700 DNTD, FA 1700 NB, FD 1700 DNTD, FD 1700 NB FAG 1700 DNT, FAG 1700 NT FAG 1700 DNTD, FAG 1700 NB	01.88-02.95 12.86-02.95 12.86-02.95 12.86-02.95 12.86-02.95	DNT620, DNS620, NT116, DNTD620, NT133		3400 124 801 ⊗ 3482 060 132 ⊗ 1861 777 043 ⊙ 3151 000 395	350 10 MF350 350GTD KZIS-4	Getr. / GBox: ZF S6-36 Nabenprofil / Hub Profile: 1 3/4"-10N (48)
				3400 124 901 ⊗ 3482 060 132 ⊗ 1861 777 037 ⊙ 3151 199 001	350 10 MF350 350GTD KZIS-3	Getr. / GBox: ZF S6-36 Nabenprofil / Hub Profile: 1 1/2"-10N (48)











		CODE				
--	--	------	--	---	---	---

DAF

F 1800							
FAV 1800 DT	01.70-08.91	DT615		3482 002 234	350 GMF350X	Getr. / GBox: ZF S5-36	
				1861 777 037	350 10 350GTD	Getr. / GBox: ZF S5-36	
				3163 030 100	KZI-3	Getr. / GBox: ZF S5-36	
				1882 110 542 ▲	350 GF350		
				1878 001 071	350 10 350GTZ		

























F 1900							
FA 1900 DNS	12.86-09.93	NS156, DNS620, DNT620, NT133		3400 124 901	350 10 MF350	Nabenprofil / Hub Profile: 1 1/2"-10N	(48)
FA 1900 DNS,FA 1900 NS	12.86-09.93			3482 060 132	350GTD		
FA 1900 DNT,FA 1900 NT	12.86-09.93			1861 777 037	KZIS-3		
FA 1900 DNT,FD 1900 DNT,FD 1900 NT	12.86-09.93			3400 124 801	350 10 MF350	Nabenprofil / Hub Profile: 1 3/4"-10N	(48)
FAV 1900 DNT,FAV 1900 NT	12.86-09.93			3482 060 132	350GTD		
FT 1900 DNS,FT 1900 NS	12.86-09.93			1861 777 043	KZIS-4		
				3151 000 395			

F 2000							
F 2000		DH825		1882 110 542 ▲	350 GF350	Getr. / GBox: S 8-45-2	
F 2000 DH				1878 001 070	350 10 350GTZ	Getr. / GBox: S 8-45-2	
F 2000 DHB		DH/DU/DHB825		1878 000 105	380 10 380GTZ		
FA 2000 DHB	01.70-12.79						
FAS 2000 DHB	01.70-12.79						
FAT 2000 DHB	01.70-12.79						
FM 2000 DHB	01.70-12.79						
FT 2000 DHB	01.70-12.79						
FT 2005 DHB	01.70-12.79						
FA 2000 DH	01.70-12.79	DH825		1882 110 542 ▲	350 GF350	Getr. / GBox: S 8-45-2	
FAS 2000 DH	01.70-12.79			1878 001 070	350 10 350GTZ	Getr. / GBox: S 8-45-2	
FAT 2000 DH	01.70-12.79						
FM 2000 DH	01.70-12.79						
FT 2000 DH	01.70-12.79						



F 2100							
F 2100		DH, DHR, DHT825, DF615		3482 008 034 #	310 MF310	Je nach Kundenwunsch mit unterschiedlicher Kupplung / Equipped with different clutch according to customer requirement	(35)
				3482 002 234	350 GMF350X	Je nach Kundenwunsch mit unterschiedlicher Kupplung / Equipped with different clutch according to customer requirement	(35)
			1878 001 071	350 10 350GTZ			
			3163 026 100	KZI-4	Kugellager / Ball Bearing	(38)	
			3482 017 035	380 GMF380	Je nach Kundenwunsch mit unterschiedlicher Kupplung / Equipped with different clutch according to customer requirement	(35)	
			1878 000 105	380 10 380GTZ			
			3151 000 395	KZIS-4			
			3400 124 701	380 10 GMF380	Getr. / GBox: ZF S6-90		
	3482 017 034	380GTZ	Getr. / GBox: ZF 9/16S-109				
	1878 000 105	KZIS-4					
	3151 000 395						

DAF

F 2100



























F 2105		DH, DHR, DHT825	 3482 002 234	350 GMF350X	Je nach Kundenwunsch mit unterschiedlicher Kupplung / Equipped with different clutch according to customer requirement	(35)			
			 1878 001 071	350 10 350GTZ					
			 3163 026 100	KZI-4	Kugellager / Ball Bearing	(38)			
			 3482 017 035	380 GMF380	Je nach Kundenwunsch mit unterschiedlicher Kupplung / Equipped with different clutch according to customer requirement	(35)			
FA 2100 DF,FA 2105 DF FA 2105 DHR,FA 2105 DHTD FA 2105 DHT FA 2105 DHT FA 2105 DHTD FAG 2100 DH,FAG 2105 DH FAG 2100 DHR,FAG 2105 DHR,FAG 2100 DHTD FAS 2100 DHR,FAS 2103 DHR,FAS 2105 DHR,FAS 2103 DHTD FAS 2103 DH FAS 2103 DH,FAS 2105 DH FAS 2103 DHT FAS 2103 DHTD FT 2100 DHR FT 2105 DHT FT 2105 DHTD FT 2105 DHTD	07.78 - 09.86 07.78 - 09.86 07.81 - 09.86 06.86 - 08.91 06.86 - 08.91 07.78 - 09.86 07.78 - 09.86 07.78 - 09.86 07.78 - 09.86 07.78 - 09.86 06.86 - 08.91 07.78 - 09.86 07.81 - 09.86 06.86 - 08.91 07.78 - 08.91 07.81 - 09.86 07.81 - 09.86 06.86 - 08.91	DHR825, DHT825, DHTD825, DH825, DF615	 3400 124 701	380 10 GMF380 380GTZ KZIS-4	Getr. / GBox: ZF S6-90 Getr. / GBox: ZF 9/16S-109				
			 3482 017 034						
			 1878 000 105						
			 3151 000 395						
			 3400 124 701	380 10 GMF380 380GTZ KZIS-4	Getr. / GBox: ZF 9S/16S-109, S6-90				
			 3482 017 034						
			 1878 000 105						
			 3151 000 395						
			 3482 000 953	350 GMF350X	Getr. / GBox: S 6-36+GV 36				
			 1878 001 070	350 10 350GTZ	Getr. / GBox: S 6-36+GV 36				
			 3151 000 515	KZIS-4	Getr. / GBox: S 6-36+GV 36				
			 3400 124 701	380 10 GMF380 380GTZ KZIS-4	Getr. / GBox: ZF S6-90 Getr. / GBox: ZF 9/16S-109				
			 3482 017 034						
			 1878 000 105						
			 3151 000 395						
			FA 2100 DNS			 3400 124 701	380 10 GMF380 380GTZ KZIS-4	Getr. / GBox: ZF S6-90 Getr. / GBox: ZF 9/16S-109	
						 3400 124 801	350 10 MF350 350GTD KZIS-4	Getr. / GBox: S 6-65+GV 80 Nabenprofil / Hub Profile: 1 3/4"-10N	(48)
 3482 060 132									
 1861 777 043									
 3151 000 395									

F 2200

F 2200 DT		DH825	 1882 110 542 ▲	350 GF350	Getr. / GBox: S 8-45-2	
			 1878 001 070	350 10 350GTZ	Getr. / GBox: S 8-45-2	
F 2205 DHB FA 2200 DU FAD 2205 DU FAS 2200 DU FAS 2205 DU FAT 2205 DU FAZ 2205 DU FT 2200 DU	01.71 - 11.80 01.71 - 11.80 01.71 - 11.80 01.71 - 11.80 01.71 - 11.80 01.71 - 11.80 01.71 - 11.80	DH/DU/DHB825	 1878 000 105	380 10 380GTZ		





		CODE				
--	--	------	--	---	---	---

DAF









F 2300		09.63 - 10.93				
F 2300		DH825/DHU825	 3482 002 234	350 GMF350X	Je nach Kundenwunsch mit unterschiedlicher Kupplung / Equipped with different clutch according to customer requirement	(35)
			 1878 001 070	350 10 350GTZ		
			 3163 026 100	KZI-4	Kugellager / Ball Bearing	(38)
			 1878 000 105	380 10 380GTZ		
			 3482 017 035	380 GMF380	Je nach Kundenwunsch mit unterschiedlicher Kupplung / Equipped with different clutch according to customer requirement	(35)
			 1878 000 105	380 10 380GTZ		
			 3151 000 395	KZIS-4		
			 3151 111 032	KZI-6	ohne Schmierrohranschluss / without lubricating pipe connection	(103)
			 3400 124 701	380 10 GMF380	Getr. / GBox: ZF S6-90	
			 1878 000 105	380GTZ	Getr. / GBox: ZF 9/16S-109	
 3151 000 395	KZIS-4					
F 2305		DH825/DHU825	 3482 002 234	350 GMF350X	Je nach Kundenwunsch mit unterschiedlicher Kupplung / Equipped with different clutch according to customer requirement	(35)
			 1878 001 070	350 10 350GTZ		
			 3163 026 100	KZI-4	Kugellager / Ball Bearing	(38)
			 3482 017 035	380 GMF380	Je nach Kundenwunsch mit unterschiedlicher Kupplung / Equipped with different clutch according to customer requirement	(35)
			 1878 000 105	380 10 380GTZ		
			 3151 000 395	KZIS-4		
			 3400 124 701	380 10 GMF380	Getr. / GBox: ZF S6-90	
			 1878 000 105	380GTZ	Getr. / GBox: ZF 9/16S-109	
			 3151 000 395	KZIS-4		
			 3400 124 701	380 10 GMF380	Getr. / GBox: ZF 9S/16S-109, S6-90	
 1878 000 105	380GTZ					
 3151 000 395	KZIS-4					
FA 2300 DHR	07.78 - 12.81	HT825, DHR825, DHT825, DHTD825, DHU825, DH825	 3400 124 701	380 10 GMF380		
FA 2300 DHU	07.78 - 12.81		 1878 000 105	380GTZ		
FA 2300 HT	01.90 - 10.93		 3151 000 395	KZIS-4		
FAB 2305 DHT,FAG 2305	07.78 - 09.86					
DHT,FAS 2300 DHU,FAS 2303						
DHU,FAS 2305						
FAG 2300 DHT,FAG 2305 DHT	11.81 - 09.86					
FAG 2300 DHT,FAG 2305 DHT	09.86 - 08.91					
FAG 2300 DHTD,FAG 2305	06.86 - 08.91					
DHTD						
FAG 2300 HT,FAR 2300 HT	01.90 - 10.93					
FAG 2305 DH	07.78 - 12.81					
FAS 2300 DHR,FAS 2305 DHR	07.78 - 12.81					
FAT 2300 HT	01.90 - 10.93					
FAT 2305 DH	07.78 - 12.81					
FAT 2305 DHR	07.78 - 12.81					
FAT 2305 DHU,FAT 2335 DHT	07.78 - 09.86					
FAT 2335 DHT	06.86 - 08.91					
FAV 2300 HT	01.90 - 10.93					
FMB 2305 DHU	07.78 - 12.83					
FMT 2300 HT	01.90 - 10.93					
FMT 2305 DHR	07.78 - 12.81					
FMT 2305 DHU,FMT 2335 DHT	07.78 - 09.86					
FMT 2335 DHT	06.86 - 08.91					
FT 2300 DHU,FT 2305 DHU	07.78 - 12.83					
FT 2300 HT	01.90 - 10.93					

DAF









F 2500

FA 2500 DHS	02.82 - 08.86	DHS825		3482 017 035	380	
FA 2505 DHS	06.86 - 08.91				GMF380	
FAG 2500 DHS, FAG 2505 DHS, FAS 2503 DHS	06.86 - 08.91			3151 000 515	KZIS-4	
FAG 2505 DHS, FAS 2503 DHS	02.82 - 09.86					
FAT 2525 DHS	02.82 - 09.86					
FAT 2525 DHS	06.86 - 08.91					
FAT 2525 DHS, FAT 2535 DHS	06.86 - 08.91					
FAT 2535 DHS	02.82 - 09.86					
FMD 2525 DHS	02.82 - 09.86					
FMD 2525 DHS, FMD 2535 DHS	06.86 - 08.91					
FMT 2525 DHS	02.82 - 09.86					
FMT 2525 DHS, FMT 2535 DHS	06.86 - 08.91					
FT 2505 DHS	06.86 - 08.91					
FA 2500 DHS		DHS825		3482 017 035	380	Getr. / GBox: S 6-90+GV 90
FAD 2535 DHS	02.82 - 09.86				GMF380	
FAD 2535 DHS	06.86 - 08.91			3151 000 515	KZIS-4	Getr. / GBox: S 6-90+GV 90
FAG 2500 DHS, FAG 2505 DHS, FAS 2503 DHS	06.86 - 08.91					
FAG 2505 DHS, FAS 2503 DHS	02.82 - 09.86					
FAS 2500 DHS						
FT 2500 DHS	02.82 - 09.86					

F 2700 01.90 - 10.93





















F 2700				3400 124 701  3482 017 034  1878 000 105  3151 000 395	380 10 GMF380 380GTZ KZIS-4	Getr. / GBox: ZF S6-90 Getr. / GBox: ZF 9/16S-109
FA 2700 HS	01.90 - 10.93	HS825		3400 124 701  3482 017 034  1878 000 105  3151 000 395	380 10 GMF380 380GTZ KZIS-4	
FAB 2700 HS, FAG 2700 HS, FAR 2700 HS	01.90 - 10.93					
FAT 2700 HS	01.90 - 10.93					
FMT 2700 HS	01.90 - 10.93					
FT 2700 HS	01.90 - 10.93					

F 2800 09.73 - 09.91







F 2800		DKT/DKTD1160		3482 124 550	430	
F 2805				3482 006 036 ●#	420	
				3151 000 515	KZIS-4	
				3482 018 132 #	420	Getr. / GBox: ZF 16S-151/181/221
				3482 119 031	430	Getr. / GBox: ZF 16S-151/181/221
					GMF430	
				1878 086 741	420 10	Getr. / GBox: ZF 16S-151/181/221
					430WGTZ	
				3151 182 233	KZI-5	Getr. / GBox: ZF 16S-151/181/221
				3482 119 032	430	Getr. / GBox: ZF 16S-130
					GMF430	
				1878 003 269	420 10	Getr. / GBox: ZF 16S-130
					420GTZ	
				3151 000 395	KZIS-4	Getr. / GBox: ZF 16S-130

DAF

F 2800 09.73 - 09.91

F 2800 ATi		DKXE1160ATi	 3400 125 701  3482 119 031  1878 003 269  3151 000 395	430 10 GMF430 420GTZ KZIS-4		
			 3482 018 132 ●#	420 GMF420		
			 3482 018 132 #	420 GMF420	Getr. / GBox: ZF 16S-151/181/221	
			 1878 086 741	420 10 430WGTZ	Getr. / GBox: ZF 16S-151/181/221	
			 3151 182 233	KZI-5	Getr. / GBox: ZF 16S-151/181/221	
			 3482 119 032	430 GMF430	Getr. / GBox: ZF 16S-130	
			 1878 003 269	420 10 420GTZ	Getr. / GBox: ZF 16S-130	
			 3151 000 395	KZIS-4	Getr. / GBox: ZF 16S-130	
F 2800 DKA/DKT		DKA1160	 3482 124 541	430 GMF430		
			 1882 330 032 ●#	420 GF420		
			 3151 000 515	KZIS-4		
			 3482 018 132 #	420 GMF420	Getr. / GBox: ZF 16S-151/181/221	
			3482 119 031	430 GMF430	Getr. / GBox: ZF 16S-151/181/221	
			 1878 086 741	420 10 430WGTZ	Getr. / GBox: ZF 16S-151/181/221	
			 3151 182 233	KZI-5	Getr. / GBox: ZF 16S-151/181/221	
			 3482 119 032	430 GMF430	Getr. / GBox: ZF 16S-130	
			 1878 003 269	420 10 420GTZ	Getr. / GBox: ZF 16S-130	
			 3151 000 395	KZIS-4	Getr. / GBox: ZF 16S-130	



















DAF

F 2800		09.73 - 09.91				
FA 2800 DKA	01.74 - 08.80	DKA1160,		3400 124 601	430 10	Getr. / GBox: ZF 16S-151/181/221
FA 2800 DKS	01.74 - 09.86	DKV1160,		 3482 119 031	GMF430	
FA 2800 DKT	01.74 - 11.80	DKXE1160,		 1878 086 741	430WGTZ	
FA 2800 DKTD	01.74 - 09.86	DKT1160,		 3151 000 395	KZIS-4	
FA 2800 DKTD	06.86 - 09.91	DKS1160,				
FA 2800 DKTD	06.86 - 09.91	DKTD1160,				
FA 2805 DKSE,FA 2800 DKV,FA 2800 DKXE	05.83 - 09.91	DKS1160E				
FAB 2805 DKS,FAR 2800 DKS,FAS 2800 DKS	01.74 - 09.86					
FAB 2805 DKTD,FAS 2800 DKTD	01.74 - 09.86					
FAC 2803 DKS	01.74 - 09.86					
FAC 2803 DKSE	01.80 - 07.90					
FAC 2803 DKTD	01.74 - 09.91					
FAD 2805 DKS	01.74 - 09.86					
FAD 2805 DKTD	01.74 - 06.86					
FAD 2825 DKTD	01.74 - 09.91					
FAD 2825 DKTD	06.86 - 09.91					
FAD 2825 DKV	05.83 - 09.91					
FAG 2800 DKV,FAR 2804 DKXE,FAS 2803 DKXE,DKSE,DKV	05.83 - 09.91					
FAR 2804 DKSE,FAS 2800 DKT	01.80 - 09.86					
FAS 2800 DKA	01.74 - 11.80					
FAS 2803 DKS	06.86 - 09.91					
FAS 2803 DKTD	06.86 - 09.91					
FAT 2800 DKA	01.74 - 11.80					
FAT 2800 DKS	01.74 - 09.86					
FAT 2800 DKT	01.74 - 11.80					
FAT 2800 DKTD	01.74 - 09.86					
FAT 2805 DKS,FAT 2825 DKS	06.86 - 09.91					
FAT 2805 DKTD,FAT 2825 DKTD	06.86 - 09.91					
FMD 2805 DKTD,FMD 2825 DKTD	01.74 - 09.86					
FMD 2805 DKTD,FMD 2825 DKTD	06.86 - 09.91					
FMD 2825 DKV	05.83 - 09.91					
FT 2800 DKA	01.74 - 11.80					
FT 2800 DKT	01.74 - 11.80					
FT 2800 DKTD	01.74 - 09.86					
FT 2805 DKTD	06.86 - 09.91					
FTS 2800 DKA	01.74 - 11.80					
FTS 2800 DKS	01.74 - 09.86					
FTS 2800 DKT	01.74 - 11.80					
FTS 2800 DKTD	01.74 - 09.86					
FTS 2803 DKS	06.86 - 09.91					
FTS 2803 DKTD	06.86 - 09.91					
FTT 2800 DKA	01.74 - 11.80					
FTT 2800 DKS	01.74 - 09.86					
FTT 2800 DKT	01.74 - 11.80					
FTT 2800 DKTD	01.74 - 09.86					
FTT 2805 DKS,FTT 2815 DKS,FTT2825 DKS	06.86 - 09.91					
FTT 2805 DKTD	06.86 - 09.91					





		CODE				
--	--	------	--	---	---	---

DAF





F 2800 09.73 - 09.91

FA 2800 DKSE FL 2805 DKS FT 2800 DKTD FTT 2816 DKS	01.80 - 09.86	-SE1160, DK, -S, -TL, -TD, DKS1160E	 3400 700 305	430 10	Getr. / GBox: ZF 16S-151/181/221	
			 3482 118 031	GMF430		
			 1878 002 706	420GTZ		
			 3151 000 515	KZIS-4		
			 3482 018 132 #	420		Getr. / GBox: ZF 16S-151/181/221
			3482 119 031	430		Getr. / GBox: ZF 16S-151/181/221
			 1878 086 741	GMF430		
			 1878 086 741	420 10		Getr. / GBox: ZF 16S-151/181/221
FT 2800 DKS FT 2800 DKSE,FT 2800DKXE,FT 2800 DKV FT 2805 DKS	01.74 - 09.86 01.80 - 09.91 06.86 - 09.91	DKXE1160, DKV1160, DKS1160, DKS1160E	 3400 700 305	430 10	Getr. / GBox: ZF 16S-151/181/221	
			 3482 118 031	GMF430		
			 1878 002 706	420GTZ		
			 3151 000 515	KZIS-4		
			 3482 018 132 #	420		Getr. / GBox: ZF 16S-151/181/221
			3482 119 031	430		Getr. / GBox: ZF 16S-151/181/221
			 1878 086 741	GMF430		
			 1878 086 741	420 10		Getr. / GBox: ZF 16S-151/181/221
			 3482 119 032	430	Getr. / GBox: ZF 16S-130	
			 1878 003 269	GMF430		
			 1878 003 269	420 10	Getr. / GBox: ZF 16S-130	
			 1878 003 269	420GTZ		
			 3151 000 395	KZIS-4	Getr. / GBox: ZF 16S-130	





















F 2900 01.90 - 10.93

FA 2900 KV FAD 2900 KV FAG 2900 KV,FAR 2900 KV,FAS 2900 KV FMD 2900 KV FT 2900 KV	01.90 - 10.93	KV1160	 3400 124 601	430 10	Getr. / GBox: ZF 16S-151/181/221
			 3482 119 031	GMF430	
			 1878 086 741	430WGTZ	
			 3151 000 395	KZIS-4	

F 3200 01.90 - 10.93

FA 3200 KS FAB 3200 KS,FAR 3200 KS,FAS 3200 KS FAD 3200 KS FAT 3200 KV FMD 3200 KS FT 3200 KS	01.90 - 10.93	KS1160	 3400 124 601	430 10	Getr. / GBox: ZF 16S-151/181/221
			 3482 119 031	GMF430	
			 1878 086 741	430WGTZ	
			 3151 000 395	KZIS-4	









DAF

F 3300		06.81 - 09.91					
F 3300		DKX1160	 3482 118 031	430 GMF430			
			 1878 002 706	420 10 420GTZ			
			 3151 000 515	KZIS-4			
					 3482 018 132 #	420 GMF420	Getr. / GBox: ZF 16S-151/181/221
					3482 119 031	430 GMF430	Getr. / GBox: ZF 16S-151/181/221
					 1878 086 741	420 10 430WGTZ	Getr. / GBox: ZF 16S-151/181/221
					 3151 182 233	KZI-5	Getr. / GBox: ZF 16S-151/181/221
					 3482 119 032	430 GMF430	Getr. / GBox: ZF 16S-130
					 1878 003 269	420 10 420GTZ	Getr. / GBox: ZF 16S-130
					 3151 000 395	KZIS-4	Getr. / GBox: ZF 16S-130
F 3300 ATi		DKX1160ATi	 3400 125 701	430 10 GMF430			
			 3482 119 031  1878 003 269  3151 000 395	420GTZ KZIS-4			
					 3482 018 132 ●#	420 GMF420	
					 3482 018 132 #	420 GMF420	Getr. / GBox: ZF 16S-151/181/221
					 1878 086 741	420 10 430WGTZ	Getr. / GBox: ZF 16S-151/181/221
					 3151 182 233	KZI-5	Getr. / GBox: ZF 16S-151/181/221
					 3482 119 032	430 GMF430	Getr. / GBox: ZF 16S-130
					 1878 003 269	420 10 420GTZ	Getr. / GBox: ZF 16S-130
					 3151 000 395	KZIS-4	Getr. / GBox: ZF 16S-130
					FA 3300 DKX,FA 3305 DKX FA 3300 DKX,FA 3305 DKX FAB 3305 DKX,FAG 3300 DKX,FAR 3300 DKX,FAS 3303 DKX FAC 3303 DKX FAC 3303 DKX FAD 3325 DKX FAD 3325 DKX FAG 3300 DKX,FAR 3304 DKX,FAS 3303 DKX FAT 3325 DKX FAT 3325 DKX FT 3305 DKX FT 3305 DKX FTG 3300 DKX,FTS 3300 DKX FTG 3300 DKX,FTS 3303 DKX FTT 3325 DKX FTT 3325 DKX	06.81 - 09.86 06.85 - 09.91 06.81 - 09.86 06.81 - 09.86 06.85 - 09.91 06.85 - 09.91 06.85 - 09.91 06.81 - 09.86 06.85 - 09.91 06.81 - 09.86 06.85 - 09.91 06.81 - 09.86 06.85 - 09.91 06.81 - 09.86 06.85 - 09.91 06.81 - 09.86 06.85 - 09.91	DKX1160, DKX1160ATi



		CODE				
--	--	------	--	---	---	---

DAF











F 3600 06.85 - 09.91

F 3600		DKZ1160ATi	 3400 124 601 ⊗ 3482 119 031 ⊗ 1878 086 741 ⊙ 3151 000 395	430 10 GMF430 430WGTZ KZIS-4			
			 3482 018 132 ●#	420 GMF420			
					 3482 018 132 #	420 GMF420	Getr. / GBox: ZF 16S-151/181/221
					 1878 086 741	420 10 430WGTZ	Getr. / GBox: ZF 16S-151/181/221
					 3151 182 233	KZI-5	Getr. / GBox: ZF 16S-151/181/221
					 3482 119 032	430 GMF430	Getr. / GBox: ZF 16S-130
					 1878 003 269	420 10 420GTZ	Getr. / GBox: ZF 16S-130
					 3151 000 395	KZIS-4	Getr. / GBox: ZF 16S-130
FA 3605 DKZ FA 3605 DKZE FAC 3603 DKZ FAG 3600 DKZ,FAR 3604 DKZ,FAS 3603 DKZ FAR 3604 DKZE,FAS 3603 DKZE FT 3605 DKZ FT 3605 DKZE FTG 3600 DKZ,FTS 3603 DKZ FTT 3625 DKZ	06.85 - 09.91 06.85 - 09.91 06.85 - 09.91 06.85 - 09.91 06.85 - 09.91 06.85 - 09.91 06.85 - 09.91 06.85 - 09.91	DKZ1160ATi, DKZE1160	 3400 124 601 ⊗ 3482 119 031 ⊗ 1878 086 741 ⊙ 3151 000 395	430 10 GMF430 430WGTZ KZIS-4	Getr. / GBox: ZF 16S-151/181/221		

N 2800

NAT 2826 DKS	01.81 - 09.91	DKS1160	 3482 118 031	430 GMF430	
			 1878 003 269	420 10 420GTZ	

N 3300

NAT 3326 DKX	01.81 - 09.91	DKX1160	 3482 118 031	430 GMF430	
			 1878 002 706	420 10 420GTZ	
			 3151 000 515	KZIS-4	
			 3482 018 132 #	420 GMF420	Getr. / GBox: ZF 16S-151/181/221
				 3482 119 031	430 GMF430
			 1878 086 741	420 10 430WGTZ	Getr. / GBox: ZF 16S-151/181/221
			 3151 182 233	KZI-5	Getr. / GBox: ZF 16S-151/181/221
			 3482 119 032	430 GMF430	Getr. / GBox: ZF 16S-130
			 1878 003 269	420 10 420GTZ	Getr. / GBox: ZF 16S-130
			 3151 000 395	KZIS-4	Getr. / GBox: ZF 16S-130























SHERPA / FREIGHT ROVER

1,7	01.85 -		 3082 956 001	242 MF242	->Chass. 271675
			 1878 600 863	242 23 242TP	->Chass. 271675
			 1863 600 128	GR1	->Chass. 271675
1,7	- 03.89		 1850 480 049	240 M240	Chass. 271676->
			 1878 600 863	242 23 242TP	Chass. 271676->
			 1863 600 128	GR1	Chass. 271676->















		CODE				
--	--	------	--	---	---	---

DAF

SHERPA / FREIGHT ROVER

1,8 D	01.85-09.86		 3082 956 001	242 MF242		
			 1878 600 863	242 23 242TP		
			 1863 600 128	GR1		
2,0	01.83-04.86		 3082 956 001 	242 MF242		
			 1878 600 863 	242 23 242TP		
			 1863 600 128 	GR1		
2,0 2,0 D	05.86-03.89 09.86-03.89		 1850 480 049 	240 M240		
			 1878 600 863 	242 23 242TP		
			 1863 600 128 	GR1		
2,5 D	01.83-03.89		 3000 950 701	242 23		
			 3082 973 001	MF242		
			 1878 600 863	242TP		
2,5 D 2,5 TD	04.89- 04.89-	Peugeot	 3000 840 101	235 10		
			 3082 737 001	MFZ235		
			 1862 642 001	235CP		
			 3151 600 548	KZAS-1		





T - Serie

T 15/2 DF T 1600 DF		DF615	 1882 137 307 #	310 GF310		
			 1882 110 542 ▲	350 GF350	Getr. / GBox: AK/S 5-35-2	
T 18 DM TB 160/163 DS			 1878 001 071	350 10 350GTZ	Getr. / GBox: AK/S 5-35-2	
			 3482 060 132	350 MF350		
T 500 T 505			 1861 777 037	350 10 350GTD		
			 3482 083 113	430 MFZ430		
T 575			 1878 002 878	420 10 420GTZ		
			 1878 001 138	420 10 420GTZ		
T 2200 DKD		DKTL615	 3151 000 515	KZIS-4		
			 1878 001 138	420 10 420GTZ		
T 2400 DK TE 2400 DK		DK/DKA1160	 3151 000 515	KZIS-4		
			 3482 000 953 ●	350 GMF350X	Getr. / GBox: 4-WG 181	
TT 1303 DH		DH825	 1878 001 070	350 10 350GTZ	Getr. / GBox: 4-WG 181	
			 3151 000 515	KZIS-4	Getr. / GBox: 4-WG 181	

V









V 1600 DD V 1700 DF V 1700 DSD			 1882 110 542 ▲	350 GF350	Getr. / GBox: AK/S 5-35-2	
			 1878 001 071	350 10 350GTZ	Getr. / GBox: AK/S 5-35-2	
V 2400 DK VE 2400 DK		DK/DKA1160	 1878 001 138	420 10 420GTZ		
			 3151 000 515	KZIS-4		







LF 45 01.01 -

45.170		BE123C	 3400 700 353 #	362 10	Getr. / GBox: ZF 5S-42	(42)
			 3482 000 419	MF362	Länderausführung: Groß Britannien / Country-spec.	
			 1878 079 331	362WGTZ	model: Great Britain	
			 3151 000 395	KZIS-4		

		CODE				
--	--	------	--	---	---	---















DAF

LF 45		01.01 -					
FA 45.140 FA 45.160	05.06- 05.06-	FR118S1, FR103S1		3400 700 398 ⊗ 3482 000 859 ⊗ 1878 005 601 ⊙ 3151 000 397	362 10 MF362 362WGTZ KZIS-4	Getr. / GBox: ZF 5S-42 Euro 5 / Euro 5	(17)
				3400 700 375 ⊗ 3482 000 419 ⊗ 1878 004 100 ⊙ 3151 000 651	362 10 MF362 362WGTZ KZIS-4		
FA 45.150 FA 45.170 FA 45.180 FA 45.220	01.01- 01.01- 01.01- 01.01-	BE110C, BE123C, CE162C, CE136C		3400 700 307 ⊗ 3482 000 419 ⊗ 1878 079 331 ⊙ 3151 000 397	362 10 MF362 362WGTZ KZIS-4	Getr. / GBox: ZF 5S-42	
				3400 700 308 ⊗ 3482 123 839 ⊗ 1878 000 036 ⊙ 3151 000 395	395 10 MF395 395WGTZ KZIS-4	Getr. / GBox: ZF 6S-850	
FA 45.160 FA 45.180	05.06- 05.06-	FR118S1, FR136S1		3400 700 375 ⊗ 3482 000 419 ⊗ 1878 004 100 ⊙ 3151 000 651	362 10 MF362 362WGTZ KZIS-4		
FA 45.220 FA 45.250	05.06- 03.06-	GR165S1, GR184S1		3400 700 523 ■ ⊗ 3482 000 474 ⊗ 1878 007 279 ⊙ 3151 000 651	395 10 MF395 395WGTZ KZIS-4	XTend Getr. / GBox: ZF Nabenprofil / Hub Profile: 38,2x44,5-10N Nur zusammen verbauen / Only install together	(48) (53)
				3400 700 376 ⊗ 3482 000 474 ⊗ 1878 007 279 ⊙ 3151 000 651	395 10 MF395 395WGTZ KZIS-4	Getr. / GBox: ZF	
				3400 700 473 ⊗ 3482 000 474 ⊗ 1878 005 599 ⊙ 3151 000 651	395 10 MF395 395WGTZ KZIS-4	Getr. / GBox: ZF 6S/800, 6S/1000 Euro 5 / Euro 5	(17)
				3400 700 524 ■ ⊗ 3482 000 474 ⊗ 1878 005 599 ⊙ 3151 000 395	395 10 MF395 395WGTZ KZIS-4	XTend Getr. / GBox: Eaton Nabenprofil / Hub Profile: 38,2x44,5-10N Nur zusammen verbauen / Only install together	(48) (53)
				3400 700 476 ⊗ 3482 000 474 ⊗ 1878 005 599 ⊙ 3151 000 395	395 10 MF395 395WGTZ KZIS-4	Getr. / GBox: Eaton Euro 5 / Euro 5	(17)



LF 55		01.01 -					
55.170		BE123C		3400 700 353 # ⊗ 3482 000 419 ⊗ 1878 079 331 ⊙ 3151 000 395	362 10 MF362 362WGTZ KZIS-4	Getr. / GBox: ZF 6S-850 Länderausführung: Groß Britannien / Country-spec. model: Great Britain	(42)
FA 55.170 FA 55.180 FA 55.220 FT 55.180 FT 55.220	01.01- 01.01- 01.01- 01.01- 01.01-	BE123C, CE162C, CE136C		3400 700 308 ⊗ 3482 123 839 ⊗ 1878 000 036 ⊙ 3151 000 395	395 10 MF395 395WGTZ KZIS-4	Getr. / GBox: ZF 6S850	
				3400 700 527 ●■ ⊗ 3482 123 839 ⊗ 1878 000 294 ⊙ 3151 000 395	395 10 MF395 395WGTZ KZIS-4	XTend Getr. / GBox: ZF 6S850 Nabenprofil / Hub Profile: 30,7x38,4-10N Nur zusammen verbauen / Only install together	(48) (53)
				3400 700 320 ⊗ 3482 123 839 ⊗ 1878 000 294 ⊙ 3151 000 395	395 10 MF395 395WGTZ KZIS-4	Getr. / GBox: Eaton 6309	
				3400 700 519 ●■ ⊗ 3482 123 839 ⊗ 1878 000 294 ⊙ 3151 000 395	395 10 MF395 395WGTZ KZIS-4	XTend Getr. / GBox: Eaton 6309 Nabenprofil / Hub Profile: 38,2x44,5-10N Nur zusammen verbauen / Only install together	(48) (53)
FA 55.180	05.06-	FR136S1		3400 700 375 ⊗ 3482 000 419 ⊗ 1878 004 100 ⊙ 3151 000 651	362 10 MF362 362WGTZ KZIS-4		

DAF

LF 55 01.01 -

















FA 55.220 FA 55.250 FAN 55.220 FAN 55.250 FT 55.220 FT 55.250	05.06-	GR165S1, GR184S1		3400 700 473 ⊗ 3482 000 474 ⊗ 1878 005 599 ⊙ 3151 000 651	395 10 MF395 395WGTZ KZIS-4	Getr. / GBox: ZF 6S/800, 6S/1000 Euro 5 / Euro 5	(17)
	05.06-			3400 700 476 ⊗ 3482 000 474 ⊗ 1878 005 599 ⊙ 3151 000 395	395 10 MF395 395WGTZ KZIS-4	Getr. / GBox: Eaton Euro 5 / Euro 5	(17)
	05.06-			3400 700 523 ■	395 10	XTend Nabenprofil / Hub Profile: 38,2x44,5-10N Je nach Kundenwunsch mit unterschiedlicher Kupplung / Equipped with different clutch according to customer requirement Nur zusammen verbauen / Only install together	(48) (35)
	05.06-			3400 700 376 ⊗ 3482 000 474 ⊗ 1878 007 279 ⊙ 3151 000 651	395 10 MF395 395WGTZ KZIS-4	Je nach Kundenwunsch mit unterschiedlicher Kupplung / Equipped with different clutch according to customer requirement	(35)
FA 55.250 FT 55.250	01.01 - 01.01 -	CE184C		3400 700 308 ⊗ 3482 123 839 ⊗ 1878 000 036 ⊙ 3151 000 395	395 10 MF395 395WGTZ KZIS-4	Getr. / GBox: ZF 6S850	
				3400 700 527 ■	395 10	XTend Getr. / GBox: ZF 6S850 Nabenprofil / Hub Profile: 30,7x38,4-10N Nur zusammen verbauen / Only install together	(48) (53)
				3400 700 473 ⊗ 3482 000 474 ⊗ 1878 005 599 ⊙ 3151 000 651	395 10 MF395 395WGTZ KZIS-4	Getr. / GBox: ZF 6S/800, 6S/1000 Euro 5 / Euro 5	(17)
				3400 700 476 ⊗ 3482 000 474 ⊗ 1878 005 599 ⊙ 3151 000 395	395 10 MF395 395WGTZ KZIS-4	Getr. / GBox: Eaton Euro 5 / Euro 5	(17)
				3400 700 320 ⊗ 3482 123 839 ⊗ 1878 000 294 ⊙ 3151 000 395	395 10 MF395 395WGTZ KZIS-4	Getr. / GBox: Eaton 6309	
				3400 700 519 ■	395 10	XTend Getr. / GBox: Eaton 6309 Nabenprofil / Hub Profile: 38,2x44,5-10N Nur zusammen verbauen / Only install together	(48) (53)
FA 55.280 FA 55.290 FAN 55.290 FT 55.280 FT 55.290	05.06 - 05.06 - 05.06 - 05.06 - 05.06 -	GR210S1		3400 700 523 ■	395 10	XTend Nabenprofil / Hub Profile: 38,2x44,5-10N Je nach Kundenwunsch mit unterschiedlicher Kupplung / Equipped with different clutch according to customer requirement Nur zusammen verbauen / Only install together	(48) (35)
				3400 700 376 ⊗ 3482 000 474 ⊗ 1878 007 279 ⊙ 3151 000 651	395 10 MF395 395WGTZ KZIS-4	Je nach Kundenwunsch mit unterschiedlicher Kupplung / Equipped with different clutch according to customer requirement	(35)
FAN 55.250	05.06 -	CE184C		3400 700 473 ⊗ 3482 000 474 ⊗ 1878 005 599 ⊙ 3151 000 651	395 10 MF395 395WGTZ KZIS-4	Getr. / GBox: ZF 6S/800, 6S/1000 Euro 5 / Euro 5	(17)
				3400 700 476 ⊗ 3482 000 474 ⊗ 1878 005 599 ⊙ 3151 000 395	395 10 MF395 395WGTZ KZIS-4	Getr. / GBox: Eaton Euro 5 / Euro 5	(17)

LF 05.13 -

FA 150	05.13 -	PX-5112		3400 700 465 ⊗ 3482 000 859 ⊗ 1878 005 601 ⊙ 3151 000 651	362 10 MF362 362WGTZ KZIS-4	Getr. / GBox: 6 S 700 Getr. / GBox: 6 AS 700 Euro 6 / Euro 6	(18)
				3400 700 464 ⊗ 3482 000 859 ⊗ 1878 005 600 ⊙ 3151 000 651	362 10 MF362 362WGTZ KZIS-4	Getr. / GBox: 6 S 800 Getr. / GBox: 6 AS 800 Euro 6 / Euro 6	(18)
				3400 700 603 ⊗ 3482 001 166 ⊗ 1878 007 172 ⊙ 3151 000 397	350 MF350 350WGTZ KZIS-4	Getr. / GBox: S5-42 Euro 6 / Euro 6	(18)

		CODE				
--	--	------	--	---	---	---

DAF

LF 05.13 -						
FA 180	05.13-	PX-5135	 3400 700 465 ⊗ 3482 000 859 ⊗ 1878 005 601 ⊙ 3151 000 651	362 10 MF362 362WGTZ KZIS-4	Getr. / GBox: 6 S 700 Getr. / GBox: 6 AS 700 Euro 6 / Euro 6	(18)
			 3400 700 464 ⊗ 3482 000 859 ⊗ 1878 005 600 ⊙ 3151 000 651	362 10 MF362 362WGTZ KZIS-4	Getr. / GBox: 6 S 800 Getr. / GBox: 6 AS 800 Euro 6 / Euro 6	(18)
			 3400 700 603 ⊗ 3482 001 166 ⊗ 1878 007 172 ⊙ 3151 000 397	350 MF350 350WGTZ KZIS-4	Getr. / GBox: S5-42 Euro 6 / Euro 6	(18)
FA 210	05.13-	PX-5157	 3400 700 465 ⊗ 3482 000 859 ⊗ 1878 005 601 ⊙ 3151 000 651	362 10 MF362 362WGTZ KZIS-4	Getr. / GBox: 6 S 700 Getr. / GBox: 6 AS 700 Euro 6 / Euro 6	(18)
			 3400 700 464 ⊗ 3482 000 859 ⊗ 1878 005 600 ⊙ 3151 000 651	362 10 MF362 362WGTZ KZIS-4	Getr. / GBox: 6 S 800 Getr. / GBox: 6 AS 800 Euro 6 / Euro 6	(18)
			 3400 700 603 ⊗ 3482 001 166 ⊗ 1878 007 172 ⊙ 3151 000 397	350 MF350 350WGTZ KZIS-4	Getr. / GBox: S5-42 Euro 6 / Euro 6	(18)
FA 220 FA 220 FT 220 FT 250 FT 280	05.13- 05.13- 05.13- 05.13- 05.13-	PX-7164	 3400 700 473 ⊗ 3482 000 474 ⊗ 1878 005 599 ⊙ 3151 000 651	395 10 MF395 395WGTZ KZIS-4	Getr. / GBox: 6S800 / 6S1000 Getr. / GBox: 9S1110TD Getr. / GBox: 6AS800 / 6AS1000 Euro 6 / Euro 6	(18)
FA 250 FA 250	05.13- 05.13-	PX-7186	 3400 700 473 ⊗ 3482 000 474 ⊗ 1878 005 599 ⊙ 3151 000 651	395 10 MF395 395WGTZ KZIS-4	Getr. / GBox: 6S800 / 6S1000 Getr. / GBox: 9S1110TD Getr. / GBox: 6AS800 / 6AS1000 Euro 6 / Euro 6	(18)
FA 280 FA 280	05.13- 05.13-	PX-7208	 3400 700 473 ⊗ 3482 000 474 ⊗ 1878 005 599 ⊙ 3151 000 651	395 10 MF395 395WGTZ KZIS-4	Getr. / GBox: 6S800 / 6S1000 Getr. / GBox: 9S1110TD Getr. / GBox: 6AS800 / 6AS1000 Euro 6 / Euro 6	(18)
FA 310 FA 310	05.13- 05.13-	PX-7231	 3400 700 473 ⊗ 3482 000 474 ⊗ 1878 005 599 ⊙ 3151 000 651	395 10 MF395 395WGTZ KZIS-4	Getr. / GBox: 6S800 / 6S1000 Getr. / GBox: 9S1110TD Getr. / GBox: 6AS800 / 6AS1000 Euro 6 / Euro 6	(18)
65 01.93 - 02.98						
FA 65.180 FA 65.210 FA 65.240 FAV 65.180 FAV 65.210	03.93-02.98 03.93-02.98 05.96-02.98 03.93-02.98 03.93-02.98	NS133L, NS177M, NS156M, NS133M, NS156L	 3400 700 405 ⊗ 3482 000 419 ⊗ 1878 044 631 ⊙ 3151 000 395	362 10 MF362 362GTZ KZIS-4	Getr. / GBox: 6S850	
			 3400 700 428 # ⊗ 3482 000 419 ⊗ 1878 044 631 ⊙ 3151 199 001	362 10 MF362 362GTZ KZIS-3	Getr. / GBox: ZF 6S-36	
			 3482 060 132	350 MF350	Getr. / GBox: ZF 6S-36 Getr. / GBox: ZF 9S-75	
			 1861 777 043	350 10 350GTD	Getr. / GBox: ZF 6S-36 Getr. / GBox: ZF 9S-75	
			 3151 199 001	KZIS-3	Getr. / GBox: ZF 6S-36 Getr. / GBox: ZF 9S-75	
			 3400 700 318 # ⊗ 3482 000 419 ⊗ 1878 002 071 ⊙ 3151 000 395	362 10 MF362 362GTZ KZIS-4	Getr. / GBox: ZF 9S-75	
65 CF 02.98 - 12.00						
FA 65 CF 180 FA 65 CF 210 FA 65 CF 240 FAV 65 CF 180 FAV 65 CF 210	02.98-12.00 02.98-12.00 02.98-12.00 02.98-12.00 02.98-12.00	NS177M, NS156M, NS133M	 3400 700 405 ⊗ 3482 000 419 ⊗ 1878 044 631 ⊙ 3151 000 395	362 10 MF362 362GTZ KZIS-4	Fahrzeuge können mit unterschiedlichen Komponenten bestückt sein. / Vehicles may be fitted with different components	(23)











































		CODE				
--	--	------	--	---	---	---

DAF

65 CF 02.98 - 12.00

FAV 65 CF 240	02.98-12.00	NS177M	 3400 700 319  3482 119 032  1878 027 231  3151 000 395	430 10 GMF430 400GTZ KZIS-4		
			 3400 700 504 ■	430 10	XTend Getr. / GBox: 8/16S151 Nabenprofil / Hub Profile: 41,1x50,8-10N Nur zusammen verbauen / Only install together	(48) (53)
			 3482 114 032	430 GMFZ430N	für Nebenantrieb / for PTO	(82)
			 1878 054 933	430 10 430GTZ	für Nebenantrieb / for PTO	(82)
			 3151 263 031	KZIZ-6	für Nebenantrieb / for PTO	(82)









CF 65 01.01 - 05.13

FA 65.180 FA 65.220	01.01-05.13 01.01-05.13	CE162C, CE136C	 3400 700 308  3482 123 839  1878 000 036  3151 000 395	395 10 MF395 395WGTZ KZIS-4	Getr. / GBox: ZF-6S-850	
			 3400 700 527 ■	395 10	XTend Getr. / GBox: ZF-6S-850 Nabenprofil / Hub Profile: 30,7x38,4-10N Nur zusammen verbauen / Only install together	(48) (53)
			 3400 700 316  3482 123 839  1878 000 296  3151 000 395	395 10 MF395 395WGTZ KZIS-4	Getr. / GBox: Eaton 6309	
			 3400 700 519 ■	395 10	XTend Getr. / GBox: Eaton 6309 Nabenprofil / Hub Profile: 38,2x44,5-10N Nur zusammen verbauen / Only install together	(48) (53)
FA 65.220	05.06-05.13	GR165S1	 3400 700 523 ■	395 10	XTend Getr. / GBox: ZF 6 S 1000 Nabenprofil / Hub Profile: 38,2x44,5-10N Nur zusammen verbauen / Only install together	(48) (53)
			 3400 700 376  3482 000 474  1878 007 279  3151 000 651	395 10 MF395 395WGTZ KZIS-4	Getr. / GBox: ZF 6 S 1000	
			 3400 700 473  3482 000 474  1878 005 599  3151 000 651	395 10 MF395 395WGTZ KZIS-4	Getr. / GBox: ZF 6S/800, 6S/1000 Euro 5 / Euro 5	(17)
			 3400 700 524 ■	395 10	XTend Getr. / GBox: Eaton Nabenprofil / Hub Profile: 38,2x44,5-10N Nur zusammen verbauen / Only install together	(48) (53)
			 3400 700 476  3482 000 474  1878 005 599  3151 000 395	395 10 MF395 395WGTZ KZIS-4	Getr. / GBox: Eaton Euro 5 / Euro 5	(17)
FA 65.250	01.01-05.13	CE184C	 3400 700 308  3482 123 839  1878 000 036  3151 000 395	395 10 MF395 395WGTZ KZIS-4	Getr. / GBox: ZF-6S-850	
			 3400 700 527 ■	395 10	XTend Getr. / GBox: ZF-6S-850 Nabenprofil / Hub Profile: 30,7x38,4-10N Nur zusammen verbauen / Only install together	(48) (53)
			 3400 700 473  3482 000 474  1878 005 599  3151 000 651	395 10 MF395 395WGTZ KZIS-4	Getr. / GBox: ZF 6S/800, 6S/1000 Euro 5 / Euro 5	(17)
			 3400 700 316  3482 123 839  1878 000 296  3151 000 395	395 10 MF395 395WGTZ KZIS-4	Getr. / GBox: Eaton 6309	
			 3400 700 519 ■	395 10	XTend Getr. / GBox: Eaton 6309 Nabenprofil / Hub Profile: 38,2x44,5-10N Nur zusammen verbauen / Only install together	(48) (53)
			 3400 700 476  3482 000 474  1878 005 599  3151 000 395	395 10 MF395 395WGTZ KZIS-4	Getr. / GBox: Eaton Euro 5 / Euro 5	(17)



		CODE					
--	--	------	--	--	---	---	---

DAF

CF 65 01.01 - 05.13

FA 65.250	05.06 - 05.13	GR184S1		3400 700 523 ■	395 10	XTend Getr. / GBox: ZF Nabenprofil / Hub Profile: 38,2x44,5-10N Nur zusammen verbauen / Only install together	(48) (53)
				3400 700 376 ⊗ 3482 000 474 ⊗ 1878 007 279 ⊙ 3151 000 651	395 10 MF395 395WGTZ KZIS-4	Getr. / GBox: ZF	
				3400 700 473 ⊗ 3482 000 474 ⊗ 1878 005 599 ⊙ 3151 000 651	395 10 MF395 395WGTZ KZIS-4	Getr. / GBox: ZF 6S/800, 6S/1000 Euro 5 / Euro 5	(17)
				3400 700 524 ■	395 10	XTend Getr. / GBox: Eaton Nabenprofil / Hub Profile: 38,2x44,5-10N Nur zusammen verbauen / Only install together	(48) (53)
				3400 700 476 ⊗ 3482 000 474 ⊗ 1878 005 599 ⊙ 3151 000 395	395 10 MF395 395WGTZ KZIS-4	Getr. / GBox: Eaton Euro 5 / Euro 5	(17)
FA 65.280	05.06 - 05.13	GR210S1		3400 700 523 ■	395 10	XTend Getr. / GBox: ZF Nabenprofil / Hub Profile: 38,2x44,5-10N Nur zusammen verbauen / Only install together	(48) (53)
				3400 700 376 ⊗ 3482 000 474 ⊗ 1878 007 279 ⊙ 3151 000 651	395 10 MF395 395WGTZ KZIS-4	Getr. / GBox: ZF	
				3400 700 524 ■	395 10	XTend Getr. / GBox: Eaton Nabenprofil / Hub Profile: 38,2x44,5-10N Nur zusammen verbauen / Only install together	(48) (53)









75 07.92 - 02.98







FA 75.240	07.92 - 02.98	RS180, RS180M, RS180L		3400 124 701 ⊗ 3482 017 034 ⊗ 1878 000 105 ⊙ 3151 000 395	380 10 GMF380 380GTZ KZIS-4		
FAG 75.240,FAN 75.240	07.92 - 02.98						
FAR 75.240,FAS 75.240	07.92 - 02.98						
FAV 75.240	07.92 - 02.98						
FT 75.240	07.92 - 02.98						
FA 75.270	07.92 - 02.98	RS222, RS200L, RS222M, RS200M, RS222L, RS200		3400 700 319 ⊗ 3482 119 032 ⊗ 1878 027 231 ⊙ 3151 000 395	430 10 GMF430 400GTZ KZIS-4		
FA 75.300	07.92 - 02.98						
FAG 75.270,FAN 75.270	07.92 - 02.98						
FAG 75.300,FAN 75.300	07.92 - 02.98						
FAR 75.270,FAS 75.270	07.92 - 02.98						
FAR 75.300,FAS 75.300	07.92 - 02.98						
FAT 75.270	07.92 - 02.98						
FAV 75.270	07.92 - 02.98						
FT 75.270	07.92 - 02.98						
FT 75.300	07.92 - 02.98						

75 CF 02.98 - 12.00

FA 75 CF 250	02.98 - 12.00	PF183M, PR183S, PF212M		3400 700 319 ⊗ 3482 119 032 ⊗ 1878 027 231 ⊙ 3151 000 395	430 10 GMF430 400GTZ KZIS-4			
FA 75 CF 290	02.98 - 12.00							
FAG 75 CF 250,FAN 75 CF 250	02.98 - 12.00				3400 700 504 ■	430 10	XTend Getr. / GBox: 8/16S151 Nabenprofil / Hub Profile: 41,1x50,8-10N Nur zusammen verbauen / Only install together	(48) (53)
FAG 75 CF 290,FAN 75 CF 290	02.98 - 12.00							
FAR 75 CF 250,FAS 75 CF 250	02.98 - 12.00							
FAR 75 CF 290,FAS 75 CF 290	02.98 - 12.00							
FAT 75 CF 250	02.98 - 12.00				3482 114 032	430 GMFZ430N	für Nebenantrieb / for PTO	(82)
FAT 75 CF 290	02.98 - 12.00				1878 054 933	430 10 430GTZ	für Nebenantrieb / for PTO	(82)
FAV 75 CF 250	06.01 -				3151 263 031	430 10 KZIS-6	für Nebenantrieb / for PTO	(82)















DAF

75 CF		02.98 - 12.00						
FA 75 CF 320	02.98 - 12.00	PF235M		3400 122 101 ⊗ 3482 083 032 ⊗ 1878 054 933 ⊙ 3151 000 034	430 10 MFZ430 430GTZ KZISZ-5	Getr. / GBox: 8/16S151		
FAG 75 CF 320, FAN 75 CF 320	02.98 - 12.00			3400 700 504 ●■	430 10	XTend Getr. / GBox: 8/16S151 Nabenprofil / Hub Profile: 41,1x50,8-10N Nur zusammen verbauen / Only install together		(48) (53)
FAR 75 CF 320, FAS 75 CF 320	02.98 - 12.00			3482 114 032	430 GMFZ430N	für Nebenantrieb / for PTO		(82)
FAT 75 CF 320	02.98 - 12.00			1878 054 933	430 10 430GTZ	für Nebenantrieb / for PTO		(82)
				3151 263 031	430 10 KZISZ-6	für Nebenantrieb / for PTO		(82)
FT 75 CF 250	02.98 - 12.00	PF183M, PF212M		3400 700 319 ⊗ 3482 119 032 ⊗ 1878 027 231 ⊙ 3151 000 395	430 10 GMF430 400GTZ KZIS-4			
FT 75 CF 290	02.98 - 12.00			3400 700 504 ■	430 10	XTend Getr. / GBox: 8/16S151 Nabenprofil / Hub Profile: 41,1x50,8-10N Nur zusammen verbauen / Only install together		(48) (53)
FT 75 CF 320	02.98 - 12.00	PF235M		3400 122 101 ⊗ 3482 083 032 ⊗ 1878 054 933 ⊙ 3151 000 034	430 10 MFZ430 430GTZ KZISZ-5	Getr. / GBox: 8/16S151		
				3400 700 504 ●■	430 10	XTend Getr. / GBox: 8/16S151 Nabenprofil / Hub Profile: 41,1x50,8-10N Nur zusammen verbauen / Only install together		(48) (53)













































CF 75		01.01 - 05.13						
FA 75.250	01.01 - 05.13	PE228C, PR265S, PR228S, PE183C, PR183S		3400 122 101 ⊗ 3482 083 032 ⊗ 1878 054 933 ⊙ 3151 000 034	430 10 MFZ430 430GTZ KZISZ-5	Getr. / GBox: 8S-151/16S-151		
FA 75.250	10.06 - 05.13			3400 700 504 ●■	430 10	XTend Getr. / GBox: 8S-151/16S-151 Nabenprofil / Hub Profile: 41,1x50,8-10N Nur zusammen verbauen / Only install together		(48) (53)
FA 75.310	01.01 - 05.13			3400 700 316 ⊗ 3482 123 839 ⊗ 1878 000 296 ⊙ 3151 000 395	395 10 MF395 395WGTZ KZIS-4	Getr. / GBox: 9S-109/16S109		
FA 75.310	10.06 - 05.13			3400 700 519 ●■	395 10	XTend Getr. / GBox: 9S-109/16S109 Nabenprofil / Hub Profile: 38,2x44,5-10N Nur zusammen verbauen / Only install together		(48) (53)
FA 75.360	10.06 - 05.13			3400 700 368 ⊗ 3482 000 484 ⊗ 1878 003 647 ⊙ 3151 000 493	430 10 MFZ430 430GTZ KZISZ-5	Getr. / GBox: ZF AS-Tronic Euro 5 / Euro 5 für Ausrückgabel mit Rollen / for release fork with rollers		(17) (71)
FAD 75.250	01.01 - 05.13			3400 700 520 ■	395 10	XTend Getr. / GBox: ZF Ecomid ZF 9S - Nabenprofil / Hub Profile: 38,2x44,5-10N Euro 5 / Euro 5 Nur zusammen verbauen / Only install together		(48) (17) (53)
FAG 75.250, FAN 75.250	01.01 - 05.13			3189 600 004		Getr. / GBox: ZF AS Tronic Rollenausführung / roller version		(58)
FAG 75.250, FAN 75.250	01.01 - 05.13							
FAG 75.310, FAN 75.310	01.01 - 05.13							
FAG 75.310, FAN 75.310	01.01 - 05.13							
FAG 75.360, FAN 75.360	01.01 - 05.13							
FAR 75.250, FAS 75.250	10.06 - 05.13							
FAR 75.310, FAS 75.310	01.01 - 05.13							
FAR 75.310, FAS 75.310	01.01 - 05.13							
FAR 75.360, FAS 75.360	10.06 - 05.13							
FAT 75.250	10.06 - 05.13							
FAT 75.250	01.01 - 05.13							
FAT 75.310	01.01 - 05.13							
FAT 75.310	10.06 - 05.13							
FAT 75.360	10.06 - 05.13							
FT 75.250	01.01 - 05.13							
FT 75.250	10.06 - 05.13							
FT 75.310	01.01 - 05.13							
FT 75.310	10.06 - 05.13							
FT 75.360	10.06 - 05.13							

		CODE				
--	--	------	--	---	---	---















































DAF

CF 75		01.01 - 05.13				
FA 75.360 FAD 75.360 FAG 75.360, FAN 75.360 FAR 75.360, FAS 75.360 FAT 75.360 FT 75.360	01.01 - 05.13	PR265S, PE265C	 3400 700 316 ⊗ 3482 123 839 ⊗ 1878 000 296 ⊙ 3151 000 395	395 10 MF395 395WGTZ KZIS-4	Getr. / GBox: 9S-109/16S109 Euro3/Euro4 / Euro3/Euro4	(19)
	01.01 - 05.13		 3400 700 519 ●■	395 10	XTend Getr. / GBox: 9S-109/16S109 Nabenprofil / Hub Profile: 38,2x44,5-10N Euro3/Euro4 / Euro3/Euro4 Nur zusammen verbauen / Only install together	(48) (19) (53)
	01.01 - 05.13		 3400 122 101 ⊗ 3482 083 032 ⊗ 1878 054 933 ⊙ 3151 000 034	430 10 MFZ430 430GTZ KZISZ-5	Getr. / GBox: Ecosplit 3 Euro 3 / Euro 3	(15)
	01.01 - 05.13		 3400 700 504 ●■	430 10	XTend Getr. / GBox: Ecosplit 3 Nabenprofil / Hub Profile: 41,1x50,8-10N Euro 3 / Euro 3 Nur zusammen verbauen / Only install together	(48) (15) (53)
	01.01 - 05.13		 3400 700 361 ⊗ 3482 000 484 ⊗ 1878 003 767 ⊙ 3151 000 034	430 10 MFZ430 430WGTZ KZISZ-5	Getr. / GBox: Ecosplit 3 Euro4/Euro5 / Euro4/Euro5	(20)
	01.01 - 05.13		 3400 700 521 ●■	430 10	XTend Getr. / GBox: Ecosplit 3 Nabenprofil / Hub Profile: 41,1x50,8-10N Euro4/Euro5 / Euro4/Euro5	(48) (20)
			 3400 700 467 ⊗ 3482 000 484 ⊗ 1878 003 767 ⊙ 3151 000 493	430 10 MFZ430 430WGTZ KZISZ-5	Getr. / GBox: Ecosplit 4 Euro 5 / Euro 5	(17)
			 3400 700 522 ●■	430 10	XTend Getr. / GBox: Ecosplit 4 Nabenprofil / Hub Profile: 41,1x50,8-10N Euro 5 / Euro 5 für Ausrückgabel mit Rollen / for release fork with rollers	(48) (17) (71)
			 3400 700 368 ⊗ 3482 000 484 ⊗ 1878 003 647 ⊙ 3151 000 493	430 10 MFZ430 430GTZ KZISZ-5	Getr. / GBox: AS Tronic Euro3/Euro4 / Euro3/Euro4 Euro 5 / Euro 5 für Ausrückgabel mit Rollen / for release fork with rollers	(19) (17) (71)
			 3400 700 522 ●■	430 10	XTend Getr. / GBox: AS Tronic Nabenprofil / Hub Profile: 41,1x50,8-10N Euro3/Euro4 / Euro3/Euro4 für Ausrückgabel mit Rollen / for release fork with rollers	(48) (19) (71)
			 3189 600 004		Getr. / GBox: ZF AS Tronic Rollenausführung / roller version	(58)
	FAR 75.250, FAS 75.250		01.01 - 05.13	PE183C, PR183S	 3400 122 101 ⊗ 3482 083 032 ⊗ 1878 054 933 ⊙ 3151 000 034	430 10 MFZ430 430GTZ KZISZ-5
 3400 700 504 ●■		430 10			XTend Getr. / GBox: 8S-151/16S-151 Nabenprofil / Hub Profile: 41,1x50,8-10N Nur zusammen verbauen / Only install together	(48) (53)
 3400 700 316 ⊗ 3482 123 839 ⊗ 1878 000 296 ⊙ 3151 000 395		395 10 MF395 395WGTZ KZIS-4			Getr. / GBox: 9S-109/16S109	
 3400 700 519 ●■		395 10			XTend Getr. / GBox: 9S-109/16S109 Nabenprofil / Hub Profile: 38,2x44,5-10N Nur zusammen verbauen / Only install together	(48) (53)







DAF

85		07.92 - 02.98				
F 85.300 FA 85.330 FA 85.360 FAD 85.330 FAD 85.360 FAG 85.330 FAR 85.360, FAS 85.360 FAG 85.360 FAT 85.330 FAT 85.360	01.92 -	WS268L,	 3400 121 101  3482 119 031  1878 002 878  3151 182 233	430 10 GMF430 420GTZ KZI-5		
	07.92 - 02.98	WS242L,	 3482 018 132 ●#	420 GMF420		
	07.92 - 02.98	WS268,	 3482 114 032	430 GMFZ430N	für Nebenantrieb / for PTO	(82)
	07.92 - 02.98	WS268M,	 1878 054 933	430 10 430GTZ	für Nebenantrieb / for PTO	(82)
	07.92 - 02.98	WS242,	 3151 263 031	KZIZ-6	für Nebenantrieb / for PTO	(82)
	07.92 - 02.98	WS242M				
	07.92 - 02.98					
FA 85.400 FAD 85.400 FAR 85.400, FAS 85.400 FAG 85.400 FAT 85.400	03.95 - 02.98	WS295M	 3400 122 101  3482 083 032  1878 054 933  3151 000 034	430 10 MfZ430 430GTZ KZISZ-5	Getr. / GBox: 8/16S151/181/221	
	03.95 - 02.98		 3482 114 032	430 GMFZ430N	für Nebenantrieb / for PTO	(82)
	03.95 - 02.98		 1878 054 933	430 10 430GTZ	für Nebenantrieb / for PTO	(82)
	03.95 - 02.98		 3151 263 031	KZIZ-6	für Nebenantrieb / for PTO	(82)
FAR 85.330, FAS 85.330	07.92 - 02.98	-SE1160, DK, -S, -TL, -TD,	 3400 700 305  3482 118 031  1878 002 706  3151 000 515	430 10 GMF430 420GTZ KZIS-4		
		WS242L, WS242M	 3400 121 101  3482 119 031  1878 002 878  3151 182 233	430 10 GMF430 420GTZ KZI-5		
			 3482 018 132 ●#	420 GMF420		
			 3482 114 032	430 GMFZ430N	für Nebenantrieb / for PTO	(82)
			 1878 054 933	430 10 430GTZ	für Nebenantrieb / for PTO	(82)
			 3151 263 031	KZIZ-6	für Nebenantrieb / for PTO	(82)
FT 85.330 FT 85.360 FTG 85.330 FTG 85.360 FTT 85.330 FTT 85.360	07.92 - 02.98	WS268L,	 3400 121 101  3482 119 031  1878 002 878  3151 182 233	430 10 GMF430 420GTZ KZI-5		
	07.92 - 02.98	WS242L,	 3482 018 132 ●#	420 GMF420		
	07.92 - 02.98	WS268M,	 3482 114 032	430 GMFZ430N	für Nebenantrieb / for PTO	(82)
	07.92 - 02.98	WS242,	 1878 054 933	430 10 430GTZ	für Nebenantrieb / for PTO	(82)
	07.92 - 02.98	WS242M	 3151 263 031	KZIZ-6	für Nebenantrieb / for PTO	(82)
FT 85.400 FTG 85.400	03.95 - 02.98	WS295M	 3400 122 101  3482 083 032  1878 054 933  3151 000 034	430 10 MfZ430 430GTZ KZISZ-5	Getr. / GBox: 8/16S151/181/221	
	03.95 - 02.98					
FTT 85.400	03.95 - 02.98	WS295M	 3400 122 101  3482 083 032  1878 054 933  3151 000 034	430 10 MfZ430 430GTZ KZISZ-5	Getr. / GBox: 8/16S151/181/221	
		DK/DKA1160	 1878 001 138	420 10 420GTZ		
			 3151 000 515	KZIS-4		





DAF

85 CF		02.98 - 12.00					
FA 85 CF 340	02.98 - 12.00	XF250M	 3400 122 101  3482 083 032  1878 054 933  3151 000 034	430 10 MFZ430 430GTZ KZISZ-5	Getr. / GBox: ZF S16-151		
FAC 85 CF 340	02.98 - 12.00		 3400 700 504 	430 10	XTend Getr. / GBox: 8/16S-151/181/221 Nabenprofil / Hub Profile: 41,1x50,8-10N Nur zusammen verbauen / Only install together	(48)	
FAD 85 CF 340	02.98 - 12.00					(53)	
FAG 85 CF 340, FAN 85 CF 340	02.98 - 12.00		 3400 121 001  3482 119 031  1878 054 933  3151 182 233	430 10 GMF430 430GTZ KZI-5	Getr. / GBox: Fuller Austauschteil ersetzt durch 3400 121 002 / remanufactured part substituted by (successor) 3400 121 002	(6)	
FAR 85 CF 340	02.98 - 12.00			 3482 114 032	430 GMFZ430N	für Nebenantrieb / for PTO	(82)
FAS 85 CF 340	02.98 - 12.00			 1878 054 933	430 10 430GTZ	für Nebenantrieb / for PTO	(82)
FAT 85 CF 340	02.98 - 12.00			 3151 263 031	KZIZ-6	für Nebenantrieb / for PTO	(82)
FA 85 CF 380	02.98 - 12.00	XF315M, XF280M	 3400 122 101  3482 083 032  1878 054 933  3151 000 034	430 10 MFZ430 430GTZ KZISZ-5	Getr. / GBox: ZF S16-181		
FA 85 CF 430	02.98 - 12.00		 3400 700 504 	430 10	XTend Getr. / GBox: 8/16S-151/181/221 Nabenprofil / Hub Profile: 41,1x50,8-10N Nur zusammen verbauen / Only install together	(48)	
FAC 85 CF 380	02.98 - 12.00					(53)	
FAD 85 CF 380	02.98 - 12.00		 3400 121 001  3482 119 031  1878 054 933  3151 182 233	430 10 GMF430 430GTZ KZI-5	Getr. / GBox: Fuller Austauschteil ersetzt durch 3400 121 002 / remanufactured part substituted by (successor) 3400 121 002	(6)	
FAG 85 CF 380, FAN 85 CF 380	02.98 - 12.00			 3482 114 032	430 GMFZ430N	für Nebenantrieb / for PTO	(82)
FAG 85 CF 430, FAN 85 CF 430	02.98 - 12.00			 1878 054 933	430 10 430GTZ	für Nebenantrieb / for PTO	(82)
FAR 85 CF 380	02.98 - 12.00			 3151 263 031	KZIZ-6	für Nebenantrieb / for PTO	(82)
FAS 85 CF 380	02.98 - 12.00						
FAS 85 CF 430	02.98 - 12.00						
FAT 85 CF 380	02.98 - 12.00						
FAT 85 CF 430	02.98 - 12.00						
FT 85 CF 340	02.98 - 12.00	XF250M	 3400 122 101  3482 083 032  1878 054 933  3151 000 034	430 10 MFZ430 430GTZ KZISZ-5	Getr. / GBox: ZF S16-151		
FTG 85 CF 340	02.98 - 12.00		 3400 700 504 	430 10	XTend Getr. / GBox: 8/16S-151/181/221 Nabenprofil / Hub Profile: 41,1x50,8-10N Nur zusammen verbauen / Only install together	(48)	
FTT 85 CF 340	02.98 - 12.00					(53)	
		 3400 121 001  3482 119 031  1878 054 933  3151 182 233	430 10 GMF430 430GTZ KZI-5	Getr. / GBox: Fuller Austauschteil ersetzt durch 3400 121 002 / remanufactured part substituted by (successor) 3400 121 002	(6)		
FT 85 CF 380	02.98 - 12.00	XF315M, XF280M	 3400 122 101  3482 083 032  1878 054 933  3151 000 034	430 10 MFZ430 430GTZ KZISZ-5	Getr. / GBox: ZF S16-181		
FT 85 CF 430	02.98 - 12.00		 3400 700 504 	430 10	XTend Getr. / GBox: 8/16S-151/181/221 Nabenprofil / Hub Profile: 41,1x50,8-10N Nur zusammen verbauen / Only install together	(48)	
FTG 85 CF 380	02.98 - 12.00					(53)	
FTG 85 CF 430	02.98 - 12.00		 3400 121 001  3482 119 031  1878 054 933  3151 182 233	430 10 GMF430 430GTZ KZI-5	Getr. / GBox: Fuller Austauschteil ersetzt durch 3400 121 002 / remanufactured part substituted by (successor) 3400 121 002	(6)	
FTT 85 CF 380	02.98 - 12.00						
FTT 85 CF 430	02.98 - 12.00						

DAF







CF 85		01.01 - 05.13					
FA 85.340	01.01 - 05.13	XF355M,		3400 122 101	430 10	Getr. / GBox: 16S-151/181/221	
FA 85.380	01.01 - 05.13	XE250C,		 3482 083 032	MFZ430		
FA 85.430	01.01 - 05.13	MX265,		 1878 054 933	430GTZ		
FA 85.480	01.01 - 05.13	XE355C,		 3151 000 034	KZISZ-5		
FAC 85.340	12.05 - 05.13	XE315C,		3400 700 504 	430 10	XTend	
FAX 85.360	10.06 - 05.13	XE280C				Getr. / GBox: 16S-151/181/221	
FAC 85.380	12.05 - 05.13					Nabenprofil / Hub Profile: 41,1x50,8-10N	(48)
FAC 85.430	12.05 - 05.13					Nur zusammen verbauen / Only install together	(53)
FAC 85.480	12.05 - 05.13						
FAD 85.340	01.01 - 05.13						
FAD 85.380	01.01 - 05.13						
FAD 85.430	01.01 - 05.13						
FAD 85.480	01.01 - 05.13						
FAG 85.340, FAN 85.340	01.01 - 05.13						
FAG 85.380, FAN 85.380	01.01 - 05.13						
FAG 85.430, FAN 85.430	01.01 - 05.13						
FAG 85.480, FAN 85.480	01.01 - 05.13						
FAR 85.340, FAS 85.340	01.01 - 05.13						
FAR 85.380, FAS 85.380	01.01 - 05.13						
FAR 85.430, FAS 85.430	01.01 - 05.13						
FAR 85.480, FAS 85.480	01.01 - 05.13						
FAT 85.340	01.01 - 05.13						
FAT 85.380	01.01 - 05.13						
FAT 85.430	01.01 - 05.13						
FAT 85.480	01.01 - 05.13						
FAX 85.340	01.01 - 05.13						
FAX 85.380	01.01 - 05.13						
FAX 85.430	01.01 - 05.13						
FAX 85.480	01.01 - 05.13						
FT 85.340	01.01 - 05.13						
FT 85.380	01.01 - 05.13						
FT 85.430	01.01 - 05.13						
FT 85.480	01.01 - 05.13						
FTG 85.340	01.01 - 05.13						
FTG 85.380	01.01 - 05.13						
FTG 85.430	01.01 - 05.13						
FTG 85.480	01.01 - 05.13						
FTP 85.340	01.01 - 05.13						
FTP 85.380	01.01 - 05.13						
FTP 85.430	01.01 - 05.13						
FTP 85.480	01.01 - 05.13						
FTS 85.380	01.01 - 05.13						
FTS 85.430	01.01 - 05.13						
FTS 85.480	01.01 - 05.13						
FTT 85.340	01.01 - 05.13						
FTT 85.380	01.01 - 05.13						
FTT 85.430	01.01 - 05.13						
FTT 85.480	01.01 - 05.13						















DAF

CF 85		01.01 - 05.13						
FA 85.360	10.06-05.13	MX340, MX375, XE250C, MX265, MX300		3400 700 361 ⊗ 3482 000 484 ⊗ 1878 003 767 ⊙ 3151 000 034	430 10 MFZ430 430WGTZ KZISZ-5	Getr. / GBox: Ecosplit		
FA 85.410	10.06-05.13			3400 700 521 ●■	430 10	XTend Getr. / GBox: Ecosplit Nabenprofil / Hub Profile: 41,1x50,8-10N	(48)	
FA 85.460	10.06-05.13			3400 700 368 ⊗ 3482 000 484 ⊗ 1878 003 647 ⊙ 3151 000 493	430 10 MFZ430 430GTZ KZISZ-5	Getr. / GBox: AS Tronic für Ausrückgabel mit Rollen / for release fork with rollers	(71)	
FA 85.510	10.06-05.13			3400 700 522 ●■	430 10	XTend Getr. / GBox: AS Tronic Nabenprofil / Hub Profile: 41,1x50,8-10N für Ausrückgabel mit Rollen / for release fork with rollers	(48) (71)	
FAC 85.360	10.06-05.13							
FAC 85.410	10.05-05.13							
FAC 85.460	10.05-05.13							
FAC 85.460	10.05-05.13							
FAC 85.510	10.05-05.13							
FAC 85.510	10.05-05.13							
FAD 85.360	10.06-05.13							
FAD 85.410	10.05-05.13							
FAD 85.410	10.06-05.13							
FAD 85.410	10.06-05.13							
FAD 85.460	10.05-05.13							
FAD 85.460	10.06-05.13							
FAD 85.460	10.06-05.13							
FAD 85.460	10.06-05.13							
FAD 85.510	10.05-05.13							
FAD 85.510	10.06-05.13							
FAD 85.510	10.06-05.13							
FAG 85.360, FAN 85.360	10.06-05.13							
FAG 85.410, FAN 85.410	10.05-05.13							
FAG 85.410, FAN 85.410	10.06-05.13							
FAG 85.460, FAN 85.460	10.05-05.13							
FAG 85.460, FAN 85.460	10.06-05.13							
FAG 85.460, FAN 85.460	10.06-05.13							
FAG 85.510, FAN 85.510	10.05-05.13							
FAG 85.510, FAN 85.510	10.06-05.13							
FAN 85.360	10.06-05.13							
FAN 85.410	10.06-05.13							
FAN 85.460	10.06-05.13							
FAN 85.510	10.06-05.13							
FAQ 85.360	10.06-05.13							
FAQ 85.410	10.06-05.13							
FAQ 85.460	10.06-05.13							
FAQ 85.510	10.06-05.13							
FAR 85.360	10.06-05.13							
FAR 85.360, FAS 85.360	10.06-05.13							
FAR 85.410	10.05-05.13							
FAR 85.410, FAS 85.410	10.05-05.13							
FAR 85.460	10.05-05.13							
FAR 85.460, FAS 85.460	10.05-05.13							
FAR 85.510	10.05-05.13							
FAR 85.510, FAS 85.510	10.05-05.13							
FAT 85.360	10.06-05.13							
FAT 85.410	10.05-05.13							
FAT 85.460	10.05-05.13							
FAT 85.510	10.05-05.13							
FT 85.360	10.06-05.13							
FT 85.410	10.05-05.13							
FT 85.460	10.05-05.13							
FT 85.510	10.05-05.13							
FTG 85.360	10.06-05.13							
FTG 85.410	10.05-05.13							
FTG 85.460	10.05-05.13							
FTG 85.510	10.05-05.13							
FTR 85.360, FTS 85.360, FTP 85.360	10.06-05.13							

		CODE				
--	--	------	--	---	---	---













DAF





































CF 85		01.01 - 05.13					
FTR 85.410, FTS 85.410, FTP 85.410	10.05-05.13	MX340,		3400 700 361 ⊗ 3482 000 484 ⊗ 1878 003 767 ⊙ 3151 000 034	430 10 MFZ430 430WGTZ KZISZ-5	Getr. / GBox: Ecosplit	
FTR 85.460, FTS 85.460, FTP 85.460	10.05-05.13	XE250C, MX265, MX300		3400 700 521 	430 10	XTend Getr. / GBox: Ecosplit Nabenprofil / Hub Profile: 41,1x50,8-10N	(48)
FTR 85.510, FTS 85.510, FTP 85.510	10.05-05.13			3400 700 368 ⊗ 3482 000 484 ⊗ 1878 003 647 ⊙ 3151 000 493	430 10 MFZ430 430GTZ KZISZ-5	Getr. / GBox: AS Tronic für Ausrückgabel mit Rollen / for release fork with rollers	(71)
FTS 85.340	01.01-05.13			3400 700 522 	430 10	XTend Getr. / GBox: AS Tronic Nabenprofil / Hub Profile: 41,1x50,8-10N für Ausrückgabel mit Rollen / for release fork with rollers	(48) (71)
FTT 85.360	10.06-05.13			3189 600 004		Getr. / GBox: ZF AS Tronic Rollenausführung / roller version	(58)
FTT 85.410	10.05-05.13						
FTT 85.460	10.05-05.13						
FTT 85.510	10.05-05.13						

CF		05.13 -					
FA 220	07.14-	PX-7164,		3400 700 473 ⊗ 3482 000 474 ⊗ 1878 005 599 ⊙ 3151 000 651	395 10 MF395 395WGTZ KZIS-4	Getr. / GBox: 6S800 / 6S1000 Getr. / GBox: 9S1110TD Getr. / GBox: 6AS800 / 6AS1000 Euro 6 / Euro 6	(18)
FA 250	07.14-	PX-7208,					
FA 280	07.14-	PX-7186,					
FA 310	07.14-	PX-7231					
FA 290	05.13-	MX-11210		3400 700 467 ⊗ 3482 000 484 ⊗ 1878 003 767 ⊙ 3151 000 493	430 10 MFZ430 430WGTZ KZISZ-5	Getr. / GBox: AS Tronic Euro 6 / Euro 6	(18)
FAN 290, FAG 290	05.13-			3400 700 604 ⊗ 3482 001 184 ⊗ 1878 004 573 ⊙ 3151 000 493	430 10 MFZ430 430WGTZ KZISZ-5	Getr. / GBox: Ecosplit4 Euro 6 / Euro 6	(18)
FAR 290, FAS 290	05.13-			3189 600 004		Getr. / GBox: ZF AS Tronic Rollenausführung / roller version	(58)
FAT 290	05.13-			3189 600 030		Getr. / GBox: Ecosplit 4	
FT 290	05.13-						
FA 330	05.13-	MX-11240		3400 700 467 ⊗ 3482 000 484 ⊗ 1878 003 767 ⊙ 3151 000 493	430 10 MFZ430 430WGTZ KZISZ-5	Getr. / GBox: AS Tronic Euro 6 / Euro 6	(18)
FAN 330, FAG 330	05.13-			3400 700 605 ⊗ 3482 001 171 ⊗ 1878 085 742 ⊙ 3151 000 395	430 10 MF430 430WGTZ KZIS-4	Getr. / GBox: 9S1110TD Euro 6 / Euro 6	(18)
FAR 330, FAS 330	05.13-			3189 600 004		Getr. / GBox: ZF AS Tronic Rollenausführung / roller version	(58)
FAT 330	05.13-			3189 600 030		Getr. / GBox: Ecosplit 4	
FT 330	05.13-						
FA 370	05.13-	MX-11271		3400 700 467 ⊗ 3482 000 484 ⊗ 1878 003 767 ⊙ 3151 000 493	430 10 MFZ430 430WGTZ KZISZ-5	Getr. / GBox: AS Tronic Euro 6 / Euro 6	(18)
FAN 370, FAG 370	05.13-			3400 700 605 ⊗ 3482 001 171 ⊗ 1878 085 742 ⊙ 3151 000 395	430 10 MF430 430WGTZ KZIS-4	Getr. / GBox: 9S1110TD Euro 6 / Euro 6	(18)
FAR 370, FAS 370	05.13-			3189 600 004		Getr. / GBox: ZF AS Tronic Rollenausführung / roller version	(58)
FAT 370	05.13-			3189 600 030		Getr. / GBox: Ecosplit 4	
FT 370	05.13-						
FA 400	05.13-	MX-11291		3400 700 467 ⊗ 3482 000 484 ⊗ 1878 003 767 ⊙ 3151 000 493	430 10 MFZ430 430WGTZ KZISZ-5	Getr. / GBox: AS Tronic Getr. / GBox: Ecosplit 4 Euro 6 / Euro 6	(18)
FAD 400	05.13-			3400 700 522 	430 10	XTend Getr. / GBox: Ecosplit 4 Nabenprofil / Hub Profile: 41,1x50,8-10N Euro 6 / Euro 6 für Ausrückgabel mit Rollen / for release fork with rollers	(48) (18) (71)
FAN 400, FAG 400	05.13-			3189 600 004		Getr. / GBox: ZF AS Tronic Rollenausführung / roller version	(58)
FAR 400, FAS 400	05.13-			3189 600 030		Getr. / GBox: Ecosplit 4	
FAT 400	05.13-						
FT 400	05.13-						
FTG 400	05.13-						
FTP 400	05.13-						
FTT 400	05.13-						

		CODE					
--	--	------	--	--	---	---	---



























DAF

CF		05.13 -										
FA 410	05.13-	MX-13303		3400 700 467 ⊗ 3482 000 484 ⊗ 1878 003 767 ⊙ 3151 000 493	430 10 MFZ430 430WGTZ KZISZ-5	Getr. / GBox: AS Tronic Getr. / GBox: Ecosplit 4 Euro 6 / Euro 6	(18)					
FAD 410	05.13-			3400 700 522 ■	430 10	XTend Getr. / GBox: Ecosplit 4 Nabenprofil / Hub Profile: 41,1x50,8-10N Euro 6 / Euro 6 für Ausrückgabel mit Rollen / for release fork with rollers	(48) (18) (71)					
FAN 410, FAG 410	05.13-											
FAR 410, FAS 410	05.13-											
FAT 410	05.13-											
FT 410	05.13-											
FTG 410	05.13-											
FTP 410	05.13-								3189 600 004		Getr. / GBox: ZF AS Tronic Rollenausführung / roller version	(58)
FTR 410	05.13-											
FTS 410	05.13-											
FTT 410	05.13-				Getr. / GBox: Ecosplit 4							
FA 440	05.13-	MX-11320		3400 700 467 ⊗ 3482 000 484 ⊗ 1878 003 767 ⊙ 3151 000 493	430 10 MFZ430 430WGTZ KZISZ-5	Getr. / GBox: AS Tronic Getr. / GBox: Ecosplit 4 Euro 6 / Euro 6	(18)					
FAC 400	12.15-			3400 700 522 ■	430 10	XTend Getr. / GBox: Ecosplit 4 Nabenprofil / Hub Profile: 41,1x50,8-10N Euro 6 / Euro 6 für Ausrückgabel mit Rollen / for release fork with rollers	(48) (18) (71)					
FAC 410	12.15-											
FAC 440	12.15-											
FAC 460	12.15-											
FAC 510	12.15-											
FAD 290	05.13-											
FAD 330	05.13-								3189 600 004		Getr. / GBox: ZF AS Tronic Rollenausführung / roller version	(58)
FAD 370	05.13-											
FAD 440	05.13-											
FAN 440, FAG 440	05.13-	MX-11210, MX-11320, MX-13375, MX-11240, MX-13303, MX-11291, MX-11271, MX-13340		3189 600 030		Getr. / GBox: Ecosplit 4						
FAQ 400, FAX 400	12.15-											
FAQ 410, FAX 410	12.15-											
FAQ 440, FAX 440	12.15-											
FAQ 460, FAX 460	12.15-											
FAQ 510, FAX 510	12.15-											
FAR 440, FAS 440	05.13-											
FAT 440	05.13-											
FT 440	05.13-											
FTG 440	05.13-											
FTP 440	05.13-											
FTT 440	05.13-											
FA 460	05.13-	MX-13340		3400 700 467 ⊗ 3482 000 484 ⊗ 1878 003 767 ⊙ 3151 000 493	430 10 MFZ430 430WGTZ KZISZ-5	Getr. / GBox: AS Tronic Getr. / GBox: Ecosplit 4 Euro 6 / Euro 6	(18)					
FAD 460	05.13-			3400 700 522 ■	430 10	XTend Getr. / GBox: Ecosplit 4 Nabenprofil / Hub Profile: 41,1x50,8-10N Euro 6 / Euro 6 für Ausrückgabel mit Rollen / for release fork with rollers	(48) (18) (71)					
FAN 460, FAG 460	05.13-											
FAR 460, FAS 460	05.13-											
FAT 460	05.13-											
FT 460	05.13-											
FTG 460	05.13-											
FTP 460	05.13-								3189 600 004		Getr. / GBox: ZF AS Tronic Rollenausführung / roller version	(58)
FTR 460	05.13-											
FTS 460	05.13-											
FTT 460	05.13-				Getr. / GBox: Ecosplit 4							
FA 510	05.13-	MX-13375		3400 700 467 ⊗ 3482 000 484 ⊗ 1878 003 767 ⊙ 3151 000 493	430 10 MFZ430 430WGTZ KZISZ-5	Getr. / GBox: AS Tronic Getr. / GBox: Ecosplit 4 Euro 6 / Euro 6	(18)					
FAD 510	05.13-			3400 700 522 ■	430 10	XTend Getr. / GBox: Ecosplit 4 Nabenprofil / Hub Profile: 41,1x50,8-10N Euro 6 / Euro 6 für Ausrückgabel mit Rollen / for release fork with rollers	(48) (18) (71)					
FAN 510, FAG 510	05.13-											
FAR 510, FAS 510	05.13-											
FAT 510	05.13-											
FT 510	05.13-											
FTG 510	05.13-											
FTP 510	05.13-								3189 600 004		Getr. / GBox: ZF AS Tronic Rollenausführung / roller version	(58)
FTR 510	05.13-											
FTS 510	05.13-											
FTT 510	05.13-				Getr. / GBox: Ecosplit 4							







95		09.87 - 01.98						
FA 95.310	09.87 - 09.90	WS259, WS225		3400 124 601	430 10			
FA 95.350	09.87 - 09.90			 3482 119 031	GMF430			
FAC 95.310	09.87 - 01.98			 1878 086 741	430WGTZ			
FAC 95.350	09.87 - 01.98			 3151 000 395	KZIS-4			
FAD 95.310	09.87 - 01.98				3482 018 132 ●#	420		
FAD 95.350	09.87 - 01.98					GMF420		
FAR 95.350, FAS 95.350	09.87 - 09.90				3482 114 032	430	für Nebenantrieb / for PTO (82)	
FAG 95.350	09.87 - 09.90					GMFZ430N		
FAR 95.310	09.87 - 09.90				1878 054 933	430 10	für Nebenantrieb / for PTO (82)	
FAT 95.350	09.87 - 09.90					430GTZ		
FTG 95.310	09.87 - 01.98			3151 263 031	KZIZ-6	für Nebenantrieb / for PTO (82)		
FTG 95.350	09.87 - 09.90							
FA 95.330	08.90 - 01.93	WS268L, WS268G, WS268, WS268M, WS242		3400 121 101	430 10			
FA 95.360	08.90 - 01.98			 3482 119 031	GMF430			
FAC 95.330	08.90 - 01.98			 1878 002 878	420GTZ			
FAC 95.360	08.90 - 01.98			 3151 182 233	KZI-5			
FAD 95.330	08.90 - 01.98				3482 018 132 ●#	420		
FAD 95.360	08.90 - 01.98					GMF420		
FAR 95.360, FAS 95.360	08.90 - 01.98				3482 114 032	430	für Nebenantrieb / for PTO (82)	
FAG 95.360	08.90 - 01.98					GMFZ430N		
FAK 95.360	08.90 - 01.98				1878 054 933	430 10	für Nebenantrieb / for PTO (82)	
FAR 95.330, FAS 95.330	08.90 - 01.93					430GTZ		
FAT 95.360	08.90 - 01.98			3151 263 031	KZIZ-6	für Nebenantrieb / for PTO (82)		
FTG 95.330	08.90 - 01.98							
FTG 95.360	08.90 - 01.98							
FA 95.380	09.87 - 09.90	WS282		3400 125 701	430 10			
FAC 95.380	09.87 - 01.98			 3482 119 031	GMF430			
FAD 95.380	09.87 - 09.90			 1878 003 269	420GTZ			
FAR 95.380, FAS 95.380	09.87 - 09.90			 3151 000 395	KZIS-4			
FAG 95.380	09.87 - 09.90				3482 018 132 ●#	420		
FAT 95.380	09.87 - 09.90					GMF420		
FTG 95.380	09.87 - 09.90				3482 114 032	430	für Nebenantrieb / for PTO (82)	
				GMFZ430N				
				1878 054 933	430 10	für Nebenantrieb / for PTO (82)		
				430GTZ				
				3151 263 031	KZIZ-6	für Nebenantrieb / for PTO (82)		
FA 95.400	08.90 - 01.98	WS315L, WS295G, WS315, WS315M, WS295, WS295L, WS315G, WS295M		3400 121 001	430 10	Austauschteil ersetzt durch 3400 121 002 / remanufactured part substituted by (successor) 3400 121 002	(6)	
FA 95.430	02.92 - 01.98			 3482 119 031	GMF430			
FAC 95.400	08.90 - 01.98			 1878 054 933	430GTZ			
FAC 95.430	02.92 - 01.98			 3151 182 233	KZI-5			
FAD 95.400	08.90 - 01.98				3482 114 032	430	für Nebenantrieb / for PTO (82)	
FAD 95.430	02.92 - 01.98					GMFZ430N		
FAR 95.400, FAS 95.400	08.90 - 01.98				1878 054 933	430 10	für Nebenantrieb / for PTO (82)	
FAG 95.400	08.90 - 01.98					430GTZ		
FAR 95.430, FAS 95.430	02.92 - 01.98					3151 263 031	KZIZ-6	für Nebenantrieb / for PTO (82)
FAG 95.430	02.92 - 01.98							
FAK 95.400	08.90 - 01.98							
FAK 95.430	02.92 - 01.98							
FAT 95.400	08.90 - 01.98							
FAT 95.430	02.92 - 01.98							
FTG 95.400	08.90 - 01.98							
FTG 95.430	02.92 - 01.98							
FT 95.310	09.87 - 09.90	WS242, WS259, WS225		3400 124 601	430 10			
FT 95.350	09.87 - 09.90			 3482 119 031	GMF430			
FTG 95.310	09.87 - 01.98			 1878 086 741	430WGTZ			
FTS 95.350	09.87 - 09.90			 3151 000 395	KZIS-4			
FTT 95.310	09.87 - 01.98				3482 018 132 ●#	420		
FTT 95.330	09.87 - 01.98					GMF420		
FTT 95.350	09.87 - 09.90							

		CODE					
--	--	------	--	--	---	---	---















DAF

95		09.87 - 01.98					
FT 95.330	08.90-01.93	WS268L,		3400 121 101	430 10		
FT 95.360	08.90-01.98	WS268G,		 3482 119 031	GMF430		
FTG 95.330	08.90-01.98	WS268,		 1878 002 878	420GTZ		
FTR 95.360, FTS 95.360	08.90-01.98	WS268M,		 3151 182 233	KZI-5		
FTT 95.360	08.90-01.98	WS242		3482 018 132 ●#	420		
					GMF420		
FT 95.380	09.87-09.90	WS282		3400 125 701	430 10		
FTS 95.380	09.87-09.90			 3482 119 031	GMF430		
FTT 95.380	09.87-09.90			 1878 003 269	420GTZ		
				 3151 000 395	KZIS-4		
				3482 018 132 ●#	420		
					GMF420		
FT 95.400	08.90-01.98	WS315L,		3400 121 001	430 10	Austauschteil ersetzt durch 3400 121 002 /	(6)
FT 95.430	02.92-01.98	WS295G,		 3482 119 031	GMF430	remanufactured part substituted by (successor) 3400	
FTR 95.400, FTS 95.400	08.90-01.98	WS315,		 1878 054 933	430GTZ	121 002	
FTR 95.430, FTS 95.430	02.92-01.98	WS315M,		 3151 182 233	KZI-5		
FTT 95.400	08.90-01.98	WS295,					
FTT 95.430	02.92-01.98	WS295L,					
		WS295M					
FT 95.500	02.94-01.98	VF373M		3400 122 101	430 10		
				 3482 083 032	MFZ430		
				 1878 054 933	430GTZ		
				 3151 000 034	KZISZ-5		
95 XF		01.97 - 09.02					
FA 95 XF 380	01.97-09.02	XF315M,		3400 122 101	430 10	Getr. / GBox: ZF S16-181	
FA 95 XF 430	01.97-09.02	XE315C,		 3482 083 032	MFZ430		
FAC 95 XF 380	01.97-09.02	XF280M,		 1878 054 933	430GTZ		
FAC 95 XF 430	01.97-09.02	XE280C		 3151 000 034	KZISZ-5		
FAD 95 XF 380	01.97-09.02			3400 121 001	430 10	Getr. / GBox: Fuller	(6)
FAD 95 XF 430	01.97-09.02			 3482 119 031	GMF430	Austauschteil ersetzt durch 3400 121 002 /	
FAR 95 XF 380	01.97-09.02			 1878 054 933	430GTZ	remanufactured part substituted by (successor) 3400	
FAR 95 XF 430	01.97-09.02			 3151 182 233	KZI-5	121 002	
FAS 95 XF 380	01.97-09.02						
FAS 95 XF 430	01.97-09.02						
FAT 95 XF 380	01.97-09.02						
FAT 95 XF 430	01.97-09.02						
FT 95 XF 380	01.97-09.02						
FT 95 XF 430	01.97-09.02						
FTD 95 XF 430	01.97-09.02						
FTG 95 XF 380	01.97-09.02						
FTG 95 XF 430	01.97-09.02						
FTR 95 XF 380	01.97-09.02						
FTR 95 XF 430	01.97-09.02						
FTS 95 XF 380	01.97-09.02						
FTS 95 XF 430	01.97-09.02						
FTT 95 XF 380	01.97-09.02						
FTT 95 XF 430	01.97-09.02						













DAF

95 XF		01.97 - 09.02					
FA 95 XF 480	01.97-09.02	XF355M,		3400 122 101	430 10	Getr. / GBox: ZF S16-221	
FA 95 XF 530	01.97-09.02	XF315M,		 3482 083 032	MFZ430		
FA 95 XF 530	01.97-09.02	VF390M,	 1878 054 933	430GTZ			
FAC 95 XF 480	01.97-09.02	XE355C,	 3151 000 034	KZISZ-5			
FAC 95 XF 530	01.97-09.02	XE315C,	3400 121 001	430 10	Getr. / GBox: Fuller		
FAC 95 XF 530	01.97-09.02	XE390C	 3482 119 031	GMF430	Austauschteil ersetzt durch 3400 121 002 /	(6)	
FAD 95 XF 480	01.97-09.02		 1878 054 933	430GTZ	remanufactured part substituted by (successor) 3400		
FAD 95 XF 530	01.97-09.02		 3151 182 233	KZI-5	121 002		
FAD 95 XF 530	01.97-09.02						
FAR 95 XF 480	01.97-09.02						
FAR 95 XF 530	01.97-09.02						
FAR 95 XF 530	01.97-09.02						
FAS 95 XF 480	01.97-09.02						
FAS 95 XF 530	01.97-09.02						
FAS 95 XF 530	01.97-09.02						
FAT 95 XF 480	01.97-09.02						
FAT 95 XF 530	01.97-09.02						
FAT 95 XF 530	01.97-09.02						
FT 95 XF 480	01.97-09.02						
FT 95 XF 530	01.97-09.02						
FT 95 XF 530	02.01-09.02						
FTD 95 XF 480	01.97-09.02						
FTD 95 XF 530	01.97-09.02						
FTG 95 XF 480	01.97-09.02						
FTG 95 XF 530	01.97-09.02						
FTG 95 XF 530	01.97-						
FTP 95 XF 430	01.97-09.02						
FTR 95 XF 480	01.97-09.02						
FTR 95 XF 530	01.97-09.02						
FTR 95 XF 530	01.97-09.02						
FTS 95 XF 480	01.97-09.02						
FTS 95 XF 530	01.97-09.02						
FTS 95 XF 530	01.97-09.02						
FTT 95 XF 480	01.97-09.02						
FTT 95 XF 530	01.97-09.02						
FTT 95 XF 530	01.97-09.02						



DAF

XF 95		01.02 - 12.06				
FA 95.380	09.02 - 12.06	XF355M,	 3400 122 101	430 10	Getr. / GBox: 16S-151/181/221	
FA 95.430	09.02 - 12.06	XF315M,	 3482 083 032	MFZ430		
FA 95.480	09.02 - 12.06	XE355C,	 1878 054 933	430GTZ		
FA 95.530	09.02 - 12.06	XE315C,	 3151 000 034	KZISZ-5		
FAD 95.380	01.02 - 12.06	XF280M,	 3400 700 504 	430 10	XTend	
FAD 95.430	01.02 - 12.06	XE390C,			Getr. / GBox: 16S-151/181/221	(48)
FAD 95.480	01.02 - 12.06	XE280C			Nabenprofil / Hub Profile: 41,1x50,8-10N	(53)
FAD 95.530	01.02 - 12.06		 3400 700 489	430 10	Getr. / GBox: ZF AS Tronic	
FAK 95.380	09.02 -		 3482 083 032	MFZ430	für Ausrückgabel mit Rollen / for release fork with	(71)
FAK 95.430	01.02 - 12.06		 1878 054 933	430GTZ	rollers	
FAK 95.480	01.02 - 12.06		 3151 000 493	KZISZ-5		
FAK 95.530	09.02 -		 3482 083 032	430	Getr. / GBox: ZF AS Tronic	(70)
FAN 95.380	01.02 - 12.06			MFZ430	für Ausrückgabel mit Nocken / for release fork with	
FAN 95.430	01.02 - 12.06		 1878 054 933	430 10	Getr. / GBox: ZF AS Tronic	(70)
FAN 95.480	01.02 - 12.06			430GTZ	für Ausrückgabel mit Nocken / for release fork with	
FAN 95.530	09.02 -		 3151 000 144	KZISZ-5	Getr. / GBox: ZF AS Tronic	(70)
FAR 95.380	09.02 - 12.06		 3189 600 004		für Ausrückgabel mit Nocken / for release fork with	
FAR 95.430	09.02 - 12.06				Rollenausführung / roller version	(58)
FAR 95.480	09.02 - 12.06					
FAR 95.530	09.02 - 12.06					
FAS 95.380	01.02 - 12.06					
FAS 95.430	01.02 - 12.06					
FAS 95.480	01.02 - 12.06					
FAS 95.530	09.02 -					
FAT 95.380	01.02 - 12.06					
FAT 95.430	01.02 - 12.06					
FAT 95.480	01.02 - 12.06					
FAT 95.530	09.02 -					
FT 95.380	09.02 - 12.06					
FT 95.430	09.02 - 12.06					
FT 95.480	09.02 - 12.06					
FT 95.530	09.02 - 12.06					
FTG 95.380	09.02 - 12.06					
FTG 95.430	12.05 - 12.06					
FTG 95.480	12.05 - 12.06					
FTG 95.530	09.02 - 12.06					
FTM 95.380	12.05 - 12.06					
FTM 95.430	12.05 - 12.06					
FTM 95.480	12.05 - 12.06					
FTM 95.530	09.02 - 12.06					
FTP 95.380	01.02 - 12.06					
FTP 95.430	01.02 - 12.06					
FTP 95.480	01.02 - 12.06					
FTP 95.530	09.02 -					
FTR 95.380	01.02 - 12.06					
FTR 95.430	01.02 - 12.06					
FTR 95.480	01.02 - 12.06					
FTR 95.530	09.02 -					
FTS 95.380	01.02 - 12.06					
FTS 95.430	01.02 - 12.06					
FTS 95.480	01.02 - 12.06					
FTS 95.530	09.02 -					
FTT 95.380	01.02 - 03.06					
FTT 95.430	01.02 - 03.06					
FTT 95.480	01.02 - 03.06					
FTT 95.530	09.02 -					







DAF

XF 105		10.05 -								
FA 105.410	10.05-	MX340, MX375, MX300		3400 700 361  3482 000 484  1878 003 767  3151 000 034	430 10 MFZ430 430WGTZ KZISZ-5	Getr. / GBox: ZF16S-2020,2220				
FA 105.460	10.05-									
FA 105.510	10.05-									
FAD 105.410	10.05-						3400 700 521 	430 10 XTend	Getr. / GBox: ZF16S-2020,2220 Nabenprofil / Hub Profile: 41,1x50,8-10N	(48)
FAD 105.460	10.05-									
FAD 105.510	10.05-									
FAK 105.410	10.05-						3400 700 368  3482 000 484  1878 003 647  3151 000 493	430 10 MFZ430 430GTZ KZISZ-5	Getr. / GBox: AS Tronic für Ausrückgabel mit Rollen / for release fork with rollers	(71)
FAK 105.460	10.05-									
FAK 105.510	10.05-									
FAR 105.410	10.05-						3400 700 522 	430 10 XTend	Getr. / GBox: AS Tronic Nabenprofil / Hub Profile: 41,1x50,8-10N für Ausrückgabel mit Rollen / for release fork with rollers	(48)
FAR 105.460	10.05-									
FAR 105.510	10.05-								(71)	
FAS 105.410, FAR 105.410	10.05-									
FAN 105.410	10.05-						3189 600 004		Getr. / GBox: ZF AS Tronic Rollenausführung / roller version	(58)
FAS 105.460, FAR 105.460	10.05-									
FAN 105.460	10.05-									
FAS 105.510, FAR 105.510	10.05-									
FAN 105.510	10.05-									
FAT 105.410	10.05-									
FAT 105.460	10.05-									
FAT 105.510	10.05-									
FT 105.410	10.05-									
FT 105.460	10.05-									
FT 105.510	10.05-									
FTM 105.410	10.05-									
FTM 105.460	10.05-									
FTM 105.510	10.05-									
FTG 105.410	10.05-									
FTG 105.460	10.05-									
FTG 105.510	10.05-									
FTS 105.410, FTR 105.410	10.05-									
FTS 105.460, FTR 105.460	10.05-									
FTS 105.510, FTR 105.510	10.05-									
FTT 105.410	10.05-									
FTT 105.460	10.05-									
FTT 105.510	10.05-									

DAF



XF		10.12 -					
FA 410	10.12-	MX-11320,		3400 700 467 ⊗ 3482 000 484 ⊗ 1878 003 767 ⊙ 3151 000 493	430 10 MFZ430 430WGTZ KZISZ-5	Getr. / GBox: AS Tronic Getr. / GBox: Ecosplit 4	
FA 440	10.12-						
FA 460	10.12-	MX-13375, MX-13303, MX-13340		3400 700 522 ■	430 10	XTend Getr. / GBox: Ecosplit 4 Nabenprofil / Hub Profile: 41,1x50,8-10N für Ausrückgabel mit Rollen / for release fork with rollers	(48)
FA 510	10.12-						(71)
FAD 460	10.12-						
FAD 510	10.12-						
FAN 410	10.12-						
FAN 440	10.12-			3189 600 004		Getr. / GBox: ZF AS Tronic Rollenausführung / roller version	(58)
FAN 460	10.12-						
FAN 510	10.12-			3189 600 030		Getr. / GBox: Ecosplit 4	
FAR 410	10.12-						
FAR 410, FAS 410	10.12-						
FAR 440	10.12-						
FAR 440, FAS 440	10.12-						
FAR 460	10.12-						
FAR 460, FAS 460	10.12-						
FAR 510	10.12-						
FAR 510, FAS 510	10.12-						
FT 410	10.12-						
FT 440	10.12-						
FT 460	10.12-						
FT 510	10.12-						
FTG 410, FTN 410	10.12-						
FTG 440, FTN 440	10.12-						
FTG 460, FTN 460	10.12-						
FTG 510, FTN 510	10.12-						
FTM 460	10.12-						
FTM 510	10.12-						
FTP 410	10.12-						
FTP 410, FTR 410, FTS 410	10.12-						
FTP 440	10.12-						
FTP 440, FTR 440, FTS 440	10.12-						
FTP 460	10.12-						
FTP 460, FTR 460, FTS 460	10.12-						
FTP 510	10.12-						
FTP 510, FTR 510, FTS 510	10.12-						
FTT 460	10.12-						
FTT 510	10.12-						

DEMAG









S ...							
SKG				1881 059 208	200 KS200		
				1864 634 039	200 10 200Z		
V ...							
V 35		WWMAKD112Z		1864 634 026	225 10 225Z		
V 42				1881 010 139 #	250 G250		
				1864 202 035 #	250 10 250Z		
				3151 045 001	KZI-2		
V 70 HL		312V		1863 600 125	GR-3	mit Anlaufring / with thrust ring	(88)







		CODE				
--	--	------	--	---	---	---

ENASA



1217 - 1437						
1217		9100Turbo		1861 902 032 #	380 10 380GTD	
1223		9220Turbo		1878 003 276	420 10 420GTZ	
1232				3482 083 113	430 MFZ430	
1234				1878 022 841	430 10 430GTZ	
1236						
1278						
1437		9156Turbo		1878 003 277	420 10 420GTZ	
				3151 145 101	KZI-5	

FAUN

A						
AK 320 HB (DB-Mot.)				1882 205 234	250 HBX250	
				1882 600 122 ●	250 HBX250	
				1861 291 136	250 10 250GTZ	
				1878 634 082 ●	250 10 250GTZ	
				3151 045 001	KZI-2	
AK 470 HB				1878 001 074	350 10 350GTZ	
AS 22	01.48 -			1881 089 002	225 K225	
				1864 634 024	225 10 225Z	
				1859 600 001	GR.I/ZL	
				1805 042 000		

F 24 - 284							
F 24 F 284 D				1881 009 201 #	250 G250		
				1861 224 005 #	250 10 250GSZ		
				1859 600 001	GR.I/ZL		
				1805 042 000			
F 50 /440 V				1880 092 415 #	310 G310		
				1863 600 125	GR-3	mit Anlauftring / with thrust ring	(88)
				1878 001 074	350 10 350GTZ		























F 610 - 837						
F 610 /36 SA F 610 /36 ZAN F 610 /362				1881 041 656 #	380 G380	
				1863 009 100	GR-5	mit Anlauftring / with thrust ring

K 20/37 - K 40/40						
K 20/37 K 20/37 A K 20/37 V K 20/37 VA				1881 039 532 #	350 G350KR	
				3151 000 395	KZIS-4	
K 25/36 A K 25/36 V K 25/36 VA K 40/40 VL				1881 041 656 #	380 G380	
				1863 009 100	GR-5	mit Anlauftring / with thrust ring



		CODE				
--	--	------	--	---	---	---

FAUN



KF 15.21 - 100.53

KF 15.21 /30 4x4 KF 15.21 /32 4x4			 1881 041 656 #	380 G380		
			 3151 000 395	KZIS-4		
KF 20.31 /42 (6 Zyl. Mot.)			 1881 039 532 #	350 G350KR		
			 1878 005 367	350 10 350WGTZ		
KF 20.31 /48 6x4 KF 20.31 /48 6x6			 1881 039 532 #	350 G350KR		
			 3151 000 395	KZIS-4		
			 1882 325 139	380 G380		
			 1878 000 104	380 10 380GTZ		
			 3151 000 395	KZIS-4		
KF 30.31 /48 KF 30.41 /48 (8-Zyl.-Mot) KF 40.41 /50 (8-Zyl.-Mot) KF 30.31 /48 6x6			 1882 325 139	380 G380		
			 1881 039 532 #	350 G350KR		
KF 30.31 /54 6x6		KHD	 3151 000 395	KZIS-4		
			 1878 002 706	420 10 420GTZ		
KF 30.41 /48 KF 30.41 /48 6x4 KF 30.41 /48 8x4			 1881 039 532 #	350 G350KR		
			 1881 041 656 #	380 G380		
KF 30.41 /48 8x6 KF 50.42 /483 8x6			 3151 000 395	KZIS-4		
			 1863 009 100	GR-5	mit Anlauftring / with thrust ring	(88)
			 1881 041 656 #	380 G380		
KF 30.41 /48 8x8 KF 60.43 /50 8x4 KF 60.43 /50 8x6 KF 60.43 /55 8x6 KF 60.52 /55 10x6 KF 70.43 /55 8x6			 1863 009 100	GR-5	mit Anlauftring / with thrust ring	(88)
			 1882 325 139	380 G380		
			 1878 000 104	380 10 380GTZ		
KF 40.41 /48 8 Zyl. KF 40.41 /48 8x4 KF 50.42 /48 8-Zyl.			 3151 000 395	KZIS-4		



KRAKA 640

KRAKA 640 (BMW-Mot. 427)			 1881 065 101	180 KS180		
			 1861 280 136	180 24 180CB		

L 908 - L 1212











L 1212 L 1212 /375 VS 8x6 L 1212 /45 ZA			 1881 041 656 #	380 G380		
			 1863 009 100	GR-5	mit Anlauftring / with thrust ring	(88)



LK 116 - LK 1512

LK 116 /42 V 6x6 LK 606 /32 V LK 606 /38 V LK 906 /48 V LK 906 /48 V 6-Zyl.			 1881 041 656 #	380 G380		
			 3151 000 395	KZIS-4		

		CODE				
--	--	------	--	---	---	---

FAUN

LK 116 - LK 1512						
LK 606 /38 6x6		1882 325 139	380 G380			
		1878 000 104	380 10 380GTZ			
		3151 000 395	KZIS-4			
LK 906 /45 V LK 906 /45 V 6x6 LK 910 /483 10-Zyl. LK 910 /483 V LK 1210 /50 V 8x6 LK 1212 /485 III LK 1412 LK 1412 /64 V 10x6 LK 1508 /36 V LK 1512 /38 V 4x4		1881 041 656 #	380 G380			
		1863 009 100	GR-5	mit Anlauftring / with thrust ring		(88)
LK 906 /48 6x4 LK 906 /48 6x6 LK 906 /48 V 6x4 LK 906 /48 V 8-Zyl. LK 906 /48 VH 6x4 LK 906 /60 V LK 910 /483		1881 039 532 #	350 G350KR			
		3151 000 395	KZIS-4			
LK 908 /48		1881 039 532 #	350 G350KR			
		1881 041 656 #	380 G380			
		3151 000 395	KZIS-4			
		1863 009 100	GR-5	mit Anlauftring / with thrust ring		(88)





TF						
TF 00.31/52 6x4		1882 325 139	380 G380			
		1878 000 104	380 10 380GTZ			
		3151 000 395	KZIS-4			



FREIGHTLINER

M Series (Business Class)						
M2 Business Class		OM906		3400 700 526 ■	395	XTend Nur zusammen verbauen / Only install together (53)





		CODE				
--	--	------	--	---	---	---

HINO

Serie 700		07.08 -					
FS2441	08.09-	E13C-TN,		3482 000 777	430	Getr. / GBox: Proshift / AS Tronic	
FS2445, FS2445Air	08.09-	E13C-UN,			MFZ430		
FS2844, FS2844Air	01.12-	E13C-VF,		1878 004 133	430 10	Getr. / GBox: Proshift / AS Tronic	
FS2845Air	01.12-	E13C-VU,			430WGTZ		
FS2848, FS2848Air	01.12-	E13C-VC,		3151 000 493	KZISZ-5	Getr. / GBox: Proshift / AS Tronic für Ausrückgabel mit Rollen / for release fork with rollers	(71)
FY2945, FY2945Air	08.09-	E13C-UY,					
FY3241	07.12-	E13C-VB,		3189 600 004		Getr. / GBox: ZF AS Tronic Rollenausführung / roller version	(58)
FY3248, FY3248Air	07.12-	E13C-TT,					
SH2045Air	01.12-	E13C-WB,					
SS2845Air	07.08-	E13C-VG,					
SS2848Air	01.12-	E13C-VA					
TT2038Air	01.12-						
TT2841	04.11-						
TT2845	04.11-						
TT2848, TT2848Air	04.11-						









TRUCK							
FS2PLKD				3488 019 133 ⊕	380	enthält eine Kupplungsscheibe / This part number includes one clutch disc	(67)
					GMFZ2/380		
				1862 543 031 ▽	380 10	Lose Kupplungsscheibe / Loose clutch disc	(41)
					380WGVZ		
				3100 023 031	KZISZ-5	In 3483/3488 enthalten / Contained in 3483, 3488	(32)
				• 3151 000 750	KZISZ-5		
				⊙ 3180 001 008			









ISUZU

N-Serie		09.93 -					
NKR 85EA, NLR 85AL, NLR 85L, NNR 85L, NPR 85G, NPR 85L	10.06-	4JJ1-X,		3400 700 389	300	Getr. / GBox: NYY5T/6S Nabenprofil / Hub Profile: 14 x 36mm	(48)
NMR 85L, NPR 85L	10.06-	4JJ1-TC					
NPR 85L, NPR 85P	10.06-						
NQR 85							
NPR 70	09.98-	4HE1-TC		3400 700 383	325	01.1999 - 12.2001 Getr. / GBox: MBP6 Organic Nabenprofil / Hub Profile: 1 1/2" -10N	(48)
NQR 70							
				3400 700 385	325	01.1999 - 12.2001 Getr. / GBox: MBP6 Ceramic Nabenprofil / Hub Profile: 1 1/2" -10N	(48)
				3400 700 387	325	01.2003 - 12.2005 Getr. / GBox: MZZ6F Organic Nabenprofil / Hub Profile: 1 1/2" -14N	(48)
				3400 700 390	325	01.2003 - 12.2005 Getr. / GBox: MZZ6F Ceramic Nabenprofil / Hub Profile: 1 1/2" -14N	(48)
NPR 75L, NQR 75L, NQR 75P, NQR 75T	10.06-	4HK1-XS		3400 700 387	325	Getr. / GBox: MZZ6F Organic Nabenprofil / Hub Profile: 1 1/2" -14N	(48)
				3400 700 391	325	Getr. / GBox: MYY6F Nabenprofil / Hub Profile: 1 1/2" -14N	(48)
				3400 700 390	325	Getr. / GBox: MZZ6F Ceramic Nabenprofil / Hub Profile: 1 1/2" -14N	(48)
NQR 77		4JH1		3400 700 392	300	01.2001 - 12.2003 Getr. / GBox: MXA5 Nabenprofil / Hub Profile: 21 x 29	(48)















		CODE				
--	--	------	--	---	---	---

IVECO

DAILY Kasten / Box		01.78 - 08.98					
30-8 (10014131, 10014132, 10014137, 10014231, 10014232...)	01.78 - 12.89	8140.61		3000 434 001 ⊗ 1850 480 049 ⊗ 1862 977 001 ⊙ 3151 065 031	240 10 M240 240CB KZI-1	Getriebeummer / Transmission Number: 2815 10014131 / 10014132 / 10014137 / 10014231 / 10014232 / 10014237 / 10015131 / 10015132 / 10015232	(28)
35-8 (10034131, 10034132, 10034137, 10034224, 10034231...)	01.78 - 12.89	8140.61		3000 434 001 ⊗ 1850 480 049 ⊗ 1862 977 001 ⊙ 3151 065 031	240 10 M240 240CB KZI-1	Getriebeummer / Transmission Number: 2815 10034131 / 10034132 / 10034137 / 10034224 / 10034231 / 10034232 / 10034237 / 10035231 / 10035232 / 10035237	(28)
35-10 (10314204, 10314211, 10314212, 10314217, 10314411...)	01.85 - 12.89	8140.21		3400 700 429 ⊗ 3482 907 001 ⊗ 1862 967 001 ⊙ 3151 065 031	265 10 MF265 265TB KZI-1	Getriebeummer / Transmission Number: 2822 10314204 / 10314211 / 10314212 / 10314217 / 10314411 / 10314412 / 10314417 / 10315211 / 10315212	(28)
		8140.27S		3400 117 701 ⊗ 3482 998 701 ⊗ 1878 997 101 ⊙ 3151 600 529	265 10 MFZ265 265VTP KZISZ-2	für / for: Euro2 Getriebeummer / Transmission Number: 2826.5 13017231	(69) (28)
				3000 951 026 ⊗ 3083 039 031 ⊗ 1878 002 072 ⊙ 3151 600 529	235 10 MFZ235X 235VTB KZISZ-2	Getriebeummer / Transmission Number: 2826.5 13017231	(28)
40-10 V	01.85 - 12.89	8140.27S		3400 700 429 ⊗ 3482 907 001 ⊗ 1862 967 001 ⊙ 3151 065 031	265 10 MF265 265TB KZI-1	Nur zusammen verbauen / Only install together	(53)
45-10 V (10334204, 10334211, 10334212, 10334217, 10334404)	01.85 - 12.89	8140.21		3400 700 429 ⊗ 3482 907 001 ⊗ 1862 967 001 ⊙ 3151 065 031	265 10 MF265 265TB KZI-1	Getriebeummer / Transmission Number: 2824 10334204 / 10334211 / 10334212 / 10334217 / 10334404	(28)
49-10 V (10354204, 10354211, 10354212, 10354217...)	01.85 - 12.89	8140.21		3400 700 429 ⊗ 3482 907 001 ⊗ 1862 967 001 ⊙ 3151 065 031	265 10 MF265 265TB KZI-1	Getriebeummer / Transmission Number: 2822 10354204 / 10354211 / 10354212 / 10354217 / 10354404 / 10354411 / 10354412	(28)

DAILY Pritsche / Flatbed		01.78 - 05.99					
30-8 (10011131, 10011132, 10011231, 10011232, 10011237...)	01.78 - 12.89	8140.61		3000 434 001 ⊗ 1850 480 049 ⊗ 1862 977 001 ⊙ 3151 065 031	240 10 M240 240CB KZI-1	Getriebeummer / Transmission Number: 2815 10011131 / 10011132 / 10011231 / 10011232 / 10011237 / 10016132 / 10016232	(28)
35-8 (10031131, 10031132, 10031137, 10031224, 10031231...)	01.78 - 12.89	8140.61		3000 434 001 ⊗ 1850 480 049 ⊗ 1862 977 001 ⊙ 3151 065 031	240 10 M240 240CB KZI-1	Getriebeummer / Transmission Number: 2815 10031131 / 10031132 / 10031137 / 10031224 / 10031231 / 10031232 / 10031237 / 10031324 / 10031331 / 10031332 / 10031337 / 10036131 / 10036132 / 10036137 / 10036231 / 10036232 / 10036237	(28)
35-10 (10310311, 10311111, 10311112, 10311117, 10311211...)	01.85 - 12.89	8140.21		3400 700 429 ⊗ 3482 907 001 ⊗ 1862 967 001 ⊙ 3151 065 031	265 10 MF265 265TB KZI-1	Getriebeummer / Transmission Number: 2824 10310311	(28)
				3400 700 429 ⊗ 3482 907 001 ⊗ 1862 967 001 ⊙ 3151 065 031	265 10 MF265 265TB KZI-1	Getriebeummer / Transmission Number: 2822 10311111 / 10311112 / 10311117 / 10311211 / 10311212 / 10311217 / 10311304 / 10311311 / 10311312 / 10311317 / 10316211	(28)
40-8	01.83 - 06.89	8140.61.200		3000 434 001 ⊗ 1850 480 049 ⊗ 1862 977 001 ⊙ 3151 065 031	240 10 M240 240CB KZI-1		
40-10	01.85 - 12.89	8140.27S		3400 700 429 ⊗ 3482 907 001 ⊗ 1862 967 001 ⊙ 3151 065 031	265 10 MF265 265TB KZI-1	Nur zusammen verbauen / Only install together	(53)
45-10 (10331211, 10331212, 10331217, 10331304, 10331311...)	01.85 - 12.89	8140.21		3400 700 429 ⊗ 3482 907 001 ⊗ 1862 967 001 ⊙ 3151 065 031	265 10 MF265 265TB KZI-1	Getriebeummer / Transmission Number: 2824 10331217 / 10331304 / 10331311 / 10331312 / 10331317 / 10331211 / 10331212	(28)
49-10 (10350211, 10350304, 10350311, 10350404, 10350411...)	01.85 - 12.89	8140.21		3400 700 429 ⊗ 3482 907 001 ⊗ 1862 967 001 ⊙ 3151 065 031	265 10 MF265 265TB KZI-1	Getriebeummer / Transmission Number: 2822 10350211 / 10350304 / 10350311 / 10350404 / 10350411 / 10351211 / 10351212 / 10351215 / 10351217 / 10351304 / 10351311 / 10351312 / 10351317	(28)

IVECO

DAILY II Kasten / Box		01.89 - 05.99					
30-8 (12914111, 12914112, 12914117, 12914131, 12914137...), 55 kW 30-8 (12914111, 12914112, 12914117, 12914131, 12914137...), 60 kW	01.89 - 08.98	8140.67F	 3000 951 026 ⊗ 3083 039 031 ⊗ 1878 002 072 ⬢ 3151 600 529	235 10 MFZ235X 235VTB KZISZ-2	Getriebeummer / Transmission Number: 2826.5 14914111 / 14914117 / 14914211 / 14914217 / 14915111 / 14915211	(28)	
	01.89 - 08.98	8140.07	 3000 951 026 ⊗ 3083 039 031 ⊗ 1878 002 072 ⬢ 3151 600 529	235 10 MFZ235X 235VTB KZISZ-2	Getriebeummer / Transmission Number: 2819.5 12914137 / 12914235 / 12915135	(28)	
			 3000 434 001 ⊗ 1850 480 049 ⊗ 1862 977 001 ⬢ 3151 065 031	240 10 M240 240CB KZI-1	Getriebeummer / Transmission Number: 2819.5 12914215	(28)	
			 3000 434 001 ⊗ 1850 480 049 ⊗ 1862 977 001 ⬢ 3151 065 031	240 10 M240 240CB KZI-1	->Chass. 2926609 Getriebeummer / Transmission Number: 2819.5 12914111 / 12914112 / 12914117 / 12914131 / 12914211 / 12914212 / 12914217 / 12914231 / 12915111 / 12915112 / 12915131 / 12915211 / 12915212 / 12915231	(28)	
			 3000 951 026 ⊗ 3083 039 031 ⊗ 1878 002 072 ⬢ 3151 600 529	235 10 MFZ235X 235VTB KZISZ-2	Chass. 2926610-> Getriebeummer / Transmission Number: 2819.5 12914111 / 12914112 / 12914117 / 12914131 / 12914211 / 12914212 / 12914217 / 12914231 / 12915111 / 12915112 / 12915131 / 12915211 / 12915212 / 12915231	(28)	
30-8 (14914111, 14914117, 14914211, 14914217, 14915111...), 60 kW 30-8 (14914111, 14914117, 14914211, 14914217, 14915111...), 62 kW 30-8 V (14914111, 14914117, 14914211, 14914217...)	01.89 - 08.98	8140.67F	 3000 951 026 ⊗ 3083 039 031 ⊗ 1878 002 072 ⬢ 3151 600 529	235 10 MFZ235X 235VTB KZISZ-2	Getriebeummer / Transmission Number: 2826.5 14914111 / 14914117 / 14914211 / 14914217 / 14915111 / 14915211	(28)	
	09.98 - 05.99						
	09.98 - 05.99						
30-10 30-10 C	01.97 - 05.99	8140.23.	 3400 700 444 ■	265 10	15011131 / 15011231 / 15014131 / 15014231 / 15015131 / 15015231	(48)	
	01.97 - 05.99		 3000 951 026 ⊗ 3083 039 031 ⊗ 1878 002 072 ⬢ 3151 600 529	235 10 MFZ235X 235VTB KZISZ-2	Nabenprofil / Hub Profile: 23x29,2x10N 15014111 / 15014211 / 15015111 / 15015211		
35-8 (12934104, 12934111, 12934112, 12934117, 12934124...), 55 kW 35-8 (12934104, 12934111, 12934112, 12934117, 12934124...), 60 kW	01.91 - 08.98	8140.67F	 3000 951 026 ⊗ 3083 039 031 ⊗ 1878 002 072 ⬢ 3151 600 529	235 10 MFZ235X 235VTB KZISZ-2	Getriebeummer / Transmission Number: 2826.5 14934104 / 14934111 / 14934204 / 14934205 / 14934211 / 14934212 / 14934215 / 14934217 / 14935211 / 14935215	(28)	
	01.91 - 08.98	8140.07	 3000 951 026 ⊗ 3083 039 031 ⊗ 1878 002 072 ⬢ 3151 600 529	235 10 MFZ235X 235VTB KZISZ-2	Getriebeummer / Transmission Number: 2819.5 12934124 / 12934224 / 12934235 / 12934237 / 12935235 / 12935237	(28)	
			 3000 434 001 ⊗ 1850 480 049 ⊗ 1862 977 001 ⬢ 3151 065 031	240 10 M240 240CB KZI-1	Getriebeummer / Transmission Number: 2819.5 12934205 / 12935215	(28)	
			 3000 434 001 ⊗ 1850 480 049 ⊗ 1862 977 001 ⬢ 3151 065 031	240 10 M240 240CB KZI-1	->Chass. 2926609 Getriebeummer / Transmission Number: 2819.5 12934104 / 12934111 / 12934112 / 12934117 / 12934131 / 12934204 / 12934211 / 12934212 / 12934215 / 12934217 / 12934231 / 12935211 / 12935212 / 12935217 / 12935231	(28)	
			 3000 951 026 ⊗ 3083 039 031 ⊗ 1878 002 072 ⬢ 3151 600 529	235 10 MFZ235X 235VTB KZISZ-2	Chass. 2926610-> Getriebeummer / Transmission Number: 2819.5 12934104 / 12934111 / 12934112 / 12934117 / 12934131 / 12934204 / 12934211 / 12934212 / 12934215 / 12934217 / 12934231 / 12935211 / 12935212 / 12935217 / 12935231	(28)	
09.98 - 05.99	8140.67F	 3000 951 026 ⊗ 3083 039 031 ⊗ 1878 002 072 ⬢ 3151 600 529	235 10 MFZ235X 235VTB KZISZ-2	Getriebeummer / Transmission Number: 2826.5 14934104 / 14934111 / 14934204 / 14934205 / 14934211 / 14934212 / 14934215 / 14934217 / 14935211 / 14935215	(28)		
35-10 (12974212, 12974217, 12974417)	09.96 - 08.98	8140.97	 3000 951 026 ⊗ 3083 039 031 ⊗ 1878 002 072 ⬢ 3151 600 529	235 10 MFZ235X 235VTB KZISZ-2	Getr. / GBox: 2826.5 12974212 / 12974217		

















IVECO

DAILY II Kasten / Box		01.89 - 05.99					
35-10 (12974212, 12974217, 13014111, 13014131, 13014204...), 76 kW 35-10 (12974212, 12974217, 13014111, 13014131, 13014204...), 80 kW	01.89-08.98	8140.47R	3400 700 432 ■	280 10 280/Z	Getriebenummer / Transmission Number: 2826.5 15534211 / 15534212 / 15534217 / 15534411 / 15534417 / 15535212 Nabenprofil / Hub Profile: 23x30,55x10N	(28)	(48)
	01.89-08.98		3400 117 701 ⊗ 3482 998 701 ⊗ 1878 997 101 ⊙ 3151 600 529	265 10 MFZ265 265VTP KZISZ-2	Getriebenummer / Transmission Number: 2826.5 13810217 / 13810417 / 13814212 / 13814217 / 13814412 / 13814417 / 13815212 / 13817212	(28)	
		8140.97	3000 951 026 ⊗ 3083 039 031 ⊗ 1878 002 072 ⊙ 3151 600 529	235 10 MFZ235X 235VTB KZISZ-2	Getriebenummer / Transmission Number: 2826.5 12974212 / 12974217	(28)	
		8140.23	3000 951 026 ⊗ 3083 039 031 ⊗ 1878 002 072 ⊙ 3151 600 529	235 10 MFZ235X 235VTB KZISZ-2	Getriebenummer / Transmission Number: 2826.5 15034111 / 15034204 / 15034211 / 15034215 / 15034217 / 15034404 / 15034411 / 15034417 / 15035211 / 15035217	(28)	
		8140.27S	3000 951 026 ⊗ 3083 039 031 ⊗ 1878 002 072 ⊙ 3151 600 529	235 10 MFZ235X 235VTB KZISZ-2	Getriebenummer / Transmission Number: 2826.5 13014131 / 13014224 / 13014231 / 13014233 / 13014235 / 13014237 / 13014424 / 13014431 / 13014437 / 13015231 / 13015235 / 13015237	(28)	
			3400 117 701 ⊗ 3482 998 701 ⊗ 1878 997 101 ⊙ 3151 600 529	265 10 MFZ265 265VTP KZISZ-2	für / for: Euro2 Getriebenummer / Transmission Number: 2826.5 13014131 / 13014231 / 13014233 / 13014431 / 13015231	(69) (28)	
	3400 700 429 ⊗ 3482 907 001 ⊗ 1862 967 001 ⊙ 3151 065 031		265 10 MF265 265TB KZI-1	->Chass. 5928512 Getriebenummer / Transmission Number: 2826.5 13014111 / 13014204 / 13014211 / 13014212 / 13014213 / 13014215 / 13014217 / 13014404 / 13014411 / 13014412 / 13014417 / 13015211 / 13015212 / 13015217	(28)		
		3000 951 026 ⊗ 3083 039 031 ⊗ 1878 002 072 ⊙ 3151 600 529	235 10 MFZ235X 235VTB KZISZ-2	Chass. 5928513-> Getriebenummer / Transmission Number: 2826.5 13014111 / 13014204 / 13014211 / 13014212 / 13014213 / 13014215 / 13014217 / 13014404 / 13014411 / 13014412 / 13014417 / 13015211 / 13015212 / 13015217	(28)		
35-10 (15034111, 15034204, 15034211, 15034215, 15034217...)	01.96-05.99	8140.23	3400 700 444 ■	265 10	Getriebenummer / Transmission Number: 2826.5 15034131 / 15034224 / 15034231 / 15034424 / 15034431 Nabenprofil / Hub Profile: 23x29,2x10N	(28)	(48)
			3000 951 026 ⊗ 3083 039 031 ⊗ 1878 002 072 ⊙ 3151 600 529	235 10 MFZ235X 235VTB KZISZ-2	Getriebenummer / Transmission Number: 2826.5 15034111 / 15034204 / 15034211 / 15034215 / 15034217 / 15034404 / 15034411 / 15034417 / 15035211 / 15035217	(28)	
35-12 (13114131, 13114204, 13114211, 13114212, 13114217...)	01.90-04.96	8140.43	3400 700 432 ■	280 10 280/Z	Getriebenummer / Transmission Number: 2826.5 15134204 / 15134211 / 15134217 / 15134404 / 15134411 / 15134417 / 15135211 / 15434211 / 15434411 / 15435211 Nabenprofil / Hub Profile: 23x30,55x10N	(28)	(48)
		8140.47	3400 117 701 ⊗ 3482 998 701 ⊗ 1878 997 101 ⊙ 3151 600 529	265 10 MFZ265 265VTP KZISZ-2	Getriebenummer / Transmission Number: 2826.5 13114131 / 13114204 / 13114211 / 13114212 / 13114217 / 13114224 / 13114231 / 13114237 / 13114411 / 13114412 / 13114417 / 13114424 / 13114431 / 13114437 / 13115211 / 13115212 / 13115217 / 13115231	(28)	
40-10 V	01.90-04.96	8140	3000 951 026 ⊗ 3083 039 031 ⊗ 1878 002 072 ⊙ 3151 600 529	235 10 MFZ235X 235VTB KZISZ-2	03.1990->		
		8140.27.2720	3400 700 429 ⊗ 3482 907 001 ⊗ 1862 967 001 ⊙ 3151 065 031	265 10 MF265 265TB KZI-1	Nur zusammen verbauen / Only install together	(53)	
40-10 4x4 (15214104, 15214111, 15214117, 15215111)	01.97-05.99	8140.23	3000 951 026 ⊗ 3083 039 031 ⊗ 1878 002 072 ⊙ 3151 600 529	235 10 MFZ235X 235VTB KZISZ-2	Getriebenummer / Transmission Number: 2826.5 15214104 / 15214111 / 15214117 / 15215111	(28)	
45-10 V (13034204, 13034211, 13034212, 13034224...)	01.89-04.96	8140.27S	3000 951 026 ⊗ 3083 039 031 ⊗ 1878 002 072 ⊙ 3151 600 529	235 10 MFZ235X 235VTB KZISZ-2	Getriebenummer / Transmission Number: 2826.5 13034224 / 13034231 / 13034424 / 13034431	(28)	
			3400 700 429 ⊗ 3482 907 001 ⊗ 1862 967 001 ⊙ 3151 065 031	265 10 MF265 265TB KZI-1	->Chass. 5928512 Getriebenummer / Transmission Number: 2826.5 13034204 / 13034211 / 13034212 / 13034404 / 13034411 / 13034412	(28)	
			3000 951 026	235 10	Chass. 5928513-> Getriebenummer / Transmission Number: 2826.5 13034204 / 13034211 / 13034212 / 13034404 /	(28)	









		CODE				
--	--	------	--	---	---	---









IVECO

DAILY II Kasten / Box		01.89 - 05.99					
49-10 V (13054204, 13054211, 13054212, 13054215...)	01.89 - 04.96	8140.23	 3000 951 026 ⊗ 3083 039 031 ⊗ 1878 002 072 ⊙ 3151 600 529	235 10 MFZ235X 235VTB KZISZ-2	Getriebenummer / Transmission Number: 2826.5 15054204 / 15054211 / 15054215 / 15054217 / 15054404 / 15054411 / 15054417	(28)	
		8140.27S	 3000 951 026 ⊗ 3083 039 031 ⊗ 1878 002 072 ⊙ 3151 600 529	235 10 MFZ235X 235VTB KZISZ-2	Getriebenummer / Transmission Number: 2826.5 13054224 / 13054231 / 13054235 / 13054237 / 13054424 / 13054431 / 13054437	(28)	
			 3400 117 701 ⊗ 3482 998 701 ⊗ 1878 997 101 ⊙ 3151 600 529	265 10 MFZ265 265VTP KZISZ-2	für / for: Euro2 Getriebenummer / Transmission Number: 2826.5 13054231 / 13054431	(69) (28)	
			 3400 700 429 ⊗ 3482 907 001 ⊗ 1862 967 001 ⊙ 3151 065 031	265 10 MF265 265TB KZI-1	->Chass. 5928512 Getriebenummer / Transmission Number: 2826.5 13054204 / 13054211 / 13054212 / 13054215 / 13054217 / 13054404 / 13054411 / 13054412 / 13054417	(28)	
			 3000 951 026 ⊗ 3083 039 031 ⊗ 1878 002 072 ⊙ 3151 600 529	235 10 MFZ235X 235VTB KZISZ-2	Chass. 5928513-> Getriebenummer / Transmission Number: 2826.5 13054204 / 13054211 / 13054212 / 13054215 / 13054217 / 13054404 / 13054411 / 13054412 / 13054417	(28)	
49-12 V (13134124, 13134204, 13134211, 13134212...)	06.90 - 04.96	8140.47	 3400 117 701 ⊗ 3482 998 701 ⊗ 1878 997 101 ⊙ 3151 600 529	265 10 MFZ265 265VTP KZISZ-2	Getriebenummer / Transmission Number: 2826.5 13134435 / 13134437 / 13134124 / 13134204 / 13134211 / 13134212 / 13134217 / 13134224 / 13134231 / 13134235 / 13134237 / 13134404 / 13134411 / 13134412 / 13134417 / 13134424 / 13134431	(28)	
49-12 V (15154204, 15154211, 15154215, 15154217...)	05.96 - 05.99	8140.43	 3400 700 432 ■	280 10 280/Z	Getriebenummer / Transmission Number: 2826.5 15154204 / 15154211 / 15154215 / 15154217 / 15154404 / 15154411 / 15154417 Nabenprofil / Hub Profile: 23x30,55x10N	(28) (48)	
59-12 V (13154404, 13154411, 13154412, 13154417...)	05.91 - 04.96	8140.47	 3400 117 701 ⊗ 3482 998 701 ⊗ 1878 997 101 ⊙ 3151 600 529	265 10 MFZ265 265VTP KZISZ-2	Getriebenummer / Transmission Number: 2826.5 13154404 / 13154411 / 13154412 / 13154417 / 13154424 / 13154431 / 13154435 / 13154437	(28)	
59-12 V (15174404, 15174411, 15174415, 15174417)	05.96 - 05.99	8140.43	 3400 700 432 ■	280 10 280/Z	Getriebenummer / Transmission Number: 2826.5 15174404 / 15174411 / 15174415 / 15174417 Nabenprofil / Hub Profile: 23x30,55x10N	(28) (48)	
DAILY II Kipper / Dumptruck		01.89 - 05.99					
35-8 K (14930304, 14931104, 14931111, 14931115...)	09.98 - 05.99	8140.67	 3000 951 026 ⊗ 3083 039 031 ⊗ 1878 002 072 ⊙ 3151 600 529	235 10 MFZ235X 235VTB KZISZ-2	Getriebenummer / Transmission Number: 2826.5 14930304 / 14931104 / 14931111 / 14931115 / 14931204 / 14931211 / 14931215 / 14931217 / 14931304 / 14931311 / 14931317 / 14931411 / 15931111	(28)	
		8140.23	 3000 951 026 ⊗ 3083 039 031 ⊗ 1878 002 072 ⊙ 3151 600 529	235 10 MFZ235X 235VTB KZISZ-2	Getriebenummer / Transmission Number: 2826.5 15030111 / 15030211 / 15030311 / 15031111 / 15031117 / 15031204 / 15031211 / 15031215 / 15031217 / 15031304 / 15031311 / 15031317 / 15031411 / 15036111 / 15036204 / 15036211 / 15036215 / 15036217 / 15036311	(28)	
		8140.43	 3400 700 432 ■	280 10 280/Z	Getriebenummer / Transmission Number: 2826.5 15130311 / 15130411 / 15131111 / 15131204 / 15131211 / 15131217 / 15131304 / 15131311 / 15131317 / 15131411 / 15131417 / 15136111 / 15136211 / 15136311 / 15136317 Nabenprofil / Hub Profile: 23x30,55x10N	(28) (48)	
45-10 (13031204, 13031211, 13031212, 13031224, 13031231...)	01.92 - 04.96	8140.27S	 3000 951 026 ⊗ 3083 039 031 ⊗ 1878 002 072 ⊙ 3151 600 529	235 10 MFZ235X 235VTB KZISZ-2	Getriebenummer / Transmission Number: 2826.5 13031224 / 13031231 / 13031324 / 13031331	(28)	
			 3400 700 429 ⊗ 3482 907 001 ⊗ 1862 967 001 ⊙ 3151 065 031	265 10 MF265 265TB KZI-1	->Chass. 5928512 Getriebenummer / Transmission Number: 2826.5 13031211 / 13031212 / 13031304 / 13031311 / 13031312 / 13031204	(28)	
			 3000 951 026 ⊗ 3083 039 031 ⊗ 1878 002 072 ⊙ 3151 600 529	235 10 MFZ235X 235VTB KZISZ-2	Chass. 5928513-> Getriebenummer / Transmission Number: 2826.5 13031211 / 13031212 / 13031304 / 13031311 / 13031312 / 13031204	(28)	

		CODE				
--	--	------	--	---	---	---













IVECO

DAILY II Kipper / Dumptruck 01.89 - 05.99						
49-10 K (13056212, 13056224, 13056231, 13056237...)	01.89 - 04.96	8140.27S	 3000 951 026 ⊗ 3083 039 031 ⊗ 1878 002 072 ⊙ 3151 600 529	235 10 MFZ235X 235VTB KZISZ-2	Getriebenummer / Transmission Number: 2826.5 13056224 / 13056231 / 13056237 / 13056304 / 13056324 / 13056331	(28)
			 3400 117 701 ⊗ 3482 998 701 ⊗ 1878 997 101 ⊙ 3151 600 529	265 10 MFZ265 265VTP KZISZ-2	für / for: Euro2 Getriebenummer / Transmission Number: 2826.5 13056231 / 13056331	(69) (28)
			 3400 700 429 ⊗ 3482 907 001 ⊗ 1862 967 001 ⊙ 3151 065 031	265 10 MF265 265TB KZI-1	->Chass. 5928512 Getriebenummer / Transmission Number: 2826.5 13056212 / 13056312	(28)
			 3000 951 026 ⊗ 3083 039 031 ⊗ 1878 002 072 ⊙ 3151 600 529	235 10 MFZ235X 235VTB KZISZ-2	Chass. 5928513-> Getriebenummer / Transmission Number: 2826.5 13056212 / 13056312	(28)
49-10 K (15056204, 15056211, 15056304, 15056311)	05.96 - 05.99	8140.23	 3000 951 026 ⊗ 3083 039 031 ⊗ 1878 002 072 ⊙ 3151 600 529	235 10 MFZ235X 235VTB KZISZ-2	Getriebenummer / Transmission Number: 2826.5 15056204 / 15056211 / 15056304 / 15056311	(28)
		8140.23.	 3400 700 444 ■	265 10	15050424 / 15050431 / 15051224 / 15051231 / 15051324 / 15051331 / 15051424 / 15051431 / 15051524 / 15051531 / 15054224 / 15054231 / 15054424 / 15054431 / 15056224 / 15056231 / 15056324 / 15056331 Nabenprofil / Hub Profile: 23x29,2x10N	(48)
49-12 K (13136204, 13136211, 13136212, 13136224...)	06.90 - 04.96	8140.47	 3400 117 701 ⊗ 3482 998 701 ⊗ 1878 997 101 ⊙ 3151 600 529	265 10 MFZ265 265VTP KZISZ-2	Getriebenummer / Transmission Number: 2826.5 13136204 / 13136211 / 13136212 / 13136224 / 13136231 / 13136237 / 13136312 / 13136324 / 13136331 / 13136337	(28)
59-12 K (13156211, 13156212, 13156231, 13156311...)	05.91 - 04.96	8140.47	 3400 117 701 ⊗ 3482 998 701 ⊗ 1878 997 101 ⊙ 3151 600 529	265 10 MFZ265 265VTP KZISZ-2	Getriebenummer / Transmission Number: 2826.5 13156331 / 13156335 / 13156337 / 13156512 / 13156531 / 13156211 / 13156212 / 13156231 / 13156311 / 13156312 / 13156324	(28)
59-12 K (15176211, 15176304, 15176311, 15176315...)	05.96 - 05.99	8140.43	 3400 700 432 ■	280 10 280/Z	Getriebenummer / Transmission Number: 2826.5 15176211 / 15176304 / 15176311 / 15176315 / 15176317 / 15176511 Nabenprofil / Hub Profile: 23x30,55x10N	(28) (48)

















































DAILY II Pritsche / Flatbed 01.89 - 05.99						
30-8 (12910211, 12911111, 12911112, 12911117, 12911131...), 55 kW	01.92 - 08.98	8140.67F	 3000 951 026 ⊗ 3083 039 031 ⊗ 1878 002 072 ⊙ 3151 600 529	235 10 MFZ235X 235VTB KZISZ-2	Getriebenummer / Transmission Number: 2826.5 14911111 / 14911117 / 14911211 / 14911215 / 14911217 / 14916111 / 14916211	(28)
		8140.07	 3000 951 026 ⊗ 3083 039 031 ⊗ 1878 002 072 ⊙ 3151 600 529	235 10 MFZ235X 235VTB KZISZ-2	Getriebenummer / Transmission Number: 2819.5 12911235 / 12911237 / 12916135 / 12916235	(28)
			 3000 434 001 ⊗ 1850 480 049 ⊗ 1862 977 001 ⊙ 3151 065 031	240 10 M240 240CB KZI-1	->Chass. 2926609 Getriebenummer / Transmission Number: 2819.5 12910211 / 12911111 / 12911112 / 12911117 / 12911131 / 12911211 / 12911212 / 12911217 / 12911231 / 12916112 / 12916131 / 12916212 / 12916231	(28)
30-8 (10011131, 10011132, 10011231, 10011232, 10011237...), 60 kW	01.92 - 08.98	8140.61	 3000 434 001 ⊗ 1850 480 049 ⊗ 1862 977 001 ⊙ 3151 065 031	240 10 M240 240CB KZI-1	Getriebenummer / Transmission Number: 2815 10011131 / 10011132 / 10011231 / 10011232 / 10011237 / 10016132 / 10016232	(28)
		8140.67F	 3000 951 026 ⊗ 3083 039 031 ⊗ 1878 002 072 ⊙ 3151 600 529	235 10 MFZ235X 235VTB KZISZ-2	Getriebenummer / Transmission Number: 2826.5 14911111 / 14911117 / 14911211 / 14911215 / 14911217 / 14916111 / 14916211	(28)
30-8 (10011131, 10011132, 10011231, 10011232, 10011237...), 62 kW	09.98 - 05.99	8140.67F	 3000 951 026 ⊗ 3083 039 031 ⊗ 1878 002 072 ⊙ 3151 600 529	235 10 MFZ235X 235VTB KZISZ-2	Getriebenummer / Transmission Number: 2826.5 14911111 / 14911117 / 14911211 / 14911215 / 14911217 / 14916111 / 14916211	(28)
30-8 (14911111, 14911117, 14911211, 14911215, 14911217...)	09.98 - 05.99	8140.67F	 3000 951 026 ⊗ 3083 039 031 ⊗ 1878 002 072 ⊙ 3151 600 529	235 10 MFZ235X 235VTB KZISZ-2	Getriebenummer / Transmission Number: 2826.5 14911111 / 14911117 / 14911211 / 14911215 / 14911217 / 14916111 / 14916211	(28)
30-10	01.98 - 05.99	8140.23.	 3400 700 444 ■	265 10	15011131 / 15011231 / 15014131 / 15014231 / 15015131 / 15015231 Nabenprofil / Hub Profile: 23x29,2x10N	(48)
			 3000 951 026	235 10	15014111 / 15014211 / 15015111 / 15015211	

		CODE				
--	--	------	--	---	---	---

IVECO

DAILY II Pritsche / Flatbed 01.89 - 05.99							
35-8 (12931102, 12931104, 12931111, 12931112, 12931117...), 55 kW 35-8 (12931102, 12931104, 12931111, 12931112, 12931117...), 60 kW	01.89-08.98	8140.67		3000 951 026 ⊗ 3083 039 031 ⊗ 1878 002 072 ⬢ 3151 600 529	235 10 MFZ235X 235VTB KZISZ-2	Getriebenummer / Transmission Number: 2826.5 14930304 / 14931104 / 14931111 / 14931115 / 14931204 / 14931211 / 14931215 / 14931217 / 14931304 / 14931311 / 14931317 / 14931411 / 14936111 / 14936204 / 14936211 / 14936215 / 14936217 / 15931111	(28)
	01.89-08.98	8140.07		3000 951 026 ⊗ 3083 039 031 ⊗ 1878 002 072 ⬢ 3151 600 529	235 10 MFZ235X 235VTB KZISZ-2	Getriebenummer / Transmission Number: 2819.5 12931124 / 12936135 / 12936235 / 12936237 / 12931135 / 12931205 / 12931224 / 12931235 / 12931324 / 12931335 / 12931337 / 12931412	(28)
				3000 434 001 ⊗ 1850 480 049 ⊗ 1862 977 001 ⬢ 3151 065 031	240 10 M240 240CB KZI-1	-> Chass. 2926609 Getriebenummer / Transmission Number: 2819.5 12931102 / 12931104 / 12931111 / 12931112 / 12931117 / 12931131 / 12931431 / 12936111 / 12936112 / 12936117 / 12936131 / 12936211 / 12936212 / 12936217 / 12936231 / 12931202 / 12931204 / 12931211 / 12931212 / 12931215 / 12931217 / 12931231 / 12931304 / 12931305 / 12931311 / 12931312 / 12931317 / 12931331	(28)
				3000 951 026 ⊗ 3083 039 031 ⊗ 1878 002 072 ⬢ 3151 600 529	235 10 MFZ235X 235VTB KZISZ-2	Chass. 2926610-> Getriebenummer / Transmission Number: 2819.5 12931102 / 12931104 / 12931111 / 12931112 / 12931117 / 12931131 / 12931431 / 12936111 / 12936112 / 12936117 / 12936131 / 12936211 / 12936212 / 12936217 / 12936231 / 12931202 / 12931204 / 12931211 / 12931212 / 12931215 / 12931217 / 12931231 / 12931304 / 12931305 / 12931311 / 12931312 / 12931317 / 12931331	(28)
35-8 (14930304, 14931104, 14931111, 14931115, 14931204...)	09.98-05.99	8140.67		3000 951 026 ⊗ 3083 039 031 ⊗ 1878 002 072 ⬢ 3151 600 529	235 10 MFZ235X 235VTB KZISZ-2	Getriebenummer / Transmission Number: 2826.5 14930304 / 14931104 / 14931111 / 14931115 / 14931204 / 14931211 / 14931215 / 14931217 / 14931304 / 14931311 / 14931317 / 14931411 / 14936111 / 14936204 / 14936211 / 14936215 / 14936217	(28)
35-10 (12971112, 12971212, 12971312, 12971317, 12976112...), 68 kW 35-10 (12971112, 12971212, 12971312, 12971317, 12976112...), 76 kW	01.89-12.96	8140.47R		3400 117 701 ⊗ 3482 998 701 ⊗ 1878 997 101 ⬢ 3151 600 529	265 10 MFZ265 265VTP KZISZ-2	Getriebenummer / Transmission Number: 2826.5 13810312 / 13811112 / 13811212 / 13811217 / 13811312 / 13811317 / 13816112 / 13816212 / 13816217	(28)
	01.89-12.96	8140.97		3400 117 701 ⊗ 3482 998 701 ⊗ 1878 997 101 ⬢ 3151 600 529	265 10 MFZ265 265VTP KZISZ-2	Getriebenummer / Transmission Number: 2826.5 12976112	(28)
				3000 951 026 ⊗ 3083 039 031 ⊗ 1878 002 072 ⬢ 3151 600 529	235 10 MFZ235X 235VTB KZISZ-2	Getriebenummer / Transmission Number: 2826.5 12971112 / 12971212 / 12971312 / 12971317 / 12976212	(28)
		8140.25S		3000 951 026 ⊗ 3083 039 031 ⊗ 1878 002 072 ⬢ 3151 600 529	235 10 MFZ235X 235VTB KZISZ-2	Getriebenummer / Transmission Number: 2826.5 13011137	(28)
		8140.27S		3000 951 026 ⊗ 3083 039 031 ⊗ 1878 002 072 ⬢ 3151 600 529	235 10 MFZ235X 235VTB KZISZ-2	Getriebenummer / Transmission Number: 2826.5 13010131 / 13010231 / 13010331 / 13010431 / 13011131 / 13011135 / 13011224 / 13011231 / 13011235 / 13011237 / 13011315 / 13011324 / 13011331 / 13011337 / 13011412 / 13011431 / 13016131 / 13016135 / 13016231 / 13016235 / 13016237	(28)
				3400 117 701 ⊗ 3482 998 701 ⊗ 1878 997 101 ⬢ 3151 600 529	265 10 MFZ265 265VTP KZISZ-2	für / for: Euro2 Getriebenummer / Transmission Number: 2826.5 13010131 / 13010231 / 13010331 / 13010431 / 13011131 / 13011231 / 13011331 / 13011431 / 13016131 / 13016231	(69) (28)
				3400 700 429 ⊗ 3482 907 001 ⊗ 1862 967 001 ⬢ 3151 065 031	265 10 MF265 265TB KZI-1	-> Chass. 5928512 Getriebenummer / Transmission Number: 2826.5 13010211 / 13010217 / 13010311 / 13010411 / 13010417 / 13011111 / 13011112 / 13011115 / 13011117 / 13011204 / 13011211 / 13011212 / 13011215 / 13011217 / 13011304 / 13011311 / 13011312 / 13011317 / 13016111 / 13016112 / 13016115 / 13016117 / 13016211 / 13016212 / 13016215 / 13016217	(28)
				3000 951 026 ⊗ 3083 039 031 ⊗ 1878 002 072 ⬢ 3151 600 529	235 10 MFZ235X 235VTB KZISZ-2	Chass. 5928513-> Getriebenummer / Transmission Number: 2826.5 13010211 / 13010217 / 13010311 / 13010411 / 13010417 / 13011111 / 13011112 / 13011115 / 13011117 / 13011204 / 13011211 / 13011212 / 13011215 / 13011217 / 13011304 / 13011311 / 13011312 / 13011317 / 13016111 / 13016112 / 13016115 / 13016117 / 13016211 / 13016212 /	(28)







IVECO

DAILY II Pritsche / Flatbed 01.89 - 05.99							
35-10 (15030111, 15030211, 15030311, 15031111, 15031117...)	01.96 - 05.99	8140.23		3000 951 026  3083 039 031  1878 002 072  3151 600 529	235 10 MFZ235X 235VTB KZISZ-2	Getriebenummer / Transmission Number: 2826.5 15030111 / 15030211 / 15030311 / 15030411 / 15031111 / 15031115 / 15031117 / 15031204 / 15031211 / 15031215 / 15031217 / 15031304 / 15031311 / 15031315 / 15031317 / 15031411 / 15036111 / 15036204 / 15036211 / 15036215 / 15036217 / 15036311 / 15631211	(28)
				3400 700 432 	280 10 280/Z	Getriebenummer / Transmission Number: 2826.5 15631231 Nabenprofil / Hub Profile: 23x30,55x10N	(28) (48)
				3400 700 444 	265 10	Getriebenummer / Transmission Number: 2826.5 15030131 / 15030231 / 15030331 / 15030431 / 15031131 / 15031224 / 15031231 / 15031324 / 15031331 / 15031424 / 15031431 / 15036131 / 15036224 / 15036231 / 15036331 Nabenprofil / Hub Profile: 23x29,2x10N	(28) (48)
		8140.47R		3400 700 432 	280 10 280/Z	Getriebenummer / Transmission Number: 2826.5 15531211 / 15531217 / 15531317 Nabenprofil / Hub Profile: 23x30,55x10N	(28) (48)
35-10	01.89 - 12.96	8140.47R		3400 700 432 	280 10 280/Z	Getr. / GBox: 2826.5 Nabenprofil / Hub Profile: 23x30,55x10N	(48)
35-12 (13110131, 13110211, 13110231, 13110311, 13110312...)	01.90 - 04.96	8140.47		3400 117 701  3482 998 701  1878 997 101  3151 600 529	265 10 MFZ265 265VTP KZISZ-2	Getriebenummer / Transmission Number: 2826.5 13110131 / 13110211 / 13110231 / 13110311 / 13110312 / 13110331 / 13110411 / 13110412 / 13110431 / 13111111 / 13111112 / 13111117 / 13111131 / 13111204 / 13111211 / 13111212 / 13111217 / 13111224 / 13111231 / 13111304 / 13111311 / 13111312 / 13111317 / 13111324 / 13111331 / 13111337 / 13111411 / 13111412 / 13111417 / 13111431 / 13111437 / 13116111 / 13116112 / 13116131 / 13116211 / 13116212 / 13116231 / 13116237 / 13116312 / 13116331 / 13116337	(28)
35-12 (15130311, 15130411, 15131111, 15131204, 15131211...)	05.96 - 05.99	8140.43		3400 700 432 	280 10 280/Z	Getriebenummer / Transmission Number: 2826.5 15130311 / 15130411 / 15131111 / 15131204 / 15131211 / 15131217 / 15131304 / 15131311 / 15131317 / 15131411 / 15131417 Nabenprofil / Hub Profile: 23x30,55x10N	(28) (48)
45-10 (13031204, 13031211, 13031212, 13031224, 13031231...)	01.89 - 04.96	8140.27S		3000 951 026  3083 039 031  1878 002 072  3151 600 529	235 10 MFZ235X 235VTB KZISZ-2	Getriebenummer / Transmission Number: 2826.5 13031224 / 13031231 / 13031324 / 13031331	(28)
				3400 700 429  3482 907 001  1862 967 001  3151 065 031	265 10 MF265 265TB KZI-1	->Chass. 5928512 Getriebenummer / Transmission Number: 2826.5 13031211 / 13031212 / 13031304 / 13031311 / 13031312 / 13031204	(28)
				3000 951 026  3083 039 031  1878 002 072  3151 600 529	235 10 MFZ235X 235VTB KZISZ-2	Chass. 5928513-> Getriebenummer / Transmission Number: 2826.5 13031211 / 13031212 / 13031304 / 13031311 / 13031312 / 13031204	(28)
49-10 (13050211, 13050231, 13050304, 13050311, 13050331...)	01.89 - 04.96	8140.47R		3400 117 701  3482 998 701  1878 997 101  3151 600 529	265 10 MFZ265 265VTP KZISZ-2	Getriebenummer / Transmission Number: 2826.5 13851212	(28)
			8140.27S		3000 951 026  3083 039 031  1878 002 072  3151 600 529	235 10 MFZ235X 235VTB KZISZ-2	Getriebenummer / Transmission Number: 2826.5 13050231 / 13050331 / 13050415 / 13050424 / 13050431 / 13050435 / 13051224 / 13051231 / 13051235 / 13051237 / 13051324 / 13051331 / 13051335 / 13051337 / 13051531 / 13056224 / 13056231 / 13056237 / 13056304 / 13056324 / 13056331
			3400 117 701  3482 998 701  1878 997 101  3151 600 529	265 10 MFZ265 265VTP KZISZ-2	für / for: Euro2 Getriebenummer / Transmission Number: 2826.5 13050231 / 13050331 / 13050431 / 13051231 / 13051331 / 13051531 / 13056231 / 13056331	(69) (28)	
			3400 700 429  3482 907 001  1862 967 001  3151 065 031	265 10 MF265 265TB KZI-1	->Chass. 5928512 Getriebenummer / Transmission Number: 2826.5 13050211 / 13050304 / 13050311 / 13050404 / 13050411 / 13051204 / 13051211 / 13051212 / 13051215 / 13051217 / 13051304 / 13051311 / 13051312 / 13051315 / 13051317 / 13056212 / 13056312	(28)	
			3000 951 026  3083 039 031  1878 002 072  3151 600 529	235 10 MFZ235X 235VTB KZISZ-2	Chass. 5928513-> Getriebenummer / Transmission Number: 2826.5 13050211 / 13050304 / 13050311 / 13050404 / 13050411 / 13051204 / 13051211 / 13051212 / 13051215 / 13051217 / 13051304 / 13051311 / 13051312 / 13051315 / 13051317 / 13056212 / 13056312	(28)	





		CODE				
--	--	------	--	---	---	---

IVECO

DAILY II Pritsche / Flatbed 01.89 - 05.99

49-10 (15050304, 15050404, 15050411, 15051204, 15051211...)	05.96 - 05.99	8140.23		3000 951 026 ⊗ 3083 039 031 ⊗ 1878 002 072 ⊙ 3151 600 529	235 10 MFZ235X 235VTB KZISZ-2	Getriebenummer / Transmission Number: 2826.5 15056204 / 15056211 / 15056304 / 15056311 / 15050304 / 15050404 / 15050411 / 15051204 / 15051211 / 15051215 / 15051217 / 15051304 / 15051311 / 15051315 / 15051317 / 15051411 / 15051511	(28)
		8140.23.		3400 700 444 ■	265 10	15050424 / 15050431 / 15051224 / 15051231 / 15051324 / 15051331 / 15051424 / 15051431 / 15051524 / 15051531 / 15054224 / 15054231 / 15054424 / 15054431 / 15056224 / 15056231 / 15056324 / 15056331 Nabenprofil / Hub Profile: 23x29,2x10N	(48)
49-12 (13130211, 13130231, 13130304, 13130311, 13130312...)	06.90 - 04.96	8140.47		3400 117 701 ⊗ 3482 998 701 ⊗ 1878 997 101 ⊙ 3151 600 529	265 10 MFZ265 265VTP KZISZ-2	Getriebenummer / Transmission Number: 2826.5 13136204 / 13136211 / 13136212 / 13136224 / 13136231 / 13136237 / 13136312 / 13136324 / 13136331 / 13136337 / 13130211 / 13130231 / 13130304 / 13130311 / 13130312 / 13130324 / 13130331 / 13130404 / 13130411 / 13130412 / 13130424 / 13130431 / 13131204 / 13131211 / 13131212 / 13131217 / 13131224 / 13131231 / 13131237 / 13131304 / 13131311 / 13131312 / 13131317 / 13131324 / 13131331 / 13131337 / 13131412 / 13131431 / 13131511 / 13131512 / 13131531 / 13131537	(28)
49-12 (15150211, 15150311, 15150404, 15150411, 15151204...)	05.96 - 05.99	8140.43		3400 700 432 ■	280 10 280/Z	Getriebenummer / Transmission Number: 2826.5 15150211 / 15150311 / 15150404 / 15150411 / 15151204 / 15151211 / 15151304 / 15151311 / 15151317 / 15151411 / 15151511 / 15151517 / 15156211 / 15156304 / 15156311 / 15156317 Nabenprofil / Hub Profile: 23x30,55x10N	(48)
59-12 (13150204, 13150211, 13150231, 13150311, 13150312...)	05.91 - 04.96	8140.47		3400 117 701 ⊗ 3482 998 701 ⊗ 1878 997 101 ⊙ 3151 600 529	265 10 MFZ265 265VTP KZISZ-2	Getriebenummer / Transmission Number: 2826.5 13150204 / 13150211 / 13150231 / 13150311 / 13150312 / 13150331 / 13150504 / 13150511 / 13150512 / 13150524 / 13150531 / 13150535 / 13150537 / 13151204 / 13151211 / 13151212 / 13151217 / 13156335 / 13156337 / 13156512 / 13156531 / 13151224 / 13151231 / 13151235 / 13151237 / 13151304 / 13151311 / 13151312 / 13151315 / 13151317 / 13151324 / 13151331 / 13151335 / 13151337 / 13151511 / 13151512 / 13151531 / 13151537 / 13156211 / 13156212 / 13156231 / 13156311 / 13156312 / 13156324 / 13156331	(28)
59-12 (15170211, 15170304, 15170311, 15170504, 15170511...)	05.96 - 05.99	8140.43		3400 700 432 ■	280 10 280/Z	Getriebenummer / Transmission Number: 2826.5 15170211 / 15170304 / 15170311 / 15170504 / 15170511 / 15171204 / 15171211 / 15171215 / 15171217 / 15171304 / 15171311 / 15171315 / 15171317 / 15171511 / 15171517 / 15176211 / 15176304 / 15176311 / 15176315 / 15176317 / 15176511 Nabenprofil / Hub Profile: 23x30,55x10N	(48)





































DAILY III Kasten / Box 11.97 - 10.09

29 L 9 V	05.99 - 07.07	8140.63.		3000 951 026 ⊗ 3083 039 031 ⊗ 1878 002 072 ⊙ 3151 600 529	235 10 MFZ235X 235VTB KZISZ-2		
29 L 11 V	05.99 - 07.07	8140.43C					
29 L 10 V (ALJA43A2, ALJA42A2, ALJA41A2) 29 L 12 V (ALKA41A2, ALLA52A2, ALKA42A2)	09.02 - 07.07	F1AE0481B, F1AE0481A		3400 700 514 ■	280 10	XTend Getr. / GBox: ZF 6S-300A Nabenprofil / Hub Profile: 23x29-10N Nur zusammen verbauen / Only install together	(48)
				6594 000 054	280 280Z	Getr. / GBox: ZF 6S-300A	(53)
				3400 700 433 ■	235 10	Getr. / GBox: ZF S5-200 Nabenprofil / Hub Profile: 23, 1x29,2x10N	(48)
				3981 000 093		Getr. / GBox: ZF 6S-300A	





		CODE				
--	--	------	--	---	---	---

IVECO

DAILY III Kasten / Box 11.97 - 10.09



































29 L 14	01.05 - 04.06	F1AE0481M		3400 700 514 	280 10	XTend Getr. / GBox: ZF 6S-400A OD Nabenprofil / Hub Profile: 23x29-10N Nur zusammen verbauen / Only install together (48) (53)
				6594 000 054	280 280Z	->Mot. 635746 Getr. / GBox: ZF 6S-400A OD
				3400 700 433 	235 10	Getr. / GBox: ZF 5S-300 Nabenprofil / Hub Profile: 23,1x29,2x10N je nach Ausführung, mit unterschiedlicher Kupplung / depending on version, with different clutch (48) (85)
				3400 700 483	267 10	Getr. / GBox: ZF 5S-300 Nabenprofil / Hub Profile: 23,05x30,57x10N je nach Ausführung, mit unterschiedlicher Kupplung / depending on version, with different clutch (48) (85)
				6594 000 054	280 280Z	Getr. / GBox: ZF 5S-300
				3981 000 093		Getr. / GBox: ZF 6S-400A OD
35 C 12 V, 35 S 12 V (AGKA43A2, AGKB43A2, AGKB46A2...)	09.02 - 07.07	F1AE0481B		3400 700 514 	280 10	XTend Nabenprofil / Hub Profile: 23x29-10N Nur zusammen verbauen / Only install together (48) (53)
				6594 000 054	280 280Z	nur als Ersatz für angegebene OE-Nr. / only for the listed OE-Numbers (100)
				3981 000 093 		
		F1AE0481		3400 700 433 	235 10	Getr. / GBox: S5-200 AGKA43A2 / AGKB43A2 / AGKB46A2 / AGKC43A2 / AGKC46A2 / ANKA42A2 / ANKA43A2 / ANKA43AB / ANKAV1A1 / ANLA51A1 / ANLA52A2 / ANLC52A2 Nabenprofil / Hub Profile: 23,1x29,2x10N (48)
35 C 17, 35 S 17	01.05 - 04.06	F1CE0481B		3400 700 515 	280 10	XTend Getr. / GBox: 6S-380A OD Nabenprofil / Hub Profile: 23x29-10N Nur zusammen verbauen / Only install together (48) (53)
				3400 700 448 	280 10 280Z	Getr. / GBox: 6S-380 OD Nabenprofil / Hub Profile: 23x29-10N (48)
35 S 9 V, 35 C 9 V	05.99 - 07.07	8140.43		3000 951 026  3083 039 031  1878 002 072  3151 600 529	235 10 MFZ235X 235VTB KZISZ-2	Getr. / GBox: S5.200
35 S 10 (ANJA41A1, ANJA42A2, ANJA42AB, ANJA43A, ANJAV1A...)	09.02 - 07.07	F1AE0481A		3400 700 514 	280 10	XTend Nabenprofil / Hub Profile: 23x29-10N Nur zusammen verbauen / Only install together (48) (53)
				6594 000 054	280 280Z	nur als Ersatz für angegebene OE-Nr. / only for the listed OE-Numbers (100)
				3981 000 093 		
		F1AE0481		3400 700 433 	235 10	Getr. / GBox: S5-200 AGJB43A2 / ANJA41A1 / ANJA42A2 / ANJA42AB Nabenprofil / Hub Profile: 23,1x29,2x10N (48)
35 S 11 V, 35 C 11 V	05.99 - 07.07	8140.43C		3000 951 026  3083 039 031  1878 002 072  3151 600 529	235 10 MFZ235X 235VTB KZISZ-2	Getr. / GBox: S5.200
35 S 15 V, 35 C 15 V (A6HCV3B2, A6HBV4B2, A6HC41B2...)	11.02 - 07.07	8140.43N		3400 700 432 	280 10 280Z	Getr. / GBox: S6-300 A6HA41B1 / A6HA42B1 / A6HA42B2 / A6HA43B2 / A6HA43B3 / A6HA43BB / A6HA44B2 / A6HA44B3 / A6HA44BB / A6HA44BC / A6HAV2B2 / A6HAV3B2 / A6HAV4B2 / A6HB41B1 / A6HB42B2 / A6HB43B2 / A6HB43B3 / A6HB44B2 / A6HB44B3 / A6HB44BC / A6HBV2B2 / A6HBV3B2 / A6HBV4B2 / A6HC41B2 / A6HC42B2 / A6HC43B2 / A6HC43B3 / A6HC44B2 / A6HC44B3 / A6HC44BB / A6HCV1B2 / A6HCV3B2 / A6HD42B1 / A6HD42B2 / A6HD43B2 / A6HD43B3 / A6HD43BB / A6HD44B2 / A6HD44B3 / A6HDV2B2 / A6HDV4B2 Nabenprofil / Hub Profile: 23x30,55x10N (48)
50 C 11 50 C 13	05.99 - 07.07 05.99 - 07.07	8140.43S, 8140.43C		3400 700 447 	265 10	Nabenprofil / Hub Profile: 23x29-10N (48)



















DAILY III Pritsche / Flatbed 03.98 - 10.09

29 L 9 29 L 11	05.99 - 04.06 05.99 - 04.06	8140.63., 8140.43B, 8140.43C		3000 951 026  3083 039 031  1878 002 072  3151 600 529	235 10 MFZ235X 235VTB KZISZ-2	
-------------------	--------------------------------	------------------------------------	---	---	---	--

		CODE				
--	--	------	--	---	---	---







IVECO

DAILY III Pritsche / Flatbed 03.98 - 10.09						
29 L 10 (ALJAV1A1, ALJA41AA, ALJA41A1, AHJA64A1...) 29 L 12 (ALKA41A1, AHKA64A1, ALLA51A1)	09.02 - 04.06	F1AE0481B, F1AE0481A		3400 700 514 	280 10	XTend Getr. / GBox: ZF 6S-300A Nabenprofil / Hub Profile: 23x29-10N Nur zusammen verbauen / Only install together (48)
	09.02 - 04.06			6594 000 054	280 280Z	Getr. / GBox: ZF 6S-300A (53)
				3400 700 433 	235 10	Getr. / GBox: ZF S5-200 Nabenprofil / Hub Profile: 23,1x29,2x10N (48)
				3981 000 093		Getr. / GBox: ZF 6S-300A
29 L 14 (AHRA11C1B1, AHRA14C1B1, AHRA64C1B1)	11.05 - 04.06	F1AE0481M		3400 700 514 	280 10	XTend Getr. / GBox: ZF 6S-400A OD Nabenprofil / Hub Profile: 23x29-10N Nur zusammen verbauen / Only install together (48)
				6594 000 054	280 280Z	->Mot. 635746 Getr. / GBox: ZF 6S-400A OD (53)
				3400 700 433 	235 10	Getr. / GBox: ZF 5S-300 Nabenprofil / Hub Profile: 23,1x29,2x10N je nach Ausführung, mit unterschiedlicher Kupplung / depending on version, with different clutch (48)
				3400 700 483	267 10	Getr. / GBox: ZF 5S-300 Nabenprofil / Hub Profile: 23,05x30,57x10N je nach Ausführung, mit unterschiedlicher Kupplung / depending on version, with different clutch (85)
				6594 000 054	280 280Z	Getr. / GBox: ZF 5S-300
				3981 000 093		Getr. / GBox: ZF 6S-400A OD
35 C 9, 35 S 9	11.01 - 04.06	8140.43R		3000 951 026 ⊗ 3083 039 031 ⊗ 1878 002 072 ⊗ 3151 600 529	235 10 MFZ235X 235VTB KZISZ-2	Getr. / GBox: S5-200
35 C 10 V, 35 S 10 V (AMJA14A1, AMJA64A1, AMJA65A1...)	09.02 - 04.06	F1AE0481A		3400 700 514 	280 10	XTend Nabenprofil / Hub Profile: 23x29-10N Nur zusammen verbauen / Only install together (48)
				6594 000 054	280 280Z	nur als Ersatz für angegebene OE-Nr. / only for the listed OE-Numbers (100)
			F1AE0481		3400 700 433 	235 10
35 C 12, 35 S 12 (AEKA14A1, AEKA14AA, AEKA64A1...)	09.02 - 04.06	F1AE0481B		3400 700 514 	280 10	XTend Nabenprofil / Hub Profile: 23x29-10N Nur zusammen verbauen / Only install together (48)
				6594 000 054	280 280Z	nur als Ersatz für angegebene OE-Nr. / only for the listed OE-Numbers (100)
			F1AE0481		3400 700 433 	235 10
35 C 15 50 C 15 65 C 15	11.01 - 04.06 01.01 - 04.06 11.01 - 04.06	8140.43N		3400 700 432 	280 10 280Z	Nabenprofil / Hub Profile: 23x30,55x10N (48)
35 C 17, 35 S 17	01.05 - 04.06	F1CE0481B		3400 700 515 	280 10	XTend Getr. / GBox: 6S-380A OD Nabenprofil / Hub Profile: 23x29-10N Nur zusammen verbauen / Only install together (48)
				3400 700 448 	280 10 280Z	Getr. / GBox: 6S-380 OD Nabenprofil / Hub Profile: 23x29-10N (48)
35 S 9, 35 C 9	05.99 - 04.06	8140.43		3000 951 026 ⊗ 3083 039 031 ⊗ 1878 002 072 ⊗ 3151 600 529	235 10 MFZ235X 235VTB KZISZ-2	Getr. / GBox: S5.200
35 S 11, 35 C 11 (A2FC13AA, A6FBU4AB, A2NB14A1, A2ND13A1...)	05.99 - 04.06	8140.43C		3000 951 026 ⊗ 3083 039 031 ⊗ 1878 002 072 ⊗ 3151 600 529	235 10 MFZ235X 235VTB KZISZ-2	Getr. / GBox: S5.200
35 S 13, 35 C 13 50 C 11 50 C 13	05.99 - 04.06 05.99 - 04.06 05.99 - 04.06	8140.43S, 8140.43C		3400 700 447 	265 10	Nabenprofil / Hub Profile: 23x29-10N (48)































DAILY IV Kasten / Box		05.06 - 03.12				
29L10 V	05.06 - 08.11	F1AE0481FA	 3400 700 433 	235 10	Getr. / GBox: ZF 5S-300 Nabenprofil / Hub Profile: 23,1x29,2x10N	(48)
			 3400 700 483	267 10	Getr. / GBox: ZF 5S-300 GHAHV1A2 / GHAHV2A2 Nabenprofil / Hub Profile: 23,05x30,57x10N	(48)
			 6594 000 054	280 280Z	Getr. / GBox: ZF 5S-300 GHAHV1A2 / GHAHV2A2	
			 3400 700 514 	280 10	XTend Getr. / GBox: ZF 6S-400A OD Nabenprofil / Hub Profile: 23x29-10N Nur zusammen verbauen / Only install together	(48) (53)
			 6594 000 054	280 280Z	-> Mot. 635746 Getr. / GBox: ZF 6S-400A OD	
			 3981 000 093		Getr. / GBox: ZF 6S-400A OD	
29L12 V, 29L12 V/P 29L14 C, 29L14 C/P, 29L14 V, 29L14 V/P	05.06 - 08.11	F1AE0481GA, F1AE0481HA	 3400 700 514 	280 10	XTend Getr. / GBox: ZF 6S-400A OD Nabenprofil / Hub Profile: 23x29-10N Nur zusammen verbauen / Only install together	(48) (53)
	05.06 - 08.11		 6594 000 054	280 280Z	-> Mot. 635746 Getr. / GBox: ZF 6S-400A OD	
			 3400 700 433 	235 10	Getr. / GBox: ZF 5S-300 Nabenprofil / Hub Profile: 23,1x29,2x10N je nach Ausführung, mit unterschiedlicher Kupplung / depending on version, with different clutch	(48) (85)
			 3400 700 483	267 10	Getr. / GBox: ZF 5S-300 Nabenprofil / Hub Profile: 23,05x30,57x10N je nach Ausführung, mit unterschiedlicher Kupplung / depending on version, with different clutch	(48) (85)
			 6594 000 054	280 280Z	Getr. / GBox: ZF 5S-300	
			 3981 000 093		Getr. / GBox: ZF 6S-400A OD	
35C11 V, 35S11 V 35C13 V, 35C13 V/P, 35S13 V, 35S13 V/P 40C11 V	07.07 - 08.11	F1AE0481FA, F1AE0481GA	 3400 700 653 	280 280Z	Getr. / GBox: 2830.5	
	07.07 - 08.11		3400 700 653 	280 280Z	Getr. / GBox: 2835.6	
	07.07 - 08.11					

		CODE				
--	--	-------------	--	---	---	---

IVECO

DAILY IV Kasten / Box		05.06 - 03.12					
35C12 V, 35C12 V/P, 35S12 V, 35S12 V/P	05.06 - 08.11	F1AE0481GA		3400 700 433 ■	235 10	Getr. / GBox: ZF 5S-300 GCBA11A1 / GCBA14A1 / GCBA14AA / GCBA15A1 / GCBA15AA / GCBA17A1 / GCBA17AA / GCBA65A1 / GCBA65AA / GCBA67A1 / GCBA7AA / GCBB11A1 / GCBB11AA / GCBB14A1 / GCBB14AA / GCBB15A1 / GCBB15AA / GCBB17A1 / GCBB17AA / GCBB64A1 / GCBB64AA / GCBB65A1 / GCBB65AA / GCBB67A1 / GCBB67AA / GCBBR4A1 / GCBC14A1 / GCBC15A1 / GCBC15AA / GCBC64A1 / GCBD11A1 / GCBD14A1 / GCBD15A1 / GCBD17A1 / GCBD65A1 / GCBD67A1 / GJBA42A2 / GJBA42AA / GJBA43A2 / GJBA43A3 / GJBA43AB / GJBA43AC / GJBA46A2 / GJBA46A3 / GJBA46AB GJBA46AC / GJB4V6A2 / GJBB41A1 / GJBB42A1 / GJBB42A2 / GJBB43A2 / GJBB43A3 / GJBB43AB / GJBB46A2 / GJBB46A3 / GJBB46AC / GJBBV3A2 / GJBBV6A2 / GJBC43A2 / GJBD43A2 / GJBD46A2 / GJBD46A3 Nabenprofil / Hub Profile: 23,1x29,2x10N	(48)
				3400 700 514 ●■	280 10	XTend Getr. / GBox: ZF 6S-400A OD GCBA11CA / GCBA14C1 / GCBA14CA / GCBA15C1 / GCBA15CA / GCBA17C1 / GCBA17CA / GCBA65C1 / GCBA65CA / GCBB11C1 / GCBB11CA / GCBB14C1 / GCBB14CA / GCBB15C1 / GCBB15CA / GCBB17C1 / GCBB64C1 / GCBB65C1 / GCBB65CA / GCBD11C1 / GCBD14C1 / GCBD17C1 / GJBA41C1 / GJBA43C2 / GJBA43CB / GJBA46C3 / GJBBU3C2 / GJBBV3C2 / GJBD43C2 Nabenprofil / Hub Profile: 23x29-10N Nur zusammen verbauen / Only install together	(48) (53)
				6594 000 054	280 280Z	Getr. / GBox: ZF 6S-400A OD GCBA11CA / GCBA14C1 / GCBA14CA / GCBA15C1 / GCBA15CA / GCBA17C1 / GCBA17CA / GCBA65C1 / GCBA65CA / GCBB11C1 / GCBB11CA / GCBB14C1 / GCBB14CA / GCBB15C1 / GCBB15CA / GCBB17C1 / GCBB64C1 / GCBB65C1 / GCBB65CA / GCBD11C1 / GCBD14C1 / GCBD17C1 / GJBA41C1 / GJBA43C2 / GJBA43CB / GJBA46C3 / GJBBU3C2 / GJBBV3C2 / GJBD43C2	
				3981 000 093		Getr. / GBox: ZF 6S-400A OD GCBA11CA / GCBA14C1 / GCBA14CA / GCBA15C1 / GCBA15CA / GCBA17C1 / GCBA17CA / GCBA65C1 / GCBA65CA / GCBB11C1 / GCBB11CA / GCBB14C1 / GCBB14CA / GCBB15C1 / GCBB15CA / GCBB17C1 / GCBB64C1 / GCBB65C1 / GCBB65CA / GCBD11C1 / GCBD14C1 / GCBD17C1 / GJBA41C1 / GJBA43C2 / GJBA43CB / GJBA46C3 / GJBBU3C2 / GJBBV3C2 / GJBD43C2	
35C14 V, 35C14 V/P, 35S14 V, 35S14 V/P	07.07 - 08.11	F1CE0441A, F1CE3481C, F1CE0481L, F1CE0481A, F1CE0481HA, F1CE3481LC		3400 700 646 ©	280 280/Z	Getr. / GBox: 2840.6	
35C14 GV, 35C14 GV/P, 35S14 GV, 35S14 GV/P	07.07 - 08.11						
35S15	06.06 - 08.11						
35S14	07.07 - 08.11						
45C17 V, 45C17 V/P	07.07 - 08.11						
50C14 GV, 50C14 GV/P	07.07 - 08.11						
50C14 V, 50C14 V/P	07.07 - 08.11						
55C16	08.07 - 03.12						
55C17	08.07 - 03.12						
60C17 V, 60C17 V/P	07.07 - 08.11						
65C14 V, 65C14 V/P	07.07 - 08.11						
35C15 V, 35C15 V/P	05.06 - 08.11	F1CE0481FA		3400 700 515 ●■	280 10	XTend Getr. / GBox: 6S-400A OD Nabenprofil / Hub Profile: 23x29-10N Nur zusammen verbauen / Only install together	(48) (53)
				3400 700 448 ■	280 10 280/Z	Getr. / GBox: 6S-400 OD Nabenprofil / Hub Profile: 23x29-10N	(48)











IVECO

DAILY IV Kasten / Box		05.06 - 03.12						
35C17 V, 35C17 V/P, 35S17 V, 35S17 V/P 40C17 V, 40C17 V/P 50C17 V, 50C17 V/P 65C17 V, 65C17 V/P	07.07 - 08.11	F1CE0481HA		3400 700 515 	280 10	XTend Getr. / GBox: 6S-400A OD Nabenprofil / Hub Profile: 23x29-10N Nur zusammen verbauen / Only install together	(48) (53)	
	07.07 - 08.11			3400 700 646 	280 280/Z	Getr. / GBox: 2840.6		
	07.07 - 08.11			3400 700 448 	280 10 280/Z	Getr. / GBox: 6S-400 OD Nabenprofil / Hub Profile: 23x29-10N	(48)	
	07.07 - 08.11			3151 600 529 	KZISZ-2	Getr. / GBox: 6S-380A OD Getr. / GBox: 6S-400A OD		
35C18 V, 35C18 V/P, 35S18 V, 35S18 V/P	05.06 - 08.11	F1CE0481		3400 700 515 	280 10	XTend Getr. / GBox: 6S-380A OD Getr. / GBox: 6S-400A OD Nabenprofil / Hub Profile: 23x29-10N Nur zusammen verbauen / Only install together	(48) (53)	
		F1CE0481HA		3400 700 448 	280 10 280/Z	Getr. / GBox: 6S-380 OD Nabenprofil / Hub Profile: 23x29-10N	(48)	
35S14 C, 35S14 C/P, 35S14 V, 35S14 V/P, 35C14 V, 35C14 V/P 40C12 V, 40C14 V/P 40C10 V	05.06 - 08.11	F1AE0481FA, F1AE0481GA, F1AE0481HA		3400 700 514 	280 10	XTend Nabenprofil / Hub Profile: 23x29-10N Nur zusammen verbauen / Only install together	(48) (53)	
	05.06 - 08.11			6594 000 054	280 280Z	nur als Ersatz für angegebene OE-Nr. / only for the listed OE-Numbers	(100)	
	05.06 - 08.11			3981 000 093 				
40C14 GV, 40C14 GV/P 40C14 V, 40C14 V/P	07.07 - 08.11	F1CE0441A, F1CE3481LC		3400 700 432 	280 10 280/Z	Getr. / GBox: 6S-400 OD Nabenprofil / Hub Profile: 23x30,55x10N	(48)	
	07.07 - 08.11			3400 700 483	267 10	Getr. / GBox: 5S-300 Nabenprofil / Hub Profile: 23,05x30,57x10N	(48)	
				3400 700 646 	280 280/Z	Getr. / GBox: 2840.6		
				6594 000 054	280 280Z	->Mot. 635746 Getr. / GBox: 5S-300		
40C15 V, 40C15 V/P 40C18 V, 40C18 V/P 45C15 V 45C18 50C15 V, 50C15 V/P 50C18 V, 50C18 V/P 60C15 V 60C18 65C15 65C18	05.06 - 08.11	F1CE0481		3400 700 515 	280 10	XTend Getr. / GBox: 6S-380A OD Getr. / GBox: 6S-400A OD Nabenprofil / Hub Profile: 23x29-10N Nur zusammen verbauen / Only install together	(48) (53)	
	05.06 - 08.11			3151 600 529	KZISZ-2	Getr. / GBox: 6S-380A OD Getr. / GBox: 6S-400A OD		
	05.06 - 08.11							
	05.06 - 08.11							
	05.06 - 08.11							
	05.06 - 08.11							
	05.06 - 08.11							
	05.06 - 08.11							
	05.06 - 08.11							
	05.06 - 08.11							
70C14 V, 70C14 V/P 70C17V, 70C17 V/P	07.07 - 08.11	F1CE0481HA, F1CE3481LC		3400 700 514 	280 10	XTend Getr. / GBox: ZF 6S-400A OD Nabenprofil / Hub Profile: 23x29-10N Nur zusammen verbauen / Only install together	(48) (53)	
	07.07 - 08.11			6594 000 054	280 280Z	->Mot. 635746 Getr. / GBox: ZF 6S-400A OD		
				3400 700 483	267 10	Getr. / GBox: ZF 6S-400 OD Nabenprofil / Hub Profile: 23,05x30,57x10N	(48)	
				6594 000 054	280 280Z	Getr. / GBox: ZF 6S-400 OD		
				3400 700 646 	280 280/Z	Getr. / GBox: 2840.6		
				3981 000 093		Getr. / GBox: ZF 6S-400A OD		





















		CODE				
--	--	------	--	---	---	---

IVECO

DAILY IV Kipper / Dumptruck 05.06 - 08.11

35C10 K	05.06 - 08.11	F1AE0481FA		3400 700 433 ■	235 10	GCAA11A1 / GCAA11AA / GCAA14A1 / GCAA14AA / GCAA15A1 / GCAA17A1 / GCAA64A1 / GCAA65A1 / GCAA67A1 / GCAB14A1 / GCAB14AA / GCAB15A1 / GCAB17A1 / GCAB64A1 / GCAB65A1 / GCAB67A1 / GJAA42A1 / GJAA43A2 / GJAA46A2 / GJAA46A3 / GJAB42A2 / GJAB43A2 / GJAB43A3 / GJAB46A2 / GJAB46A3 Nabenprofil / Hub Profile: 23,1x29,2x10N (48)
				3400 700 514 ◉■	280 10	XTend ->Mot. 635746 Getr. / GBox: ZF 6S-400A OD GCAA11CA / GCAA14C1 / GCAA15C1 / GCAA64C1 / GCAB11C1 / GCAB11CA / GCAB14C1 / GCAB15C1 / GCAB64C1 Nabenprofil / Hub Profile: 23x29-10N (48) Nur zusammen verbauen / Only install together (53)
				6594 000 054	280 280Z	->Mot. 635746 Getr. / GBox: ZF 6S-400A OD GCAA11CA / GCAA14C1 / GCAA15C1 / GCAA64C1 / GCAB11C1 / GCAB11CA / GCAB14C1 / GCAB15C1 / GCAB64C1
				3981 000 093		->Mot. 635746 Getr. / GBox: ZF 6S-400A OD GCAA11CA / GCAA14C1 / GCAA15C1 / GCAA64C1 / GCAB11C1 / GCAB11CA / GCAB14C1 / GCAB15C1 / GCAB64C1
35C11 K, 35C11 DK, 35S11 K, 35S11 DK 35C13 K, 35C13 DK, 35S13 K, 35S13 DK 35S14 K, 35S14 DK	07.07 - 08.11	F1AE0481FA, F1AE0481GA, F1AE0481HA		3400 700 653 ⑤	280 280Z	Getr. / GBox: 2830.5
	07.07 - 08.11			3400 700 653 ⑥	280 280Z	Getr. / GBox: 2835.6
	07.07 - 08.11					
35C12	05.06 - 08.11	F1AE0481GA		3400 700 433 ■	235 10	Getr. / GBox: ZF 5S-300 GCBA11A1 / GCBA14A1 / GCBA14AA / GCBA15A1 / GCBA15AA / GCBA17A1 / GCBA17AA / GCBA65A1 / GCBA65AA / GCBA67A1 / GCBA7AA / GCBB11A1 / GCBB11AA / GCBB14A1 / GCBB14AA / GCBB15A1 / GCBB15AA / GCBB17A1 / GCBB17AA / GCBB64A1 / GCBB64AA / GCBB65A1 / GCBB65AA / GCBB67A1 / GCBB67AA / GCBBR4A1 / GCBC14A1 / GCBC15A1 / GCBC15AA / GCBC64A1 / GCBD11A1 / GCBD14A1 / GCBD15A1 / GCBD17A1 / GCBD65A1 / GCBD67A1 / GJBA42A2 / GJBA42AA / GJBA43A2 / GJBA43A3 / GJBA43AB / GJBA43AC / GJBA46A2 / GJBA46A3 / GJBA46AB GJBA46AC / GJBVA6A2 / GJBB41A1 / GJBB42A1 / GJBB42A2 / GJBB43A2 / GJBB43A3 / GJBB43AB / GJBB46A2 / GJBB46A3 / GJBB46AC / GJBBV3A2 / GJBBV6A2 / GJBC43A2 / GJBD43A2 / GJBD46A2 / GJBD46A3 Nabenprofil / Hub Profile: 23,1x29,2x10N (48)
				3400 700 514 ◉■	280 10	XTend Getr. / GBox: ZF 6S-400A OD GCBA11CA / GCBA14C1 / GCBA14CA / GCBA15C1 / GCBA15CA / GCBA17C1 / GCBA17CA / GCBA65C1 / GCBA65CA / GCBB11C1 / GCBB11CA / GCBB14C1 / GCBB14CA / GCBB15C1 / GCBB15CA / GCBB17C1 / GCBB64C1 / GCBB65C1 / GCBB65CA / GCBD11C1 / GCBD14C1 / GCBD17C1 / GJBA41C1 / GJBA43C2 / GJBA43CB / GJBA46C3 / GJBBU3C2 / GJBBV3C2 / GJBD43C2 Nabenprofil / Hub Profile: 23x29-10N (48) Nur zusammen verbauen / Only install together (53)
				6594 000 054	280 280Z	Getr. / GBox: ZF 6S-400A OD GCBA11CA / GCBA14C1 / GCBA14CA / GCBA15C1 / GCBA15CA / GCBA17C1 / GCBA17CA / GCBA65C1 / GCBA65CA / GCBB11C1 / GCBB11CA / GCBB14C1 / GCBB14CA / GCBB15C1 / GCBB15CA / GCBB17C1 / GCBB64C1 / GCBB65C1 / GCBB65CA / GCBD11C1 / GCBD14C1 / GCBD17C1 / GJBA41C1 / GJBA43C2 / GJBA43CB / GJBA46C3 / GJBBU3C2 / GJBBV3C2 / GJBD43C2
				3981 000 093		Getr. / GBox: ZF 6S-400A OD GCBA11CA / GCBA14C1 / GCBA14CA / GCBA15C1 / GCBA15CA / GCBA17C1 / GCBA17CA / GCBA65C1 / GCBA65CA / GCBB11C1 / GCBB11CA / GCBB14C1 /

DAILY IV Kipper / Dumptruck 05.06 - 08.11

35C15	05.06 - 08.11	F1CE0481FA		3400 700 515 	280 10	XTend Getr. / GBox: 6S-400A OD Nabenprofil / Hub Profile: 23x29-10N Nur zusammen verbauen / Only install together	(48) (53)
				3400 700 448 	280 10 280/Z	Getr. / GBox: 6S-400 OD Nabenprofil / Hub Profile: 23x29-10N	(48)
35C14 K, 35C14 DK, 35S14 K, 35S14 DK	07.07 - 08.11	F1CE0481HA, F1CE3481LC		3400 700 646 	280 280/Z	Getr. / GBox: 2840.6	
60C14 K, 60C14 DK	07.07 - 08.11						
60C17 K, 60C17 DK	07.07 - 08.11						
65C14 K, 65C14 DK	07.07 - 08.11						
35C17 K, 35C17 DK, 35S17 K, 35S17 DK	07.07 - 08.11	F1CE0481HA		3400 700 515 	280 10	XTend Getr. / GBox: 6S-400A OD Nabenprofil / Hub Profile: 23x29-10N Nur zusammen verbauen / Only install together	(48) (53)
				3400 700 646 	280 280/Z	Getr. / GBox: 2840.6	
				3400 700 448 	280 10 280/Z	Getr. / GBox: 6S-400 OD Nabenprofil / Hub Profile: 23x29-10N	(48)
35C18	05.06 - 08.11	F1CE0481		3400 700 515 	280 10	XTend Getr. / GBox: 6S-380A OD Getr. / GBox: 6S-400A OD Nabenprofil / Hub Profile: 23x29-10N Nur zusammen verbauen / Only install together	(48) (53)
		F1CE0481HA		3400 700 448 	280 10 280/Z	Getr. / GBox: 6S-380 OD Nabenprofil / Hub Profile: 23x29-10N	(48)
40C14 K, 40C14 DK	07.07 - 08.11	F1CE3481LC		3400 700 432 	280 10 280/Z	Getr. / GBox: 6S-400 OD Nabenprofil / Hub Profile: 23x30,55x10N	(48)
				3400 700 483	267 10	Getr. / GBox: 5S-300 Nabenprofil / Hub Profile: 23,05x30,57x10N	(48)
				3400 700 646 	280 280/Z	Getr. / GBox: 2840.6	
				6594 000 054	280 280Z	->Mot. 635746 Getr. / GBox: 5S-300	
50C15 50C18 60C15 60C18	05.06 - 08.11	F1CE0481		3400 700 515 	280 10	XTend Getr. / GBox: 6S-380A OD Getr. / GBox: 6S-400A OD Nabenprofil / Hub Profile: 23x29-10N Nur zusammen verbauen / Only install together	(48) (53)
				3151 600 529	KZISZ-2	Getr. / GBox: 6S-380A OD Getr. / GBox: 6S-400A OD	
70C14 K, 70C14 DK, 70C14 KK 70C17 K, 70C17 DK, 70C17 KK	07.07 - 08.11	F1CE0481HA, F1CE3481LC		3400 700 514 	280 10	XTend Getr. / GBox: ZF 6S-400A OD Nabenprofil / Hub Profile: 23x29-10N Nur zusammen verbauen / Only install together	(48) (53)
				6594 000 054	280 280Z	->Mot. 635746 Getr. / GBox: ZF 6S-400A OD	
				3400 700 483	267 10	Getr. / GBox: ZF 6S-400 OD Nabenprofil / Hub Profile: 23,05x30,57x10N	(48)
				6594 000 054	280 280Z	Getr. / GBox: ZF 6S-400 OD	
				3400 700 646 	280 280/Z	Getr. / GBox: 2840.6	
				3981 000 093		Getr. / GBox: ZF 6S-400A OD	

DAILY V Kasten/Kombi 09.11 - 02.14

29L11 V, 35C11 V, 35S11 V, 40C11 V	09.11 - 02.14	F1AE3481B, F1AE3481A		3400 700 653 	280 280/Z	Getr. / GBox: 2830.5	
				3400 700 653 	280 280/Z	Getr. / GBox: 2835.6	
29L13 V, 35C13 V, 35S13 V, 40C13 V, 40S13 V	09.11 - 02.14						
29L15 V, 35C15L V, 40C15L V, 50C15L V	09.11 - 02.14	F1AE3481C		3400 700 653 	280 280/Z	Getr. / GBox: 2835.6	
				3400 700 637 	268 10	Nabenprofil / Hub Profile: 23x29-10N	(48)
				3400 700 653 	280 280/Z	Getr. / GBox: 2830.5	

		CODE				
--	--	------	--	---	---	---

IVECO





DAILY V Kasten/Kombi 09.11 - 02.14

35C15 V, 40C15 V 35 S 14	09.11-02.14 04.12-02.14	F1CE3481L, F1CE3481C, F1CE3481J, F1CE3481K		3400 700 646 	280 280/Z	Getr. / GBox: 2840.6	
35C17 V, 35S17 V, 40C17 V, 45C17 V, 50C17 V, 60C17 V,	09.11-02.14						

















DAILY V Kipper 09.11 - 02.14

35C11K, 35S11DKP 35C13K, 35C13DKP	09.11-02.14 09.11-02.14	F1AE3481B, F1AE3481A		3400 700 653 	280 280/Z	Getr. / GBox: 2830.5	
				3400 700 653 	280 280/Z	Getr. / GBox: 2835.6	
35C15K, 35S15DKP, 50C15K, 60C15K, 65C15DK, 70C15K 35C17K, 35S17DKP, 50C17K, 65C17DK 70C17K	09.11-02.14 09.11-02.14	F1CE3481C, F1CE3481L, F1CE3481K		3400 700 646 	280 280/Z	Getr. / GBox: 2840.6	

DAILY V Pritsche/Fahrgestell 09.11 - 02.14

26L11, 26L11D, 35C11D, 35S11, 40C11	09.11-02.14	F1AE3481C, F1AE3481B, F1AE3481A		3400 700 653 	280 280/Z	Getr. / GBox: 2830.5	
29L13, 29L13D, 35C13D, 40C13	09.11-02.14			3400 700 653 	280 280/Z	Getr. / GBox: 2835.6	
29L15 V, 35C15L V, 40C15L V, 50C15L V	09.11-02.14						
35C15, 35C15D, 35S15, 40C15, 45C15, 50C15, 60C15, 70C15 35C17, 35C17D, 35S17, 40C17, 45C17, 50C17, 60C17, 70C17	09.11-02.14 09.11-02.14	F1CE3481C, F1CE3481L, F1CE3481J, F1CE3481K		3400 700 646 	280 280/Z	Getr. / GBox: 2840.6	

DAILY IV Pritsche / Flatbed 05.06 - 09.11

29L10	05.06-08.11	F1AE0481FA		3400 700 433 	235 10	Getr. / GBox: ZF 5S-300 Nabenprofil / Hub Profile: 23,1x29,2x10N	(48)
				3400 700 483	267 10	Getr. / GBox: ZF 5S-300 GHAHV1A2 / GHAHV2A2 Nabenprofil / Hub Profile: 23,05x30,57x10N	(48)
				6594 000 054	280 280Z	Getr. / GBox: ZF 5S-300 GHAHV1A2 / GHAHV2A2	
				3400 700 514 	280 10	XTend Getr. / GBox: ZF 6S-400A OD Nabenprofil / Hub Profile: 23x29-10N Nur zusammen verbauen / Only install together	(48) (53)
				6594 000 054	280 280Z	->Mot. 635746 Getr. / GBox: ZF 6S-400A OD	
				3981 000 093		Getr. / GBox: ZF 6S-400A OD	
29L12 29L14	05.06-08.11 05.06-08.11	F1AE0481GA, F1AE0481HA		3400 700 514 	280 10	XTend Getr. / GBox: ZF 6S-400A OD Nabenprofil / Hub Profile: 23x29-10N Nur zusammen verbauen / Only install together	(48) (53)
				6594 000 054	280 280Z	->Mot. 635746 Getr. / GBox: ZF 6S-400A OD	
				3400 700 433 	235 10	Getr. / GBox: ZF 5S-300 Nabenprofil / Hub Profile: 23,1x29,2x10N je nach Ausführung, mit unterschiedlicher Kupplung / depending on version, with different clutch	(48) (85)
				3400 700 483	267 10	Getr. / GBox: ZF 5S-300 Nabenprofil / Hub Profile: 23,05x30,57x10N je nach Ausführung, mit unterschiedlicher Kupplung / depending on version, with different clutch	(48) (85)
				6594 000 054	280 280Z	Getr. / GBox: ZF 5S-300	
				3981 000 093		Getr. / GBox: ZF 6S-400A OD	

































IVECO

DAILY IV Pritsche / Flatbed 05.06 - 09.11

35C10, 35S10	05.06 - 08.11	F1AE0481FA	3400 700 433	235 10	Getr. / GBox: ZF 5S-300 GCAA11A1 / GCAA11AA / GCAA14A1 / GCAA14AA / GCAA15A1 / GCAA17A1 / GCAA64A1 / GCAA65A1 / GCAA67A1 / GCAB14A1 / GCAB14AA / GCAB15A1 / GCAB17A1 / GCAB64A1 / GCAB65A1 / GCAB67A1 / GJAA42A1 / GJAA43A2 / GJAA46A2 / GJAA46A3 / GJAB42A2 / GJAB43A2 / GJAB43A3 / GJAB46A2 / GJAB46A3 Nabenprofil / Hub Profile: 23, 1x29, 2x10N	(48)
			3400 700 514	280 10	XTend ->Mot. 635746 Getr. / GBox: ZF 6S-400A OD GCAA11CA / GCAA14C1 / GCAA15C1 / GCAA64C1 / GCAB11C1 / GCAB11CA / GCAB14C1 / GCAB15C1 / GCAB64C1 Nabenprofil / Hub Profile: 23x29-10N Nur zusammen verbauen / Only install together	(48) (53)
			6594 000 054	280 280Z	->Mot. 635746 Getr. / GBox: ZF 6S-400A OD GCAA11CA / GCAA14C1 / GCAA15C1 / GCAA64C1 / GCAB11C1 / GCAB11CA / GCAB14C1 / GCAB15C1 / GCAB64C1	
			3981 000 093		->Mot. 635746 Getr. / GBox: ZF 6S-400A OD GCAA11CA / GCAA14C1 / GCAA15C1 / GCAA64C1 / GCAB11C1 / GCAB11CA / GCAB14C1 / GCAB15C1 / GCAB64C1	
35C11, 35S11, 35S11 D, 35S11 /P 35C13, 35C13 /P, 35S13 D, 35S13, 35S13 /P 40C11, 40C11 D 40C13, 40C13 /P	07.07 - 08.11	F1AE0481FA, F1AE0481GA	3400 700 653	280 280Z	Getr. / GBox: 2830.5	
			3400 700 653	280 280Z	Getr. / GBox: 2835.6	
35C12, 35S12	05.06 - 08.11	F1AE0481GA	3400 700 433	235 10	Getr. / GBox: ZF 5S-300 GCBA11A1 / GCBA14A1 / GCBA14AA / GCBA15A1 / GCBA15AA / GCBA17A1 / GCBA17AA / GCBA65A1 / GCBA65AA / GCBA67A1 / GCBA7AA / GCBB11A1 / GCBB11AA / GCBB14A1 / GCBB14AA / GCBB15A1 / GCBB15AA / GCBB17A1 / GCBB17AA / GCBB64A1 / GCBB64AA / GCBB65A1 / GCBB65AA / GCBB67A1 / GCBB67AA / GCBBR4A1 / GCBC14A1 / GCBC15A1 / GCBC15AA / GCBC64A1 / GCB11A1 / GCB14A1 / GCB15A1 / GCB17A1 / GCB65A1 / GCB67A1 / GJBA42A2 / GJBA42AA / GJBA43A2 / GJBA43A3 / GJBA43AB / GJBA43AC / GJBA46A2 / GJBA46A3 / GJBA46AB GJBA46AC / GJB46A2 / GJBB41A1 / GJBB42A1 / GJBB42A2 / GJBB43A2 / GJBB43A3 / GJBB43AB / GJBB46A2 / GJBB46A3 / GJBB46AC / GJBBV3A2 / GJBBV6A2 / GJBC43A2 / GJBD43A2 / GJBD46A2 / GJBD46A3 Nabenprofil / Hub Profile: 23, 1x29, 2x10N	(48)
			3400 700 514	280 10	XTend Getr. / GBox: ZF 6S-400A OD GCBA11CA / GCBA14C1 / GCBA14CA / GCBA15C1 / GCBA15CA / GCBA17C1 / GCBA17CA / GCBA65C1 / GCBA65CA / GCBB11C1 / GCBB11CA / GCBB14C1 / GCBB14CA / GCBB15C1 / GCBB15CA / GCBB17C1 / GCBB64C1 / GCBB65C1 / GCBB65CA / GCB11C1 / GCB14C1 / GCB17C1 / GJBA41C1 / GJBA43C2 / GJBA43CB / GJBA46C3 / GJBBU3C2 / GJBBV3C2 / GJBD43C2 Nabenprofil / Hub Profile: 23x29-10N Nur zusammen verbauen / Only install together	(48) (53)
			6594 000 054	280 280Z	Getr. / GBox: ZF 6S-400A OD GCBA11CA / GCBA14C1 / GCBA14CA / GCBA15C1 / GCBA15CA / GCBA17C1 / GCBA17CA / GCBA65C1 / GCBA65CA / GCBB11C1 / GCBB11CA / GCBB14C1 / GCBB14CA / GCBB15C1 / GCBB15CA / GCBB17C1 / GCBB64C1 / GCBB65C1 / GCBB65CA / GCB11C1 / GCB14C1 / GCB17C1 / GJBA41C1 / GJBA43C2 / GJBA43CB / GJBA46C3 / GJBBU3C2 / GJBBV3C2 / GJBD43C2	
			3981 000 093		Getr. / GBox: ZF 6S-400A OD GCBA11CA / GCBA14C1 / GCBA14CA /	

		CODE				
--	--	------	--	---	---	---











IVECO

DAILY IV Pritsche / Flatbed 05.06 - 09.11						
35C14, 35C14 /P, 35S14, 35S14 /P, 35S14 D, 35S14 D/P 35C14 G, 35C14 G/P, 35S14 G, 35S14 G/P, 35C14 GD, 35S14 GD 45C14, 45C14 /P 45C17, 45C17 /P 50C14, 50C14 /P 50C14 G, 50C14 G/P, 50C14 GD, 50C14 GD/P 55S17 W, 55S17 WD 60C14, 60C14 /P 60C17, 60C17 /P 65C14, 65C14 /P 65C14 G, 65C14 G/P, 65C14 GD, 65C14 GD/P	07.07 - 08.11 07.07 - 08.11 07.07 - 08.11 07.07 - 08.11 07.07 - 08.11 07.07 - 08.11 07.07 - 08.11 07.07 - 08.11 07.07 - 08.11 07.07 - 08.11 07.07 - 08.11	F1CE0441A, F1CE0481HA, F1CE3481LC		3400 700 646 	280 280/Z	Getr. / GBox: 2840.6
35C15	05.06 - 08.11	F1CE0481FA		3400 700 515 	280 10	XTend Getr. / GBox: 6S-400A OD Nabenprofil / Hub Profile: 23x29-10N Nur zusammen verbauen / Only install together (48) (53)
				3400 700 448 	280 10 280/Z	Getr. / GBox: 6S-400 OD Nabenprofil / Hub Profile: 23x29-10N (48)
35C17, 35C17 /P, 35S17, 35S17 /P, 35S17 D 35S17 W, 35S17 WD 40C17, 40C17 /P 50C17, 50C17 /P 65C17, 65C17 /P	07.07 - 08.11 07.07 - 08.11 07.07 - 08.11 07.07 - 08.11 07.07 - 08.11	F1CE0481HA		3400 700 515 	280 10	XTend Getr. / GBox: 6S-400A OD Nabenprofil / Hub Profile: 23x29-10N Nur zusammen verbauen / Only install together (48) (53)
				3400 700 646 	280 280/Z	Getr. / GBox: 2840.6
				3400 700 448 	280 10 280/Z	Getr. / GBox: 6S-400 OD Nabenprofil / Hub Profile: 23x29-10N (48)
35C18, 35S18	05.06 - 08.11	F1CE0481		3400 700 515 	280 10	XTend Getr. / GBox: 6S-380A OD Getr. / GBox: 6S-400A OD Nabenprofil / Hub Profile: 23x29-10N Nur zusammen verbauen / Only install together (48) (53)
				3151 600 529	KZISZ-2	Getr. / GBox: 6S-380A OD Getr. / GBox: 6S-400A OD
		F1CE0481HA		3400 700 448 	280 10 280/Z	Getr. / GBox: 6S-380 OD Nabenprofil / Hub Profile: 23x29-10N (48)
35C14, 35S14, 35S14 /P	05.06 - 08.11	F1AE0481HA		3400 700 514 	280 10	XTend Nabenprofil / Hub Profile: 23x29-10N Nur zusammen verbauen / Only install together (48) (53)
				3400 700 653 	280 280/Z	Getr. / GBox: 2835.6
				3400 700 653 	280 280/Z	Getr. / GBox: 2830.5
				6594 000 054	280 280Z	nur als Ersatz für angegebene OE-Nr. / only for the listed OE-Numbers (100)
				3981 000 093 		
40C10 40C12	05.06 - 08.11 05.06 - 08.11	F1AE0481FA, F1AE0481GA		3400 700 514 	280 10	XTend Nabenprofil / Hub Profile: 23x29-10N Nur zusammen verbauen / Only install together (48) (53)
				6594 000 054	280 280Z	nur als Ersatz für angegebene OE-Nr. / only for the listed OE-Numbers (100)
				3981 000 093 		
40C14, 40C14 /P 40C14 G, 40C14 G/P	07.07 - 08.11 07.07 - 08.11	F1CE0441A, F1CE3481LC		3400 700 432 	280 10 280/Z	Getr. / GBox: 6S-400 OD Nabenprofil / Hub Profile: 23x30,55x10N (48)
				3400 700 483	267 10	Getr. / GBox: 5S-300 Nabenprofil / Hub Profile: 23,05x30,57x10N (48)
				3400 700 646 	280 280/Z	Getr. / GBox: 2840.6
				6594 000 054	280 280Z	->Mot. 635746 Getr. / GBox: 5S-300











		CODE				
--	--	------	--	---	---	---

IVECO











DAILY IV Pritsche / Flatbed 05.06 - 09.11

40C15	05.06 - 08.11	F1CE0481		3400 700 515 	280 10	XTend Getr. / GBox: 6S-380A OD Getr. / GBox: 6S-400A OD Nabenprofil / Hub Profile: 23x29-10N Nur zusammen verbauen / Only install together	(48) (53)
40C18	05.06 - 08.11						
45C15	05.06 - 08.11						
45C18, 45C18 /P, 45C18 D, 45C18 D/P	05.06 - 08.11						
50C15	05.06 - 08.11			3151 600 529		KZISZ-2 Getr. / GBox: 6S-380A OD Getr. / GBox: 6S-400A OD	
50C18	05.06 - 08.11						
60C15, 60C15 /P, 60C15 D, 60C15 D/P	05.06 - 08.11						
60C18	05.06 - 08.11						
65C15, 65C15 /P, 65C15 D, 65C15 D/P	05.06 - 08.11						
65C18	05.06 - 08.11						
70C14, 70C14 /P	07.07 - 08.11	F1CE0481HA, F1CE3481LC		3400 700 514 	280 10	XTend Getr. / GBox: ZF 6S-400A OD Nabenprofil / Hub Profile: 23x29-10N Nur zusammen verbauen / Only install together	(48) (53)
70C17, 70C17 /P	07.07 - 08.11			3400 700 483	267 10	Getr. / GBox: ZF 6S-400 OD Nabenprofil / Hub Profile: 23,05x30,57x10N	(48)
				6594 000 054	280	Getr. / GBox: ZF 6S-400 OD	
				3400 700 646 	280	Getr. / GBox: 2840.6	
				3981 000 093		Getr. / GBox: ZF 6S-400A OD	

DAILY VI Kasten/Kombi 03.14 -

33S11, 35S11, 35C11	03.14 -	F1AFL411B, F1AFL411A, F1AE3481A		3400 700 653 	280	Getr. / GBox: 2830.5	
33S13, 35S13, 35C13	03.14 -			3400 700 653 	280	Getr. / GBox: 2835.6	
					280/Z		
33S15, 35S15, 35C15	03.14 -	F1AE3481C		3400 700 637 	268 10	Nabenprofil / Hub Profile: 23x29-10N	(48)
		F1AE3481C, F1AFL411C		3400 700 653 	280	Getr. / GBox: 2830.5	
				3400 700 653 	280	Getr. / GBox: 2835.6	
					280/Z		
35S15, 35C15, 40C15, 50C15, 65C15, 70C15	03.14 -	F1CFL411H, F1CFL411F, F1CFL411J, F1CE3481J, F1CE3481K, F1CFL411E		3400 700 646 	280	Getr. / GBox: 2840.6	
35S17, 35C17, 40C17, 50C17, 55C17, 65C17, 70C17	03.14 -				280/Z		

DAILY VI Pritsche/Fahrgestell 03.14 -









33S11, 35S11, 35C11	03.14 -	F1AFL411B, F1AFL411A, F1AE3481B, F1AE3481A		3400 700 653 	280	Getr. / GBox: 2830.5	
33S13, 35S13, 35C13	03.14 -			3400 700 653 	280	Getr. / GBox: 2835.6	
					280/Z		
33S15, 35S15, 35C15	03.14 -	F1AE3481C		3400 700 637 	268 10	Nabenprofil / Hub Profile: 23x29-10N	(48)
		F1AE3481C, F1AFL411C		3400 700 653 	280	Getr. / GBox: 2830.5	
				3400 700 653 	280	Getr. / GBox: 2835.6	
					280/Z		
35S15, 35C15, 40C15, 50C15, 65C15, 70C15	03.14 -	F1CFL411H, F1CFL411F, F1CFL411J, F1CE3481J, F1CE3481K, F1CFL411E		3400 700 646 	280	Getr. / GBox: 2840.6	
35S17, 35C17, 40C17, 45C17, 50C17, 55C17, 65C17, 70C17	03.14 -				280/Z		













Daily 50...

50 NC	01.75 -	-Deutz		1878 600 841	280 10		
55 NC	01.75 -				280CTB		
50-8		8040		1878 600 834	250 10	09.1983->	
					250CB		

		CODE				
--	--	------	--	---	---	---

IVECO

Daily 50...						
50-9		8340		1878 600 841	280 10 280CTB	
50-10	-02.82					
50 F /50 F 10	01.78-			1850 282 652 ▲	KZA-2	
55 F 9/55 F 10	-12.78					
55-9						
55-10						
50-9 Zeta	01.87-	8040		3482 911 001	270 MF270	
				1862 811 001	270 10 270CTB	
50-10				1878 600 841	280 10 280CTB	01.1978 - 12.1983
		8340		1878 600 841	280 10 280CTB	09.1983->
55-8	-12.83			1878 600 834	250 10 250CB	->02.1982
55-12 Turbo				3400 117 701 3482 998 701 1878 997 101 3151 600 529	265 10 MFZ265 265VTP KZISZ-2	Diesel / Diesel (13)





EuroCargo I-III 01.91 - 09.15						
EuroCargo Euro 6		Tetcor4		3400 700 607 3482 000 419 1878 079 306 3151 000 515	362 10 MF362 362WGTZ KZIS-4	für / for: 160/186 PS Getr. / GBox: 6 AS 700 TO Getr. / GBox: 6 S 700 TO Euro 6 / Euro 6 (69)
				3400 700 436 3482 000 419 1878 004 100 3151 000 515	362 10 MF362 362WGTZ KZIS-4	für / for: 206 PS Getr. / GBox: 6 AS 800 TO Getr. / GBox: 6 S 800 TO Euro 6 / Euro 6 (18)
				3400 700 606 3482 000 474 1878 007 250 3151 000 515	395 10 MF395 395WGTZ KZIS-4	für / for: 220/250 PS Getr. / GBox: 6 AS 800 TO Getr. / GBox: 6 S 800 TO Euro 6 / Euro 6 (69)
				3400 700 606 3482 000 474 1878 007 250 3151 000 515	395 10 MF395 395WGTZ KZIS-4	für / for: 280 PS Getr. / GBox: 6 AS 1000 TO Getr. / GBox: 6 S 1000TO Euro 6 / Euro 6 (18)
				3400 700 608 3482 001 174 1878 007 250 3151 000 493	395 10 MFZ395 395WGTZ KZISZ-5	für / for: 320 PS Getr. / GBox: 12 AS 1210 TO Euro 6 / Euro 6 (69)
				3189 600 004		Getr. / GBox: ZF AS Tronic Rollenausführung / roller version (58)
			60 E 10	01.91 - 09.15	8040	
60 E 12	01.91 - 09.15	8040		3400 066 031 # 3482 092 031 1878 074 841 3151 600 544	280 10 MFZ280 280GTZ KZISZ-3	->Chass. 21801116 D0DAC1A1 / D0DAC1AD / D0DAC1B1 / D0DAC2A1 / D0DAC2AD / D0DAC2B1 / D0DAC2BD / D0DAC3A1 / D0DAC3AD / D0DAC3B1 / D0DAC3BD / D0DAC4A1 / D0DAC4B1 / D0DAC4BD / D0DAC6AD
60 E 14 K	01.91 - 09.15	8040		3400 066 031 # 3482 092 031 1878 074 841 3151 600 544	280 10 MFZ280 280GTZ KZISZ-3	->Chass. 21801116 D0EAD1A1 / D0EAD2A1
60 E 14, 60 E 14 P	01.91 - 09.15	8040		3400 066 031 # 3482 092 031 1878 074 841 3151 600 544	280 10 MFZ280 280GTZ KZISZ-3	->Chass. 21801116 D0EAC1A1 / D0EAC1AD / D0EAC1B1 / D0EAC2A1 / D0EAC2AD / D0EAC2B1 / D0EAC3A1 / D0EAC3AD / D0EAC3B1 / D0EAC3DD / D0EAC4A1 / D0EAC4B1 / D0EAC4BD / D0EAC6A1 / D0EAC6B1 / D0EBC3A1 / D0EBC3B1 / D0EBC4B1 / D0EBC6B1
65 E 10	01.91 - 09.15	8040		3400 066 031 # 3482 092 031 1878 074 841 3151 600 544	280 10 MFZ280 280GTZ KZISZ-3	->Chass. 21801116 D1BAC1A1 / D1BAC1B1 / D1BAC2A1 / D1BAC2B1 / D1BAC3A1 / D1BAC3B1 / D1BAC4A1 / D1BAC4B1
65 E 10 K	01.91 - 09.15	8040		3400 066 031 # 3482 092 031 1878 074 841 3151 600 544	280 10 MFZ280 280GTZ KZISZ-3	->Chass. 21801116 D1BAD1A1 / D1BAD2A1



IVECO



EuroCargo I-III		01.91 - 09.15					
65 E 12 K	01.91 - 09.15	8040	3400 066 031 # ⊗ 3482 092 031 ⊗ 1878 074 841 ⊙ 3151 600 544	280 10 MFZ280 280GTZ KZISZ-3	->Chass. 21801116 D1DAD1A1 / D1DAD1AD / D1DAD2A1 / D1DAD2AD		
65 E 12, 65 E 12 P	01.91 - 09.15	8040	3400 066 031 # ⊗ 3482 092 031 ⊗ 1878 074 841 ⊙ 3151 600 544	280 10 MFZ280 280GTZ KZISZ-3	->Chass. 21801116 D1DA11B1 / D1DA12B1 / D1DA12E1 / D1DA13B1 / D1DA14B1 / D1DA14E1 / D1DA16B1 / D1DAC1A1 / D1DAC1AD / D1DAC1B1 / D1DAC2A1 / D1DAC2AD / D1DAC2B1 / D1DAC2BD / D1DAC3A1 / D1DAC3AD / D1DAC3B1 / D1DAC3D1 / D1DAC4A1 / D1DAC4B1 / D1DAC4D1 / D1DAC6A1 / D1DAC6B1 / D1DAC6D1 / D1DBC3A1 / D1DD03A5 / D1DDC1A5 / D1DDC1B5 / D1DDC3A5 / D1DDC3AE / D1DDC3B5 / D1DDC4A5 / D1DDC4B5 / D1DDC4D5 / D1DHC1A1 / D1DHC2A1 / D1DHC3A1 / D1DHC3B1 / D1DHC4A1		
65 E 13 tector	09.00 - 09.15	Tector4F4AE04 81D	3400 700 431 ■	330 10	06.2003-> Getriebeummer / Transmission Number: 2855.6 Getr. / GBox: Iveco 6-Gear Nabenprofil / Hub Profile: 1 1/2"-10N	(28)	
			3400 700 431 ■	330 10	11.2000-> Getriebeummer / Transmission Number: 2855.5 Getr. / GBox: Iveco 5-Gear Nabenprofil / Hub Profile: 1 1/2"-10N	(28)	(48)
65 E 14 K	01.91 - 09.15	8040	3400 066 031 # ⊗ 3482 092 031 ⊗ 1878 074 841 ⊙ 3151 600 544	280 10 MFZ280 280GTZ KZISZ-3	->Chass. 21801116 D1EAD1A1 / D1EAD2A1 / D1EAD2AD / D1EHD1A1 / D1EHD2A1		
65 E 14, 65 E 14 P	01.91 - 09.15	8040	3400 066 031 # ⊗ 3482 092 031 ⊗ 1878 074 841 ⊙ 3151 600 544	280 10 MFZ280 280GTZ KZISZ-3	D1EHC5A1 / D1EHC5D1 / D1ELC1A1 / D1ELC4A1 / D1ELC5B1 / D1ELC5E1		
			3400 066 031 # ⊗ 3482 092 031 ⊗ 1878 074 841 ⊙ 3151 600 544	280 10 MFZ280 280GTZ KZISZ-3	->Chass. 21801116 D1EAC2AD / D1EAC2B1 / D1EAC2BD / D1EAC2D1 / D1EAC2E1 / D1EAC3A1 / D1EAC3AD / D1EAC3B1 / D1EAC3BD / D1EAC3D1 / D1EAC3E1 / D1EAC4A1 / D1EAC4B1 / D1EAC4D1 / D1EAC4E1 / D1EAC6A1 / D1EAC6B1 / D1EAC6D1 / D1EAC6E1 / D1EB13B1 / D1EB14B1 / D1EHC1A1 / D1EHC1B1 / D1EHC2A1 / D1EHC2B1 / D1EHC4B1 / D1EHC5B1 / D1EHC7E1 / D1ELC4B1 / D1EA11B1 / D1EA12B1 / D1EA13B1 / D1EA13E1 / D1EA14B1 / D1EA14E1 / D1EA16B1 / D1EA16E1 / D1EAC1A1 / D1EAC1B1 / D1EAC2A1		
75 E 12 K	01.91 - 09.15	8040	3400 066 031 # ⊗ 3482 092 031 ⊗ 1878 074 841 ⊙ 3151 600 544	280 10 MFZ280 280GTZ KZISZ-3	->Chass. 21801116 D2DAD2AD / D2DAD3AD		
75 E 12, 75 E 12 P	01.91 - 09.15	8040	3400 066 031 # ⊗ 3482 092 031 ⊗ 1878 074 841 ⊙ 3151 600 544	280 10 MFZ280 280GTZ KZISZ-3	->Chass. 21801116 D2DAC2A1 / D2DAC2AD / D2DAC2B1 / D2DAC2BD / D2DAC3A1 / D2DAC3AD / D2DAC3B1 / D2DAC3BD / D2DAC3DD / D2DAC3ED / D2DAC4A1 / D2DAC4AD / D2DAC4B1 / D2DAC4BD / D2DAC4DD / D2DAC4ED / D2DAC5A1 / D2DAC5AD / D2DAC5B1 / D2DAC5DD / D2DAC5ED / D2DAC6A1 / D2DAC6AD / D2DAC7A1 / D2DBC3A1 / D2DBC3AD / D2DBC3BD / D2DBC4A1 / D2DBC4BD / D2DBC5A1 / D2DHC2A1 / D2DHC2B1 / D2DHC4A1 / D2DHC4B1 / D2DHC5A1 / D2DHC6BD / D2DHC6E1 / D2DHC7A1		
75 E 13 tector, 75 E 13 P tector	09.00 - 09.15	F4AE0481	3400 700 431 ■	330 10	D2MAC1A1 / D2MAC1D1 / D2MAC2A1 / D2MAC2D1 / D2MAC3A1 / D2MAC3D1 / D2MAC4A1 / D2MAC4D1 / D2MAC5A1 / D2MAC5D1 / D2MAC5D2 / D2MAC6A1 / D2MAC6D1 / D2MAC7A1 / D2MAC7A2 / D2MAC7D1 / D2MAC7D2 / D2MBC2D1 / D2MBC3A1 / D2MBC3D1 / D2MBC4A1 / D2MBC4D1 / D2MBC5A1 / D2MBC5D1 / D2MBC6A1 / D2MBC6D1 Nabenprofil / Hub Profile: 1 1/2"-10N	(48)	
75 E 14 K	01.91 - 09.15	8040	3400 066 031 # ⊗ 3482 092 031 ⊗ 1878 074 841 ⊙ 3151 600 544	280 10 MFZ280 280GTZ KZISZ-3	->Chass. 21801116 D2EAD2AD / D2EAD3AD		

IVECO



EuroCargo I-III		01.91 - 09.15				
75 E 14 K tector	09.06 - 09.15	F4AE3481C,		3400 700 436	362 10	Getr. / GBox: 6 AS 800 TO Getr. / GBox: 6 S 800 TO
75 E 14 tector, 75 E 14 P tector	09.06 - 09.15	F4AE3481A,		☉ 3482 000 419	MF362	
75 E 16 K tector	09.06 - 09.15	F4AE3481B,		☉ 1878 004 100	362WGTZ	
75 E 16 tector, 75 E 16 P tector	09.06 - 09.15	F4AE3681B,		☉ 3151 000 515	KZIS-4	
100 E 18 tector, 100 E 18 P tector, 100 E 18 FP tector	09.06 - 09.15	F4AE3481D		3400 700 487	362 10	Getr. / GBox: ZF 6AS 700 T0
100 E 22 tector, 100 E 22 P tector, 100 E 22 FP tector	09.06 - 09.15			☉ 3482 000 419	MF362	
100 E 22 W tector, 100 E 22 WS tector	09.06 - 09.15			☉ 1878 079 331	362WGTZ	
120 E 18 K tector, 120 E 18 DK tector	09.06 - 09.15			☉ 3151 000 515	KZIS-4	
120 E 22 D tector, 120 E 22 P tector, 120 E 22 FP tector	09.06 - 09.15			3400 700 475 ■	362 10	Getr. / GBox: ZF 6S 700 T0 Nabenprofil / Hub Profile: 31,02x38,55-10N
120 E 22 K tector	09.06 - 09.15					(48)
140 E 18 K tector, 140 E 18 DK tector	09.06 - 09.15			3400 700 474 ■	362 10	Getr. / GBox: ZF S5-42 Nabenprofil / Hub Profile: 31,01x38,53-10N
140 E 18 tector, 140 E 18 P tector, 140 E 18 D FP tector	09.06 - 09.15					(48)
140 E 22 K tector	09.06 - 09.15					
140 E 22 tector, 140 E 22 P tector, 140 E 22 D FP tector	09.06 - 09.15					
150 E 22 K tector	09.06 - 09.15					
150 E 22 tector, 150 E 22 P tector, 150 E 22 FP tector	09.06 - 09.15					
160 E 18 K tector	09.06 - 09.15					
160 E 18 tector, 160 E 18 P tector	09.06 - 09.15					
160 E 22 K tector	09.06 - 09.15					
160 E 22 tector, 160 E 22 P tector	09.06 - 09.15					
75 E 14, 75 E 14 P	01.91 - 09.15	8040		3400 066 031 #	280 10	->Chass. 21801116 D2EHC3B1 / D2EHC3BD / D2EHC4A1 / D2EHC4AD / D2EHC4B1 / D2EHC4BD / D2EHC4D1 / D2EHC4DD / D2EHC4E1 / D2EHC4ED / D2EHC5A1 / D2EHC5AD / D2EHC5B1 / D2EHC5BD / D2EHC5D1 / D2EHC5DD / D2EHC5E1 / D2EHC5ED / D2EHC6A1 / D2EHC6AD / D2EHC6B1 / D2EHC6BD / D2EHC6D1 / D2EHC6DD / D2EHC6E1 / D2EHC6ED / D2EHC7A1 / D2EHC7AD / D2EHC7B1 / D2EHC7BD / D2EHC7D1 / D2EHC7DD / D2EHC7E1 / D2EHC7ED / D2ELC4A1 / D2ELC4B1 / D2ELC5A1 / D2ELC5B1 / D2ELC5BD / D2ELC5E1 / D2ELC7B1 / D2ELC7E1 / D2EAC2A1 / D2EAC2AD / D2EAC2B1 / D2EAC2BD / D2EAC3A1 / D2EAC3AD / D2EAC3B1 / D2EAC3BD / D2EAC3D1 / D2EAC3DD / D2EAC3E1 / D2EAC3ED / D2EAC4A1 / D2EAC4AD / D2EAC4B1 / D2EAC4BD / D2EAC4D1 / D2EAC4DD / D2EAC4E1 / D2EAC4ED / D2EAC5A1 / D2EAC5AD / D2EAC5B1 / D2EAC5BD / D2EAC5D1 / D2EAC5DD / D2EAC5E1 / D2EAC5ED / D2EAC6A1 / D2EAC6AD / D2EAC6B1 / D2EAC6BD / D2EAC6D1 / D2EAC6DD / D2EAC6E1 / D2EAC6ED / D2EAC7A1 / D2EAC7AD / D2EAC7B1 / D2EAC7BD / D2EBC3A1 / D2EBC3AD / D2EBC3B1 / D2EBC3D1 / D2EBC3E1 / D2EBC3ED / D2EBC4A1 / D2EBC4B1 / D2EBC4BD / D2EBC4E1 / D2EBC4ED / D2EBC5A1 / D2EBC5B1 / D2EBC5E1 / D2EBC6A1 / D2EBC6AD / D2EBC6B1 / D2EBC6D1 / D2EBC6E1 / D2EHC2A1 / D2EHC2AD / D2EHC2B1 / D2EHC2BD / D2EHC3A1 / D2EHC3AD
75 E 15 K	01.91 - 09.15	8060		3400 700 449 ■	310 10	Nabenprofil / Hub Profile: 1 1/2"-10N
75 E 15, 75 E 15 P, 80 E 15	01.91 - 09.15			☉ 3482 094 031	MFZ310	(48)
				☉ 1878 000 611	310TB	
				☉ 3151 600 544	KZISZ-3	
75 E 15 K tector	09.00 - 09.15	F4AE0481		3400 700 431 ■	330 10	D2NAC1A1 / D2NAC2A1 / D2NAC2AA / D2NAC2D1 / D2NAC2DA / D2NAC3A1 / D2NAC3D1 / D2NAC4A1 / D2NAC4A2 / D2NAC4AA / D2NAC4D1 / D2NAC4D2 / D2NAC4DA / D2NAC4DB / D2NAC5A1 / D2NAC5A2 / D2NAC5AA / D2NAC5D1 / D2NAC5D2 / D2NAC5DA / D2NAC6A1 /

		CODE				
--	--	------	--	---	---	---

IVECO

EuroCargo I-III		01.91 - 09.15					
75 E 15 tector, 75 E 15 P tector	09.00 - 09.15	F4AE0481		3400 700 431 ■	330 10	D2NAC1A1 / D2NAC2AA / D2NAC2D1 / D2NAC2DA / D2NAC3A1 / D2NAC3D1 / D2NAC4A1 / D2NAC4AA / D2NAC4D1 / D2NAC4D2 / D2NAC4DA / D2NAC4DB / D2NAC5A1 / D2NAC5A2 / D2NAC5AA / D2NAC5D1 / D2NAC5D2 / D2NAC5DA / D2NAC6A1 / D2NAC6D1 / D2NAC6D2 / D2NAC7A2 / D2NAC7AB / D2NAC7D1 / D2NAC7D2 / D2NBC2A1 / D2NBC2D1 / D2NBC3A1 / D2NBC3D1 / D2NBC4A1 / D2NBC4D1 / D2NBC4D2 / D2NBC5A1 / D2NBC5A2 / D2NBC5D1 / D2NBC5D2 / D2NBC6A1 / D2NBC6D1 / D2NBC6D2 / D2NBC7A1 / D2NBC7A2 / D2NBC7D1 / D2NBC7D2 Nabenprofil / Hub Profile: 1 1/2"-10N	(48)
75 E 17 K, 75 E 18 K tector	09.00 - 09.15	F4AE0481		3400 700 431 ■	330 10	D2PBC4DA / D2PBC5A1 / D2PBC5AA / D2PBC5D1 / D2PBC5D2 / D2PBC5DA / D2PBC6A1 / D2PBC6AA / D2PBC6AB / D2PBC6D1 / D2PBC6D2 / D2PBC6DA / D2PBC7A1 / D2PBC7A2 / D2PBC7AA / D2PBC7AB / D2PBC7D1 / D2PBC7D2 / D2PBC7DB D2PAC1A1 / D2PAC1D1 / D2PAC2A1 / D2PAC2AA / D2PAC2D1 / D2PAC2DA / D2PAC3A1 / D2PAC3AA / D2PAC3D1 / D2PAC3DA / D2PAC4A1 / D2PAC4AA / D2PAC4AB / D2PAC4D1 / D2PAC4D2 / D2PAC4DA / D2PAC5A1 / D2PAC5A2 / D2PAC5AA / D2PAC5D1 / D2PAC5DB / D2PAC6A2 / D2PAC6AA / D2PAC6AB / D2PAC6D1 / D2PAC6D2 / D2PAC6DA / D2PAC7A1 / D2PAC7A2 / D2PAC7AA / D2PAC7AB / D2PAC7D1 / D2PAC7D2 / D2PAC7DA / D2PAC7DB D2PBC2A1 / D2PBC2D1 / D2PBC3A1 / D2PBC3AA / D2PBC3D1 / D2PBC4A1 / D2PBC4A2 / D2PBC4AA / D2PBC4D1 / D2PBC4D2 Nabenprofil / Hub Profile: 1 1/2"-10N	(48)
		F4AE3481B, F4AE0481A		3400 700 452 ■	350 10	D2RAC2A1 / DJRAC1A1 / D2RAC2AA / DJRAC1D1 / DJRAC2A1 / D2RAC2D1 / DJRAC2AA / D2RAC2DA / DJRAC2D1 / D2RAC3AA / D2RAC3D1 / DJRAC2DA / DJRAC3AA / D2RAC4A1 / DJRAC3D1 / D2RAC4AA / DJRAC3DA / D2RAC4D1 / DJRAC4A1 / D2RAC4D2 / D2RAC4DA / DJRAC4AA / D2RAC5A1 / DJRAC4D1 / DJRAC5A1 / D2RAC5A2 / D2RAC5AA / DJRAC5AA / DJRAC5D1 / D2RAC5AB / D2RAC5D1 / DJRAC5DA / DJRAC6A1 / D2RAC5D2 / D2RAC5DA / DJRAC6AA / D2RAC6A1 / DJRAC6AB / DJRAC6D1 / D2RAC6A2 / DJRAC6D2 / D2RAC6AA / D2RAC6AB / DJRAC6DA / DJRAC7AA / DJRAC6D1 / D2RAC6D2 / DJRAC7AB / D2RAC6DA / DJRAC7D1 / D2RAC6DB / DJRAC7D2 / DJRAC7DA / D2RAC7A1 / D2RAC7AA / DJRAC7DB / DJRBC2A1 / D2RAC7AB / D2RAC7D1 / DJRBC2D1 / D2RAC7D2 / DJRBC3D1 / D2RAC7DA / DJRBC4A1 / D2RAC7DB / DJRBC4D1 / DJRBC4D2 / D2RBC2A1 / DJRBC5A1 / D2RBC2D1 / DJRBC5D1 / D2RBC3D1 / D2RBC4A1 / DJRBC5D2 / D2RBC4D1 / DJRBC6A1 / DJRBC6AA / D2RBC5A1 / D2RBC5A2 / DJRBC6AB / DJRBC6D1 / D2RBC5AA / D2RBC5AB / DJRBC6D2 / D2RBC5D1 / DJRBC6DA / D2RBC5D2 / DJRBC7A1 / DJRBC7A2 / D2RBC6A2 / DJRBC7AA / D2RBC6AA / D2RBC6D1 / DJRBC7AB / D2RBC6D2 / DJRBC7D1 / D2RBC6DA / DJRBC7D2 / D2RBC7AA / DJRBC7DA / DJRBC7DB / D2RBC7AB / D2RBC7D1 / D2RBC7D2 / D2RBC7DB Nabenprofil / Hub Profile: 1 1/2"-10N	(48)

IVECO

EuroCargo I-III		01.91 - 09.15				
75 E 17, 75 E 17 P, 75 E 18 tector	09.00 - 09.15	F4AE0481		3400 700 431 ■	330 10	D2PAC1A1 / D2PAC1D1 / D2PAC2A1 / D2PAC2AA / D2PAC2D1 / D2PAC2DA / D2PAC3A1 / D2PAC3AA / D2PAC3D1 / D2PAC3DA / D2PAC4A1 / D2PAC4AA / D2PAC4AB / D2PAC4D2 / D2PAC4DA / D2PAC5A1 / D2PAC5A2 / D2PAC5D1 / D2PAC5D2 / D2PAC5DA / D2PAC5DB / D2PAC6A2 / D2PAC6AA / D2PAC6AB / D2PAC6D1 / D2PAC6D2 / D2PAC6DA / D2PAC7A1 / D2PAC7A2 / D2PAC7AA / D2PAC7AB / D2PAC7D1 / D2PAC7D2 / D2PAC7DA / D2PAC7DB / D2PBC2A1 / D2PBC2D1 / D2PBC3A1 / D2PBC3AA / D2PBC3D1 / D2PBC4A1 / D2PBC4A2 / D2PBC4AA / D2PBC4D1 / D2PBC4D2 / D2PBC4DA / D2PBC5A1 / D2PBC5AA / D2PBC5D1 / D2PBC5D2 / D2PBC5DA / D2PBC6A1 / D2PBC6AA / D2PBC6AB / D2PBC6D1 / D2PBC6D2 / D2PBC6DA / D2PBC7A1 / D2PBC7A2 / D2PBC7AA / D2PBC7AB / D2PBC7D1 / D2PBC7D2 / D2PBC7DB Nabenprofil / Hub Profile: 1 1/2"-10N (48)
		F4AE3481B, F4AE0481A		3400 700 452 ■	350 10	D2RAC2A1 / DJRAC1A1 / D2RAC2AA / DJRAC1D1 / DJRAC2A1 / D2RAC2D1 / D2RAC2DA / DJRAC2AA / D2RAC3AA / DJRAC2D1 / DJRAC2DA / D2RAC3D1 / D2RAC4A1 / DJRAC3AA / DJRAC3D1 / D2RAC4AA / D2RAC4D1 / DJRAC3DA / DJRAC4A1 / D2RAC4D2 / D2RAC4DA / DJRAC4AA / DJRAC4D1 / D2RAC5A1 / DJRAC5A1 / D2RAC5A2 / DJRAC5AA / D2RAC5AA / D2RAC5AB / DJRAC5D1 / DJRAC5DA / D2RAC5D1 / DJRAC6A1 / D2RAC5D2 / DJRAC6AA / D2RAC5DA / DJRAC6AB / D2RAC6A1 / DJRAC6D1 / D2RAC6A2 / D2RAC6AA / DJRAC6D2 / D2RAC6AB / DJRAC6DA / DJRAC7AA / D2RAC6D1 / D2RAC6D2 / DJRAC7AB / DJRAC7D1 / D2RAC6DA / DJRAC7D2 / D2RAC6DB / D2RAC7A1 / DJRAC7DA / DJRAC7DB / D2RAC7AA / DJRBC2A1 / D2RAC7AB / DJRBC2D1 / D2RAC7D1 / DJRBC3D1 / D2RAC7D2 / DJRBC4A1 / D2RAC7DA / DJRBC4D1 / D2RAC7DB / D2RBC2A1 / DJRBC4D2 / D2RBC2D1 / DJRBC5A1 / DJRBC5D1 / D2RBC3D1 / DJRBC5D2 / D2RBC4A1 / DJRBC6A1 / D2RBC4D1 / D2RBC5A1 / DJRBC6AA / DJRBC6AB / D2RBC5A2 / D2RBC5AA / DJRBC6D1 / DJRBC6D2 / D2RBC5AB / D2RBC5D1 / DJRBC6DA / DJRBC7A1 / D2RBC5D2 / DJRBC7A2 / D2RBC6A2 / DJRBC7AA / D2RBC6AA / D2RBC6D1 / DJRBC7AB / DJRBC7D1 / D2RBC6D2 / D2RBC6DA / DJRBC7D2 / D2RBC7AA / DJRBC7DA / DJRBC7DB / D2RBC7AB / D2RBC7D1 / D2RBC7D2 / D2RBC7DB Nabenprofil / Hub Profile: 1 1/2"-10N (48)
75 E 18 K tector 75 E 18 tector, 75 E 18 P tector	09.00 - 09.15 09.00 - 09.15	F4AE0681D, F4AE0681E		3400 700 452 ■	350 10	DJRAC1A1 / D2RAC2A1 / DJRAC1D1 / D2RAC2AA / DJRAC2A1 / D2RAC2D1 / D2RAC2DA / DJRAC2AA / DJRAC2D1 / D2RAC3AA / D2RAC3D1 / DJRAC2DA / DJRAC3AA / D2RAC4A1 / D2RAC4AA / DJRAC3D1 / DJRAC3DA / D2RAC4D1 / DJRAC4A1 / D2RAC4D2 / D2RAC4DA / DJRAC4AA / D2RAC5A1 / DJRAC4D1 / D2RAC5A2 / DJRAC5AA / D2RAC5AA / DJRAC5D1 / D2RAC5AB / D2RAC5D1 / DJRAC5DA / DJRAC6A1 / D2RAC5D2 / DJRAC6AA / D2RAC5DA / DJRAC6AB / D2RAC6A1 / D2RAC6A2 / DJRAC6D1 / DJRAC6D2 / D2RAC6AA / D2RAC6AB / DJRAC6DA / DJRAC7AA / D2RAC6D1 / DJRAC7AB / D2RAC6D2 / D2RAC6DA / DJRAC7D1 / DJRAC7D2 / D2RAC6DB / D2RAC7A1 / DJRAC7DA / D2RAC7AA / DJRAC7DB / DJRBC2A1 / D2RAC7AB / DJRBC2D1 / D2RAC7D1 / DJRBC3D1 / D2RAC7D2 / D2RAC7DA / DJRBC4A1 / DJRBC4D1 / D2RAC7DB / D2RBC2A1 / DJRBC4D2 / DJRBC5A1 / D2RBC2D1 / DJRBC5D1 / D2RBC3D1 / D2RBC4A1 / DJRBC5D2 / DJRBC6A1 / D2RBC4D1 / DJRBC6AA / D2RBC5A1 / D2RBC5A2 / DJRBC6AB / D2RBC5AA / DJRBC6D1 / D2RBC5AB / DJRBC6D2 / DJRBC6DA / D2RBC5D1 / D2RBC5D2 / DJRBC7A1 / DJRBC7A2 / D2RBC6A2 / D2RBC6AA / DJRBC7AA / D2RBC6D1 / DJRBC7AB / DJRBC7D1 / D2RBC6D2 / D2RBC6DA / DJRBC7D2 / DJRBC7DA / D2RBC7AA / DJRBC7DB















IVECO

EuroCargo I-III		01.91 - 09.15					
80 E 15 K	01.91 - 09.15	8060		3400 700 449 ■ Ⓢ 3482 094 031 Ⓢ 1878 000 611 Ⓢ 3151 600 544	310 10 MFZ310 310TB KZISZ-3	Getriebenummer / Transmission Number: 2845.6 D3HAD1B1 / D3HAD2B1 / D3HAD2BD / D3HAD3B1 / D3HAD3BD Nabenummer / Hub Profile: 1 1/2"-10N	(28)
				3400 700 449 ■ Ⓢ 3482 094 031 Ⓢ 1878 000 611 Ⓢ 3151 600 544	310 10 MFZ310 310TB KZISZ-3	Getriebenummer / Transmission Number: 2845.5 D3HAD1A1 / D3HAD2A1 / D3HAD2AD / D3HAD3A1 / D3HAD3AD Nabenummer / Hub Profile: 1 1/2"-10N	(48)
				3400 700 449 ■ Ⓢ 3482 094 031 Ⓢ 1878 000 611 Ⓢ 3151 600 544	310 10 MFZ310 310TB KZISZ-3	Getriebenummer / Transmission Number: 2845.6 D3HA12B1 / D3HA13B1 / D3HA13BD / D3HA13E1 / D3HA13ED / D3HA14B1 / D3HA14BD / D3HA14E1 / D3HA14ED / D3HA15B1 / D3HA15E1 / D3HA15ED / D3HA16B1 / D3HA16E1 / D3HA31B1 / D3HA32B1 / D3HA32BD / D3HA33B1 / D3HA33BD / D3HAC2B1 / D3HAC3B1 / D3HAC3BD / D3HAC3E1 / D3HAC4B1 / D3HAC4BD / D3HAC4E1 / D3HAC5B1 / D3HAC5BD / D3HAC5E1 / D3HAC5ED / D3HAC6B1 / D3HAC6BD / D3HAC6E1 / D3HAC6ED / D3HAC7B1 / D3HAC7BD / D3HB13B1 / D3HB13E1 / D3HB14B1 / D3HB14BD / D3HB14E1 / D3HB15B1 / D3HB15E1 / D3HB16B1 / D3HB16E1 D3HBC3B1 / D3HBC3BD / D3HBC3E1 / D3HBC3ED / D3HBC4B1 / D3HBC4E1 / D3HBC5B1 / D3HBC5BD / D3HBC5E1 / D3HBC6B1 / D3HBC6E1 / D3HDC3B5 / D3HDC3BE / D3HDC4EE / D3HHC1B1 / D3HHC2B1 / D3HHC3B1 / D3HHC4B1 / D3HHC4E1 / D3HHC5B1 / D3HHC5BD / D3HHC5E1 / D3HHC6B1 / D3HHC6E1 / D3HHC7B1 / D3HHC7BD / D3HHC7E1 / D3HLC4B1 / D3HLC4E1 / D3HLC5B1 / D3HLC6B1 Nabenummer / Hub Profile: 1 1/2"-10N	(48)
3400 700 449 ■ Ⓢ 3482 094 031 Ⓢ 1878 000 611 Ⓢ 3151 600 544	310 10 MFZ310 310TB KZISZ-3	Getriebenummer / Transmission Number: 2845.5 D3HAC2A1 / D3HAC2AD / D3HAC3A1 / D3HAC3AD / D3HAC3D1 / D3HAC4A1 / D3HAC4AD / D3HAC4D1 / D3HAC5A1 / D3HAC5AD / D3HAC5D1 / D3HAC6A1 / D3HAC6AD / D3HAC6D1 / D3HAC6DD / D3HAC7A1 / D3HBC3A1 / D3HBC3AD / D3HBC4A1 / D3HBC4DD / D3HBC5A1 / D3HBC6A1 / D3HDC2AE / D3HDC3A5 / D3HDC4A5 / D3HDC5A5 / D3HHC1A1 / D3HHC2A1 / D3HHC2AD / D3HHC3A1 / D3HHC4A1 / D3HHC4AD / D3HHC5A1 / D3HHC6A1 / D3HHC7A1 / D3HHC7AD / D3HLC4A1 Nabenummer / Hub Profile: 1 1/2"-10N	(48)				
80 E 15, 80 E 15 P	01.91 - 09.15	8060		3400 700 449 ■ Ⓢ 3482 094 031 Ⓢ 1878 000 611 Ⓢ 3151 600 544	310 10 MFZ310 310TB KZISZ-3	Getriebenummer / Transmission Number: 2845.6 D3HA12B1 / D3HA13B1 / D3HA13BD / D3HA13E1 / D3HA13ED / D3HA14B1 / D3HA14BD / D3HA14E1 / D3HA14ED / D3HA15B1 / D3HA15E1 / D3HA15ED / D3HA16B1 / D3HA16E1 / D3HA31B1 / D3HA32B1 / D3HA32BD / D3HA33B1 / D3HA33BD / D3HAC2B1 / D3HAC3B1 / D3HAC3BD / D3HAC3E1 / D3HAC4B1 / D3HAC4BD / D3HAC4E1 / D3HAC5B1 / D3HAC5BD / D3HAC5E1 / D3HAC5ED / D3HAC6B1 / D3HAC6BD / D3HAC6E1 / D3HAC6ED / D3HAC7B1 / D3HAC7BD / D3HB13B1 / D3HB13E1 / D3HB14B1 / D3HB14BD / D3HB14E1 / D3HB15B1 / D3HB15E1 / D3HB16B1 / D3HB16E1 D3HBC3B1 / D3HBC3BD / D3HBC3E1 / D3HBC3ED / D3HBC4B1 / D3HBC4E1 / D3HBC5B1 / D3HBC5BD / D3HBC5E1 / D3HBC6B1 / D3HBC6E1 / D3HDC3B5 / D3HDC3BE / D3HDC4EE / D3HHC1B1 / D3HHC2B1 / D3HHC3B1 / D3HHC4B1 / D3HHC4E1 / D3HHC5B1 / D3HHC5BD / D3HHC5E1 / D3HHC6B1 / D3HHC6E1 / D3HHC7B1 / D3HHC7BD / D3HHC7E1 / D3HLC4B1 / D3HLC4E1 / D3HLC5B1 / D3HLC6B1 Nabenummer / Hub Profile: 1 1/2"-10N	(28)
80 E 17 K, 80 E 17 DK tector, 80 E 18 K tector	09.00 - 09.15	Tector4F4AE04 81A		3400 700 430 ■ Ⓢ 3482 094 031 Ⓢ 1878 000 611 Ⓢ 3151 600 544	350 10	06.2003-> Getriebenummer / Transmission Number: 2870.9 Getr. / GBox: Iveco 9-Gear Nabenummer / Hub Profile: 1 1/2"-10N	(28)
80 E 17, 80 E 17 D tector, 80 E 17 DP tector, 80 E 18 tector	09.00 - 09.15			3400 700 431 ■ Ⓢ 3482 094 031 Ⓢ 1878 000 611 Ⓢ 3151 600 544	330 10	06.2003-> Getriebenummer / Transmission Number: 2855.5 Getr. / GBox: Iveco 5-Gear Nabenummer / Hub Profile: 1 1/2"-10N	(48)
				3400 700 431 ■ Ⓢ 3482 094 031 Ⓢ 1878 000 611 Ⓢ 3151 600 544	330 10	11.2000-> Getriebenummer / Transmission Number: 2855.6 Getr. / GBox: Iveco 6-Gear Nabenummer / Hub Profile: 1 1/2"-10N	(48)
80 E 18 K	01.91 - 09.15	8060		3400 700 449 ■ Ⓢ 3482 094 031 Ⓢ 1878 000 611 Ⓢ 3151 600 544	310 10 MFZ310 310TB KZISZ-3	Getriebenummer / Transmission Number: 2855.6 D3KA33A1 / D3KA33AD / D3KAD1A1 / D3KAD2A1 / D3KAD2AD / D3KAD3A1 / D3KAD3AD / D3KHD1A1 / D3KHD2A1 / D3KHD4A1 / D3KA31A1 / D3KA32A1 / D3KA32AD Nabenummer / Hub Profile: 1 1/2"-10N	(28)
80 E 18 K tector, 80 E 18 DK tector	09.00 - 09.15	Tector6F4AE06 81E		3400 700 430 ■ Ⓢ 3482 094 031 Ⓢ 1878 000 611 Ⓢ 3151 600 544	350 10	11.2000-> Getriebenummer / Transmission Number: 2870.9 Getr. / GBox: Iveco 9-Gear Nabenummer / Hub Profile: 1 1/2"-10N	(28)
80 E 18 tector, 80 E 18 D tector, 80 E 18 DP tector	09.00 - 09.15						(48)
90 E 18 K tector, 90 E 18 DK tector	09.00 - 09.15						(48)
90 E 18 tector, 90 E 18 D tector, 90 E 18 DP tector	09.00 - 09.15						(48)
80 E 18, 80 E 18 P, 18 E 80 FP	01.91 - 09.15	8060		3400 700 449 ■ Ⓢ 3482 094 031 Ⓢ 1878 000 611 Ⓢ 3151 600 544	310 10 MFZ310 310TB KZISZ-3	Getriebenummer / Transmission Number: 2855.6 D3KHC1A1 / D3KHC2A1 / D3KHC2AD / D3KHC3A1 / D3KHC3AD / D3KHC4A1 / D3KHC4AD / D3KHC4D1 / D3KHC4DD / D3KHC5A1 / D3KHC5AD / D3KHC5D1 / D3KHC5DD / D3KHC6A1 / D3KHC6AD / D3KHC6D1 / D3KHC6DD / D3KHC7A1 / D3KHC7AD / D3KHC7D1 / D3KHC7DD / D3KLC4A1 / D3KLC5A1	(28)

































		CODE				
--	--	------	--	---	---	---

IVECO

EuroCargo I-III		01.91 - 09.15						
80 E 18, 80 E 18 P, 18 E 80 FP	01.91-09.15	8060	 3400 700 449 ■ ⚙️ 3482 094 031 ⚙️ 1878 000 611 ⚙️ 3151 600 544	310 10 MFZ310 310TB KZISZ-3	Getriebenummer / Transmission Number: 2855.6 D3KA12A1 / D3KA12AD / D3KA13A1 / D3KA13C1 / D3KA14A1 / D3KA14C1 / D3KA15A1 / D3KA15C1 / D3KA15CD / D3KA16A1 / D3KA16C1 / D3KAC2A1 / D3KAC2AD / D3KAC3A1 / D3KAC3AD / D3KAC3C1 / D3KAC3CD / D3KAC4A1 / D3KAC4AD / D3KAC4C1 / D3KAC4CD / D3KAC5A1 / D3KAC5AD / D3KAC5C1 / D3KAC5CD / D3KAC6A1 / D3KAC6AD / D3KAC6C1 / D3KAC6CD / D3KAC7A1 / D3KB13A1 / D3KB13C1 / D3KB14A1 / D3KB14AD / D3KB14C1 / D3KB15A1 / D3KB15C1 / D3KB15CD / D3KB16A1 / D3KB16AD / D3KB16C1 / D3KBC3A1 / D3KBC3AD / D3KBC4A1 / D3KBC4AD D3KBC4CD / D3KBC5A1 / D3KBC5CD / D3KBC6A1 / D3KCC4A1 / D3KCC4C1 / D3KCC5A1 / D3KCC5C1 / D3KCC6A1 / D3KCC6C1 / D3KDC4A5 / D3KDC5A5 / D3KHC1A1 / D3KHC2A1 / D3KHC2AD / D3KHC3A1 / D3KHC3AD / D3KHC4A1 / D3KHC4AD / D3KHC4D1 / D3KHC4DD / D3KHC5A1 / D3KHC5AD / D3KHC5D1 / D3KHC5DD / D3KHC6A1 / D3KHC6AD / D3KHC6D1 / D3KHC6DD / D3KHC7A1 / D3KHC7AD / D3KHC7D1 / D3KHC7DD / D3KLC4A1 / D3KLC5A1 / D3KLC6A1 / D3KLC6D1 / D3KLC7A1 / D3KLC7D1 Nabenummer / Hub Profile: 1 1/2"-10N	(28)		
80 E 21 K, 80 E 21 DK tector, 80 E 22 K tector	09.00-09.15	Tector6F4AE06 81D	 3400 700 430 ■ ⚙️ 3482 094 031 ⚙️ 1878 000 611 ⚙️ 3151 600 544	350 10 06.2003->	Getriebenummer / Transmission Number: 2870.9	(28)		
80 E 21, 80 E 21 D tector, 80 E 21 DP tector, 80 E 22 tector	09.00-09.15				3400 700 430 ■ ⚙️ 3482 094 031 ⚙️ 1878 000 611 ⚙️ 3151 600 544	350 10 06.2003->	Getr. / GBox: Iveco 9-Gear	(28)
90 E 21 K tector, 90 E 21 DK tector	09.00-09.15						Getriebenummer / Transmission Number: 2865.6	(28)
90 E 21, 90 E 21 D tector, 90 E 21 DP tector, 90 E 22 tector	09.00-09.15				Getr. / GBox: Iveco 6-Gear	(48)		
80 E 21, 80 E 21 P, 21 E 80 FP	01.91-09.15	8060	 3400 068 031 ⚙️ 3482 093 031 ⚙️ 1862 310 132 ⚙️ 3151 600 544	330 10 MFZ330 330GSB KZISZ-3	Getriebenummer / Transmission Number: 2865.6 D3LA12A1 / D3LA13A1 / D3LA13C1 / D3LA14A1 / D3LA14C1 / D3LA15A1 / D3LA15C1 / D3LA16A1 / D3LA16C1 / D3LAC2A1 / D3LAC3A1 / D3LAC3C1 / D3LAC4A1 / D3LAC4C1 / D3LAC5A1 / D3LAC5C1 / D3LAC6A1 / D3LAC6C1 / D3LB13A1 / D3LB13C1 / D3LB14A1 / D3LB14C1 / D3LB15A1 / D3LB15C1 / D3LB16A1 / D3LB16C1 / D3LBC3A1 / D3LBC4A1 / D3LBC5A1 / D3LCC4C1 / D3LHC4A1 / D3LHC4D1 / D3LHC5A1 / D3LHC7D1 / D3LLC5A1 / D3LLC5D1 / D3LLC6D1 / D3LLC7A1 / D3LLC7D1 / D3LMC7D1	(28)		
80 E 21, 80 E 21 P, 80 E 21 FP	01.91-09.15							
80 EL 15 tector	09.00-09.15	Tector4F4AE04 81C	 3400 700 431 ■ ⚙️ 3482 094 031 ⚙️ 1878 000 611 ⚙️ 3151 600 544	330 10 06.2003->	Getriebenummer / Transmission Number: 2855.5/6	(28)		
90 E 17 K tector, 90 E 17 DK tector	09.00-09.15	Tector4F4AE04 81A	 3400 700 430 ■ ⚙️ 3482 094 031 ⚙️ 1878 000 611 ⚙️ 3151 600 544	350 10 06.2003->	Getr. / GBox: Iveco 9-Gear	(28)		
90 E 17, 90 E 17D tector, 90 E 17 DP tector, 90 E 18 tector	09.00-09.15				3400 700 431 ■ ⚙️ 3482 094 031 ⚙️ 1878 000 611 ⚙️ 3151 600 544	330 10 11.2000->	Getriebenummer / Transmission Number: 2870.9	(48)
							Getr. / GBox: Iveco 6-Gear	(28)
					Nabenummer / Hub Profile: 1 1/2"-10N	(48)		
95 E 15 W	01.91-09.15	8060	 3400 700 449 ■ ⚙️ 3482 094 031 ⚙️ 1878 000 611 ⚙️ 3151 600 544	310 10 MFZ310 310TB KZISZ-3	Getriebenummer / Transmission Number: 2845.6 D4HE11B1 / D4HE12B1 / D4HE12BD / D4HPC1B1 / D4HPC1BD / D4HPC2B1 Nabenummer / Hub Profile: 1 1/2"-10N	(28)		
			 3400 700 449 ■ ⚙️ 3482 094 031 ⚙️ 1878 000 611 ⚙️ 3151 600 544	310 10 MFZ310 310TB KZISZ-3	Getriebenummer / Transmission Number: 2845.5 D4HE11A1 / D4HE12A1 / D4HE12AD / D4HPC1A1 / D4HPC2A1 Nabenummer / Hub Profile: 1 1/2"-10N	(28)		
95 E 21 W	01.91-09.15	8060	 3400 068 031 ⚙️ 3482 093 031 ⚙️ 1862 310 132 ⚙️ 3151 600 544	330 10 MFZ330 330GSB KZISZ-3	->Chass. 2253628			
			 3400 068 031 ⚙️ 3482 093 031 ⚙️ 1862 310 132 ⚙️ 3151 600 544	330 10 MFZ330 330GSB KZISZ-3	Getr. / GBox: 2865.6			
			 3400 068 031 ⚙️ 3482 093 031 ⚙️ 1862 310 132 ⚙️ 3151 600 544	330 10 MFZ330 330GSB KZISZ-3	D4LE11A1 / D4LE11AD / D4LE12A1 / D4LE12AD / D4LPC1A1 / D4LPC1AD / D4LPC2A1 / D4LPC2AD			
			 3400 068 031 ⚙️ 3482 093 031 ⚙️ 1862 310 132 ⚙️ 3151 600 544	330 10 MFZ330 330GSB KZISZ-3	Getr. / GBox: S6-36/2-5			
			 3400 068 031 ⚙️ 3482 093 031 ⚙️ 1862 310 132 ⚙️ 3151 600 544	330 10 MFZ330 330GSB KZISZ-3	D4LPC1C1			
			 3400 068 031 ⚙️ 3482 093 031 ⚙️ 1862 310 132 ⚙️ 3151 600 544	330 10 MFZ330 330GSB KZISZ-3	Getr. / GBox: S6-36			
			3400 068 031 ⚙️ 3482 093 031 ⚙️ 1862 310 132 ⚙️ 3151 600 544	330 10 MFZ330 330GSB KZISZ-3	D4LPC2C1			

		CODE				
--	--	------	--	---	---	---

IVECO

EuroCargo I-III		01.91 - 09.15					
100 E 15 K	01.91 - 09.15	8060		3400 700 449   3482 094 031  1878 000 611  3151 600 544	310 10 MFZ310 310TB KZISZ-3	Getriebenummer / Transmission Number: 2845.6 D4HA31B1 / D4HA32B1 / D4HA32BD / D4HA33B1 / D4HAD1B1 / D4HAD2B1 / D4HAD2BD / D4HAD3B1 / D4HAD3BD Nabenummer / Hub Profile: 1 1/2"-10N	(28)
				3400 700 449   3482 094 031  1878 000 611  3151 600 544	310 10 MFZ310 310TB KZISZ-3	Getriebenummer / Transmission Number: 2845.5 D4HAD1A1 / D4HAD2A1 / D4HAD2AD / D4HAD3A1 / D4HAD3AD Nabenummer / Hub Profile: 1 1/2"-10N	(48)
100 E 15, 100 E 15 P	01.91 - 09.15	8060		3400 700 449   3482 094 031  1878 000 611  3151 600 544	310 10 MFZ310 310TB KZISZ-3	Getriebenummer / Transmission Number: 2845.6 D4HA12B1 / D4HA12BD / D4HA13B1 / D4HA13BD / D4HA14B1 / D4HA14BD / D4HA15B1 / D4HA15E1 / D4HA16B1 / D4HA16E1 / D4HAC2B1 / D4HAC2BD / D4HAC3B1 / D4HAC3BD / D4HAC4B1 / D4HAC4BD / D4HAC4E1 / D4HAC4ED / D4HAC5B1 / D4HAC5BD / D4HAC5E1 / D4HAC5ED / D4HAC6B1 / D4HAC6BD / D4HAC6E1 / D4HAC6ED / D4HHC1B1 / D4HHC2B1 / D4HHC2BD / D4HHC3B1 / D4HHC4B1 / D4HHC4BD / D4HHC5B1 / D4HHC5BD / D4HHC5E1 / D4HHC6B1 / D4HHC6BD / D4HHC6E1 / D4HHC6ED / D4HHC7B1 / D4HHC7BD / D4HHC7E1 / D4HHC7ED / D4HLC5B1 / D4HLC5BD D4HLC6B1 / D4HLC7B1 Nabenummer / Hub Profile: 1 1/2"-10N	(28)
				3400 700 449   3482 094 031  1878 000 611  3151 600 544	310 10 MFZ310 310TB KZISZ-3	Getriebenummer / Transmission Number: 2845.5 D4HAC2A1 / D4HAC2AD / D4HAC3A1 / D4HAC3AD / D4HAC4A1 / D4HAC4AD / D4HAC4D1 / D4HAC4DD / D4HAC5A1 / D4HAC5AD / D4HAC5D1 / D4HAC5DD / D4HAC6A1 / D4HAC6AD / D4HAC6D1 / D4HAC6DD / D4HBC4A1 / D4HBC5A1 / D4HBC6A1 / D4HHC1A1 / D4HHC2A1 / D4HHC2AD / D4HHC3A1 / D4HHC4A1 / D4HHC4AD / D4HHC5A1 / D4HHC5AD / D4HHC5D1 / D4HHC6A1 / D4HHC6AD / D4HHC6D1 / D4HHC7A1 / D4HLC5A1 / D4HLC6A1 Nabenummer / Hub Profile: 1 1/2"-10N	(48)
100 E 17 K tector, 100 E 17 DK tector	09.00 - 09.15	F4AE0481		3400 700 431   3482 094 031  1878 000 611  3151 600 544	330 10 MFZ310 310TB KZISZ-3	D4PA04D3 / D4PAC1D1 / D4PAC2D1 / D4PAC2DA / D4PAC2G1 / D4PAC2GA / D4PAC3D1 / D4PAC3G1 / D4PAC4D1 / D4PAC4D2 / D4PAC4DA / D4PAC4G1 / D4PAC5D1 / D4PAC5D2 / D4PAC5DA / D4PAC5G1 / D4PAC6D1 / D4PAC6D2 / D4PAC6DA / D4PAC6G1 / D4PAC7D1 / D4PAC7D2 / D4PAC7DA / D4PAC7DB / D4PAC7G1 / D4PAC7G2 / D4PAE2D3 / D4PAE4D3 / D4PAE5D3 / D4PAE6D3 / D4PAE7D3 / D4PB04D3 / D4PBC2D1 / D4PBC2G1 / D4PBC3D1 / D4PBC3G1 / D4PBC4D1 / D4PBC4G1 / D4PBC5D1 / D4PBC5D2 / D4PBC5G1 / D4PBC5G2 / D4PBC6D1 / D4PBC6D2 / D4PBC6G1 D4PBC6G2 / D4PBC7D1 / D4PBC7D2 / D4PBC7G1 / D4PBC7G2 / D4PBE4D3 / D4PBE5D3 / D4PBE7D3 Nabenummer / Hub Profile: 1 1/2"-10N	(48)
100 E 17, 100 E 17 DP tector, 100 E 18 tector	09.00 - 09.15	F4AE0481		3400 700 431   3482 094 031  1878 000 611  3151 600 544	330 10 MFZ310 310TB KZISZ-3	D4PA04D3 / D4PAC2D1 / D4PAC2DA / D4PAC2G1 / D4PAC2GA / D4PAC3D1 / D4PAC3G1 / D4PAC4D1 / D4PAC4D2 / D4PAC4DA / D4PAC4G1 / D4PAC5D1 / D4PAC5D2 / D4PAC5DA / D4PAC5G1 / D4PAC6D1 / D4PAC6D2 / D4PAC6DA / D4PAC6G1 / D4PAC6G2 / D4PAC7D1 / D4PAC7D2 / D4PAC7DA / D4PAC7DB / D4PAC7G1 / D4PAC7G2 / D4PAE2D3 / D4PAE4D3 / D4PAE5D3 / D4PAE6D3 / D4PAE7D3 / D4PB04D3 / D4PBC2D1 / D4PBC2G1 / D4PBC3D1 / D4PBC3G1 / D4PBC4D1 / D4PBC4G1 / D4PBC5D1 / D4PBC5D2 / D4PBC5G1 / D4PBC5G2 / D4PBC6D1 / D4PBC6D2 / D4PBC6G1 D4PBC6G2 / D4PBC7D1 / D4PBC7D2 / D4PBC7G1 / D4PBC7G2 / D4PBE4D3 / D4PBE5D3 / D4PBE7D3 Nabenummer / Hub Profile: 1 1/2"-10N	(48)
100 E 18 K	01.91 - 09.15	8060		3400 700 449   3482 094 031  1878 000 611  3151 600 544	310 10 MFZ310 310TB KZISZ-3	Getriebenummer / Transmission Number: 2855.6 D4KA31A1 / D4KA32A1 / D4KA33A1 / D4KAD1A1 / D4KAD2A1 / D4KAD2AD / D4KAD3A1 / D4KAD3AD / D4KHD1A1 / D4KHD2A1 Nabenummer / Hub Profile: 1 1/2"-10N	(28)







IVECO

EuroCargo I-III 01.91 - 09.15

100 E 18 K tector	09.06 - 09.15	F4AE3481B		3400 700 436 3482 000 419 1878 004 100 3151 000 515	362 10 MF362 362WGTZ KZIS-4	Getr. / GBox: 6 AS 800 TO Getr. / GBox: 6 S 800 TO	
				3400 700 452	350 10	DKRAC1D1 / DKRAC2D1 / DKRAC2DA / DKRAC3D1 / DKRAC3DA / DKRAC4D1 / DKRAC4D2 / DKRAC4DA / DKRAC5D1 / DKRAC5D2 / DKRAC5DA / DKRAC5DB / DKRAC6D1 / DKRAC6D2 / DKRAC6DA / DKRAC6DB / DKRAC7D1 / DKRAC7D2 / DKRAC7DA / DKRAC7DB / DKRAE4D4 / DKRAE4DD / DKRAE5D4 / DKRAE5DD / DKRAE6D4 / DKRAE7D4 / DKRAE7DD / DKRBC2D1 / DKRBC2DA / DKRBC3D1 / DKRBC4D1 / DKRBC4D2 / DKRBC5D1 / DKRBC5D2 / DKRBC6D1 / DKRBC6D2 / DKRBC7D1 / DKRBC7D2 / DKRBC7DA / DKRBC7DB / DKRBE4D4 / DKRBE5D4 / DKRBE6D4 / DKRBE7D4 / DKRCC5D1 / DKRCC6D1 / DKRCC7D1 / DKRCC7D2 / DKRCC7DA / DMREC1E1 Nabenprofil / Hub Profile: 1 1/2"-10N	(48)
				3400 700 487 3482 000 419 1878 079 331 3151 000 515	362 10 MF362 362WGTZ KZIS-4	Getr. / GBox: ZF 6AS 700 T0	
				3400 700 475	362 10	Getr. / GBox: ZF 6S 700 T0 Nabenprofil / Hub Profile: 31,02x38,55-10N	(48)
				3400 700 474	362 10	Getr. / GBox: ZF S5-42 Nabenprofil / Hub Profile: 31,01x38,53-10N	(48)
100 E 18 K tector, 100 E 18 DK tector 100 E 18 tector, 100 E 18 P tector, 100 E 18 FP tector	09.00 - 09.15	F4AE0681		3400 700 430	350 10	D4RAC1G1 / D4RAC2G1 / D4RAC2GA / D4RAC3G1 / D4RAC4G1 / D4RAC4G2 / D4RAC5G1 / D4RAC5G2 / D4RAC6G1 / D4RAC6G2 / D4RAC7G1 / D4RAC7G2 / D4RAE5G3 / D4RAE6G3 / D4RBC2G1 / D4RBC3G1 / D4RBC4G1 / D4RBC4G2 / D4RBC5G1 / D4RBC5G2 / D4RBC6G2 / D4RBC7G2 / D4RCC5G1 / D4RCC6G1 / D4RCC7G1 / D4RCC7G2 Nabenprofil / Hub Profile: 1 1/2"-10N	(48)
	09.00 - 09.15	F4AE0681D, F4AE0681E					
100 E 18 W tector, 100 E 18 WS tector	09.00 - 09.15	F4AE0681		3400 700 430	350 10	D4RAC1G1 / D4RAC2G1 / D4RAC2GA / D4RAC3G1 / D4RAC4G1 / D4RAC4G2 / D4RAC5G1 / D4RAC5G2 / D4RAC6G1 / D4RAC6G2 / D4RAC7G1 / D4RAC7G2 / D4RAE5G3 / D4RAE6G3 / D4RBC2G1 / D4RBC3G1 / D4RBC4G1 / D4RBC4G2 / D4RBC5G1 / D4RBC5G2 / D4RBC6G2 / D4RBC7G2 / D4RCC5G1 / D4RCC6G1 / D4RCC7G2 Nabenprofil / Hub Profile: 1 1/2"-10N	(48)
		F4AE0681E, F4AE3681C					

		CODE				
--	--	------	--	---	---	---

IVECO

















EuroCargo I-III		01.91 - 09.15					
100 E 18, 100 E 18 P	01.91-09.15	8060	 3400 700 449 ■ ⊗ 3482 094 031 ⊗ 1878 000 611 ⊙ 3151 600 544	310 10 MFZ310 310TB KZISZ-3	Getriebenummer / Transmission Number: 2855.6 D4KA12A1 / D4KA12AD / D4KA13A1 / D4KA13AD / D4KA14A1 / D4KA14C1 / D4KA15A1 / D4KA15C1 / D4KA16A1 / D4KA16C1 / D4KAC2A1 / D4KAC2AD / D4KAC3A1 / D4KAC3AD / D4KAC4A1 / D4KAC4AD / D4KAC4C1 / D4KAC4CD / D4KAC5A1 / D4KAC5AD / D4KAC5C1 / D4KAC5CD / D4KAC6A1 / D4KAC6AD / D4KAC6C1 / D4KAC6CD / D4KB14A1 / D4KB14C1 / D4KB15A1 / D4KB16A1 / D4KB16C1 / D4KBC4A1 / D4KBC5A1 / D4KBC6A1 / D4KHC1A1 / D4KHC2A1 / D4KHC2AD / D4KHC4A1 / D4KHC4AD / D4KHC5A1 / D4KHC5AD / D4KHC5D1 / D4KHC5DD / D4KHC6A1 / D4KHC6AD D4KHC6D1 / D4KHC6DD / D4KHC7A1 / D4KHC7AD / D4KHC7D1 / D4KHC7DD / D4KLC5A1 / D4KLC6A1 / D4KLC7A1 / D4KLC7D1 Nabenprofil / Hub Profile: 1 1/2"-10N	(28)	
100 E 21 K tector, 100 E 21 DK tector 100 E 21 W tector, 100 E 21 WS tector	09.00-09.15 09.00-09.15	F4AE0681	 3400 700 430 ■	350 10	D4SA04D3 / D4SA07D3 / D4SAC1D1 / D4SAC1G1 / D4SAC2D1 / D4SAC2G1 / D4SAC3D1 / D4SAC3G1 / D4SAC4D1 / D4SAC4D2 / D4SAC4DA / D4SAC4G1 / D4SAC4G2 / D4SAC5D1 / D4SAC5D2 / D4SAC5G1 / D4SAC5G2 / D4SAC6D1 / D4SAC6D2 / D4SAC6DA / D4SAC6G1 / D4SAC6G2 / D4SAC7D1 / D4SAC7D2 / D4SAC7DA / D4SAC7G1 / D4SAC7G2 / D4SAC7GB / D4SAE5D3 / D4SAE5G3 / D4SAE6D3 / D4SAE7D3 / D4SAE7G3 / D4SB04D3 / D4SBC2D1 / D4SBC2G1 / D4SBC3D1 / D4SBC3G1 / D4SBC4D1 / D4SBC4D2 / D4SBC4G1 / D4SBC4G2 / D4SBC5D1 / D4SBC5D2 / D4SBC5DA D4SBC5G1 / D4SBC5G2 / D4SBC6D1 / D4SBC6D2 / D4SBC6DA / D4SBC6DB / D4SBC6G1 / D4SBC6G2 / D4SBC7D1 / D4SBC7D2 / D4SBC7DA / D4SBC7DB / D4SBC7G1 / D4SBC7G2 / D4SBC7GB / D4SBE4G3 / D4SBE5D3 / D4SBE6D3 / D4SBE7D3 / D4SBE7G3 / D4SCC5D1 / D4SCC5G1 / D4SCC5G2 / D4SCC6D1 / D4SCC6DA / D4SCC6G2 / D4SCC7D1 / D4SCC7D2 / D4SCC7G1 / D4SCC7G2 / D4SEC1D1 / D4SEC1DA / D4SEC2D1 Nabenprofil / Hub Profile: 1 1/2"-10N	(48)	
100 E 21, 100 E 21 DP tector, 100 E 22 tector	09.00-09.15	F4AE0681	 3400 700 430 ■	350 10	D4SA04D3 / D4SAC1D1 / D4SAC1G1 / D4SAC2D1 / D4SAC2G1 / D4SAC3D1 / D4SAC3G1 / D4SAC4D1 / D4SAC4D2 / D4SAC4DA / D4SAC4G1 / D4SAC4G2 / D4SAC5D1 / D4SAC5D2 / D4SAC5G1 / D4SAC5G2 / D4SAC6D1 / D4SAC6D2 / D4SAC6DA / D4SAC6G1 / D4SAC6G2 / D4SAC7D1 / D4SAC7D2 / D4SAC7DA / D4SAC7G1 / D4SAC7G2 / D4SAC7GB / D4SAE5D3 / D4SAE5G3 / D4SAE6D3 / D4SAE7D3 / D4SAE7G3 / D4SB04D3 / D4SBC2D1 / D4SBC2G1 / D4SBC3D1 / D4SBC3G1 / D4SBC4D1 / D4SBC4D2 / D4SBC4G1 / D4SBC4G2 / D4SBC5D1 / D4SBC5D2 / D4SBC5DA / D4SBC5G1 D4SBC5G2 / D4SBC6D1 / D4SBC6D2 / D4SBC6DA / D4SBC6DB / D4SBC6G1 / D4SBC6G2 / D4SBC7D1 / D4SBC7D2 / D4SBC7DA / D4SBC7DB / D4SBC7G1 / D4SBC7G2 / D4SBC7GB / D4SBE4G3 / D4SBE5D3 / D4SBE6D3 / D4SBE7D3 / D4SBE7G3 / D4SCC5D1 / D4SCC5G1 / D4SCC5G2 / D4SCC6D1 / D4SCC6DA / D4SCC6G2 / D4SCC7D1 / D4SCC7D2 / D4SCC7G1 / D4SCC7G2 / D4SEC1D1 / D4SEC1DA / D4SEC2D1 Nabenprofil / Hub Profile: 1 1/2"-10N	(48)	
100 E 21, 100 E 21 P	01.91-09.15	8060	 3400 068 031 ⊗ 3482 093 031 ⊗ 1862 310 132 ⊙ 3151 600 544	330 10 MFZ330 330GSB KZISZ-3	Getriebenummer / Transmission Number: 2865.6 D4LA12A1 / D4LA13A1 / D4LA14A1 / D4LA14C1 / D4LA15A1 / D4LA15C1 / D4LA16A1 / D4LA16C1 / D4LAC2A1 / D4LAC3A1 / D4LAC4A1 / D4LAC4C1 / D4LAC5A1 / D4LAC5C1 / D4LAC6A1 / D4LAC6C1 / D4LB14A1 / D4LB14C1 / D4LB15A1 / D4LB15C1 / D4LB16A1 / D4LB16C1 / D4LBC4C1 / D4LBC5A1 / D4LBC5C1 / D4LHC2A1 / D4LHC3A1 / D4LHC4A1 / D4LHC5A1 / D4LHC5D1 / D4LHC6A1 / D4LHC7A1 / D4LHC7D1 / D4LLC5A1 / D4LLC6A1 / D4LLC7A1 / D4LLC7D1	(28)	



IVECO























EuroCargo I-III		01.91 - 09.15					
110 E 25 W tector 110 E 25 WS tector 140 E 24 K tector 140 E 24 tector, 14 E 24 P tector, 140 E 24 FP tector 230 E 30 tector	05.06 - 09.15 05.06 - 09.15 09.00 - 09.15 09.00 - 09.15 02.08 - 09.15	F4AE3681D, F4AE3681A, F4AE0681B		3400 700 486 ⊗ 3482 000 474 ⊗ 1878 004 584 ⊙ 3151 000 515	395 10 MF395 395WGTZ KZIS-4	Getr. / GBox: 6AS800/6AS1000	
120 E 15	01.91 - 09.15	8060		3400 700 449 ■ ⊗ 3482 094 031 ⊗ 1878 000 611 ⊙ 3151 600 544	310 10 MFZ310 310TB KZISZ-3	Getriebenummer / Transmission Number: 2845.6 E0BA11B1 / E0BA12B1 / E0BA13B1 / E0BA14B1 / E0BA15B1 / E0BA16B1 / E0BA17B1 / E0BAC1B1 / E0BAC1BD / E0BAC2B1 / E0BAC2BD / E0BAC2ED / E0BAC3B1 / E0BAC3BD / E0BAC3ED / E0BAC4B1 / E0BAC4BD / E0BAC4ED / E0BAC5B1 / E0BAC5BD / E0BAC5ED / E0BAC6B1 / E0BAC6BD / E0BAC6ED / E0BAC7B1 / E0BAC7BD / E0BAC7ED / E0BBC3BD / E0BBC3ED / E0BBC7BD / E0HHC4B1 / E0HHC5B1 / E0HHC5BD / E0HHC6B1 / E0HHC6BD / E0HHC7B1 / E0HHC7BD / E0HHC8BD / E0HHC9BD Nabenprofil / Hub Profile: 1 1/2"-10N	(28)
				3400 700 449 ■ ⊗ 3482 094 031 ⊗ 1878 000 611 ⊙ 3151 600 544	310 10 MFZ310 310TB KZISZ-3	Getriebenummer / Transmission Number: 2845.5 E0BAC1A1 / E0BAC2A1 / E0BAC3A1 / E0BAC3DD / E0BAC4A1 / E0BAC5A1 / E0BAC5AD / E0BAC6A1 / E0BAC7A1 / E0BAC7AD / E0BBC3A1 / E0BBC3AD / E0BBC3D1 / E0BBC3DD / E0BBC5A1 / E0BBC5AD / E0BBC6AD / E0BBC6D1 / E0BBC7A1 / E0BBC7AD / E0HHC5A1 / E0HHC6A1 / E0HHC7A1 / E0HHC8A1 Nabenprofil / Hub Profile: 1 1/2"-10N	(48)
120 E 15 K	01.91 - 09.15	8060		3400 700 449 ■ ⊗ 3482 094 031 ⊗ 1878 000 611 ⊙ 3151 600 544	310 10 MFZ310 310TB KZISZ-3	Getriebenummer / Transmission Number: 2845.5 E0BAD1A1 / E0BAD1AD / E0BAD2A1 / E0BAD2AD Nabenprofil / Hub Profile: 1 1/2"-10N	(28)
				3400 700 449 ■ ⊗ 3482 094 031 ⊗ 1878 000 611 ⊙ 3151 600 544	310 10 MFZ310 310TB KZISZ-3	Getriebenummer / Transmission Number: 2845.6 E0BAD1B1 / E0BAD1BD / E0BAD2B1 / E0BAD2BD Nabenprofil / Hub Profile: 1 1/2"-10N	(48)
120 E 18 K	01.91 - 09.15	8060		3400 700 449 ■ ⊗ 3482 094 031 ⊗ 1878 000 611 ⊙ 3151 600 544	310 10 MFZ310 310TB KZISZ-3	Getriebenummer / Transmission Number: 2870.9 E0CA31B1 / E0CA32B1 / E0CAD1B1 Nabenprofil / Hub Profile: 1 1/2"-10N	(28)
				3400 700 449 ■ ⊗ 3482 094 031 ⊗ 1878 000 611 ⊙ 3151 600 544	310 10 MFZ310 310TB KZISZ-3	Getriebenummer / Transmission Number: 2855.6 E0CAD1A1 / E0CAD2A1 Nabenprofil / Hub Profile: 1 1/2"-10N	(48)
120 E 18 K tector, 120 E 18 DK tector 120 E 18 tector, 120 E 18 D tector, 120 E 18 DP tector	09.00 - 09.15	Tector6F4AE06 81E		3400 700 431 ■	330 10	02.2001-> Getriebenummer / Transmission Number: 2855.6 Getr. / GBox: Iveco 6-Gear Nabenprofil / Hub Profile: 1 1/2"-10N	(28)
	09.00 - 09.15			3400 700 430 ■	350 10	02.2001-> Getriebenummer / Transmission Number: 2870.9 Getr. / GBox: Iveco 9-Gear Nabenprofil / Hub Profile: 1 1/2"-10N	(48)
120 E 18, 120 E 18 P, 120 E 18 H	01.91 - 09.15	8060		3400 700 449 ■ ⊗ 3482 094 031 ⊗ 1878 000 611 ⊙ 3151 600 544	310 10 MFZ310 310TB KZISZ-3	Getriebenummer / Transmission Number: 2870.9 E0KHC2B1 / E0KHC4B1 / E0KHC4E1 / E0KHC5B1 / E0KHC6B1 / E0KHC7B1 / E0KHC7E1 / E0KHC8B1 / E0KHC8E1 / E0KHC9B1 / E0KHC9E1 / E0KLC5B1 / E0KLC5E1 / E0CA11B1 / E0CA11BD / E0CA12B1 / E0CA12E1 / E0CA13B1 / E0CA13E1 / E0CA14B1 / E0CA14BD / E0CA14E1 / E0CA15B1 / E0CA15E1 / E0CA16B1 / E0CA16BD / E0CA16E1 / E0CA16ED / E0CA17B1 / E0CA17E1 / E0CAC1B1 / E0CAC2B1 / E0CAC2E1 / E0CAC3B1 / E0CAC3E1 / E0CAC4B1 / E0CAC4E1 / E0CAC5B1 / E0CAC5E1 / E0CAC6B1 / E0CAC6E1 / E0CAC7B1 / E0CAC7E1 / E0CB13B1 / E0CB13E1 E0CB15B1 / E0CB15E1 / E0CB16B1 / E0CB16E1 / E0CB17B1 / E0CB17E1 / E0CBC5BD / E0CBC6BD / E0KLC7B1 / E0KLC7E1 / E0KLC9E1 / E0KMC5E1 / E0KMC8B1 / E0KMC8E1 Nabenprofil / Hub Profile: 1 1/2"-10N	(48)
				3400 700 449 ■ ⊗ 3482 094 031 ⊗ 1878 000 611 ⊙ 3151 600 544	310 10 MFZ310 310TB KZISZ-3	Getriebenummer / Transmission Number: 2855.6 E0CCC3A1 / E0CCC5A1 / E0CCC6A1 / E0CCC6D1 / E0CCC7A1 / E0CCC7D1 / E0KHC2A1 / E0KHC4A1 / E0KHC4AD / E0KHC4D1 / E0KHC5A1 / E0KHC5AD / E0KHC6A1 / E0KHC6AD / E0KHC7A1 / E0KHC7AD / E0KHC7D1 / E0KHC8A1 / E0KHC8AD / E0KHC9A1 / E0KHC9D1 / Nabenprofil / Hub Profile: 1 1/2"-10N	(28)

IVECO

EuroCargo I-III		01.91 - 09.15					
120 E 23, 120 E 23 P, 120 E 23 FP, 120 E 23 H	01.91 - 09.15	8060	 3400 068 031  3482 093 031  1862 310 132  3151 600 544	330 10 MFZ330 330GSB KZISZ-3	Getriebenummer / Transmission Number: 2870.9 E0DC13E1 / E0DC15B1 / E0DC15E1 / E0DC16B1 / E0DC16E1 / E0DC17B1 / E0DC17E1 / E0DCC3B1 / E0DCC3E1 / E0DCC5B1 / E0DCC5E1 / E0DCC6B1 / / E0DCC6E1 / E0DCC7B1 / E0DCC7E1 / E0MHC4B1 / E0MHC5B1 / E0MHC5E1 / E0MHC6B1 / / E0MHC6E1 / E0MHC7B1 / E0MHC7E1 / E0MHC8E1 / E0MHC9B1 / E0MHC9E1 / E0MLC5B1 / / E0MLC5E1 / E0MLC7B1 / E0MLC7E1 / E0MLC8B1 / / E0MLC8E1 / E0MLC9B1 / E0MLC9E1 / E0MMC9E1 / E0DA11B1 / E0DA12B1 / E0DA12E1 / E0DA13B1 / E0DA13E1 / E0DA14B1 / E0DA14E1 / E0DA15B1 / E0DA15E1 / E0DA16B1 / E0DA16E1 / E0DA17B1 / E0DA17E1 / E0DA17ED / E0DAC1B1 / E0DAC2B1 / E0DAC2E1 / E0DAC3B1 / E0DAC3E1 / E0DAC4B1 / E0DAC4E1 / E0DAC5B1 / E0DAC5E1 / E0DAC6B1 / E0DAC6E1 / E0DAC7B1 / E0DAC7E1 / E0DB13B1 / E0DB13E1 / E0DB15B1 / E0DB15E1 / E0DB16B1 / E0DB16E1 / E0DB17B1 / E0DB17BD / E0DB17E1 / E0DBC3B1 / E0DBC3E1 / E0DBC5B1 / E0DBC5E1 / E0DBC6B1 / E0DBC6E1 / E0DBC7B1 / E0DBC7E1 / E0DC13B1	(28)	
				3400 068 031  3482 093 031  1862 310 132  3151 600 544	330 10 MFZ330 330GSB KZISZ-3	Getriebenummer / Transmission Number: 2865.6 E0MHC2A1 / E0MHC4A1 / E0MHC8D1 / E0MHC9A1 / / E0MHC9D1 / E0MLC7A1 / E0DAC1A1 / E0DAC2A1 / E0DAC3A1 / E0DAC3D1 / E0DAC4A1 / E0DAC4D1 / E0DAC5A1 / E0DAC5D1 / E0DAC6A1 / / E0DAC6D1 / E0DAC7A1 / E0DAC7D1 / E0DBC3A1 / E0DBC3D1 / E0DBC5A1 / E0DBC5D1 / / E0DBC7A1 / E0DBC7D1	(28)
120 E 24 K tector, 120 E 24 DK tector 120 E 24, 120 E 24 DP tector, 120 E 25 FP tector	09.00 - 09.15	F4AE3681D, F4AE0681B	 3400 700 486  3482 000 474  1878 004 584  3151 000 515	395 10 MF395 395WGTZ KZIS-4	Getr. / GBox: 6AS800/6AS1000		
	09.00 - 09.15		3400 074 031  3482 078 134  1878 007 339  3151 000 144	400 10 MFZ400 380GTZ KZISZ-5	Getriebenummer / Transmission Number: 2895.9 Getr. / GBox: Iveco 9-Gear	(28)	
120 E 25 K tector, 120 E 25 DK tector 140 E 25 K tector, 140 E 25 DK tector 140 E 25 W tector, 140 E 25 WS tector 140 E 28 K tector 140 E 28 tector, 140 E 28 P tector, 140 E 28 FP tector 140 E D 25 tector, 140 E 25 P tector, 140 E 25 FP tector 150 E 25 K tector 150 E 25 W tector 150 E 25 WS tector 150 E 28 W tector 160 E 25 K tector 160 E 25 tector, 160 E 25 P tector 160 E 28 tector, 160 E 28 P tector 180 E 25 K tector 190 E 25 tector, 190 E 25 P tector	09.06 - 09.15	F4AE3681E, F4AE3681D, F4AE0681A	 3400 700 636	400 10	Nabenprofil / Hub Profile: 36x44,6-10N	(48)	
120 EL 17, 120 EL 17 P tector, 120 E 18, 120 EL 18 tector	09.00 - 09.15	F4AE3481A, F4AE0481A	 3400 700 431	330 10	Nabenprofil / Hub Profile: 1 1/2"-10N	(48)	
120 EL 21, 120 EL 21 P tector, 120 E 22, 120 EL 22 tector	09.00 - 09.15	F4AE0681D, F4AE3681B, F4AE0681C	 3400 700 430	350 10	Getriebenummer / Transmission Number: 2870.9 Getr. / GBox: Iveco 9-Gear Nabenprofil / Hub Profile: 1 1/2"-10N	(28)	
			3400 700 430	350 10	Getriebenummer / Transmission Number: 2865.6 Getr. / GBox: Iveco 6-Gear Nabenprofil / Hub Profile: 1 1/2"-10N	(28)	























		CODE				
--	--	------	--	---	---	---

IVECO

EuroCargo I-III		01.91 - 09.15					
130 E 15	01.91 - 09.15	8060		3400 700 449 ■  3482 094 031  1878 000 611  3151 600 544	310 10 MFZ310 310TB KZISZ-3	Getriebenummer / Transmission Number: 2870.9 E5BA12BD / E5BAC1B1 / E5BAC2B1 / E5BAC2E1 / E5BAC4B1 / E5BAC5B1 / E5BBC3ED / E5BBC7BD Nabenprofil / Hub Profile: 1 1/2"-10N	(28)
				3400 700 449 ■  3482 094 031  1878 000 611  3151 600 544	310 10 MFZ310 310TB KZISZ-3	Getriebenummer / Transmission Number: 2845.6 E1HHC2A1 / E1HHC2AD / E1HHC4A1 / E1HHC5AD / E1HHC6AD / E1HHC7A1 / E1HHC7AD / E1HHC8A1 / E1HHC8AD / E1HHC9AD / E5BAC1A1 / E5BAC1AD / E5BAC2A1 / E5BAC2AD / E5BAC2D1 / E5BAC2DD / E5BAC3A1 / E5BAC3AD / E5BAC3D1 / E5BAC3DD / E5BAC4A1 / E5BAC4AD / E5BAC4D1 / E5BAC4DD / E5BAC5A1 / E5BAC5AD / E5BAC5D1 / E5BAC5DD / E5BAC6A1 / E5BAC6AD / E5BAC6D1 / E5BAC7A1 / E5BAC7AD / E5BAC7D1 / E5BAC7DD / E5BBC3AD / E5BBC3DD / E5BBC5AD / E5BBC5DD / E5BBC6DD Nabenprofil / Hub Profile: 1 1/2"-10N	(48)
130 E 15 K	01.91 - 09.15	8060		3400 700 449 ■  3482 094 031  1878 000 611  3151 600 544	310 10 MFZ310 310TB KZISZ-3	Getriebenummer / Transmission Number: 2845.6 E5BAD1A1 / E5BAD1AD / E5BAD2A1 / E5BAD2AD Nabenprofil / Hub Profile: 1 1/2"-10N	(28)
130 E 18	01.91 - 09.15	8060		3400 700 449 ■  3482 094 031  1878 000 611  3151 600 544	310 10 MFZ310 310TB KZISZ-3	Getriebenummer / Transmission Number: 2870.9 E1KHC2B1 / E1KHC4B1 / E1KHC5B1 / E1KHC6B1 / E1KHC7B1 / E1KHC7E1 / E1KHC8B1 / E1KLC5B1 / E1KLC7B1 / E5CA11B1 / E5CA12B1 / E5CA12BD / E5CA13B1 / E5CA13E1 / E5CA14B1 / E5CA14E1 / E5CA15B1 / E5CA15BD / E5CA15E1 / E5CA16B1 / E5CA16E1 / E5CA17B1 / E5CAC1B1 / E5CAC2B1 / E5CAC3B1 / E5CAC3E1 / E5CAC4B1 / E5CAC4E1 / E5CAC5B1 / E5CAC5E1 / E5CAC6B1 / E5CAC6E1 / E5CAC7B1 / E5CAC7E1 / E5CB13B1 / E5CB15B1 / E5CB15E1 / E5CB16B1 / E5CB16E1 / E5CB17B1 / E5CBC3B1 / E5CBC5B1 / E5CBC5E1 / E5CBC6E1 / E5CBC7E1 Nabenprofil / Hub Profile: 1 1/2"-10N	(28)
				3400 700 449 ■  3482 094 031  1878 000 611  3151 600 544	310 10 MFZ310 310TB KZISZ-3	Getriebenummer / Transmission Number: 2855.6 E1KHC2A1 / E1KHC2AD / E1KHC4A1 / E1KHC5A1 / E1KHC6A1 / E1KHC7A1 / E1KHC8A1 / E1KHC8AD / E1KHC9A1 / E1KHC9AD / E1KHC9DD / E1KLC8AD / E1KLC9DD / E5CAC1A1 / E5CAC1AD / E5CAC2A1 / E5CAC2AD / E5CAC2D1 / E5CAC3A1 / E5CAC3AD / E5CAC3DD / E5CAC4A1 / E5CAC4AD / E5CAC4D1 / E5CAC5A1 / E5CAC5AD / E5CAC5D1 / E5CAC5DD / E5CAC6A1 / E5CAC6AD / E5CAC6D1 / E5CAC6DD / E5CAC7A1 / E5CAC7AD / E5CAC7D1 / E5CAC7DD / E5CBC3A1 / E5CBC3AD / E5CBC5A1 / E5CBC6A1 / E5CBC6D1 / E5CBC7A1 / E5CBC7D1 Nabenprofil / Hub Profile: 1 1/2"-10N	(48)
130 E 18 D tector, 130 E 18 DP tector	09.06 - 09.15	F4AE3481A		3400 700 452 ■	350 10	EKRAC2D1 / EKRAC2DA / EKRAC4D1 / EKRAC4DA / EKRAC4DB / EKRAC5D1 / EKRAC5DA / EKRAC5DB / EKRAC6D1 / EKRAC6D2 / EKRAC6DA / EKRAC7D1 / EKRAC7D2 / EKRAC7DA / EKRAC7DB / EKRAC8D1 / EKRAC8D2 / EKRAC8DA / EKRAC8DB / EKRAC9D1 / EKRAC9D2 / EKRAC9DA / EKRAC9DB / EKRACBD1 / EKRACBD2 / EKRACBDA / EKRACBDB / EKRAE4D4 / EKRAE5D4 / EKRAE5DD / EKRAE6D4 / EKRAE6DD / EKRAE7D4 / EKRAE7DD / EKRAE8D4 / EKRAE8DD / EKRBC2D1 / EKRBC2DA / EKRBC4D1 / EKRBC4DA / EKRBC5D1 / EKRBC5DA / EKRBC6D1 / EKRBC6D2 / EKRBC7D1 EKRBC7D2 / EKRBC8D1 / EKRBC8D2 / EKRBC8DA / EKRBC8DB / EKRBC9D1 / EKRBC9D2 / EKRBC9DA / EKRBC9DB / EKRBCBD1 / EKRBED4 / EKRBED4 / EKRC8D1 / EKRC8D1 / EKRC8D1 / Nabenprofil / Hub Profile: 1 1/2"-10N	(48)
130 E 18 K	01.91 - 09.15	8060		3400 700 449 ■  3482 094 031  1878 000 611  3151 600 544	310 10 MFZ310 310TB KZISZ-3	Getriebenummer / Transmission Number: 2855.6 E5CAD1A1 / E5CAD2A1 Nabenprofil / Hub Profile: 1 1/2"-10N	(28)









		CODE				
--	--	------	--	---	---	---

IVECO

EuroCargo I-III		01.91 - 09.15				
130 E 18 K tector, 130 E 18 DK tector 130 E 18 tector, 130 E 18 D tector, 130 E 18 DP tector	09.00 - 09.15	F4AE0681		3400 700 430 ■	350 10	E4RA72D1 / E4RAC2G1 / E4RAC2GA / E4RAC4G1 / E4RAC4GA / E4RAC5G1 / E4RAC6G1 / E4RAC7G1 / E4RAC7G2 / E4RAC8G1 / E4RAC8G2 / E4RAC9G1 / E4RAC9G2 / E4RACBG1 / E4RACBGB / E4RAE5G3 / E4RAE6G3 / E4RAE7G3 / E4RBC2G1 / E4RBC4G1 / E4RBC5G1 / E4RBC5G2 / E4RBC6G1 / E4RBC6G2 / E4RBC7G1 / E4RBC7G2 / E4RBC8G1 / E4RBC8G2 / E4RBC9G1 / E4RBC9G2 / E4RBCBG2 / E4RBE6G3 / E4RCC5G1 / E4RCC6G1 / E4RCC7G1 / E4RCC8G2 / E4RCC9G2 Nabenprofil / Hub Profile: 1 1/2"-10N (48)
	09.00 - 09.15	F4AE0681D, F4AE0681E		3400 700 452 ■	350 10	E4RAC2D1 / E4RAC2DA / E4RAC4D1 / E4RAC4D2 / E4RAC4DA / E4RAC4DB / E4RAC5D1 / E4RAC5D2 / E4RAC5DA / E4RAC5DB / E4RAC6D1 / E4RAC6D2 / E4RAC6DA / E4RAC7D1 / E4RAC7D2 / E4RAC7DA / E4RAC7DB / E4RAC8D1 / E4RAC8D2 / E4RAC8DA / E4RAC8DB / E4RAC9D1 / E4RAC9D2 / E4RAC9DA / E4RAC9DB / E4RACBD1 / E4RACBDA / E4RACBDB / E4RAE4D3 / E4RAE5D3 / E4RAE6D3 / E4RAE6DC / E4RAE7D3 / E4RAE8D3 / E4RAE8DC / E4RBC2D1 / E4RBC2DA / E4RBC4D1 / E4RBC4DA / E4RBC5D1 / E4RBC5D2 / E4RBC5DA / E4RBC6D1 / E4RBC6DA / E4RBC6DB / E4RBC7D1 / E4RBC7D2 / E4RBC8D1 / E4RBC8D2 / E4RBC8DA / E4RBC9D1 / E4RBC9D2 / E4RBC9DA / E4RBCBD1 / E4RBCBD2 / E4RBCBDA / E4RBE5D3 / E4RBE7D3 / E4RCC5D1 / E4RCC5D2 / E4RCC6D1 / E4RCC7D1 / E4RCC7D2 / E4RCC7DA / E4RCC8D1 / E4RCC9D1 / E4RCCBD1 Nabenprofil / Hub Profile: 1 1/2"-10N (48)
130 E 23	01.91 - 09.15	8060		3400 068 031	330 10	Getriebenummer / Transmission Number: 2865.6 (28)
				 3482 093 031	MFZ330	E1MHC7A1 / E5DAC1A1 / E5DAC2A1 / E5DAC2D1 / E5DAC3A1 / E5DAC3D1 / E5DAC4A1 / E5DAC5A1 / E5DAC5D1 / E5DAC6A1 / E5DAC6D1 / E5DAC7A1 / E5DAC7D1
				 1862 310 132	330GSB	
				 3151 600 544	KZISZ-3	
				3400 068 031	330 10	Getriebenummer / Transmission Number: 2870.9 (28)
				 3482 093 031	MFZ330	E1MHC5B1 / E1MHC6B1 / E1MHC7B1 / E1MHC7E1 / E1MHC8E1 / E1MHC9B1 / E1MHC9E1 / E1MLC5B1 / E1MLC7B1 / E1MLC7E1 / E1MLC8B1 / E1MLC8E1 / E5DA12B1 / E5DA13B1 / E5DA14B1 / E5DA14E1 / E5DA15B1 / E5DA15E1 / E5DA16B1 / E5DA16E1 / E5DA17B1 / E5DA17E1 / E5DAC1B1 / E5DAC2B1 / E5DAC3B1 / E5DAC3E1 / E5DAC4B1 / E5DAC4E1 / E5DAC5B1 / E5DAC5E1 / E5DAC6B1 / E5DAC6E1 / E5DAC7B1 / E5DAC7E1 / E5DB13B1 / E5DB13E1 / E5DB15B1 / E5DB15E1 / E5DB16B1 / E5DB16E1 / E5DB17E1 / E5DBC3B1 / E5DBC3E1 / E5DBC5B1 / E5DBC5E1 / E5DBC6E1 / E5DBC7B1 / E5DBC7E1 / E5DC13E1 / E5DC15B1 / E5DC16BD / E5DC17B1 / E5DC17E1 / E5DCC5B1 / E5DCC5E1 / E5DCC6B1
 1862 310 132	330GSB					
 3151 600 544	KZISZ-3					
			3400 700 449 ■	310 10	Getriebenummer / Transmission Number: 2870.9 (28)	
			 3482 094 031	MFZ310	E1MHC4B1	
			 1878 000 611	310TB	Nabenprofil / Hub Profile: 1 1/2"-10N (48)	
			 3151 600 544	KZISZ-3		
			3400 700 449 ■	310 10	Getriebenummer / Transmission Number: 2865.6 (28)	
			 3482 094 031	MFZ310	E1MHC4A1	
			 1878 000 611	310TB	Nabenprofil / Hub Profile: 1 1/2"-10N (48)	
			 3151 600 544	KZISZ-3		
			3400 068 031	330 10	->Chass. 2253628	
			 3482 093 031	MFZ330	Getriebenummer / Transmission Number: ZF S6.36 (28)	
			 1862 310 132	330GSB	OD+N36/10	
			 3151 600 544	KZISZ-3	E1MHC4A1 / E1MHC4B1	
130 E 24 K tector, 130 E 24 DK tector	09.00 - 09.15	F4AE0681		3400 074 031	400 10	E4TCC7G2 / E4TCC8G1 / E4TCC8G2 / E4TCC9G1 / E4TCC9G2 / E4TCCBG1 / E4TCCBG2 / E4TAC2G1 / E4TAC4G1 / E4TAC5G1 / E4TAC5G2 / E4TAC6G1 / E4TAC6G2 / E4TAC7G1 / E4TAC7G2 / E4TAC7GA / E4TAC8G1 / E4TAC8G2 / E4TAC8GA / E4TAC8GB / E4TAC9G1 / E4TAC9G2 / E4TACBG1 / E4TACBG2 / E4TAE6G3 / E4TAE8G3 / E4TBC2G1 / E4TBC4G1 / E4TBC4G2 / E4TBC5G1 / E4TBC5G2 / E4TBC6G1 / E4TBC6G2 / E4TBC7G1 / E4TBC7G2 / E4TBC8G1 / E4TBC8G2 / E4TBC9G1 / E4TBC9G2 / E4TBC9GA / E4TBC9GB / E4TBCBG1 / E4TBCBG2 / E4TBE4G3 / E4TBE7G3 / E4TBE8G3 / E4TBE8GC / E4TCC5G1 / E4TCC5G2 / E4TCC6G1 / E4TCC6G2 / E4TCC7G1
				 3482 078 134	MFZ400	
				 1878 007 339	380GTZ	
				 3151 000 144	KZISZ-5	

		CODE				
--	--	------	--	---	---	---

IVECO

EuroCargo I-III		01.91 - 09.15					
130 E 24 tector, 130 E 24 D tector, 130 E 24 DP tector	09.00 - 09.15	F4AE0681		3400 074 031 ⊗ 3482 078 134 ⊗ 1878 007 339 ⊙ 3151 000 144	400 10 MFZ400 380GTZ KZISZ-5	E4TAC2G1 / E4TAC4G1 / E4TAC5G1 / E4TAC5G2 / E4TAC6G1 / E4TAC6G2 / E4TAC7G1 / E4TAC7G2 / E4TAC7GA / E4TAC8G1 / E4TAC8G2 / E4TAC8GA / E4TAC8GB / E4TAC9G1 / E4TAC9G2 / E4TACBG1 / E4TACBG2 / E4TAE6G3 / E4TAE8G3 / E4TBC2G1 / E4TBC4G1 / E4TBC4G2 / E4TBC5G1 / E4TBC5G2 / E4TBC6G1 / E4TBC6G2 / E4TBC7G1 / E4TBC7G2 / E4TBC8G1 / E4TBC8G2 / E4TBC9G1 / E4TBC9G2 / E4TBC9GA / E4TBC9GB / E4TBCBG1 / E4TBCBG2 / E4TBE4G3 / E4TBE7G3 / E4TBE8G3 / E4TBE8GC / E4TCC5G1 / E4TCC5G2 / E4TCC6G1 / E4TCC6G2 / E4TCC7G1 / E4TCC7G2 / E4TCC8G1 / E4TCC8G2 / E4TCC9G1 / E4TCC9G2 / E4TCCBG1 / E4TCCBG2	
		F4AE0681B		3400 700 486 ⊗ 3482 000 474 ⊗ 1878 004 584 ⊙ 3151 000 515	395 10 MF395 395WGTZ KZIS-4	Getr. / GBox: 6AS800/6AS1000	
130 E 28 K tector 130 E 28 tector	09.00 - 09.15 09.00 - 09.15	F4AE0681		3400 074 031 ⊗ 3482 078 134 ⊗ 1878 007 339 ⊙ 3151 000 144	400 10 MFZ400 380GTZ KZISZ-5	E4UAC2G1 / E4UAC4G1 / E4UAC5G1 / E4UAC5G2 / E4UAC6G1 / E4UAC6G2 / E4UAC7G1 / E4UAC7G2 / E4UAC8G1 / E4UAC8G2 / E4UAC9G1 / E4UAC9G2 / E4UACBG1 / E4UACBG2 / E4UBC2G1 / E4UBC4G1 / E4UBC4G2 / E4UBC5G1 / E4UBC5G2 / E4UBC6G1 / E4UBC6G2 / E4UBC7G1 / E4UBC7G2 / E4UBC8G1 / E4UBC8G2 / E4UBC9G1 / E4UBC9G2 / E4UBC9GB / E4UBCBG1 / E4UBCBG2 / E4UCC5G1 / E4UCC5G2 / E4UCC6G1 / E4UCC6G2 / E4UCC7G1 / E4UCC7G2 / E4UCC8G1 / E4UCC8G2 / E4UCC9G1 / E4UCC9G2 / E4UCCBG2	
135 E 18 W	01.91 - 09.15	8060		3400 700 449 ■ ⊗ 3482 094 031 ⊗ 1878 000 611 ⊙ 3151 600 544	310 10 MFZ310 310TB KZISZ-3	Getriebenummer / Transmission Number: 2865.6 E3KPC1A1 / E3KPC2A1 / E3KPC2AD / E3KPC3A1 / E3KPC3AD Nabenprofil / Hub Profile: 1 1/2"-10N	(28) (48)
135 E 18 WR	01.91 - 09.15	8060		3400 700 449 ■ ⊗ 3482 094 031 ⊗ 1878 000 611 ⊙ 3151 600 544	310 10 MFZ310 310TB KZISZ-3	Getriebenummer / Transmission Number: 2865.6 E1CE11A1 / E1CE11AD / E1CE12A1 / E1CE12AD / E1CE13A1 / E1CE13AD Nabenprofil / Hub Profile: 1 1/2"-10N	(28) (48)
135 E 23 W	01.91 - 09.15	8060		3400 068 031 ⊗ 3482 093 031 ⊗ 1862 310 132 ⊙ 3151 600 544	330 10 MFZ330 330GSB KZISZ-3	->Chass. 2253628 Getriebenummer / Transmission Number: S6-36/2-5 E3MPC2C1	(28)
				3400 068 031 ⊗ 3482 093 031 ⊗ 1862 310 132 ⊙ 3151 600 544	330 10 MFZ330 330GSB KZISZ-3	->Chass. 2253628 Getriebenummer / Transmission Number: 2865.6 E3MPC1A1 / E3MPC1AD / E3MPC2A1 / E3MPC3A1 / E3MPC3AD	(28)
135 E 23 WR	01.91 - 09.15	8060		3400 068 031 ⊗ 3482 093 031 ⊗ 1862 310 132 ⊙ 3151 600 544	330 10 MFZ330 330GSB KZISZ-3	->Chass. 2253628 Getriebenummer / Transmission Number: 2865.6 E1DE11A1 / E1DE11AD / E1DE12A1 / E1DE12AD / E1DE13A1 / E1DE13AD	(28)
140 E 18 W tector	09.00 - 09.15	Tector6F4AE0681E		3400 700 430 ■ ⊗ 3482 093 031 ⊗ 1862 310 132 ⊙ 3151 600 544	350 10	06.2003-> Getriebenummer / Transmission Number: 2865.6 Getr. / GBox: Iveco 6-Gear Nabenprofil / Hub Profile: 1 1/2"-10N	(28) (48)
140 E 24 W tector, 140 E 24 WS tector	09.00 - 09.15	F4AE0681B		3400 700 486 ⊗ 3482 000 474 ⊗ 1878 004 584 ⊙ 3151 000 515	395 10 MF395 395WGTZ KZIS-4	Getr. / GBox: 6AS800/6AS1000	
				3400 074 031 ⊗ 3482 078 134 ⊗ 1878 007 339 ⊙ 3151 000 144	400 10 MFZ400 380GTZ KZISZ-5		





IVECO

EuroCargo I-III		01.91 - 09.15					
140 E 28 W tector, 140 E 28 WS tector	09.06 - 09.15	F4AE3681E, F4AE0681A, F4AE3681A		3400 700 636 ■ 3400 700 486 ⊗ 3482 000 474 ⊗ 1878 004 584 ⊗ 3151 000 515	400 10 395 10 MF395 395WGTZ KZIS-4	Nabenprofil / Hub Profile: 36x44,6-10N Getr. / GBox: 6AS800/6AS1000	(48)
150 E 28 WS tector	09.06 - 09.15						
150 E 30 K tector	09.06 - 09.15						
150 E 30 tector, 150 E 30 P tector, 150 E 30 FP tector	09.06 - 09.15						
160 E 28 K tector	09.06 - 09.15						
160 E 30 K tector	09.06 - 09.15						
160 E 30 tector, 160 E 30 P tector	09.06 - 09.15						
180 E 30 K tector	09.06 - 09.15						
180 E 30 tector, 180 E 30 P tector	08.06 - 09.15						
190 E 28 tector, 190 E 28 P tector	05.08 - 09.15						
190 E 30 tector, 190 E 30 P tector	05.08 - 09.15						
150 E 15	01.91 - 09.15	8060		3400 700 449 ■ ⊗ 3482 094 031 ⊗ 1878 000 611 ⊗ 3151 600 544	310 10 MFZ310 310TB KZISZ-3	Getriebenummer / Transmission Number: 2870.9 E2BAC1BD / E2BAC2BD / E2BAC2ED / E2BAC5BD / E2BAC6BD Nabenprofil / Hub Profile: 1 1/2"-10N	(28) (48)
				3400 700 449 ■ ⊗ 3482 094 031 ⊗ 1878 000 611 ⊗ 3151 600 544	310 10 MFZ310 310TB KZISZ-3	Getriebenummer / Transmission Number: 2845.6 E2BAC1AD / E2BAC2A1 / E2BAC2AD / E2BAC2DD / E2BAC3A1 / E2BAC3AD / E2BAC4A1 / E2BAC4AD / E2BAC4DD / E2BAC5A1 / E2BAC5AD / E2BAC6A1 / E2BAC6AD / E2BAC7A1 / E2BAC7AD / E2BAC7D1 / E2BAC7DD / E2BBC5AD / E2HHC7AD / E2HHC8AD / E2HHC9AD Nabenprofil / Hub Profile: 1 1/2"-10N	(28) (48)
150 E 15 K	01.91 - 09.15	8060		3400 700 449 ■ ⊗ 3482 094 031 ⊗ 1878 000 611 ⊗ 3151 600 544	310 10 MFZ310 310TB KZISZ-3	Getriebenummer / Transmission Number: 2845.6 E2BAD1A1 / E2BAD1AD / E2BAD2A1 Nabenprofil / Hub Profile: 1 1/2"-10N	(28) (48)
150 E 18 K	01.91 - 09.15	8060		3400 700 449 ■ ⊗ 3482 094 031 ⊗ 1878 000 611 ⊗ 3151 600 544	310 10 MFZ310 310TB KZISZ-3	Getriebenummer / Transmission Number: 2870.9 E2CA31B1 / E2CA32B1 / E2CAD1B1 / E2CAD2B1 Nabenprofil / Hub Profile: 1 1/2"-10N	(28) (48)
				3400 700 449 ■ ⊗ 3482 094 031 ⊗ 1878 000 611 ⊗ 3151 600 544	310 10 MFZ310 310TB KZISZ-3	Getriebenummer / Transmission Number: 2865.6 E2CAD1A1 / E2CAD2A1 Nabenprofil / Hub Profile: 1 1/2"-10N	(28) (48)
150 E 18 K tector	09.00 - 09.15	F4AE0681		3400 700 430 ■	350 10	E6RA72GA / E6RAC2D1 / E6RAC2DA / E6RAC2G1 / E6RAC2GA / E6RAC4D1 / E6RAC4DA / E6RAC4G1 / E6RAC4GA / E6RAC5D1 / E6RAC5DA / E6RAC5DB / E6RAC5G1 / E6RAC5G2 / E6RAC5GA / E6RAC6D1 / E6RAC6DA / E6RAC6G1 / E6RAC7D1 / E6RAC7DA / E6RAC7G1 / E6RAC7G2 / E6RAC8D1 / E6RAC8DA / E6RAC8G1 / E6RAC9D1 / E6RAC9D2 / E6RAC9DA / E6RAC9G1 / E6RAC9G2 / E6RACBD1 / E6RBC2G1 / E6RBC4G1 / E6RBC4G2 / E6RBC5D1 / E6RBC5DA / E6RBC5G1 / E6RBC6G1 / E6RBC6G2 / E6RBC7D1 / E6RBC7DA / E6RBC7G1 / E6RBC8D1 / E6RBC8G1 / E6RBC9G1 E6RBC9G2 / E6RBCBDA Nabenprofil / Hub Profile: 1 1/2"-10N	(48)
150 E 18 tector	09.00 - 09.15						
		F4AE0681E		3400 700 452 ■	350 10	E7REC1D1 / E7REC2D1 / E7REC3D1 / E7REC3DA Nabenprofil / Hub Profile: 1 1/2"-10N	(48)
150 E 18 K tector	09.06 - 09.15	F4AE3481A		3400 700 452 ■	350 10	E7REC1D1 / E7REC2D1 / E7REC3D1 / E7REC3DA Nabenprofil / Hub Profile: 1 1/2"-10N	(48)
150 E 18 tector, 150 E 18 P tector, 150 E 18 FP tector	09.06 - 09.15			3400 700 487 ⊗ 3482 000 419 ⊗ 1878 079 331 ⊗ 3151 000 515	362 10 MF362 362WGTZ KZIS-4	Getr. / GBox: ZF 6AS 700 T0	
				3400 700 475 ■	362 10	Getr. / GBox: ZF 6S 700 T0 Nabenprofil / Hub Profile: 31,02x38,55-10N	(48)
				3400 700 474 ■	362 10	Getr. / GBox: ZF S5-42 Nabenprofil / Hub Profile: 31,01x38,53-10N	(48)

		CODE				
--	--	------	--	---	---	---

IVECO



































EuroCargo I-III		01.91 - 09.15				
150 E 18, 150 E 18 P	01.91-09.15	8060	 3400 700 449 ■ 3482 094 031 1878 000 611 3151 600 544	310 10 MFZ310 310TB KZISZ-3	Getriebenummer / Transmission Number: 2865.6 E2CAC1A1 / E2CAC1AD / E2CAC2A1 / E2CAC2AD / E2CAC2D1 / E2CAC2DD / E2CAC3A1 / E2CAC3AD / E2CAC3D1 / E2CAC4A1 / E2CAC4AD / E2CAC4D1 / E2CAC4DD / E2CAC5A1 / E2CAC5AD / E2CAC5D1 / E2CAC5DD / E2CAC6A1 / E2CAC6AD / E2CAC6D1 / E2CAC6DD / E2CAC7A1 / E2CAC7AD / E2CAC7D1 / E2CAC7DD / E2CBC5A1 / E2CBC6A1 / E2CBC7A1 / E2KHC2A1 / E2KHC2AD / E2KHC4A1 / E2KHC5A1 / E2KHC6A1 / E2KHC7A1 / E2KHC7AD / E2KHC7D1 / E2KHC8A1 / E2KHC8AD / E2KHC9A1 / E2KHC9AD / E2KHC9DD Nabenprofil / Hub Profile: 1 1/2"-10N	(28)
			3400 700 449 ■ 3482 094 031 1878 000 611 3151 600 544	310 10 MFZ310 310TB KZISZ-3	Getriebenummer / Transmission Number: 2870.9 E2CA11B1 / E2CA12B1 / E2CA12E1 / E2CA13B1 / E2CA13E1 / E2CA14B1 / E2CA14E1 / E2CA15B1 / E2CA15E1 / E2CA16B1 / E2CA16E1 / E2CA17B1 / E2CA17E1 / E2CAC1B1 / E2CAC1BD / E2CAC2B1 / E2CAC2BD / E2CAC2E1 / E2CAC3B1 / E2CAC3BD / E2CAC3E1 / E2CAC4B1 / E2CAC4BD / E2CAC4E1 / E2CAC5B1 / E2CAC5BD / E2CAC5E1 / E2CAC5ED / E2CAC6B1 / E2CAC6BD / E2CAC6E1 / E2CAC6ED / E2CAC7B1 / E2CAC7BD / E2CAC7E1 / E2CAC7ED / E2CB13B1 / E2CB15B1 / E2CB15E1 / E2CB16B1 / E2CB17B1 / E2CB17E1 / E2CBC3B1 / E2CBC3E1 / E2CBC5B1 E2CBC5E1 / E2CBC6B1 / E2CBC6E1 / E2CBC7B1 / E2CBC7E1 / E2KHC2B1 / E2KHC2BD / E2KHC4B1 / E2KHC4BD / E2KHC4E1 / E2KHC5B1 / E2KHC5E1 / E2KHC6B1 / E2KHC7B1 / E2KHC8B1 / E2KHC8BD / E2KHC9B1 / E2KHC9E1 / E2KLC5B1 / E2KLC5E1 / E2KLC7E1 Nabenprofil / Hub Profile: 1 1/2"-10N	(28)
150 E 23, 150 E 23 P, 150 E 23 FP	01.91-09.15	8060	 3400 068 031 3482 093 031 1862 310 132 3151 600 544	330 10 MFZ330 330GSB KZISZ-3	Getriebenummer / Transmission Number: 2865.6 E2DAC7A1 / E2DAC7D1 / E2DCC7AD / E2DAC1A1 / E2DAC2A1 / E2DAC2D1 / E2DAC3A1 / E2DAC3D1 / E2DAC4A1 / E2DAC4D1 / E2DAC5A1 / E2DAC5D1 / E2DAC6A1 / E2DAC6D1 / E2MHC4A1 / E2MHC5A1 / E2MHC7A1 / E2MHC8A1	(28)
			3400 068 031 3482 093 031 1862 310 132 3151 600 544	330 10 MFZ330 330GSB KZISZ-3	Getriebenummer / Transmission Number: 2870.9 E2DAC6E1 / E2DAC7B1 / E2DAC7E1 / E2DB13B1 / E2DB13E1 / E2DB15B1 / E2DB15E1 / E2DB16B1 / E2DB16E1 / E2DB17B1 / E2DB17E1 / E2DBC3B1 / E2DBC3E1 / E2DBC5B1 / E2DBC5E1 / E2DBC6B1 / E2DBC6E1 / E2DBC7B1 / E2DBC7E1 / E2DC13B1 / E2DC13E1 / E2DC15B1 / E2DC16B1 / E2DC16E1 / E2DC17B1 / E2DC17E1 / E2DCC3B1 / E2DCC3E1 / E2DCC5B1 / E2DCC5E1 / E2DCC6B1 / E2DCC6E1 / E2DCC7B1 / E2DCC7E1 / E2MHC2B1 / E2DA11B1 / E2DA12B1 / E2DA12E1 / E2DA13B1 / E2DA13E1 / E2DA14B1 / E2DA14E1 / E2DA15B1 / E2DA15E1 / E2DA16B1 E2DA16E1 / E2DA17B1 / E2DA17E1 / E2DAC1B1 / E2DAC2B1 / E2DAC2E1 / E2DAC3B1 / E2DAC3E1 / E2DAC4B1 / E2DAC4E1 / E2DAC5B1 / E2DAC5E1 / E2DAC6B1 / E2MHC5B1 / E2MHC6B1 / E2MHC7B1 / E2MHC8B1 / E2MHC8E1 / E2MHC9B1 / E2MHC9E1 / E2MLC5B1 / E2MLC7B1 / E2MLC7E1 / E2MLC8B1 / E2MLC8E1 / E2MLC9B1 / E2MLC9E1	(28)
			3400 700 449 ■ 3482 094 031 1878 000 611 3151 600 544	310 10 MFZ310 310TB KZISZ-3	Getriebenummer / Transmission Number: 2870.9 E2MHC4B1 Nabenprofil / Hub Profile: 1 1/2"-10N	(28)
			3400 068 031 3482 093 031 1862 310 132 3151 600 544	330 10 MFZ330 330GSB KZISZ-3	Getriebenummer / Transmission Number: 2870S.9 E2MMC9E1	(28)
			3400 068 031 3482 093 031 1862 310 132 3151 600 544	330 10 MFZ330 330GSB KZISZ-3	->Chass. 2253628 Getriebenummer / Transmission Number: ZF S6.36 OD+N36/10 E2MHC4B1	(28)
150 E 24 K tector	09.00-09.15	F4AE0681	 3400 074 031 3482 078 134 1878 007 339 3151 000 144	400 10 MFZ400 380GTZ KZISZ-5	E6TA87E1 / E6TAC2G1 / E6TAC2GA / E6TAC4G1 / E6TAC5G1 / E6TAC5G2 / E6TAC6G1 / E6TAC6G2 / E6TAC6GA / E6TAC7G1 / E6TAC7G2 / E6TAC8G1 / E6TAC8G2 / E6TAC9G1 / E6TAC9G2 / E6TAC9GA / E6TACBG1 / E6TACBG2 / E6TACBGA / E6TBC2G1 / E6TBC4G1 / E6TBC5G1 / E6TBC5G2 / E6TBC6G1 / E6TBC6G2 / E6TBC7G1 / E6TBC7G2 / E6TBC8G1 / E6TBC8G2 / E6TBC9G1 / E6TBC9G2	



































IVECO























EuroCargo I-III		01.91 - 09.15				
150 E 24 tector, 150 E 25 tector	09.00 - 09.15	F4AE0681	3400 074 031 3482 078 134 1878 007 339 3151 000 144	400 10 MFZ400 380GTZ KZISZ-5	E6TA87E1 / E6TAC2G1 / E6TAC2GA / E6TAC4G1 / E6TAC5G1 / E6TAC5G2 / E6TAC6G1 / E6TAC6G2 / E6TAC6GA / E6TAC7G1 / E6TAC7G2 / E6TAC8G1 / E6TAC8G2 / E6TAC9G1 / E6TAC9G2 / E6TAC9GA / E6TACBG1 / E6TACBG2 / E6TACBGA / E6TBC2G1 / E6TBC4G1 / E6TBC5G1 / E6TBC5G2 / E6TBC6G1 / E6TBC6G2 / E6TBC7G1 / E6TBC7G2 / E6TBC8G1 / E6TBC8G2 / E6TBC9G1 / E6TBC9G2 / E6TBCBG1 / E6TBCBG2 / E6TCC5G1 / E6TCC6G1 / E6TCC7G1 / E6TCC7G2 / E6TCC8G1 / E6TCC8G2 / E6TCC9G1 / E6TCC9G2 / E6TCCBG1 / E6TCCBG2	
		F4AE3681D, F4AE0681B	3400 700 486 3482 000 474 1878 004 584 3151 000 515	395 10 MF395 395WGTZ KZIS-4	Getr. / GBox: 6AS800/6AS1000	
150 E 27, 150 E 27 P, 150 E27FP, 150 E 27 R	01.91 - 09.15	8360.46	3400 074 031 3482 078 134 1878 007 339 3151 000 144	400 10 MFZ400 380GTZ KZISZ-5	Getriebenummer / Transmission Number: 2895.9 E2FA11A1 / E2FA12A1 / E2FA12C1 / E2FA13A1 / E2FA13C1 / E2FA14A1 / E2FA14C1 / E2FA15A1 / E2FA15AD / E2FA15C1 / E2FA16A1 / E2FA16C1 / E2FA17A1 / E2FA17C1 / E2FB13A1 / E2FB13C1 / E2FB15A1 / E2FB15C1 / E2FB16A1 / E2FB16C1 / E2FB17A1 / E2FB17C1 / E2FC13A1 / E2FC13C1 / E2FC15A1 / E2FC15C1 / E2FC16A1 / E2FC16C1 / E2FC17A1 / E2FC17C1	(28)
		8360.46E2	3400 074 031 3482 078 134 1878 007 339 3151 000 144	400 10 MFZ400 380GTZ KZISZ-5	Getriebenummer / Transmission Number: 2895.9 E2FH14A1 / E2FH15A1 / E2FH16A1 / E2FH17A1 / E2FH17D1 / E2FH18D1 / E2FH19D1 / E2FL18D1 / E2FL19D1	(28)
150 E 28 K tector	09.00 - 09.15	F4AE0681	3400 074 031 3482 078 134 1878 007 339 3151 000 144	400 10 MFZ400 380GTZ KZISZ-5	E6UA87G1 / E6UA87G5 / E6UAC4G1 / E6UAC5G1 / E6UAC5G2 / E6UAC6G1 / E6UAC6G2 / E6UAC7G1 / E6UAC7G2 / E6UAC8G1 / E6UAC8G2 / E6UAC9G1 / E6UAC9G2 / E6UBC2G1 / E6UBC4G1 / E6UBC5G1 / E6UBC5G2 / E6UBC6G1 / E6UBC6G2 / E6UBC7G1 / E6UBC7G2 / E6UBC8G1 / E6UBC8G2 / E6UBC9G1 / E6UBC9G2 / E6UBCBG1 / E6UBCBG2 / E6UCC5G1 / E6UCC6G1 / E6UCC6G2 / E6UCC7G1 / E6UCC7G2 / E6UCC8G1 / E6UCC8G2 / E6UCC8GB / E6UCC9G1 / E6UCC9G2 / E6UCC9GA / E6UCCBG1 / E6UCCBG2	
150 E 28 tector	09.00 - 09.15	F4AE0681	3400 074 031 3482 078 134 1878 007 339 3151 000 144	400 10 MFZ400 380GTZ KZISZ-5	E6UA87G1 / E6UA87G5 / E6UAC2G1 / E6UAC4G1 / E6UAC5G1 / E6UAC5G2 / E6UAC6G1 / E6UAC6G2 / E6UAC7G1 / E6UAC7G2 / E6UAC8G1 / E6UAC8G2 / E6UAC9G1 / E6UAC9G2 / E6UACBG2 / E6UBC2G1 / E6UBC4G1 / E6UBC5G1 / E6UBC5G2 / E6UBC6G1 / E6UBC6G2 / E6UBC7G1 / E6UBC7G2 / E6UBC8G1 / E6UBC8G2 / E6UBC9G1 / E6UBC9G2 / E6UBCBG1 / E6UBCBG2 / E6UCC5G1 / E6UCC6G1 / E6UCC6G2 / E6UCC7G1 / E6UCC7G2 / E6UCC8G1 / E6UCC8G2 / E6UCC8GB / E6UCC9G1 / E6UCC9G2 / E6UCC9GA / E6UCCBG1 / E6UCCBG2 / E6UCCBGB	
170 E 18 K, 180 E 18 K	01.91 - 09.15	8060	3400 700 449 ■ 3482 094 031 1878 000 611 3151 600 544	310 10 MFZ310 310TB KZISZ-3	Getriebenummer / Transmission Number: 2870.9 F0AAD2B1 / F0AAD2BD / F0AAD3B1 / F0AAD3BD Nabenprofil / Hub Profile: 1 1/2"-10N	(28) (48)
			3400 700 449 ■ 3482 094 031 1878 000 611 3151 600 544	310 10 MFZ310 310TB KZISZ-3	Getriebenummer / Transmission Number: 2865.6 F0AAD2A1 / F0AAD2AD / F0AAD3A1 / F0AAD3AD Nabenprofil / Hub Profile: 1 1/2"-10N	(28) (48)
170 E 18, 180 E 18	01.91 - 09.15	8060	3400 700 449 ■ 3482 094 031 1878 000 611 3151 600 544	310 10 MFZ310 310TB KZISZ-3	Getriebenummer / Transmission Number: 2870.9 F0AAC4E1 / F0AAC5B1 / F0AAC5BD / F0AAC5ED / F0AAC6B1 / F0AAC6BD / F0AAC6ED / F0AAC7B1 / F0AAC7BD / F0AAC7E1 / F0AAC7ED / F0AAC8BD / F0AAC8ED / F0AAC9BD / F0AAC9ED / F0ABC4BD / F0ABC4ED / F0ABC7BD / F0ABC7ED / F0ABC8BD / F0ABC8ED / F0ABC9BD / F0KHC2B1 / F0KHC2BD / F0KHC3B1 / F0KHC3BD / F0KHC4B1 / F0KHC8BD / F0AAC2B1 / F0AAC3B1 / F0AAC3BD / F0AAC3E1 / F0AAC3ED / F0AAC4B1 / F0AAC4BD Nabenprofil / Hub Profile: 1 1/2"-10N	(28) (48)
			3400 700 449 ■ 3482 094 031 1878 000 611 3151 600 544	310 10 MFZ310 310TB KZISZ-3	Getriebenummer / Transmission Number: 2865.6 F0AAC4D1 / F0AAC4DD / F0AAC5A1 / F0AAC5AD / F0AAC5D1 / F0AAC6A1 / F0AAC6AD / F0AAC6D1 / F0AAC7A1 / F0AAC7AD / F0AAC7DD / F0AAC8AD / F0AAC8DD / F0AAC9AD / F0AAC9DD / F0ABC5DD / F0ABC7AD / F0ABC8AD / F0ABC9DD	(28)

IVECO

EuroCargo I-III		01.91 - 09.15					
170 E 23 K, 180 E 23 K	01.91 - 09.15	8060		3400 068 031  3482 093 031  1862 310 132  3151 600 544	330 10 MFZ330 330GSB KZISZ-3	->Chass. 2253628 Getriebenummer / Transmission Number: 2870.9 F0BAD2B1 / F0BAD2BD / F0BAD3B1 / F0BAD3BD	(28)
				3400 068 031  3482 093 031  1862 310 132  3151 600 544	330 10 MFZ330 330GSB KZISZ-3	->Chass. 2253628 Getriebenummer / Transmission Number: 2865.6 F0BAD2A1 / F0BAD3A1	(28)
170 E 23, 180 E 23	01.91 - 09.15	8060		3400 068 031  3482 093 031  1862 310 132  3151 600 544	330 10 MFZ330 330GSB KZISZ-3	->Chass. 2253628 Getriebenummer / Transmission Number: 2870.9 F0BA12B1 / F0BA13B1 / F0BA13ED / F0BA14B1 / F0BA15B1 / F0BA15BD / F0BA15E1 / F0BA16B1 / F0BA16E1 / F0BA17B1 / F0BA17BD / F0BA17E1 / F0BA17ED / F0BAC2B1 / F0BAC2BD / F0BAC3B1 / F0BAC3BD / F0BAC3E1 / F0BAC4B1 / F0BAC4BD / F0BAC4E1 / F0BAC4ED / F0BAC5B1 / F0BAC5BD / F0BAC5E1 / F0BAC5ED / F0BAC6B1 / F0BAC6BD / F0BAC6E1 / F0BAC6ED / F0BAC7B1 / F0BAC7BD / F0BAC7E1 / F0BAC7ED / F0BAC8BD / F0BAC8ED / F0BAC9BD / F0BAC9ED / F0BB17BD / F0BB17ED / F0BBC4BD / F0BBC5BD / F0BBC6BD / F0BBC6ED / F0BBC7BD F0BBC7ED / F0BBC8BD / F0BBC8ED / F0BBC9BD / F0BBC9ED	(28)
				3400 068 031  3482 093 031  1862 310 132  3151 600 544	330 10 MFZ330 330GSB KZISZ-3	->Chass. 2253628 Getriebenummer / Transmission Number: 2865.6 F0BAC2A1 / F0BAC3A1 / F0BAC4A1 / F0BAC5A1 / F0BAC7A1 / F0BAC7D1 / F0BAC9DD	(28)
170 E 27, 180 E 27	01.91 - 09.15	8360.46E2		3400 074 031  3482 078 134  1878 007 339  3151 000 144	400 10 MFZ400 380GTZ KZISZ-5	Getriebenummer / Transmission Number: 2895.9 F0FHC2A1 / F0FHC3A1 / F0FHC3D1 / F0FHC4A1 / F0FHC5A1 / F0FHC6A1 / F0FHC7A1 / F0FHC7D1 / F0FHC8A1 / F0FHC8D1 / F0FHC9D1 / F0FLC4A1 / F0FLC4D1 / F0FLC5A1 / F0FLC5D1 / F0FLC6A1 / F0FLC6D1 / F0FLC7A1 / F0FLC7D1 / F0FLC8AD / F0FLC8D1 / F0FLC9AD / F0FLC9D1	(28)
180 E 21 K tector 180 E 21 tector	09.00 - 09.15 09.00 - 09.15	F4AE0681		3400 700 430	350 10	F0SAC4DA / F0SAC4G1 / F0SAC5D1 / F0SAC5D2 / F0SAC5DA / F0SAC5G1 / F0SAC6DA / F0SAC6G1 / F0SAC7DA / F0SAC7G1 / F0SAC8D1 / F0SAC8DA / F0SAC8G1 / F0SAC9D1 / F0SAC9DA / F0SAC9G1 / F0SAC9G2 / F0SACAD1 / F0SACADA / F0SACAG1 / F0SACBDA / F0SACBDB / F0SACBGA / F0SBC6G1 / F0SBC7G1 / F0SBC9DA / F0SBC9DB / F0SBC9GA / F0SBCAGA / F0SBCBDB Nabenprofil / Hub Profile: 1 1/2"-10N	(48)
180 E 21 T	01.91 - 09.15	8060		3400 068 031  3482 093 031  1862 310 132  3151 600 544	330 10 MFZ330 330GSB KZISZ-3	Getriebenummer / Transmission Number: 2865.6 D3LA22A1 / D3LA22AD / D3LA22C1 / D3LA22CD / D3LB22A1 / D3LB22C1	(28)
180 E 24 K tector	09.00 - 09.15	F4AE0681		3400 074 031  3482 078 134  1878 007 339  3151 000 144	400 10 MFZ400 380GTZ KZISZ-5	F0TAC4G1 / F0TAC4GA / F0TAC5G1 / F0TAC5GA / F0TAC5GB / F0TAC6G1 / F0TAC6G2 / F0TAC6GA / F0TAC7G1 / F0TAC7GA / F0TAC8G1 / F0TAC8GA / F0TAC9G1 / F0TAC9G2 / F0TAC9GA / F0TAC9GB / F0TACAG1 / F0TACAG2 / F0TACAGA / F0TACAGB / F0TACBG1 / F0TACBG2 / F0TACBGA / F0TACBGB / F0TBC4G1 / F0TBC5G1 / F0TBC6G1 / F0TBC7G1 / F0TBC7GA / F0TBC8G1 / F0TBC8G2 / F0TBC8GB / F0TBC9G1 / F0TBC9G2 / F0TBC9GA / F0TBCAG1 / F0TBCAG2 / F0TBCAGA / F0TBCAGB / F0TBCBG1 / F0TBCBG2 / F0TBCBGB	
180 E 24, 180 E 25 tector	09.00 - 09.15	F4AE0681		3400 700 430	350 10	F0SBCBDB Nabenprofil / Hub Profile: 1 1/2"-10N	(48)
				3400 074 031  3482 078 134  1878 007 339  3151 000 144	400 10 MFZ400 380GTZ KZISZ-5	F0TAC4G1 / F0TAC4GA / F0TAC5G1 / F0TAC5GA / F0TAC5GB / F0TAC6G1 / F0TAC6G2 / F0TAC6GA / F0TAC7G1 / F0TAC7GA / F0TAC8G1 / F0TAC8GA / F0TAC9G1 / F0TAC9G2 / F0TAC9GA / F0TAC9GB / F0TACAG1 / F0TACAG2 / F0TACAGA / F0TACAGB / F0TACBG1 / F0TACBG2 / F0TACBGA / F0TACBGB / F0TBC4G1 / F0TBC5G1 / F0TBC6G1 / F0TBC7G1 / F0TBC7GA / F0TBC8G1 / F0TBC8G2 / F0TBC8GB / F0TBC9G1 / F0TBC9G2 / F0TBC9GA / F0TBCAG1 / F0TBCAG2 / F0TBCAGA / F0TBCAGB / F0TBCBG1 / F0TBCBG2 / F0TBCBGB	
180 E 28 K tector	09.00 - 09.15	F4AE0681		3400 074 031  3482 078 134  1878 007 339  3151 000 144	400 10 MFZ400 380GTZ KZISZ-5	F0UAC4G1 / F0UAC4GA / F0UAC5G1 / F0UAC5G2 / F0UAC6G1 / F0UAC6G2 / F0UAC7G1 / F0UAC7G2 / F0UAC8G1 / F0UAC8G2 / F0UAC8GA / F0UAC9G1 / F0UAC9G2 / F0UAC9GA / F0UACAG1 / F0UACAG2 / F0UACAGA / F0UACAGB / F0UACBG1 / F0UACBG2 / F0UACBGA / F0UACBGB / F0UAC4G1 /	









IVECO













EuroCargo I-III		01.91 - 09.15					
180 E 28 tector, 180 E 28 P tector	09.00 - 09.15	F4AE0681		3400 074 031  3482 078 134  1878 007 339  3151 000 144	400 10 MFZ400 380GTZ KZISZ-5	F0UAC4G1 / F0UAC4GA / F0UAC5G1 / F0UAC5G2 / F0UAC6G1 / F0UAC6G2 / F0UAC7G1 / F0UAC7G2 / F0UAC8G1 / F0UAC8G2 / F0UAC8GA / F0UAC9G1 / F0UAC9G2 / F0UAC9GA / F0UACAG1 / F0UACAG2 / F0UACAGA / F0UACAGB / F0UACBG1 / F0UACBG2 / F0UACBGA / F0UACBGB / F0UBC4G1 / F0UBC5G1 / F0UBC6G1 / F0UBC6G2 / F0UBC7G1 / F0UBC7G2 / F0UBC8G1 / F0UBC8G2 / F0UBC9G1 / F0UBC9G2 / F0UBC9GA / F0UBC9GB / F0UBCAG1 / F0UBCAG2 / F0UBCBG1 / F0UBCBG2 / F0UBCBGA / F0UBCBGB	
260 E 23	01.92 - 09.15	8060.45STCA, 8060.45S.6000		3400 068 031  3482 093 031  1862 310 132  3151 600 544	330 10 MFZ330 330GSB KZISZ-3		
260 E 23 T	01.91 - 09.15	8060		3400 068 031  3482 093 031  1862 310 132  3151 600 544	330 10 MFZ330 330GSB KZISZ-3	Getriebeummer / Transmission Number: 2870.9 E0DA21B1 / E0DA21BD / E0DA21E1 / E0DA21ED / E0DB21B1 / E0DB21BD / E0DB21E1 / E0MH22B1 / E0ML22B1 / E0ML22E1	(28)
280 E 23 T	01.91 - 09.15	8060		3400 068 031  3482 093 031  1862 310 132  3151 600 544	330 10 MFZ330 330GSB KZISZ-3	Getriebeummer / Transmission Number: 2870.9 E2DA21B1 / E2DA21BD / E2DA22BD / E2DA22E1 / E2DA22ED / E2DB21B1 / E2DB22E1	(28)
320 E 27 T	01.91 - 09.15	8360.46		3400 074 031  3482 078 134  1878 007 339  3151 000 144	400 10 MFZ400 380GTZ KZISZ-5	Getriebeummer / Transmission Number: 2895.9 E2FA21A1 / E2FA21AD / E2FA22A1 / E2FA22AD / E2FA22C1 / E2FA22CD / E2FB21A1 / E2FB22A1 / E2FB22C1	(28)
		8360.46E2		3400 074 031  3482 078 134  1878 007 339  3151 000 144	400 10 MFZ400 380GTZ KZISZ-5	Getriebeummer / Transmission Number: 2895.9 E2FH23A1 / E2FH23D1 / E2FL22A1 / E2FL23A1 / E2FL23D1	(28)
320 E 27, 320 E 27 P	01.92 - 09.15	8360.46.417, 8360.46.417TC A		3400 074 031  3482 078 134  1878 007 339  3151 000 144	400 10 MFZ400 380GTZ KZISZ-5		
320 E 28 T tector	09.00 - 09.15	F4AE0681		3400 074 031  3482 078 134  1878 007 339  3151 000 144	400 10 MFZ400 380GTZ KZISZ-5	E6UA2YG1 / E6UB22G1 / E6UB22GA / E6UB2YG1 / E6UB2YG2 / E6UB2YGA	

EuroFire							
60 .9 A				3151 199 001 KZIS-3			
65 .12 A				3482 008 033 MF310	310		
				1861 577 037 # 310GTD	310 10		
				3151 199 001 KZIS-3			
75 .14 A-AW 75 .16 A-AW 90 .16 A-AW				3482 038 031 GMF350	350		
				1861 742 032 350GTB	350 10		
				3151 199 001 KZIS-3			
				3400 066 031 #  3482 092 031  1878 074 841  3151 600 544	280 10 MFZ280 280GTZ KZISZ-3	->Chass. 2180116	
75 E 14	05.91 -			3482 094 031 # MFZ310	310	Chass. 2180117->	
75 E 14				1878 000 611 310TB	310 10		
				3151 600 544 KZISZ-3		Chass. 2180117->	
				3400 700 449 #  3482 094 031  1878 000 611  3151 600 544	310 10 MFZ310 310TB KZISZ-3	Nebenprofil / Hub Profile: 1 1/2"-10N	(48)
95 E 18	05.91 -			3482 002 234 GMF350X	350		
120 .19 A-AW 140 .19 A				1878 001 070 350GTZ	350 10		
				3151 000 515 KZIS-4			
							









		CODE				
--	--	------	--	---	---	---

IVECO

EuroFire						
120 .23 AW 120 .25 AW,AN 140 .25 A				1882 325 139	380 G380	
				1878 000 957	380 10 380GTZ	
				3151 000 515	KZIS-4	
130 E 24 135 E 22	05.91 - 05.91 -			3400 068 031 ⊗ 3482 093 031 ⊗ 1862 310 132 ⊙ 3151 600 544	330 10 MFZ330 330GSB KZISZ-3	
150 E 27	12.91 -			3400 074 031 ⊗ 3482 078 134 ⊗ 1878 007 339 ⊙ 3151 000 144	400 10 MFZ400 380GTZ KZISZ-5	
160 .30 AH-AHW				3482 124 516	430 GMF430	
				1878 002 955	420 10 420GTZ	
				3151 000 515	KZIS-4	

















EuroStar 01.93 - 02.02						
LD 190 E 38 P LD 240 E 38 LD 260 E 38 P LD 400 E 38 TX/P, LD 440 E 38 TX/P LD 440 E 38 T LD 440 E 38 TZ	01.93-02.02 01.93-02.02 01.93-02.02 01.93-02.02 01.93-02.02 01.93-02.02	8460		3400 077 071 ⊗ 3482 078 134 ⊗ 1862 317 032 ⊙ 3151 000 144	400 10 MFZ400 400GVZ KZISZ-5	Getr. / GBox: Fuller
				3400 084 031 ⊗ 3482 078 134 ⊗ 1878 032 032 ⊙ 3151 000 144	400 10 MFZ400 400WGTZ KZISZ-5	Getr. / GBox: ZF
LD 190 E 39 P, LD 190 E 39 FP	11.99-02.02	F3AE0681		3400 117 801 ⊗ 3482 083 032 ⊗ 1878 085 741 ⊙ 3151 000 144	430 10 MFZ430 430WGTZ KZISZ-5	L1JB15H2 / L1JB15N2 / L1JB17E2 / L1JB17H2 / L1JB17N2 / L1JB18H2 / L1JB18N2 / L1JB19F2 / L1JB19N2 / L1JC17F2 / L1JC18E2 / L1JC18F2 / L1JC18H2 / L1JC18N2 / L1JCL7N2 / L1JCL8H2 / L1JCL9H2 / L1JCL9N2 für Ausrückgabel mit Nocken / for release fork with cams (70)
				3400 700 435 ⊗ 3482 083 032 ⊗ 1878 085 741 ⊙ 3151 000 493	430 10 MFZ430 430WGTZ KZISZ-5	L1JB15H2 / L1JB15N2 / L1JB17E2 / L1JB17H2 / L1JB17N2 / L1JB18H2 / L1JB18N2 / L1JB19F2 / L1JB19N2 / L1JC17F2 / L1JC18E2 / L1JC18F2 / L1JC18H2 / L1JC18N2 / L1JCL7N2 / L1JCL8H2 / L1JCL9H2 / L1JCL9N2 für Ausrückgabel mit Rollen / for release fork with rollers (71)
		F3AE0681E		3189 600 004		Getr. / GBox: ZF AS Tronic Rollenausführung / roller version (58)
LD 190 E 40 LD 260 E 40 LD 440 E 40 T LD 440 E 40 TX/P	09.00-02.02 09.00-02.02 09.00-02.02 01.01-02.02	F3AE0681B		3400 117 801 ⊗ 3482 083 032 ⊗ 1878 085 741 ⊙ 3151 000 144	430 10 MFZ430 430WGTZ KZISZ-5	Getr. / GBox: ZF für Ausrückgabel mit Nocken / for release fork with cams (70)
				3400 700 435 ⊗ 3482 083 032 ⊗ 1878 085 741 ⊙ 3151 000 493	430 10 MFZ430 430WGTZ KZISZ-5	Getr. / GBox: ZF für Ausrückgabel mit Rollen / for release fork with rollers (71)
				3189 600 004		Getr. / GBox: ZF AS Tronic Rollenausführung / roller version (58)
LD 190 E 42, LD 190 E 42 P LD 190 E 47 LD 240 E 42 FS, LD 240 E 42 PS LD 240 E 47 PS LD 260 E 42 P LD 260 E 47 LD 400 E 42 TX/P, LD 440 E 42 TX/P LD 440 E 42 T/P LD 440 E 42 TZ LD 440 E 47 T/P LD 440 E 47 TZ	01.93-02.02 01.93-02.02 01.93-02.02 01.93-02.02 01.93-02.02 01.93-02.02 01.93-02.02 01.93-02.02 01.93-02.02 01.93-02.02 01.93-02.02 01.93-02.02	8210		3400 700 455	430 10	Getr. / GBox: Fuller Nabenprofil / Hub Profile: 41,1x50,8-10N (48)
				3400 117 801 ⊗ 3482 083 032 ⊗ 1878 085 741 ⊙ 3151 000 144	430 10 MFZ430 430WGTZ KZISZ-5	Getr. / GBox: ZF für Ausrückgabel mit Nocken / for release fork with cams (70)
				3400 700 435 ⊗ 3482 083 032 ⊗ 1878 085 741 ⊙ 3151 000 493	430 10 MFZ430 430WGTZ KZISZ-5	Getr. / GBox: ZF für Ausrückgabel mit Rollen / for release fork with rollers (71)
		8210.42M.TCA, 8210.42L(TCA), 8210.42L.400, 8210.42L.		3189 600 004		Getr. / GBox: ZF AS Tronic Rollenausführung / roller version (58)

IVECO

EuroStar		01.93 - 02.02				
LD 190 E 43, LD 190 E 43 P, LD 190 E 43 FP	11.99-02.02	F3AE0681	 3400 117 801 3482 083 032 1878 085 741 3151 000 144 3400 700 435 3482 083 032 1878 085 741 3151 000 493	430 10 MFZ430 430WGTZ KZISZ-5	L1KB15C2 / L1KB17A2 / L1KB17C2 / L1KB17D2 / L1KB18A2 / L1KB18C2 / L1KB18D2 / L1KB19C2 / L1KB19D2 / L1KC18A2 / L1KC18D2 / L1KCL7D2 / L1KCL8A2 / L1KCL8D2 / L1KCL9D2 für Ausrückgabel mit Nocken / for release fork with cams	(70)
		F3AE0681D	 3189 600 004		Getr. / GBox: ZF AS Tronic Rollenausführung / roller version	(58)
LD 190 E 52 LD 240 E 52 PS LD 260 E 52 LD 440 E 52 T LD 440 E 52 TZ	01.93-02.02	8280.42S.TCA	 3400 700 455	430 10 MFZ430 430WGTZ KZISZ-5	Getr. / GBox: Fuller Nabenprofil / Hub Profile: 41,1x50,8-10N	(48)
			 3400 117 801 3482 083 032 1878 085 741 3151 000 144	430 10 MFZ430 430WGTZ KZISZ-5	Getr. / GBox: ZF für Ausrückgabel mit Nocken / for release fork with cams	(70)
			3400 700 435 3482 083 032 1878 085 741 3151 000 493	430 10 MFZ430 430WGTZ KZISZ-5	Getr. / GBox: ZF für Ausrückgabel mit Rollen / for release fork with rollers	(71)
			 3189 600 004		Getr. / GBox: ZF AS Tronic Rollenausführung / roller version	(58)
LD 260 E 39 P, LD 260 E 39 FP	11.99-02.02	F3AE0681	 3400 117 801 3482 083 032 1878 085 741 3151 000 144 3400 700 435 3482 083 032 1878 085 741 3151 000 493	430 10 MFZ430 430WGTZ KZISZ-5	L3JB15H2 / L3JB15N2 / L3JB16E2 / L3JB16H2 / L3JB16N2 / L3JB17HD / L3JB17ND / L3JB18N2 / L3JE14E2 / L3JE14F2 / L3JE14H2 / L3JE14N2 / L3JE15E2 / L3JE15F2 / L3JE15H2 / L3JE15N2 / L3JE16F2 / L3JE17F2 / L3JE17H2 / L3JE17N2 / L3JE18N2 / L3JE19E2 / L3JE19H2 / L3JE19N2 / L3JF15F2 / L7JB15N2 für Ausrückgabel mit Nocken / for release fork with cams	(70)
		F3AE0681E	 3189 600 004		Getr. / GBox: ZF AS Tronic Rollenausführung / roller version	(58)
LD 260 E 43 Y/PS, LD 260 E 43 FP	01.93-02.02	F3AE0681	 3400 117 801 3482 083 032 1878 085 741 3151 000 144 3400 700 435 3482 083 032 1878 085 741 3151 000 493	430 10 MFZ430 430WGTZ KZISZ-5	L3KB15D2 / L3KB16A2 / L3KB16C2 / L3KB16D2 / L3KB17C2 / L3KB17D2 / L3KC15C2 / L3KC15D2 / L3KC16A2 / L3KC16C2 / L3KC16D2 / L3KCL6A2 / L3KCL6C2 / L3KCL6D2 / L3KCL7C2 / L3KCL7D2 / L3KE14C2 / L3KE14D2 / L3KE15A2 / L3KE15C2 / L3KE15D2 / L3KE16C2 / L3KE16D2 / L3KE17A2 / L3KE17C2 / L3KE17D2 / L3KE18D2 / L3KE19A2 / L3KE19D2 / L3KF15A2 / L3KF15C2 / L3KF15D2 / L3KF16A2 / L3KF16C2 / L3KF16D2 / L3KF17D2 / L3KFL6C2 / L3KFL6D2 / L3KFL7C2 / L3KFL7D2 / L7KB17D2 / L7KB18D2 für Ausrückgabel mit Nocken / for release fork with cams	(70)
		F3AE0681D	 3189 600 004		Getr. / GBox: ZF AS Tronic Rollenausführung / roller version	(58)











		CODE				
--	--	------	--	---	---	---

IVECO











EuroStar		01.93 - 02.02				
LD 260 E 48 Y/PS	01.93-02.02	F3AE0681	 3400 117 801 ⊗ 3482 083 032 ⊗ 1878 085 741 ⊙ 3151 000 144	430 10 MFZ430 430WGTZ KZISZ-5	L3PB18D1 / L3PC16D1 / L3PC16G3 / L3PE14G1 / L3PE16F1 / L3PF16C1 / L3PF16F1 / L3PF17F1 / LJPC15A1 / LJPC16A1 / LJPC16E1 / LJPE14A1 / LJPE14E1 / LJPE15A1 / LJPE15E1 / LJPE16A1 / LJPE16E1 / LJPE17A1 / LJPE17E1 / LJPE18F1 / LJPF15E1 / LJPF16A1 / LJPF16E1 / LJPF17E1 für Ausrückgabel mit Nocken / for release fork with cams	(70)
			 3400 117 801 ⊗ 3482 083 032 ⊗ 1878 085 741 ⊙ 3151 000 144	430 10 MFZ430 430WGTZ KZISZ-5	L1PB2112 / L1PB2142 / L1PB21G2 / L1PB21J2 / L1PB21L2 / L1PB21W2 / L1PB23G2 / L1PB23GD / L1PB23J2 / L1PB23L2 / L1PB23W2 / L1PBH3G2 für Ausrückgabel mit Nocken / for release fork with cams	(70)
			 3400 700 435 ⊗ 3482 083 032 ⊗ 1878 085 741 ⊙ 3151 000 493	430 10 MFZ430 430WGTZ KZISZ-5	L3PB18D1 / L3PC16D1 / L3PC16G3 / L3PE14G1 / L3PE16F1 / L3PF16C1 / L3PF16F1 / L3PF17F1 / LJPC15A1 / LJPC16A1 / LJPC16E1 / LJPE14A1 / LJPE14E1 / LJPE15A1 / LJPE15E1 / LJPE16A1 / LJPE16E1 / LJPE17A1 / LJPE17E1 / LJPE18F1 / LJPF15E1 / LJPF16A1 / LJPF16E1 / LJPF17E1 für Ausrückgabel mit Rollen / for release fork with rollers	(71)
			 3400 700 435 ⊗ 3482 083 032 ⊗ 1878 085 741 ⊙ 3151 000 493	430 10 MFZ430 430WGTZ KZISZ-5	L1PB2112 / L1PB2142 / L1PB21G2 / L1PB21J2 / L1PB21L2 / L1PB21W2 / L1PB23G2 / L1PB23GD / L1PB23J2 / L1PB23L2 / L1PB23W2 / L1PBH3G2 für Ausrückgabel mit Rollen / for release fork with rollers	(71)
		F3BE0681E	 3189 600 004		Getr. / GBox: ZF AS Tronic Rollenausführung / roller version	(58)
LD 440 E 39 T, LD 440 E 39 T/P	11.99-02.02	F3AE0681	 3400 117 801 ⊗ 3482 083 032 ⊗ 1878 085 741 ⊙ 3151 000 144	430 10 MFZ430 430WGTZ KZISZ-5	L1JB21C2 / L1JB21F2 / L1JB23C2 / L1JB23F2 / L1JB23FD / L2JB21FD für Ausrückgabel mit Nocken / for release fork with cams	(70)
			 3400 700 435 ⊗ 3482 083 032 ⊗ 1878 085 741 ⊙ 3151 000 493	430 10 MFZ430 430WGTZ KZISZ-5	L1JB21C2 / L1JB21F2 / L1JB23C2 / L1JB23F2 / L1JB23FD / L2JB21FD für Ausrückgabel mit Rollen / for release fork with rollers	(71)
			F3AE0681E	 3189 600 004		Getr. / GBox: ZF AS Tronic Rollenausführung / roller version
LD 440 E 43 T/P	01.93-02.02	F3AE0681	 3400 117 801 ⊗ 3482 083 032 ⊗ 1878 085 741 ⊙ 3151 000 144	430 10 MFZ430 430WGTZ KZISZ-5	L1KB21C2 / L1KB23C2 / L1KCT1C2 für Ausrückgabel mit Nocken / for release fork with cams	(70)
			 3400 700 435 ⊗ 3482 083 032 ⊗ 1878 085 741 ⊙ 3151 000 493	430 10 MFZ430 430WGTZ KZISZ-5	L1KB21C2 / L1KB23C2 / L1KCT1C2 für Ausrückgabel mit Rollen / for release fork with rollers	(71)
			F3AE0681D	 3189 600 004		Getr. / GBox: ZF AS Tronic Rollenausführung / roller version
LD 440 E 43 TX/P	11.99-02.02	F3AE0681	 3400 117 801 ⊗ 3482 083 032 ⊗ 1878 085 741 ⊙ 3151 000 144	430 10 MFZ430 430WGTZ KZISZ-5	L1KB21C2 / L1KB21DD / L1KB21J2 / L1KB21L2 / L1KB23C2 / L1KB23CD / L1KB23J2 / L1KB23L2 / L1KB23LD / L1KBH3C2 / L1KBH3L2 / L1KCT1C2 / L1KCT1CD / L1KCT1J2 / L1KCT1L2 / L1KCT1LD / L2KB21C2 / L2KB21CD / L2KB21L2 / L2KB21LD für Ausrückgabel mit Nocken / for release fork with cams	(70)
			 3400 700 435 ⊗ 3482 083 032 ⊗ 1878 085 741 ⊙ 3151 000 493	430 10 MFZ430 430WGTZ KZISZ-5	L1KB21C2 / L1KB21DD / L1KB21J2 / L1KB21L2 / L1KB23C2 / L1KB23CD / L1KB23J2 / L1KB23L2 / L1KB23LD / L1KBH3C2 / L1KBH3L2 / L1KCT1C2 / L1KCT1CD / L1KCT1J2 / L1KCT1L2 / L1KCT1LD / L2KB21C2 / L2KB21CD / L2KB21L2 / L2KB21LD für Ausrückgabel mit Rollen / for release fork with rollers	(71)
			F3AE0681D	 3189 600 004		Getr. / GBox: ZF AS Tronic Rollenausführung / roller version
LD 440 E 48 T/P	01.01-02.02	F3AE0681	 3400 117 801 ⊗ 3482 083 032 ⊗ 1878 085 741 ⊙ 3151 000 144	430 10 MFZ430 430WGTZ KZISZ-5	L1PB2112 / L1PB2142 / L1PB21G2 / L1PB21J2 / L1PB21L2 / L1PB21W2 / L1PB23G2 / L1PB23GD / L1PB23J2 / L1PB23L2 / L1PB23W2 / L1PBH3G2 für Ausrückgabel mit Nocken / for release fork with cams	(70)
			 3400 700 435 ⊗ 3482 083 032 ⊗ 1878 085 741 ⊙ 3151 000 493	430 10 MFZ430 430WGTZ KZISZ-5	L1PB2112 / L1PB2142 / L1PB21G2 / L1PB21J2 / L1PB21L2 / L1PB21W2 / L1PB23G2 / L1PB23GD / L1PB23J2 / L1PB23L2 / L1PB23W2 / L1PBH3G2 für Ausrückgabel mit Rollen / for release fork with rollers	(71)
			F3BE0681E	 3189 600 004		Getr. / GBox: ZF AS Tronic Rollenausführung / roller version

















		CODE				
--	--	------	--	---	---	---

IVECO

EuroTech MH		01.98 -					
190 E 24 K 190 E 27 K 190 E 31 K 260 E 27 Y/P, 260 E 27 Y/PS, 260 E 27 RY/PS, 260 E 27 RY/PT	09.98- 09.98- 09.98- 11.99-	F2BE0681F, F2BE0681D, F2BE0681B, F2BE0681C		3400 107 031 ⊗ 3482 078 134 ⊗ 1862 317 031 ⊙ 3151 000 144	400 10 MFZ400 400GVZ KZISZ-5	Getr. / GBox: AS Tronic	
190 E 24, 190 E 24 /P	09.98-	F2BE0681		3400 107 031 ⊗ 3482 078 134 ⊗ 1862 317 031 ⊙ 3151 000 144	400 10 MFZ400 400GVZ KZISZ-5	Getriebenummer / Transmission Number: 2895.9 M1NA13A1 / M1NA14A1 / M1NA15A1 / M1NA16A1 / M1NA17A1 / M1NA18A1 / M1NA19A1 / M1NB15A1 / M1NB15A2 / M1NB17A1 / M1NB18A1 / M1NB18A2 / M1NB19A1 / M1NB19A2 / M1NB19AC	(28)
				3400 074 031 ⊗ 3482 078 134 ⊗ 1878 007 339 ⊙ 3151 000 144	400 10 MFZ400 380GTZ KZISZ-5	Getriebenummer / Transmission Number: 2895.9 M1NB19A1	(28)
190 E 27, 190 E 27 /P	09.98-	F2BE0681F, F2BE0681C		3400 074 031 ⊗ 3482 078 134 ⊗ 1878 007 339 ⊙ 3151 000 144	400 10 MFZ400 380GTZ KZISZ-5		
190 E 31, 190 E 31 /P	09.98-	F2BE0681		3400 107 031 ⊗ 3482 078 134 ⊗ 1862 317 031 ⊙ 3151 000 144	400 10 MFZ400 400GVZ KZISZ-5	Getr. / GBox: 16S 109 M1PA13B1 / M1PA14B1 / M1PA15B1 / M1PA16B1 / M1PB16B1 / M1PB17B1 / M1PB17B2 / M1PB18B1 / M1PB18B2 / M1PB19B1 / M1PB19B2	
				3400 084 031 ⊗ 3482 078 134 ⊗ 1878 032 032 ⊙ 3151 000 144	400 10 MFZ400 400WGTZ KZISZ-5	Getr. / GBox: AS-tronic M1PA15B1 / M1PB16B1 / M1PB17B1 / M1PB17B2 / M1PB18B1 / M1PB18B2 / M1PB19B2	
190 E 35, 190 E 35 /P, 190 E 35 /FP	09.98-	F2BE0681		3400 084 031 ⊗ 3482 078 134 ⊗ 1878 032 032 ⊙ 3151 000 144	400 10 MFZ400 400WGTZ KZISZ-5	Getr. / GBox: 16S 151 M1RA13B1 / M1RB17B2 / M1RB18B1 / M1RB18B2 / M1RB19B2	
260 E 24 Y/P, 260 E 24 Y/PS, 260 E 24 Y/PT	11.99-	F2BE0681		3400 107 031 ⊗ 3482 078 134 ⊗ 1862 317 031 ⊙ 3151 000 144	400 10 MFZ400 400GVZ KZISZ-5	Getriebenummer / Transmission Number: 2895.9 M3NE13A1 / M7NA15A1	(28)
260 E 31 Y/P, 260 E 31 Y/PS, 260 E 31 Y/PT	11.99-	F2BE0681		3400 107 031 ⊗ 3482 078 134 ⊗ 1862 317 031 ⊙ 3151 000 144	400 10 MFZ400 400GVZ KZISZ-5	Getr. / GBox: 16S 109 M3PB15B1 / M3PE13B1 / M3PE14B1 / M3PE14B2 / M3PE15B1 / M3PE15B2 / M3PE16B1 / M3PE16B2 / M3PE17B1 / M3PE17B2 / M7PA15B1 / M7PA15B2 / M7PA18B2 / M7PB15B1 / M7PB16B1	
				3400 084 031 ⊗ 3482 078 134 ⊗ 1878 032 032 ⊙ 3151 000 144	400 10 MFZ400 400WGTZ KZISZ-5	Getr. / GBox: AS-tronic M3PE13B1 / M3PE14B1 / M3PE15B1 / M3PE17B1	
260 E 35 Y/P, 260 E 35 Y/PT, 260 E 35 Y/TN	11.99-	F2BE0681		3400 084 031 ⊗ 3482 078 134 ⊗ 1878 032 032 ⊙ 3151 000 144	400 10 MFZ400 400WGTZ KZISZ-5	Getr. / GBox: 16S 151 M3RE14B1 / M3RE14B2 / M3RE15B1 / M3RE15B2 / M3RE16B2 / M3RE17B2 / M7RB15B2 / M7RB17B1 / M7RB17B2	
400 E 31 TP, 440 E 31 T, 440 E 31 TP	09.98-	F2BE0681		3400 107 031 ⊗ 3482 078 134 ⊗ 1862 317 031 ⊙ 3151 000 144	400 10 MFZ400 400GVZ KZISZ-5	Getr. / GBox: 16S 109 M1PB21B1 / M1PB21B2 / M1PB21BC / M1PB23B2	
				3400 084 031 ⊗ 3482 078 134 ⊗ 1878 032 032 ⊙ 3151 000 144	400 10 MFZ400 400WGTZ KZISZ-5	Getr. / GBox: AS-tronic M1PB21B1	
400 E 35 TP, 440 E 35 T, 440 E 35 T/P, 440 E 35 T/FP	09.98-	F2BE0681		3400 084 031 ⊗ 3482 078 134 ⊗ 1878 032 032 ⊙ 3151 000 144	400 10 MFZ400 400WGTZ KZISZ-5	Getr. / GBox: 16S 151 M1RA21B1 / M1RA21B2 / M1RB21B1 / M1RB21B2 / M1RB23B2 / M1RB23BD	
				3400 084 031 ⊗ 3482 078 134 ⊗ 1878 032 032 ⊙ 3151 000 144	400 10 MFZ400 400WGTZ KZISZ-5	Getr. / GBox: 12AS 1800 DD M1RB21C2	

IVECO

















EuroTech MP		01.92 -						
180 E 34	01.92-12.93	8460		3400 084 031 ⊗ 3482 078 134 ⊗ 1878 032 032 ⬢ 3151 000 144	400 10 MFZ400 400WGTZ KZISZ-5	Getr. / GBox: ZF		
180 E 38	01.92-12.93							
190 E 34	01.93-							
190 E 38	01.93-							
240 E 34	09.95-12.96				3400 077 071 ⊗ 3482 078 134 ⊗ 1862 317 032 ⬢ 3151 000 144	400 10 MFZ400 400GVZ KZISZ-5	Getr. / GBox: Fuller	
240 E 38	01.92-							
260 E 38 P	01.94-							
400 E 34 T, 440 E 34 T	01.92-							
400 E 38 T, 440 E 38 T, 440 E 38 T / P	01.92-							
400 E 38 TXP	11.93-12.96							
440 E 38 TZ	01.93-							
180 E 42	01.92-12.93	8210		3400 700 455 ■	430 10	Getr. / GBox: Fuller Nabenprofil / Hub Profile: 41,1x50,8-10N	(48)	
190 E 42, 190 E 42 / P	01.93-				3400 117 801 ⊗ 3482 083 032 ⊗ 1878 085 741 ⬢ 3151 000 144	430 10 MFZ430 430WGTZ KZISZ-5	Getr. / GBox: ZF für Ausrückgabel mit Nocken / for release fork with cams	(70)
240 E 42	01.92-							
260 E 42	01.94-							
400 E 42 T, 440 E 42 T, 440 E 42 T / P	01.92-							
440 E 42 TZ	01.93-			3400 700 435 ⊗ 3482 083 032 ⊗ 1878 085 741 ⬢ 3151 000 493	430 10 MFZ430 430WGTZ KZISZ-5	Getr. / GBox: ZF für Ausrückgabel mit Rollen / for release fork with rollers	(71)	
		8210.42L(TCA), 8210.42L.400		3189 600 004		Getr. / GBox: ZF AS Tronic Rollenausführung / roller version	(58)	
190 E 39, 190 E 39 / P, 190 E39 / FP	11.99-	F3AE0681		3400 117 801 ⊗ 3482 083 032 ⊗ 1878 085 741 ⬢ 3151 000 144	430 10 MFZ430 430WGTZ KZISZ-5	M1JB15C1 / M1JB15D1 / M1JB15E1 / M1JB15F2 / M1JB15H1 / M1JB15H2 / M1JB15N1 / M1JB17C2 / M1JB17D1 / M1JB17E1 / M1JB17F1 / M1JB17F2 / M1JB17H1 / M1JB17H2 / M1JB17N1 / M1JB17N2 / M1JB18A1 / M1JB18C2 / M1JB18F2 / M1JB18H2 / M1JB18N2 / M1JB19C2 / M1JB19H2 / M1JB19N2 / M1JCL8C2 / M1JCL8D2 / M1JCL8F2 / M1JCL8FD / M1JCL9D2 / M1JCLLC2 / M1JCLLF2 / M1JCN8A2 / M1JCN8D2 / M1JCN8E2 / M1JCN8H2 / M1JCN8HD / M1JCN8N2 / M1JCN8ND / M1JCNLA2 / M1JCNLD2 / M1JCNLE2 / M1JCNLH2 / M1JCNLN2 / M1JCNLND für Ausrückgabel mit Nocken / for release fork with cams	(70)	
					3400 700 435 ⊗ 3482 083 032 ⊗ 1878 085 741 ⬢ 3151 000 493	430 10 MFZ430 430WGTZ KZISZ-5	M1JB15C1 / M1JB15D1 / M1JB15E1 / M1JB15F2 / M1JB15H1 / M1JB15H2 / M1JB15N1 / M1JB17C2 / M1JB17D1 / M1JB17E1 / M1JB17F1 / M1JB17F2 / M1JB17H1 / M1JB17H2 / M1JB17N1 / M1JB17N2 / M1JB18A1 / M1JB18C2 / M1JB18F2 / M1JB18H2 / M1JB18N2 / M1JB19C2 / M1JB19H2 / M1JB19N2 / M1JCL8C2 / M1JCL8D2 / M1JCL8F2 / M1JCL8FD / M1JCL9D2 / M1JCLLC2 / M1JCLLF2 / M1JCN8A2 / M1JCN8D2 / M1JCN8E2 / M1JCN8H2 / M1JCN8HD / M1JCN8N2 / M1JCN8ND / M1JCNLA2 / M1JCNLD2 / M1JCNLE2 / M1JCNLH2 / M1JCNLN2 / M1JCNLND für Ausrückgabel mit Rollen / for release fork with rollers	(71)
			F3AE0681E		3189 600 004		Getr. / GBox: ZF AS Tronic Rollenausführung / roller version	(58)
190 E 43, 190 E 43 / P	01.01-	F3AE0681		3400 117 801 ⊗ 3482 083 032 ⊗ 1878 085 741 ⬢ 3151 000 144	430 10 MFZ430 430WGTZ KZISZ-5	M1KA14D1 / M1KA17D2 / M1KB15A1 / M1KB15D1 / M1KB15D2 / M1KB17A1 / M1KB17A2 / M1KB17D1 / M1KB17D2 / M1KB18A1 / M1KB18A2 / M1KB18D1 / M1KB18D2 / M1KB19D2 / M1KC17D1 / M1KC18D1 / M1KC18D2 / M1KCL8D2 / M1KCN8D2 / M1KCNLA2 / M1KCNLD2 für Ausrückgabel mit Nocken / for release fork with cams	(70)	
					3400 700 435 ⊗ 3482 083 032 ⊗ 1878 085 741 ⬢ 3151 000 493	430 10 MFZ430 430WGTZ KZISZ-5	M1KA14D1 / M1KA17D2 / M1KB15A1 / M1KB15D1 / M1KB15D2 / M1KB17A1 / M1KB17A2 / M1KB17D1 / M1KB17D2 / M1KB18A1 / M1KB18A2 / M1KB18D1 / M1KB18D2 / M1KB19D2 / M1KC17D1 / M1KC18D1 / M1KC18D2 / M1KCL8D2 / M1KCN8D2 / M1KCNLA2 / M1KCNLD2 für Ausrückgabel mit Rollen / for release fork with rollers	(71)
			F3AE0681D		3189 600 004		Getr. / GBox: ZF AS Tronic Rollenausführung / roller version	(58)
240 E 30 PS	01.97-	8460		3400 084 031 ⊗ 3482 078 134 ⊗ 1878 032 032 ⬢ 3151 000 144	400 10 MFZ400 400WGTZ KZISZ-5			

EuroTech MP		01.92 -				
260 E 39 Y, 260 E 39 Y/P, 260 E 39 Y/FP, 260 E 39 Y/FS	11.99-	F3AE0681	 3400 117 801  3482 083 032  1878 085 741  3151 000 144	430 10 MFZ430 430WGTZ KZISZ-5	M3JB14E2 / M3JB14N1 / M3JB15H1 / M3JB15H2 / M3JB16A1 / M3JB16D1 / M3JB16D2 / M3JB16E2 / M3JB16N2 / M3JB17C2 / M3JB17F2 / M3JC14H1 / M3JC15F1 / M3JC15F2 / M3JC15H1 / M3JC16F2 / M3JC16N2 / M3JC17N2 / M3JE14A1 / M3JE14C1 / M3JE14C2 / M3JE14E1 / M3JE14E2 / M3JE14F1 / M3JE14F2 / M3JE14H1 / M3JE14H2 / M3JE14N1 / M3JE14N2 / M3JE15C1 / M3JE15C2 / M3JE15D2 / M3JE15F1 / M3JE15F2 / M3JE15H1 / M3JE15H2 / M3JE15N1 / M3JE15N2 / M3JE16A1 / M3JE16C1 / M3JE16C2 / M3JE16E2 / M3JE16F1 / M3JE16F2 / M3JE16H1 M3JE16H2 / M3JE16N1 / M3JE16N2 / M3JE17C2 / M3JE17F2 / M3JE17H2 / M3JE18D2 / M3JE18N2 / M3JE19D2 / M3JE19H2 / M3JE19N2 / M3JF14A1 / M3JF14E1 / M3JF15E1 / M3JF15H1 / M3JF15H2 / M3JF15N1 / M3JF15N2 / M3JF16D2 / M3JF16E2 / M3JF16F2 / M3JF16H2 / M3JF16N2 / M3JF17E2 / M3JF17H2 / M3JFL6N1 / M7JB15N2 für Ausrückgabel mit Nocken / for release fork with cams	(70)
			3400 700 435  3482 083 032  1878 085 741  3151 000 493	430 10 MFZ430 430WGTZ KZISZ-5	M3JB14E2 / M3JB14N1 / M3JB15H1 / M3JB15H2 / M3JB16A1 / M3JB16D1 / M3JB16D2 / M3JB16E2 / M3JB16N2 / M3JB17C2 / M3JB17F2 / M3JC14H1 / M3JC15F1 / M3JC15F2 / M3JC15H1 / M3JC16F2 / M3JC16N2 / M3JC17N2 / M3JE14A1 / M3JE14C1 / M3JE14C2 / M3JE14E1 / M3JE14E2 / M3JE14F1 / M3JE14F2 / M3JE14H1 / M3JE14H2 / M3JE14N1 / M3JE14N2 / M3JE15C1 / M3JE15C2 / M3JE15D2 / M3JE15F1 / M3JE15F2 / M3JE15H1 / M3JE15H2 / M3JE15N1 / M3JE15N2 / M3JE16A1 / M3JE16C1 / M3JE16C2 / M3JE16E2 / M3JE16F1 / M3JE16F2 / M3JE16H1 M3JE16H2 / M3JE16N1 / M3JE16N2 / M3JE17C2 / M3JE17F2 / M3JE17H2 / M3JE18D2 / M3JE18N2 / M3JE19D2 / M3JE19H2 / M3JE19N2 / M3JF14A1 / M3JF14E1 / M3JF15E1 / M3JF15H1 / M3JF15H2 / M3JF15N1 / M3JF15N2 / M3JF16D2 / M3JF16E2 / M3JF16F2 / M3JF16H2 / M3JF16N2 / M3JF17E2 / M3JF17H2 / M3JFL6N1 / M7JB15N2 für Ausrückgabel mit Rollen / for release fork with rollers	(71)
		F3AE0681E	 3189 600 004		Getr. / GBox: ZF AS Tronic Rollenausführung / roller version	(58)
260 E 43 Y, 260 E 43 Y/P	11.99-	F3AE0681	 3400 117 801  3482 083 032  1878 085 741  3151 000 144	430 10 MFZ430 430WGTZ KZISZ-5	M7KB15D1 / M7KB16D1 / M7KB16D2 / M7KB17D1 / M7KB17D2 / M7KB17DD / M7KB18D2 / M3KB14D1 / M3KB15D1 / M3KB15D2 / M3KB16D1 / M3KB16D2 / M3KB17D2 / M3KB18D2 / M3KC15D2 / M3KC16D2 / M3KC17D2 / M3KCL6D1 / M3KE14A1 / M3KE14C1 / M3KE14C2 / M3KE14D1 / M3KE14D2 / M3KE15A1 / M3KE15A2 / M3KE15C1 / M3KE15C2 / M3KE15D1 / M3KE15D2 / M3KE16A2 / M3KE16C1 / M3KE16C2 / M3KE16D1 / M3KE16D2 / M3KE17C2 / M3KE17D2 / M3KE18D2 / M3KE19D2 / M3KF14A1 / M3KF14D1 / M3KF15D1 / M3KF15D2 / M3KF16D2 / M3KF17D2 / M3KFL6D2 M3KFL7D1 / M3KFL7D2 / M3KFL8D1 / M7KA15D1 / M7KA15D2 / M7KA16D1 für Ausrückgabel mit Nocken / for release fork with cams	(70)
			3400 700 435  3482 083 032  1878 085 741  3151 000 493	430 10 MFZ430 430WGTZ KZISZ-5	M7KB15D1 / M7KB16D1 / M7KB16D2 / M7KB17D1 / M7KB17D2 / M7KB17DD / M7KB18D2 / M3KB14D1 / M3KB15D1 / M3KB15D2 / M3KB16D1 / M3KB16D2 / M3KB17D2 / M3KB18D2 / M3KC15D2 / M3KC16D2 / M3KC17D2 / M3KCL6D1 / M3KE14A1 / M3KE14C1 / M3KE14C2 / M3KE14D1 / M3KE14D2 / M3KE15A1 / M3KE15A2 / M3KE15C1 / M3KE15C2 / M3KE15D1 / M3KE15D2 / M3KE16A2 / M3KE16C1 / M3KE16C2 / M3KE16D1 / M3KE16D2 / M3KE17C2 / M3KE17D2 / M3KE18D2 / M3KE19D2 / M3KF14A1 / M3KF14D1 / M3KF15D1 / M3KF15D2 / M3KF16D2 / M3KF17D2 / M3KFL6D2 M3KFL7D1 / M3KFL7D2 / M3KFL8D1 / M7KA15D1 / M7KA15D2 / M7KA16D1 für Ausrückgabel mit Rollen / for release fork with rollers	(71)
		F3AE0681D	 3189 600 004		Getr. / GBox: ZF AS Tronic Rollenausführung / roller version	(58)













		CODE				
--	--	------	--	---	---	---

IVECO

EuroTech MP 01.92 -



440 E 39 T, 440 E 39 T/P, 440 E 39 T/FP-CT 440 E 39 TX/P	11.99-	F3AE0681		3400 117 801  3482 083 032  1878 085 741  3151 000 144	430 10 MFZ430 430WGTZ KZISZ-5	M1JB21C1 / M1JB21C2 / M1JB21F1 / M1JB21F2 / M1JB21G1 / M1JB21G2 / M1JB21M1 / M1JB21N2 / M1JB21P1 / M1JB21P2 / M1JB21PC / M1JB23C1 / M1JB23C2 / M1JB23CD / M1JB23F1 / M1JB23F2 / M1JB23FD / M1JB23G1 / M1JB23G2 / M1JB23GD / M1JB23HD / M1JB23M1 / M1JB23M2 / M1JB23P1 / M1JB23P2 / M1JB23PD / M1JBH1DD / M1JBH3H2 / M1JBH3HD / M1JCM3A2 / M1JCM3D2 / M1JCM3E2 / M1JCM3H2 / M1JCM3HD / M1JCM3N2 / M1JCM3ND / M1JCT3C2 / M1JCT3F2 / M1JCT3FD / M1JD23D2 / M1JE2112 / M2JB21FD / M2JB21G1 / M2JB21G2 / M2JB21GD M2JB21L2 / M2JB21P2 / M2JB21PD für Ausrückgabel mit Nocken / for release fork with cams	(70)
	11.99-			3400 700 435  3482 083 032  1878 085 741  3151 000 493	430 10 MFZ430 430WGTZ KZISZ-5	M1JB21C1 / M1JB21C2 / M1JB21F1 / M1JB21F2 / M1JB21G1 / M1JB21G2 / M1JB21M1 / M1JB21N2 / M1JB21P1 / M1JB21P2 / M1JB21PC / M1JB23C1 / M1JB23C2 / M1JB23CD / M1JB23F1 / M1JB23F2 / M1JB23FD / M1JB23G1 / M1JB23G2 / M1JB23GD / M1JB23HD / M1JB23M1 / M1JB23M2 / M1JB23P1 / M1JB23P2 / M1JB23PD / M1JBH1DD / M1JBH3H2 / M1JBH3HD / M1JCM3A2 / M1JCM3D2 / M1JCM3E2 / M1JCM3H2 / M1JCM3HD / M1JCM3N2 / M1JCM3ND / M1JCT3C2 / M1JCT3F2 / M1JCT3FD / M1JD23D2 / M1JE2112 / M2JB21FD / M2JB21G1 / M2JB21G2 / M2JB21GD M2JB21L2 / M2JB21P2 / M2JB21PD für Ausrückgabel mit Rollen / for release fork with rollers	(71)
		F3AE0681E		3189 600 004		Getr. / GBox: ZF AS Tronic Rollenausführung / roller version	(58)
440 E 43 T, 440 E 43 T/P	11.99-	F3AE0681		3400 117 801  3482 083 032  1878 085 741  3151 000 144	430 10 MFZ430 430WGTZ KZISZ-5	M1KA21D2 / M1KAH1DD / M1KB21C2 / M1KB21D1 / M1KB21J2 / M1KB21L1 / M1KB21L2 / M1KB21LC / M1KB23C2 / M1KB23CD / M1KB23J2 / M1KB23L1 / M1KB23L2 / M1KB23LD / M1KBH1A2 / M1KBH1C2 / M1KBH3D2 / M1KBH3DD / M1KBH3L2 / M1KCM3A2 / M1KCM3D2 / M1KCT1L2 / M1KD21D1 / M1KD21D2 / M1KE2121 / M1KE2122 / M1KE2322 / M2KB21CD / M2KB21L2 / M2KB21LD für Ausrückgabel mit Nocken / for release fork with cams	(70)
				3400 700 435  3482 083 032  1878 085 741  3151 000 493	430 10 MFZ430 430WGTZ KZISZ-5	M1KA21D2 / M1KAH1DD / M1KB21C2 / M1KB21D1 / M1KB21J2 / M1KB21L1 / M1KB21L2 / M1KB21LC / M1KB23C2 / M1KB23CD / M1KB23J2 / M1KB23L1 / M1KB23L2 / M1KB23LD / M1KBH1A2 / M1KBH1C2 / M1KBH3D2 / M1KBH3DD / M1KBH3L2 / M1KCM3A2 / M1KCM3D2 / M1KCT1L2 / M1KD21D1 / M1KD21D2 / M1KE2121 / M1KE2122 / M1KE2322 / M2KB21CD / M2KB21L2 / M2KB21LD für Ausrückgabel mit Rollen / for release fork with rollers	(71)
		F3AE0681D		3189 600 004		Getr. / GBox: ZF AS Tronic Rollenausführung / roller version	(58)







EuroTech MT 01.92 - 08.98

180 E 24	01.92 - 12.96	8360		3400 074 031  3482 078 134  1878 007 339  3151 000 144	400 10 MFZ400 380GTZ KZISZ-5		
180 E 24 K	01.93 - 12.96						
180 E 27	01.92 - 12.96						
180 E 27 K	01.92 - 12.96						
190 E 24	01.97 - 08.98						
190 E 24 K	01.97 - 08.98						
190 E 27	01.97 - 08.98						
190 E 27 K	01.97 - 08.98						
180 E 30 R	01.92 - 12.96	8460		3400 107 031  3482 078 134  1862 317 031  3151 000 144	400 10 MFZ400 400GVZ KZISZ-5	Getr. / GBox: ZF	
190 E 30	01.97 - 08.98						
190 E 30 K	01.97 - 08.98						
400 E 30 T	01.92 - 08.98						
				3400 077 071  3482 078 134  1862 317 032  3151 000 144	400 10 MFZ400 400GVZ KZISZ-5	Getr. / GBox: Fuller	









		CODE				
--	--	------	--	---	---	---

IVECO

EuroTech MT		01.92 - 08.98				
180 E 34 R	01.92-12.93	8460		3400 084 031 3482 078 134 1878 032 032 3151 000 144	400 10 MFZ400 400WGTZ KZISZ-5	Getr. / GBox: ZF
400 E 34 T	01.92-08.98			3400 077 071 3482 078 134 1862 317 032 3151 000 144	400 10 MFZ400 400GVZ KZISZ-5	Getr. / GBox: Fuller







EuroTrakker		01.93 - 11.04				
MP 190 E 30 W	01.93-11.04	8460		3400 107 031 3482 078 134 1862 317 031 3151 000 144	400 10 MFZ400 400GVZ KZISZ-5	
MP 190 E 30 H	01.93-11.04					
MP 260 E 30 H	01.93-11.04					
MP 190 E 31 W Cursor	09.99-11.04	F2BE0681		3400 084 031 3482 078 134 1878 032 032 3151 000 144	400 10 MFZ400 400WGTZ KZISZ-5	Getr. / GBox: 12AS 1800 DD K0PB12C1 / K0PB13C1 / K0PB14C1
MP 190 E 31 H Cursor	09.99-11.04					
				3400 107 031 3482 078 134 1862 317 031 3151 000 144	400 10 MFZ400 400GVZ KZISZ-5	Getr. / GBox: 16S 109 K0PA14A2 / K0PA15A2 / K0PA17A2 / K0PB12A3 / K0PB12A5 / K0PB12B1 / K0PB13A3 / K0PB13A5 / K0PB13B1 / K0PB14A3 / K0PB14B1 / KOPE12A3 / K0PA12A2 / K0PA13A2 / K0PA13A3
				3400 107 031 3482 078 134 1862 317 031 3151 000 144	400 10 MFZ400 400GVZ KZISZ-5	Getr. / GBox: 9S 109 K0PA14A1 / K0PA14D1 / K0PA15A1 / K0PB12A1 / K0PB12G3 / K0PB14A1 / K0PA12A1 / K0PA13A1
		F2BE0681B		3400 700 313 3482 083 113 1878 054 951 3151 000 144	430 10 MFZ430 430GTZ KZISZ-5	K0DA12A5 / K0DA12E5 / K0DA13A5 / K0DA13C5 / K0DA13D5 / K0DA14A5 / K0DA14AE / K0DA14E5 / K0DA15A5 / K0DA15D5 / K0DA15E5 / K0DA16A5 / K0DB12AE / K0DB13A5 / K0DB13D5 / K0DB14A5
MP 190 E 31 W Cursor	09.99-11.04	F2BE0681		3400 084 031 3482 078 134 1878 032 032 3151 000 144	400 10 MFZ400 400WGTZ KZISZ-5	Getr. / GBox: 12AS 1800 DD K0PB12C1 / K0PB13C1 / K0PB14C1
				3400 107 031 3482 078 134 1862 317 031 3151 000 144	400 10 MFZ400 400GVZ KZISZ-5	Getr. / GBox: 9S 109 K0PA12A1 / K0PA13A1 / K0PA14A1 / K0PA14D1 / K0PA15A1 / K0PB12A1 / K0PB12G3 / K0PB14A1
				3400 107 031 3482 078 134 1862 317 031 3151 000 144	400 10 MFZ400 400GVZ KZISZ-5	Getr. / GBox: 16S 109 K0PA12A2 / K0PA13A2 / K0PA13A3 / K0PA14A2 / K0PA15A2 / K0PA17A2 / K0PB12A3 / K0PB12A5 / K0PB12B1 / K0PB13A3 / K0PB13A5 / K0PB13B1 / K0PB14A3 / K0PB14B1 / KOPE12A3
MP 190 E 34 H	01.93-11.04	8460		3400 077 071 3482 078 134 1862 317 032 3151 000 144	400 10 MFZ400 400GVZ KZISZ-5	Getr. / GBox: Fuller
MP 190 E 34 W	01.93-11.04					
MP 260 E 34 H	01.93-11.04					
MP 260 E 34 W	01.93-11.04					
MP 340 E 34 H	01.93-11.04					
MP 380 E 34 H	01.93-11.04					
MP 400 E 34 HT	01.93-11.04					
MP 440 E 34 HT	01.93-11.04					
MP 190 E 35 H Cursor	09.99-11.04	F2BE0681		3400 084 031 3482 078 134 1878 032 032 3151 000 144	400 10 MFZ400 400WGTZ KZISZ-5	Getr. / GBox: 12AS 2301 DD K0RB13K3 / K0RE12K3
MP 190 E 35 W Cursor	09.99-11.04			3400 084 031 3482 078 134 1878 032 032 3151 000 144	400 10 MFZ400 400WGTZ KZISZ-5	Getr. / GBox: 16S 151+INT K0RB14B3
				3400 084 031 3482 078 134 1878 032 032 3151 000 144	400 10 MFZ400 400WGTZ KZISZ-5	Getr. / GBox: 16S 151 K0RA12A1 / K0RA12A2 / K0RA13A1 / K0RA13A2 / K0RA13D1 / K0RA13H1 / K0RA14A1 / K0RA14A2 / K0RA14A4 / K0RA15A1 / K0RA15A2 / K0RB12A3 / K0RB13A1 / K0RB13A3 / K0RB13D1 / K0RB14A1 / K0RB14A3 / K0RB14D1
MP 190 E 37 H	01.93-11.04	8210.42K.		3400 700 455 ■	430 10	Nabenprofil / Hub Profile: 41,1x50,8-10N (48)
MP 190 E 37 W	01.93-11.04					

IVECO

















EuroTrakker		01.93 - 11.04	
MP 190 E 38 W Cursor	01.01 - 11.04	F3AE0681	 3400 117 801 ● 3482 083 032 ● 1878 085 741 ● 3151 000 144 430 10 MFZ430 430WGTZ KZISZ-5 K0LB12H3 / K0LB12H5 / K0LB13C3 / K0LB14C3 / K0LB14H3 / K0LA12C2 / K0LA13C2 / K0LA13C4 / K0LA14C2 / K0LA15C2 / K0LB12C3 für Ausrückgabel mit Nocken / for release fork with cams (70)
			3400 700 435 ● 3482 083 032 ● 1878 085 741 ● 3151 000 493 430 10 MFZ430 430WGTZ KZISZ-5 K0LB12H3 / K0LB12H5 / K0LB13C3 / K0LB14C3 / K0LB14H3 / K0LA12C2 / K0LA13C2 / K0LA13C4 / K0LA14C2 / K0LA15C2 / K0LB12C3 für Ausrückgabel mit Rollen / for release fork with rollers (71)
		F3BE0681G	 3189 600 004 Getr. / GBox: ZF AS Tronic Rollenausführung / roller version (58)
MP 190 E 42 H	01.93 - 11.04	8210	 3400 700 455 ■ 430 10 Getr. / GBox: Fuller Nabenprofil / Hub Profile: 41,1x50,8-10N (48)
MP 190 E 42 W	01.93 - 11.04		
MP 260 E 37 H	01.93 - 11.04		 3400 117 801 ● 3482 083 032 ● 1878 085 741 ● 3151 000 144 430 10 MFZ430 430WGTZ KZISZ-5 für Ausrückgabel mit Nocken / for release fork with cams (70)
MP 260 E 37 W	01.93 - 11.04		
MP 260 E 42 H	01.93 - 11.04		
MP 260 E 42 W	01.93 - 11.04		3400 700 435 ● 3482 083 032 ● 1878 085 741 ● 3151 000 493 430 10 MFZ430 430WGTZ KZISZ-5 für Ausrückgabel mit Rollen / for release fork with rollers (71)
MP 380 E 37 W	01.93 - 11.04		
MP 380 E 37 H	01.93 - 11.04		 3189 600 004 Getr. / GBox: ZF AS Tronic Rollenausführung / roller version (58)
MP 410 E 37 H	01.93 - 11.04		
MP 440 E 37 HT	01.93 - 11.04		
MP 440 E 42 HT	01.93 - 11.04		
MP 720 E 37 HT	01.93 - 11.04		
MP 720 E 37 WT	01.93 - 11.04		
MP 720 E 42 HT	01.93 - 11.04		
MP 720 E 42 WT	01.93 - 11.04		
MP 190 E 44 W Cursor	09.00 - 11.04	F3AE0681	 3400 117 801 ● 3482 083 032 ● 1878 085 741 ● 3151 000 144 430 10 MFZ430 430WGTZ KZISZ-5 K0MA12C2 / K0MA13C2 / K0MA14C2 / K0MB12C3 / K0MB12C5 / K0MB12D3 / K0MB12D5 / K0MB12H3 / K0MB12H5 / K0MB13C3 / K0MB13H3 / K0MB13H5 / K0MB14C3 / K0MB14C5 für Ausrückgabel mit Nocken / for release fork with cams (70)
			3400 700 435 ● 3482 083 032 ● 1878 085 741 ● 3151 000 493 430 10 MFZ430 430WGTZ KZISZ-5 K0MA12C2 / K0MA13C2 / K0MA14C2 / K0MB12C3 / K0MB12C5 / K0MB12D3 / K0MB12D5 / K0MB12H3 / K0MB12H5 / K0MB13C3 / K0MB13H3 / K0MB13H5 / K0MB14C3 / K0MB14C5 für Ausrückgabel mit Rollen / for release fork with rollers (71)
		F3BE0681C	 3189 600 004 Getr. / GBox: ZF AS Tronic Rollenausführung / roller version (58)
MP 260 E 31 H Cursor	09.99 - 11.04	F2BE0681	 3400 084 031 ● 3482 078 134 ● 1878 032 032 ● 3151 000 144 400 10 MFZ400 400WGTZ KZISZ-5 Getr. / GBox: 12AS 1800 DD K1PA14C1 / K1PA14JD / K1PA14PD / K1PC73JD
MP 260 E 31 HB Cursor	11.99 - 11.04		
			3400 107 031 ● 3482 078 134 ● 1862 317 031 ● 3151 000 144 400 10 MFZ400 400GVZ KZISZ-5 Getr. / GBox: 9S 109 K1PA14A1 / K1PA14AD / K1PA14G2 / K1PA14GA / K1PA15AD / K1PA16G1 / K1PA16G2 / K1PA17AD / K1PA17G2 / K1PA17GA / K1PA72A1 / K1PA72G2 / K1PA73A1 / K1PA74G2 / K1PC74GD
			3400 107 031 ● 3482 078 134 ● 1862 317 031 ● 3151 000 144 400 10 MFZ400 400GVZ KZISZ-5 Getr. / GBox: 16S 109 K1PA12B1 / K1PA13A2 / K1PA14A2 / K1PA14B1 / K1PA15A2 / K1PA15B1 / K1PA15G2 / K1PA16A2 / K1PA16B1 / K1PA17A2 / K1PA17B1 / K1PA12A2
			3400 084 031 ● 3482 078 134 ● 1878 032 032 ● 3151 000 144 400 10 MFZ400 400WGTZ KZISZ-5 Getr. / GBox: 12AS 2301 DD K1PA13K2 / K1PA14KA / K1PA15KA
MP 260 E 35 H Cursor	01.00 - 11.04	F2BE0681	 3400 084 031 ● 3482 078 134 ● 1878 032 032 ● 3151 000 144 400 10 MFZ400 400WGTZ KZISZ-5 Getr. / GBox: 12AS 1800 DD K1RA16C1 / K1RA17C1
MP 260 E 35 W Cursor	09.99 - 11.04		
			3400 084 031 ● 3482 078 134 ● 1878 032 032 ● 3151 000 144 400 10 MFZ400 400WGTZ KZISZ-5 Getr. / GBox: 16S 151+INT K1RA14N1
			3400 084 031 ● 3482 078 134 ● 1878 032 032 ● 3151 000 144 400 10 MFZ400 400WGTZ KZISZ-5 Getr. / GBox: 16S 151 K1RA12A2 / K1RA13A1 / K1RA13A2 / K1RA13A4 / K1RA14A1 / K1RA14A2 / K1RA15A1 / K1RA15A2 / K1RA16A2 / K1RA16A4 / K1RA17A1 / K1RA17A2 / K1RA17AA / K1RA72A2 / K1RA73A2 / K1RA74A2 / K1RB13A1 / K1RB13A3 / K1RB14A1 / K1RB14A3
			3400 084 031 400 10 Getr. / GBox: 12AS 2301 DD K1RA12K2 / K1RA14K2 / K1RA15K2 / K1RA17K2























		CODE				
--	--	------	--	---	---	---

IVECO

EuroTrakker		01.93 - 11.04						
MP 260 E 35 W Cursor	09.99 - 11.04	F2BE0681		3400 084 031 3482 078 134 1878 032 032 3151 000 144	400 10 MFZ400 400WGTZ KZISZ-5	Getr. / GBox: 12AS 1800 DD K1RA16C1 / K1RA17C1		
				3400 084 031 3482 078 134 1878 032 032 3151 000 144	400 10 MFZ400 400WGTZ KZISZ-5	Getr. / GBox: 16S 151+INT K1RA14N1		
				3400 084 031 3482 078 134 1878 032 032 3151 000 144	400 10 MFZ400 400WGTZ KZISZ-5	Getr. / GBox: 16S 151 K1RA12A2 / K1RA13A1 / K1RA13A4 / K1RA14A1 / K1RA14A2 / K1RA15A1 / K1RA15A2 / K1RA16A2 / K1RA16A4 / K1RA17A1 / K1RA17A2 / K1RA17AA / K1RA72A2 / K1RA73A2 / K1RA74A2 / K1RB13A1 / K1RB13A3 / K1RB14A1 / K1RB14A3		
				3400 084 031 3482 078 134 1878 032 032 3151 000 144	400 10 MFZ400 400WGTZ KZISZ-5	Getr. / GBox: 12AS 2301 DD K1RA12K2 / K1RA14K2 / K1RA15K2 / K1RA17K2		
MP 260 E 38 H Cursor MP 260 E 38 W Cursor	01.01 - 11.04 01.01 - 11.04	F3AE0681		3400 117 801 3482 083 032 1878 085 741 3151 000 144	430 10 MFZ430 430WGTZ KZISZ-5	K1LA12C2 / K1LA12D2 / K1LA12H2 / K1LA13C2 / K1LA13C4 / K1LA13H2 / K1LA14C2 / K1LA14C4 / K1LA14D2 / K1LA14H2 / K1LA15C2 / K1LA15C4 / K1LA15H2 / K1LA15H4 / K1LA16C2 / K1LA16C4 / K1LA16H2 / K1LA17C2 / K1LA17C4 / K1LA17D2 / K1LB13C3 / K1LB13C5 / K1LB13H3 / K1LB13H5 / K1LB14C3 / K1LB14C5 / K1LB14H3 / K1LB14H5 für Ausrückgabel mit Nocken / for release fork with cams	(70)	
				3400 700 435 3482 083 032 1878 085 741 3151 000 493	430 10 MFZ430 430WGTZ KZISZ-5		K1LA12C2 / K1LA12D2 / K1LA12H2 / K1LA13C2 / K1LA13C4 / K1LA13H2 / K1LA14C2 / K1LA14C4 / K1LA14D2 / K1LA14H2 / K1LA15C2 / K1LA15C4 / K1LA15H2 / K1LA15H4 / K1LA16C2 / K1LA16C4 / K1LA16H2 / K1LA17C2 / K1LA17C4 / K1LA17D2 / K1LB13C3 / K1LB13C5 / K1LB13H3 / K1LB13H5 / K1LB14C3 / K1LB14C5 / K1LB14H3 / K1LB14H5 für Ausrückgabel mit Rollen / for release fork with rollers	(71)
		F3BE0681G		3189 600 004		Getr. / GBox: ZF AS Tronic Rollenausführung / roller version	(58)	
MP 260 E 44 H Cursor MP 260 E 44 H Cursor MP 260 E 44 W Cursor	01.01 - 11.04 01.00 - 11.04 01.01 - 11.04	F3AE0681		3400 117 801 3482 083 032 1878 085 741 3151 000 144	430 10 MFZ430 430WGTZ KZISZ-5	K1MA12C2 / K1MA12C4 / K1MA12D2 / K1MA12D4 / K1MA12H2 / K1MA12H4 / K1MA13C2 / K1MA13C4 / K1MA13D4 / K1MA14C2 / K1MA14C4 / K1MA14D2 / K1MA14H2 / K1MA14H4 / K1MA15C2 / K1MA15C4 / K1MA15D2 / K1MA15D4 / K1MA15H2 / K1MA16C2 / K1MA17C2 / K1MA17C4 / K1MA17J2 / K1MB13C3 / K1MB13C5 / K1MB13H3 / K1MB13H5 / K1MB14C3 / K1MB14H3 für Ausrückgabel mit Nocken / for release fork with cams	(70)	
				3400 700 435 3482 083 032 1878 085 741 3151 000 493	430 10 MFZ430 430WGTZ KZISZ-5		K1MA12C2 / K1MA12C4 / K1MA12D2 / K1MA12D4 / K1MA12H2 / K1MA12H4 / K1MA13C2 / K1MA13C4 / K1MA13D4 / K1MA14C2 / K1MA14C4 / K1MA14D2 / K1MA14H2 / K1MA14H4 / K1MA15C2 / K1MA15C4 / K1MA15D2 / K1MA15D4 / K1MA15H2 / K1MA16C2 / K1MA17C2 / K1MA17C4 / K1MA17J2 / K1MB13C3 / K1MB13C5 / K1MB13H3 / K1MB13H5 / K1MB14C3 / K1MB14H3 für Ausrückgabel mit Rollen / for release fork with rollers	(71)
							F3BE0681C	
MP 340 E 35 H Cursor MP 340 E 35 HB Cursor	09.99 - 11.04 01.01 - 11.04	F2BE0681		3400 084 031 3482 078 134 1878 032 032 3151 000 144	400 10 MFZ400 400WGTZ KZISZ-5	Getr. / GBox: 12AS 1800 DD K4RA13CD		
				3400 084 031 3482 078 134 1878 032 032 3151 000 144	400 10 MFZ400 400WGTZ KZISZ-5	Getr. / GBox: 16S 151 K4RA11A2 / K4RA13A2 / K4RA13AA / K4RA13DD / K4RA14A1 / K4RA14AA / K4RA71A1 / K4RA71A2 / K4RA73A1 / K4RA73A2		
				3400 084 031 3482 078 134 1878 032 032 3151 000 144	400 10 MFZ400 400WGTZ KZISZ-5	Getr. / GBox: 12AS 2301 DD K4RA13KA / K4RF13KA / K4RF14KC		

IVECO





















EuroTrakker		01.93 - 11.04					
MP 340 E 37 H MP 340 E 42 H MP 400 E 37 HT MP 400 E 37 WT	01.93 - 11.04	8210.42K(TCA), 8210.42K., 8210.42L.		3400 700 455 ■	430 10	Getr. / GBox: Fuller Nabenprofil / Hub Profile: 41,1x50,8-10N	(48)
	01.93 - 11.04			3400 117 801 ⊗ 3482 083 032 ⊗ 1878 085 741 ⊙ 3151 000 144	430 10 MFZ430 430WGTZ KZISZ-5	Getr. / GBox: ZF für Ausrückgabel mit Nocken / for release fork with cams	(70)
	01.93 - 11.04			3400 700 435 ⊗ 3482 083 032 ⊗ 1878 085 741 ⊙ 3151 000 493	430 10 MFZ430 430WGTZ KZISZ-5	Getr. / GBox: ZF für Ausrückgabel mit Rollen / for release fork with rollers	(71)
	01.93 - 11.04			3189 600 004		Getr. / GBox: ZF AS Tronic Rollenausführung / roller version	(58)
MP 340 E 38 H Cursor MP 340 E 38 HB Cursor	01.01 - 11.04	F3AE0681		3400 117 801 ⊗ 3482 083 032 ⊗ 1878 085 741 ⊙ 3151 000 144	430 10 MFZ430 430WGTZ KZISZ-5	K4LA11C2 / K4LA11D2 / K4LA11H2 / K4LA12C2 / K4LA12H2 / K4LA13C2 / K4LA13CA / K4LA13DA / K4LA13HA / K4LA13JA / K4LA71C2 / K4LA72C2 / K4LA73C2 / K4LF13CA für Ausrückgabel mit Nocken / for release fork with cams	(70)
	01.01 - 11.04			3400 700 435 ⊗ 3482 083 032 ⊗ 1878 085 741 ⊙ 3151 000 493	430 10 MFZ430 430WGTZ KZISZ-5	K4LA11C2 / K4LA11D2 / K4LA11H2 / K4LA12C2 / K4LA12H2 / K4LA13C2 / K4LA13CA / K4LA13DA / K4LA13HA / K4LA13JA / K4LA71C2 / K4LA72C2 / K4LA73C2 / K4LF13CA für Ausrückgabel mit Rollen / for release fork with rollers	(71)
		F3BE0681G		3189 600 004		Getr. / GBox: ZF AS Tronic Rollenausführung / roller version	(58)
MP 340 E 44 H Cursor MP 340 E 44 HB Cursor	01.01 - 11.04	F3AE0681		3400 117 801 ⊗ 3482 083 032 ⊗ 1878 085 741 ⊙ 3151 000 144	430 10 MFZ430 430WGTZ KZISZ-5	K4MA11C2 / K4MA11D2 / K4MA11H2 / K4MA11J2 / K4MA12C2 / K4MA12D2 / K4MA12H2 / K4MA12J2 / K4MA13C2 / K4MA13C4 / K4MA13CA / K4MA13D2 / K4MA13H2 / K4MA13H4 / K4MA13HA / K4MA13J4 / K4MA14CC / K4MA71C2 / K4MA72C2 / K4MA73C2 für Ausrückgabel mit Nocken / for release fork with cams	(70)
	01.01 - 11.04			3400 700 435 ⊗ 3482 083 032 ⊗ 1878 085 741 ⊙ 3151 000 493	430 10 MFZ430 430WGTZ KZISZ-5	K4MA11C2 / K4MA11D2 / K4MA11H2 / K4MA11J2 / K4MA12C2 / K4MA12D2 / K4MA12H2 / K4MA12J2 / K4MA13C2 / K4MA13C4 / K4MA13CA / K4MA13D2 / K4MA13H2 / K4MA13H4 / K4MA13HA / K4MA13J4 / K4MA14CC / K4MA71C2 / K4MA72C2 / K4MA73C2 für Ausrückgabel mit Rollen / for release fork with rollers	(71)
		F3BE0681C		3189 600 004		Getr. / GBox: ZF AS Tronic Rollenausführung / roller version	(58)
MP 380 E 31				3400 700 313 ⊗ 3482 083 113 ⊗ 1878 054 951 ⊙ 3151 000 144	430 10 MFZ430 430GTZ KZISZ-5	K3DA13A5 / K3DA13B5 / K3DA13E5 / K3DA14A5 / K3DA14E5 / K3DA15A5	
MP 380 E 38 HB Cursor MP 380 E 38 W Cursor	01.01 - 11.04	F3AE0681		3400 117 801 ⊗ 3482 083 032 ⊗ 1878 085 741 ⊙ 3151 000 144	430 10 MFZ430 430WGTZ KZISZ-5	K3LA12D2 / K3LA12H2 / K3LA13C2 / K3LA13C4 / K3LA13D2 / K3LA13E2 / K3LA13H2 / K3LA14C2 / K3LA14D2 / K3LA14H2 / K3LA15C2 / K3LA15C4 / K3LA15E2 / K3LA15H2 / K3LA74C2 / K3LB13C3 / K3LB13H3 / K3LB14C3 für Ausrückgabel mit Nocken / for release fork with cams	(70)
	01.01 - 11.04			3400 700 435 ⊗ 3482 083 032 ⊗ 1878 085 741 ⊙ 3151 000 493	430 10 MFZ430 430WGTZ KZISZ-5	K3LA12D2 / K3LA12H2 / K3LA13C2 / K3LA13C4 / K3LA13D2 / K3LA13E2 / K3LA13H2 / K3LA14C2 / K3LA14D2 / K3LA14H2 / K3LA15C2 / K3LA15C4 / K3LA15E2 / K3LA15H2 / K3LA74C2 / K3LB13C3 / K3LB13H3 / K3LB14C3 für Ausrückgabel mit Rollen / for release fork with rollers	(71)
		F3BE0681G		3189 600 004		Getr. / GBox: ZF AS Tronic Rollenausführung / roller version	(58)
MP 380 E 38 H Cursor MP 380 E 38 W Cursor	01.01 - 11.04	F3AE0681		3400 117 801 ⊗ 3482 083 032 ⊗ 1878 085 741 ⊙ 3151 000 144	430 10 MFZ430 430WGTZ KZISZ-5	K3LA12C2 / K3LA12D2 / K3LA12H2 / K3LA13C2 / K3LA13C4 / K3LA13D2 / K3LA13E2 / K3LA13H2 / K3LA14C2 / K3LA14D2 / K3LA14H2 / K3LA15C2 / K3LA15C4 / K3LA15E2 / K3LA15H2 / K3LA74C2 / K3LB13C3 / K3LB13H3 / K3LB14C3 / K3LB14H3 für Ausrückgabel mit Nocken / for release fork with cams	(70)
	01.01 - 11.04			3400 700 435 ⊗ 3482 083 032 ⊗ 1878 085 741 ⊙ 3151 000 493	430 10 MFZ430 430WGTZ KZISZ-5	K3LA12C2 / K3LA12D2 / K3LA12H2 / K3LA13C2 / K3LA13C4 / K3LA13D2 / K3LA13E2 / K3LA13H2 / K3LA14C2 / K3LA14D2 / K3LA14H2 / K3LA15C2 / K3LA15C4 / K3LA15E2 / K3LA15H2 / K3LA74C2 / K3LB13C3 / K3LB13H3 / K3LB14C3 / K3LB14H3 für Ausrückgabel mit Rollen / for release fork with rollers	(71)
		F3BE0681G		3189 600 004		Getr. / GBox: ZF AS Tronic Rollenausführung / roller version	(58)

EuroTrakker		01.93 - 11.04					
MP 380 E 42 H MP 380 E 42 W	01.93 - 11.04	8210		3400 700 455 ■	430 10	Getr. / GBox: Fuller Nabenprofil / Hub Profile: 41,1x50,8-10N	(48)
	01.93 - 11.04			3400 700 435 ⊗ 3482 083 032 ⊗ 1878 085 741 ⊙ 3151 000 493	430 10 MFZ430 430WGTZ KZISZ-5	Getr. / GBox: ZF für Ausrückgabel mit Rollen / for release fork with rollers	(71)
				3400 117 801 ⊗ 3482 083 032 ⊗ 1878 085 741 ⊙ 3151 000 144	430 10 MFZ430 430WGTZ KZISZ-5	Getr. / GBox: ZF für Ausrückgabel mit Nocken / for release fork with cams	(70)
	01.93 - 11.04	8210.42L.		3483 000 509 ⊕	445 GMFZ445W	K3FD14J1 für Fahrzeuge mit Wandlerschaltkupplung / for vehicles with converter and clutch unit	(76)
				1878 051 801	445 24 445GTZC	K3FD14J1 für Fahrzeuge mit Wandlerschaltkupplung / for vehicles with converter and clutch unit	(76)
				3189 600 004		Getr. / GBox: ZF AS Tronic Rollenausführung / roller version	(58)
MP 380 E 44 H Cursor MP 380 E 44 W Cursor MP 380 E 44 HB Cursor MP 440 E 44 HT Cursor MP 720 E 44 HT Cursor	01.01 - 11.04	F3AE0681		3400 117 801 ⊗ 3482 083 032 ⊗ 1878 085 741 ⊙ 3151 000 144	430 10 MFZ430 430WGTZ KZISZ-5	K3SA12C2 / K3SA12C4 / K3SA12D2 / K3SA12D4 / K3SA12H2 / K3SA13C2 / K3SA13H4 / K3SA15C2 / K3SA15C4 für Ausrückgabel mit Nocken / for release fork with cams	(70)
	01.01 - 11.04			3400 700 435 ⊗ 3482 083 032 ⊗ 1878 085 741 ⊙ 3151 000 493	430 10 MFZ430 430WGTZ KZISZ-5	K3SA12C2 / K3SA12C4 / K3SA12D2 / K3SA12D4 / K3SA12H2 / K3SA13C2 / K3SA13H4 / K3SA15C2 / K3SA15C4 für Ausrückgabel mit Rollen / for release fork with rollers	(71)
	01.01 - 11.04			3189 600 004		Getr. / GBox: ZF AS Tronic Rollenausführung / roller version	(58)
	01.01 - 11.04	F3BE0681C		3400 700 313 ⊗ 3482 083 113 ⊗ 1878 054 951 ⊙ 3151 000 144	430 10 MFZ430 430GTZ KZISZ-5	K0DA21A5 / K0DA21AE / K0DA21D5 / K0DB23D5	
	01.01 - 11.04			3400 700 455 ■	430 10	Getr. / GBox: Fuller Nabenprofil / Hub Profile: 41,1x50,8-10N	(48)
MP 400 E 31 MP 400 E 42 HT MP 400 E 42 WT	01.93 - 11.04	8460		3400 117 801 ⊗ 3482 083 032 ⊗ 1878 085 741 ⊙ 3151 000 144	430 10 MFZ430 430WGTZ KZISZ-5	Getr. / GBox: ZF für Ausrückgabel mit Nocken / for release fork with cams	(70)
	01.93 - 11.04			3400 700 435 ⊗ 3482 083 032 ⊗ 1878 085 741 ⊙ 3151 000 493	430 10 MFZ430 430WGTZ KZISZ-5	Getr. / GBox: ZF für Ausrückgabel mit Rollen / for release fork with rollers	(71)
				3189 600 004		Getr. / GBox: ZF AS Tronic Rollenausführung / roller version	(58)
	01.93 - 11.04	8210.42L(TCA), 8210.42L.		3400 117 801 ⊗ 3482 083 032 ⊗ 1878 085 741 ⊙ 3151 000 144	430 10 MFZ430 430WGTZ KZISZ-5	K5LA11C2 / K5LA11D2 / K5LA11E2 / K5LA11H2 / K5LA12C2 / K5LA12D2 / K5LA12H2 / K5LA13C2 / K5LA13E2 / K5LA13E3 / K5LA13H2 / K5LA14C2 / K5LA71C2 / K5LA73C2 für Ausrückgabel mit Nocken / for release fork with cams	(70)
MP 410 E 38 H Cursor MP 440 E 38 HT Cursor MP 720 E 38 HT Cursor	01.01 - 11.04	F3AE0681		3400 700 435 ⊗ 3482 083 032 ⊗ 1878 085 741 ⊙ 3151 000 493	430 10 MFZ430 430WGTZ KZISZ-5	K5LA11C2 / K5LA11D2 / K5LA11E2 / K5LA11H2 / K5LA12C2 / K5LA12D2 / K5LA12H2 / K5LA13C2 / K5LA13E2 / K5LA13E3 / K5LA13H2 / K5LA14C2 / K5LA71C2 / K5LA73C2 für Ausrückgabel mit Rollen / for release fork with rollers	(71)
	01.01 - 11.04			3189 600 004		Getr. / GBox: ZF AS Tronic Rollenausführung / roller version	(58)
	01.01 - 11.04	F3BE0681G		3400 700 455 ■	430 10	Getr. / GBox: Fuller Nabenprofil / Hub Profile: 41,1x50,8-10N	(48)
MP 410 E 42 H MP 410 E 42 W	01.93 - 11.04	8210		3400 700 435 ⊗ 3482 083 032 ⊗ 1878 085 741 ⊙ 3151 000 493	430 10 MFZ430 430WGTZ KZISZ-5	Getr. / GBox: ZF für Ausrückgabel mit Rollen / for release fork with rollers	(71)
	01.93 - 11.04			3400 117 801 ⊗ 3482 083 032 ⊗ 1878 085 741 ⊙ 3151 000 144	430 10 MFZ430 430WGTZ KZISZ-5	Getr. / GBox: ZF für Ausrückgabel mit Nocken / for release fork with cams	(70)
				3483 000 509 ⊕	445 GMFZ445W	K5FD12B1 für Fahrzeuge mit Wandlerschaltkupplung / for vehicles with converter and clutch unit	(76)
	01.93 - 11.04	8210.42L(TCA), 8210.42L.		1878 051 801	445 24 445GTZC	K5FD12B1 für Fahrzeuge mit Wandlerschaltkupplung / for vehicles with converter and clutch unit	(76)
				3189 600 004		Getr. / GBox: ZF AS Tronic Rollenausführung / roller version	(58)





		CODE				
--	--	------	--	---	---	---





IVECO















EuroTrakker 01.93 - 11.04



MP 410 E 44 HB Cursor MP 410 E 44 H Cursor	01.01 - 11.04	F3AE0681		3400 117 801  3482 083 032  1878 085 741  3151 000 144	430 10 MFZ430 430WGTZ KZISZ-5	K5MA12C3 / K5MA12C4 / K5MA12D2 / K5MA12H2 / K5MA12H4 / K5MA12J4 / K5MA13C2 / K5MA13C4 / K5MA13D2 / K5MA13H2 / K5MA13J2 / K5MA14C2 / K5MA14C3 / K5MA14C4 / K5MA14H2 / K5MA14H4 / K5MA14J4 / K5MA71C2 / K5MA73C2 / K5MB12C3 / K5MB12H3 / K5MA11C2 / K5MA11C3 / K5MA11C4 / K5MA11D2 / K5MA11D4 / K5MA11H2 / K5MA11J2 / K5MA12C2 für Ausrückgabel mit Nocken / for release fork with cams (70)
	01.01 - 11.04			3400 700 435  3482 083 032  1878 085 741  3151 000 493	430 10 MFZ430 430WGTZ KZISZ-5	K5MA12C3 / K5MA12C4 / K5MA12D2 / K5MA12H2 / K5MA12H4 / K5MA12J4 / K5MA13C2 / K5MA13C4 / K5MA13D2 / K5MA13H2 / K5MA13J2 / K5MA14C2 / K5MA14C3 / K5MA14C4 / K5MA14H2 / K5MA14H4 / K5MA14J4 / K5MA71C2 / K5MA73C2 / K5MB12C3 / K5MB12H3 / K5MA11C2 / K5MA11C3 / K5MA11C4 / K5MA11D2 / K5MA11D4 / K5MA11H2 / K5MA11J2 / K5MA12C2 für Ausrückgabel mit Rollen / for release fork with rollers (71)
		F3BE0681C		3189 600 004		Getr. / GBox: ZF AS Tronic Rollenausführung / roller version (58)
MP 720 E 31				3400 700 313  3482 083 113  1878 054 951  3151 000 144	430 10 MFZ430 430GTZ KZISZ-5	K3DA22A5 / K3DA23A5 / K3DA23D5 / K3DA23E5 / K3DA23EE
MP 720 E 48 HT Cursor	01.01 - 11.04	F3AE0681		3400 117 801  3482 083 032  1878 085 741  3151 000 144	430 10 MFZ430 430WGTZ KZISZ-5	L1PB2112 / L1PB2142 / L1PB21G2 / L1PB21J2 / L1PB21L2 / L1PB21W2 / L1PB23G2 / L1PB23GD / L1PB23J2 / L1PB23L2 / L1PB23W2 / L1PBH3G2 für Ausrückgabel mit Nocken / for release fork with cams (70)
						3400 700 435  3482 083 032  1878 085 741  3151 000 493
		F3BE0681E		3189 600 004		Getr. / GBox: ZF AS Tronic Rollenausführung / roller version (58)



M 06.82 - 12.92

115-17 135-17 135-17 T	09.83 - 12.85	8060		3482 905 001	330	->11.1985	
					MF330	Getr. / GBox: Fiat	
				1862 973 002	330 10	->11.1985	
					330CPB	Getr. / GBox: Fiat	
				3151 000 395	KZIS-4	->11.1985	
						Getr. / GBox: Fiat	
115-17 115-17 H	01.86 - 12.91	8060		3482 905 001	330	Getr. / GBox: Fiat,ZF	
					MF330		
				1862 973 002	330 10	Getr. / GBox: Fiat,ZF	
					330CPB		
135-17 135-17 H 135-17 T 145-17	01.86 - 12.91	8060		3482 905 001	330	Getr. / GBox: Fiat, ZF	
					MF330		
				1862 973 002	330 10	Getr. / GBox: Fiat, ZF	
					330CPB		
				3151 196 031	KZIS-4	Getr. / GBox: Fiat, ZF	
159-17	07.82 - 09.86	8360		3482 038 031	350	Getr. / GBox: ZF	
					GMF350		
				1861 742 032	350 10	Getr. / GBox: ZF	
					350GTB		
				3151 196 031	KZIS-4	Getr. / GBox: ZF	
165-24 R 165-24 R 165-24 T	06.82 - 09.86	8220.22.002, 8220.22.102		1882 325 139	380		
					G380		
				1878 000 957	380 10		
					380GTZ		
				3151 127 031	KZI-4,5	Getr. / GBox: Fuller	
				3151 114 031	KZI-4,5	Getr. / GBox: ZF	
175-17	09.86 - 12.92	8060		3482 905 001	330	Getr. / GBox: ZF	
					MF330		
				1862 973 002	330 10	Getr. / GBox: ZF	
					330CPB		
				3151 196 031	KZIS-4	Getr. / GBox: ZF	

M 06.82 - 12.92						
175-24 175-24 T	09.86 - 11.92	8460		1882 325 139	380 G380	
	09.86 - 11.92			1878 000 957	380 10 380GTZ	
				3151 127 031	KZI-4,5	Getr. / GBox: Fuller
				3151 114 031	KZI-4,5	Getr. / GBox: ZF

MK 01.83 - 12.91						
80-13 A	01.83 - 12.91	BF6L913T		3482 008 036 #	310 MF310	
80-13 AH	01.83 - 12.91			1861 577 136 #	310 10 310GTD	
80-13 AT	01.83 - 12.91			3151 199 001	KZIS-3	
90-13 A	01.83 - 12.91					
90-13 AH	01.83 - 12.91					
110-13 A	01.83 - 12.91					
110-13 AH	01.83 - 12.85					
80-13 AW	01.83 - 12.91	BF6L913T		3482 008 033	310 MF310	
80-13 AW	01.83 - 12.89			1861 577 136 #	310 10 310GTD	
				3151 199 001	KZIS-3	
80-16 A	01.83 - 12.91	BF6L913		3482 038 031	350 GMF350	
80-16 AW	01.86 - 12.89			1861 742 032	350 10 350GTB	
110-16 A	01.83 - 12.91			3151 199 001	KZIS-3	
110-16 AT	01.83 - 12.85					
130-13 A	01.83 - 12.91	BF6L913T		3482 008 036 #	310 MF310	für / for: Version 42231628 für / for: Version 42231929
130-13 AH	01.83 - 12.91			1861 577 136 #	310 10 310GTD	für / for: Version 42231628 für / for: Version 42231929
				3151 199 001	KZIS-3	für / for: Version 42231628 für / for: Version 42231929
130-16 A	01.83 - 12.91	BF6L913		3482 038 031	350 GMF350	für / for: Version 42231628 für / for: Version 42231929
130-16 AH	01.83 - 12.91			1861 742 032	350 10 350GTB	für / for: Version 42231628 für / for: Version 42231929
				3151 199 001	KZIS-3	für / for: Version 42231628 für / for: Version 42231929





































OM 35 - 616						
OM 35	01.85 -			1878 600 834	250 10 250CB	
OM 40 /35	05.76 - 12.85					
OM 40	05.76 -					
OM 45	01.85 -					
OM 50	01.85 -					
OM 616	05.76 -					
OM 55				1878 600 841	280 10 280CTB	
OM 65						
OM 70						
OM 75						

P/PA 12.79 - 12.93						
159-17 H	07.82 - 09.86	8360		3482 038 031	350 GMF350	Getr. / GBox: ZF
				1861 742 032	350 10 350GTB	Getr. / GBox: ZF
				3151 196 031	KZIS-4	Getr. / GBox: ZF

		CODE		 Parameter		
--	--	------	--	---	---	---









































IVECO

P/PA		12.79 - 12.93				
160-23 AH	04.84 - 05.89	F8L413F	 3482 124 531	430 GMF430		
			 1882 316 035 ●#	420 GF420		
			 1878 001 138	420 10 420GTZ		
			 3151 000 515	KZIS-4		
			 1882 306 136 #	420 G420N	für Nebenantrieb / for PTO	(82)
			 1861 643 134 #	420 10 420GSZ	für Nebenantrieb / for PTO	(82)
160-23 AHW	01.85 - 12.85	F8L413F	 1882 325 139	380 G380		
			 1878 000 957	380 10 380GTZ		
			 3151 000 515	KZIS-4		
160-23 AHW	04.84 - 05.89	F8L413F	 1882 325 139	380 G380	->01.1986	
			 1878 000 957	380 10 380GTZ	->01.1986	
			 3482 124 531	430 GMF430	02.1986->	
			 1882 316 035 ●#	420 GF420	02.1986->	
			 1878 001 138	420 10 420GTZ	02.1986->	
			 3151 000 515	KZIS-4		
			 1882 306 136 #	420 G420N	02.1986-> für Nebenantrieb / for PTO	(82)
			 1861 643 134 #	420 10 420GSZ	02.1986-> für Nebenantrieb / for PTO	(82)
160-30 AH	06.86 - 05.89	BF8L513	 3482 124 516	430 GMF430	Getr. / GBox: ZF	
			 1878 002 955	420 10 420GTZ	Getr. / GBox: ZF	
			 3151 000 515	KZIS-4	Getr. / GBox: ZF	
160-30 AH 160-30 AHW	06.86 - 05.89 06.86 - 05.89	BF8L513	 3482 124 516	430 GMF430	Getr. / GBox: ZF	
			 1878 002 955	420 10 420GTZ	Getr. / GBox: ZF	
			 3151 000 515	KZIS-4	Getr. / GBox: ZF	
170-23 AH	04.88 - 12.90	F8L513	 3482 124 531	430 GMF430		
			 1878 001 138	420 10 420GTZ		
			 3151 000 515	KZIS-4		
170-23 AHW 170-23 AHW,180-23 AHW	04.88 - 12.90 01.91 - 12.93	F8L513F	 1882 325 139	380 G380	Getr. / GBox: ZF	
			 1878 000 957	380 10 380GTZ	Getr. / GBox: ZF	
			 3482 124 531	430 GMF430	Getr. / GBox: ZF	
			 1882 316 035 ●#	420 GF420	Getr. / GBox: ZF	
			 1878 001 138	420 10 420GTZ	Getr. / GBox: ZF	
			 3151 000 515	KZIS-4	Getr. / GBox: ZF	
170-23 AH,180-23 AH 170-34 AH	01.91 - 12.93 04.89 - 12.90	BF8L513, F8L513	 3482 124 516	430 GMF430		
170-34 AH 170-34 AHW	01.91 - 12.93 04.89 - 12.90		 1878 002 955	420 10 420GTZ		
170-34 AH,180-34 AH 170-34 AHW,180-34 AHW	01.91 - 12.93 01.91 - 12.93		 3151 000 515	KZIS-4		























P/PA		12.79 - 12.93					
170-25 AH 170-25 AHW 170-25 AHW,180-25 AHW	03.89 - 12.90	F8L513F	 3482 124 531	430 GMF430	Getr. / GBox: ZF		
	03.89 - 12.90		 1882 316 035 ●#	420 GF420	Getr. / GBox: ZF		
	01.91 - 12.93		 1878 001 138	420 10 420GTZ	Getr. / GBox: ZF		
			 3151 000 515	KZIS-4	Getr. / GBox: ZF		
170-25 AH,180-25 AH	01.91 - 12.93	F8L413F	 1882 306 136 #	420 G420N	für Nebenantrieb / for PTO		(82)
			 1861 643 134 #	420 10 420GSZ	für Nebenantrieb / for PTO		(82)
		F8L513F	 3482 124 531	430 GMF430	Getr. / GBox: ZF		
			 1882 316 035 ●#	420 GF420	Getr. / GBox: ZF		
			 1878 001 138	420 10 420GTZ	Getr. / GBox: ZF		
			 3151 000 515	KZIS-4	Getr. / GBox: ZF		
190-25 AH 190-25 AHW	07.83 - 06.86	F8L413F	 3482 124 531	430 GMF430	Getr. / GBox: ZF		
	07.83 - 06.86		 1882 316 035 ●#	420 GF420	Getr. / GBox: ZF		
			 1878 001 138	420 10 420GTZ	Getr. / GBox: ZF		
			 3151 000 515	KZIS-4	Getr. / GBox: ZF		
190-30 H 190-30 H	04.87 - 12.90	8210	 3482 125 131	420 MF420	Getr. / GBox: Fuller enthält Druckplattenbefestigungsschrauben / includes bolt for pressure plate mounting		(65)
	01.91 - 12.92		 1878 002 955	420 10 420GTZ	Getr. / GBox: Fuller		
			 3151 000 515	KZIS-4	Getr. / GBox: Fuller		
190-30 HT 190-30 HT	01.89 - 12.90	8210.22.236, 8210.22.535, 8210.22.537, 8210.22.511, 8210.22.521, 8210.22.523, 8210.22.525, 8210.22.210	 3400 042 031 ☉	420 10 MF420 420GTZ	enthält Druckplattenbefestigungsschrauben / includes bolt for pressure plate mounting		(65)
	01.90 - 12.92		 3482 125 131  1878 002 955  1874 015 200				
190-30 HW 190-30 HW	04.87 - 12.90	8210.22.236, 8210.22.535, 8210.22.537, 8210.22.511, 8210.22.521, 8210.22.523, 8210.22.525, 8210.22.210	 3400 042 031 ☉	420 10 MF420 420GTZ	enthält Druckplattenbefestigungsschrauben / includes bolt for pressure plate mounting		(65)
	01.91 - 12.92		 3482 125 131  1878 002 955  1874 015 200  3151 114 031	KZI-4,5			
190-32 AH 190-32 AHW	01.83 - 12.85	F10L413F	 3482 124 532	430 GMF430			
	01.83 - 12.85		 1878 002 955	420 10 420GTZ			
			 3151 000 515	KZIS-4			
260-25 AH 260-25 AH 260-25 AHW	03.84 - 06.86	F8L413F	 3482 124 531	430 GMF430	Getr. / GBox: ZF		
	04.89 - 12.92		 1882 316 035 ●#	420 GF420	Getr. / GBox: ZF		
	03.84 - 06.86		 1878 001 138	420 10 420GTZ	Getr. / GBox: ZF		
			 3151 000 515	KZIS-4	Getr. / GBox: ZF		
260-25 AHB 260-25 AHB	12.79 - 10.85	F8L413F	 1882 325 139	380 G380	Getr. / GBox: ZF		
	03.84 - 06.86		 1878 000 957	380 10 380GTZ	Getr. / GBox: ZF		
			 3151 000 515	KZIS-4	Getr. / GBox: ZF		

































		CODE				
--	--	------	--	---	---	---

IVECO

P/PA		12.79 - 12.93					
260-30 AH	06.86 - 05.90	BF8L513		3482 124 516	430 GMF430	Getr. / GBox: ZF	
260-30 AHT	06.86 - 05.90			1878 002 955	420 10 420GTZ	Getr. / GBox: ZF	
260-30 AHW	06.86 - 05.90			3151 000 515	KZIS-4	Getr. / GBox: ZF	
260-34 AH	04.89 - 12.90						
260-34 AH	01.91 - 12.92						
260-34 AHT	01.91 - 12.92						
260-34 AHT	04.89 - 12.90						
260-34 AHW	01.91 - 12.92						
260-32 AH	01.83 - 12.85	F10L413F		3482 124 532	430 GMF430	Getr. / GBox: ZF	
260-32 AHT	01.83 - 12.85			1878 002 955	420 10 420GTZ	Getr. / GBox: ZF	
260-32 AHW	01.83 - 12.85			3151 000 515	KZIS-4	Getr. / GBox: ZF	
300-30 AH	04.87 - 05.89	BF8L513		3482 124 516	430 GMF430		
300-30 AHB	04.87 - 05.89			1878 002 955	420 10 420GTZ		
				3151 000 515	KZIS-4		
330-30 H	01.88 - 12.90	8210		3400 118 901 ☹	420 10 MF420 420WGTZ	enthält Druckplattenbefestigungsschrauben / includes bolt for pressure plate mounting	(65)
330-30 H	01.91 - 12.92			3482 125 131			
330-30 H	06.84 - 12.90			1878 003 661			
330-30 H	06.84 - 12.92			1874 015 200			
330-30 HT	01.91 - 12.92			1878 002 955 ●	420 10 420GTZ		
330-30 HT	01.88 - 12.90			3151 000 515	KZIS-4		
330-30 HT	01.88 - 12.92						
330-30 HW	01.91 - 12.92	8210.22X.523, 8210.22X.235		3400 042 031 ☹	420 10 MF420 420GTZ	enthält Druckplattenbefestigungsschrauben / includes bolt for pressure plate mounting	(65)
330-30 HW	01.88 - 12.90			3482 125 131			
330-30 HW	01.88 - 12.92			1878 002 955			
				1874 015 200			
				3151 196 031	KZIS-4		
330-36 H	01.91 - 12.92	8210.42.269, 8210.42.235, 8210.42.271, 8210.42.270, 8210.42.237, 8210.42.210		3400 700 418	430 10 MFZ430 430WGTZ	Getr. / GBox: ZF	
330-36 H	01.89 - 12.90			3483 020 035			
330-36 H	01.89 - 12.92			1878 085 741			
				3400 700 454 ▣	430 10	Getr. / GBox: Fuller Nabenprofil / Hub Profile: 41,1x50,8-10N	(48)
				3482 083 040	430 MFZ430	Getr. / GBox: ZF Getr. / GBox: Fuller In 3483/3488 enthalten / Contained in 3483, 3488	(32)
				3100 002 038	KZIZ5 KZI/Z-5	Getr. / GBox: ZF Getr. / GBox: Fuller Beinhaltet Ausrücker und Montagesatz / Contains releaser and fitting kit In 3483/3488 enthalten / Contained in 3483, 3488	(9) (32)
				3151 123 031			
				3180 001 008			
				1888 063 137	380 GF2/380N	für Nebenantrieb / for PTO enthält eine Kupplungsscheibe / This part number includes one clutch disc	(82) (67)
				1862 304 033 ▽	380 10 380GV	für Nebenantrieb / for PTO Lose Kupplungsscheibe / Loose clutch disc	(82) (41)
				1882 019 133	380 GF2/380N	In 1888 enthalten / Contained in 1888	(31)
			1859 250 101	380 GF2/380	In 1888 enthalten / Contained in 1888	(31)	
			1862 305 033 △	380 10 380GVZ	In 1888 enthalten / Contained in 1888	(31)	
330-36 HT	01.89 - 12.90	8210.42.269, 8210.42.235, 8210.42.271, 8210.42.270, 8210.42.237, 8210.42.210		3400 700 418	430 10 MFZ430 430WGTZ	Getr. / GBox: ZF Getr. / GBox: Fuller	
				3483 020 035			
				1878 085 741			
				3482 083 040	430 MFZ430	Getr. / GBox: ZF Getr. / GBox: Fuller In 3483/3488 enthalten / Contained in 3483, 3488	(32)
				3100 002 038	KZIZ5 KZI/Z-5	Getr. / GBox: ZF Getr. / GBox: Fuller Beinhaltet Ausrücker und Montagesatz / Contains releaser and fitting kit In 3483/3488 enthalten / Contained in 3483, 3488	(9) (32)
				3151 123 031			
				3180 001 008			



































IVECO

P/PA		12.79 - 12.93					
330-36 HT	01.91 - 12.92	8210.42.269,		3400 700 418	430 10	Getr. / GBox: ZF	
330-36 HT	01.89 - 12.90	8210.42.235,		 3483 020 035	MFZ430		
330-36 HT	01.89 - 12.92	8210.42.271,		 1878 085 741	430WGTZ		
330-36 HW	01.89 - 10.90	8210.42.270,		3400 700 454 ■	430 10	Getr. / GBox: Fuller	
330-36 HW	01.89 - 12.92	8210.42.237,		3482 083 040	430	Nabenprofil / Hub Profile: 41,1x50,8-10N	(48)
330-36 HW	01.91 - 12.92	8210.42.210		430	MFZ430	Getr. / GBox: ZF	
				3100 002 038	KZIZ5	Getr. / GBox: Fuller	
				 3151 123 031	KZI/Z-5	Getr. / GBox: Fuller	(9)
				 3180 001 008		Beinhaltet Ausrücker und Montagesatz / Contains releaser and fitting kit	(32)
						In 3483/3488 enthalten / Contained in 3483, 3488	(32)
340-34 AH	03.89 - 12.92	BF8L513		3400 042 031 ☉	420 10	enthält Druckplattenbefestigungsschrauben / includes bolt for pressure plate mounting	(65)
				 3482 125 131	MF420		
				 1878 002 955	420GTZ		
				 1874 015 200			
				3151 000 515	KZIS-4		

P/PA-Haubenfahrzeuge		12.79 - 12.93					
120-13 ANW	01.83 - 09.90	F6L913, BF6L913T		3151 199 001	KZIS-3		
120-16 ANW,120-17 ANW	01.83 - 11.89	BF6L913		3151 199 001	KZIS-3		
				1882 307 131 ▲	350	für / for: Version 42231628	(69)
				1878 001 070	GF350	für / for: Version 42231929	(69)
				3151 000 515	350 10	für / for: Version 42231628	(69)
					350GTZ	für / for: Version 42231929	(69)
150-16 AN	01.83 - 12.91	BF6L913		3482 038 031	350	Getr. / GBox: ZF	
150-16 ANW	01.83 - 12.91			1861 742 032	GMF350		
				3151 000 395	350 10	Getr. / GBox: ZF	
					350GTB		
160-17 AN	07.89 - 12.93	BF6L913/U,		1882 307 131 ▲	350		
160-17 ANW	07.89 - 12.93	BF6L913		1878 001 070	GF350		
				3151 000 515	350 10		
					350GTZ		
160-23 ANW	01.86 - 05.89	F8L413F,		1882 325 139	380	79011212 / 79011232	
160-23 ANW	04.84 - 12.85	F8L513		1878 000 957	G380		
160-23 ANW	04.85 - 12.85			3151 000 515	380 10	79011212 / 79011232	
160-23 ANW	01.88 - 05.89				380GTZ		
170-23 ANW	04.88 - 12.90				KZIS-4	79011212 / 79011232	
190-25 ANT	07.86 - 12.87						
170-23 ANW	01.90 - 12.90	F8L513		1882 325 139	380		
170-23 ANW	01.91 - 12.93			1878 000 957	G380		
				3151 000 515	380 10		
					380GTZ		
					KZIS-4		
190-25 AN	07.83 - 12.86	F8L413F		1882 306 136 #	420	für Nebenantrieb / for PTO	(82)
190-25 AN	07.83 - 12.87			3482 124 531	G420N		
				1882 316 035 ●#	430	->11.1984	
					GMF430		
				1878 001 138	420	->11.1984	
					GF420		
					420 10	->11.1984	
					420GTZ		
190-25 AN	01.86 - 09.90	F8L413F		3151 000 515	KZIS-4	->11.1984	
					420	für Nebenantrieb / for PTO	(82)
					G420N		















		CODE				
--	--	------	--	---	---	---



IVECO





























P/PA-Haubenfahrzeuge 12.79 - 12.93						
190-25 ANT	07.83 - 06.86	F8L413F	 3482 124 531	430 GMF430	->11.1984	
			 1882 316 035 ●#	420 GF420	->11.1984	
			 1878 001 138	420 10 420GTZ	->11.1984	
			 3151 000 515	KZIS-4	->11.1984	
190-25 ANW 190-25 ANW	07.83 - 12.86	F8L413F	 3482 124 531	430 GMF430		
	07.83 - 12.87		 1882 316 035 ●#	420 GF420		
			 1878 001 138	420 10 420GTZ	->11.1984	
			 1878 002 955	420 10 420GTZ	12.1984->	
			 3151 000 515	KZIS-4		
190-25 ANW	01.86 - 09.90	F8L413F	 3482 124 531	430 GMF430		
			 1882 316 035 ●#	420 GF420		
			 1878 002 955	420 10 420GTZ		
			 3151 000 515	KZIS-4		
190-30 N 190-30 N 190-30 NT 190-30 NT	04.87 - 12.90	8210	 3482 125 131	420 MF420	Getr. / GBox: Fuller enthält Druckplattenbefestigungsschrauben / includes bolt for pressure plate mounting	(65)
	01.91 - 12.93		 1878 002 955	420 10 420GTZ	Getr. / GBox: Fuller	
	04.87 - 12.90		 3151 000 515	KZIS-4	Getr. / GBox: Fuller	
	01.91 - 12.93					
260-25 AN	07.83 - 06.86	F8L413F	 1882 325 139 <small>RHD</small>	380 G380	Getr. / GBox: ZF	
			 1878 000 957 <small>RHD</small>	380 10 380GTZ	Getr. / GBox: ZF	
			 3151 000 515 <small>RHD</small>	KZIS-4	Getr. / GBox: ZF	
			 3482 124 531	430 GMF430	Getr. / GBox: ZF	
			 1882 316 035 #	420 GF420	Getr. / GBox: ZF	
			 1878 001 138	420 10 420GTZ	für / for: ANW Getr. / GBox: ZF Produktionsnummer / Production Number: 42231	(69) (54)
			 1878 002 955	420 10 420GTZ	für / for: AN Getr. / GBox: ZF Produktionsnummer / Production Number: 77311 Produktionsnummer / Production Number: 77211	(69) (54) (54)
			 3151 000 515	KZIS-4	Getr. / GBox: ZF	
260-25 ANW	07.83 - 06.86	F8L413F	 3482 124 531	430 GMF430	Getr. / GBox: ZF	
			 1882 316 035 ●#	420 GF420	Getr. / GBox: ZF	
			 1878 001 138	420 10 420GTZ	Getr. / GBox: ZF	
			 3151 000 515	KZIS-4	Getr. / GBox: ZF	
330-30 AN 330-30 ANW	05.86 - 09.90	BF8L513	 3482 124 533 #	420 GMF430	Getr. / GBox: ZF, Fuller	
	05.86 - 09.90		 1878 002 955	420 10 420GTZ	Getr. / GBox: ZF, Fuller	
			 3151 000 515	KZIS-4	Getr. / GBox: ZF, Fuller	
330-30 ANW			 3400 700 312  3482 083 113  1878 085 741  3151 000 144	430 10 MFZ430 430WGTZ KZISZ-5		

		CODE				
--	--	------	--	---	---	---





IVECO

P/PA-Haubenfahrzeuge 12.79 - 12.93						
330-30 N	01.91 - 12.92	8210.22X.575,		3400 042 031   3482 125 131  1878 002 955  1874 015 200	420 10 MF420 420GTZ	70351112 / 70351115 / 70351212 / 70351215 / 70351315 enthält Druckplattenbefestigungsschrauben / includes bolt for pressure plate mounting (65)
330-30 N	10.87 - 12.90	8210.22X.069			3151 000 515	KZIS-4 70351112 / 70351115 / 70351212 / 70351215 / 70351315
330-30 N	10.87 - 12.92			3482 085 033	420 MF420	70431112 / 70431115 enthält Druckplattenbefestigungsschrauben / includes bolt for pressure plate mounting (65)
				1878 002 955	420 10 420GTZ	70431112 / 70431115
				3151 196 031	KZIS-4	70431112 / 70431115
330-30 NW	01.91 - 12.92	8210.22X.575,		3400 042 031   3482 125 131  1878 002 955  1874 015 200	420 10 MF420 420GTZ	enthält Druckplattenbefestigungsschrauben / includes bolt for pressure plate mounting (65)
330-30 NW	10.87 - 12.90	8210.22X.069				
330-30 NW	10.87 - 12.92					







Sirius						
Sirius K		F4L514		1880 083 132 #	280 G280	
Sirius S		F4L514		1880 083 132 #	280 G280	
				1863 600 125	GR-3	mit Anlaufring / with thrust ring (88)

Stralis 02.02 -							
Stralis Euro 6		Cursor11		3400 700 366  3482 000 572  1878 004 132  3151 000 493	430 10 MFZ430 430WGTZ KZISZ-5	für / for: 480 PS Getr. / GBox: 16 S 2320 TD Getr. / GBox: 16 S 2520 TO Getr. / GBox: 12 AS 2330 TD Getr. / GBox: 12 AS 2330 TO Euro 6 / Euro 6 für Ausrückgabel mit Rollen / for release fork with rollers (69) (18) (71)	
				3400 700 366  3482 000 572  1878 004 132  3151 000 493	430 10 MFZ430 430WGTZ KZISZ-5	für / for: 500 PS Getr. / GBox: 16 S 2320 TD Getr. / GBox: 16 S 2520 TO Getr. / GBox: 12 AS 2330 TO Getr. / GBox: 16 AS 2630 TO Euro 6 / Euro 6 für Ausrückgabel mit Rollen / for release fork with rollers (69) (18) (71)	
				3400 700 366  3482 000 572  1878 004 132  3151 000 493	430 10 MFZ430 430WGTZ KZISZ-5	für / for: 560 PS Getr. / GBox: 16 S 2520 TO Getr. / GBox: 12 AS 2530 TO Euro 6 / Euro 6 für Ausrückgabel mit Rollen / for release fork with rollers (69) (18) (71)	
				3189 600 004		Getr. / GBox: ZF AS Tronic Rollenausführung / roller version (58)	
	260S35 AD	02.02 -	F2BE0681		3400 084 031  3482 078 134  1878 032 032  3151 000 144	400 10 MFZ400 400WGTZ KZISZ-5	Getr. / GBox: 6S-151 Getr. / GBox: 12AS 2301DD
	260S35 AD				3496 006 000		Getr. / GBox: 6S-151 Getr. / GBox: 12AS 2301DD langer Bügel / long handle (86)
260S35 AT							
450S33 T	04.12 -	Cursor9		3400 700 377  3482 000 628  1878 004 581  3151 000 651	430 10 MF430 430WGTZ KZIS-4	Getr. / GBox: 9 S 1310TO Euro 6 / Euro 6 (18)	
		F2CFE611C		3189 600 004		Getr. / GBox: ZF AS Tronic Rollenausführung / roller version (58)	
460S36 T	04.12 -	Cursor9		3400 700 365  3482 000 573  1878 004 133  3151 000 493	430 10 MFZ430 430WGTZ KZISZ-5	Getr. / GBox: 16 S 1620 TD Getr. / GBox: 12 AS 1420 TD Getr. / GBox: 12 AS 1930 TD Getr. / GBox: 12 AS 2330 TO Euro 6 / Euro 6 für Ausrückgabel mit Rollen / for release fork with rollers (18) (71)	
500S33 T	04.12 -						
530S36 T	04.12 -						
AD 190S36, AT 190S36	01.13 -						
AD 190S40, AT 190S40	01.13 -						
AD 260S36, AT 260S36	01.13 -	F2CFE611A,		3189 600 004		Getr. / GBox: ZF AS Tronic Rollenausführung / roller version (58)	
AD 260S40, AT 260S40	01.13 -	F2CFE611C, F2CFE611B					

IVECO































Stralis		02.02 -				
AD 190S27, AT 190S27 AD 260S31, AT 260S31	06.03-	F2BE0681F, F2BE3681C, F2BE0681B, F2BE0681C		3400 107 031 ⊗ 3482 078 134 ⊗ 1862 317 031 ⊙ 3151 000 144	400 10 MFZ400 400GVZ KZISZ-5	Getr. / GBox: 9S, 16S
	06.03-			3400 084 031 ⊗ 3482 078 134 ⊗ 1878 032 032 ⊙ 3151 000 144	400 10 MFZ400 400WGTZ KZISZ-5	Getr. / GBox: 12AS
AD 190S30, AD 190S31, AT 190S31	06.03-	F2BE0681		3400 084 031 ⊗ 3482 078 134 ⊗ 1878 032 032 ⊙ 3151 000 144	400 10 MFZ400 400WGTZ KZISZ-5	Getr. / GBox: 12AS-2301 DD MDPB1ME1 / MDPG14F1 / MDPG16E1 / MDPG16F1 / MDPG17E1 / MDPG17F1 / MDPG18E1 / MDPG18F1 / MDPG19E1 / MDPG1ME1 / NDPB1ME1 / NDPB1MF1 / NDPB1MFA / NDPG16E1 / NDPG18E1 / NDPG18F1 / NDPG19E1 / NDPG19F1 / NDPG1ME1 / NDPG1MF1 / NDPB15E1 / NDPB15F1 / NDPB16F1 / NDPB17E1 / NDPB17F1 / NDPB18E1 / NDPB18F1 / NDPB19E1 / NDPB19F1 / MDPB13E1 / MDPB13F1 / MDPB14E1 / MDPB14F1 / MDPB15E1 / MDPB16E1 / MDPB16F1 / MDPB17E1 / MDPB17EA / MDPB17F1 / MDPB18E1 / MDPB18EA / MDPB18F1 / MDPB19E1 / MDPB19F1
				3400 107 031 ⊗ 3482 078 134 ⊗ 1862 317 031 ⊙ 3151 000 144	400 10 MFZ400 400GVZ KZISZ-5	Getr. / GBox: 9S-109 MDPB1MB1 / MDPG14B1 / MDPG15B1 / MDPG16A1 / MDPG17A1 / MDPG17B1 / MDPG18A1 / MDPG18B1 / MDPG1MB1 / NDPA14B1 / NDPA15B1 / NDPB1MA1 / NDPB1MB1 / NDPG15A1 / NDPG17A1 / NDPG17B1 / NDPG18A1 / NDPG18B1 / NDPG19B1 / NDPG1MB1 / NDPA17A1 / NDPA17B1 / NDPA18A1 / NDPA18B1 / NDPA19A1 / NDPB15A1 / NDPB15B1 / NDPB16B1 / NDPB17A1 / NDPB17B1 / NDPB18A1 / NDPB18B1 / NDPB19A1 / NDPB19B1 / MDPA13A1 / MDPA13B1 / MDPA14A1 / MDPA14B1 / MDPA15A1 / MDPA15B1 / MDPA16A1 / MDPA16B1 / MDPA17A1 / MDPA17B1 / MDPA18A1 / MDPA18B1 / MDPA19A1 / MDPA19B1 / MDPB13A1 / MDPB13B1 / MDPB14A1 / MDPB14B1 / MDPB15A1 / MDPB15B1 / MDPB16A1 / MDPB16B1 / MDPB17A1 / MDPB17B1 / MDPB18A1 / MDPB18B1 / MDPB19A1 / MDPB19B1 / MDPB1MA1
				3400 107 031 ⊗ 3482 078 134 ⊗ 1862 317 031 ⊙ 3151 000 144	400 10 MFZ400 400GVZ KZISZ-5	Getr. / GBox: 16S-109 MDPB1MG1 / MDPB1MH1 / MDPG14G1 / MDPG14H1 / MDPG16G1 / MDPG17G1 / MDPG18G1 / MDPG19G1 / MDPG1MG1 / MDPG1MH1 / NDPA14G1 / NDPA15G1 / NDPB19H1 / NDPB1MG1 / NDPB1MH1 / NDPG15G1 / NDPG17G1 / NDPG18G1 / NDPG18H1 / NDPG19G1 / NDPG1MG1 / NDPG1MH1 / NDPA16G1 / NDPA17G1 / NDPA18H1 / NDPB14G1 / NDPB15G1 / NDPB16G1 / NDPB17G1 / NDPB17H1 / NDPB18G1 / NDPB18H1 / NDPB19G1 / MDPA13G1 / MDPA13H1 / MDPA14G1 / MDPA14H1 / MDPA15G1 / MDPA15H1 / MDPA16G1 / MDPA16H1 / MDPA17G1 / MDPA17H1 / MDPA18G1 / MDPB13G1 MDPB13H1 / MDPB14G1 / MDPB14H1 / MDPB15G1 / MDPB15H1 / MDPB16G1 / MDPB17G1 / MDPB17H1 / MDPB18G1 / MDPB18H1 / MDPB19G1 / MDPB19H1
AD 190S31, AT 190S31	04.04-	F2BE3681C		3400 700 377 ⊗ 3482 000 628 ⊗ 1878 004 581 ⊙ 3151 000 651	430 10 MF430 430WGTZ KZIS-4	QAAB13C1 / QAAB13C3 / QAAA13C1 / TAAA19C1 / TAAB19C1 / TAAB16C3 / TAAB17C3 / TAAB18C3 / TAAB19C3 / TAAA17C3
AD 190S31, AT 190S31 AD 190S33, AT 190S33 AD 260S31, AT 260S31 AD 260S31, AT 260S31 AD 260S33, AT 260S33	01.13-	Cursor9		3400 700 365 ⊗ 3482 000 573 ⊗ 1878 004 133 ⊙ 3151 000 493	430 10 MFZ430 430WGTZ KZISZ-5	Getr. / GBox: 16 S 1620 TD Getr. / GBox: 12 AS 1420 TD Getr. / GBox: 12 AS 1930 TD Getr. / GBox: 12 AS 2330 TO Euro 6 / Euro 6 für Ausrückgabel mit Rollen / for release fork with rollers
	01.13-			3400 700 377 ⊗ 3482 000 628 ⊗ 1878 004 581 ⊙ 3151 000 651	430 10 MF430 430WGTZ KZIS-4	Getr. / GBox: 9 S 1310TO Euro 6 / Euro 6
		F2BE3681C, F2CFE611D, F2CFE611C		3189 600 004		Getr. / GBox: ZF AS Tronic Rollenausführung / roller version

IVECO































Stralis		02.02 -					
AD 190S33, AT 190S33	12.06 -	F2BE3681		3400 700 365 Ⓢ 3482 000 573 Ⓢ 1878 004 133 Ⓢ 3151 000 493	430 10 MFZ430 430WGTZ KZISZ-5	Getr. / GBox: 12AS-1420 TD TABB1MBA für Ausrückgabel mit Rollen / for release fork with rollers	(71)
				3400 700 365 Ⓢ 3482 000 573 Ⓢ 1878 004 133 Ⓢ 3151 000 493	430 10 MFZ430 430WGTZ KZISZ-5	Getr. / GBox: 12AS-1930 TD QABB17E1 / TABB14E1 / TABB18E1 / TABCU8E1 für Ausrückgabel mit Rollen / for release fork with rollers	(71)
		F2BE3681B		3189 600 004		Getr. / GBox: ZF AS Tronic Rollenausführung / roller version	(58)
AD 190S33, AT 190S33	05.07 -	F2BE3681B		3400 700 365 Ⓢ 3482 000 573 Ⓢ 1878 004 133 Ⓢ 3151 000 493	430 10 MFZ430 430WGTZ KZISZ-5	QABB13E3 / QABB19E3 / QABCD7E3 für Ausrückgabel mit Rollen / for release fork with rollers	(71)
				3400 700 378 Ⓢ 3482 000 573 Ⓢ 1878 004 133 Ⓢ 3151 000 144	430 10 MFZ430 430WGTZ KZISZ-5	QABA13A3 / QABA14A3 / QABA17A3 / QABA19A3 / QABB14A3 / QABB17A3 / QABB18A3 / QABB19A3 für Ausrückgabel mit Nocken / for release fork with cams	(70)
		F2BE3681B		3189 600 004		Getr. / GBox: ZF AS Tronic Rollenausführung / roller version	(58)
AD 190S35	04.04 -	F2BE0681A		3400 084 031 Ⓢ 3482 078 134 Ⓢ 1878 032 032 Ⓢ 3151 000 144	400 10 MFZ400 400WGTZ KZISZ-5	Getr. / GBox: 9S,16S,12AS	

		CODE				
--	--	------	--	---	---	---

IVECO

Stralis		02.02 -					
AD 190S35, AT 190S35, AD 190S36, AT 190S36	06.03-	F2BE0681	 3400 084 031  3482 078 134  1878 032 032  3151 000 144	400 10 MFZ400 400WGTZ KZISZ-5	Getr. / GBox: 12AS-2301 DD NDRB14E1 / NDRB14F1 / NDRB16E1 / NDRB17E1 / NDRB17F1 / NDRB18E1 / NDRB18F1 / NDRB19E1 / NDRB19EA / NDRB19F1 / NDRB19FA / NDRB1ME1 / NDRB1MF1 / MDRB14E1 / MDRB14F1 / MDRB15E1 / MDRB16E1 / MDRB16F1 / MDRB17E1 / MDRB17F1 / MDRB18E1 / MDRB19E1 / MDRB19F1 / MDRB1ME1 / MDRG15EA / MDRG15F1 / MDRG16E1 / MDRG17E1 / MDRG17F1 / MDRG18E1 / MDRG18F1 / MDRG19F1 / MDRG1ME1 / MDRG1MEA / MDRG1MF1 / NDRG16E1 / NDRG16F1 / NDRG17E1 / NDRG18E1 / NDRG18F1 / NDRG19E1 / NDRG19F1 / NDRG1ME1 / NDRG1MF1		
			3400 084 031  3482 078 134  1878 032 032  3151 000 144	400 10 MFZ400 400WGTZ KZISZ-5	Getr. / GBox: 16S-151 NDRA17B1 / NDRA18B1 / NDRA19A1 / NDRA19B1 / NDRB14A1 / NDRB14B1 / NDRB15B1 / NDRB16A1 / NDRB16B1 / NDRB17A1 / NDRB17B1 / NDRB18A1 / NDRB19B1 / NDRB1MA1 / NDRB1MB1 / NDRG14A1 / NDRG16A1 / NDRG16B1 / MDRA13A1 / MDRA13B1 / MDRA14A1 / MDRA14B1 / MDRA15A1 / MDRA15B1 / MDRA16A1 / MDRA16B1 / MDRA17A1 / MDRA17B1 / MDRA18A1 / MDRA18B1 / MDRA19A1 / MDRA19B1 / MDRB14A1 / MDRB14B1 / MDRB15A1 / MDRB15BA / MDRB16A1 / MDRB16B1 / MDRB17A1 / MDRB17B1 / MDRB18A1 / MDRB18B1 / MDRB19A1 / MDRB19B1 / MDRB1MA1 / MDRG14A1 / MDRG14B1 / MDRG15A1 / MDRG16A1 / MDRG16B1 / MDRG17B1 / MDRG18A1 / MDRG18B1 / MDRG19A1 / MDRG1MA1 / NDRG17A1 / NDRG17B1 / NDRG18A1 / NDRG18B1 / NDRG19A1 / NDRG19B1 / NDRG1MA1 / NDRG1MB1		
		F2BE3681	 3400 700 365  3482 000 573  1878 004 133  3151 000 493	430 10 MFZ430 430WGTZ KZISZ-5	Getr. / GBox: 12AS-1930TD QACA13B1 / QACB13B1 / QACB17B1 / QACB18B1 / QACCD8B1 / TACB18B1 / TACB19B1 / TACCD8B1 / TACCD9B1 für Ausrückgabel mit Rollen / for release fork with rollers	(71)	
			3400 700 378  3482 000 573  1878 004 133  3151 000 144	430 10 MFZ430 430WGTZ KZISZ-5	Getr. / GBox: 16S-1620TD QACA13A1 / QACA16A1 / QACA18A1 / QACA19A1 / QACB13A1 / QACB16A1 / QACB17A1 / QACCD8A1 / QACCDMA1 / TACA19A1 / TACB16A1 / TACB18A1 / TACB19A1 / TACCD7A1 / TACCD8A1 für Ausrückgabel mit Nocken / for release fork with cams	(70)	
		F2BE3681A, F2BE0681A	 3400 700 365  3482 000 573  1878 004 133  3151 000 493	430 10 MFZ430 430WGTZ KZISZ-5	TACB1MB1 / TACCU8B1 für Ausrückgabel mit Rollen / for release fork with rollers	(71)	
			3400 700 378  3482 000 573  1878 004 133  3151 000 144	430 10 MFZ430 430WGTZ KZISZ-5	TACB1MB1 / TACCU8B1 für Ausrückgabel mit Nocken / for release fork with cams	(70)	
		 3189 600 004		Getr. / GBox: ZF AS Tronic Rollenausführung / roller version	(58)		
	AD 190S36, AT 190S36	05.07 -	F2BE3681A	 3400 700 365  3482 000 573  1878 004 133  3151 000 493	430 10 MFZ430 430WGTZ KZISZ-5	TACB15B3 / TACB18B3 / TACB19B3 / TACB1MB3 / TACCD7B3 / TACCD8B3 / TACCD9B3 / TACCU8B3 für Ausrückgabel mit Rollen / for release fork with rollers	(71)
				3400 700 378  3482 000 573  1878 004 133  3151 000 144	430 10 MFZ430 430WGTZ KZISZ-5	TACA17A3 / TACB16A3 / TACB17A3 / TACB18A3 / TACB19A3 / TACB1MA3 / TACCD9A3 / TACCDMA3 / TACCU8A3 für Ausrückgabel mit Nocken / for release fork with cams	(70)
			 3189 600 004		Getr. / GBox: ZF AS Tronic Rollenausführung / roller version	(58)	

IVECO













Stralis		02.02 -			
AD 190S40, AT 190S40	03.03-	F3AE0681	 3400 117 801  3482 083 032  1878 085 741  3151 000 144	430 10 MFZ430 430WGTZ KZISZ-5	Getr. / GBox: 12AS-2301DD MLLG1ME1 / MLLB15E1 / MLLB17E1 / MLLB18E1 / MLLB18F1 / MLLB1ME1 / MLLG15E1 / MLLG16E1 / MLLG17E1 / MLLG18E1 / NLLB15E1 / NLLB16E1 / NLLB17E1 / NLLB18E1 / NLLB19E1 / NLLB1ME1 / NLLCN8E1 / NLLCNLE1 / NLLG16E1 / NLLG16F1 / NLLG17E1 / NLLG18E1 / NLLG19E1 / NLLG1ME1 / NLLG1MF1 für Ausrückgabel mit Nocken / for release fork with cams (70)
			3400 117 801  3482 083 032  1878 085 741  3151 000 144	430 10 MFZ430 430WGTZ KZISZ-5	Getr. / GBox: 16S-181 MLLG1MA1 / MLLA14A1 / MLLA15A1 / MLLA15B1 / MLLA16B1 / MLLA17A1 / MLLB15A1 / MLLB16A1 / MLLB17A1 / MLLB18A1 / MLLB1MA1 / MLLG15A1 / MLLA19A1 / NLLB15A1 / NLLB17A1 / NLLB18A1 / NLLB18B1 / NLLB19A1 / NLLB1MA1 / NLLCN8B1 / NLLCNLA1 / NLLCNLB1 / NLLG15A1 / NLLG17A1 / NLLG18A1 / NLLG19A1 / NLLG1MB1 für Ausrückgabel mit Nocken / for release fork with cams (70)
			3400 700 435  3482 083 032  1878 085 741  3151 000 493	430 10 MFZ430 430WGTZ KZISZ-5	Getr. / GBox: 12AS-2301DD MLLG1ME1 / MLLB15E1 / MLLB17E1 / MLLB18E1 / MLLB18F1 / MLLB1ME1 / MLLG15E1 / MLLG16E1 / MLLG17E1 / MLLG18E1 / NLLB15E1 / NLLB16E1 / NLLB17E1 / NLLB18E1 / NLLB19E1 / NLLB1ME1 / NLLCN8E1 / NLLCNLE1 / NLLG16E1 / NLLG16F1 / NLLG17E1 / NLLG18E1 / NLLG19E1 / NLLG1ME1 / NLLG1MF1 für Ausrückgabel mit Rollen / for release fork with rollers (71)
			3400 700 435  3482 083 032  1878 085 741  3151 000 493	430 10 MFZ430 430WGTZ KZISZ-5	Getr. / GBox: 16S-181 MLLG1MA1 / MLLA14A1 / MLLA15A1 / MLLA15B1 / MLLA16B1 / MLLA17A1 / MLLB15A1 / MLLB16A1 / MLLB17A1 / MLLB18A1 / MLLB1MA1 / MLLG15A1 / MLLA19A1 / NLLB15A1 / NLLB17A1 / NLLB18A1 / NLLB18B1 / NLLB19A1 / NLLB1MA1 / NLLCN8B1 / NLLCNLA1 / NLLCNLB1 / NLLG15A1 / NLLG17A1 / NLLG18A1 / NLLG19A1 / NLLG1MB1 für Ausrückgabel mit Rollen / for release fork with rollers (71)
		F3AE0681B, F3AE0681H	 3189 600 004		Getr. / GBox: ZF AS Tronic Rollenausführung / roller version (58)
AD 190S42, AT 190S42, AS 190S42	07.06-	F3AE3681	 3400 700 365  3482 000 573  1878 004 133  3151 000 493	430 10 MFZ430 430WGTZ KZISZ-5	Getr. / GBox: 12AS-1930TD TFDB16B1 / TFDCD7B1 / TFDCNLB1 für Ausrückgabel mit Rollen / for release fork with rollers (71)
			 3482 000 573	430 MFZ430	Getr. / GBox: 12AS-1930TD TFDB13B1 / TFDB16B1 / TFDCD7B1 / TFDCNLB1 / TFDCU8B1
			 1878 004 133	430 10 430WGTZ	Getr. / GBox: 12AS-1930TD TFDB13B1 / TFDB16B1 / TFDCD7B1 / TFDCNLB1 / TFDCU8B1
			 3151 000 144	KZISZ-5	Getr. / GBox: 12AS-1930TD TFDB13B1 / TFDB16B1 / TFDCD7B1 / TFDCNLB1 / TFDCU8B1 für Ausrückgabel mit Nocken / for release fork with cams (70)
		F3AE3681	 3400 700 395  3482 000 573  1878 004 581  3151 000 493	430 10 MFZ430 430WGTZ KZISZ-5	Getr. / GBox: 16S-1920TD TFDB1MA3 / TFDB18A3 / TFDCDMA3 / TFDCD9A3 / TFDCN8A3 / TFDCU8A3 / ZADCL8A3 / ZADCU8A3
		F3AE3681D, F3AE3681B	 3189 600 004		Getr. / GBox: ZF AS Tronic Rollenausführung / roller version (58)
AD 190S42, AT 190S42, AS 190S42	01.13-	Cursor11	 3400 700 366  3482 000 572  1878 004 132  3151 000 493	430 10 MFZ430 430WGTZ KZISZ-5	Getr. / GBox: 16 S 1920 TD Getr. / GBox: 16 S 2220 TO Getr. / GBox: 12 AS 1930 TD Getr. / GBox: 12 AS 2330 TD Getr. / GBox: 12 AS 2330 TO Euro 6 / Euro 6 für Ausrückgabel mit Rollen / for release fork with rollers (18)
AD 260S42, AT 260S42	01.13-				
AD 260S42, AT 260S42, AS 260S42	01.13-				
AD 440S42, AT 440S42, AS 440S42	01.13-				
		F3GFE611D	 3189 600 004		Getr. / GBox: ZF AS Tronic Rollenausführung / roller version (58)

IVECO

Stralis		02.02 -			
AD 190S43, AT 190S43	06.03-	F3AE0681	3400 117 801 ⊕ 3482 083 032 ⊕ 1878 085 741 ⊕ 3151 000 144	430 10 MFZ430 430WGTZ KZISZ-5	Getr. / GBox: 12AS-2301DD MLKB15E1 / MLKB15EA / MLKB17E1 / MLKB18E1 / MLKB1ME1 / MLKG15E1 / MLKG16E1 / MLKG17E1 / MLKG18E1 / NLKB15E1 / NLKB15F1 / NLKB16E1 / NLKB17E1 / NLKB18E1 / NLKB18EA / NLKB18F1 / NLKB19E1 / NLKB19EA / NLKCN8E1 / NLKCNLE1 / NLKCNLEA / NLKCNLF1 / NLKG15E1 / NLKG17E1 / NLKG18E1 / NLKG1ME1 für Ausrückgabel mit Nocken / for release fork with cams (70)
			3400 117 801 ⊕ 3482 083 032 ⊕ 1878 085 741 ⊕ 3151 000 144	430 10 MFZ430 430WGTZ KZISZ-5	Getr. / GBox: 16S-181 MLKA14A1 / MLKA14B1 / MLKB15A1 / MLKB16A1 / MLKB17A1 / MLKB18A1 / MLKG17A1 / MLKG18A1 / MLKG19A1 / NLKA17A1 / NLKA17B1 / NLKB15A1 / NLKB15B1 / NLKB16A1 / NLKB17A1 / NLKB18A1 / NLKB18B1 / NLKB19A1 / NLKB1MA1 / NLKCN8A1 / NLKCN8B1 / NLKCNLA1 / NLKCNLB1 / NLKG15A1 / NLKG16A1 / NLKG17A1 / NLKG18A1 / NLKG19A1 für Ausrückgabel mit Nocken / for release fork with cams (70)
			3400 700 435 ⊕ 3482 083 032 ⊕ 1878 085 741 ⊕ 3151 000 493	430 10 MFZ430 430WGTZ KZISZ-5	Getr. / GBox: 12AS-2301DD MLKB15E1 / MLKB15EA / MLKB17E1 / MLKB18E1 / MLKB1ME1 / MLKG15E1 / MLKG16E1 / MLKG17E1 / MLKG18E1 / NLKB15E1 / NLKB15F1 / NLKB16E1 / NLKB17E1 / NLKB18E1 / NLKB18EA / NLKB18F1 / NLKB19E1 / NLKB19EA / NLKCN8E1 / NLKCNLE1 / NLKCNLEA / NLKCNLF1 / NLKG15E1 / NLKG17E1 / NLKG18E1 / NLKG1ME1 für Ausrückgabel mit Rollen / for release fork with rollers (71)
			3400 700 435 ⊕ 3482 083 032 ⊕ 1878 085 741 ⊕ 3151 000 493	430 10 MFZ430 430WGTZ KZISZ-5	Getr. / GBox: 16S-181 MLKA14A1 / MLKA14B1 / MLKB15A1 / MLKB16A1 / MLKB17A1 / MLKB18A1 / MLKG17A1 / MLKG18A1 / MLKG19A1 / NLKA17A1 / NLKA17B1 / NLKB15A1 / NLKB15B1 / NLKB16A1 / NLKB17A1 / NLKB18A1 / NLKB18B1 / NLKB19A1 / NLKB1MA1 / NLKCN8A1 / NLKCN8B1 / NLKCNLA1 / NLKCNLB1 / NLKG15A1 / NLKG16A1 / NLKG17A1 / NLKG18A1 / NLKG19A1 für Ausrückgabel mit Rollen / for release fork with rollers (71)
		F3AE0681D	3189 600 004		Getr. / GBox: ZF AS Tronic Rollenausführung / roller version (58)
AD 190S45, AT 190S45	12.06-	F3AE3681	3400 700 365 ⊕ 3482 000 573 ⊕ 1878 004 133 ⊕ 3151 000 493	430 10 MFZ430 430WGTZ KZISZ-5	Getr. / GBox: 12AS-2330TD QFECU8B1 / TFECDB1 / TFECNLB1 für Ausrückgabel mit Rollen / for release fork with rollers (71)
			3400 700 378 ⊕ 3482 000 573 ⊕ 1878 004 133 ⊕ 3151 000 144	430 10 MFZ430 430WGTZ KZISZ-5	Getr. / GBox: 12AS-2330TD QFECU8B1 / TFEB18BA / TFECDB1 / TFECDB1 / TFECNLB1 / TFECU8B1 für Ausrückgabel mit Nocken / for release fork with cams (70)
		F3AE3681A	3400 700 462	430 10	Getr. / GBox: ZF 16S-1920TD QFEA13A3 / QFEB138A3 / QFEB16A3 / QFEB18A3 / QFECU8A3 / QFEA14A1 / QFEB15A1 / QFECDB1 / ZAE17A3 / ZAE18A3 / ZAE1LA3 / ZAECL8A3 / ZAECU8A3 / ZAE15A1 / ZAE17A1 / ZAE1LA1 / ZAECLA1 / ZAECU8A1 / TFECU8A3 / TFEB19A3 / TFECDB1 / TFECN8A3 / TFECNL3 / TFEB17A1 / TFEB18A1 / TFECDB1 / TFECDB1 / TFECNL3 / TFECNL3 / TFECN8A1 Nabenprofil / Hub Profile: 41,25x52,1-10N (48)
			3189 600 004		Getr. / GBox: ZF AS Tronic Rollenausführung / roller version (58)
		F3AE3681	3400 700 395 ⊕ 3482 000 573 ⊕ 1878 004 581 ⊕ 3151 000 493	430 10 MFZ430 430WGTZ KZISZ-5	Getr. / GBox: 16S-2220TD TFEA17A3 / TFEB14A3 / TFEB16A3 / TFECDB1 / TFECDB1 / TFECDB1 / TFECNL3 / TFECNL3 / TFECU8A3 (71)
AD 190S46, AT 190S46, AS 190S46	01.13-	Cursor13	3400 700 366 ⊕ 3482 000 572 ⊕ 1878 004 132 ⊕ 3151 000 493	430 10 MFZ430 430WGTZ KZISZ-5	Getr. / GBox: 12 AS 2330 TD Getr. / GBox: 12 AS 2330 TO Getr. / GBox: 16 AS 2630 TO Euro 6 / Euro 6 für Ausrückgabel mit Rollen / for release fork with rollers (18) (71)
			F3AE3681Y	3189 600 004	









		CODE				
--	--	------	--	---	---	---

IVECO



























Stralis		02.02 -					
AD 190S46, AT 190S46, AS 190S46	01.13-	Cursor11		3400 700 366 Ⓢ 3482 000 572 Ⓢ 1878 004 132 Ⓢ 3151 000 493	430 10 MFZ430 430WGTZ KZISZ-5	Getr. / GBox: 16 S 2220 TD Getr. / GBox: 16 S 2220 TO Getr. / GBox: 12 AS 2330 TD Getr. / GBox: 12 AS 2330 TO Euro 6 / Euro 6 für Ausrückgabel mit Rollen / for release fork with rollers	(18) (71)
AD 260S46, AT 260S46, AS 260S46	01.13-						
AD 440S46, AT 440S46, AS 440S46	01.13-						
AT 440S46	01.13-	F3GFE611B		3189 600 004		Getr. / GBox: ZF AS Tronic Rollenausführung / roller version	(58)
AD 190S48, AT 190S48, AS 190S48	01.13-	F3GFE611A		3400 117 801 Ⓢ 3482 083 032 Ⓢ 1878 085 741 Ⓢ 3151 000 144	430 10 MFZ430 430WGTZ KZISZ-5	Getr. / GBox: 16S, 12AS AS 190S48 für Ausrückgabel mit Nocken / for release fork with cams	(70)
				3400 700 435 Ⓢ 3482 083 032 Ⓢ 1878 085 741 Ⓢ 3151 000 493	430 10 MFZ430 430WGTZ KZISZ-5	Getr. / GBox: 16S, 12AS AS 190S48 für Ausrückgabel mit Rollen / for release fork with rollers	(71)
				3189 600 004		Getr. / GBox: ZF AS Tronic Rollenausführung / roller version	(58)
AD 260S27 CNG, AT 260S27 CNG	01.08-	F2BE0641		3400 700 378 Ⓢ 3482 000 573 Ⓢ 1878 004 133 Ⓢ 3151 000 144	430 10 MFZ430 430WGTZ KZISZ-5	Getr. / GBox: 16S AD 260S27 CNG für Ausrückgabel mit Nocken / for release fork with cams	(70)
				3400 107 031 Ⓢ 3482 078 134 Ⓢ 1862 317 031 Ⓢ 3151 000 144	400 10 MFZ400 400GVZ KZISZ-5	Getr. / GBox: 3200R AD 260S27 CNG	
AD 260S27, AT 260S27	04.04-	F2BE0681F		3400 107 031 Ⓢ 3482 078 134 Ⓢ 1862 317 031 Ⓢ 3151 000 144	400 10 MFZ400 400GVZ KZISZ-5	Getr. / GBox: 9S, 16S	
AD 260S35	04.04-	F2BE0681A		3400 084 031 Ⓢ 3482 078 134 Ⓢ 1878 032 032 Ⓢ 3151 000 144	400 10 MFZ400 400WGTZ KZISZ-5	Getr. / GBox: 16S-109,12AS-2301 DD	
AD 260S35, AT 260S35, AD 260S36, AT 260S36	06.03-	F2BE3681A, F2BE0681A		3400 700 378 Ⓢ 3482 000 573 Ⓢ 1878 004 133 Ⓢ 3151 000 144	430 10 MFZ430 430WGTZ KZISZ-5	Getr. / GBox: 16S 109 für Ausrückgabel mit Nocken / for release fork with cams	(70)
AD 260S36, AT 260S36	07.07-	F2BE3681A		3400 700 365 Ⓢ 3482 000 573 Ⓢ 1878 004 133 Ⓢ 3151 000 493	430 10 MFZ430 430WGTZ KZISZ-5	Getr. / GBox: 12AS 2301 DD für Ausrückgabel mit Rollen / for release fork with rollers	(71)
				3400 700 378 Ⓢ 3482 000 573 Ⓢ 1878 004 133 Ⓢ 3151 000 144	430 10 MFZ430 430WGTZ KZISZ-5	Getr. / GBox: 12AS 2301 DD für Ausrückgabel mit Nocken / for release fork with cams	(70)
				3189 600 004		Getr. / GBox: ZF AS Tronic Rollenausführung / roller version	(58)
AD 260S40, AT 260S40	06.03-	F3AE0681B, F3AE0681H		3400 117 801 Ⓢ 3482 083 032 Ⓢ 1878 085 741 Ⓢ 3151 000 144	430 10 MFZ430 430WGTZ KZISZ-5	Getr. / GBox: 12AS / 16S 109 für Ausrückgabel mit Nocken / for release fork with cams	(70)
				3400 700 435 Ⓢ 3482 083 032 Ⓢ 1878 085 741 Ⓢ 3151 000 493	430 10 MFZ430 430WGTZ KZISZ-5	Getr. / GBox: 12AS / 16S 109 für Ausrückgabel mit Rollen / for release fork with rollers	(71)
				3189 600 004		Getr. / GBox: ZF AS Tronic Rollenausführung / roller version	(58)

		CODE				
--	--	------	--	---	---	---

IVECO

Stralis		02.02 -					
AD 260S42, AT 260S42	12.06 -	F3AE3681B	 3400 700 462 ■	430 10	Getr. / GBox: ZF16S-1920TD ZDDCL6A1 / ZDDCU5A1 / ZDDCU6A1 / ZDDE16A1 / ZDDFL7A1 / ZDDE18A1 / ZDDE19A1 / ZDDFU5A1 / ZCDB19A1 / ZDDFU6A1 / ZDDFU9A1 / ZDDB15A1 / ZDDB16A1 / QKDFD4A1 / QKDFD5A1 / QKDFD6A1 / QKDFD7A1 / QKDFD8A1 / QKDFU4A1 / QKDFU5A1 / QKDFU6A1 / QKDE15A1 / QKDE17A1 / QKDE17AA / QKDE19A1 / QKDE14A1 / QHDA14A1 / QHDB14A1 / QHDB16A1 / QHDB17A1 / QKDB14A1 / QKDB15A1 / QKDB16A1 / QKDCU6A1 / QKDE16A1 / THDB15A1 / THDB18A1 / THDB19A1 / TKDB14A1 / TKDB15A1 / TKDB16A1 / TKDB17A1 / TKDB18A1 / TKDB19A1 / TKDCD4A1 TKDCU6A1 / TKDE18A1 / TKDE14A1 / TKDE15A1 / TKDE16A1 / TKDE17A1 / TKDE13A1 / TKFD4A1 / TKFD5A1 / TKFD6A1 / TKFD7A1 / TKFD8A1 / TKFD9A1 / TKDFU5A1 / TKDFU6A1 / TKDFU8A1 / TKDFU9A1 / THDB14A1 Nabensprofil / Hub Profile: 41,25x52,1-10N	(48)	
			 3189 600 004		Getr. / GBox: ZF AS Tronic Rollenausführung / roller version	(58)	
		F3AE3681	 3400 700 395 ● 3482 000 573 ● 1878 004 581 ● 3151 000 493	430 10 MFZ430 430WGTZ KZISZ-5	Getr. / GBox: 16S-1920TD QKDB16A3 / QKDB17A3 / QKDB18A3 / QKDCD8A3 / QKDCU6A3 / QKDE13A3 / QKDE16A3 / QKDE18A3 / QKDE19A3 / QKDFD3A3 / QKDFD4A3 / QKDFD5A3 / QKDFD7A3 / QKDFD9A3 / QKDFU4A3 / QKDFU5A3 / QKDFU7A3 / ZCDB17A3 / ZDDCU6A3 / ZDDE16A3 / ZDDE18A3 / ZDDE19A3 / ZDDFU4A3 / ZDDFU6A3 / ZDDFU9A3		
AD 260S42, AT 260S42	12.06 -	F3AE3681B	 3400 700 365 ● 3482 000 573 ● 1878 004 133 ● 3151 000 493	430 10 MFZ430 430WGTZ KZISZ-5	Getr. / GBox: 16S 109 AD 260S42 E4 für Ausrückgabel mit Rollen / for release fork with rollers	(71)	
				 3400 700 462 ■	430 10	Getr. / GBox: 16S 109 AT 260S42 Nabensprofil / Hub Profile: 41,25x52,1-10N	(48)
				 3400 700 378 ● 3482 000 573 ● 1878 004 133 ● 3151 000 144	430 10 MFZ430 430WGTZ KZISZ-5	Getr. / GBox: 12 AS, 16S 109 AT 260S42 / AD 260S42 E4 für Ausrückgabel mit Nocken / for release fork with cams	(70)
AD 260S42, AT 260S42, AS 260S42	05.07 -	F3AE3681B	 3400 700 462 ■	430 10	Getr. / GBox: ZF16S-1920TD THDB14A3 / THDB15A3 / THDB17A3 / THDB18A3 / TKDB16A3 / TKDB17A3 / TKDB19A3 / TKDCU6A3 / TKDE18A3 / TKDFU9A3 / TKDE19A3 / TKDFD9A3 / TKDE17A3 / TKDE16A3 / TKDFD4A3 / TKDFD5A3 / TKDFD6A3 / TKDFD8A3 / TKDE14A3 / TKDE15A3 / TKDFU5A3 / TKDFU8A3 / ZDDCU6A3 / ZDDFL6A3 / ZDDE18A3 / ZDDE14A3 / ZDDE15A3 / ZDDE16A3 / ZDDE19A3 / ZDDFU6A3 / ZDDFU8A3 / ZDDFU9A3 / ZDDE17A3 / ZDDB15A3 / ZDDB16A3 / ZDDB17A3 / TUPB15A3 / QKDFD5A3 / QKDFD6A3 / QKDFU5A3 / QKDFU9A3 / QKDE14A3 / QKDE17A3 / QKDE18A3 / QKDE13A3 QHDA15A3 / QHDA16A3 / QHDB14A3 / QHDB15A3 / QHDB17A3 / QHDB18A3 / QKDB14A3 / QKDB15A3 / QKDB17A3 / QKDCU6A3 / QKDE15A3 / QKDE16A3 Nabensprofil / Hub Profile: 41,25x52,1-10N	(48)	
				 3189 600 004		Getr. / GBox: ZF AS Tronic Rollenausführung / roller version	(58)
		F3AE3681	 3400 700 395 ● 3482 000 573 ● 1878 004 581 ● 3151 000 493	430 10 MFZ430 430WGTZ KZISZ-5	Getr. / GBox: 16S-1920TD QKDB16A3 / QKDB17A3 / QKDB18A3 / QKDCD8A3 / QKDCU6A3 / QKDE13A3 / QKDE16A3 / QKDE18A3 / QKDE19A3 / QKDFD3A3 / QKDFD4A3 / QKDFD5A3 / QKDFD7A3 / QKDFD9A3 / QKDFU4A3 / QKDFU5A3 / QKDFU7A3 / ZCDB17A3 / ZDDCU6A3 / ZDDE16A3 / ZDDE18A3 / ZDDE19A3 / ZDDFU4A3 / ZDDFU6A3 / ZDDFU9A3		

IVECO

Stralis		02.02 -					
AD 260S43, AT 260S43	06.03-	F3AE0681D		3400 117 801  3482 083 032  1878 085 741  3151 000 144	430 10 MFZ430 430WGTZ KZISZ-5	Getr. / GBox: 16S 181 Getr. / GBox: 12AS 2301 DD für Ausrückgabel mit Nocken / for release fork with cams	(70)
				3400 700 435  3482 083 032  1878 085 741  3151 000 493	430 10 MFZ430 430WGTZ KZISZ-5	Getr. / GBox: 16S 181 Getr. / GBox: 12AS 2301 DD für Ausrückgabel mit Rollen / for release fork with rollers	(71)
				3400 700 462	430 10	Getr. / GBox: ZF 16S-1920TD QUQB14A3 / ZUQCL6A3 / TUQB15A3 Nabensprofil / Hub Profile: 41,25x52,1-10N	(48)
				3189 600 004		Getr. / GBox: ZF AS Tronic Rollenausführung / roller version	(58)
AD 260S45, AT 260S45	12.06 -	F3AE3681A		3400 700 462	430 10	Getr. / GBox: ZF 16S-1920TD ZDEFU7A1 / ZDEFU8A1 / ZDEFU9A1 / ZDEE15A1 / ZDEB16A1 / ZDEB17A1 / ZDECL6A1 / ZDECL7A1 / ZDECU5A1 / ZDECU6A1 / ZDEE14A1 / ZCEB17A1 / ZDEE16A1 / ZDEE17A1 / ZDEE18A1 / ZDEE19A1 / ZDEFL7A1 / ZDEFU4A1 / ZDEFU5A1 / ZDEFU6A1 / QKEE16A1 / QKEE17A1 / QKEE18A1 / QKEE19A1 / QKEFD3A1 / QKEFD4A1 / QKEFD5A1 / QKEFD8A1 / QKEFU4A1 / QKEFU5A1 / QKEE14A1 / QKEB15A1 / QKEB16A1 / QKEE13A1 / QKEE15A1 / QHEB16A1 / QHEB17A1 / QKEFU6A1 / QKEFU8A1 / TKEE15A1 / TKEE16A1 / TKEE17A1 / THEA18A1 / THEB14A1 / THEB16A1 THEB17A1 / THEB18A1 / TKEB16A1 / TKEB17A1 / TKEB19A1 / TKECD7A1 / TKECU6A1 / TKEE13A1 / TKEE14A1 / TKEFD8A1 / TKEFD9A1 / TKEFU4A1 / TKEFU5A1 / TKEFU6A1 / TKEFU7A1 / TKEFU8A1 / TKEFU9A1 / TKEE18A1 / TKEE19A1 / TKEFD4A1 / TKEFD5A1 / TKEFD6A1 Nabensprofil / Hub Profile: 41,25x52,1-10N	(48)
				3189 600 004		Getr. / GBox: ZF AS Tronic Rollenausführung / roller version	(58)
		F3AE3681		3400 700 395  3482 000 573  1878 004 581  3151 000 493	430 10 MFZ430 430WGTZ KZISZ-5	Getr. / GBox: 16S-1920TD ZDEFU5A3	
				3400 700 395  3482 000 573  1878 004 581  3151 000 493	430 10 MFZ430 430WGTZ KZISZ-5	Getr. / GBox: 16S-2220TD QKEB16A3 / QKEE13AC / QKEE13A3 / QKEE14AC / QKEE14A3 / QKEE16A3 / QKEE17A3 / QKEE18A3 / QKEFD3A3 / QKEFD4A3 / QKEFD5A3 / QKEFD6A3 / QKEFD8A3 / QKEFU4A3 / QKEFU5A3 / QKEFU6A3 / TKEE15A3 / TKEE16A3 / TKEE17A3 / TKEE19A3 / TKEFD4A3 / TKEFD5A3 / TKEFD8A3 / TKEFU4A3 / TKEFU5A3 / TKEFU6A3 / TKEFU9A3 / ZDECL5A3 / ZDECL6A3 / ZDECU5A3 / ZDECU6A3 / ZDEE14A3 / ZDEE15A3 / ZDEE16A3 / ZDEE18A3 / ZDEE19A3 / ZDEFU4A3 / ZDEFU6A3 / ZDEFU8A3 / ZDEFU9A3	
AD 260S45, AT 260S45, AS 260S45	05.07 -	F3AE3681A		3400 700 462	430 10	Getr. / GBox: ZF 16S-1920TD TKEE14A3 / TKEE15A3 / TKEE16A3 / THEB16A3 / TKEB13A3 / TKEB14A3 / TKEB16A3 / TKEB17A3 / TKEB18A3 / TKECU6A3 / TKEE13A3 / TKEFD9A3 / TKEFU4A3 / TKEFU5A3 / TKEFU6A3 / TKEFU7A3 / TKEE17A3 / TKEE18A3 / TKEE19A3 / TKEFD4A3 / TKEFD6A3 / TKEFD7A3 / ZDEFU7A3 / ZDEFU8A3 / ZDEFU9A3 / ZDEE14A3 / ZDEB14A3 / ZDEB16A3 / ZDEB17A3 / ZDECL5A3 / ZDECL6A3 / ZDECL7A3 / ZDECU4A3 / ZDECU5A3 / ZDECU6A3 / ZCEB19A3 / ZDEE15A3 / ZDEE16A3 / ZDEE17A3 / ZDEE18A3 / ZDEE19A3 / ZDEFU4A3 / ZDEFU5A3 / ZDEFU6A3 / QKEE16A3 QKEE16AC / QKEE17A3 / QKEE18A3 / QKEE19A3 / QKEFD3A3 / QKEFD4A3 / QKEFD6A3 / QKEFU5A3 / QKEE13A3 / QKEB14A3 / QKEB15A3 / QKEB16A3 / QKEE14A3 / QKEE15A3 Nabensprofil / Hub Profile: 41,25x52,1-10N	(48)
				3189 600 004		Getr. / GBox: ZF AS Tronic Rollenausführung / roller version	(58)
		F3AE3681		3400 700 395  3482 000 573  1878 004 581  3151 000 493	430 10 MFZ430 430WGTZ KZISZ-5	Getr. / GBox: 16S-1920TD ZDEFU5A3	
				3400 700 395	430 10	Getr. / GBox: 16S-2220TD QKEB16A3 / QKEE13AC / QKEE13A3 /	









IVECO

Stralis		02.02 -					
AD 260S48, AT 260S48, AS 260S48	01.13-	F3GFE611A		3400 117 801 3482 083 032 1878 085 741 3151 000 144	430 10 MFZ430 430WGTZ KZISZ-5	Getr. / GBox: 12AS/16AS/16S AS 260S48 für Ausrückgabel mit Nocken / for release fork with cams	(70)
				3400 700 366 3482 000 572 1878 004 132 3151 000 493	430 10 MFZ430 430WGTZ KZISZ-5	Getr. / GBox: 12AS 2330 TD Getr. / GBox: 16S 2220TD AD 260S48 für Ausrückgabel mit Rollen / for release fork with rollers	(71)
				3400 700 378 3482 000 573 1878 004 133 3151 000 144	430 10 MFZ430 430WGTZ KZISZ-5	Getr. / GBox: 12AS 2601 DD AT 260S48 für Ausrückgabel mit Nocken / for release fork with cams	(70)
				3400 700 435 3482 083 032 1878 085 741 3151 000 493	430 10 MFZ430 430WGTZ KZISZ-5	Getr. / GBox: 12AS/16AS/16S AS 260S48 für Ausrückgabel mit Rollen / for release fork with rollers	(71)
				3189 600 004 		Getr. / GBox: ZF AS Tronic Rollenausführung / roller version	(58)
AD 320S36	01.13-	F2BE3681A		3400 700 365 3482 000 573 1878 004 133 3151 000 493	430 10 MFZ430 430WGTZ KZISZ-5	Getr. / GBox: 12AS für Ausrückgabel mit Rollen / for release fork with rollers	(71)
				3400 700 378 3482 000 573 1878 004 133 3151 000 144	430 10 MFZ430 430WGTZ KZISZ-5	Getr. / GBox: 12AS für Ausrückgabel mit Nocken / for release fork with cams	(70)
				3189 600 004 		Getr. / GBox: ZF AS Tronic Rollenausführung / roller version	(58)
AD 320S42, AT 320S42	05.07-	F3AE3681D		3400 700 365 3482 000 573 1878 004 133 3151 000 493	430 10 MFZ430 430WGTZ KZISZ-5	Getr. / GBox: 12AS AD 320S42 / AT 320S42 für Ausrückgabel mit Rollen / for release fork with rollers	(71)
				3400 700 469 3482 000 573 1878 004 582 3151 000 493	430 10 MFZ430 430WGTZ KZISZ-5	Getr. / GBox: 16S AD 320S42	
				3400 700 462	430 10	Getr. / GBox: 16S AT 320S42 Nablenprofil / Hub Profile: 41,25x52,1-10N	(48)
				3400 700 378 3482 000 573 1878 004 133 3151 000 144	430 10 MFZ430 430WGTZ KZISZ-5	Getr. / GBox: 12AS AD 320S42 / AT 320S42 für Ausrückgabel mit Nocken / for release fork with cams	(70)
AD 320S45, AT 320S45, AD 320S46, AT320S46	05.07-	F3AE3681A		3400 700 365 3482 000 573 1878 004 133 3151 000 493	430 10 MFZ430 430WGTZ KZISZ-5	Getr. / GBox: 12AS AD 320S45 für Ausrückgabel mit Rollen / for release fork with rollers	(71)
				3400 700 365 3482 000 573 1878 004 133 3151 000 493	430 10 MFZ430 430WGTZ KZISZ-5	Getr. / GBox: 12AS / 16AS AT 320S45 für Ausrückgabel mit Rollen / for release fork with rollers	(71)
				3400 700 365 3482 000 573 1878 004 133 3151 000 493	430 10 MFZ430 430WGTZ KZISZ-5	AD 320S46 / AT 320S46 für Ausrückgabel mit Rollen / for release fork with rollers	(71)
				3400 700 469 3482 000 573 1878 004 582 3151 000 493	430 10 MFZ430 430WGTZ KZISZ-5	Getr. / GBox: 16S AD 320S45	
				3400 700 378 3482 000 573 1878 004 133 3151 000 144	430 10 MFZ430 430WGTZ KZISZ-5	Getr. / GBox: 12AS / 16AS AT 320S45 für Ausrückgabel mit Nocken / for release fork with cams	(70)
				3400 700 378 3482 000 573 1878 004 133 3151 000 144	430 10 MFZ430 430WGTZ KZISZ-5	AD 320S46 / AT 320S46 für Ausrückgabel mit Nocken / for release fork with cams	(70)
				3400 700 378 3482 000 573 1878 004 133 3151 000 144	430 10 MFZ430 430WGTZ KZISZ-5	Getr. / GBox: 12AS AD 320S45 für Ausrückgabel mit Nocken / for release fork with cams	(70)
				3400 107 031 3482 078 134 1862 317 031 3151 000 144	400 10 MFZ400 400GVZ KZISZ-5	Getr. / GBox: 9S / 16S / 12AS	















		CODE				
--	--	------	--	---	---	---

IVECO

Stralis		02.02 -					
AD 440S33, AT 440S33	12.06-	F2BE3681B		3400 700 365 ⊕ 3482 000 573 ⊕ 1878 004 133 ⊕ 3151 000 493	430 10 MFZ430 430WGTZ KZISZ-5	Getr. / GBox: 12AS AD 440S33 für Ausrückgabel mit Rollen / for release fork with rollers	(71)
				3400 700 378 ⊕ 3482 000 573 ⊕ 1878 004 133 ⊕ 3151 000 144	430 10 MFZ430 430WGTZ KZISZ-5	Getr. / GBox: 12AS AD 440S33 für Ausrückgabel mit Nocken / for release fork with cams	(70)
				3400 700 378 ⊕ 3482 000 573 ⊕ 1878 004 133 ⊕ 3151 000 144	430 10 MFZ430 430WGTZ KZISZ-5	Getr. / GBox: 12AS / 16S AT 440S33 für Ausrückgabel mit Nocken / for release fork with cams	(70)
				3400 700 378 ⊕ 3482 000 573 ⊕ 1878 004 133 ⊕ 3151 000 144	430 10 MFZ430 430WGTZ KZISZ-5	Getr. / GBox: 16S AD 440S33 für Ausrückgabel mit Nocken / for release fork with cams	(70)
AD 440S35, AT 440S35, AD 440S36, AT 440S36	06.03-	F2BE3681A, F2BE0681A		3400 084 031 ⊕ 3482 078 134 ⊕ 1878 032 032 ⊕ 3151 000 144	400 10 MFZ400 400WGTZ KZISZ-5	Getr. / GBox: 12AS / 16S AD 440S35 / AT 440S35	
				3400 700 378 ⊕ 3482 000 573 ⊕ 1878 004 133 ⊕ 3151 000 144	430 10 MFZ430 430WGTZ KZISZ-5	Getr. / GBox: 12AS / 16S AT 440S36 für Ausrückgabel mit Nocken / for release fork with cams	(70)
				3400 700 378 ⊕ 3482 000 573 ⊕ 1878 004 133 ⊕ 3151 000 144	430 10 MFZ430 430WGTZ KZISZ-5	Getr. / GBox: 9S AD 440S36 für Ausrückgabel mit Nocken / for release fork with cams	(70)
				3400 107 031 ⊕ 3482 078 134 ⊕ 1862 317 031 ⊕ 3151 000 144	400 10 MFZ400 400GVZ KZISZ-5	Getr. / GBox: 12AS / 16S AD 440S36	
AD 440S40, AT 440S40 AS 190S43	03.03- 02.02-	F3AE0681B, F3AE0681H, F3AE0681D		3400 117 801 ⊕ 3482 083 032 ⊕ 1878 085 741 ⊕ 3151 000 144	430 10 MFZ430 430WGTZ KZISZ-5	Getr. / GBox: 12AS 2301 DD Getr. / GBox: 16 S 181 für Ausrückgabel mit Nocken / for release fork with cams	(70)
				3400 700 435 ⊕ 3482 083 032 ⊕ 1878 085 741 ⊕ 3151 000 493	430 10 MFZ430 430WGTZ KZISZ-5	Getr. / GBox: 12AS 2301 DD Getr. / GBox: 16 S 181 für Ausrückgabel mit Rollen / for release fork with rollers	(71)
				3189 600 004		Getr. / GBox: ZF AS Tronic Rollenausführung / roller version	(58)
AD 440S42, AT 440S42 AS 440S42, AT 440S42	04.06- 12.06-	F3AE3681D, F3AE3681B		3400 700 462	430 10	Getr. / GBox: ZF 16S-1920TD QGDB21A1 / QGDB23A1 / QGDE21A2 / ZEDB21A1 / ZBDB21A1 / ZBDCT1A1 / TGDB21A1 / TMD21A1 / TGDB23A1 / TGDBH1AA / TGDBH3A1 / TGDCM3A1 / TGDCM3A1 / TGDCM3A1 / TGDCM3A1 / TMD21A3 / TGDB21A3 / TGDB23A3 / TGDBH3A3 / TGDCM3A3 / TGDCM3A3 / TGDCM3A3 / ZEDB21A3 / ZBDB23A3 / ZBDB21A3 / ZBDBH3A3 / ZBDCT1A3 / QGDB21A3 / QGDB23A3 / QGDE21A4 / QGDE23A4 Nabenprofil / Hub Profile: 41,25x52,1-10N	(48)
				3189 600 004		Getr. / GBox: ZF AS Tronic Rollenausführung / roller version	(58)
		F3AE3681		3400 700 395 ⊕ 3482 000 573 ⊕ 1878 004 581 ⊕ 3151 000 493	430 10 MFZ430 430WGTZ KZISZ-5	Getr. / GBox: 16S-1920TD TGDBH3A3 / TGDB21AC / TGDB21A3 / TGDB23A3 / TGDCM3A3	
AD 440S42, AT 440S42, AS 440S42	01.13-	F3GFE611D		3400 117 801 ⊕ 3482 083 032 ⊕ 1878 085 741 ⊕ 3151 000 144	430 10 MFZ430 430WGTZ KZISZ-5	Getr. / GBox: 12AS 1930 TD Getr. / GBox: 16 S 1920 TD für Ausrückgabel mit Nocken / for release fork with cams	(70)
				3400 700 435 ⊕ 3482 083 032 ⊕ 1878 085 741 ⊕ 3151 000 493	430 10 MFZ430 430WGTZ KZISZ-5	Getr. / GBox: 12AS 1930 TD Getr. / GBox: 16 S 1920 TD für Ausrückgabel mit Rollen / for release fork with rollers	(71)
				3189 600 004		Getr. / GBox: ZF AS Tronic Rollenausführung / roller version	(58)
AD 440S43, AT 440S43 AT 440S43	06.03- 06.03-	F3AE0681D		3400 700 462	430 10	Getr. / GBox: ZF 16S-1920TD ZTQB23A3 / TSQB21A3 / TSQB23A3 / TSQBH3A3 / TSQCT1A3 / TSQE21A4 / TSQE23A4 Nabenprofil / Hub Profile: 41,25x52,1-10N	(48)



















		CODE				
--	--	------	--	---	---	---

IVECO

Stralis		02.02 -	
AD 440S45, AT 440S45 AS 440S45	12.06- 12.06-	F3AE3681A	 3400 700 462  430 10 Getr. / GBox: ZF16S-1920TD TMEB21A3 / TMEB21AC / TGECT1A3 / TGEB21A3 / TGECM3A3A / TJEBH2A3 / TJEBH2AC / TGEB23A3 / TGEB23AC / TGEBH3A3 / TGEE21A4 / ZBEB23A3 / ZBEB24AC / ZEEB21A3 / ZEEB21AC / ZBECT1A3 / ZBEB21A3 / ZBEBH1A3 / ZBEBH3A3 / QGEB21A3 / QGEB23A3 / QGEBH1A3 / QGEE21A4 / TMEB21A1 / TMEB21AA / TGECT1A1 / TGEB21A1 / TJEBH1A1 / TJEBH2AA / TGEB23AA / TGEB23A1 / TGEBH3A1 / TGECM3A1 / TGEE21A2 / TGEE23A2 / ZBEB21A1 / ZBEB23AA / ZEEB21A1 / ZEEB21AA / ZBEE23A2 / ZBEB23A1 / ZBEBH3A1 / ZBECT1A1 / QGEB23A1 / QGEB21A1 QGEE21A2 / QGEE23A2 Nabenprofil / Hub Profile: 41,25x52,1-10N (48)
			 3189 600 004 Getr. / GBox: ZF AS Tronic Rollenausführung / roller version (58)
		F3AE3681	 3400 700 395 ⊙ 3482 000 573 ⊙ 1878 004 581 ⬢ 3151 000 493 430 10 MFZ430 430WGTZ KZISZ-5 Getr. / GBox: 16S-2220TD TGEBH3A3 / TGEB21A3 / TGEB23A3 / TGECM3A3 / TGECT1A3 / TMEB21A3
			 3400 700 395 ⊙ 3482 000 573 ⊙ 1878 004 581 ⬢ 3151 000 493 430 10 MFZ430 430WGTZ KZISZ-5 Getr. / GBox: 16S-2220TO TGEE21A4 / TGEE23A4
AD 440S48, AT 440S48, AS 440S48 AT 440S48	01.13- 01.13-	Cursor13	 3400 700 366 ⊙ 3482 000 572 ⊙ 1878 004 132 ⬢ 3151 000 493 430 10 MFZ430 430WGTZ KZISZ-5 Getr. / GBox: 16 S 2220 TO Euro 6 / Euro 6 für Ausrückgabel mit Rollen / for release fork with rollers (18) (71)
		F3GFE611A	 3189 600 004 Getr. / GBox: ZF AS Tronic Rollenausführung / roller version (58)
AS 190S40	02.02-	F3AE0681	 3400 117 801 ⊙ 3482 083 032 ⊙ 1878 085 741 ⬢ 3151 000 144 430 10 MFZ430 430WGTZ KZISZ-5 Getr. / GBox: 12AS-2301DD LDLB15E1 / LDLB17E1 / LDLB18E1 / LDLB19E1 / LDLC18E1 / LDLC17E1 / LDLC18E1 für Ausrückgabel mit Nocken / for release fork with cams (70)
			 3400 117 801 ⊙ 3482 083 032 ⊙ 1878 085 741 ⬢ 3151 000 144 430 10 MFZ430 430WGTZ KZISZ-5 Getr. / GBox: 16S-181 LDLB15A1 / LDLB17A1 / LDLB18A1 / LDLB19A1 / LDLC18A1 / LDLC17A1 / LDLC18A1 für Ausrückgabel mit Nocken / for release fork with cams (70)
			 3400 700 435 ⊙ 3482 083 032 ⊙ 1878 085 741 ⬢ 3151 000 493 430 10 MFZ430 430WGTZ KZISZ-5 Getr. / GBox: 12AS-2301DD LDLB15E1 / LDLB17E1 / LDLB18E1 / LDLB19E1 / LDLC18E1 / LDLC17E1 / LDLC18E1 für Ausrückgabel mit Rollen / for release fork with rollers (71)
			 3400 700 435 ⊙ 3482 083 032 ⊙ 1878 085 741 ⬢ 3151 000 493 430 10 MFZ430 430WGTZ KZISZ-5 Getr. / GBox: 16S-181 LDLB15A1 / LDLB17A1 / LDLB18A1 / LDLB19A1 / LDLC18A1 / LDLC17A1 / LDLC18A1 für Ausrückgabel mit Rollen / for release fork with rollers (71)
			 3189 600 004 Getr. / GBox: ZF AS Tronic Rollenausführung / roller version (58)
AS 190S45	12.06-	F3AE3681	 3400 700 395 ⊙ 3482 000 573 ⊙ 1878 004 581 ⬢ 3151 000 493 430 10 MFZ430 430WGTZ KZISZ-5 Getr. / GBox: 16S-2220TD ZAEB17A3 / ZAECU8A3
		F3AE3681A	 3189 600 004 Getr. / GBox: ZF AS Tronic Rollenausführung / roller version (58)











































		CODE				
--	--	------	--	---	---	---

IVECO

Stralis		02.02 -				
AS 190S48	02.02-	F3BE0681		3400 117 801 3482 083 032 1878 085 741 3151 000 144	430 10 MFZ430 430WGTZ KZISZ-5	Getr. / GBox: 12AS-2330TD LKPB15M1 / LKPC18M1 / LKPCL7M1 für Ausrückgabel mit Nocken / for release fork with cams (70)
				3400 117 801 3482 083 032 1878 085 741 3151 000 144	430 10 MFZ430 430WGTZ KZISZ-5	Getr. / GBox: 16AS-2601DD LKPB17E1 / LKPB18E1 / LKPB19E1 / LKPB19F1 / LKPC18E1 / LKPCL7E1 / LKPCL8E1 für Ausrückgabel mit Nocken / for release fork with cams (70)
				3400 117 801 3482 083 032 1878 085 741 3151 000 144	430 10 MFZ430 430WGTZ KZISZ-5	Getr. / GBox: 16AS-2601OD LKPCL7G1 / LKPCL8G1 für Ausrückgabel mit Nocken / for release fork with cams (70)
				3400 117 801 3482 083 032 1878 085 741 3151 000 144	430 10 MFZ430 430WGTZ KZISZ-5	Getr. / GBox: 16S-181OD LKPCL7C1 / LKPCL8C1 für Ausrückgabel mit Nocken / for release fork with cams (70)
				3400 117 801 3482 083 032 1878 085 741 3151 000 144	430 10 MFZ430 430WGTZ KZISZ-5	Getr. / GBox: 16S-221 LKPB15A1 / LKPB17A1 / LKPB18A1 / LKPB19A1 / LKPC18A1 / LKPCL7A1 / LKPCL8A1 für Ausrückgabel mit Nocken / for release fork with cams (70)
				3400 700 435 3482 083 032 1878 085 741 3151 000 493	430 10 MFZ430 430WGTZ KZISZ-5	Getr. / GBox: 12AS-2330TD LKPB15M1 / LKPC18M1 / LKPCL7M1 für Ausrückgabel mit Rollen / for release fork with rollers (71)
				3400 700 435 3482 083 032 1878 085 741 3151 000 493	430 10 MFZ430 430WGTZ KZISZ-5	Getr. / GBox: 16AS-2601DD LKPB17E1 / LKPB18E1 / LKPB19E1 / LKPB19F1 / LKPC18E1 / LKPCL7E1 / LKPCL8E1 für Ausrückgabel mit Rollen / for release fork with rollers (71)
				3400 700 435 3482 083 032 1878 085 741 3151 000 493	430 10 MFZ430 430WGTZ KZISZ-5	Getr. / GBox: 16AS-2601OD LKPCL7G1 / LKPCL8G1 für Ausrückgabel mit Rollen / for release fork with rollers (71)
				3400 700 435 3482 083 032 1878 085 741 3151 000 493	430 10 MFZ430 430WGTZ KZISZ-5	Getr. / GBox: 16S-181OD LKPCL7C1 / LKPCL8C1 für Ausrückgabel mit Rollen / for release fork with rollers (71)
				3400 700 435 3482 083 032 1878 085 741 3151 000 493	430 10 MFZ430 430WGTZ KZISZ-5	Getr. / GBox: 16S-221 LKPB15A1 / LKPB17A1 / LKPB18A1 / LKPB19A1 / LKPC18A1 / LKPCL7A1 / LKPCL8A1 für Ausrückgabel mit Rollen / for release fork with rollers (71)
		F3BE0681E		3189 600 004		Getr. / GBox: ZF AS Tronic Rollenausführung / roller version (58)
AS 190S50	12.06-	F3BE3681		3400 700 366 3482 000 572 1878 004 132 3151 000 493	430 10 MFZ430 430WGTZ KZISZ-5	Getr. / GBox: 12AS-2330TD ZFFCLLB1 für Ausrückgabel mit Rollen / for release fork with rollers (71)
				3400 700 461 3482 000 572 1878 004 132 3151 000 144	430 10 MFZ430 430WGTZ KZISZ-5	Getr. / GBox: 12AS-2330TD ZFFCLLB1 / ZFFCU8B1
				3400 700 461 3482 000 572 1878 004 132 3151 000 144	430 10 MFZ430 430WGTZ KZISZ-5	Getr. / GBox: 16S-2320TD ZFFB17A1 / ZFFCU8A1
			F3B3681B, F3HFE611B		3189 600 004	
AS 260S40	02.02-	F3AE0681		3400 117 801 3482 083 032 1878 085 741 3151 000 144	430 10 MFZ430 430WGTZ KZISZ-5	L3LC16D1 / L3LE14C3 / LCLC16A1 / LCLC16E1 / LCLCL7EA / LCLE14A1 / LCLE14E1 / LCLE15A1 / LCLE17A1 / LCLE17E1 / LCLE19E1 / LCLF15E1 / LCLF16E1 / LCLF17E1 / LCLFL6A1 / LCLFL7E1 für Ausrückgabel mit Nocken / for release fork with cams (70)
				3400 700 435 3482 083 032 1878 085 741 3151 000 493	430 10 MFZ430 430WGTZ KZISZ-5	L3LC16D1 / L3LE14C3 / LCLC16A1 / LCLC16E1 / LCLCL7EA / LCLE14A1 / LCLE14E1 / LCLE15A1 / LCLE17A1 / LCLE17E1 / LCLE19E1 / LCLF15E1 / LCLF16E1 / LCLF17E1 / LCLFL6A1 / LCLFL7E1 für Ausrückgabel mit Rollen / for release fork with rollers (71)
			F3AE0681B, F3AE0681H		3189 600 004	















		CODE				
--	--	------	--	---	---	---

IVECO

Stralis		02.02 -				
AS 260S43	02.02 -	F3AE0681	 3400 117 801  3482 083 032  1878 085 741  3151 000 144	430 10 MFZ430 430WGTZ KZISZ-5	L3KC16D1 / L3KC16F1 / L3KC16G1 / L3KCL6G1 / L3KF16D1 / L3KFL6G1 / LCKC15A1 / LCKC15E1 / LCKC16A1 / LCKC16E1 / LCKC17A1 / LCKCL6A1 / LCKCL6E1 / LCKE14A1 / LCKE15A1 / LCKE15B1 / LCKE15E1 / LCKE16A1 / LCKE16E1 / LCKE17A1 / LCKE18E1 / LCKE19A1 / LCKE19E1 / LCKF15A1 / LCKF16A1 / LCKF16E1 / LCKF17A1 für Ausrückgabel mit Nocken / for release fork with cams	(70)
			3400 700 435  3482 083 032  1878 085 741  3151 000 493	430 10 MFZ430 430WGTZ KZISZ-5	L3KC16D1 / L3KC16F1 / L3KC16G1 / L3KCL6G1 / L3KF16D1 / L3KFL6G1 / LCKC15A1 / LCKC15E1 / LCKC16A1 / LCKC16E1 / LCKC17A1 / LCKCL6A1 / LCKCL6E1 / LCKE14A1 / LCKE15A1 / LCKE15B1 / LCKE15E1 / LCKE16A1 / LCKE16E1 / LCKE17A1 / LCKE18E1 / LCKE19A1 / LCKE19E1 / LCKF15A1 / LCKF16A1 / LCKF16E1 / LCKF17A1 für Ausrückgabel mit Rollen / for release fork with rollers	(71)
		F3AE0681D	 3400 700 462 	430 10	Getr. / GBox: ZF 16S-1920TD QUQB14A3 / ZUQCL6A3 / TUQB15A3 Nabenprofil / Hub Profile: 41,25x52,1-10N	(48)
			 3189 600 004		Getr. / GBox: ZF AS Tronic Rollenausführung / roller version	(58)
AS 260S43	05.05 -	F3AE3681	 3400 700 395  3482 000 573  1878 004 581  3151 000 493	430 10 MFZ430 430WGTZ KZISZ-5	Getr. / GBox: 16S-1920TD QUQE14A3	
			F3AE0681D	 3189 600 004		Getr. / GBox: ZF AS Tronic Rollenausführung / roller version
AS 260S44	02.02 -	F3BE0681	 3400 117 801  3482 083 032  1878 085 741  3151 000 144	430 10 MFZ430 430WGTZ KZISZ-5	Getr. / GBox: 16AS 2601 DD Getr. / GBox: 16AS 2601 OD für Ausrückgabel mit Nocken / for release fork with cams	(70)
			3400 700 435  3482 083 032  1878 085 741  3151 000 493	430 10 MFZ430 430WGTZ KZISZ-5	Getr. / GBox: 16AS 2601 DD Getr. / GBox: 16AS 2601 OD für Ausrückgabel mit Rollen / for release fork with rollers	(71)
				 3496 006 000		Getr. / GBox: 16AS 2601 DD Getr. / GBox: 16AS 2601 OD langer Bügel / long handle
AS 260S48	02.02 -	F3AE0681	 3400 117 801  3482 083 032  1878 085 741  3151 000 144	430 10 MFZ430 430WGTZ KZISZ-5	L3PB18D1 / L3PC16D1 / L3PC16G3 / L3PE14G1 / L3PE16F1 / L3PF16C1 / L3PF16F1 / L3PF17F1 / LJPC15A1 / LJPC16A1 / LJPC16E1 / LJPE14A1 / LJPE14E1 / LJPE15A1 / LJPE15E1 / LJPE16A1 / LJPE16E1 / LJPE17A1 / LJPE17E1 / LJPE18F1 / LJPF15E1 / LJPF16A1 / LJPF16E1 / LJPF17E1 für Ausrückgabel mit Nocken / for release fork with cams	(70)
			3400 700 435  3482 083 032  1878 085 741  3151 000 493	430 10 MFZ430 430WGTZ KZISZ-5	L3PB18D1 / L3PC16D1 / L3PC16G3 / L3PE14G1 / L3PE16F1 / L3PF16C1 / L3PF16F1 / L3PF17F1 / LJPC15A1 / LJPC16A1 / LJPC16E1 / LJPE14A1 / LJPE14E1 / LJPE15A1 / LJPE15E1 / LJPE16A1 / LJPE16E1 / LJPE17A1 / LJPE17E1 / LJPE18F1 / LJPF15E1 / LJPF16A1 / LJPF16E1 / LJPF17E1 für Ausrückgabel mit Rollen / for release fork with rollers	(71)
		F3BE0681E	 3189 600 004		Getr. / GBox: ZF AS Tronic Rollenausführung / roller version	(58)
AS 260S48	02.02 -	F3BE0681E	 3400 117 801  3482 083 032  1878 085 741  3151 000 144	430 10 MFZ430 430WGTZ KZISZ-5	Getr. / GBox: 12AS / 16S / 16AS für Ausrückgabel mit Nocken / for release fork with cams	(70)
			3400 700 435  3482 083 032  1878 085 741  3151 000 493	430 10 MFZ430 430WGTZ KZISZ-5	Getr. / GBox: 12AS / 16S / 16AS für Ausrückgabel mit Rollen / for release fork with rollers	(71)
				 3189 600 004		Getr. / GBox: ZF AS Tronic Rollenausführung / roller version
AS 260S50 AS 260S56	12.06 - 12.06 -	F3B3681B, F3B3681A, F3HFE611A, F3HFE611B	 3400 700 461  3482 000 572  1878 004 132  3151 000 144	430 10 MFZ430 430WGTZ KZISZ-5	Getr. / GBox: 12AS / 16AS	







































		CODE		Parameter 		
--	--	------	--	---	---	---

IVECO





























Stralis		02.02 -			
AS 260S54 AS 440S48 AS 440S54	02.02-	F3BE0681E, F3BE0681A	 3400 117 801 ④ 3482 083 032 Ⓞ 1878 085 741 Ⓞ 3151 000 144	430 10 MFZ430 430WGTZ KZISZ-5	Getr. / GBox: 12AS / 16AS für Ausrückgabel mit Nocken / for release fork with cams (70)
	02.02-		3400 700 435 ④ 3482 083 032 Ⓞ 1878 085 741 Ⓞ 3151 000 493	430 10 MFZ430 430WGTZ KZISZ-5	Getr. / GBox: 12AS / 16AS für Ausrückgabel mit Rollen / for release fork with rollers (71)
	02.02-		 3189 600 004		Getr. / GBox: ZF AS Tronic Rollenausführung / roller version (58)
AS 260S54	02.02-	F3AE0681	 3400 117 801 ④ 3482 083 032 Ⓞ 1878 085 741 Ⓞ 3151 000 144	430 10 MFZ430 430WGTZ KZISZ-5	L3RE15A1 / L3RE16A1 / LJRE14G1 / LJRE15G1 / LJRE16G1 für Ausrückgabel mit Nocken / for release fork with cams (70)
			3400 700 435 ④ 3482 083 032 Ⓞ 1878 085 741 Ⓞ 3151 000 493	430 10 MFZ430 430WGTZ KZISZ-5	L3RE15A1 / L3RE16A1 / LJRE14G1 / LJRE15G1 / LJRE16G1 für Ausrückgabel mit Rollen / for release fork with rollers (71)
		F3BE0681A	 3189 600 004		Getr. / GBox: ZF AS Tronic Rollenausführung / roller version (58)
AS 320S50 AS 440S50	05.07 - 07.06-	F3B3681B, F3HFE611B	 3400 700 366 ④ 3482 000 572 Ⓞ 1878 004 132 Ⓞ 3151 000 493	430 10 MFZ430 430WGTZ KZISZ-5	Getr. / GBox: 12AS für Ausrückgabel mit Rollen / for release fork with rollers (71)
			3400 700 461 ④ 3482 000 572 Ⓞ 1878 004 132 Ⓞ 3151 000 144	430 10 MFZ430 430WGTZ KZISZ-5	Getr. / GBox: 16S
			 3189 600 004		Getr. / GBox: ZF AS Tronic Rollenausführung / roller version (58)
AS 440S35 AD		F2BE0681	 3400 084 031 ④ 3482 078 134 Ⓞ 1878 032 032 Ⓞ 3151 000 144	400 10 MFZ400 400WGTZ KZISZ-5	Getr. / GBox: 16S-151
			 3496 006 000		Getr. / GBox: 16S-151 langer Bügel / long handle (86)
AS 440S40 AS 440S40	02.02 - 02.02-	F3AE0681	 3400 117 801 ④ 3482 083 032 Ⓞ 1878 085 741 Ⓞ 3151 000 144	430 10 MFZ430 430WGTZ KZISZ-5	L1LB21C1 / L1LB21D1 / L1LB21F1 / L1LB21G1 / L1LB23C1 / L1LB23D1 / L1LB23DA / L1LB23G1 / L1LCT1G1 / L1LCT1GA / L2LB21DA / L2LB21G1 / LALB21A1 / LALB21E1 / LALB23A1 / LALB23E1 / LALCT1A1 / LALCT1E1 für Ausrückgabel mit Nocken / for release fork with cams (70)
			3400 700 435 ④ 3482 083 032 Ⓞ 1878 085 741 Ⓞ 3151 000 493	430 10 MFZ430 430WGTZ KZISZ-5	L1LB21C1 / L1LB21D1 / L1LB21F1 / L1LB21G1 / L1LB23C1 / L1LB23D1 / L1LB23DA / L1LB23G1 / L1LCT1G1 / L1LCT1GA / L2LB21DA / L2LB21G1 / LALB21A1 / LALB21E1 / LALB23A1 / LALB23E1 / LALCT1A1 / LALCT1E1 für Ausrückgabel mit Rollen / for release fork with rollers (71)
		F3AE0681B, F3AE0681H	 3189 600 004		Getr. / GBox: ZF AS Tronic Rollenausführung / roller version (58)
AS 440S40	02.02 -	F3AE0681H	 3400 117 801 ④ 3482 083 032 Ⓞ 1878 085 741 Ⓞ 3151 000 144	430 10 MFZ430 430WGTZ KZISZ-5	Getr. / GBox: 12AS / 16S für Ausrückgabel mit Nocken / for release fork with cams (70)
			3400 700 435 ④ 3482 083 032 Ⓞ 1878 085 741 Ⓞ 3151 000 493	430 10 MFZ430 430WGTZ KZISZ-5	Getr. / GBox: 12AS / 16S für Ausrückgabel mit Rollen / for release fork with rollers (71)
			 3189 600 004		Getr. / GBox: ZF AS Tronic Rollenausführung / roller version (58)
AS 440S42 AS 440S42 AT 440S42	05.06 - 07.06 - 07.06 -	F3AE3681D, F3AE3681B	 3400 700 462 ■	430 10	Getr. / GBox: ZF 16S-1920TD QGDB21A1 / QGDB23A1 / QGDE21A2 / ZEDB21A1 / ZBDB21A1 / ZBDB21A1 / TGDB21A1 / TMDDB21A1 / TGDB23A1 / TGDBH1AA / TGDBH3A1 / TGDCM3A1 / TGDCM3A3 / TGDCM3A3 / TGDCM3A3 / TGDCM3A3 / TGDCM3A3 / TGDCM3A3 / TGDCM3A3 / TGDCM3A3 / TGDCM3A3 / TGDCM3A3 / TGDCM3A3 / TGDCM3A3 / TGDCM3A3 / TGDCM3A3 / TGDCM3A3 / ZEDB21A3 / ZBDB21A3 / ZBDB21A3 / ZBDBH3A3 / ZBDCT1A3 / QGDB21A3 / QGDB23A3 / QGDE21A4 / QGDE23A4 Nabenprofil / Hub Profile: 41,25x52,1-10N (48)
			 3189 600 004		Getr. / GBox: ZF AS Tronic Rollenausführung / roller version (58)
		F3AE3681	 3400 700 395	430 10	Getr. / GBox: 16S-1920TD ZBDB21A3 / ZBDB23A3 / ZBDCT1A3

		CODE				
--	--	------	--	---	---	---



















































IVECO















Stralis		02.02 -					
AS 440S43	02.02-	F3AE0681		3400 117 801  3482 083 032  1878 085 741  3151 000 144	430 10 MFZ430 430WGTZ KZISZ-5	L1KB21C1 / L1KB21D1 / L1KB21F1 / L1KB21G1 / L1KB23D1 / L1KB23DA / L1KB23G1 / L1KCT1D1 / L2KB21DA / L2KB21G1 / L2KB21GA / LAKB21A1 / LAKB21E1 / LAKB23A1 / LAKB23E1 / LAKB23EA / LAKBH3A1 / LAKCT1A1 / LAKCT1E1 / LBKB21A1 / LBKB21E1 / LBKB21EA für Ausrückgabel mit Nocken / for release fork with cams	(70)
				3400 700 435  3482 083 032  1878 085 741  3151 000 493	430 10 MFZ430 430WGTZ KZISZ-5	L1KB21C1 / L1KB21D1 / L1KB21F1 / L1KB21G1 / L1KB23D1 / L1KB23DA / L1KB23G1 / L1KCT1D1 / L2KB21DA / L2KB21G1 / L2KB21GA / LAKB21A1 / LAKB21E1 / LAKB23A1 / LAKB23E1 / LAKB23EA / LAKBH3A1 / LAKCT1A1 / LAKCT1E1 / LBKB21A1 / LBKB21E1 / LBKB21EA für Ausrückgabel mit Rollen / for release fork with rollers	(71)
		F3AE0681D		3400 700 462 	430 10	Getr. / GBox: ZF16S-1920TD ZTQB23A3 / TSQB21A3 / TSQB23A3 / TSQBH3A3 / TSQCT1A3 / TSQE21A4 / TSQE23A4 Nablenprofil / Hub Profile: 41,25x52,1-10N	(48)
				3189 600 004		Getr. / GBox: ZF AS Tronic Rollenausführung / roller version	(58)
AS 440S43	02.02-	F3AE0681		3400 117 801  3482 083 032  1878 085 741  3151 000 144	430 10 MFZ430 430WGTZ KZISZ-5	L1KB21C1 / L1KB21D1 / L1KB21F1 / L1KB21G1 / L1KB23D1 / L1KB23G1 / L1KCT1D1 / L2KB21DA / L2KB21G1 / L2KB21GA / LAKB21A1 / LAKB21E1 / LAKB23A1 / LAKB23E1 / LAKB23EA / LAKBH3A1 / LAKCT1A1 / LAKCT1E1 / LBKB21A1 / LBKB21E1 / LBKB21EA für Ausrückgabel mit Nocken / for release fork with cams	(70)
				3400 700 435  3482 083 032  1878 085 741  3151 000 493	430 10 MFZ430 430WGTZ KZISZ-5	L1KB21C1 / L1KB21D1 / L1KB21F1 / L1KB21G1 / L1KB23D1 / L1KB23G1 / L1KCT1D1 / L2KB21DA / L2KB21G1 / L2KB21GA / LAKB21A1 / LAKB21E1 / LAKB23A1 / LAKB23E1 / LAKB23EA / LAKBH3A1 / LAKCT1A1 / LAKCT1E1 / LBKB21A1 / LBKB21E1 / LBKB21EA für Ausrückgabel mit Rollen / for release fork with rollers	(71)
		F3AE0681D		3400 700 462 	430 10	Getr. / GBox: ZF16S-1920TD ZTQB23A3 / TSQB21A3 / TSQB23A3 / TSQBH3A3 / TSQCT1A3 / TSQE21A4 / TSQE23A4 Nablenprofil / Hub Profile: 41,25x52,1-10N	(48)
				3189 600 004		Getr. / GBox: ZF AS Tronic Rollenausführung / roller version	(58)
AS 440S44		F3BE0681		3400 117 801  3482 083 032  1878 085 741  3151 000 144	430 10 MFZ430 430WGTZ KZISZ-5	Getr. / GBox: 16S-221 Getr. / GBox: 16AS 2601DD für Ausrückgabel mit Nocken / for release fork with cams	(70)
				3400 700 435  3482 083 032  1878 085 741  3151 000 493	430 10 MFZ430 430WGTZ KZISZ-5	Getr. / GBox: 16S-221 Getr. / GBox: 16AS 2601DD für Ausrückgabel mit Rollen / for release fork with rollers	(71)
				3496 006 000		Getr. / GBox: 16S-221 Getr. / GBox: 16AS 2601DD langer Bügel / long handle	(86)
AS 440S45, AT 440S45	12.06-	F3AE3681A		3400 700 462 	430 10	Getr. / GBox: ZF16S-1920TD TMEB21A3 / TMEB21AC / TGECT1A3 / TGEB21A3 / TGECM3A3A / TJEBH2A3 / TJEBH2AC / TGEB23A3 / TGEB23AC / TGEBH3A3 / TGEE21A4 / ZBEB23A3 / ZBEB24AC / ZEEB21A3 / ZEEB21AC / ZBECT1A3 / ZBEB21A3 / ZBEBH1A3 / ZBEBH3A3 / QGEB21A3 / QGEB23A3 / QGEBH1A3 / QGEE21A4 / TMEB21A1 / TMEB21AA / TGECT1A1 / TGEB21A1 / TJEBH1A1 / TJEBH2AA / TGEB23AA / TGEB23A1 / TGEBH3A1 / TGECM3A1 / TGEE21A2 / TGEE23A2 / ZBEB21A1 / ZBEB23AA / ZEEB21A1 / ZEEB21AA / ZBEE23A2 / ZBEB23A1 / ZBEBH3A1 / ZBECT1A1 / QGEB23A1 / QGEB21A1 / QGEE21A2 / QGEE23A2 Nablenprofil / Hub Profile: 41,25x52,1-10N	(48)
				3189 600 004		Getr. / GBox: ZF AS Tronic Rollenausführung / roller version	(58)
			F3AE3681		3400 700 395  3482 000 573  1878 004 581  3151 000 493	430 10 MFZ430 430WGTZ KZISZ-5	Getr. / GBox: 16S-2220TD ZBEB21A3 / ZBEB23A3 / ZBECT1A3

IVECO

Stralis		02.02 -					
AS 440S48 AS 440S48	02.02 -	F3AE0681		3400 117 801  3482 083 032  1878 085 741  3151 000 144	430 10 MFZ430 430WGTZ KZISZ-5	L1PB21C1 / L1PB21D1 / L1PB21F1 / L1PB21G1 / L1PB23C1 / L1PB23D1 / L1PB23DA / L1PB23G1 / L1PCT1B1 / L1PCT1J1 / L1PCT1K1 / LGPB21A1 / LGPB21E1 / LGPB23A1 / LGPB23E1 / LGPCT1C1 / LGPCT1G1 / LGPCT1GA / LHPB21A1 / LHPB21E1 / LHPB21EA für Ausrückgabel mit Nocken / for release fork with cams	(70)
	02.02 -			3400 700 435  3482 083 032  1878 085 741  3151 000 493	430 10 MFZ430 430WGTZ KZISZ-5		L1PB21C1 / L1PB21D1 / L1PB21F1 / L1PB21G1 / L1PB23C1 / L1PB23D1 / L1PB23DA / L1PB23G1 / L1PCT1B1 / L1PCT1J1 / L1PCT1K1 / LGPB21A1 / LGPB21E1 / LGPB23A1 / LGPB23E1 / LGPCT1C1 / LGPCT1G1 / LGPCT1GA / LHPB21A1 / LHPB21E1 / LHPB21EA für Ausrückgabel mit Rollen / for release fork with rollers
		F3BE0681E		3189 600 004		Getr. / GBox: ZF AS Tronic Rollenausführung / roller version	(58)
AS 440S54	02.02 -	F3AE0681		3400 117 801  3482 083 032  1878 085 741  3151 000 144	430 10 MFZ430 430WGTZ KZISZ-5	L1RB21A1 / L1RB21B1 / L1RB23B1 / L1RB23BA / L2RB21BA / LGRB21G1 / LGRB23G1 für Ausrückgabel mit Nocken / for release fork with cams	(70)
				3400 700 435  3482 083 032  1878 085 741  3151 000 493	430 10 MFZ430 430WGTZ KZISZ-5		L1RB21A1 / L1RB21B1 / L1RB23B1 / L1RB23BA / L2RB21BA / LGRB21G1 / LGRB23G1 für Ausrückgabel mit Rollen / for release fork with rollers
		F3BE0681A		3189 600 004		Getr. / GBox: ZF AS Tronic Rollenausführung / roller version	(58)
AS 440S56	07.06 -	F3B3681A, F3HFE611A		3400 117 801  3482 083 032  1878 085 741  3151 000 144	430 10 MFZ430 430WGTZ KZISZ-5	Getr. / GBox: 16S für Ausrückgabel mit Nocken / for release fork with cams	(70)
				3400 700 366  3482 000 572  1878 004 132  3151 000 493	430 10 MFZ430 430WGTZ KZISZ-5		Getr. / GBox: 12AS für Ausrückgabel mit Rollen / for release fork with rollers
				3400 700 435  3482 083 032  1878 085 741  3151 000 493	430 10 MFZ430 430WGTZ KZISZ-5	Getr. / GBox: 16S für Ausrückgabel mit Rollen / for release fork with rollers	(71)
				3189 600 004		Getr. / GBox: ZF AS Tronic Rollenausführung / roller version	(58)
AT 440S45	07.06 -	F3AE3681A		3400 700 462 	430 10	Getr. / GBox: ZF16S-1920TD TMEB21A3 / TMEB21AC / TGECT1A3 / TGEB21A3 / TGECM3A3A / TJEBH2A3 / TJEBH2AC / TGEB23A3 / TGEB23AC / TGEH3A3 / TGEE21A4 / ZBEB23A3 / ZBEB24AC / ZEEB21A3 / ZEEB21AC / ZBECT1A3 / ZBEB21A3 / ZBEBH1A3 / ZBEBH3A3 / QGEB21A3 / QGEB23A3 / QGEBH1A3 / QGEE21A4 / TMEB21A1 / TMEB21AA / TGECT1A1 / TGEB21A1 / TJEBH1A1 / TJEBH2AA / TGEB23AA / TGEB23A1 / TGEH3A1 / TGECM3A1 / TGEE21A2 / TGEE23A2 / ZBEB21A1 / ZBEB23AA / ZEEB21A1 / ZEEB21AA / ZBEE23A2 / ZBEB23A1 / ZBEBH3A1 / ZBECT1A1 / QGEB23A1 / QGEB21A1 QGEE21A2 / QGEE23A2 Nabenprofil / Hub Profile: 41,25x52,1-10N	(48)













IVECO















Trakker		09.04 -							
Trakker Euro 6		Cursor9	 3400 700 365  3482 000 573  1878 004 133  3151 000 493	430 10 MFZ430 430WGTZ KZISZ-5	für / for: 400 PS Getr. / GBox: 16 S 1620 TD Getr. / GBox: 12 AS 1420 TD Getr. / GBox: 12 AS 1930 TD Getr. / GBox: 12 AS 2330 TO Euro 6 / Euro 6 für Ausrückgabel mit Rollen / for release fork with rollers	(69)	(18)	(71)	
		Cursor11	 3400 700 366  3482 000 572  1878 004 132  3151 000 493	430 10 MFZ430 430WGTZ KZISZ-5	für / for: 420 PS Getr. / GBox: 16 S 1920 TD Getr. / GBox: 16 S 2220 TO Getr. / GBox: 12 AS 1930 TD Getr. / GBox: 12 AS 2330 TD Getr. / GBox: 12 AS 2330 TO Euro 6 / Euro 6 für Ausrückgabel mit Rollen / for release fork with rollers	(69)	(18)	(71)	
			 3400 700 366  3482 000 572  1878 004 132  3151 000 493	430 10 MFZ430 430WGTZ KZISZ-5	für / for: 460 PS Getr. / GBox: 16 S 2220 TD Getr. / GBox: 16 S 2220 TO Getr. / GBox: 12 AS 2330 TD Getr. / GBox: 12 AS 2330 TO Euro 6 / Euro 6 für Ausrückgabel mit Rollen / for release fork with rollers	(69)	(18)	(71)	
			 3400 700 366  3482 000 572  1878 004 132  3151 000 493	430 10 MFZ430 430WGTZ KZISZ-5	für / for: 480 PS Getr. / GBox: 16 S 2320 TD Getr. / GBox: 16 S 2520 TO Getr. / GBox: 12 AS 2330 TD Getr. / GBox: 12 AS 2330 TO Euro 6 / Euro 6 für Ausrückgabel mit Rollen / for release fork with rollers	(69)	(18)	(71)	
		Cursor13	 3400 700 366  3482 000 572  1878 004 132  3151 000 493	430 10 MFZ430 430WGTZ KZISZ-5	für / for: 450 PS Getr. / GBox: 12 AS 2330 TD Getr. / GBox: 12 AS 2330 TO Getr. / GBox: 16 AS 2630 TO Euro 6 / Euro 6 für Ausrückgabel mit Rollen / for release fork with rollers	(69)	(18)	(71)	
			 3400 700 366  3482 000 572  1878 004 132  3151 000 493	430 10 MFZ430 430WGTZ KZISZ-5	für / for: 480 PS Getr. / GBox: 16 S 2220 TO Euro 6 / Euro 6 für Ausrückgabel mit Rollen / for release fork with rollers	(69)	(18)	(71)	
			 3400 700 366  3482 000 572  1878 004 132  3151 000 493	430 10 MFZ430 430WGTZ KZISZ-5	für / for: 500 PS Getr. / GBox: 16 S 2320 TD Getr. / GBox: 16 S 2520 TO Getr. / GBox: 12 AS 2330 TO Getr. / GBox: 16 AS 2630 TO Euro 6 / Euro 6 für Ausrückgabel mit Rollen / for release fork with rollers	(69)	(18)	(71)	
			 3400 700 366  3482 000 572  1878 004 132  3151 000 493	430 10 MFZ430 430WGTZ KZISZ-5	für / for: 560 PS Getr. / GBox: 16 S 2520 TO Getr. / GBox: 12 AS 2530 TO Euro 6 / Euro 6 für Ausrückgabel mit Rollen / for release fork with rollers	(69)	(18)	(71)	
			 3189 600 004		Getr. / GBox: ZF AS Tronic Rollenausführung / roller version	(58)			
		AD 180T27 W, AT 180T27 W	06.05-	F2BE0681	 3400 107 031  3482 078 134  1862 317 031  3151 000 144	400 10 MFZ400 400GVZ KZISZ-5	Getr. / GBox: 9S109 KFKA12D2 / KFKA12DB / KFKA13D2 / KFKA13DB / KFKA14D2 / HFKA14D2		
		AD 190T27, AT 190T27	06.05-	F2BE0681	 3400 107 031  3482 078 134  1862 317 031  3151 000 144	400 10 MFZ400 400GVZ KZISZ-5	Getr. / GBox: 9S109 KAKA12D1 / KAKA12D2 / KAKA13D1 / KAKA14D1 / KAKA15D1 / KAKA17D1 / HAKA14D1 / HAKA15D1		
		AD 190T31 W, AT 190T31 W AD 190T31 W, AT 190T31 W AD 190T31, AT 190T31	10.04- 06.05- 10.04-	F2BE0681	 3400 084 031  3482 078 134  1878 032 032  3151 000 144	400 10 MFZ400 400WGTZ KZISZ-5	Getr. / GBox: 12AS2301DD KFPA12F2 / KFPA13F2 / KFPA14F2 / KFPA12F2 / HFPA14F2		
			 3400 107 031  3482 078 134  1862 317 031  3151 000 144	400 10 MFZ400 400GVZ KZISZ-5	Getr. / GBox: 9S109 KFPA12D2 / KFPA13D2 / KFPA14D2				
			 3400 107 031	400 10	Getr. / GBox: 16S109 KAPA12A1 / KAPA13A1 / KAPA13A2 / KAPA14A1 /				

Trakker		09.04 -				
AD 190T31 W, AT 190T31 W AD 190T33 W, AT 190T33 W AD 190T33, AT 190T33 AD 260T33, AT 260T33	01.13-	Cursor9	 3400 700 365 ⊗ 3482 000 573 ⊗ 1878 004 133 ⬢ 3151 000 493	430 10 MFZ430 430WGTZ KZISZ-5	Getr. / GBox: 16 S 1620 TD Getr. / GBox: 12 AS 1420 TD Getr. / GBox: 12 AS 1930 TD Getr. / GBox: 12 AS 2330 TO Euro 6 / Euro 6 für Ausrückgabel mit Rollen / for release fork with rollers	(18) (71)
	01.13- 01.13- 01.13-		3400 700 377 ⊗ 3482 000 628 ⊗ 1878 004 581 ⬢ 3151 000 651	430 10 MF430 430WGTZ KZIS-4	Getr. / GBox: 9 S 1310TO Euro 6 / Euro 6	(18)
		F2CFE611D, F2CFE611C	 3189 600 004		Getr. / GBox: ZF AS Tronic Rollenausführung / roller version	(58)
AD 190T33 W, AT 190T33 W AD 190T33, AT 190T33	03.06-	F2BE3681	 3400 700 365 ⊗ 3482 000 573 ⊗ 1878 004 133 ⬢ 3151 000 493	430 10 MFZ430 430WGTZ KZISZ-5	Getr. / GBox: 12AS1420TD KUBA13C3 / KUBA15C3 / KUBA15C6 für Ausrückgabel mit Rollen / for release fork with rollers	(71)
	03.06-		 3400 700 365 ⊗ 3482 000 573 ⊗ 1878 004 133 ⬢ 3151 000 493	430 10 MFZ430 430WGTZ KZISZ-5	Getr. / GBox: 12AS1930TD KUCA13C3 / KUCB15C3 für Ausrückgabel mit Rollen / for release fork with rollers	(71)
			 3400 700 378 ⊗ 3482 000 573 ⊗ 1878 004 133 ⬢ 3151 000 144	430 10 MFZ430 430WGTZ KZISZ-5	Getr. / GBox: 12AS1930TD KUCA13C3 / KUCB13C3 / KUCB15C3 für Ausrückgabel mit Nocken / for release fork with cams	(70)
			 3400 700 378 ⊗ 3482 000 573 ⊗ 1878 004 133 ⬢ 3151 000 144	430 10 MFZ430 430WGTZ KZISZ-5	Getr. / GBox: 16S1620TD KUBA13A3 / KUCA13A3 / KUCA14A3 / KUCB14A3 für Ausrückgabel mit Nocken / for release fork with cams	(70)
			F2BE3681B	 3189 600 004		Getr. / GBox: ZF AS Tronic Rollenausführung / roller version
AD 190T35 W, AD 190T36 W, AT 190T35 W, AT 190T36 W AD 190T35 W, AT 190T35 W, AD 190T36 W, AT 190T36 W AD 190T35, AD 190T36, AT 190T35, AT 190T36 AD 190T35, AT 190T35, AD 190T36, AT 190T36	10.04-	F2BE0681	 3400 084 031 ⊗ 3482 078 134 ⊗ 1878 032 032 ⬢ 3151 000 144	400 10 MFZ400 400WGTZ KZISZ-5	Getr. / GBox: 12AS2301DD HFRA14F2 / HFRB14F2 / KFRA12F2 / KFRA13F2 / KFRB12F2 / KFRB13F2 / KFRB14F2	
	01.05-		 3400 084 031 ⊗ 3482 078 134 ⊗ 1878 032 032 ⬢ 3151 000 144	400 10 MFZ400 400WGTZ KZISZ-5	Getr. / GBox: 16S151 HARA13A1 / HFRB12A2 / KARA12A1 / KARA13A1 / KARA13A2 / KARA14A1 / KARA15A1 / KARA17A1 / KFRA12A2 / KFRA13A2 / KFRA14A2 / KFRB12A2 / KFRB13A2 / KFRB14A2	
	10.04-	F2BE3681	 3400 700 365 ⊗ 3482 000 573 ⊗ 1878 004 133 ⬢ 3151 000 493	430 10 MFZ430 430WGTZ KZISZ-5	Getr. / GBox: 12AS1930TD KUCB13C6 / HUCB15C3 für Ausrückgabel mit Rollen / for release fork with rollers	(71)
	06.05-		 3400 700 378 ⊗ 3482 000 573 ⊗ 1878 004 133 ⬢ 3151 000 144	430 10 MFZ430 430WGTZ KZISZ-5	Getr. / GBox: 12AS1930TD HUCB15C3 für Ausrückgabel mit Nocken / for release fork with cams	(70)
		F2BE3681A, F2BE0681A	 3189 600 004		Getr. / GBox: ZF AS Tronic Rollenausführung / roller version	(58)
			Cursor9	 3400 700 365 ⊗ 3482 000 573 ⊗ 1878 004 133 ⬢ 3151 000 493	430 10 MFZ430 430WGTZ KZISZ-5	Getr. / GBox: 16 S 1620 TD Getr. / GBox: 12 AS 1420 TD Getr. / GBox: 12 AS 1930 TD Getr. / GBox: 12 AS 2330 TO Euro 6 / Euro 6 für Ausrückgabel mit Rollen / for release fork with rollers
		F2CFE611B	 3189 600 004		Getr. / GBox: ZF AS Tronic Rollenausführung / roller version	(58)

		CODE				
--	--	------	--	---	---	---











IVECO

Trakker		09.04 -				
AD 190T38 W, AT 190T38 W AD 190T38 W, AT 190T38 W AD 190T38, AT 190T38	10.04- 06.05- 10.04-	F3BE0681	 3400 700 435 ⊗ 3482 083 032 ⊗ 1878 085 741 ⬢ 3151 000 493	430 10 MFZ430 430WGTZ KZISZ-5	Getr. / GBox: 12AS2301OD KFLA12E2 / KFLA13E2 / KFLA14E2 / KFLA14EB / HFLA14E2 für Ausrückgabel mit Rollen / for release fork with rollers (71)	
			 3400 117 801 ⊗ 3482 083 032 ⊗ 1878 085 741 ⬢ 3151 000 144	430 10 MFZ430 430WGTZ KZISZ-5	Getr. / GBox: 12AS2301OD KFLA12E2 / KFLA13E2 / KFLA14E2 / KFLA14EB / HFLA14E2 für Ausrückgabel mit Nocken / for release fork with cams (70)	
			 3400 117 801 ⊗ 3482 083 032 ⊗ 1878 085 741 ⬢ 3151 000 144	430 10 MFZ430 430WGTZ KZISZ-5	Getr. / GBox: 16S151OD KFLA12B2 / KFLA13B2 / KFLA14B2 / H0UBK4B1 / HALA13B1 / HFLA13B2 / K0UAK2B1 / K0UAK3B1 / K0UAK4B1 / K0UAK5B1 / K0UAK5BA / K0UBK2B1 / K0UBK3B1 / K0UBK4B1 / KALA12B1 / KALA12B2 / KALA13B1 / KALA13B2 / KALA14B1 / KALA14B2 / KALA15B1 für Ausrückgabel mit Nocken / for release fork with cams (70)	
			 3400 700 435 ⊗ 3482 083 032 ⊗ 1878 085 741 ⬢ 3151 000 493	430 10 MFZ430 430WGTZ KZISZ-5	Getr. / GBox: 16S151OD KFLA12B2 / KFLA13B2 / KFLA14B2 / H0UBK4B1 / HALA13B1 / HFLA13B2 / K0UAK2B1 / K0UAK3B1 / K0UAK4B1 / K0UAK5B1 / K0UAK5BA / K0UBK2B1 / K0UBK3B1 / K0UBK4B1 / KALA12B1 / KALA12B2 / KALA13B1 / KALA13B2 / KALA14B1 / KALA14B2 / KALA15B1 für Ausrückgabel mit Rollen / for release fork with rollers (71)	
	F3BE3681	 3400 700 366 ⊗ 3482 000 572 ⊗ 1878 004 132 ⬢ 3151 000 493	430 10 MFZ430 430WGTZ KZISZ-5	Getr. / GBox: 12AS2330TO KYEC13C3 für Ausrückgabel mit Rollen / for release fork with rollers (71)		
		 3400 700 461 ⊗ 3482 000 572 ⊗ 1878 004 132 ⬢ 3151 000 144	430 10 MFZ430 430WGTZ KZISZ-5	Getr. / GBox: 12AS2330TO KYEC13C3		
		 3400 700 461 ⊗ 3482 000 572 ⊗ 1878 004 132 ⬢ 3151 000 144	430 10 MFZ430 430WGTZ KZISZ-5	Getr. / GBox: 16S2220TO KYEC13A3		
	F3BE0681G	 3189 600 004		Getr. / GBox: ZF AS Tronic Rollenausführung / roller version (58)		
	AD 190T41 W, AT 190T41 W AD 190T41, AT 190T41	03.06 - 03.06 -	F3BE3681	 3400 700 366 ⊗ 3482 000 572 ⊗ 1878 004 132 ⬢ 3151 000 493	430 10 MFZ430 430WGTZ KZISZ-5	Getr. / GBox: 12AS2330TO KUDA15C3 / KUDA15C6 für Ausrückgabel mit Rollen / for release fork with rollers (71)
				 3400 700 461 ⊗ 3482 000 572 ⊗ 1878 004 132 ⬢ 3151 000 144	430 10 MFZ430 430WGTZ KZISZ-5	Getr. / GBox: 12AS2330TO KUDA15C3 / KUDA14C3
 3400 700 461 ⊗ 3482 000 572 ⊗ 1878 004 132 ⬢ 3151 000 144				430 10 MFZ430 430WGTZ KZISZ-5	Getr. / GBox: 16S2220TO KLDA13A1 / KLDA14A1 / KLDA16A1 / KUDA13A3 / KUDA14A3	
F3HFE11D, F3BE3681D		 3189 600 004		Getr. / GBox: ZF AS Tronic Rollenausführung / roller version (58)		

Trakker		09.04 -					
AD 190T44 W, AD 190T45 W, AT 190T44 W, AD 190T45W AD 190T44 W, AT 190T44 W, AD 190T45W, AT 190T45W AD 190T44, AD 190T45, AT 190T44, AT 190T45 AD 190T44, AT 190T44, AD 19T45, AT 190T45	10.04-	F3BE0681	 3400 700 435 ⊗ 3482 083 032 ⊗ 1878 085 741 ⊙ 3151 000 493	430 10 MFZ430 430WGTZ KZISZ-5	Getr. / GBox: 12AS2301OD KFMA12E2 / HFMA14E2 / KFMA13E2 / KFMA14E2 / HFMA12E2 für Ausrückgabel mit Rollen / for release fork with rollers	(71)	
	06.05-						
	10.04-			3400 117 801 ⊗ 3482 083 032 ⊗ 1878 085 741 ⊙ 3151 000 144	430 10 MFZ430 430WGTZ KZISZ-5	Getr. / GBox: 12AS2301OD KFMA12E2 / HFMA14E2 / KFMA13E2 / KFMA14E2 / HFMA12E2 für Ausrückgabel mit Nocken / for release fork with cams	(70)
	06.05-						
				 3400 117 801 ⊗ 3482 083 032 ⊗ 1878 085 741 ⊙ 3151 000 144	430 10 MFZ430 430WGTZ KZISZ-5	Getr. / GBox: 16S181OD KAMA12B1 / KAMA13B1 / KAMA13B2 / KAMA14B1 / KAMA15B1 / KFMA12B2 / HFMA13B2 / HFMA14B2 / KFMA13B2 / KFMA14B2 / HAMA13B1 / HAMA14B1 / HAMA15B1 / HFMA12B2 für Ausrückgabel mit Nocken / for release fork with cams	(70)
				3400 700 435 ⊗ 3482 083 032 ⊗ 1878 085 741 ⊙ 3151 000 493	430 10 MFZ430 430WGTZ KZISZ-5	Getr. / GBox: 16S181OD KAMA12B1 / KAMA13B1 / KAMA13B2 / KAMA14B1 / KAMA15B1 / KFMA12B2 / HFMA13B2 / HFMA14B2 / KFMA13B2 / KFMA14B2 / HAMA13B1 / HAMA14B1 / HAMA15B1 / HFMA12B2 für Ausrückgabel mit Rollen / for release fork with rollers	(71)
			F3BE3681	 3400 700 366 ⊗ 3482 000 572 ⊗ 1878 004 132 ⊙ 3151 000 493	430 10 MFZ430 430WGTZ KZISZ-5	Getr. / GBox: 12AS2330TO KUEA13C3 für Ausrückgabel mit Rollen / for release fork with rollers	(71)
				 3400 700 461 ⊗ 3482 000 572 ⊗ 1878 004 132 ⊙ 3151 000 144	430 10 MFZ430 430WGTZ KZISZ-5	Getr. / GBox: 12AS2330TO KUEA13C3	
				 3400 700 461 ⊗ 3482 000 572 ⊗ 1878 004 132 ⊙ 3151 000 144	430 10 MFZ430 430WGTZ KZISZ-5	Getr. / GBox: 16S2220TO KLEA13A1 / KLEA14A1 / KLEA17A1 / KUEA13A3 / KUEA14A3	
			F3B3681G, F3BE0681C, F3BE3681C	 3189 600 004		Getr. / GBox: ZF AS Tronic Rollenausführung / roller version	(58)
AD 190T45, AT 190T45 AD 380T45 W, AT 380T45 W	01.13-	Cursor13	 3400 700 366 ⊗ 3482 000 572 ⊗ 1878 004 132 ⊙ 3151 000 493	430 10 MFZ430 430WGTZ KZISZ-5	Getr. / GBox: 12 AS 2330 TD Getr. / GBox: 12 AS 2330 TO Getr. / GBox: 16 AS 2630 TO Euro 6 / Euro 6 für Ausrückgabel mit Rollen / for release fork with rollers	(18) (71)	
	01.13-						
		F3HFE611/450	 3189 600 004		Getr. / GBox: ZF AS Tronic Rollenausführung / roller version	(58)	
AD 260T31 B AD 260T31, AT 260T31	06.05- 10.04-	F2BE0681	 3400 084 031 ⊗ 3482 078 134 ⊗ 1878 032 032 ⊙ 3151 000 144	400 10 MFZ400 400WGTZ KZISZ-5	Getr. / GBox: 12AS2301DD KCPA12F1 / KCPA13FA / KCPA14FA / KCPA15F1 / KCPA15FA / KCPA16F1 / KCPA17F1 / KCPA17FA		
			 3400 107 031 ⊗ 3482 078 134 ⊗ 1862 317 031 ⊙ 3151 000 144	400 10 MFZ400 400GVZ KZISZ-5	Getr. / GBox: 9S109 KCPA12D1 / KCPA13D1 / KCPA14D1 / KCPA14DA / KCPA15D1 / KCPA15DA / KCPA16D1 / KCPA17D1 / KCPA18D1 / KCPA72D1 / KCPA73D1 / KCPA74D1 / KCPC73D1 / KCPG72D1 / KCPG73D1 / KCPG74DA		
			 3400 107 031 ⊗ 3482 078 134 ⊗ 1862 317 031 ⊙ 3151 000 144	400 10 MFZ400 400GVZ KZISZ-5	Getr. / GBox: 16S109 KCPA12A1 / KCPA13A1 / KCPA14A1 / KCPA15A1 / KCPA16A1 / KCPA17A1 / HCPA17AA		
AD 260T33 B AD 260T33, AD 380T33, AT 260T33, AT 380T33	07.07- 03.06-	F2BE3681	 3400 700 365 ⊗ 3482 000 573 ⊗ 1878 004 133 ⊙ 3151 000 493	430 10 MFZ430 430WGTZ KZISZ-5	Getr. / GBox: 12AS1420TD KNBA12CA / KNBD13CA / KNBD16CA für Ausrückgabel mit Rollen / for release fork with rollers	(71)	
			 3400 700 378 ⊗ 3482 000 573 ⊗ 1878 004 133 ⊙ 3151 000 144	430 10 MFZ430 430WGTZ KZISZ-5	Getr. / GBox: 12AS1420TD KNBA12CA / KNBD13CA für Ausrückgabel mit Nocken / for release fork with cams	(70)	
		F4AE3681	 3400 700 365 ⊗ 3482 000 573 ⊗ 1878 004 133 ⊙ 3151 000 493	430 10 MFZ430 430WGTZ KZISZ-5	Getr. / GBox: FS-8309A(B) KNBA72C1 für Ausrückgabel mit Rollen / for release fork with rollers	(71)	
		F2BE3681B	 3189 600 004		Getr. / GBox: ZF AS Tronic Rollenausführung / roller version	(58)	











		CODE				
--	--	------	--	---	---	---

IVECO

Trakker		09.04 -					
AD 260T35 B AD 260T35 W, AT 260T35 W AD 260T35, AT 260T35	06.05- 06.05- 10.04-	F2BE0681	 3400 084 031 ⊗ 3482 078 134 ⊗ 1878 032 032 ⊙ 3151 000 144	400 10 MFZ400 400WGTZ KZISZ-5	Getr. / GBox: 12AS2301DD KHRA14F2 / HCRA13F1 / HCRA15FA / HCRG17FA / KCRA12F1 / KCRA13F1 / KCRA14F1 / KCRA15F1 / KCRA16F1 / KCRA17F1 / KCRA18F1		
			 3400 084 031 ⊗ 3482 078 134 ⊗ 1878 032 032 ⊙ 3151 000 144	400 10 MFZ400 400WGTZ KZISZ-5	Getr. / GBox: 16S151 KCRG74AA / KHRA13A2 / KHRA14A2 / HCRA14A1 / HCRA15A1 / HCRA16A1 / HCRA17A1 / HCRA17AA / KCRA12A1 / KCRA13A1 / KCRA14A1 / KCRA15A1 / KCRA16A1 / KCRA17A1 / KCRA18A1 / KCRA72A1 / KCRA73A1 / KCRA74A1		
AD 260T36 B AD 260T36 W, AD 380T36 W, AT 260T36 W, AT 380T36 W AD 260T36, AT 260T36	07.07- 10.04- 03.06-	F2BE3681	 3400 700 365 ⊗ 3482 000 573 ⊗ 1878 004 133 ⊙ 3151 000 493	430 10 MFZ430 430WGTZ KZISZ-5	Getr. / GBox: 12AS1930TD KNCA11C1 / KNCA12C1 / KNCA13C1 / KNCA15C1 / KNCA16C1 / KNCA17C1 / KNCD13CA / KNCD16CA / KNCF73CA / KXCB13C3 für Ausrückgabel mit Rollen / for release fork with rollers (71)		
			 3400 700 378 ⊗ 3482 000 573 ⊗ 1878 004 133 ⊙ 3151 000 144	430 10 MFZ430 430WGTZ KZISZ-5	Getr. / GBox: 12AS1930TD KXCB13C3 für Ausrückgabel mit Nocken / for release fork with cams (70)		
			 3400 700 378 ⊗ 3482 000 573 ⊗ 1878 004 133 ⊙ 3151 000 144	430 10 MFZ430 430WGTZ KZISZ-5	Getr. / GBox: 16S1620TD KXCB12A3 / KXCB13A3 für Ausrückgabel mit Nocken / for release fork with cams (70)		
AD 260T38 , AT 260T38 AD 260T38 B AD 260T38 W, AT 260T38 W AD 260T38, AD 260T38 /P, AT 260T38	10.04- 06.05- 06.05- 06.05-	F3BE0681	 3400 117 801 ⊗ 3482 083 032 ⊗ 1878 085 741 ⊙ 3151 000 144	430 10 MFZ430 430WGTZ KZISZ-5	Getr. / GBox: 12AS2301OD KCLA12E1 / KCLA13E1 / KCLA14E1 / KCLA15E1 / KCLA16E1 / KCLA17E1 / KCLA18E1 / KCLE12E1 / KCLE13E1 / KCLE14E1 / KCLE16E1 / KHLA13E2 / KHLA14E2 / HCLA16E1 / HCLA17E1 / HCLE13E1 für Ausrückgabel mit Nocken / for release fork with cams (70)		
			3400 700 435 ⊗ 3482 083 032 ⊗ 1878 085 741 ⊙ 3151 000 493	430 10 MFZ430 430WGTZ KZISZ-5	Getr. / GBox: 12AS2301OD KCLA12E1 / KCLA13E1 / KCLA14E1 / KCLA15E1 / KCLA16E1 / KCLA17E1 / KCLA18E1 / KCLE12E1 / KCLE13E1 / KCLE14E1 / KCLE16E1 / KHLA13E2 / KHLA14E2 / HCLA16E1 / HCLA17E1 / HCLE13E1 für Ausrückgabel mit Rollen / for release fork with rollers (71)		
			 3400 700 435 ⊗ 3482 083 032 ⊗ 1878 085 741 ⊙ 3151 000 493	430 10 MFZ430 430WGTZ KZISZ-5	Getr. / GBox: 16S151OD KCLA12B1 / KCLA13B1 / KCLA14B1 / KCLA15B1 / KCLA16B1 / KCLA17B1 / KCLA18B1 / KCLE13B1 / KCLE14B1 / KCLE15B1 / KCLE16B1 / KCLE17B1 / KHLA13B2 / KHLA14B2 / HCLA13B1 / HCLA15B1 / HCLA16B1 / HCLA17B1 / HCLE16B1 / HCLE17B1 / HHLA13B2 für Ausrückgabel mit Rollen / for release fork with rollers (71)		
		3400 117 801 ⊗ 3482 083 032 ⊗ 1878 085 741 ⊙ 3151 000 144	430 10 MFZ430 430WGTZ KZISZ-5	Getr. / GBox: 16S151OD KCLA12B1 / KCLA13B1 / KCLA14B1 / KCLA15B1 / KCLA16B1 / KCLA17B1 / KCLA18B1 / KCLE13B1 / KCLE14B1 / KCLE15B1 / KCLE16B1 / KCLE17B1 / KHLA13B2 / KHLA14B2 / HCLA13B1 / HCLA15B1 / HCLA16B1 / HCLA17B1 / HCLE16B1 / HCLE17B1 / HHLA13B2 für Ausrückgabel mit Nocken / for release fork with cams (70)			
AD 260T41 W, AD 380T41 W, AT 260T41 W, AT 380T41 W AD 260T41, AD 380T41, AT 260T41, AT 380T41	03.06- 03.06-	F3BE3681	 3400 700 366 ⊗ 3482 000 572 ⊗ 1878 004 132 ⊙ 3151 000 493	430 10 MFZ430 430WGTZ KZISZ-5	Getr. / GBox: 12AS2330TO KXDB12C3 / HNDE14C1 / HNDE15C1 für Ausrückgabel mit Rollen / for release fork with rollers (71)		
			 3400 700 461 ⊗ 3482 000 572 ⊗ 1878 004 132 ⊙ 3151 000 144	430 10 MFZ430 430WGTZ KZISZ-5	Getr. / GBox: 12AS2330TO KXDB12C3 / HNDE15C1		
		F3HFE611D, F3BE3681D	 3189 600 004		Getr. / GBox: ZF AS Tronic Rollenausführung / roller version (58)		











		CODE				
--	--	------	--	---	---	---

IVECO















































Trakker		09.04 -				
AD 260T44 W, AT 260T44 W AD 260T44, AD 260T44 /P, AT 260T44	06.05-	F3BE0681	 3400 117 801 ⊗ 3482 083 032 ⊗ 1878 085 741 ⊙ 3151 000 144	430 10 MFZ430 430WGTZ KZISZ-5	Getr. / GBox: 12AS2301OD KHMA13E2 / KHMA14E2 / HCMA13E1 / HCMA14E1 / / HCMA15E1 / HCMA16E1 / HCME14E1 / / HCME15E1 / HCME16E1 / HCME17E1 / HHMA13E2 / HHMA14E2 / KCMA12E1 / KCMA13E1 / / KCMA14E1 / KCMA15E1 / KCMA16E1 / KCME12E1 / KCME14E1 / KCME15E1 / KCME16E1 für Ausrückgabel mit Nocken / for release fork with cams	(70)
	06.05-		 3400 700 435 ⊗ 3482 083 032 ⊗ 1878 085 741 ⊙ 3151 000 493	430 10 MFZ430 430WGTZ KZISZ-5	Getr. / GBox: 12AS2301OD KHMA13E2 / KHMA14E2 / HCMA13E1 / HCMA14E1 / / HCMA15E1 / HCMA16E1 / HCME14E1 / / HCME15E1 / HCME16E1 / HCME17E1 / HHMA13E2 / HHMA14E2 / KCMA12E1 / KCMA13E1 / / KCMA14E1 / KCMA15E1 / KCMA16E1 / KCME12E1 / KCME14E1 / KCME15E1 / KCME16E1 für Ausrückgabel mit Rollen / for release fork with rollers	(71)
			 3400 700 435 ⊗ 3482 083 032 ⊗ 1878 085 741 ⊙ 3151 000 493	430 10 MFZ430 430WGTZ KZISZ-5	Getr. / GBox: 16S1810D KHMA14B2 / HCMA12B1 / HCMA13B1 / HCMA14B1 / HCMA16B1 / HCMA17B1 / HHMA14B2 / / KCMA12B1 / KCMA13B1 / KCMA14B1 / KCMA15B1 / KCMA16B1 / KCMA17B1 / KCME13B1 / / KCME14B1 / KCME15B1 / KCME16B1 / KCME17B1 / KHMA13B2 für Ausrückgabel mit Rollen / for release fork with rollers	(71)
			 3400 117 801 ⊗ 3482 083 032 ⊗ 1878 085 741 ⊙ 3151 000 144	430 10 MFZ430 430WGTZ KZISZ-5	Getr. / GBox: 16S1810D KHMA14B2 / HCMA12B1 / HCMA13B1 / HCMA14B1 / HCMA16B1 / HCMA17B1 / HHMA14B2 / / KCMA12B1 / KCMA13B1 / KCMA14B1 / KCMA15B1 / KCMA16B1 / KCMA17B1 / KCME13B1 / / KCME14B1 / KCME15B1 / KCME16B1 / KCME17B1 / KHMA13B2 für Ausrückgabel mit Nocken / for release fork with cams	(70)
		F3BE0681C	 3189 600 004		Getr. / GBox: ZF AS Tronic Rollenausführung / roller version	(58)
AD 260T45 W, AD 380T45 W, AT 260T45 W, AT 380T45 W AD 260T45, AD 380T45, AT 260T45, AT 380T45	03.06-	F3BE3681	 3400 700 366 ⊗ 3482 000 572 ⊗ 1878 004 132 ⊙ 3151 000 493	430 10 MFZ430 430WGTZ KZISZ-5	Getr. / GBox: 12AS2330TO HNEE16C1 / HXEB13C3 / KNEB11C1 / KNEB13C1 / / KNEB14C1 / KNEB15C1 / KNEE11C1 / KXEB12C3 / / KXEB12C6 / KXEB13C3 / HNEB12C1 / HNEB14C1 / / HNEE15C1 / KPEC12C4 / KSEB11C1 / KSEB13C1 / / KSEB71C1 / KSED13CA / KSEE11C1 / KSEE12C1 / / KSEE13C1 / KSEE14C1 / HPEC11C1 / HPEC14C1 / / HYEC13C3 für Ausrückgabel mit Rollen / for release fork with rollers	(71)
	03.06-		 3400 700 366 ⊗ 3482 000 572 ⊗ 1878 004 132 ⊙ 3151 000 493	430 10 MFZ430 430WGTZ KZISZ-5	Getr. / GBox: 16S2220TO KPEC11C4 für Ausrückgabel mit Rollen / for release fork with rollers	(71)
			 3400 700 461 ⊗ 3482 000 572 ⊗ 1878 004 132 ⊙ 3151 000 144	430 10 MFZ430 430WGTZ KZISZ-5	Getr. / GBox: 12AS2330TO KNEB11C1 / KNEB13C1 / KNEE11C1 / KNEB15C1 / / KNEE12C1 / KXEB13C3 / HNEB12C1 / KSEB11C1 / / KSEB12C1 / KSEB71C1 / KSED13CA / KSEE11C1 / / KSEE12C1 / KSEE13C1	
			 3400 700 461 ⊗ 3482 000 572 ⊗ 1878 004 132 ⊙ 3151 000 144	430 10 MFZ430 430WGTZ KZISZ-5	Getr. / GBox: 16S2220TO KNEB11A1 / KNEB12A1 / KXEB12A3 / KSEB11A1 / / KSEB12A1 / KSEB13A1 / KSEB71A1 / KSEB72A1 / / KSEE13A1	
		F3BE3681C, F3HFE611C	 3189 600 004		Getr. / GBox: ZF AS Tronic Rollenausführung / roller version	(58)

		CODE				
--	--	------	--	---	---	---

IVECO











Trakker		09.04 -			
AD 260T48, AT 260T48	06.05-	F3BE0681	 3400 117 801 ⊗ 3482 083 032 ⊗ 1878 085 741 ⊙ 3151 000 144	430 10 MFZ430 430WGTZ KZISZ-5	Getr. / GBox: 12AS2301OD KCSA12E1 / KCSA13E1 / KCSA14E1 / KCSE12E1 / KCSE14E1 / HCSA12E1 / HCSA13E1 / HCSA14E1 / HCSA16E1 / HCSE14E1 für Ausrückgabel mit Nocken / for release fork with cams (70)
			3400 700 435 ⊗ 3482 083 032 ⊗ 1878 085 741 ⊙ 3151 000 493	430 10 MFZ430 430WGTZ KZISZ-5	Getr. / GBox: 12AS2301OD KCSA12E1 / KCSA13E1 / KCSA14E1 / KCSE12E1 / KCSE14E1 / HCSA12E1 / HCSA13E1 / HCSA14E1 / HCSA16E1 / HCSE14E1 für Ausrückgabel mit Rollen / for release fork with rollers (71)
			 3400 700 435 ⊗ 3482 083 032 ⊗ 1878 085 741 ⊙ 3151 000 493	430 10 MFZ430 430WGTZ KZISZ-5	Getr. / GBox: 16S221OD KCSA12B1 / KCSA13B1 / KCSA14B1 / KCSE12B1 / KCSE14B1 / HCSA12B1 / HCSA13B1 / HCSA14B1 / HCSA15B1 / HCSA16B1 / HCSE13B1 / HCSE14B1 / HCSE16B1 für Ausrückgabel mit Rollen / for release fork with rollers (71)
			3400 117 801 ⊗ 3482 083 032 ⊗ 1878 085 741 ⊙ 3151 000 144	430 10 MFZ430 430WGTZ KZISZ-5	Getr. / GBox: 16S221OD KCSA12B1 / KCSA13B1 / KCSA14B1 / KCSE12B1 / KCSE14B1 / HCSA12B1 / HCSA13B1 / HCSA14B1 / HCSA15B1 / HCSA16B1 / HCSE13B1 / HCSE14B1 / HCSE16B1 für Ausrückgabel mit Nocken / for release fork with cams (70)
		F3BE0681E	 3189 600 004	Getr. / GBox: ZF AS Tronic Rollenausführung / roller version (58)	
AD 260T50, AD 380T50, AT 260T50, AT 380T50	03.06-	F3BE3681	 3400 700 366 ⊗ 3482 000 572 ⊗ 1878 004 132 ⊙ 3151 000 493	430 10 MFZ430 430WGTZ KZISZ-5	Getr. / GBox: 12AS2330TO KNFB11C1 / KNFB13C1 / KNFE15C1 / HNFB11C1 / HNFB12C1 / HNFB15C1 / HNFE15C1 / KPFC11C1 / KPFC11C4 / KPFC12C4 / HPFC14C1 für Ausrückgabel mit Rollen / for release fork with rollers (71)
			 3400 700 461 ⊗ 3482 000 572 ⊗ 1878 004 132 ⊙ 3151 000 144	430 10 MFZ430 430WGTZ KZISZ-5	Getr. / GBox: 12AS2330TO KNFB11C1 / HNFB11C1 / KPFC11C1
			 3400 700 461 ⊗ 3482 000 572 ⊗ 1878 004 132 ⊙ 3151 000 144	430 10 MFZ430 430WGTZ KZISZ-5	Getr. / GBox: 16S2520TO KPFC11A1 / KPFC12A1
		F3BE3681B, F3HFE611B	 3189 600 004	Getr. / GBox: ZF AS Tronic Rollenausführung / roller version (58)	
AD 340T35 B, AT 340T35 B	06.05-	F2BE0681	 3400 084 031 ⊗ 3482 078 134 ⊗ 1878 032 032 ⊙ 3151 000 144	400 10 MFZ400 400WGTZ KZISZ-5	Getr. / GBox: 12AS2301DD KERA11F1 / KERA12F1 / KERA13F1 / KERA13FA / KERG13FA / KERH13FA
			 3400 084 031 ⊗ 3482 078 134 ⊗ 1878 032 032 ⊙ 3151 000 144	400 10 MFZ400 400WGTZ KZISZ-5	Getr. / GBox: 16S151 KERA11A1 / KERA13A1 / KERA13AA / KERA71A1 / KERA73A1 / KERG13AA / KERG14AA
AD 340T36, AT 340T36 AD 340T36, AT 340T36	03.06 - 07.07-	F2BE3681	 3400 700 365 ⊗ 3482 000 573 ⊗ 1878 004 133 ⊙ 3151 000 493	430 10 MFZ430 430WGTZ KZISZ-5	Getr. / GBox: 12AS1930TD KSCD13CE / KSCF71C5 / HSCF14CA für Ausrückgabel mit Rollen / for release fork with rollers (71)
			F2BE3681A	 3189 600 004	Getr. / GBox: ZF AS Tronic Rollenausführung / roller version (58)

IVECO

Trakker		09.04 -			
AD 340T38 B, AT 34T38 B	06.05-	F3BE0681	 3400 117 801  3482 083 032  1878 085 741  3151 000 144	430 10 MFZ430 430WGTZ KZISZ-5	Getr. / GBox: 12AS2301OD KELA11E1 / KELA13E1 / KELA13EA / KELE13E1 / KELG13EA für Ausrückgabel mit Nocken / for release fork with cams (70)
			 3400 700 435  3482 083 032  1878 085 741  3151 000 493	430 10 MFZ430 430WGTZ KZISZ-5	Getr. / GBox: 12AS2301OD KELA11E1 / KELA13E1 / KELA13EA / KELE13E1 / KELG13EA für Ausrückgabel mit Rollen / for release fork with rollers (71)
			 3400 700 435  3482 083 032  1878 085 741  3151 000 493	430 10 MFZ430 430WGTZ KZISZ-5	Getr. / GBox: 16S1510D KELA11B1 / KELA12B1 / KELA13B1 / KELA13BA / KELA71B1 / KELA72B1 / KELA73B1 / KELC71B1 / KELE12B1 / KELE13B1 / KELG13BA / KELH14BA / KELH71B1 für Ausrückgabel mit Rollen / for release fork with rollers (71)
			 3400 117 801  3482 083 032  1878 085 741  3151 000 144	430 10 MFZ430 430WGTZ KZISZ-5	Getr. / GBox: 16S1510D KELA11B1 / KELA12B1 / KELA13B1 / KELA13BA / KELA71B1 / KELA72B1 / KELA73B1 / KELC71B1 / KELE12B1 / KELE13B1 / KELG13BA / KELH14BA / KELH71B1 für Ausrückgabel mit Nocken / for release fork with cams (70)
		F3BE0681G	 3189 600 004		Getr. / GBox: ZF AS Tronic Rollenausführung / roller version (58)
AD 340T41 B AD 340T41, AT 340T41 AD 340T41, AT 340T41	06.06- 06.06- 03.06-	F3BE3681	 3400 700 366  3482 000 572  1878 004 132  3151 000 493	430 10 MFZ430 430WGTZ KZISZ-5	Getr. / GBox: 12AS2330TO KSDB11C1 / KSDB12C1 / KSDB13C1 / KSDB13CA / KSDB14C1 / KSDB71C1 / KSDB73C1 / KSDB73C4 / KSDD13CA / KSDD13CE / KSDE11C1 / KSDF71C1 / HSDB12C1 / HSDB13C1 / HSDB14CA / HSDD14CA für Ausrückgabel mit Rollen / for release fork with rollers (71)
			 3400 700 461  3482 000 572  1878 004 132  3151 000 144	430 10 MFZ430 430WGTZ KZISZ-5	Getr. / GBox: 12AS2330TO KSDB13C1 / KSDB71C1 / KSDD13CA / HSDB14CA / HSDD14CA
			 3400 700 461  3482 000 572  1878 004 132  3151 000 144	430 10 MFZ430 430WGTZ KZISZ-5	Getr. / GBox: 16S2220TO KSDB11A1 / KSDB71A1 / KSDE12A1 / KSDE13A1 / KSDF71A1
		F3HFE611D, F3B3681D, F3BE3681D	 3189 600 004		Getr. / GBox: ZF AS Tronic Rollenausführung / roller version (58)
AD 340T44 B, AT 340T44 B	06.05-	F3BE0681	 3400 117 801  3482 083 032  1878 085 741  3151 000 144	430 10 MFZ430 430WGTZ KZISZ-5	Getr. / GBox: 12AS2301OD KEMA11E1 / KEMA12E1 / KEMA13E1 / KEMA13EA / KEME11E1 / KEME12E1 / KEME13E1 / KEMG13EA / HEMA11E1 / HEMA12E1 / HEMA12E1 / HEME13E1 für Ausrückgabel mit Nocken / for release fork with cams (70)
			 3400 700 435  3482 083 032  1878 085 741  3151 000 493	430 10 MFZ430 430WGTZ KZISZ-5	Getr. / GBox: 12AS2301OD KEMA11E1 / KEMA12E1 / KEMA13E1 / KEMA13EA / KEME11E1 / KEME12E1 / KEME13E1 / KEMG13EA / HEMA11E1 / HEMA12E1 / HEMA12E1 / HEME13E1 für Ausrückgabel mit Rollen / for release fork with rollers (71)
			 3400 700 435  3482 083 032  1878 085 741  3151 000 493	430 10 MFZ430 430WGTZ KZISZ-5	Getr. / GBox: 16S1810D KEMA11B1 / KEMA12B1 / KEMA13B1 / KEMA13BA / KEMA71B1 / KEMA73B1 / KEME11B1 / KEME12B1 / KEME13B1 / HEMA11B1 / HEMA12B1 / HEMA13B1 / HEMA14BA / HEMA72B1 / HEME12B1 / HEMG14BA für Ausrückgabel mit Rollen / for release fork with rollers (71)
			 3400 117 801  3482 083 032  1878 085 741  3151 000 144	430 10 MFZ430 430WGTZ KZISZ-5	Getr. / GBox: 16S1810D KEMA11B1 / KEMA12B1 / KEMA13B1 / KEMA13BA / KEMA71B1 / KEMA73B1 / KEME11B1 / KEME12B1 / KEME13B1 / HEMA11B1 / HEMA12B1 / HEMA13B1 / HEMA14BA / HEMA72B1 / HEME12B1 / HEMG14BA für Ausrückgabel mit Nocken / for release fork with cams (70)
		F3BE0681C	 3189 600 004		Getr. / GBox: ZF AS Tronic Rollenausführung / roller version (58)







		CODE				
--	--	------	--	---	---	---

IVECO



















Trakker		09.04 -				
AD 340T45 B AD 340T45, AD 340T45 /P, AT 340T45, AT 34T45 /P AD 340T45, AT 340T45	06.06 -	F3BE3681	 3400 700 366 3482 000 572 1878 004 132 3151 000 493	430 10 MFZ430 430WGTZ KZISZ-5	Getr. / GBox: 12AS2330TO KSEB11C4 / HSEB11C1 / HSEB12C1 / HSED14CA / HSEE13C1 für Ausrückgabel mit Rollen / for release fork with rollers (71)	
	06.06 -		 3400 700 461 3482 000 572 1878 004 132 3151 000 144	430 10 MFZ430 430WGTZ KZISZ-5	Getr. / GBox: 12AS2330TO HSEB11C1 / HSED14CA / HSEE12C1 / HSEE13C1	
	03.06 -	F3BE3681C, F3HFE611C, F3B3681C	 3189 600 004		Getr. / GBox: ZF AS Tronic Rollenausführung / roller version (58)	
AD 380T38 B AD 380T38, AT 380T38	06.05 - 01.05 -	F3BE0681	 3400 117 801 3482 083 032 1878 085 741 3151 000 144	430 10 MFZ430 430WGTZ KZISZ-5	Getr. / GBox: 12AS2301OD KCLD12E1 / KCLD12E2 / KCLD13E1 / KCLD14E1 / KCLD14E2 / KCLD15E1 / KCLD15E2 / KHL13E2 / KHL14E2 / KHL14EB / HELG14EA für Ausrückgabel mit Nocken / for release fork with cams (70)	
			3400 700 435 3482 083 032 1878 085 741 3151 000 493	430 10 MFZ430 430WGTZ KZISZ-5	Getr. / GBox: 12AS2301OD KCLD12E1 / KCLD12E2 / KCLD13E1 / KCLD14E1 / KCLD14E2 / KCLD15E1 / KCLD15E2 / KHL13E2 / KHL14E2 / KHL14EB / HELG14EA für Ausrückgabel mit Rollen / for release fork with rollers (71)	
			 3400 700 435 3482 083 032 1878 085 741 3151 000 493	430 10 MFZ430 430WGTZ KZISZ-5	Getr. / GBox: 16S1510D K3UBK3B1 / K3UBK4B1 / KCLD12B1 / KCLD12B2 / KCLD13B1 / KCLD13B2 / KCLD14B1 / KCLD15B1 / KCLD16B1 / KCLD72B1 / KCLD73B1 / KCLD74B1 / KHL13B2 / KHL14B2 / H3UAK3B1 / H3UAK4B1 / H3UAK5B1 / H3UBK4B1 / HCLD13B1 / HCLD14B1 / HCLD14B2 / HCLD15B1 / HCLD16B1 / HELA11B1 / HELA12B1 / HELA13B1 / HELA71B1 / HELG14BA / HHLD13B2 / HHLD14B2 / K3UAK2B1 / K3UAK3B1 / K3UAK3BA / K3UAK4B1 / K3UAK4BA / K3UAK5B1 / K3UAK6B1 für Ausrückgabel mit Rollen / for release fork with rollers (71)	
			 3400 117 801 3482 083 032 1878 085 741 3151 000 144	430 10 MFZ430 430WGTZ KZISZ-5	Getr. / GBox: 16S1510D K3UBK3B1 / K3UBK4B1 / KCLD12B1 / KCLD12B2 / KCLD13B1 / KCLD13B2 / KCLD14B1 / KCLD15B1 / KCLD16B1 / KCLD72B1 / KCLD73B1 / KCLD74B1 / KHL13B2 / KHL14B2 / H3UAK3B1 / H3UAK4B1 / H3UAK5B1 / H3UBK4B1 / HCLD13B1 / HCLD14B1 / HCLD14B2 / HCLD15B1 / HCLD16B1 / HELA11B1 / HELA12B1 / HELA13B1 / HELA71B1 / HELG14BA / HHLD13B2 / HHLD14B2 / K3UAK2B1 / K3UAK3B1 / K3UAK3BA / K3UAK4B1 / K3UAK4BA / K3UAK5B1 / K3UAK6B1 für Ausrückgabel mit Nocken / for release fork with cams (70)	
				 3400 117 801 3482 083 032 1878 085 741 3151 000 144	430 10 MFZ430 430WGTZ KZISZ-5	Getr. / GBox: 16S2210D KCLD13C1 / KCLD13C2 für Ausrückgabel mit Nocken / for release fork with cams (70)
				 3400 700 435 3482 083 032 1878 085 741 3151 000 493	430 10 MFZ430 430WGTZ KZISZ-5	Getr. / GBox: 16S2210D KCLD13C1 / KCLD13C2 für Ausrückgabel mit Rollen / for release fork with rollers (71)
		F3BE0681G	 3189 600 004		Getr. / GBox: ZF AS Tronic Rollenausführung / roller version (58)	
AD 380T41, AT 380T41	01.13 -	Cursor11	 3400 700 366 3482 000 572 1878 004 132 3151 000 493	430 10 MFZ430 430WGTZ KZISZ-5	Getr. / GBox: 16 S 1920 TD Getr. / GBox: 16 S 2220 TO Getr. / GBox: 12 AS 1930 TD Getr. / GBox: 12 AS 2330 TD Getr. / GBox: 12 AS 2330 TO Euro 6 / Euro 6 für Ausrückgabel mit Rollen / for release fork with rollers (18) (71)	
			F3HFE611D	 3189 600 004		Getr. / GBox: ZF AS Tronic Rollenausführung / roller version (58)

		CODE				
--	--	------	--	---	---	---

IVECO













Trakker		09.04 -			
AD 380T44 B AD 380T44 W, AT 380T44 W AD 380T44, AT 380T44	06.05-	F3BE0681	 3400 117 801 ⊗ 3482 083 032 ⊗ 1878 085 741 ⬢ 3151 000 144	430 10 MFZ430 430WGTZ KZISZ-5	Getr. / GBox: 12AS2301OD KCMD12E1 / KCMD13E1 / KCMD14E1 / KCMD14E2 / KCMD15E1 / KHMD13E2 / KHMD14E2 / KHMD14EB / HCMD13E1 / HCMD14E1 / HCMD15E1 / HHMD13E2 / HHMD14E2 für Ausrückgabel mit Nocken / for release fork with cams (70)
	06.05-		3400 700 435 ⊗ 3482 083 032 ⊗ 1878 085 741 ⬢ 3151 000 493	430 10 MFZ430 430WGTZ KZISZ-5	Getr. / GBox: 12AS2301OD KCMD12E1 / KCMD13E1 / KCMD14E1 / KCMD14E2 / KCMD15E1 / KHMD13E2 / KHMD14E2 / KHMD14EB / HCMD13E1 / HCMD14E1 / HCMD15E1 / HHMD13E2 / HHMD14E2 für Ausrückgabel mit Rollen / for release fork with rollers (71)
	06.05-		3400 700 435 ⊗ 3482 083 032 ⊗ 1878 085 741 ⬢ 3151 000 493	430 10 MFZ430 430WGTZ KZISZ-5	Getr. / GBox: 16S1810D KCMD12B1 / KCMD13B1 / KCMD14B1 / KCMD15B1 / KCMD72B1 / KHMD13B2 / KHMD14B2 / HCMD12B1 / HCMD13B1 / HCMD14B1 / HCMD16B1 / HHMD14B2 für Ausrückgabel mit Rollen / for release fork with rollers (71)
			3400 117 801 ⊗ 3482 083 032 ⊗ 1878 085 741 ⬢ 3151 000 144	430 10 MFZ430 430WGTZ KZISZ-5	Getr. / GBox: 16S1810D KCMD12B1 / KCMD13B1 / KCMD14B1 / KCMD15B1 / KCMD72B1 / KHMD13B2 / KHMD14B2 / HCMD12B1 / HCMD13B1 / HCMD14B1 / HCMD16B1 / HHMD14B2 für Ausrückgabel mit Nocken / for release fork with cams (70)
		F3BE0681C	 3189 600 004		Getr. / GBox: ZF AS Tronic Rollenausführung / roller version (58)
AD 380T48, AD 380T48	06.05-	F3BE0681	 3400 117 801 ⊗ 3482 083 032 ⊗ 1878 085 741 ⬢ 3151 000 144	430 10 MFZ430 430WGTZ KZISZ-5	Getr. / GBox: 12AS2301OD KCSD12E1 / KCSD14EA / KCSD15E1 / HCSD13E1 / HCSD15E1 für Ausrückgabel mit Nocken / for release fork with cams (70)
			3400 700 435 ⊗ 3482 083 032 ⊗ 1878 085 741 ⬢ 3151 000 493	430 10 MFZ430 430WGTZ KZISZ-5	Getr. / GBox: 12AS2301OD KCSD12E1 / KCSD14EA / KCSD15E1 / HCSD13E1 / HCSD15E1 für Ausrückgabel mit Rollen / for release fork with rollers (71)
			3400 700 435 ⊗ 3482 083 032 ⊗ 1878 085 741 ⬢ 3151 000 493	430 10 MFZ430 430WGTZ KZISZ-5	Getr. / GBox: 16S2210D KCSD12B1 / KCSD13B1 / KCSD14B1 / KCSD15B1 / HCSD12B1 / HCSD13B1 / HCSD14B1 / HCSD15B1 für Ausrückgabel mit Rollen / for release fork with rollers (71)
			3400 117 801 ⊗ 3482 083 032 ⊗ 1878 085 741 ⬢ 3151 000 144	430 10 MFZ430 430WGTZ KZISZ-5	Getr. / GBox: 16S2210D KCSD12B1 / KCSD13B1 / KCSD14B1 / KCSD15B1 / HCSD12B1 / HCSD13B1 / HCSD14B1 / HCSD15B1 für Ausrückgabel mit Nocken / for release fork with cams (70)
		F3BE0681E	 3189 600 004		Getr. / GBox: ZF AS Tronic Rollenausführung / roller version (58)
AD 400T35 T, AT 400T35 T	06.05-	F2BE0681	 3400 084 031 ⊗ 3482 078 134 ⊗ 1878 032 032 ⬢ 3151 000 144	400 10 MFZ400 400WGTZ KZISZ-5	Getr. / GBox: 16S151 KBRA22A1 / KBRA21A1
AD 400T36 T, AT 400T36 T	10.04-	F2BE3681	 3400 700 378 ⊗ 3482 000 573 ⊗ 1878 004 133 ⬢ 3151 000 144	430 10 MFZ430 430WGTZ KZISZ-5	Getr. / GBox: 16S1620TD KMCA21A1 für Ausrückgabel mit Nocken / for release fork with cams (70)

IVECO

Trakker		09.04 -					
AD 400T38 T, AT 400T38 T AD 400T38 WT, AT 400T38 WT	06.05 -	F3BE0681		3400 117 801 3482 083 032 1878 085 741 3151 000 144	430 10 MFZ430 430WGTZ KZISZ-5	Getr. / GBox: 12AS2301OD KGLA23E2 / HBLA22E1 für Ausrückgabel mit Nocken / for release fork with cams	(70)
	06.05 -			3400 700 435 3482 083 032 1878 085 741 3151 000 493	430 10 MFZ430 430WGTZ KZISZ-5	Getr. / GBox: 12AS2301OD KGLA23E2 / HBLA22E1 für Ausrückgabel mit Rollen / for release fork with rollers	(71)
				3400 700 435 3482 083 032 1878 085 741 3151 000 493	430 10 MFZ430 430WGTZ KZISZ-5	Getr. / GBox: 16S151OD K0UAH1B1 / K0UAH2B1 / K5UAK1B1 / K5UAK3B1 / K5UAK4B1 / KBLA21B1 / KBLA22B1 / KGLA23B2 / H0UAH1B1 / H0UAH2B1 / HBLA22B1 / HGLA23B2 für Ausrückgabel mit Rollen / for release fork with rollers	(71)
				3400 117 801 3482 083 032 1878 085 741 3151 000 144	430 10 MFZ430 430WGTZ KZISZ-5	Getr. / GBox: 16S151OD K0UAH1B1 / K0UAH2B1 / K5UAK1B1 / K5UAK3B1 / K5UAK4B1 / KBLA21B1 / KBLA22B1 / KGLA23B2 / H0UAH1B1 / H0UAH2B1 / HBLA22B1 / HGLA23B2 für Ausrückgabel mit Nocken / for release fork with cams	(70)
		F3BE0681G		3189 600 004		Getr. / GBox: ZF AS Tronic Rollenausführung / roller version	(58)
AD 400T41 T, AT 400T41 T AD 400T41 WT, AT 400T41 WT	03.06 -	F3BE3681		3400 700 366 3482 000 572 1878 004 132 3151 000 493	430 10 MFZ430 430WGTZ KZISZ-5	Getr. / GBox: 12AS2330TO KMDB22C1 / KVDA22C3 / HMDA22C1 / HVDA22C3 für Ausrückgabel mit Rollen / for release fork with rollers	(71)
	03.06 -			3400 700 461 3482 000 572 1878 004 132 3151 000 144	430 10 MFZ430 430WGTZ KZISZ-5	Getr. / GBox: 12AS2330TO HVDA22C3	
				3400 700 461 3482 000 572 1878 004 132 3151 000 144	430 10 MFZ430 430WGTZ KZISZ-5	Getr. / GBox: 16S2220TO KVDA22A3	
				F3HFE611D, F3BE3681D	3189 600 004		Getr. / GBox: ZF AS Tronic Rollenausführung / roller version
AD 400T44 T, AT 400T44 T AD 400T44 WT, AT 400T44 WT	06.05 -	F3BE0681		3400 117 801 3482 083 032 1878 085 741 3151 000 144	430 10 MFZ430 430WGTZ KZISZ-5	Getr. / GBox: 12AS2301OD KBMA21E1 / KBMA22E1 / KGMA23E2 / HBMA22E1 / HDMA22E1 / HDME22E1 / HGMA23E2 für Ausrückgabel mit Nocken / for release fork with cams	(70)
	06.05 -			3400 700 435 3482 083 032 1878 085 741 3151 000 493	430 10 MFZ430 430WGTZ KZISZ-5	Getr. / GBox: 12AS2301OD KBMA21E1 / KBMA22E1 / KGMA23E2 / HBMA22E1 / HDMA22E1 / HDME22E1 / HGMA23E2 für Ausrückgabel mit Rollen / for release fork with rollers	(71)
				3400 700 435 3482 083 032 1878 085 741 3151 000 493	430 10 MFZ430 430WGTZ KZISZ-5	Getr. / GBox: 16S181OD KBMA21B1 / KBMA22B1 / KBMA22B2 / KGMA23B2 / HBMA22B1 / HBMA22B2 / HDMA22B1 / HDME22B1 / HGMA23B2 für Ausrückgabel mit Rollen / for release fork with rollers	(71)
				3400 117 801 3482 083 032 1878 085 741 3151 000 144	430 10 MFZ430 430WGTZ KZISZ-5	Getr. / GBox: 16S181OD KBMA21B1 / KBMA22B1 / KBMA22B2 / KGMA23B2 / HBMA22B1 / HBMA22B2 / HDMA22B1 / HDME22B1 / HGMA23B2 für Ausrückgabel mit Nocken / for release fork with cams	(70)
		F3BE0681C		3189 600 004		Getr. / GBox: ZF AS Tronic Rollenausführung / roller version	(58)
AD 400T45 T, AT 400T45 T AD 400T45 WT, AT 400T45 WT	03.06 -	F3BE3681		3400 700 366 3482 000 572 1878 004 132 3151 000 493	430 10 MFZ430 430WGTZ KZISZ-5	Getr. / GBox: 12AS2330TO KMEA22C1 / KVEA22C3 / HMEA22C1 / HVEA22C6 für Ausrückgabel mit Rollen / for release fork with rollers	(71)
	03.06 -			3400 700 461 3482 000 572 1878 004 132 3151 000 144	430 10 MFZ430 430WGTZ KZISZ-5	Getr. / GBox: 12AS2330TO KMEA22C1 / HMEA22C1 / HVEA22C3	
				3400 700 461 3482 000 572 1878 004 132 3151 000 144	430 10 MFZ430 430WGTZ KZISZ-5	Getr. / GBox: 16S2220TO KMEA22A1 / KVEA22A3 / HMEB22A1	
				F3BE3681C, F3HFE611C	3189 600 004		Getr. / GBox: ZF AS Tronic Rollenausführung / roller version
AD 400T50 T, AT 400T50 T	03.06 -	F3BE3681		3400 700 461 3482 000 572 1878 004 132 3151 000 144	430 10 MFZ430 430WGTZ KZISZ-5	Getr. / GBox: 12AS2330TO HMF22C1	

















		CODE				
--	--	------	--	---	---	---

IVECO

Trakker		09.04 -					
AD 410T36, AT 410T36	03.06-	F2BE3681	 3400 700 365 ⊗ 3482 000 573 ⊗ 1878 004 133 ⊙ 3151 000 493	430 10 MFZ430 430WGTZ KZISZ-5	Getr. / GBox: 12AS1930TD KTCC14CA für Ausrückgabel mit Rollen / for release fork with rollers	(71)	
		F2BE3681A	 3189 600 004		Getr. / GBox: ZF AS Tronic Rollenausführung / roller version	(58)	
AD 410T38 B, AT 410T38 B	06.05-	F3BE0681	 3400 117 801 ⊗ 3482 083 032 ⊗ 1878 085 741 ⊙ 3151 000 144	430 10 MFZ430 430WGTZ KZISZ-5	Getr. / GBox: 12AS2301OD KELD11E1 / KELD12E1 / KELD13E1 / KELD14E1 / HELD13E1 / HELD14E1 für Ausrückgabel mit Nocken / for release fork with cams	(70)	
			3400 700 435 ⊗ 3482 083 032 ⊗ 1878 085 741 ⊙ 3151 000 493	430 10 MFZ430 430WGTZ KZISZ-5	Getr. / GBox: 12AS2301OD KELD11E1 / KELD12E1 / KELD13E1 / KELD14E1 / HELD13E1 / HELD14E1 für Ausrückgabel mit Rollen / for release fork with rollers	(71)	
			 3400 700 435 ⊗ 3482 083 032 ⊗ 1878 085 741 ⊙ 3151 000 493	430 10 MFZ430 430WGTZ KZISZ-5	Getr. / GBox: 16S1510D KELD11B1 / KELD11B2 / KELD12B1 / KELD13B1 / KELD13B2 / KELD14B1 / KELD71B1 / KELD72B1 / KELD73B1 / HELD13B1 für Ausrückgabel mit Rollen / for release fork with rollers	(71)	
			3400 117 801 ⊗ 3482 083 032 ⊗ 1878 085 741 ⊙ 3151 000 144	430 10 MFZ430 430WGTZ KZISZ-5	Getr. / GBox: 16S1510D KELD11B1 / KELD11B2 / KELD12B1 / KELD13B1 / KELD13B2 / KELD14B1 / KELD71B1 / KELD72B1 / KELD73B1 / HELD13B1 für Ausrückgabel mit Nocken / for release fork with cams	(70)	
		F3BE0681G	 3189 600 004		Getr. / GBox: ZF AS Tronic Rollenausführung / roller version	(58)	
AD 410T44 B, AT 410T44 B	06.05-	F3BE0681	 3400 117 801 ⊗ 3482 083 032 ⊗ 1878 085 741 ⊙ 3151 000 144	430 10 MFZ430 430WGTZ KZISZ-5	Getr. / GBox: 12AS2301OD KEMD11E1 / KEMD12E1 / KEMD12E2 / KEMD13E1 / KEMD13EB / KEMD14E1 / KKMD12E2 / HEMD11E1 / HEMD12E1 für Ausrückgabel mit Nocken / for release fork with cams	(70)	
			3400 700 435 ⊗ 3482 083 032 ⊗ 1878 085 741 ⊙ 3151 000 493	430 10 MFZ430 430WGTZ KZISZ-5	Getr. / GBox: 12AS2301OD KEMD11E1 / KEMD12E1 / KEMD12E2 / KEMD13E1 / KEMD13EB / KEMD14E1 / KKMD12E2 / HEMD11E1 / HEMD12E1 für Ausrückgabel mit Rollen / for release fork with rollers	(71)	
			 3400 700 435 ⊗ 3482 083 032 ⊗ 1878 085 741 ⊙ 3151 000 493	430 10 MFZ430 430WGTZ KZISZ-5	Getr. / GBox: 16S1810D KEMD11B1 / KEMD11B2 / KEMD12B1 / KEMD12B2 / KEMD13B1 / KEMD13B2 / KEMD13BA / KEMD14B1 / KEMD71B1 / KEMD71BA / KEMD72B1 / KEMD73B1 / KKMD12B2 / HEMD11B1 / HEMD12B1 / HEMD13B1 für Ausrückgabel mit Rollen / for release fork with rollers	(71)	
			3400 117 801 ⊗ 3482 083 032 ⊗ 1878 085 741 ⊙ 3151 000 144	430 10 MFZ430 430WGTZ KZISZ-5	Getr. / GBox: 16S1810D KEMD11B1 / KEMD11B2 / KEMD12B1 / KEMD12B2 / KEMD13B1 / KEMD13B2 / KEMD13BA / KEMD14B1 / KEMD71B1 / KEMD71BA / KEMD72B1 / KEMD73B1 / KKMD12B2 / HEMD11B1 / HEMD12B1 / HEMD13B1 für Ausrückgabel mit Nocken / for release fork with cams	(70)	
		F3BE0681C	 3189 600 004		Getr. / GBox: ZF AS Tronic Rollenausführung / roller version	(58)	
AD 410T45 W AD 410T45 W AD 410T45, AT 410T45 AD 410T45, AT 410T45	03.06- 07.07- 03.06- 06.06-	F3BE3681	 3400 700 366 ⊗ 3482 000 572 ⊗ 1878 004 132 ⊙ 3151 000 493	430 10 MFZ430 430WGTZ KZISZ-5	Getr. / GBox: 12AS2330TO KWEC13C3 / HTEC11C1 / KTEC11C1 / KTEC12C1 / KTEC12C4 / KTEC13C1 / KTEE14C4 / KWEC12C3 / KWEC12C6 für Ausrückgabel mit Rollen / for release fork with rollers	(71)	
			 3400 700 461 ⊗ 3482 000 572 ⊗ 1878 004 132 ⊙ 3151 000 144	430 10 MFZ430 430WGTZ KZISZ-5	Getr. / GBox: 12AS2330TO KWEC13C3 / HTEC11C1 / KTEC11C1 / KTEC12C1 / KTEC13C1 / KWEC12C3		
			 3400 700 461 ⊗ 3482 000 572 ⊗ 1878 004 132 ⊙ 3151 000 144	430 10 MFZ430 430WGTZ KZISZ-5	Getr. / GBox: 16S2220TO HTEC11A1 / HTEC13A1 / KTEC11A1 / KTEC12A1 / KTEC14A1 / KWEC12A3		
	F3BE3681C, F3HFE611C, F3B3681C	 3189 600 004		Getr. / GBox: ZF AS Tronic Rollenausführung / roller version	(58)		













IVECO

Trakker		09.04 -					
AD 410T48 B, AT 410T48 B	06.05 -	F3BE0681		3400 117 801 ● 3482 083 032 ● 1878 085 741 ● 3151 000 144	430 10 MFZ430 430WGTZ KZISZ-5	Getr. / GBox: 12AS2301OD KESD11E1 / KESD12E1 / KESD13E1 / KESD14E1 / HESD11E1 / HESD12E1 / HESD13E1 / HESD14E1 für Ausrückgabel mit Nocken / for release fork with cams	(70)
				3400 700 435 ● 3482 083 032 ● 1878 085 741 ● 3151 000 493	430 10 MFZ430 430WGTZ KZISZ-5	Getr. / GBox: 12AS2301OD KESD11E1 / KESD12E1 / KESD13E1 / KESD14E1 / HESD11E1 / HESD12E1 / HESD13E1 / HESD14E1 für Ausrückgabel mit Rollen / for release fork with rollers	(71)
				3400 700 435 ● 3482 083 032 ● 1878 085 741 ● 3151 000 493	430 10 MFZ430 430WGTZ KZISZ-5	Getr. / GBox: 16S221OD KESD11B1 / KESD11B2 / KESD12B1 / KESD13B1 / KESD13B2 / KESD14B1 / HESD11B1 / HESD11B2 / HESD12B1 / HESD13B1 / HESD14B1 / HESD14B2 für Ausrückgabel mit Rollen / for release fork with rollers	(71)
				3400 117 801 ● 3482 083 032 ● 1878 085 741 ● 3151 000 144	430 10 MFZ430 430WGTZ KZISZ-5	Getr. / GBox: 16S221OD KESD11B1 / KESD11B2 / KESD12B1 / KESD13B1 / KESD13B2 / KESD14B1 / HESD11B1 / HESD11B2 / HESD12B1 / HESD13B1 / HESD14B1 / HESD14B2 für Ausrückgabel mit Nocken / for release fork with cams	(70)
		F3BE0681E		3189 600 004		Getr. / GBox: ZF AS Tronic Rollenausführung / roller version	(58)
AD 410T48, AT 410T48 AD 720T48 T, AT 720T48 T	02.05 - 06.05 -	F3BE0681		3400 117 801 ● 3482 083 032 ● 1878 085 741 ● 3151 000 144	430 10 MFZ430 430WGTZ KZISZ-5	Getr. / GBox: 12AS2301OD KDSD22E1 / HDSD22E1 für Ausrückgabel mit Nocken / for release fork with cams	(70)
				3400 700 435 ● 3482 083 032 ● 1878 085 741 ● 3151 000 493	430 10 MFZ430 430WGTZ KZISZ-5	Getr. / GBox: 12AS2301OD KDSD22E1 / HDSD22E1 für Ausrückgabel mit Rollen / for release fork with rollers	(71)
				3400 700 435 ● 3482 083 032 ● 1878 085 741 ● 3151 000 493	430 10 MFZ430 430WGTZ KZISZ-5	Getr. / GBox: 16S221OD KDSD22B1 / KDSD22B2 / HDSD22B1 / HDSD22B2 für Ausrückgabel mit Rollen / for release fork with rollers	(71)
				3400 117 801 ● 3482 083 032 ● 1878 085 741 ● 3151 000 144	430 10 MFZ430 430WGTZ KZISZ-5	Getr. / GBox: 16S221OD KDSD22B1 / KDSD22B2 / HDSD22B1 / HDSD22B2 für Ausrückgabel mit Nocken / for release fork with cams	(70)
		F3BE0681E		3189 600 004		Getr. / GBox: ZF AS Tronic Rollenausführung / roller version	(58)
AD 410T50, AT 410T50 AD 410T50, AT 410T50	03.06 - 06.06 -	F3BE3681		3400 700 366 ● 3482 000 572 ● 1878 004 132 ● 3151 000 493	430 10 MFZ430 430WGTZ KZISZ-5	Getr. / GBox: 12AS2330TO KTFC11C1 / KTFC11C4 / KTFC14C4 / KTFE11C4 / HTFC11C1 / HTFC12C1 / HTFC14C1 / HTFE13C4 für Ausrückgabel mit Rollen / for release fork with rollers	(71)
				3400 700 461 ● 3482 000 572 ● 1878 004 132 ● 3151 000 144	430 10 MFZ430 430WGTZ KZISZ-5	Getr. / GBox: 12AS2330TO KTFC11C1 / HTFC11C1 / HTFC14C1	
				3400 700 461 ● 3482 000 572 ● 1878 004 132 ● 3151 000 144	430 10 MFZ430 430WGTZ KZISZ-5	Getr. / GBox: 16S2520TO KTFE11A1 / KTFE12A1 / KTFE13A1 / KTFE14A1 / HTFC11A1	
		F3HFE611/500, F3BE3681B, F3BE0681B		3189 600 004		Getr. / GBox: ZF AS Tronic Rollenausführung / roller version	(58)
AD 440T38 T, AT 440T38 T	04.05 -	F3BE0681		3400 117 801 ● 3482 083 032 ● 1878 085 741 ● 3151 000 144	430 10 MFZ430 430WGTZ KZISZ-5	Getr. / GBox: 16S151OD KDLE22B1 für Ausrückgabel mit Nocken / for release fork with cams	(70)
				3400 700 435 ● 3482 083 032 ● 1878 085 741 ● 3151 000 493	430 10 MFZ430 430WGTZ KZISZ-5	Getr. / GBox: 16S151OD KDLE22B1 für Ausrückgabel mit Rollen / for release fork with rollers	(71)
				F3BE0681G		3189 600 004	
AD 440T41 T, AT 440T41 T	03.06 -	F3BE3681		3400 700 366 ● 3482 000 572 ● 1878 004 132 ● 3151 000 493	430 10 MFZ430 430WGTZ KZISZ-5	Getr. / GBox: 12AS2330TO HQDB21CA / HQDE21C1 für Ausrückgabel mit Rollen / for release fork with rollers	(71)
				3400 700 461 ● 3482 000 572 ● 1878 004 132 ● 3151 000 144	430 10 MFZ430 430WGTZ KZISZ-5	Getr. / GBox: 12AS2330TO HQDB21CA / HQDE21C1	
				F3BE3681D		3189 600 004	











Trakker		09.04 -					
AD 440T44 B AD 440T44 T, AT 440T44T	06.05 -	F3BE0681		3400 117 801 ⊗ 3482 083 032 ⊗ 1878 085 741 ⊙ 3151 000 144	430 10 MFZ430 430WGTZ KZISZ-5	Getr. / GBox: 12AS2301OD KDMA22E1 / KDMA22EA / KDME22E1 für Ausrückgabel mit Nocken / for release fork with cams	(70)
	06.05 -			3400 700 435 ⊗ 3482 083 032 ⊗ 1878 085 741 ⊙ 3151 000 493	430 10 MFZ430 430WGTZ KZISZ-5	Getr. / GBox: 12AS2301OD KDMA22E1 / KDMA22EA / KDME22E1 für Ausrückgabel mit Rollen / for release fork with rollers	(71)
				3400 700 435 ⊗ 3482 083 032 ⊗ 1878 085 741 ⊙ 3151 000 493	430 10 MFZ430 430WGTZ KZISZ-5	Getr. / GBox: 16S181OD KDMA22B1 / KDME22B1 für Ausrückgabel mit Rollen / for release fork with rollers	(71)
				3400 117 801 ⊗ 3482 083 032 ⊗ 1878 085 741 ⊙ 3151 000 144	430 10 MFZ430 430WGTZ KZISZ-5	Getr. / GBox: 16S181OD KDMA22B1 / KDME22B1 für Ausrückgabel mit Nocken / for release fork with cams	(70)
		F3BE0681C		3189 600 004		Getr. / GBox: ZF AS Tronic Rollenausführung / roller version	(58)
AD 440T45 T, AT 440T45 T	03.06 -	F3BE3681		3400 700 366 ⊗ 3482 000 572 ⊗ 1878 004 132 ⊙ 3151 000 493	430 10 MFZ430 430WGTZ KZISZ-5	Getr. / GBox: 12AS2330TO KQEB21C1 / HQEB21CA / HQEE21C1 für Ausrückgabel mit Rollen / for release fork with rollers	(71)
				3400 700 366 ⊗ 3482 000 572 ⊗ 1878 004 132 ⊙ 3151 000 493	430 10 MFZ430 430WGTZ KZISZ-5	Getr. / GBox: 16S2220TO KQEE21C1 für Ausrückgabel mit Rollen / for release fork with rollers	(71)
				3400 700 461 ⊗ 3482 000 572 ⊗ 1878 004 132 ⊙ 3151 000 144	430 10 MFZ430 430WGTZ KZISZ-5	Getr. / GBox: 12AS2330TO HQEB21CA / HQEE21C1	
			F3BE3681C, F3HFE611C		3189 600 004		Getr. / GBox: ZF AS Tronic Rollenausführung / roller version
AD 440T50 T, AT 440T50 T	03.06 -	F3BE3681		3400 700 366 ⊗ 3482 000 572 ⊗ 1878 004 132 ⊙ 3151 000 493	430 10 MFZ430 430WGTZ KZISZ-5	Getr. / GBox: 12AS2330TO HQFE21C1 für Ausrückgabel mit Rollen / for release fork with rollers	(71)
				3400 700 461 ⊗ 3482 000 572 ⊗ 1878 004 132 ⊙ 3151 000 144	430 10 MFZ430 430WGTZ KZISZ-5	Getr. / GBox: 12AS2330TO HQFE21C1	
				3400 700 461 ⊗ 3482 000 572 ⊗ 1878 004 132 ⊙ 3151 000 144	430 10 MFZ430 430WGTZ KZISZ-5	Getr. / GBox: 16S2520TO KQFB21A1	
			F3BE3681B, F3HFE611B		3189 600 004		Getr. / GBox: ZF AS Tronic Rollenausführung / roller version
AD 720T38 T, AT 720T38 T AD 720T38 WT, AT 720T38 WT	06.05 -	F3BE0681		3400 117 801 ⊗ 3482 083 032 ⊗ 1878 085 741 ⊙ 3151 000 144	430 10 MFZ430 430WGTZ KZISZ-5	Getr. / GBox: 16S151OD K3UAH2B1 / K3UAH3B1 / K3UBH4B1 / KDLD22B1 / KJLD23B2 / H3UAH3B1 / H3UBH3B1 / H3UBH4B1 / HDLD22B1 / HDLD22B2 für Ausrückgabel mit Nocken / for release fork with cams	(70)
	06.05 -			3400 700 435 ⊗ 3482 083 032 ⊗ 1878 085 741 ⊙ 3151 000 493	430 10 MFZ430 430WGTZ KZISZ-5	Getr. / GBox: 16S151OD K3UAH2B1 / K3UAH3B1 / K3UBH4B1 / KDLD22B1 / KJLD23B2 / H3UAH3B1 / H3UBH3B1 / H3UBH4B1 / HDLD22B1 / HDLD22B2 für Ausrückgabel mit Rollen / for release fork with rollers	(71)
			F3BE0681G		3189 600 004		Getr. / GBox: ZF AS Tronic Rollenausführung / roller version

		CODE				
--	--	------	--	---	---	---

IVECO















Trakker		09.04 -				
AD 720T44 T, AT 720T44 T AD 720T44 WT, AT 720T44 WT	06.05 -	F3BE0681	 3400 117 801 ⊗ 3482 083 032 ⊗ 1878 085 741 ⊙ 3151 000 144	430 10 MFZ430 430WGTZ KZISZ-5	Getr. / GBox: 12AS2301OD KDMD22E1 / KDMD22EA / KJMD23E2 / HDMD22E1 / HDMD22EA / HJMD23E2 für Ausrückgabel mit Nocken / for release fork with cams	(70)
	06.05 -		 3400 700 435 ⊗ 3482 083 032 ⊗ 1878 085 741 ⊙ 3151 000 493	430 10 MFZ430 430WGTZ KZISZ-5	Getr. / GBox: 12AS2301OD KDMD22E1 / KDMD22EA / KJMD23E2 / HDMD22E1 / HDMD22EA / HJMD23E2 für Ausrückgabel mit Rollen / for release fork with rollers	(71)
			 3400 700 435 ⊗ 3482 083 032 ⊗ 1878 085 741 ⊙ 3151 000 493	430 10 MFZ430 430WGTZ KZISZ-5	Getr. / GBox: 16S1810D KDMD22B1 / KDMD22B2 / KJMD23B2 / HDMD22B1 / HDMD22B2 / HJMD23B2 für Ausrückgabel mit Rollen / for release fork with rollers	(71)
			 3400 117 801 ⊗ 3482 083 032 ⊗ 1878 085 741 ⊙ 3151 000 144	430 10 MFZ430 430WGTZ KZISZ-5	Getr. / GBox: 16S1810D KDMD22B1 / KDMD22B2 / KJMD23B2 / HDMD22B1 / HDMD22B2 / HJMD23B2 für Ausrückgabel mit Nocken / for release fork with cams	(70)
		F3BE0681C	 3189 600 004		Getr. / GBox: ZF AS Tronic Rollenausführung / roller version	(58)
AD 720T45 T, AT 720T45 T AD 720T45 WT, AT 720T45 WT	03.06 -	F3BE3681	 3400 700 366 ⊗ 3482 000 572 ⊗ 1878 004 132 ⊙ 3151 000 493	430 10 MFZ430 430WGTZ KZISZ-5	Getr. / GBox: 12AS2330TO KREC21C1 / KZEC21C3 / HREC21C1 für Ausrückgabel mit Rollen / for release fork with rollers	(71)
			 3400 700 461 ⊗ 3482 000 572 ⊗ 1878 004 132 ⊙ 3151 000 144	430 10 MFZ430 430WGTZ KZISZ-5	Getr. / GBox: 12AS2330TO HREC21C1 / HZEC21C3	
			 3400 700 461 ⊗ 3482 000 572 ⊗ 1878 004 132 ⊙ 3151 000 144	430 10 MFZ430 430WGTZ KZISZ-5	Getr. / GBox: 16S2220TO KREC21A1 / KZEC21A3	
			F3BE3681C, F3HFE611C	 3189 600 004		Getr. / GBox: ZF AS Tronic Rollenausführung / roller version
AD 720T50 T, AT 720T50 T, AT 720T50 TP	03.06 -	F3BE3681	 3400 700 366 ⊗ 3482 000 572 ⊗ 1878 004 132 ⊙ 3151 000 493	430 10 MFZ430 430WGTZ KZISZ-5	Getr. / GBox: 12AS2330TO KRFC21C1 / HRFC21C1 / HRFE21C4 für Ausrückgabel mit Rollen / for release fork with rollers	(71)
			 3400 700 461 ⊗ 3482 000 572 ⊗ 1878 004 132 ⊙ 3151 000 144	430 10 MFZ430 430WGTZ KZISZ-5	Getr. / GBox: 12AS2330TO KRFC21C1 / HRFC21C1	
			 3400 700 461 ⊗ 3482 000 572 ⊗ 1878 004 132 ⊙ 3151 000 144	430 10 MFZ430 430WGTZ KZISZ-5	Getr. / GBox: 16S2520TO KRFC21A1 / HRFC21A1	
			F3BE3681B, F3HFE611B	 3189 600 004		Getr. / GBox: ZF AS Tronic Rollenausführung / roller version

IVECO



















TurboStar		07.84 - 12.93						
190-33 190-33 T	07.84 - 09.86	8210.22.105	 3400 700 454 ■	430 10	->Chass. 140027 Getr. / GBox: Fuller Nabenprofil / Hub Profile: 41,1x50,8-10N Ausrückgabel hängend [mm] / Release Fork, suspended [mm]: 125	(48)	(4)	
	07.84 - 09.86		 3482 083 040	430 MFZ430	->Chass. 140027 Getr. / GBox: Fuller In 3483/3488 enthalten / Contained in 3483, 3488	(32)		
			 3100 002 038 ◆ 3151 123 031 ◎ 3180 001 008	KZIZ5 KZI/Z-5	09.1984 - Chass. 140027 Getr. / GBox: Fuller Beinhaltet Ausrücker und Montagesatz / Contains releaser and fitting kit In 3483/3488 enthalten / Contained in 3483, 3488	(9)	(32)	
			 3483 010 138 ⊕	430 GMFZ430	09.1984 - Chass. 140027 Getr. / GBox: Fuller Beinhaltet Ausrücker und Montagesatz / Contains releaser and fitting kit	(9)		
			 1861 992 432	430 10 430GVZ	09.1984 - Chass. 140027 Getr. / GBox: Fuller			
			 3482 043 134	430 GMFZ430	09.1984 - Chass. 140027 Getr. / GBox: Fuller In 3483/3488 enthalten / Contained in 3483, 3488	(32)		
			 3400 700 456 ■	430 10	Chass. 140028-> Getr. / GBox: Fuller Nabenprofil / Hub Profile: 41,1x50,8-10N Ausrückgabel stehend [mm] / Release Fork, upright [mm]: 86	(48)	(5)	
			 3400 700 457 ■	430 10	Chass. 140028-> Getr. / GBox: ZF Nabenprofil / Hub Profile: 41,1x50,8-10N	(48)		
			 3482 083 040	430 MFZ430	Chass. 140028-> Getr. / GBox: ZF Getr. / GBox: Fuller In 3483/3488 enthalten / Contained in 3483, 3488	(32)		
			 3100 002 040 ◆ 3151 000 148 ◎ 3180 001 008	KZIZ5	Chass. 140028-> Getr. / GBox: ZF Getr. / GBox: Fuller Beinhaltet Ausrücker und Montagesatz / Contains releaser and fitting kit In 3483/3488 enthalten / Contained in 3483, 3488	(9)	(32)	

		CODE				
--	--	------	--	---	---	---

IVECO













TurboStar		07.84 - 12.93				
190-33 190-33 P 190-33 T	10.86 - 05.87	8210.22.105	 3400 700 454 ■	430 10	-> Chass. 140027 Getr. / GBox: Fuller Nabenprofil / Hub Profile: 41,1x50,8-10N Ausrückgabel hängend [mm] / Release Fork, suspended [mm]: 125	(48) (4)
	01.86 - 12.87		 3482 083 040	430 MFZ430	-> Chass. 140027 Getr. / GBox: Fuller In 3483/3488 enthalten / Contained in 3483, 3488	(32)
	10.86 - 05.87		 3100 002 038 ◆ 3151 123 031 ◎ 3180 001 008	KZIZ5 KZI/Z-5	-> Chass. 140027 Getr. / GBox: Fuller Beinhaltet Ausrücker und Montagesatz / Contains releaser and fitting kit In 3483/3488 enthalten / Contained in 3483, 3488	(9) (32)
			 3483 010 138 ⊕	430 GMFZ430	-> Chass. 140027 Getr. / GBox: Fuller Beinhaltet Ausrücker und Montagesatz / Contains releaser and fitting kit	(9)
			 1861 992 432	430 10 430GVZ	-> Chass. 140027 Getr. / GBox: Fuller	
			 3482 043 134	430 GMFZ430	-> Chass. 140027 Getr. / GBox: Fuller In 3483/3488 enthalten / Contained in 3483, 3488	(32)
			 3400 700 456 ■	430 10	Chass. 140028-> Getr. / GBox: Fuller Nabenprofil / Hub Profile: 41,1x50,8-10N Ausrückgabel stehend [mm] / Release Fork, upright [mm]: 86	(48) (5)
			 3400 700 457 ■	430 10	Chass. 140028-> Getr. / GBox: ZF Nabenprofil / Hub Profile: 41,1x50,8-10N	(48)
			 3482 083 040	430 MFZ430	Chass. 140028-> Getr. / GBox: Fuller Getr. / GBox: ZF In 3483/3488 enthalten / Contained in 3483, 3488	(32)
			 3100 002 040 ◆ 3151 000 148 ◎ 3180 001 008	KZIZ5	Chass. 140028-> Getr. / GBox: ZF Getr. / GBox: Fuller Beinhaltet Ausrücker und Montagesatz / Contains releaser and fitting kit In 3483/3488 enthalten / Contained in 3483, 3488	(9) (32)
190-36 190-36 190-36 P 190-36 P 190-36 T 190-36 T	07.87 - 06.90	8210	 3400 700 456 ■	430 10	Getr. / GBox: Fuller Nabenprofil / Hub Profile: 41,1x50,8-10N Ausrückgabel stehend [mm] / Release Fork, upright [mm]: 86	(48) (5)
	07.90 - 12.93		 3400 700 457 ■	430 10	Getr. / GBox: ZF Nabenprofil / Hub Profile: 41,1x50,8-10N	(48)
	07.87 - 06.90		 3482 083 040	430 MFZ430	Getr. / GBox: ZF Getr. / GBox: Fuller In 3483/3488 enthalten / Contained in 3483, 3488	(32)
	07.90 - 12.93		 3100 002 040 ◆ 3151 000 148 ◎ 3180 001 008	KZIZ5	Getr. / GBox: ZF Getr. / GBox: Fuller Beinhaltet Ausrücker und Montagesatz / Contains releaser and fitting kit In 3483/3488 enthalten / Contained in 3483, 3488	(9) (32)
	07.87 - 06.90					
07.90 - 12.93						









IVECO

TurboStar		07.84 - 12.93				
190-42 190-42 T	07.84 - 09.86 07.84 - 09.86	8280	 3400 700 454 ■	430 10	->Chass. 140027 Getr. / GBox: Fuller Nabenprofil / Hub Profile: 41,1x50,8-10N Ausrückgabel hängend [mm] / Release Fork, suspended [mm]: 125	(48) (4)
			 3482 083 040	430 MFZ430	Getr. / GBox: Fuller In 3483/3488 enthalten / Contained in 3483, 3488	(32)
			 3100 002 038 ◊ 3151 123 031 ◎ 3180 001 008	KZIZ5 KZI/Z-5	->Chass. 140027 Getr. / GBox: Fuller Beinhaltet Ausrücker und Montagesatz / Contains releaser and fitting kit In 3483/3488 enthalten / Contained in 3483, 3488	(9) (32)
			 3400 700 456 ■	430 10	Chass. 140028-> Getr. / GBox: Fuller Nabenprofil / Hub Profile: 41,1x50,8-10N Ausrückgabel stehend [mm] / Release Fork, upright [mm]: 86	(48) (5)
			 3100 002 040 ◊ 3151 000 148 ◎ 3180 001 008	KZIZ5	Chass. 140028-> Getr. / GBox: Fuller Beinhaltet Ausrücker und Montagesatz / Contains releaser and fitting kit In 3483/3488 enthalten / Contained in 3483, 3488	(9) (32)
			 3400 700 457 ■	430 10	09.1984-> Getr. / GBox: ZF Nabenprofil / Hub Profile: 41,1x50,8-10N	(48)
			 3482 083 040	430 MFZ430	09.1984-> Getr. / GBox: ZF In 3483/3488 enthalten / Contained in 3483, 3488	(32)
			 3100 002 040 ◊ 3151 000 148 ◎ 3180 001 008	KZIZ5	09.1984-> Getr. / GBox: ZF Beinhaltet Ausrücker und Montagesatz / Contains releaser and fitting kit In 3483/3488 enthalten / Contained in 3483, 3488	(9) (32)
190-42 190-42 T	10.86 - 12.90 10.86 - 12.90	8280	 3400 700 454 ■	430 10	->Chass. 140027 Getr. / GBox: Fuller Nabenprofil / Hub Profile: 41,1x50,8-10N Ausrückgabel hängend [mm] / Release Fork, suspended [mm]: 125	(48) (4)
			 3100 002 038 ◊ 3151 123 031 ◎ 3180 001 008	KZIZ5 KZI/Z-5	->Chass. 140027 Getr. / GBox: Fuller Beinhaltet Ausrücker und Montagesatz / Contains releaser and fitting kit In 3483/3488 enthalten / Contained in 3483, 3488	(9) (32)
			 3400 700 456 ■	430 10	Chass. 140028-> Getr. / GBox: Fuller Nabenprofil / Hub Profile: 41,1x50,8-10N	(48)
			 3100 002 040 ◊ 3151 000 148 ◎ 3180 001 008	KZIZ5	Chass. 140028-> Getr. / GBox: Fuller Beinhaltet Ausrücker und Montagesatz / Contains releaser and fitting kit	(9)
			 3400 700 457 ■	430 10	Getr. / GBox: ZF Nabenprofil / Hub Profile: 41,1x50,8-10N	(48)
			 3482 083 040	430 MFZ430	Getr. / GBox: Fuller Getr. / GBox: ZF In 3483/3488 enthalten / Contained in 3483, 3488	(32)
			 3100 002 040 ◊ 3151 000 148 ◎ 3180 001 008	KZIZ5	Getr. / GBox: ZF Beinhaltet Ausrücker und Montagesatz / Contains releaser and fitting kit	(9)
190-48 190-48 190-48 T 190-48 T	03.89 - 03.91 04.91 - 12.93 03.89 - 03.91 04.91 - 12.93	8280.42.001, 8280.42.050	 3400 700 455 ■	430 10	Getr. / GBox: Fuller Nabenprofil / Hub Profile: 41,1x50,8-10N	(48)
			 3400 117 801 ◎ 3482 083 032 ◎ 1878 085 741 ◊ 3151 000 144	430 10 MFZ430 430WGTZ KZISZ-5	Getr. / GBox: ZF für Ausrückgabel mit Nocken / for release fork with cams	(70)
			 3400 700 435 ◎ 3482 083 032 ◎ 1878 085 741 ◊ 3151 000 493	430 10 MFZ430 430WGTZ KZISZ-5	Getr. / GBox: ZF für Ausrückgabel mit Rollen / for release fork with rollers	(71)
			 3189 600 004		Getr. / GBox: ZF AS Tronic Rollenausführung / roller version	(58)



		CODE				
--	--	------	--	---	---	---







IVECO







TurboTech		01.90 - 01.93							
190-26	01.90 - 12.92	8460		3482 085 033	420	-> Chass. 93115 Getr. / GBox: Fuller, ZF enthält Druckplattenbefestigungsschrauben / includes bolt for pressure plate mounting	(65)		
190-26 T	01.90 - 12.92				MF420				
190-32	01.90 - 12.92				1878 002 955	420 10	-> Chass. 93115 Getr. / GBox: Fuller, ZF		
190-32 T	01.90 - 12.92					420GTZ			
						3151 114 031	420	-> Chass. 93115 Getr. / GBox: Fuller, ZF	
							MF420		
				3482 125 131	420	Chass. 93116-> Getr. / GBox: Fuller, ZF enthält Druckplattenbefestigungsschrauben / includes bolt for pressure plate mounting	(65)		
					MF420				
				1878 003 661	420 10	Chass. 93116-> Getr. / GBox: Fuller, ZF			
					420WGTZ				
				3151 207 031	420	Chass. 93116-> Getr. / GBox: Fuller, ZF			
					KZIS-4				
190-36	01.90 - 12.92	8210		3400 700 456 ■	430 10	Getr. / GBox: Fuller Nabenprofil / Hub Profile: 41,1x50,8-10N Ausrückgabel stehend [mm] / Release Fork, upright [mm]: 86	(48) (5)		
190-36 T	01.90 - 12.92								
						3400 700 457 ■	430 10	Getr. / GBox: ZF Nabenprofil / Hub Profile: 41,1x50,8-10N	(48)
						3482 083 040	430	Getr. / GBox: Fuller Getr. / GBox: ZF In 3483/3488 enthalten / Contained in 3483, 3488	(32)
							MFZ430		
				3100 002 040 ◊ 3151 000 148 ◎ 3180 001 008	430	Getr. / GBox: Fuller Getr. / GBox: ZF Beinhaltet Ausrücker und Montagesatz / Contains releaser and fitting kit In 3483/3488 enthalten / Contained in 3483, 3488	(9) (32)		
					KZIZ5				
220-36 PT	01.90 - 12.92	8210		3400 700 456 ■	430 10	Getr. / GBox: Fuller Nabenprofil / Hub Profile: 41,1x50,8-10N	(48)		
240-36 P	01.90 - 12.92								
								3482 083 040	430
					MFZ430				
				3100 002 040 ◊ 3151 000 148 ◎ 3180 001 008	430	Getr. / GBox: Fuller Beinhaltet Ausrücker und Montagesatz / Contains releaser and fitting kit In 3483/3488 enthalten / Contained in 3483, 3488	(9) (32)		
					KZIZ5				







Zeta		01.79 - 12.92							
50-10	01.79 - 12.86	8040.25.230R, 8060.04.660, 8340.04.200, 8340.04.250, 8040.05.230, 8340.04.300, 8040.04.200, 8340.04.362, 8060.04.060		3482 911 001	270				
50-10 H	01.79 - 12.86				MF270				
50-10 V	01.79 - 12.86				1862 811 001			270 10	270CTB
50-8	01.83 - 12.86								
50-8 H	01.83 - 12.86								
50-8 V	01.83 - 12.86								
50-9	01.87 - 03.91								
50-9 H	01.87 - 03.91								
50-9 V	01.87 - 03.91								
60-11	01.87 - 03.91								
60-11 V	01.87 - 03.91								
79-13	11.79 - 12.83								
60-10	11.79 - 12.86			8340				1878 600 841	
60-10 V	11.79 - 12.86								
				1850 282 652 ▲	280 10	KZA-2	-> 02.1982		
60-10 H	11.79 - 12.86	8340.04.200, 8340.04.250		1878 600 841	280 10	280CTB			
				8340					
				1850 282 652 ▲	280 10	KZA-2	-> 02.1982		
60-8	11.79 - 12.82	8040.04.200		1878 600 834	250 10	250CB			
60-8	11.79 - 12.81								
60-8	11.79 - 12.83								
		8040.04.200		1878 600 834	250 10	250CB	-> 08.1983		
		Deutz		1878 600 834	250 10			250CB	09.1983->



IVECO

Zeta 01.79 - 12.92						
65-10	11.79-01.87	8340.04.350,		1878 600 841	280 10	
65-10 H	11.79-01.87	8340.04.200,			280CTB	
65-10 V	11.79-01.87	8340.04.250,				
		8340.04.300				
65-9	01.87-03.91	8040		3482 911 001	270	
					MF270	
				1862 811 001	270 10	
					270CTB	

60...						
60 U-10	-02.82	8340		1878 600 841	280 10	
65 F	-12.78				280CTB	
				1850 282 652 ▲	KZA-2	
65 NC		8340		1878 600 841	280 10	
65 NC /70 NC	01.73-12.78				280CTB	
65 U-10	-10.78					
65/60 U-10	-10.78					
65-12 A Fire Fighting	01.89-	F6L913		3482 008 033	310	
					MF310	
				1861 577 037 #	310 10	
					310GTD	
				3151 199 001	KZIS-3	



70...						
70 NC		8340		1878 600 841	280 10	
70 NC /75 NC	01.75-12.78				280CTB	
70 U-10						
75 NC						
79 U-10	-10.78					
70 NC /70 NC (Mot. Deutz)	01.73-12.78			1878 600 841	280 10	
70-10	01.73-12.75				280CTB	
70-10 (Mot. Deutz)	-12.75					
70-10		8340		1878 600 841	280 10	
75 F 10/79 F 10	01.78-				280CTB	
75 U-10	-02.82			1850 282 652 ▲	KZA-2	
75-10	-02.82					
75-13 AW		BF6L913T		3482 008 033	310	
75-13 AWM	01.87-				MF310	
				1861 577 037 #	310 10	
					310GTD	
				3151 199 001	KZIS-3	









90...						
90 NC	01.75-	Deutz		1878 600 841	280 10	
					280CTB	
90-13 AT		BF6L913T		3482 008 036 #	310	
					MF310	
				1861 577 136 #	310 10	
					310GTD	
				3151 199 001	KZIS-3	
90-16 AW		BF6L913		3482 038 031	350	
					GMF350	
				1861 742 032	350 10	
					350GTB	
				3151 199 001	KZIS-3	





110...						
110-14 P 4x4		8060		1878 000 611	310 10	Getr. / GBox: ZF
115-14					310TB	
				3151 824 001 ▲	KZA-4	Getr. / GBox: ZF

		CODE				
--	--	------	--	---	---	---

IVECO







110...						
110-16 AW		BF6L913		3482 038 031	350	
110-16 AWM	01.84-				GMF350	
110-17 AWM	01.84-			1861 742 032	350 10	
					350GTB	
				3151 199 001	KZIS-3	

120...						
120 PC 17				3482 038 031	350	für / for: Version 42231628
120-17 H					GMF350	für / for: Version 42231929
120-17 HW				1861 742 032	350 10	für / for: Version 42231628
					350GTB	für / for: Version 42231929
				3151 196 031	KZIS-4	für / for: Version 42231628
						für / for: Version 42231929
120-13 AN				3151 199 001	KZIS-3	
120-14	02.78-	8360		3482 905 001	330	
					MF330	
120-25 AW	01.88-	F8L413F		1882 325 139	380	
					G380	
				1878 000 957	380 10	
					380GTZ	
				3151 000 515	KZIS-4	

130...						
130-16 AT		BF6L913		3482 038 031	350	
					GMF350	
				1861 742 032	350 10	
					350GTB	
				3151 199 001	KZIS-3	
135-14 ,H		8060		1878 000 611	310 10	Getr. / GBox: ZF
					310TB	
				3151 824 001 ▲	KZA-4	Getr. / GBox: ZF







140...						
140-14		8360		3482 905 001	330	
					MF330	
140-19				3482 002 234	350	
					GMF350X	
				1878 001 070	350 10	
					350GTZ	
				3151 000 515	KZIS-4	



















150...						
150-14	02.78-	8360		3482 905 001	330	
					MF330	
150-17 2. Serie	02.78-	8360		3482 038 031	350	Getr. / GBox: ZF
					GMF350	
				1861 742 032	350 10	Getr. / GBox: ZF
					350GTB	
				3151 196 031	KZIS-4	Getr. / GBox: ZF













160...						
160-16 A	02.78-	BF6L913		3482 038 031	350	Getr. / GBox: ZF
					GMF350	
				1861 742 032	350 10	Getr. / GBox: ZF
					350GTB	
				3151 000 395	KZIS-4	Getr. / GBox: ZF
160-19 ANW				3482 002 234	350	
					GMF350X	
				1878 001 070	350 10	
					350GTZ	
				3151 000 515	KZIS-4	

		CODE				
--	--	------	--	---	---	---

IVECO



















































160...						
160-26 , T		8210	 3482 125 131	420 MF420	Getr. / GBox: Fiat enthält Druckplattenbefestigungsschrauben / includes bolt for pressure plate mounting	(65)
			 1878 001 138	420 10 420GTZ	Getr. / GBox: Fiat	
			 3151 071 032	KZI-4,5	Getr. / GBox: Fiat	
165-24 , T		8460	 1882 325 139	380 G380		
			 1878 000 957	380 10 380GTZ		
			 3151 114 031	KZI-4,5	Getr. / GBox: ZF	
			 3151 127 031	KZI-4,5	Getr. / GBox: Fuller	













































170...						
170 NC 26			 3400 119 001	420 10 MF420	enthält Druckplattenbefestigungsschrauben / includes bolt for pressure plate mounting	(65)
			 3482 085 033	420GTZ		
170 NC 33, 35 170 NT 33 170-32 170-33 170-35			 1878 001 138			
			 1874 015 200			
170-26	01.79 -		 3151 054 031	KZI-4,5		
			 3482 125 131	420 MF420	enthält Druckplattenbefestigungsschrauben / includes bolt for pressure plate mounting	(65)
170-26	- 12.78		 1878 002 955	420 10 420GTZ		
			 3151 071 032	KZI-4,5	Getr. / GBox: Fiat	
170-26	01.79 -		 3151 127 031	KZI-4,5	Getr. / GBox: ZF	
			 3400 119 001	420 10 MF420	enthält Druckplattenbefestigungsschrauben / includes bolt for pressure plate mounting	(65)
170-30	01.79 -		 3482 085 033	420 10 MF420	enthält Druckplattenbefestigungsschrauben / includes bolt for pressure plate mounting	(65)
			 1878 002 955	420GTZ		
170-30			 1874 015 200			
			 3151 127 031	KZI-4,5	Getr. / GBox: Fuller	
170-35 , T			 3400 042 031	420 10 MF420	enthält Druckplattenbefestigungsschrauben / includes bolt for pressure plate mounting	(65)
			 3482 125 131	420GTZ		
170-35 , T			 1878 002 955			
			 1874 015 200			
170-35 , T			 3151 127 031	KZI-4,5		

180...								
180-24 , T		8220	 1882 325 139	380 G380				
			 1878 000 957	380 10 380GTZ				
			 3151 114 031	KZI-4,5	Getr. / GBox: ZF			
			 3151 127 031	KZI-4,5	Getr. / GBox: Fuller			
180-26		8210	 3400 119 001	420 10 MF420	enthält Druckplattenbefestigungsschrauben / includes bolt for pressure plate mounting	(65)		
			 3482 085 033	420GTZ				
				 1878 001 138				
				 1874 015 200				
180-26			 3151 054 031	KZI-4,5	Getr. / GBox: Fiat			
			 3482 125 131	420 MF420	Getr. / GBox: Fuller enthält Druckplattenbefestigungsschrauben / includes bolt for pressure plate mounting	(65)		
			 1878 001 138	420 10 420GTZ	Getr. / GBox: Fuller			
180-26			 3151 127 031	KZI-4,5	Getr. / GBox: Fuller			

		CODE				
--	--	------	--	---	---	---

























IVECO

180...						
190 NC /H 26		8210	 3400 119 001   3482 085 033  1878 001 138  1874 015 200	420 10 MF420 420GTZ	enthält Druckplattenbefestigungsschrauben / includes bolt for pressure plate mounting	(65)
			 3151 054 031	KZI-4,5	Getr. / GBox: Fiat	
			 3151 127 031	KZI-4,5	Getr. / GBox: Fuller	
190...						
190 NC 26			 3482 125 131	420 MF420	enthält Druckplattenbefestigungsschrauben / includes bolt for pressure plate mounting	(65)
190 NC 30			 1878 002 955	420 10 420GTZ		
190 U 26						
190-33						
190-35						
190 NT /H 26		8210	 3400 119 001   3482 085 033  1878 001 138  1874 015 200	420 10 MF420 420GTZ	enthält Druckplattenbefestigungsschrauben / includes bolt for pressure plate mounting	(65)
			 3151 054 031	KZI-4,5	Getr. / GBox: Fiat	
			 3151 127 031	KZI-4,5	Getr. / GBox: Fuller	
190 PAC						
190 PAC 26						
190 PAT						
190 U 26/T/TH	10.78-					
190-26						
190 PAC /F 20	01.76-		 1882 325 134	380 G380		
190 PAC /H 20	01.76-		 1878 000 957	380 10 380GTZ		
190 PAC /20	01.76-					
190 PAC 20		8220	 1882 325 134	380 G380	Getr. / GBox: ZF	
			 1878 000 957	380 10 380GTZ	Getr. / GBox: ZF	
			 3151 000 515	KZIS-4	Getr. / GBox: ZF	
190-20 N						
190 PAT 26		8210	 3400 119 001   3482 085 033  1878 001 138  1874 015 200	420 10 MF420 420GTZ	Getr. / GBox: Fiat, ZF enthält Druckplattenbefestigungsschrauben / includes bolt for pressure plate mounting	(65)
			 3151 000 515	KZIS-4	Getr. / GBox: Fiat, ZF	
190 PC			 3400 042 031   3482 125 131  1878 002 955  1874 015 200	420 10 MF420 420GTZ	Getr. / GBox: Fiat enthält Druckplattenbefestigungsschrauben / includes bolt for pressure plate mounting	(65)
190-35 H/HT		8280	 3151 000 515	KZIS-4	Getr. / GBox: Fiat	
190 PC 30		8210	 3482 125 131	420 MF420	Getr. / GBox: Fuller enthält Druckplattenbefestigungsschrauben / includes bolt for pressure plate mounting	(65)
			 3151 000 515	KZIS-4	Getr. / GBox: Fuller	
190 U T	-09.80	8210	 3400 042 031   3482 125 131  1878 002 955  1874 015 200	420 10 MF420 420GTZ	enthält Druckplattenbefestigungsschrauben / includes bolt for pressure plate mounting	(65)
			 3151 114 031	KZI-4,5	Getr. / GBox: ZF	
			 3151 127 031	KZI-4,5	Getr. / GBox: Fuller	
190-30 P, T, PT	-12.84					
190-24		8220	 1882 325 139	380 G380	Getr. / GBox: Fuller	
			 1878 000 957	380 10 380GTZ	Getr. / GBox: Fuller	
			 3151 127 031	KZI-4,5	Getr. / GBox: Fuller	
190-25 A, AT	-12.84	F8L413F	 1882 325 139	380 G380	Getr. / GBox: Fuller	
			 1878 000 957	380 10 380GTZ	Getr. / GBox: Fuller	
			 3151 127 031	KZI-4,5	Getr. / GBox: Fuller	
190-26 , T	-12.84	8210	 3482 125 131	420 MF420	Getr. / GBox: Fuller enthält Druckplattenbefestigungsschrauben / includes bolt for pressure plate mounting	(65)
			 1878 001 138	420 10 420GTZ	Getr. / GBox: Fuller	
			 3151 127 031	KZI-4,5	Getr. / GBox: Fuller	

190...						
190-29 A, AP 190-29 AT, APT		BF8L413F	 3482 124 533 #	420 GMF430		
			 1878 002 955	420 10 420GTZ		
			 3151 127 031	KZI-4,5		
190-30 AHT		BF8L513	 3482 124 533 #	420 GMF430		
			 1878 002 955	420 10 420GTZ		
			 3151 000 515	KZIS-4		
190-30 P, T, PT	01.85-		 3482 125 131	420 MF420	Getr. / GBox: Ecosplit 16 S 130 enthält Druckplattenbefestigungsschrauben / includes bolt for pressure plate mounting	(65)
			 1878 003 661	420 10 420WGTZ	Getr. / GBox: Ecosplit 16 S 130	
			 3151 114 031	KZI-4,5	Getr. / GBox: Ecosplit 16 S 130	
	8210	 3400 042 031 	420 10 MF420 420GTZ	Getr. / GBox: Fuller enthält Druckplattenbefestigungsschrauben / includes bolt for pressure plate mounting	(65)	
		 3482 125 131  1878 002 955  1874 015 200	420 10 420GTZ	Getr. / GBox: Fuller		
		 1878 001 138 	420 10 420GTZ	Getr. / GBox: Fuller		
190-32	01.87-	8210	 3483 020 034 	430 MFZ430		
			 1878 085 742	430 10 430WGTZ	Lose Kupplungsscheibe / Loose clutch disc	(41)
			 3482 083 040	430 MFZ430	In 3483/3488 enthalten / Contained in 3483, 3488	(32)
			 3100 002 040  3151 000 148  3180 001 008	KZIZ5	Beinhaltet Ausrücker und Montagesatz / Contains releaser and fitting kit In 3483/3488 enthalten / Contained in 3483, 3488	(9) (32)
190-32 A, AT		BF8L413F	 3482 124 532	430 GMF430		
			 1878 002 955	420 10 420GTZ		
			 3151 000 515	KZIS-4		
190-32 AH, AHT, AHW		BF8L413F	 3482 124 533 #	420 GMF430		
			 1878 002 955	420 10 420GTZ		
			 3151 000 515	KZIS-4		
190-33	09.84-		 3483 010 137 	430 GMFZ430	-> Chass. 140027 Getr. / GBox: ZF Beinhaltet Ausrücker und Montagesatz / Contains releaser and fitting kit	(9)
			 1878 022 841	430 10 430GTZ	-> Chass. 140027 Getr. / GBox: ZF	
			 3482 043 134	430 GMFZ430	-> Chass. 140027 Getr. / GBox: ZF In 3483/3488 enthalten / Contained in 3483, 3488	(32)
			 3100 002 040  3151 000 148  3180 001 008	KZIZ5	-> Chass. 140027 Getr. / GBox: ZF Beinhaltet Ausrücker und Montagesatz / Contains releaser and fitting kit In 3483/3488 enthalten / Contained in 3483, 3488	(9) (32)
190-35 , T	- 12.84	8280	 3400 042 031 	420 10 MF420 420GTZ	Getr. / GBox: Fuller enthält Druckplattenbefestigungsschrauben / includes bolt for pressure plate mounting	(65)
			 3482 125 131  1878 002 955  1874 015 200	420 10 420GTZ	Getr. / GBox: Fuller	
			 1878 001 138 	420 10 420GTZ	Getr. / GBox: Fuller	
			 3151 127 031	KZI-4,5	Getr. / GBox: Fuller	



































		CODE		 Parameter		
--	--	------	--	---	---	---

IVECO

190...						
190-35, T			 3400 042 031 ◐ ⊗ 3482 125 131 ⊗ 1878 002 955 ⚡ 1874 015 200	420 10 MF420 420GTZ	Getr. / GBox: Fuller enthält Druckplattenbefestigungsschrauben / includes bolt for pressure plate mounting	(65)
			 3151 127 031	KZI-4,5	Getr. / GBox: Fuller	
190-36 APT	- 12.84	BF10L413F	 3482 124 533 #	420 GMF430	Getr. / GBox: Fuller	
			 1878 002 955	420 10 420GTZ	Getr. / GBox: Fuller	
			 3151 127 031	KZI-4,5	Getr. / GBox: Fuller	
190-38, T, P, PT	01.87-	8280	 3400 700 456 ■	430 10	Getr. / GBox: Fuller Nabenprofil / Hub Profile: 41,1x50,8-10N Ausrückgabel stehend [mm] / Release Fork, upright [mm]: 86	(48) (5)
			 3482 083 040	430 MFZ430	Getr. / GBox: Fuller In 3483/3488 enthalten / Contained in 3483, 3488	(32)
			 3100 002 040 ⊗ 3151 000 148 ⊗ 3180 001 008	KZIZ5	Getr. / GBox: Fuller Beinhaltet Ausrücker und Montagesatz / Contains releaser and fitting kit In 3483/3488 enthalten / Contained in 3483, 3488	(9) (32)
190-38 Turbo Star	01.87-	8280	 3400 700 457 ■	430 10	Getr. / GBox: ZF Nabenprofil / Hub Profile: 41,1x50,8-10N	(48)
			 3482 083 040	430 MFZ430	Getr. / GBox: ZF In 3483/3488 enthalten / Contained in 3483, 3488	(32)
			 3100 002 040 ⊗ 3151 000 148 ⊗ 3180 001 008	KZIZ5	Getr. / GBox: ZF Beinhaltet Ausrücker und Montagesatz / Contains releaser and fitting kit In 3483/3488 enthalten / Contained in 3483, 3488	(9) (32)
190-48, P, T, PT			 3400 700 435 ⊗ 3482 083 032 ⊗ 1878 085 741 ⊗ 3151 000 493	430 10 MFZ430 430WGTZ KZISZ-5	für Ausrückgabel mit Rollen / for release fork with rollers	(71)
			 3400 117 801 ⊗ 3482 083 032 ⊗ 1878 085 741 ⊗ 3151 000 144	430 10 MFZ430 430WGTZ KZISZ-5	für Ausrückgabel mit Nocken / for release fork with cams	(70)
200...						
200-32			 3482 125 131	420 MF420	enthält Druckplattenbefestigungsschrauben / includes bolt for pressure plate mounting	(65)
			 1878 002 955	420 10 420GTZ		
200-32 AHW, AHWM		F10L413F	 3482 124 534	430 GMF430	Getr. / GBox: ZF	
			 1882 301 239 ●	420 GF420	Getr. / GBox: ZF	
			 1878 634 017 ▲	420 10 420GSZ	Getr. / GBox: ZF	
			 3151 000 515	KZIS-4	Getr. / GBox: ZF	
220...						
220-29 AP		BF8L413F	 3482 124 533 #	420 GMF430	Getr. / GBox: Fuller	
			 1878 002 955	420 10 420GTZ	Getr. / GBox: Fuller	
			 3151 127 031	KZI-4,5	Getr. / GBox: Fuller	
220-30 PT	01.85-	8210	 3400 042 031 ◐ ⊗ 3482 125 131 ⊗ 1878 002 955 ⚡ 1874 015 200	420 10 MF420 420GTZ	Getr. / GBox: Fuller enthält Druckplattenbefestigungsschrauben / includes bolt for pressure plate mounting	(65)
			 1878 001 138 ●	420 10 420GTZ	Getr. / GBox: Fuller	
			 3151 114 031	KZI-4,5	Getr. / GBox: Fuller	





































		CODE				
--	--	------	--	---	---	---

IVECO































220...						
220-32 AHW, AHTM		F10L413F	 3482 124 534	430 GMF430	Getr. / GBox: ZF	
			 1882 301 239 ●	420 GF420	Getr. / GBox: ZF	
			 1878 634 017 ▲	420 10 420GSZ	Getr. / GBox: ZF	
			 3151 000 515	KZIS-4	Getr. / GBox: ZF	
220-35 T			 3400 042 031 ☾  3482 125 131  1878 002 955  1874 015 200	420 10 MF420 420GTZ	Getr. / GBox: Fuller enthält Druckplattenbefestigungsschrauben / includes bolt for pressure plate mounting	(65)
			 1878 001 138 ●	420 10 420GTZ	Getr. / GBox: Fuller	
			 3151 114 031	KZI-4,5	Getr. / GBox: Fuller	
220-36 AP, APT 220-38 PT	- 12.84 - 12.84		 3483 020 034 ⊕	430 MFZ430	Getr. / GBox: Fuller	
			 1861 992 432	430 10 430GVZ	Getr. / GBox: Fuller	
			 3482 083 040	430 MFZ430	Getr. / GBox: Fuller In 3483/3488 enthalten / Contained in 3483, 3488	(32)
			 3100 002 040  3151 000 148  3180 001 008	KZIZ5	Getr. / GBox: Fuller Beinhaltet Ausrücker und Montagesatz / Contains releaser and fitting kit In 3483/3488 enthalten / Contained in 3483, 3488	(9) (32)
220-38 PT		8280	 3400 700 456 ■	430 10	Getr. / GBox: Fuller Nabenprofil / Hub Profile: 41,1x50,8-10N Ausrückgabel stehend [mm] / Release Fork, upright [mm]: 86	(48) (5)
			 3482 083 040	430 MFZ430	Getr. / GBox: Fuller In 3483/3488 enthalten / Contained in 3483, 3488	(32)
			 3400 700 454 ■	430 10	Getr. / GBox: Fuller Nabenprofil / Hub Profile: 41,1x50,8-10N Ausrückgabel stehend [mm] / Release Fork, upright [mm]: 86 Ausrückgabel hängend [mm] / Release Fork, suspended [mm]: 125	(48) (5) (4)
			 3100 002 038  3151 123 031  3180 001 008	KZIZ5 KZI/Z-5	Getr. / GBox: Fuller Beinhaltet Ausrücker und Montagesatz / Contains releaser and fitting kit In 3483/3488 enthalten / Contained in 3483, 3488	(9) (32)
			 3400 700 457 ■	430 10	Getr. / GBox: ZF Nabenprofil / Hub Profile: 41,1x50,8-10N	(48)
			 3482 083 040	430 MFZ430	Getr. / GBox: ZF Getr. / GBox: Fuller In 3483/3488 enthalten / Contained in 3483, 3488	(32)
			 3100 002 040  3151 000 148  3180 001 008	KZIZ5	Getr. / GBox: ZF Getr. / GBox: Fuller Beinhaltet Ausrücker und Montagesatz / Contains releaser and fitting kit In 3483/3488 enthalten / Contained in 3483, 3488	(9) (32)
230...						
230-26		8210	 3400 119 001 ☾  3482 085 033  1878 001 138  1874 015 200	420 10 MF420 420GTZ	enthält Druckplattenbefestigungsschrauben / includes bolt for pressure plate mounting	(65)
			 3151 054 031	KZI-4,5	Getr. / GBox: Fiat	
230-32			 3151 127 031	KZI-4,5	Getr. / GBox: Fuller	
			 3482 125 131	420 MF420	enthält Druckplattenbefestigungsschrauben / includes bolt for pressure plate mounting	(65)
			 1878 002 955	420 10 420GTZ		

		CODE				
--	--	------	--	---	---	---

IVECO





240...						
240-26		8210	 3482 125 131	420 MF420	enthält Druckplattenbefestigungsschrauben / includes bolt for pressure plate mounting	(65)
			 1878 001 138	420 10 420GTZ		
			 3151 127 031	KZI-4,5	Getr. / GBox: Fiat	
240-30	01.85-	8210	 3400 042 031 ☹	420 10 MF420 420GTZ	Getr. / GBox: Fuller enthält Druckplattenbefestigungsschrauben / includes bolt for pressure plate mounting	(65)
			 3482 125 131			
			 1878 002 955			
			 1874 015 200			
240-30		8210	 1878 001 138 ●	420 10 420GTZ	Getr. / GBox: Fuller	
			 1878 003 661	420 10 420WGTZ	Getr. / GBox: ZF16 S130	
			 3151 114 031	KZI-4,5	Getr. / GBox: Fuller Getr. / GBox: ZF16 S130	
			 3400 042 031 ☹	420 10 MF420 420GTZ	Getr. / GBox: Fuller enthält Druckplattenbefestigungsschrauben / includes bolt for pressure plate mounting	(65)
240-30 P	- 12.84	8210	 3482 125 131			
			 1878 002 955			
240-36 Turbo Star 240-48 Turbo Star	01.89- 01.89-	8280	 3400 117 801	430 10 MFZ430 430WGTZ KZISZ-5	Getr. / GBox: ZF für Ausrückgabel mit Nocken / for release fork with cams	(70)
			 3482 083 032			
			 1878 085 741			
			 3151 000 144			
240-38	01.85-	8280	 3400 700 435	430 10 MFZ430 430WGTZ KZISZ-5	Getr. / GBox: ZF für Ausrückgabel mit Rollen / for release fork with rollers	(71)
			 3482 083 032			
			 1878 085 741			
			 3151 000 493			
240-38 P	- 12.84	8210	 3400 700 455 ■	430 10	Getr. / GBox: Fuller Nabenprofil / Hub Profile: 41,1x50,8-10N	(48)
			 1878 085 741 ●	430 10 430WGTZ	Getr. / GBox: ZF	
			 3400 700 456 ■	430 10	Getr. / GBox: Fuller Nabenprofil / Hub Profile: 41,1x50,8-10N Ausrückgabel stehend [mm] / Release Fork, upright [mm]: 86	(48) (5)
			 3100 002 040	KZIZ5	Getr. / GBox: Fuller Beinhaltet Ausrücker und Montagesatz / Contains releaser and fitting kit In 3483/3488 enthalten / Contained in 3483, 3488	(9) (32)
			 3151 000 148			
			 3180 001 008			
			 3400 700 454 ■	430 10	Getr. / GBox: Fuller Nabenprofil / Hub Profile: 41,1x50,8-10N Ausrückgabel hängend [mm] / Release Fork, suspended [mm]: 125	(48) (4)
			 3100 002 038	KZIZ5 KZI/Z-5	Getr. / GBox: Fuller Beinhaltet Ausrücker und Montagesatz / Contains releaser and fitting kit In 3483/3488 enthalten / Contained in 3483, 3488	(9) (32)
			 3151 123 031			
			 3180 001 008			
240-38 P		8280	 3400 700 457 ■	430 10	Getr. / GBox: ZF Nabenprofil / Hub Profile: 41,1x50,8-10N	(48)
			 3482 083 040	430 MFZ430	Getr. / GBox: ZF Getr. / GBox: Fuller In 3483/3488 enthalten / Contained in 3483, 3488	(32)
			 3100 002 040	KZIZ5	Getr. / GBox: ZF Beinhaltet Ausrücker und Montagesatz / Contains releaser and fitting kit In 3483/3488 enthalten / Contained in 3483, 3488	(9) (32)
			 3151 000 148			
240-38 P		8210	 3180 001 008			
			 3483 020 034 ⊕	430 MFZ430	Getr. / GBox: Fuller	
			1861 992 432	430 10 430GVZ	Getr. / GBox: Fuller Lose Kupplungsscheibe / Loose clutch disc	(41)
			3482 083 040	430 MFZ430	Getr. / GBox: Fuller In 3483/3488 enthalten / Contained in 3483, 3488	(32)
240-38 P		8210	3100 002 040	KZIZ5	Getr. / GBox: Fuller Beinhaltet Ausrücker und Montagesatz / Contains releaser and fitting kit In 3483/3488 enthalten / Contained in 3483, 3488	(9) (32)
			3151 000 148			
3180 001 008						















IVECO







260...						
260-23				1882 325 134	380 G380	
				1878 000 104	380 10 380GTZ	
				3151 000 395	KZIS-4	
260-23 AH 260-23 AHB 260-25 AHB	01.86 - 01.89 -	F8L413F		3482 124 531	430 GMF430	Getr. / GBox: ZF
				1882 316 035 ●#	420 GF420	Getr. / GBox: ZF
				1878 001 138	420 10 420GTZ	Getr. / GBox: ZF
				3151 000 515	KZIS-4	Getr. / GBox: ZF
260-23 AH	- 12.85	F8L413F		1882 325 139	380 G380	Getr. / GBox: ZF
				1878 000 957	380 10 380GTZ	Getr. / GBox: ZF
				3151 000 515	KZIS-4	Getr. / GBox: ZF
260-26 H, HT, HW 260-26 N, NW 260 PAC 26 6x4, 6x6 260 PC 6x4, 6x6 260 PT 26 6x4		8210		3400 119 001 ☾ ⊗ 3482 085 033 ⊗ 1878 001 138 ⊗ 1874 015 200	420 10 MF420 420GTZ	enthält Druckplattenbefestigungsschrauben / includes bolt for pressure plate mounting (65)
				3151 000 515	KZIS-4	
260-30				1882 306 210	420 G420N	für Nebenantrieb / for PTO (82)
				1878 003 274	420 10 420GTZ	für Nebenantrieb / for PTO (82)
260-30 H		8210		3400 118 901 ☾ ⊗ 3482 125 131 ⊗ 1878 003 661 ⊗ 1874 015 200	420 10 MF420 420WGTZ	enthält Druckplattenbefestigungsschrauben / includes bolt for pressure plate mounting (65)
				3151 000 515	KZIS-4	
260-32		F10L413F		1878 003 274	420 10 420GTZ	Nebenantriebs-ID / PTO ID: 110E (50)
260-32 AH		F8L413F		3482 124 533 #	420 GMF430	Getr. / GBox: Fuller
				1878 002 955	420 10 420GTZ	Getr. / GBox: Fuller
				3151 000 515	KZIS-4	Getr. / GBox: Fuller
260-32 AHM 260-32 AHWM		F10L413F		3482 124 534	430 GMF430	Getr. / GBox: ZF
				1882 301 239 ●	420 GF420	Getr. / GBox: ZF
				1878 634 017 ▲	420 10 420GSZ	Getr. / GBox: ZF
				3151 000 515	KZIS-4	Getr. / GBox: ZF
260-35 H, HT 6x4 260-35 HW 6x6 260 PC HW 6x6 260 PT 35 6x4, 6x6		8280		3400 042 031 ☾ ⊗ 3482 125 131 ⊗ 1878 002 955 ⊗ 1874 015 200	420 10 MF420 420GTZ	enthält Druckplattenbefestigungsschrauben / includes bolt for pressure plate mounting (65)
				3151 000 515	KZIS-4	
260-36				3400 700 457 ■	430 10	Getr. / GBox: ZF Nabenprofil / Hub Profile: 41,1x50,8-10N (48)
				3400 700 456 ■	430 10	Getr. / GBox: Fuller Nabenprofil / Hub Profile: 41,1x50,8-10N (48)
				3482 083 040	430 MFZ430	Getr. / GBox: Fuller Getr. / GBox: ZF In 3483/3488 enthalten / Contained in 3483, 3488 (32)
				3100 002 040 ⊗ 3151 000 148 ⊗ 3180 001 008	KZIS5	Getr. / GBox: Fuller Getr. / GBox: ZF Beinhaltet Ausrücker und Montagesatz / Contains releaser and fitting kit (9)
						In 3483/3488 enthalten / Contained in 3483, 3488 (32)







































		CODE		 Parameter		
--	--	------	--	---	---	---

IVECO

260...						
260-48 Turbo Star	01.89-	8280		3400 117 801 ⊗ 3482 083 032 ⊗ 1878 085 741 ⊙ 3151 000 144	430 10 MFZ430 430WGTZ KZISZ-5	Getr. / GBox: ZF für Ausrückgabel mit Nocken / for release fork with cams (70)
				3400 700 435 ⊗ 3482 083 032 ⊗ 1878 085 741 ⊙ 3151 000 493	430 10 MFZ430 430WGTZ KZISZ-5	Getr. / GBox: ZF für Ausrückgabel mit Rollen / for release fork with rollers (71)
				3400 700 455 ■	430 10	Getr. / GBox: Fuller Nabenprofil / Hub Profile: 41,1x50,8-10N (48)
260 PAC 260 PAT		8210		3482 085 033	420 MF420	enthält Druckplattenbefestigungsschrauben / includes bolt for pressure plate mounting (65)
				1878 001 138	420 10 420GTZ	
				3151 000 515	KZIS-4	



300...						
300-23				1882 325 134	380 G380	
				1878 000 104	380 10 380GTZ	
				3151 000 395	KZIS-4	
300-25 AHB		F8L513		3482 124 534	430 GMF430	Getr. / GBox: ZF
				1882 301 239 ●	420 GF420	Getr. / GBox: ZF
				1878 001 138	420 10 420GTZ	Getr. / GBox: ZF
				3151 000 515	KZIS-4	Getr. / GBox: ZF
300-32 300-34		BF8L513		3482 124 516	430 GMF430	
				1878 002 955	420 10 420GTZ	
				3151 000 515	KZIS-4	
300 PC				3482 085 033	420 MF420	->Chass. 014757 enthält Druckplattenbefestigungsschrauben / includes bolt for pressure plate mounting (65)
				1878 634 020	420 10 420GSZ	->Chass. 014757
				3151 117 031	KZI-5	->Chass. 014757
300 PT				3482 085 033	420 MF420	->Chass. 04386 enthält Druckplattenbefestigungsschrauben / includes bolt for pressure plate mounting (65)
				1878 634 020	420 10 420GSZ	->Chass. 04386
				3151 117 031	KZI-5	->Chass. 04386

320...						
320-30 N	01.88-	8210		3482 125 131	420 MF420	Getr. / GBox: Fuller enthält Druckplattenbefestigungsschrauben / includes bolt for pressure plate mounting (65)
				1878 002 955	420 10 420GTZ	Getr. / GBox: Fuller
				3151 000 515	KZIS-4	Getr. / GBox: Fuller
320-32 AHB				3482 124 516	430 GMF430	
				1878 002 955	420 10 420GTZ	
				3151 000 515	KZIS-4	

330...						
330-25 AH, AN 330-26 AH, AN		F8L413F	 3482 124 531	430 GMF430		
			 1882 316 035 ●#	420 GF420		
			 1878 002 955	420 10 420GTZ		
			 3151 000 515	KZIS-4		
330-26 H			 1878 003 274	420 10 420GTZ	Nebenantriebs-ID / PTO ID: 110E	(50)
330-26 H, HT 330-26 N 330 PAC 26 330 PC 26 6x4 330 PT 26 6x4 330-30 N		8210	 3400 119 001 ☾	420 10 MF420	enthält Druckplattenbefestigungsschrauben / includes bolt for pressure plate mounting	(65)
			 3482 085 033	420GTZ		
			 1878 001 138	420GTZ		
			 1874 015 200			
	- 12.87		 3151 000 515	KZIS-4		
330-32 AN, ANW		F10L413F	 3482 124 532	430 GMF430		
			 1878 002 955	420 10 420GTZ		
			 3151 000 515	KZIS-4		
330-32 ANW			 1878 003 274	420 10 420GTZ	Nebenantriebs-ID / PTO ID: 100E	(50)
330-35 H, HT, HW		8280	 1878 003 274	420 10 420GTZ	Getr. / GBox: ZF, Fuller, Fiat Nebenantriebs-ID / PTO ID: 110E	(50)
330-35 H,HT,HN,HW Prod.-Nr. 42240		8280	 3400 042 031 ☾	420 10 MF420	enthält Druckplattenbefestigungsschrauben / includes bolt for pressure plate mounting	(65)
			 3482 125 131	420GTZ		
			 1878 002 955	420GTZ		
			 1874 015 200			
			 3151 000 515	KZIS-4		
330-36 AH, AHT			 3483 020 034 ⊕	430 MFZ430		
			 1861 992 432	430 10 430GVZ		
			 3482 083 040	430 MFZ430	In 3483/3488 enthalten / Contained in 3483, 3488	(32)
			 3100 002 040	KZIZ5	Beinhaltet Ausrücker und Montagesatz / Contains releaser and fitting kit	(9)
			 3151 000 148			
			 3180 001 008		In 3483/3488 enthalten / Contained in 3483, 3488	(32)
330-36 AH, AHT	06.84-		 3483 020 035 ⊕	430 MFZ430		
			 1878 022 841	430 10 430GTZ		
			 3482 083 040	430 MFZ430	In 3483/3488 enthalten / Contained in 3483, 3488	(32)
			 3100 002 038	KZIZ5	Beinhaltet Ausrücker und Montagesatz / Contains releaser and fitting kit	(9)
			 3151 123 031	KZI/Z-5	In 3483/3488 enthalten / Contained in 3483, 3488	(32)
			 3180 001 008			
330 PC 26			 3400 042 031 ☾	420 10 MF420	für / for: Version 42240590	(69)
			 3482 125 131	420GTZ	enthält Druckplattenbefestigungsschrauben / includes bolt for pressure plate mounting	(65)
			 1878 002 955			
			 1874 015 200			
			 3482 124 541	430 GMF430	für / for: Version 42240569	(69)
		für / for: Version 42240611	(69)			
		für / for: Version 42240569	(69)			
		für / for: Version 42240611	(69)			
		für / for: Version 42240569	(69)			
		für / for: Version 42240611	(69)			
			 3151 000 515	KZIS-4		
330 PC 35 330 PT 35		8280	 1878 003 274	420 10 420GTZ	Getr. / GBox: Fiat, Fuller, ZF Nebenantriebs-ID / PTO ID: 110E	(50)

























		CODE		 Parameter		
--	--	------	--	---	---	---

IVECO

340...						
340-34		BF8L513		3482 124 516	430 GMF430	
				1878 002 955	420 10 420GTZ	
				3151 000 515	KZIS-4	













































613 - 619						
613 N 3				1878 600 834	250 10 250CB	Chass. 106895->
616 N 3/4	05.76-			1878 600 834	250 10 250CB	
619 NIP 016045-				3482 085 033	420 MF420	enthält Druckplattenbefestigungsschrauben / includes bolt for pressure plate mounting
				1878 634 020	420 10 420GSZ	
				3151 117 031	KZI-5	

KAMAZ

4 01.69 -							
4307		B3.90-140CIV-1, B5.9140CIV-1, Cummins		3482 000 419	362 MF362	Getr. / GBox: ZF-S5-42	
				1878 002 599	362 10 362GTZ	Getr. / GBox: ZF-S5-42	
				3151 000 958	KZIS-4	Getr. / GBox: ZF-S5-42	
4308		B5.90-180CIV-0 , Cummins		3483 000 001 ⊕	350 MFZ350		
				1878 002 642	350 10 350CZ		
				3482 000 419	362 MF362	Getr. / GBox: ZF-6S-850	
				1878 002 071	362 10 362GTZ	Getr. / GBox: ZF-6S-850	
				3151 000 419	KZIS-4	Getr. / GBox: ZF-6S-850	
4308	01.03-	B5.9180CIV-0		3482 000 419	362 MF362	Getr. / GBox: ZF6S-850	
				1878 002 071	362 10 362GTZ	Getr. / GBox: ZF6S-850	
				3151 000 419	KZIS-4	Getr. / GBox: ZF6S-850	
			3482 000 474	395 MF395	Getr. / GBox: AS-Tronic 6S1000To		
			1878 000 294	395 10 395WGTZ	Getr. / GBox: AS-Tronic 6S1000To		
			3151 000 419	KZIS-4	Getr. / GBox: AS-Tronic 6S1000To		
			Cummins4ISBe 185		3482 000 419	362 MF362	Getr. / GBox: ZF 6S700
					1878 002 599	362 10 362GTZ	Getr. / GBox: ZF 6S700
					3151 000 419	KZIS-4	Getr. / GBox: ZF 6S700
					3400 700 345	430 10 MFZ430 430GTZ KZISZ-5	Getr. / GBox: KAMA3-154
4355 43118	05.87-	740.30-260		3482 083 118 1878 000 206 3151 000 034			
4807 43255	01.03-	B5.9140CIV-1		3482 000 419	362 MF362	Getr. / GBox: S5-42	
				3151 000 958	KZIS-4	Getr. / GBox: S5-42	
43253		Cummins6ISBe 285		3482 000 474	395 MF395	Getr. / GBox: ZF 6 S 1000	
				1878 004 094	395 10 395GTZ	Getr. / GBox: ZF 6 S 1000	
				3151 000 419	KZIS-4	Getr. / GBox: ZF 6 S 1000	
44108 45141	01.03- 05.90-	740.30-260		3400 700 344	430 10	Getr. / GBox: KAMA3-154	

























		CODE				
--	--	------	--	---	---	---

KAMAZ

5							01.69 -						
5308	05.11 -	CummiISBe4300		3482 000 474	395	Getr. / GBox: ZF 16 S 109							
				3151 000 419		MF395 KZIS-4	Getr. / GBox: ZF 16 S 109						
5350		740.30-260, KAMAZ/YAMZ		3400 700 345  3482 083 118  1878 000 206  3151 000 034	430 10 MFZ430 430GTZ KZISZ-5	Getr. / GBox: KAMAZ 154							
5360	05.86 -	740.30-260		3400 700 344  3482 083 118  1878 008 030  3151 000 034	430 10 MFZ430 430GTZ KZISZ-5	Getr. / GBox: KAMA3-154							
5360 5460	05.86 - 05.03 -	740.50-360		3400 700 344  3482 083 118  1878 008 030  3151 000 034	430 10 MFZ430 430GTZ KZISZ-5	Getr. / GBox: 16S 151							
5490	12.13 -	OM457		3400 700 420  3482 000 209  1878 080 037	430 10 MFZ430 430WGTZ	Getr. / GBox: ZF AS Tronic Euro 5 / Euro 5					(17)		
				3151 000 493		KZISZ-5	Getr. / GBox: ZF AS Tronic Euro 5 / Euro 5 für Ausrückgabel mit Rollen / for release fork with rollers					(17) (71)	
				3482 083 032	430	MFZ430	Getr. / GBox: ZF 16 S 2221 Euro 5 / Euro 5						(17)
				1878 085 641	430 10	430GTZ	Getr. / GBox: ZF 16 S 2221 Euro 5 / Euro 5						(17)
				3151 000 034		KZISZ-5	Getr. / GBox: ZF 16 S 2221 Euro 5 / Euro 5						(17)
				3189 600 004			Getr. / GBox: ZF AS Tronic Rollenausführung / roller version						(58)
53205 53215 53228 53229 53605 54115 55111	05.06 - 05.04 - 05.99 - 05.99 - 05.05 - 05.84 - 05.82 -	740.11-240, 740.13-240, 740.31-240		3482 000 463	395 MF395	Getr. / GBox: KAMA3-152							
				1878 039 631	395 10 395GTZ	Getr. / GBox: KAMA3-152							
				3151 000 958		KZIS-4	Getr. / GBox: KAMA3-152						
		740.31, 740.11		1878 000 967	380 10 380GTZ	für Fahrzeuge mit Zweischeibenkupplung / for vehicles with double disc clutch Lose Kupplungsscheibe / Loose clutch disc					(77) (41)		
53215	11.05 -	740.11-240, 740.13-260, 740.31-240, KAMAZ/YAMZ		3482 000 463	395 MF395	Getr. / GBox: KAMAZ Getr. / GBox: 141 142 152							
				1878 039 631	395 10 395GTZ	Getr. / GBox: KAMAZ Getr. / GBox: 141 142 152							
				3151 000 958		KZIS-4	Getr. / GBox: KAMAZ Getr. / GBox: 141 142 152						
				740.31-240, KAMAZ/YAMZ		3400 700 344  3482 083 118  1878 008 030  3151 000 034	430 10 MFZ430 430GTZ KZISZ-5	Getr. / GBox: ZF-Ecosplit 16S-151					
						3482 083 118	430 MFZ430	Getr. / GBox: ZF-Ecomit 9S-109					
						1878 000 206	430 10 430GTZ	Getr. / GBox: ZF-Ecomit 9S-109					
						3151 000 157		KZISZ-5	Getr. / GBox: ZF-Ecomit 9S-109				
53605	05.05 -	740.30-260		3400 700 344  3482 083 118  1878 008 030  3151 000 034	430 10 MFZ430 430GTZ KZISZ-5	Getr. / GBox: KAMA3-154							
		740.11-240, 740.13-240, 740.31-240		3482 000 463	395 MF395	Getr. / GBox: KAMA3-152							
				1878 039 631	395 10 395GTZ	Getr. / GBox: KAMA3-152							
				3151 000 958		KZIS-4	Getr. / GBox: KAMA3-152						
		740.30		1878 000 967	380 10 380GTZ	für Fahrzeuge mit Zweischeibenkupplung / for vehicles with double disc clutch Lose Kupplungsscheibe / Loose clutch disc						(77) (41)	





		CODE				
--	--	------	--	---	---	---

KAMAZ



6							01.69 -	
65206	12.13-	OM457		3482 083 032	430 MFZ430	Getr. / GBox: ZF 16 S 2221 Euro 5 / Euro 5	(17)	
				1878 085 641	430 10 430GTZ	Getr. / GBox: ZF 16 S 2221 Euro 5 / Euro 5	(17)	
				3151 000 034	KZISZ-5	Getr. / GBox: ZF 16 S 2221 Euro 5 / Euro 5	(17)	
63501 6450 6520-06 65201 65224	05.03- 05.02- 01.03- 05.06- 05.05-	740.50-360		3400 700 344 ⊗ 3482 083 118 ⊗ 1878 008 030 ⊙ 3151 000 034	430 10 MFZ430 430GTZ KZISZ-5	Getr. / GBox: 16S 151		
6460	10.03-	740.50-360		3400 700 344 ⊗ 3482 083 118 ⊗ 1878 008 030 ⊙ 3151 000 034	430 10 MFZ430 430GTZ KZISZ-5	Getr. / GBox: 16S 151		
				3482 083 032	430 MFZ430	Getr. / GBox: 16S 151		
				1878 085 641	430 10 430GTZ	Getr. / GBox: 16S 151		
				3151 000 034	KZISZ-5	Getr. / GBox: 16S 151		
6460		740.50-360, 740.51-320, KAMAZ/YAMZ		3400 700 344 ⊗ 3482 083 118 ⊗ 1878 008 030 ⊙ 3151 000 034	430 10 MFZ430 430GTZ KZISZ-5	Getr. / GBox: ZF-Ecosplit 16S-151		
				3482 083 032	430 MFZ430	Getr. / GBox: ZF 16S-151		
		740.37-400, KAMAZ		1878 085 641	430 10 430GTZ	Getr. / GBox: ZF 16S-151		
				3151 000 034	KZISZ-5	Getr. / GBox: ZF 16S-151		
6520	05.03-	740.51-320		3400 700 344 ⊗ 3482 083 118 ⊗ 1878 008 030 ⊙ 3151 000 034	430 10 MFZ430 430GTZ KZISZ-5	Getr. / GBox: ZF 16S 151		
				3400 700 327 ⊗ 3482 114 031 ⊗ 1878 004 832 ⊙ 3151 263 031	430 10 GMFZ430N 430WGTZ KZIZ-6	Nebenantriebs-ID / PTO ID: NMV 221	(50)	
6520		740.50-360, 740.51-320, KAMAZ/YAMZ		3400 700 344 ⊗ 3482 083 118 ⊗ 1878 008 030 ⊙ 3151 000 034	430 10 MFZ430 430GTZ KZISZ-5	Getr. / GBox: ZF-Ecosplit 16S-151		
		740.51-320, KAMAZ		3400 700 327 ⊗ 3482 114 031 ⊗ 1878 004 832 ⊙ 3151 263 031	430 10 GMFZ430N 430WGTZ KZIZ-6	Nebenantriebs-ID / PTO ID: NMV221	(50)	
6522	05.05-	740.51		3400 700 344 ⊗ 3482 083 118 ⊗ 1878 008 030 ⊙ 3151 000 034	430 10 MFZ430 430GTZ KZISZ-5			
6540 65111 65116 65117	05.02- 05.08- 05.06-	740.30-260		3400 700 345 ⊗ 3482 083 118 ⊗ 1878 000 206 ⊙ 3151 000 034	430 10 MFZ430 430GTZ KZISZ-5	Getr. / GBox: KAMA3-154		
65111 65115	05.00- 05.95-	740.11-240, 740.13-260, 740.31-240, KAMAZ/YAMZ		3482 000 463	395 MF395	Getr. / GBox: KAMAZ Getr. / GBox: 141 142 152		
				1878 039 631	395 10 395GTZ	Getr. / GBox: KAMAZ Getr. / GBox: 141 142 152		
				3151 000 958	KZIS-4	Getr. / GBox: KAMAZ Getr. / GBox: 141 142 152		
	740.31-240, KAMAZ/YAMZ		3400 700 344 ⊗ 3482 083 118 ⊗ 1878 008 030 ⊙ 3151 000 034	430 10 MFZ430 430GTZ KZISZ-5	Getr. / GBox: ZF-Ecosplit 16S-151			
			3482 083 118	430 MFZ430	Getr. / GBox: ZF-Ecomit 9S-109			
			1878 000 206	430 10 430GTZ	Getr. / GBox: ZF-Ecomit 9S-109			
			3151 000 157	KZISZ-5	Getr. / GBox: ZF-Ecomit 9S-109			

		CODE				
--	--	------	--	---	---	---

















KAMAZ

6							01.69 -						
65115	05.95 -	740.30-260		3400 700 345 ⊗ 3482 083 118 ⊗ 1878 000 206 ⊙ 3151 000 034	430 10 MFZ430 430GTZ KZISZ-5	Getr. / GBox: KAMA3-154							
		740.62-280		3482 083 118	430 MFZ430	Getr. / GBox: ZF 9 S 1310							
				1878 000 206	430 10 430GTZ	Getr. / GBox: ZF 9 S 1310							
65225	05.04 -	740.50-360		3400 700 345 ⊗ 3482 083 118 ⊗ 1878 000 206 ⊙ 3151 000 034	430 10 MFZ430 430GTZ KZISZ-5	Getr. / GBox: 16S 151 / 16 S 1820							

KÄSSBOHRER







Pistenbully											
Pistenbully		OM352A		1882 252 331	310 GFX310						
				1861 303 248	310 10 310GSB						
		OM616		1882 252 331	310 GFX310						













LIEBHERR

Kran / crane													
AK 35 AK 40				1881 010 139 #	250 G250								
				1864 202 035 #	250 10 250Z								
AK 40 b				1864 634 023	225 10 225Z								
LG 1130 LT 1050 LT 1055 LT 1110				1888 015 523 #	380 GF2/380	enthält eine Kupplungsscheibe / This part number includes one clutch disc					(67)		
				1878 000 967 ▽	380 10 380GTZ	Lose Kupplungsscheibe / Loose clutch disc						(41)	
				3151 208 001	KZI-5								
				1882 280 213	380 GF2/380	In 1888 enthalten / Contained in 1888							(31)
				1859 212 001	380 GF2/380	In 1888 enthalten / Contained in 1888							(31)
				1878 000 964 △	380 10 380GTZ	In 1888 enthalten / Contained in 1888							(31)
LI 1010				1881 010 139 #	250 G250								
				3151 045 001	KZI-2								
LT 1020 LT 1030 LT 1060		DBOM355		1882 166 737	380 GF380								
LT 1025		KHDBF6L913LL K		1878 001 070	350 10 350GTZ								
				3151 000 395	KZIS-4								
LT 1035		DBOM402		1882 302 131	380 GF380								
				1878 000 105	380 10 380GTZ								
				3151 000 375	KZIS-4								

		CODE		 Parameter		
--	--	------	--	---	---	---

LIEBHERR

Kran / crane						
LT 1045 LT 1080	05.75-	DBOM403	 1888 015 523 #	380 GF2/380	enthält eine Kupplungsscheibe / This part number includes one clutch disc	(67)
			 1878 000 967 ▽	380 10 380GTZ	Lose Kupplungsscheibe / Loose clutch disc	(41)
			 3151 208 001	KZI-5		
			 1882 280 213	380 GF2/380	In 1888 enthalten / Contained in 1888	(31)
			 1859 212 001	380 GF2/380	In 1888 enthalten / Contained in 1888	(31)
			 1878 000 964 △	380 10 380GTZ	In 1888 enthalten / Contained in 1888	(31)
LTM 1085 OW		D934S	 1866 000 062	466 18 466/ 232NGT	max. übertragbares Motormoment [Nm] / max. transmittable engine torque [Nm]: 2719	(87)

















Mobilbagger / mobile excavator						
A 312 A 314 A 316			 1866 156 001	314 18 314/ 159NGS	max. übertragbares Motormoment [Nm] / max. transmittable engine torque [Nm]: 670	(87)
A 350 A 400 A 500 N			 1881 010 139 #	250 G250		
			 1864 202 035 #	250 10 250Z		
A 353			 1880 083 132 #	280 G280		
			 1863 600 125	GR-3	mit Anlauftring / with thrust ring	(88)
A 900 C-ZW			 1866 157 103 ▲	345 24 345/ 232NGT	max. übertragbares Motormoment [Nm] / max. transmittable engine torque [Nm]: 1810	(87)
A 900 LI A 900 ZW			 1866 138 101	314 16 314/ 159NGS	max. übertragbares Motormoment [Nm] / max. transmittable engine torque [Nm]: 670	(87)
A 902 Indurstie A 902 LI			 1866 136 001	345 16 345/ 159NGS	max. übertragbares Motormoment [Nm] / max. transmittable engine torque [Nm]: 823	(87)
A 904 A 904 C, HD A 912 A 914, B A 922, HD A 924 B A 924 HD			 1866 000 332	345 345/212GT		
A 932 LI A 934 B LI A 934 LI A 944 LI			 1866 000 337	345 24 345/212GT	max. übertragbares Motormoment [Nm] / max. transmittable engine torque [Nm]: 2500	(87)
A 934 C LI			 1866 000 151	345 24 345/ 232NGT	max. übertragbares Motormoment [Nm] / max. transmittable engine torque [Nm]: 3415	(87)
A 942		KHD	 1866 065 001	345 22 345/210GS	max. übertragbares Motormoment [Nm] / max. transmittable engine torque [Nm]: 1400	(87)

Radlader / wheel loader						
L 538 L 542			 1866 000 079	466 18 466/ 232NGT	max. übertragbares Motormoment [Nm] / max. transmittable engine torque [Nm]: 2719	(87)

		CODE				
--	--	------	--	---	---	---

LIEBHERR







Radlader / wheel loader						
L 544				1866 000 007	345 18 345/ 254NGT	max. übertragbares Motormoment [Nm] / max. transmittable engine torque [Nm]: 2490 (87)
L 550						
L 554						
L 556						
L 564						
L 566						
L 574						
L 576						
L 580						

Raupenbagger / crawler excavator						
MR 500 N				1881 010 139 #	250 G250	
R 350						
R 400				1864 202 035 #	250 10 250Z	
R 500 N						
R 317				1866 156 001	314 18 314/ 159NGS	max. übertragbares Motormoment [Nm] / max. transmittable engine torque [Nm]: 670 (87)
		BF4M1013C		1866 000 021	314 21 314/ 188NGT	max. übertragbares Motormoment [Nm] / max. transmittable engine torque [Nm]: 1240 (87)
R 321				1866 136 001	345 16 345/ 159NGS	max. übertragbares Motormoment [Nm] / max. transmittable engine torque [Nm]: 823 (87)
R 902 LI						
R 324				1866 157 101	345 24 345/ 232NGT	max. übertragbares Motormoment [Nm] / max. transmittable engine torque [Nm]: 2719 (87)
R 353				1880 083 132 #	280 G280	
				1863 600 125	GR-3	mit Anlaufring / with thrust ring (88)
R 900 LI				1866 138 101	314 16 314/ 159NGS	max. übertragbares Motormoment [Nm] / max. transmittable engine torque [Nm]: 670 (87)
R 912				1866 000 332	345 345/212GT	
R 932 LI, T				1866 000 337	345 24 345/212GT	max. übertragbares Motormoment [Nm] / max. transmittable engine torque [Nm]: 2500 (87)
R 932 LI TR BAUER						
R 932 LI TR DELMAG						
R 934 B, T						
R 942 LI						
R 942 LI TR BAUER						
R 944						
R 934 C				1866 000 337	345 24 345/212GT	max. übertragbares Motormoment [Nm] / max. transmittable engine torque [Nm]: 2500 (87)
				1866 000 151	345 24 345/ 232NGT	max. übertragbares Motormoment [Nm] / max. transmittable engine torque [Nm]: 3415 (87)
R 942				1866 065 001	345 22 345/210GS	max. übertragbares Motormoment [Nm] / max. transmittable engine torque [Nm]: 1400 (87)
R 944 C TU				1866 000 151	345 24 345/ 232NGT	max. übertragbares Motormoment [Nm] / max. transmittable engine torque [Nm]: 3415 (87)
R 952, LI				1866 090 001	390 18 390/ 210NGS	max. übertragbares Motormoment [Nm] / max. transmittable engine torque [Nm]: 1950 (87)
R 962-133 LC						
R 962-225 HD						
R 962-226 LC SL						
R 962-385 HD-EW						
R 964 B				1866 148 001	466 22 466/ 288NGT	max. übertragbares Motormoment [Nm] / max. transmittable engine torque [Nm]: 2789 (87)
R 964 LI						
R 974						
R 974 C				1866 000 152	466 22 466/ 288NGT	max. übertragbares Motormoment [Nm] / max. transmittable engine torque [Nm]: 4500 (87)
R 984 C						



		CODE				
--	--	------	--	---	---	---

MAGIRUS-DEUTZ

A 3500 - S 5500

A 3500 A 4500 (Mercur) S 3500 S 4500		F4L514		1880 083 132 #	280 G280		
				1863 600 125	GR-3	mit Anlauftring / with thrust ring	(88)
S 4500 , F3, M6, TW6 (Chassis K 3500) S 4500 F				1880 083 132 #	280 G280		
				1863 600 125	GR-3	mit Anlauftring / with thrust ring	(88)
S 4500 S S 5500				1881 039 532 #	350 G350KR		
				1878 001 074	350 10 350GTZ		
				1863 600 125	GR-3	mit Anlauftring / with thrust ring	(88)









Jupiter

Jupiter 6x6 Z				1882 325 134	380 G380		
				1861 470 234	380 10 380GSZ		
				1863 010 100	GR-4	mit Anlauftring / with thrust ring	(88)

Mercur

Mercur A Mercur S		F4L514		1880 083 132 #	280 G280		
				1863 600 125	GR-3	mit Anlauftring / with thrust ring	(88)



Saturn

Saturn		S6L714		1881 039 532 #	350 G350KR		
				1878 001 074	350 10 350GTZ		
Saturn -Europawagen		S6L714		1882 325 139	380 G380		
				1878 000 104	380 10 380GTZ		
				3151 000 395	KZIS-4		
Saturn 145 a		F6L714		1881 039 532 #	350 G350KR		
				1878 001 074	350 10 350GTZ		
				1863 600 125	GR-3	mit Anlauftring / with thrust ring	(88)

70...

















70 D 6 FL		F4L812D		1881 010 139 #	250 G250		
				3151 045 001	KZI-2		
70 M 6 FL				3151 199 001	KZIS-3		
75 D 6 FL		F4L912		1881 010 139 #	250 G250		
				3151 045 001	KZI-2		

80...

80 D 6/7/8 FK				1881 010 139 #	250 G250	Getr. / GBox: 5-524	
				3151 045 001	KZI-2	Getr. / GBox: 5-524	









		CODE				
--	--	------	--	---	---	---

MAGIRUS-DEUTZ















90...						
90 D 5,2 FL,FV,FK 90 D 5,6 FL,FV,FK 90 D 6,0 FL,FV,FK 90 D 6,5 FL,FV,FK 90 D 7,5 FL,FV,FK 90 M 6 FL,FK 90 M 7 FL,FG,FGB,FK 90 M 8 FL,FK 90 M 9 FL		F4L913		3151 199 001	KZIS-3	
90 M 5,3 FL,FV,FK 90 M 5,7 FL,FV,FK 90 M 5,9 FL,FV,FK 90 M 6,0 FL,FK,FV 90 M 6,6 FL,FV,FK 90 M 7,5 FL,FV,FK 90 M 7,9 FL, FV, FK 90 M 9,0	-02.82 -02.82 -02.82 -02.82 -02.82 -02.82 -02.82	F4L913		1878 600 841	280 10 280CTB	
				1850 282 652 ▲	KZA-2	
100...						
100 R		F6L413		1881 039 532 #	350 G350KR	Getr. / GBox: ZF S-6/80
				1878 005 367	350 10 350WGTZ	Getr. / GBox: ZF S-6/80
				1863 600 125	GR-3	Getr. / GBox: ZF S-6/80 mit Anlauffring / with thrust ring (88)
110...						
112 D 9 AS				1881 039 532 #	350 G350KR	
				1878 001 074	350 10 350GTZ	
				1863 600 125	GR-3	mit Anlauffring / with thrust ring (88)
120...						
120 120 F 125 D 10 A 126 126 AK 126 D 11 126 F				1861 600 033 #	310 10 310GTD	
				1863 600 125	GR-3	mit Anlauffring / with thrust ring (88)
126 D 12, 14 F		F6L312		1861 600 033 #	310 10 310GTD	
				1863 600 125	GR-3	mit Anlauffring / with thrust ring (88)
130...						
130 D 9 AL	07.77 -			3482 002 234	350 GMF350X	
				1878 001 070	350 10 350GTZ	
				3151 000 515	KZIS-4	

		CODE				
--	--	------	--	---	---	---

MAGIRUS-DEUTZ

130...						
130 D 9 FA, FL 130 D 11 FL 130 D 12 AK, K 130 D 13 FL 130 D 15 K 130 D 16 FL, FLL 130 M 7 FL, FAL 130 M 8 FL, FS, FK, FAL 130 M 9 FL, FS, FK, FG 130 M 11 FL, FK 130 M 13 FL 130 M 13 FL, FGB, FK		F6L913/Turbo		3482 008 033	310 MF310	
				1861 577 037 #	310 10 310GTD	
				3151 199 001	KZIS-3	
130 D 13 AK	04.77 -			3482 002 234	350 GMF350X	
				1878 001 070	350 10 350GTZ	
				3151 000 395	KZIS-4	
135 D 10, D 12, D 14 FS, FL		F6L312		1861 600 033 #	310 10 310GTD	
				1863 600 125	GR-3	mit Anlaufring / with thrust ring (88)

140...						
140 D 11 F, K, AK				1881 039 532 #	350 G350KR	
				1878 001 074	350 10 350GTZ	
145 AK 6x6		D8FL		1881 039 532 #	350 G350KR	
				1878 001 074	350 10 350GTZ	
				1863 600 125	GR-3	mit Anlaufring / with thrust ring (88)

150...						
150 ,150/1F 150 AK 6x6 150 D 13 FL, FS 150 D 14 156 D 15 K	-02.62			1881 039 532 #	350 G350KR	
				1878 001 074	350 10 350GTZ	
				1863 600 125	GR-3	mit Anlaufring / with thrust ring (88)
150 AK 6x6 150 L 6x4 156 D 22	03.62 -			1881 039 532 #	350 G350KR	
				1878 001 074	350 10 350GTZ	
150 D 10 A		F6L714		1878 001 074	350 10 350GTZ	
				1863 600 125	GR-3	mit Anlaufring / with thrust ring (88)
150 D 14 AK				1861 600 033 #	310 10 310GTD	
				1863 600 125	GR-3	mit Anlaufring / with thrust ring (88)
150 D 22 FL 6x4		F6L714		1881 039 532 #	350 G350KR	
				1878 001 074	350 10 350GTZ	
				1863 600 125	GR-3	mit Anlaufring / with thrust ring (88)
156 D 14 K 156 D 15 AK 156 D 16 AK		FL814		1881 039 532 #	350 G350KR	
				1878 001 074	350 10 350GTZ	
				1863 600 125	GR-3	mit Anlaufring / with thrust ring (88)



CODE



SACHS

Parameter



MAGIRUS-DEUTZ

160...





























160 D 11 FL, FS 160 D 12 K 160 D 15 K 160 D 16 FL, FLL 160 M 11 FL, FS		BF6L913		3482 060 233	350 MF350		
				1861 777 037	350 10 350GTD		
				3151 199 001	KZIS-3		
160 D 11-D 17				1882 307 131 ▲	350 GF350		
				1878 001 074	350 10 350GTZ		
				3151 000 515	KZIS-4		
160 D 12 AK 168 M 13 FL 168 M 16 FL	01.82-			1882 307 131 ▲	350 GF350		
				1878 001 070	350 10 350GTZ		
				3151 000 515	KZIS-4		
160 D 16 FL				1882 307 131 ▲	350 GF350		
				1878 001 074	350 10 350GTZ		
160 M 11 FA, FS, FK 160 M 13 FL, FS, FK 160 M 7 FA 160 M 8 FL, FAL 168 M 11 FL, FAL				3482 038 031	350 GMF350		
				1861 742 032	350 10 350GTB		
				3151 199 001	KZIS-3		
160 M 11 FK (Version 2550435)				3482 008 036 #	310 MF310		
				1861 577 136 #	310 10 310GTD		
				3151 199 001	KZIS-3		
168 M 14 FK 168 M 14 FL (Version 42230423)				3482 002 234	350 GMF350X		
				1878 001 077	350 10 350GTZ		
				3151 000 515	KZIS-4		
168 M 14 FL				1882 307 131 ▲	350 GF350	für / for: Version 61602271	(69)
				1878 001 070	350 10 350GTZ	für / for: Version 61602271	(69)
				3151 000 515	KZIS-4	für / for: Version 61602271	(69)

170...

170 D 10 AK 170 D 11 F 170 D 11 FA 170 D 21 AK 6x6		- 11.83		1881 039 532 #	350 G350KR		
				1878 001 074	350 10 350GTZ		
				1863 600 125	GR-3	mit Anlaufring / with thrust ring	(88)
170 D 11 FA	12.83-			3482 002 234	350 GMF350X		
				1878 001 070	350 10 350GTZ		
				3151 000 515	KZIS-4		









		CODE					
--	--	------	--	--	---	---	---









MAGIRUS-DEUTZ

170...							
170 D 11 FL 170 D 12 AK, AL 170 D 12, FL 170 D 13 FS, FL 170 D 15 AK, FAK, FK, K 170 D 15 FL 170 D 16 FL 170 D 16 K 170 D 17 F, K, AK 170 D 19 L, FL, AL 170 D 24 K, L	F6L413		1881 039 532 #	350 G350KR			
			1878 005 367	350 10 350WGTZ			
			1863 600 125	GR-3	mit Anlaufring / with thrust ring		(88)
170 D 11 FL			1882 261 013 #	380 G380N	Nebenantriebs-ID / PTO ID: 70/1		(50)
			3151 111 032	KZI-6	ohne Schmierrohranschluss / without lubricating pipe connection Nebenantriebs-ID / PTO ID: 70/1		(103) (50)
170 D 14 SL, FL, FS	F6L413		1881 039 532 #	350 G350KR			
			1878 005 367	350 10 350WGTZ			
			1863 600 125	GR-3	mit Anlaufring / with thrust ring		(88)
170 D 19 F			1882 325 134	380 G380			
			1861 351 342 #	380 10 380WGSZ			
			1863 600 125	GR-3	mit Anlaufring / with thrust ring		(88)
180...							
180 D 12 FL			1878 001 074	350 10 350GTZ			
			1863 600 125	GR-3	mit Anlaufring / with thrust ring		(88)
180 LS 12	F8L312		1881 039 532 #	350 G350KR			
			1878 001 074	350 10 350GTZ			
186 D 13 FL 186 D 15 FL 186 D 17 FL	FL312		1878 001 074	350 10 350GTZ			
			1863 600 125	GR-3	mit Anlaufring / with thrust ring		(88)
190...							
192 D 11 F, FA 192 D 13 F 192 M 12 FA			3482 002 234	350 GMF350X			
			1878 001 070	350 10 350GTZ			
			3151 000 515	KZIS-4			
192 D 12 AL			3482 002 234	350 GMF350X			
			1878 001 070	350 10 350GTZ			
			3151 000 395	KZIS-4			
192 M 14 FL 2			1882 325 134	380 G380			
			1878 000 957	380 10 380GTZ			
			3151 000 515	KZIS-4			
192 M 14 FL, FS 192 M 16 F, FL, FS			1882 325 134	380 G380			
			1878 000 957	380 10 380GTZ			



		CODE				
--	--	------	--	---	---	---





MAGIRUS-DEUTZ

190...						
195 195 L				1882 325 134	380 G380	Radstand [mm] / Wheelbase [mm]: 5400 Für Export / for export (57) (27)
				1861 470 234	380 10 380GSZ	Radstand [mm] / Wheelbase [mm]: 5400 Für Export / for export (57) (27)
				1863 010 100	GR-4	Radstand [mm] / Wheelbase [mm]: 5400 Für Export / for export (57) (27) mit Anlauftring / with thrust ring (88)
195				1882 325 134	380 G380	
				1861 470 234	380 10 380GSZ	
				1863 010 100	GR-4	mit Anlauftring / with thrust ring (88)
195 D		F8L714		1882 325 134	380 G380	
				1861 351 342 #	380 10 380WGSZ	
				1863 010 100	GR-4	mit Anlauftring / with thrust ring (88)

200...						
200 D 15 FAK 200 D 18				1882 325 134	380 G380	
				1878 000 104	380 10 380GTZ	
200 D 16 200 D 26 200 D F, K, AK, S, L 200 D FS, FL 6x4				1882 325 134	380 G380	
				1861 470 234	380 10 380GSZ	
				1863 010 100	GR-4	mit Anlauftring / with thrust ring (88)
200 D 16 F 200 D 22 B				1882 325 134	380 G380	
				1878 000 104	380 10 380GTZ	
				3151 000 395	KZIS-4	





























210...						
210 D 16 210 D 16 F 210 D 18				1882 325 134	380 G380	
				1878 000 104	380 10 380GTZ	
210 D 16 AK 210 D 22 210 D 26 K				1882 325 134	380 G380	
				1878 000 104	380 10 380GTZ	
				3151 000 395	KZIS-4	

220...						
228 M 16 AK				1882 325 139	380 G380	
				1878 000 957	380 10 380GTZ	
				3151 000 515	KZIS-4	































230...						
230 D 16 F 232 D 20 AL (Version 2551578) 232 D 26 B 232 D 30 AK, FAK 232 D 30 FK 232 D 32 A 232 D 32 K				1882 325 134	380 G380	
				1878 000 104	380 10 380GTZ	
				3151 000 395	KZIS-4	
230 D 16 FAK				1882 325 134	380 G380	
				1878 000 104	380 10 380GTZ	

		CODE				
--	--	------	--	---	---	---

MAGIRUS-DEUTZ



























230...						
230 D 18 AK		FL914		1882 325 134	380	
230 D 19 FL					G380	
230 D 22 K				1878 000 104	380 10	
230 D 26 AK					380GTZ	
230 D 22 FT 6x6		F8L914		1882 325 134	380	
					G380	
				1878 000 104	380 10	
					380GTZ	
				3151 000 395	KZIS-4	
232 D 15 FK, FAK, FS, FL		F8L413		1882 325 134	380	
232 D 16 F, AK, FS, FL					G380	
232 D 17 F, FA				1878 000 104	380 10	
232 D 19 AK, K, FAK, FK, FL, FS, L, S					380GTZ	
232 D 19 K, L				3151 000 395	KZIS-4	
232 D 22 AK, FAK, FK 6x6, FB 6x4						
232 D 24 L, K, FK						
232 D 26 AK, F, FAK, FB, FK, K, L, S						
232 D 26 K 6x4						
232 D 16 AL				1882 325 139	380	
232 D 20 AL					G380	
				1878 000 957	380 10	
					380GTZ	
				3151 000 515	KZIS-4	
232 D 17				3482 124 541	430	
					GMF430	
				1882 330 032 ●#	420	
					GF420	
				1878 634 017 ▲	420 10	
					420GSZ	
				3151 000 515	KZIS-4	
232 D 17 FA (Version 42230187)				3482 002 234	350	
					GMF350X	
				1878 001 070	350 10	
					350GTZ	
				3151 000 515	KZIS-4	
235 D 22 FL, FS 6x4				1882 325 139	380	
					G380	
				1878 000 104	380 10	
					380GTZ	
				3151 000 395	KZIS-4	
250...						
250 D 22				1882 325 139	380	
250 D 22 FK 6x4 (10 Zyl.)					G380	
				1878 000 104	380 10	
					380GTZ	
				3151 000 395	KZIS-4	
250 D 22 FK 6x4				1882 325 134	380	
					G380	
				1878 000 104	380 10	
					380GTZ	
				3151 000 395	KZIS-4	
256 D 14 F		F8L413		1882 325 139	380	
256 D 16 AK (Version 2551676)					G380	
256 D 16 FS, FL, FLL, K				1878 000 957	380 10	
256 D 19 AK, FL,FS, K, S					380GTZ	
256 D 22 FLL				3151 000 515	KZIS-4	
256 D 26 AK, K, 6x4						
256 D 26 FB 6x4						

MAGIRUS-DEUTZ

250...						
256 D 16 FB 6x4 (Version 42231436)				1882 325 134	380 G380	
				1878 000 957	380 10 380GTZ	
				3151 000 395	KZIS-4	
256 D 16 SS				1882 306 136 #	420 G420N	Getr. / GBox: S 6-90-GV 90 für Nebenantrieb / for PTO (82)
256 M 19 256 M 22		F8L413F		3482 124 532	430 GMF430	Getr. / GBox: ZF S 6-90 Getr. / GBox: Fiat E 100
				1878 001 138	420 10 420GTZ	Getr. / GBox: ZF S 6-90 Getr. / GBox: Fiat E 100
				3151 071 032	KZI-4,5	Getr. / GBox: Fiat E 100
				3151 098 031	KZI-4,5	Getr. / GBox: ZF S 6-90
256 M 19 A, AT		F8L413F		3482 124 532	430 GMF430	Getr. / GBox: Fuller
				1878 001 138	420 10 420GTZ	Getr. / GBox: Fuller
				3151 127 031	KZI-4,5	Getr. / GBox: Fuller
256 M 19 AK	12.84-	F8L413F		3482 124 531	430 GMF430	
				1882 316 035 ●#	420 GF420	
				1878 002 955	420 10 420GTZ	
				3151 000 515	KZIS-4	
256 M 19 AK, AS, K, L, S 256 M 19 FAK, FK, FKL, FKS	- 11.84 - 11.84	F8L413F		3482 124 531	430 GMF430	Getr. / GBox: ZF
				1882 316 035 ●#	420 GF420	Getr. / GBox: ZF
				1878 001 138	420 10 420GTZ	Getr. / GBox: ZF
				3151 000 515	KZIS-4	Getr. / GBox: ZF
256 M 19 F, FL, FS, FSL 256 M 22 F, FL, FS, FSL		F8L413		3482 124 531	430 GMF430	Getr. / GBox: ZF
			1882 316 035 ●#	420 GF420	Getr. / GBox: ZF	
			1878 001 138	420 10 420GTZ	Getr. / GBox: ZF	
			3151 098 031	KZI-4,5	Getr. / GBox: ZF	
256 M 19 FL, FS, FSL 256 M 22 FL, FS, FSL		F8L413F		3482 124 531	430 GMF430	Getr. / GBox: Fuller
			1882 316 035 ●#	420 GF420	Getr. / GBox: Fuller	
			1878 001 138	420 10 420GTZ	Getr. / GBox: Fuller Getr. / GBox: Fiat E 90	
			3151 071 032	KZI-4,5	Getr. / GBox: Fiat E 90	
			3151 127 031	KZI-4,5	Getr. / GBox: Fuller	
256 M 19 FLL				3482 124 532	430 GMF430	
				1878 001 138	420 10 420GTZ	
				3151 127 031	KZI-4,5	
256 M 19 K				1882 306 136 #	420 G420N	Nebenantriebs-ID / PTO ID: 110E (50)
256 M 26 AK 6x6, K, S 6x4 256 M 26 AK Prod.-Nr. 77311 256 M 26 FAK, FK, FKL, FKS 256 M 26 K, L, S Prod.-Nr. 77211		F8L413F		3482 124 531	430 GMF430	Getr. / GBox: ZF
			1882 316 035 ●#	420 GF420	Getr. / GBox: ZF	
			1878 002 955	420 10 420GTZ	Getr. / GBox: ZF	
			3151 000 515	KZIS-4	Getr. / GBox: ZF	







		CODE				
--	--	------	--	---	---	---

















MAGIRUS-DEUTZ

250...						
256 M 26 FB, L 6x4		F8L413F		1882 325 139	380 G380	Getr. / GBox: ZF
				1878 000 957	380 10 380GTZ	Getr. / GBox: ZF
				3151 000 515	KZIS-4	Getr. / GBox: ZF
256 M 26 K (Version 42230027)				3482 002 234	350 GMF350X	
				1878 001 070	350 10 350GTZ	
				3151 000 515	KZIS-4	
256 M 33 K, FK				3482 124 531	430 GMF430	
				1882 316 035 ●#	420 GF420	
				1878 002 955	420 10 420GTZ	
				3151 000 515	KZIS-4	
260...						
260 D FAL 6x6		F10L413		3482 124 541	430 GMF430	
				1882 330 032 ●#	420 GF420	
				1878 634 017 ▲	420 10 420GSZ	
				3151 000 515	KZIS-4	
270...						
270 D 16 FAK, FK 270 D 19 270 D 22 FL, FLL, FS 270 D 26 AK, FAK				3482 124 534	430 GMF430	
				1882 301 239 ●	420 GF420	
				1878 634 017 ▲	420 10 420GSZ	
				3151 000 515	KZIS-4	
280...						
280 M 26 FS				3482 124 534	430 GMF430	
				1882 301 239 ●	420 GF420	
				1878 002 706	420 10 420GTZ	
				3151 000 515	KZIS-4	
290...						
290 D 19 K 290 D 19 L 290 D 22 290 D 26 K 290 D 26 L				3482 124 541	430 GMF430	
				1882 330 032 ●#	420 GF420	
				1878 634 017 ▲	420 10 420GSZ	
				3151 000 515	KZIS-4	
290 D 19 Turbo		F8L413		3482 124 533 #	420 GMF430	Getr. / GBox: Fuller
				1878 002 955	420 10 420GTZ	Getr. / GBox: Fuller
				3151 127 031	KZI-4,5	Getr. / GBox: Fuller
290 D 22 FK 6x4 (10 Zyl./cyl.)				1882 325 139	380 G380	
				1878 000 104	380 10 380GTZ	
				3151 000 395	KZIS-4	

		CODE				
--	--	------	--	---	---	---































MAGIRUS-DEUTZ

290...						
290 D 26 FAL 6x6		F10L413		3482 124 541	430 GMF430	
				1882 330 032 ●#	420 GF420	
				1878 634 017 ▲	420 10 420GSZ	
				3151 000 515	KZIS-4	
290 M 19 FL, FS 290 M 22 AP, FL, FLL		BF8L413F		3482 124 533 #	420 GMF430	
				1878 002 955	420 10 420GTZ	
				3151 127 031	KZI-4,5	

































310...							
310 D 15 AK, FAK, FK, FL, FS, K 310 D 16 AK, FAK, FK, FLL, FS, K, S 310 D 16 FL 310 D 16 FSL (Version 42230102) 310 D 19 AK, FAK, FK, FL, FS, S 310 D 21 F 310 D 22 AK, FAK, FAL, FK, FL, FS 310 D 22 FA (Version 42230120) 310 D 26 AK, FAK, FK, FS, S 310 D 28 FK, FL 310 D 32 K	- 10.76			3482 124 534	430 GMF430		
				1882 301 239 ●	420 GF420		
				1878 634 017 ▲	420 10 420GSZ		
				3151 000 515	KZIS-4		
310 D 16 FL	11.76 -			3482 124 522	430 GMF430		
				1878 634 017 ▲	420 10 420GSZ		
				3151 000 515	KZIS-4		
310 D 16 FSL (Version 2550517)				1881 039 532 #	350 G350KR		
				1878 005 367	350 10 350WGTZ		
				1863 600 125	GR-3	mit Anlauftring / with thrust ring	(88)
310 D 22 FA (Version 42230008) 310 D 26 FAK (Version 42241400) 310 D 26 FK 6x4				1878 003 274	420 10 420GTZ	für Nebenantrieb / for PTO	(82)
310 D 26 AK (Version 2551686) 310 D 26 K (Version 42231407)				3482 124 534	430 GMF430		
				1882 330 032 ●#	420 GF420		
				1878 634 017 ▲	420 10 420GSZ		
				3151 000 515	KZIS-4		
310 D 26 K (Version 2551652)				3482 124 541	430 GMF430		
				1882 301 239 ●	420 GF420		
				1878 634 017 ▲	420 10 420GSZ		
				3151 000 515	KZIS-4		

		CODE				
--	--	------	--	---	---	---















MAGIRUS-DEUTZ

310...						
310 D 232				1882 325 134	380 G380	
				1878 000 104	380 10 380GTZ	
				3151 000 395	KZIS-4	
310 D 32 AK 310 D 32 K 310 D 32 L	-01.78 07.76-01.78 -01.78			1882 320 131	420 GF420	Nur bei Altteil-Rückgabe lieferbar (Reparatur; Werk Bielefeld) / Please return old unit for repair (plant Bielefeld) (51)
				1878 001 138	420 10 420GTZ	
				3151 000 515	KZIS-4	
310 D 32 AK 6x6 HD	02.78-	F10L413L		3482 124 532	430 GMF430	
				1878 002 955	420 10 420GTZ	
				3151 000 515	KZIS-4	
310 D 32 K 310 D 32 L	02.78- 02.78-			3482 124 532	430 GMF430	
				1878 001 138	420 10 420GTZ	
				3151 000 515	KZIS-4	
320...						
320 D 19 FAK 320 M 33 AK, K, L				3482 124 532	430 GMF430	
				1878 002 955	420 10 420GTZ	
				3151 000 515	KZIS-4	
320 D 20 AL, AS, FAT, FS				3482 124 534	430 GMF430	
				1882 301 239 ●	420 GF420	
				1878 634 017 ▲	420 10 420GSZ	
				3151 000 515	KZIS-4	
320 D 21 HL 320 D 26 AK				3482 124 541	430 GMF430	
				1882 330 032 ●#	420 GF420	
				1878 634 017 ▲	420 10 420GSZ	
				3151 000 515	KZIS-4	
320 D 26 AL	11.83-			3482 124 533 #	420 GMF430	
				1878 003 657	420 10 420WGTZ	
				3151 000 515	KZIS-4	
320 D 26 AL	-10.83			3482 124 532	430 GMF430	
				1878 003 657	420 10 420WGTZ	
				3151 000 515	KZIS-4	
320 D 26 F, FA, FT		F10L413F		3482 124 541	430 GMF430	
				1882 301 239 ●	420 GF420	
				1878 634 017 ▲	420 10 420GSZ	
				3151 000 515	KZIS-4	



MAGIRUS-DEUTZ

320...						
320 D 34 AS			 3482 124 532	430 GMF430		
			 1878 001 138	420 10 420GTZ		
			 3151 000 515	KZIS-4		
320 M 19 320 M 22		F10L413F	 3482 124 533 #	420 GMF430	Getr. / GBox: ZF Getr. / GBox: Fuller	
			 1878 002 955	420 10 420GTZ	Getr. / GBox: ZF Getr. / GBox: Fuller	
			 3151 000 515	KZIS-4	Getr. / GBox: ZF	
			 3151 127 031	KZI-4,5	Getr. / GBox: Fuller	
320 M 19 A, AT		BF8L413F	 3482 124 532	430 GMF430	Getr. / GBox: Fuller	
			 1878 002 955	420 10 420GTZ	Getr. / GBox: Fuller	
			 3151 000 515	KZIS-4	Getr. / GBox: Fuller	
320 M 19 FAK, FK, FKL, FKS		BF8L413F	 3482 124 533 #	420 GMF430		
			 1878 002 955	420 10 420GTZ		
			 3151 000 515	KZIS-4		
		F10L413F	 3482 124 532	430 GMF430	Getr. / GBox: ZF	
			 1878 002 955	420 10 420GTZ	Getr. / GBox: ZF	
			 3151 000 515	KZIS-4	Getr. / GBox: ZF	
320 M 19 FL, FS, FSL 320 M 22 FL, FS, FSL		F10L413F	 3482 124 532	430 GMF430	Getr. / GBox: Fuller	
			 1878 002 955	420 10 420GTZ	Getr. / GBox: Fuller	
			 3151 127 031	KZI-4,5	Getr. / GBox: Fuller	
320 M 26 FAK		F10L413F	 1878 003 274	420 10 420GTZ	Nebenantriebs-ID / PTO ID: 110E	(50)
320 M 26 FAK 6x6 320 M 26 FK, FKL, FKS (6x4),		F10L413F	 3482 124 532	430 GMF430	Getr. / GBox: ZF	
			 1878 002 955	420 10 420GTZ	Getr. / GBox: ZF	
			 3151 000 515	KZIS-4	Getr. / GBox: ZF	
320 M 26 FK, FKL		BF8L413F	 3482 124 533 #	420 GMF430	Getr. / GBox: Fuller	
			 1878 002 955	420 10 420GTZ	Getr. / GBox: Fuller	
			 3151 000 515	KZIS-4	Getr. / GBox: Fuller	
340...						
340 D 16 FS, FL 6x4 340 D 22 FS, FL 6x4	05.72-		 3482 124 522	430 GMF430		
			 1878 634 017 ▲	420 10 420GSZ		
			 3151 000 515	KZIS-4		
350...						
350 F 33, PC, PT		8280	 3400 042 031 ☉	420 10 MF420 420GTZ	Getr. / GBox: Fiat enthält Druckplattenbefestigungsschrauben / includes bolt for pressure plate mounting	(65)
			 3482 125 131			
			 1878 002 955			
			 1874 015 200	KZIS-4	Getr. / GBox: Fiat	





MAGIRUS-DEUTZ

360...							
360 D 18 FL, FS				3482 124 533 #	420 GMF430		
				1878 001 138	420 10 420GTZ		
				3151 000 515	KZIS-4		
360 M 19 A, AT 360 M 22 AP, APT		BF10L413F		3483 020 034 ⊕	430 MFZ430		
				1861 992 432	430 10 430GVZ		
				3482 083 040	430 MFZ430	In 3483/3488 enthalten / Contained in 3483, 3488	(32)
				3100 002 040 ◊ 3151 000 148 ◎ 3180 001 008	KZIZ5	Beinhaltet Ausrücker und Montagesatz / Contains releaser and fitting kit In 3483/3488 enthalten / Contained in 3483, 3488	(9) (32)
360 M 19 APT		BF10L413F		3482 124 533 #	420 GMF430		
				1878 002 955	420 10 420GTZ		
				3151 127 031	KZI-4,5		
360 M 33 F, FKS				3483 020 035 ⊕	430 MFZ430		
				1878 022 841	430 10 430GTZ		
				3482 083 040	430 MFZ430	In 3483/3488 enthalten / Contained in 3483, 3488	(32)
				3100 002 038 ◊ 3151 123 031 ◎ 3180 001 008	KZIZ5 KZIZ-5	Beinhaltet Ausrücker und Montagesatz / Contains releaser and fitting kit In 3483/3488 enthalten / Contained in 3483, 3488	(9) (32)

MAN

CLA 01.06 -						
15.220 FRC MA5 MA6	01.06-	D0836LFL10, D0836LFL08		3400 121 701 ◊ 3482 000 467 ◊ 1862 506 131 ◊ 3151 253 031	395 10 MFZ395 395WGTZ KZIZ-4,5	
16.220 FC MA6 MA5	01.06-			3189 600 053		Getr. / GBox: ZF 9S-1110 TO / HH
16.220 FK MA5 MA6	01.06-					
18.280 FC, FRC MA5 MA6	01.06-					
18.280 FRS, FS MA5 MA6	01.06-					
20.280 FC, FRC MA5 MA6	01.06-					
25.280 FDK, FDRK MC5	01.06-					
25.280 FDRK, FDC MC5 MC6	01.06-					
25.280 FDS, FDRS MC5 MC6	01.06-					
26.280 FDC, FDRK MC6 MC5	01.06-					
26.280 FDK, FDRK MC6 MC5	01.06-					
26.280 FDS, FDRS MC5 MC6	01.06-					
26.280 FD-TM, FDR-TM MC6 MC5	01.06-					
26.280 FRC MB6	01.06-					
31.280 FFDRK ME0	01.06-					

MAN



E 2000		05.00 -						
19.310 FALK, FALK-L E62	05.00-	D2876LF03, D2866LF24, D2840LF21, D2866LF23, D2866LF25, E2866DF01		3488 017 447	400 MFZ2/400X	Getr. / GBox: ZF Ecosplit-3 für Fahrzeuge mit Zweischeibenkupplung / for vehicles with double disc clutch	(77)	
19.310 FALS E62	05.00-			1878 002 643	400 10 400WGTZ	Getr. / GBox: ZF Ecosplit-3 für Fahrzeuge mit Zweischeibenkupplung / for vehicles with double disc clutch	(67)	
19.310 FLK E61	05.00-			3151 262 031	KZISZ-5	Getr. / GBox: ZF Ecosplit-3 für Fahrzeuge mit Zweischeibenkupplung / for vehicles with double disc clutch	(77)	
19.310 FLS E61	05.00-			3189 600 009		Getr. / GBox: ZF Ecosplit-3 für Fahrzeuge mit Zweischeibenkupplung / for vehicles with double disc clutch	(77)	
19.360 FALK, FALK-L E62	05.00-							
19.360 FALS E62	05.00-							
19.360 FLK E61	05.00-							
19.360 FLS E61	05.00-							
19.410 FALK, FALK-L E62	05.00-							
19.410 FALS E62	05.00-							
19.410 FLK E61	05.00-							
19.410 FLS E61	05.00-							
19.460 FALK, FALK-L E62	05.00-							
19.460 FALS E62	05.00-							
19.460 FLK E61	05.00-							
19.460 FLS E61	05.00-							
26.310 FAVLC E66	05.00-							
26.310 FAVLK E66	05.00-							
26.360 FAVLC E66	05.00-							
26.360 FAVLK E66	05.00-							
26.410 DFARC E40	05.00-							
26.410 DFRC, FAVLC E40 E66	05.00-							
26.410 FAVLK E66	05.00-							
26.460 DFARC E40	05.00-							
26.460 DFLS, DFLRS E40	05.00-							
26.460 FAVLC E66	05.00-							
26.460 FAVLK E66	05.00-							
28.230 FNLC E63	05.00-							
28.310 FNLC E63	05.00-							
28.360 FANLC E67	05.00-							
28.360 FANLK E67	05.00-							
28.360 FNALC E67	05.00-							
28.360 FNALK E67	05.00-							
28.360 FNLC E63	05.00-							
28.410 FANLC E67	05.00-							
28.410 FANLK E67	05.00-							

		CODE					
--	--	------	--	--	---	---	---

MAN









E 2000		05.00 -					
28.410 FNALC E67	05.00-	D2876LF03, D2866LF24, D2840LF21, D2866LF23, D2866LF25, E2866DF01		3488 017 447	400 MFZ2/400X	Getr. / GBox: ZF Ecosplit-3 für Fahrzeuge mit Zweischeibenkupplung / for vehicles with double disc clutch	(77)
28.410 FNALK E67	05.00-			1878 002 643	400 10 400WGTZ	Getr. / GBox: ZF Ecosplit-3 für Fahrzeuge mit Zweischeibenkupplung / for vehicles with double disc clutch	(67)
28.410 FNLC E63	05.00-			3151 262 031	KZISZ-5	Getr. / GBox: ZF Ecosplit-3 für Fahrzeuge mit Zweischeibenkupplung / for vehicles with double disc clutch	(77)
28.460 FANLC E67	05.00-			3189 600 009		Getr. / GBox: ZF Ecosplit-3 für Fahrzeuge mit Zweischeibenkupplung / for vehicles with double disc clutch	(77)
28.460 FANLK E67	05.00-						
28.460 FNALC E67	05.00-						
28.460 FNALK E67	05.00-						
28.460 FVAS E71	05.00-						
28.460 FNLC E63	05.00-						
29.460 FVAS E71	05.00-						
30.310 FNLC E69	05.00-						
30.360 FANLC E60	05.00-						
30.360 FANLK E60	05.00-						
30.360 FNLC E69	05.00-						
30.410 FANLC E60	05.00-						
30.410 FANLK E60	05.00-						
30.410 FNLC E69	05.00-						
30.460 FANLC E60	05.00-						
30.460 FANLK E60	05.00-						
30.460 FNLC E69	05.00-						
32.310 VFCLC E65	05.00-						
32.310 VFNLC E65	05.00-						
32.360 VFCLC E65	05.00-						
32.360 VFNLC E65	05.00-						
32.410 VFARK E41	05.00-						
32.410 VFCLC, VFRC, VFLRC E41 E65	05.00-						
32.410 VFNLC E65	05.00-						
32.460 VFARK E41	05.00-						
32.460 VFCLC, VFLRC E41 E65	05.00-						
32.460 VFNLC E65	05.00-						
33.360 DFAK, DFALK E72 E60	05.00-						
33.360 DFALC E60	05.00-						
33.360 DFALS E60	04.01-						
33.360 DFCLC E69	05.00-						
33.360 DFLK E69	05.00-						
33.360 DFSL E69	05.00-						

MAN

E 2000		05.00 -					
33.410 DFAK, DFALK E72 E60	05.00-	D2876LF03, D2866LF24, D2840LF21, D2866LF23, D2866LF25, E2866DF01		3488 017 447	400 MFZ2/400X	Getr. / GBox: ZF Ecosplit-3 für Fahrzeuge mit Zweischeibenkupplung / for vehicles with double disc clutch	(77)
33.410 DFALC E60	05.00-			1878 002 643	400 10 400WGTZ	Getr. / GBox: ZF Ecosplit-3 für Fahrzeuge mit Zweischeibenkupplung / for vehicles with double disc clutch	(77)
33.410 DFALS E60	04.01-			3151 262 031	KZISZ-5	Getr. / GBox: ZF Ecosplit-3 für Fahrzeuge mit Zweischeibenkupplung / for vehicles with double disc clutch	(77)
33.410 DFALC E69	05.00-						
33.410 DFLK E69	05.00-			3189 600 009		Getr. / GBox: ZF Ecosplit-3 für Fahrzeuge mit Zweischeibenkupplung / for vehicles with double disc clutch	(77)
33.410 DFLLS E69	05.00-						
33.460 DFAK, DFALK E72 E60	05.00-						
33.460 DFALC E60	05.00-						
33.460 DFALS E60	04.01-						
33.460 DFLLC E69	05.00-						
33.460 DFLK E69	05.00-						
33.460 DFLLS E69	05.00-						
33.600 DFALS, DFAS E94	06.00-						
33.600 DFLLS E99	06.00-						
35.360 VFAK E68	05.00-						
35.410 FVNLC E73	05.00-						
35.410 VFAK E68	05.00-						
35.460 FVNLC E73	05.00-						
35.460 VFAK E68	05.00-						
40.600 DFAS E94	06.00-						
41.360 VFAK E68	05.00-						
41.410 VFAK E68	05.00-						
41.460 DFVS, DFVLS E75	06.00-						
41.460 VFAK E68	05.00-						
41.600 DFVS, DFVLS E95	06.00-						
50.410 VFAK E68	05.00-						
50.410 VFAVK, VFAVK-HK, VFAV-G E79	03.01-						
50.410 VFK E68	05.00-						
50.410 VFBK, VFBK-G, VFBK- HK E77	10.00-						
50.460 VFAK E68	05.00-						
50.460 VFAVK, VFAV-G, VFAVK-HK E79	03.01-						
50.460 VFK E68	05.00-						
50.460 VFBK, VFBK-HK, VFBK- G E77	10.00-						
50.600 VFAS E98	05.00-						













		CODE				
--	--	------	--	---	---	---

MAN

F 2000		01.94 -					
11.153 T72	04.96-	D0824L, LFL	 3400 121 701 ⊗ 3482 000 467 ⊗ 1862 506 131 ⊙ 3151 253 031	395 10 MFZ395 395WGTZ KZIZ-4,5	Je nach Kundenwunsch mit unterschiedlicher Kupplung / Equipped with different clutch according to customer requirement	(35)	
11.163 T72	04.96-		 3400 121 801 Ⓞ ⊗ 3482 120 031 ⊗ 1878 044 631	362 10 MFZ362 362GTZ	Je nach Kundenwunsch mit unterschiedlicher Kupplung / Equipped with different clutch according to customer requirement	(35)	
12.153 T72,74,76	04.96-			3182 005 231	HHISZ-3	Füllmedium: Bremsflüssigkeit / Fill Medium: Brake Fluid	(25)
13.153 T74,76	04.96-					Immer erneuern / Renew everytime	(30)
13.163 T74,76	04.96-			3400 710 001 ⊗ 3482 120 031 ⊗ 1878 044 631 Ⓞ 3182 005 231	362 10 MFZ362 362GTZ HHISZ-3		
14.153 T74,76,81,83	04.96-						
15.153 T81,83	04.96-						
15.163 T81,83	04.96-						
18.273 T01,02,03	01.94-	D2865LF	 3400 122 301 ⊗ 3482 083 032 ⊗ 1878 080 034 ⊙ 3151 000 034	430 10 MFZ430 430WGTZ KZISZ-5			
18.293 T01,02,03	01.94-			3482 114 031	430 GMFZ430N	für Nebenantrieb / for PTO	(82)
18.323 T01,02,03	01.94-			1878 080 034	430 10 430WGTZ	für Nebenantrieb / for PTO	(82)
18.343 T01,02,03	01.94-			3151 263 031	KZIZ-6	für Nebenantrieb / for PTO	(82)
32.323 T15	01.95-			3189 600 020		Getr. / GBox: ZF Ecosplit-3	
35.293 T15	01.95-						
35.323 T15,16	01.95-						
37.323 T16	01.95-						
37.343 T16	01.95-						
41.323 T16	01.95-						

		CODE				
--	--	------	--	---	---	---

MAN

F 2000		01.94 -					
18.273 F, FL, FLL T01 T02 T03	06.94 -	D2865LF24, D2865LF20, D2865LF22, D2865LF21, D2865LF23		3400 122 301 ● 3482 083 032 ● 1878 080 034 ● 3151 000 034	430 10 MFZ430 430WGTZ KZISZ-5		
19.273 F, FL, FLL T01 T03 T02	01.94 -			3496 006 000		langer Bügel / long handle	(86)
19.273 FA T04	01.94 -			3482 114 031	430 GMFZ430N	für Nebenantrieb / for PTO	(82)
19.273 FAK T04	01.94 -			1878 080 034	430 10 430WGTZ	für Nebenantrieb / for PTO	(82)
19.273 FK T01	01.94 -			3151 263 031	KZIZ-6	für Nebenantrieb / for PTO	(82)
19.273 FS,19.273 FLS T01 T02	01.94 - 12.95			3189 600 020		Getr. / GBox: ZF Ecosplit-3	
19.293 FAC T04	01.94 -						
19.293 FAK T04	01.94 -						
19.293 FAS T04	01.94 -						
19.293 FC,19.293 FLC,19.293 FLLC	01.94 -						
19.293 FK,19.293 FLK T01 T02	01.94 -						
19.293 FS,19.293 FLS,19.293 FLLS	01.94 -						
19.323 FC,19.323 FLC,19.323 FLLC	01.94 - 12.95						
19.323 FS,19.323 FLS,19.323 FLLS	01.94 - 12.95						
19.343 FAC T04	01.94 -						
19.343 FAK T04	01.94 -						
19.343 FAS T04	01.94 -						
19.343 FC,19.343 FLC,19.343 FLLC	01.94 -						
19.343 FK,19.343 FLK T01 T02	01.94 -						
19.343 FS,19.343 FLS,19.343 FLLS	01.94 -						
18.373 T33	01.94 -			3488 017 447	400 MFZ2/400X	Getr. / GBox: ZF Ecosplit-3 für Fahrzeuge mit Zweischeibenkupplung / for vehicles with double disc clutch	(77)
18.403 T33	01.94 -			1878 002 643	400 10 400WGTZ	Getr. / GBox: ZF Ecosplit-3 für Fahrzeuge mit Zweischeibenkupplung / for vehicles with double disc clutch	(67)
18.463 T33	01.94 -			3151 262 031	KZISZ-5	Getr. / GBox: ZF Ecosplit-3 für Fahrzeuge mit Zweischeibenkupplung / for vehicles with double disc clutch	(77)
				3189 600 020		Getr. / GBox: ZF Ecosplit-3	
				3189 600 009		Getr. / GBox: ZF Ecosplit-3 für Fahrzeuge mit Zweischeibenkupplung / for vehicles with double disc clutch	(77)
		D2866LF21		3400 122 201 ● 3482 083 032 ● 1878 004 832 ● 3151 000 034	430 10 MFZ430 430WGTZ KZISZ-5		







MAN

F 2000		01.94 -				
18.373 T31,32 18.403 T31,32 18.423 T31,32 18.463 T31,32 19.404 T31,32 19.463 T31,32 19.464 T31,32		D2866	3400 122 201 3482 083 032 1878 004 832 3151 000 034	430 10 MFZ430 430WGTZ KZISZ-5		
		D2840	3488 017 447	400 MFZ2/400X	enthält eine Kupplungsscheibe / This part number includes one clutch disc	(67)
			1878 002 643 ▽	400 10 400WGTZ	Lose Kupplungsscheibe / Loose clutch disc	(41)
			3151 262 031	KZISZ-5		
			1878 002 023 △	400 8 400GTZ	In 3483/3488 enthalten / Contained in 3483, 3488	(32)
			3189 600 020 3189 600 036		Getr. / GBox: ZF Ecosplit-3	
					für Fahrzeuge mit Zweischeibenkupplung / for vehicles with double disc clutch	(77)





		CODE				
--	--	------	--	---	---	---

MAN

F 2000		01.94 -						
18.373 4x2 F/FR T31	08.94-	D2876LF03, D2866LF24, D2876LF06, D2866LF20, D2866LF23, D2866LF25, E2866DF01, D2865LF22		3488 017 447	400 MFZ2/400X	Getr. / GBox: ZF Ecosplit-3 für Fahrzeuge mit Zweischeibenkupplung / for vehicles with double disc clutch	(77)	
18.373 4x2 FL/FLR T32	04.94-					enthält eine Kupplungsscheibe / This part number includes one clutch disc	(67)	
18.403 4x2 F/FR T31	08.94-				1878 002 643	400 10 400WGTZ	Getr. / GBox: ZF Ecosplit-3 für Fahrzeuge mit Zweischeibenkupplung / for vehicles with double disc clutch	(77)
18.403 4x2 FL/FLR T32	04.94-							
19.233 4x2 F/FR T31	08.94-			3151 262 031	KZISZ-5	Getr. / GBox: ZF Ecosplit-3 für Fahrzeuge mit Zweischeibenkupplung / for vehicles with double disc clutch	(77)	
19.233 FK, FK-L, CNG T31	03.00-			3189 600 009		Getr. / GBox: ZF Ecosplit-3 für Fahrzeuge mit Zweischeibenkupplung / for vehicles with double disc clutch	(77)	
23.314 FNLLC T35	05.01-							
23.364 FNLLC T35	05.01-							
23.414 FNLLC T35	05.01-							
23.464 FNLLC T35	05.01-							
24.314 FNLLRC T37	05.01-							
24.364 FNLLRC T37	05.01-							
24.414 FNLLRC T37	05.01-							
24.464 FNLLRC T37	05.01-							
26.233 FVL-KO T38	03.00-							
26.314 DFC, DFCL T39 T40	05.01-							
26.314 DFK, DFLK, DFLK-L T40 T39	05.01-							
26.314 DFS, DFSL T39 T40	05.01-							
26.314 DF-TM T39	05.01-							
26.314 FNLC, FNLLC, FNLLRC, FNLLW, FNLCR, FNLLRC, FVLC T38 T36 T37	05.01-							
26.314 FNLC, FNLLC, FNLLRC, FNLLW, FNLCR, FNLLRC, FVLC T37 T36 T38	05.01-							
26.314 FNLS T36	05.01-							
26.314 FVL-KO T38	05.01-							
26.314 FVLS, FVLSR T38	05.01-							
26.364 DFC, DFCL T39 T40	05.01-							
26.364 DFK, DFLK, DFLK-L T40 T39	05.01-							
26.364 DFS, DFSL T40 T39	05.01-							
26.364 DF-TM T39	05.01-							
26.364 FNLC, FNLLC, FNLLRC, FNLLW, FNLCR, FNLLRC, FVLC T37 T38 T36	05.01-							
26.364 FNLC, FNLLC, FNLLRC, FNLLW, FNLCR, FNLLRC, FVLC T38 T36 T37	05.01-							
26.364 FNLS T36	05.01-							
26.364 FVL-KO T38	05.01-							





		CODE				
--	--	------	--	---	---	---

MAN





F 2000		01.94 -					
26.364 FVLS, FVLRS T38	05.01-	D2876LF03, D2866LF24, D2876LF06, D2866LF20, D2866LF23, D2866LF25, D2876LF02, E2866DF01, D2865LF22		3488 017 447	400 MFZ2/400X	Getr. / GBox: ZF Ecosplit-3 für Fahrzeuge mit Zweischeibenkupplung / for vehicles with double disc clutch	(77)
26.414 DFC, DFCL T39 T40	05.01-					enthält eine Kupplungsscheibe / This part number includes one clutch disc	(67)
26.414 DFK, DFLK, DFLK-L T39 T40	05.01-			1878 002 643	400 10 400WGTZ	Getr. / GBox: ZF Ecosplit-3 für Fahrzeuge mit Zweischeibenkupplung / for vehicles with double disc clutch	(77)
26.414 DFS, DFSL T40 T39	05.01-			3151 262 031	KZISZ-5	Getr. / GBox: ZF Ecosplit-3 für Fahrzeuge mit Zweischeibenkupplung / for vehicles with double disc clutch	(77)
26.414 DF-TM T39	05.01-			3189 600 009		Getr. / GBox: ZF Ecosplit-3 für Fahrzeuge mit Zweischeibenkupplung / for vehicles with double disc clutch	(77)
26.414 FNLC, FNLLC, FNLLRC, FNLLW, FNLR, FNLLRC, FVLC T36 T38 T37	05.01-						
26.414 FNLC, FNLLC, FNLLRC, FNLLW, FNLR, FNLLRC, FVLC T38 T36 T37	05.01-						
26.414 FNLS T36	05.01-						
26.414 FVL-KO T38	05.01-						
26.414 FVLS, FVLRS T38	05.01-						
26.464 DFC, DFCL T39 T40	05.01-						
26.464 DFK, DFLK, DFLK-L T39 T40	05.01-						
26.464 DFS, DFSL T39 T40	05.01-						
26.464 DF-TM T39	05.01-						
26.464 FNLC, FNLLC, FNLLRC, FNLLW, FNLR, FNLLRC, FVLC T37 T38 T36	05.01-						
26.464 FNLS T36	05.01-						
26.464 FVL-KO T38	05.01-						
26.464 FVLS, FVLRS T38	05.01-						
26.604 DFSL T70	04.00-						
27.314 DFAC T42	05.01-						
27.314 DFAK, DFA-KI, DFAK-L T42	05.01-						
27.314 DFAS T42	05.01-						
27.314 DFC T48	05.01-						
27.314 DFK, DFLK, DFLK-L, DF-KI T48	05.01-						
27.314 DFS T48	05.01-						
27.314 DF-TM T48	05.01-						
27.314 FVL T38	06.98-						
27.364 DFAC T42	05.01-						
27.364 DFAK, DFA-KI, DFAK-L T42	05.01-						
27.364 DFAS T42	05.01-						
27.364 DFC T48	05.01-						
27.364 DFK, DFK-KI, DFK-L, DF-KI T48	05.01-						













		CODE				
--	--	------	--	---	---	---

MAN

F 2000		01.94 -					
27.364 DFS T48	05.01-	D2876LF03, D2866LF24, D2876LF06, D2866LF20, D2866LF23, D2866LF25, D2876LF02, E2866DF01, D2865LF22		3488 017 447	400 MFZ2/400X	Getr. / GBox: ZF Ecosplit-3 für Fahrzeuge mit Zweischeibenkupplung / for vehicles with double disc clutch	(77)
27.364 DF-TM T48	05.01-			1878 002 643	400 10 400WGTZ	Getr. / GBox: ZF Ecosplit-3 für Fahrzeuge mit Zweischeibenkupplung / for vehicles with double disc clutch enthält eine Kupplungsscheibe / This part number includes one clutch disc	(67)
27.364 FVL T38	06.98-			3151 262 031	KZISZ-5	Getr. / GBox: ZF Ecosplit-3 für Fahrzeuge mit Zweischeibenkupplung / for vehicles with double disc clutch	(77)
27.373 DF, 27.373 DFL T39 T40	01.94-			3189 600 009		Getr. / GBox: ZF Ecosplit-3 für Fahrzeuge mit Zweischeibenkupplung / for vehicles with double disc clutch	(77)
27.373 DF-TM T48	07.00-						
27.403 DF, 27.403 DFL T40 T39	01.94-						
27.403 DF-TM T48	07.00-						
27.414 DFAC T42	05.01-						
27.414 DFAK, DFA-KI, DFAK-L T42	05.01-						
27.414 DFAS T42	05.01-						
27.414 DFC T48	05.01-						
27.414 DFK, DFK-KI, DFK-L, DF-KI T48	05.01-						
27.414 DFS T48	05.01-						
27.414 DF-TM T48	05.01-						
27.414 FVL T38	06.98-						
27.423 DF, 27.423 DFL T39 T40	01.94-						
27.423 DF-TM T48	07.00-						
27.463 DF, 27.463 DFL T39 T40	01.94-						
27.463 DF-TM T48	07.00-						
27.464 DFC T48	01.94-						
27.464 DFK, DFK-KI, DFK-L, DF-KI T48	05.01-						
27.464 DFS T48	01.94-						
27.464 DF-TM T48	05.01-						
27.464 FVL T38	06.98-						
32.314 VF, VFC T45	05.01-						
32.314 VFK, VF-HK T45	05.01-						
32.314 VF-TM T45	05.01-						
32.364 VFK, VF-HK T45	05.01-						
32.364 VF-TM T45	05.01-						
32.414 VF, VFC T45	05.01-						
32.414 VFK, VF-HK T45	05.01-						
32.414 VF-TM T45	05.01-						
32.464 VF, VFC T45	05.01-						
32.464 VFK, VF-HK T45	05.01-						
32.464 VF-TM T45	05.01-						





























MAN



















F 2000		01.94 -					
33.364 DFAC T42	05.01-	D2876LF03, D2866LF24, D2876LF06, D2866LF20, D2866LF23, D2866LF25, D2876LF02, E2866DF01, D2865LF22		3488 017 447	400 MFZ2/400X	Getr. / GBox: ZF Ecosplit-3 für Fahrzeuge mit Zweischeibenkupplung / for vehicles with double disc clutch	(77)
33.364 DFAK, DFAK-HK, DFA- KI T42	05.01-			1878 002 643	400 10 400WGTZ	Getr. / GBox: ZF Ecosplit-3 für Fahrzeuge mit Zweischeibenkupplung / for vehicles with double disc clutch	(77)
33.364 DFAS T42	05.01-			3151 262 031	KZISZ-5	Getr. / GBox: ZF Ecosplit-3 für Fahrzeuge mit Zweischeibenkupplung / for vehicles with double disc clutch	(77)
33.364 DFC T48	05.01-			3189 600 009		Getr. / GBox: ZF Ecosplit-3 für Fahrzeuge mit Zweischeibenkupplung / for vehicles with double disc clutch	(77)
33.364 DFK, DF-KI T48	05.01-						
33.364 DFS, DFRS T48	05.01-						
33.414 DFAC T42	05.01-						
33.414 DFAK, DFAK-HK, DFA- KI T42	05.01-						
33.414 DFAS T42	05.01-						
33.414 DFC T48	05.01-						
33.414 DFK, DF-KI T48	05.01-						
33.414 DFS, DFRS T48	05.01-						
33.464 DFC T48	05.01-						
33.464 DFK, DF-KI T48	05.01-						
33.464 DFS, DFRS T48	05.01-						
35.314 VF-TM T46	03.02-						
35.364 VF, VFC, VFRC T46	05.01-						
35.364 VFK, VF-HK, VF-KI T46	03.02-						
35.364 VF-TM T46	03.02-						
35.373 VF, VFC, VFRC T46	05.01-						
35.373 VFK, VF-HK, VF-KI T46	03.02-						
35.414 VF, VFC, VFRC T46	05.01-						
35.414 VFK, VF-HK, VF-KI T46	03.02-						
35.414 VF-TM T46	03.02-						
35.423 VF, VFC, VFRC T46	05.01-						
35.423 VFK, VF-HK, VF-KI T46	03.02-						
35.464 VF, VFC, VFRC T46	05.01-						
35.464 VFK, VF-HK, VF-KI T46	03.02-						
35.464 VF-TM T46	03.02-						
37.414 VFA E68	06.98-						
37.464 VFA E68	06.98-						
40.273 DFAK T44	01.94-						
40.373 DFAK T44	05.01-						
40.373 DFK T43	05.01-						
40.403 DFAK T44	01.94-						
40.403 DFAS	01.94-						

F 2000		01.94 -					
40.403 DFK T43	01.94-	D2876LF03, D2866LF24, D2876LF06, D2866LF20, D2866LF23, D2866LF25, D2876LF02, E2866DF01, D2865LF22		3488 017 447	400 MFZ2/400X	Getr. / GBox: ZF Ecosplit-3 für Fahrzeuge mit Zweischeibenkupplung / for vehicles with double disc clutch	(77)
40.414 DFK T43	05.01-			1878 002 643	400 10 400WGTZ	Getr. / GBox: ZF Ecosplit-3 für Fahrzeuge mit Zweischeibenkupplung / for vehicles with double disc clutch	(77)
40.423 DFK T43	05.01-			3151 262 031	KZISZ-5	Getr. / GBox: ZF Ecosplit-3 für Fahrzeuge mit Zweischeibenkupplung / for vehicles with double disc clutch	(77)
40.463 DFK T44	01.94-			3189 600 009		Getr. / GBox: ZF Ecosplit-3 für Fahrzeuge mit Zweischeibenkupplung / for vehicles with double disc clutch	(77)
40.463 DFAS T44	01.94-						
40.463 DFK T43	01.94-						
40.463 DFS	01.94-						
40.464 DFK T44	05.01-						
40.464 DFAS T44	05.01-						
40.464 DFK T43	05.01-						
41.364 VF, VFC, VFRC T46	05.01-						
41.364 VFK, VF-HK, VF-KI T46	03.02-						
41.373 VF, VFC, VFRC T46	05.01-						
41.373 VFK, VF-HK, VF-KI T46	03.02-						
41.414 VF, VFC, VFRC T46	05.01-						
41.414 VFK, VF-HK, VF-KI T46	03.02-						
41.423 VF, VFC, VFRC T46	05.01-						
41.423 VFK, VF-HK, VF-KI T46	03.02-						
41.464 VF, VFC, VFRC T46	06.98-						
41.464 VFK, VF-HK, VF-KI T46	03.02-						
18.423 T33	01.94-	D2866LF21		3400 122 201	430 10 MFZ430		
21.373 4x4 FA T34	08.94-			<ul style="list-style-type: none"> • 3482 083 032 • 1878 004 832 • 3151 000 034 	430WGTZ KZISZ-5		
				3189 600 020		Getr. / GBox: ZF Ecosplit-3	
19.233 T31	01.94-	D2840		3488 017 447	400 MFZ2/400X	enthält eine Kupplungsscheibe / This part number includes one clutch disc	(67)
26.464 T48				1878 002 643 ▽	400 10 400WGTZ	Lose Kupplungsscheibe / Loose clutch disc	(41)
33.463 T48				3151 262 031	KZISZ-5		
				1878 002 023 △	400 8 400GTZ	In 3483/3488 enthalten / Contained in 3483, 3488	(32)
				3189 600 036		für Fahrzeuge mit Zweischeibenkupplung / for vehicles with double disc clutch	(77)
				3189 600 009		Getr. / GBox: ZF Ecosplit-3 für Fahrzeuge mit Zweischeibenkupplung / for vehicles with double disc clutch	(77)

		CODE				
--	--	------	--	---	---	---

MAN

F 2000		01.94 -					
19.233 FC CNG T31	03.00-	D2866		3400 122 201 ⊗ 3482 083 032 ⊗ 1878 004 832 ⊙ 3151 000 034	430 10 MFZ430 430WGTZ KZISZ-5		
19.403 FC, FLC, FLLC, FRC, FLRC, F-NL T31 T50 T32 T33	01.94-			3400 700 327 ⊗ 3482 114 031 ⊗ 1878 004 832 ⊙ 3151 263 031	430 10 GMFZ430N 430WGTZ KZIZ-6	für Nebenantrieb / for PTO	(82)
19.403 FK, F-KI, FK-L, FLK, FL- KI, F-NL T32 T31	01.94-			3400 700 641 HD ⊗ 3482 114 031 ⊗ 1878 007 729 ⊙ 3151 263 031	430 10 GMFZ430N 430WGTZ KZIZ-6	Nebenantriebs-ID / PTO ID: NMV 221	(50)
19.403 FS, FLS, FLLS, FRS, FLRS, FLLRS T32 T33 T50 T31	01.94-			3488 017 447	400 MFZ2/400X	Getr. / GBox: ZF Ecosplit-3 für Fahrzeuge mit Zweischeibenkupplung / for vehicles with double disc clutch enthält eine Kupplungsscheibe / This part number includes one clutch disc	(77) (67)
19.423 FC, FLC, FLLC, F-NL T31 T32 T33	01.94-	D2866LF21, D2866LF20, D2866LF22, E2866DF01		1878 002 643	400 10 400WGTZ	Getr. / GBox: ZF Ecosplit-3 für Fahrzeuge mit Zweischeibenkupplung / for vehicles with double disc clutch	(77)
19.423 FK, F-KI, FK-L, FLK, FL- KI, F-NL T31 T32	01.94-			3151 262 031	KZISZ-5	Getr. / GBox: ZF Ecosplit-3 für Fahrzeuge mit Zweischeibenkupplung / for vehicles with double disc clutch	(77)
19.423 FS, FLS, FLLS T32 T33 T31	01.94-			3189 600 009		Getr. / GBox: ZF Ecosplit-3 für Fahrzeuge mit Zweischeibenkupplung / for vehicles with double disc clutch	(77)
26.373 DFC, 26.373 DFLC T39 T40	01.94 - 12.95			3189 600 020		Getr. / GBox: ZF Ecosplit-3	
26.373 DFK, 26.373 DFLK T39 T40	01.94 - 12.95						
26.373 DFS, 26.373 DFSL T40 T39	01.94 - 12.95						
26.373 FNLC, 26.373 FNLLC, 26.373 FVLC T36 T37 T38	01.94 - 12.95						
26.373 FNLS, 26.373 FVLS T36 T38	01.94 - 12.95						
28.373 T48	01.94-						
28.403 T48	01.94-						
28.423 T48	01.94-						
33.403 DFC T48	01.94-						
33.403 DFK, DF-KI T48	01.94-						
33.403 DFS, DFRS T48	01.94-						
19.314 FAC T34	05.01-	D2866LF34, D2866LF31, D2866LF35		3400 122 201 ⊗ 3482 083 032 ⊗ 1878 004 832 ⊙ 3151 000 034	430 10 MFZ430 430WGTZ KZISZ-5		
19.314 FAK, FA-KI, FAK-L T34	05.01-			3189 600 020		Getr. / GBox: ZF Ecosplit-3	
19.314 FAS T34	06.98-						
19.364 FAC T34	06.98-						
19.364 FAK, FA-KI, FAK-L T34	06.98-						
19.364 FAS T34	06.98-						
19.414 FAC T34	06.98-						
19.414 FAK, FA-KI, FAK-L T34	06.98-						
19.414 FAS T34	06.98-						
26.413 T 36							
26.414							

F 2000		01.94 -					
19.314 FC, FLC, FLLC, FLLW, FRC, FLRC, FLLRC, FLL, FLLR, F-N T32 T31 T33 T50 19.314 FK, FK-L, F-KI, FL-KI, F-NL, FLK T31 T32 19.314 FS, FLS, FLLS, FRS, FLRS, FLLRS T31 T32 T33 T50 19.364 FC, FLC, FLLC, FLLW, FRC, FLRC, FLLRC, FLL, FLLR, F-N T31 T33 T32 T50 19.364 FK, FK-L, F-KI, FL-KI, F-NL, FLK T32 T31 19.364 FS, FLS, FLLS, FRS, FLRS, FLLRS T50 T32 T31 T33 19.414 FC, FLC, FLLC, FRC, FLRC, FLLRC, FLL, FLLR, F-NL T33 T32 T50 T31 19.414 FK, F-KI, FK-L, FLK, FL-KI, F-NL T31 T32 19.414 FS, FLS, FLLS, FRS, FLRS, FLLRS T50 T32 T33 T31	06.98-	D2866LF34, D2866LF31, D2866LF35	 3400 122 201 ⊗ 3482 083 032 ⊗ 1878 004 832 ⊙ 3151 000 034	430 10 MFZ430 430WGTZ KZISZ-5			
	06.98-		 3488 017 447	400 MFZ2/400X	Getr. / GBox: ZF Ecosplit-3 für Fahrzeuge mit Zweischeibenkupplung / for vehicles with double disc clutch enthält eine Kupplungsscheibe / This part number includes one clutch disc	(77)	(67)
	06.98-		 1878 002 643	400 10 400WGTZ	Getr. / GBox: ZF Ecosplit-3 für Fahrzeuge mit Zweischeibenkupplung / for vehicles with double disc clutch	(77)	
	06.98-		 3151 262 031	KZISZ-5	Getr. / GBox: ZF Ecosplit-3 für Fahrzeuge mit Zweischeibenkupplung / for vehicles with double disc clutch	(77)	
	06.98-		 3189 600 009		Getr. / GBox: ZF Ecosplit-3 für Fahrzeuge mit Zweischeibenkupplung / for vehicles with double disc clutch	(77)	
	06.98-		3189 600 020		Getr. / GBox: ZF Ecosplit-3		
	06.98-						
19.323 FAC T04 19.323 FAK T04 19.323 FAS T04 19.323 FK,19.323 FLK T02 T01	01.94 - 12.95	D2865	 3400 122 301 ⊗ 3482 083 032 ⊗ 1878 080 034 ⊙ 3151 000 034	430 10 MFZ430 430WGTZ KZISZ-5	E52		
	01.94 - 12.95		 3482 114 031	430 GMFZ430N	E52 für Nebenantrieb / for PTO	(82)	
	01.94 - 12.95		 3400 122 301 ⊗ 3482 083 032 ⊗ 1878 080 034 ⊙ 3151 000 034	430 10 MFZ430 430WGTZ KZISZ-5	T01,02,03,04		
	01.94 - 12.95		 3189 600 020		Getr. / GBox: ZF Ecosplit-3		
19.344 T04,20,E52 21.343 T04 23.344 T05 24.343 T05,06,E53 28.343 T08	01.94 -	D2865LF21	 3400 122 301 ⊗ 3482 083 032 ⊗ 1878 080 034 ⊙ 3151 000 034	430 10 MFZ430 430WGTZ KZISZ-5			
	01.94 -		 3482 114 031	430 GMFZ430N	für Nebenantrieb / for PTO	(82)	
	04.94 -		 1878 080 034	430 10 430WGTZ	für Nebenantrieb / for PTO	(82)	
	01.94 -		 3151 263 031	KZISZ-6	für Nebenantrieb / for PTO	(82)	
	01.94 -		 3189 600 020		Getr. / GBox: ZF Ecosplit-3		
19.373 T31,32 19.403 T31,32 19.423 T31,32	06.98-	D2840	 3488 017 447	400 MFZ2/400X	enthält eine Kupplungsscheibe / This part number includes one clutch disc	(67)	
	06.98-		 1878 002 643 ▽	400 10 400WGTZ	Lose Kupplungsscheibe / Loose clutch disc	(41)	
	06.98-		 3151 262 031	KZISZ-5			
	06.98-		 1878 002 023 △	400 8 400GTZ	In 3483/3488 enthalten / Contained in 3483, 3488	(32)	
	06.98-		 3189 600 036		für Fahrzeuge mit Zweischeibenkupplung / for vehicles with double disc clutch	(77)	



MAN

F 2000		01.94 -				
19.373 FAC T34 19.373 FAK, FA-KI, FAK-L T34 19.373 FAS T34	01.94 -	D2866LF21	3400 122 201 ⊗ 3482 083 032 ⊗ 1878 004 832 ⊙ 3151 000 034	430 10 MFZ430 430WGTZ KZISZ-5	T31,32,33,34	
	01.94 -		3400 700 327 ⊗ 3482 114 031 ⊗ 1878 004 832 ⊙ 3151 263 031	430 10 GMFZ430N 430WGTZ KZIZ-6	T31,32,33,34 für Nebenantrieb / for PTO	(82)
	01.94 -		3400 700 641 HD ⊗ 3482 114 031 ⊗ 1878 007 729 ⊙ 3151 263 031	430 10 GMFZ430N 430WGTZ KZIZ-6	T31,32,33,34 Nebenantriebs-ID / PTO ID: NMV 221	(50)
			3189 600 020		Getr. / GBox: ZF Ecosplit-3	
19.373 FC, FLC, FLLC, FRC, FLRC, F-NL T33 T32 T31 19.373 FK, FK-L, F-KI, FL-KI, F-NL, FLK T32 T31 19.373 FS, FLS, FLLS, FRS, FLRS, FLLRS T32 T33 T31	01.94 -	D2866LF21	3400 122 201 ⊗ 3482 083 032 ⊗ 1878 004 832 ⊙ 3151 000 034	430 10 MFZ430 430WGTZ KZISZ-5	T31,32,33,34	
	01.94 -		3400 700 327 ⊗ 3482 114 031 ⊗ 1878 004 832 ⊙ 3151 263 031	430 10 GMFZ430N 430WGTZ KZIZ-6	T31,32,33,34 für Nebenantrieb / for PTO	(82)
	01.94 -		3400 700 641 HD ⊗ 3482 114 031 ⊗ 1878 007 729 ⊙ 3151 263 031	430 10 GMFZ430N 430WGTZ KZIZ-6	T31,32,33,34 Nebenantriebs-ID / PTO ID: NMV 221	(50)
			3488 017 447	400 MFZ2/400X	Getr. / GBox: ZF Ecosplit-3 für Fahrzeuge mit Zweischeibenkupplung / for vehicles with double disc clutch enthält eine Kupplungsscheibe / This part number includes one clutch disc	(77) (67)
			1878 002 643	400 10 400WGTZ	Getr. / GBox: ZF Ecosplit-3 für Fahrzeuge mit Zweischeibenkupplung / for vehicles with double disc clutch	(77)
			3151 262 031	KZISZ-5	Getr. / GBox: ZF Ecosplit-3 für Fahrzeuge mit Zweischeibenkupplung / for vehicles with double disc clutch	(77)
			3189 600 020		Getr. / GBox: ZF Ecosplit-3	
			3189 600 009		Getr. / GBox: ZF Ecosplit-3 für Fahrzeuge mit Zweischeibenkupplung / for vehicles with double disc clutch	(77)
19.403 FAC T34 19.403 FAK, FA-KI T34 19.403 FAS T34 19.423 FAC T34 19.423 FAK, FA-KI T34 19.423 FAS T34 26.404 T39,40,42,48	01.94 -	D2866	3400 122 201 ⊗ 3482 083 032 ⊗ 1878 004 832 ⊙ 3151 000 034	430 10 MFZ430 430WGTZ KZISZ-5		
	01.94 -		3400 700 327 ⊗ 3482 114 031 ⊗ 1878 004 832 ⊙ 3151 263 031	430 10 GMFZ430N 430WGTZ KZIZ-6	für Nebenantrieb / for PTO	(82)
	01.94 - 12.95		3400 700 641 HD ⊗ 3482 114 031 ⊗ 1878 007 729 ⊙ 3151 263 031	430 10 GMFZ430N 430WGTZ KZIZ-6	Nebenantriebs-ID / PTO ID: NMV 221	(50)
	01.94 -		3189 600 020		Getr. / GBox: ZF Ecosplit-3	
	01.94 - 12.95					
	01.94 -		D2866LF20, D2866LF22	3189 600 020		Getr. / GBox: ZF Ecosplit-3
19.404 T34,E61,62 23.404 T35,37	01.94 -	D2866LF20	3400 122 201 ⊗ 3482 083 032 ⊗ 1878 004 832 ⊙ 3151 000 034	430 10 MFZ430 430WGTZ KZISZ-5		
	01.94 -		3400 700 327 ⊗ 3482 114 031 ⊗ 1878 004 832 ⊙ 3151 263 031	430 10 GMFZ430N 430WGTZ KZIZ-6	für Nebenantrieb / for PTO	(82)
			3400 700 641 HD ⊗ 3482 114 031 ⊗ 1878 007 729 ⊙ 3151 263 031	430 10 GMFZ430N 430WGTZ KZIZ-6	Nebenantriebs-ID / PTO ID: NMV 221	(50)
			3189 600 020		Getr. / GBox: ZF Ecosplit-3	





















































MAN













F 2000		01.94 -					
19.404 T50		D2866LF20	3400 122 201 3482 083 032 1878 004 832 3151 000 034	430 10 MFZ430 430WGTZ KZISZ-5	01.1995 - 05.1996		
			3400 122 301 3482 083 032 1878 080 034 3151 000 034	430 10 MFZ430 430WGTZ KZISZ-5	06.1996->		
			3400 700 327 3482 114 031 1878 004 832 3151 263 031	430 10 GMFZ430N 430WGTZ KZIZ-6	01.1996-> für Nebenantrieb / for PTO	(82)	
			3400 700 641 HD 3482 114 031 1878 007 729 3151 263 031	430 10 GMFZ430N 430WGTZ KZIZ-6	01.1996-> Nebenantriebs-ID / PTO ID: NMV 221	(50)	
		3488 017 447	400 MFZ2/400X	Getr. / GBox: ZF Ecosplit-3 für Fahrzeuge mit Zweischeibenkupplung / for vehicles with double disc clutch enthält eine Kupplungsscheibe / This part number includes one clutch disc	(77) (67)		
		1878 002 643	400 10 400WGTZ	Getr. / GBox: ZF Ecosplit-3 für Fahrzeuge mit Zweischeibenkupplung / for vehicles with double disc clutch	(77)		
		3151 262 031	KZISZ-5	Getr. / GBox: ZF Ecosplit-3 für Fahrzeuge mit Zweischeibenkupplung / for vehicles with double disc clutch	(77)		
		3189 600 009		Getr. / GBox: ZF Ecosplit-3 für Fahrzeuge mit Zweischeibenkupplung / for vehicles with double disc clutch	(77)		
		3189 600 020		Getr. / GBox: ZF Ecosplit-3			
		19.463 FAC T34 19.463 FAK, FA-KI, FAK-L T34 19.463 FAS T34	01.94 -	D2876LF02	3400 122 201 3482 083 032 1878 004 832 3151 000 034	430 10 MFZ430 430WGTZ KZISZ-5	
01.94 -	3400 700 327 3482 114 031 1878 004 832 3151 263 031		430 10 GMFZ430N 430WGTZ KZIZ-6		->07.1999 für Nebenantrieb / for PTO	(82)	
01.94 -	3400 700 641 HD 3482 114 031 1878 007 729 3151 263 031		430 10 GMFZ430N 430WGTZ KZIZ-6		Nebenantriebs-ID / PTO ID: NMV 221	(50)	
	3189 600 020				Getr. / GBox: ZF Ecosplit-3		
	3189 600 009				Getr. / GBox: ZF Ecosplit-3 für Fahrzeuge mit Zweischeibenkupplung / for vehicles with double disc clutch	(77)	
19.463 FC, FLC, FLLC, FRC, FLRC, F-NL T33 T50 T31 T32 19.463 FK, F-KI, FK-L, FLK, FL- KI, F-NL T31 T32 19.463 FS, FLS, FLLS, FRS, FLRS, FLLRS T31 T32 T33 T50	01.94 -	D2876LF02	3400 122 201 3482 083 032 1878 004 832 3151 000 034	430 10 MFZ430 430WGTZ KZISZ-5			
	01.94 -		3400 700 327 3482 114 031 1878 004 832 3151 263 031	430 10 GMFZ430N 430WGTZ KZIZ-6	->07.1999 für Nebenantrieb / for PTO	(82)	
	01.94 -		3400 700 641 HD 3482 114 031 1878 007 729 3151 263 031	430 10 GMFZ430N 430WGTZ KZIZ-6	Nebenantriebs-ID / PTO ID: NMV 221	(50)	
			3488 017 447	400 MFZ2/400X	Getr. / GBox: ZF Ecosplit-3 für Fahrzeuge mit Zweischeibenkupplung / for vehicles with double disc clutch enthält eine Kupplungsscheibe / This part number includes one clutch disc	(77) (67)	
			1878 002 643	400 10 400WGTZ	Getr. / GBox: ZF Ecosplit-3 für Fahrzeuge mit Zweischeibenkupplung / for vehicles with double disc clutch	(77)	
			3151 262 031	KZISZ-5	Getr. / GBox: ZF Ecosplit-3 für Fahrzeuge mit Zweischeibenkupplung / for vehicles with double disc clutch	(77)	
			3189 600 020		Getr. / GBox: ZF Ecosplit-3		
			3189 600 009		Getr. / GBox: ZF Ecosplit-3 für Fahrzeuge mit Zweischeibenkupplung / for vehicles with double disc clutch	(77)	
				3189 600 020		Getr. / GBox: ZF Ecosplit-3	
				3189 600 009		Getr. / GBox: ZF Ecosplit-3 für Fahrzeuge mit Zweischeibenkupplung / for vehicles with double disc clutch	(77)
19.464 T34,E61,62 21.403 4x4 FA T34	01.94 -	D2866LF20	3400 122 201 3482 083 032 1878 004 832 3151 000 034	430 10 MFZ430 430WGTZ KZISZ-5			
	08.94 -		3189 600 020		Getr. / GBox: ZF Ecosplit-3		

		CODE				
--	--	------	--	---	---	---





MAN

































F 2000		01.94 -				
19.464 T50 27.464 DFAC T42 27.464 DFAK, DFA-KI, DFAK-L T42	05.01 -	D2876LF02	 3400 122 201  3482 083 032  1878 004 832  3151 000 034	430 10 MFZ430 430WGTZ KZISZ-5	01.1995 - 05.1996	
	05.01 -		 3400 122 301  3482 083 032  1878 080 034  3151 000 034	430 10 MFZ430 430WGTZ KZISZ-5	06.1996->	
			 3400 700 327  3482 114 031  1878 004 832  3151 263 031	430 10 GMFZ430N 430WGTZ KZIZ-6	01.1996-> für Nebenantrieb / for PTO	(82)
			 3400 700 641 HD  3482 114 031  1878 007 729  3151 263 031	430 10 GMFZ430N 430WGTZ KZIZ-6	01.1996-> Nebenantriebs-ID / PTO ID: NMV 221	(50)
			D2876LF03	 3488 017 447	400 MFZ2/400X	Getr. / GBox: ZF Ecosplit-3 für Fahrzeuge mit Zweischeibenkupplung / for vehicles with double disc clutch enthält eine Kupplungsscheibe / This part number includes one clutch disc
			 1878 002 643	400 10 400WGTZ	Getr. / GBox: ZF Ecosplit-3 für Fahrzeuge mit Zweischeibenkupplung / for vehicles with double disc clutch	(77)
			 3151 262 031	KZISZ-5	Getr. / GBox: ZF Ecosplit-3 für Fahrzeuge mit Zweischeibenkupplung / for vehicles with double disc clutch	(77)
			 3189 600 009		Getr. / GBox: ZF Ecosplit-3 für Fahrzeuge mit Zweischeibenkupplung / for vehicles with double disc clutch	(77)
			3189 600 020		Getr. / GBox: ZF Ecosplit-3	
19.464 FAC T34 19.464 FAK, FA-KI, FAK-L T34 19.464 FAS T34	06.98 -	D2876LF06	 3400 122 201  3482 083 032  1878 004 832  3151 000 034	430 10 MFZ430 430WGTZ KZISZ-5		
	06.98 -		 3400 700 327  3482 114 031  1878 004 832  3151 263 031	430 10 GMFZ430N 430WGTZ KZIZ-6	->07.1999 für Nebenantrieb / for PTO	(82)
	06.98 -		 3400 700 641 HD  3482 114 031  1878 007 729  3151 263 031	430 10 GMFZ430N 430WGTZ KZIZ-6	->07.1999 Nebenantriebs-ID / PTO ID: NMV 221	(50)
			 3189 600 020		Getr. / GBox: ZF Ecosplit-3	
19.464 FC, FLC, FLLC, FLL, FRC, FLLR, FLLRC, FLLW, F- NL T32 T33 T50 T31 19.464 FK, F-KI, FK-L, FLK, FL- KI, F-NL T32 T31 19.464 FS, FLS, FLLS, FRS, FLRS, FLLRS T32 T31 T33 T50 26.233 FVLC CNG T38 26.463 DFC, DFLC T39 T40 26.463 DFK, DFLK, DFLK-L T39 T40 26.463 DFS, DFLS T40 T39 26.463 FNLC, FNLLC, FNLLRC, FNLLW, FNLR, FNLLRC, FVLC T38 T37 T36 26.463 FNLS, FVLS, FVLR T38 T36	06.98 -	D2876LF06, D2876LF02, E2866DF01	 3400 122 201  3482 083 032  1878 004 832  3151 000 034	430 10 MFZ430 430WGTZ KZISZ-5		
	06.98 -		 3400 700 327  3482 114 031  1878 004 832  3151 263 031	430 10 GMFZ430N 430WGTZ KZIZ-6	->07.1999 für Nebenantrieb / for PTO	(82)
	06.98 -		 3400 700 641 HD  3482 114 031  1878 007 729  3151 263 031	430 10 GMFZ430N 430WGTZ KZIZ-6	->07.1999 Nebenantriebs-ID / PTO ID: NMV 221	(50)
	09.96 -					
	01.94 -		 3488 017 447	400 MFZ2/400X	Getr. / GBox: ZF Ecosplit-3 für Fahrzeuge mit Zweischeibenkupplung / for vehicles with double disc clutch enthält eine Kupplungsscheibe / This part number includes one clutch disc	(77) (67)
	01.94 -		 1878 002 643	400 10 400WGTZ	Getr. / GBox: ZF Ecosplit-3 für Fahrzeuge mit Zweischeibenkupplung / for vehicles with double disc clutch	(77)
	01.94 -		 3151 262 031	KZISZ-5	Getr. / GBox: ZF Ecosplit-3 für Fahrzeuge mit Zweischeibenkupplung / for vehicles with double disc clutch	(77)
	01.94 -		 3189 600 020		Getr. / GBox: ZF Ecosplit-3	
	01.94 -		 3189 600 009		Getr. / GBox: ZF Ecosplit-3 für Fahrzeuge mit Zweischeibenkupplung / for vehicles with double disc clutch	(77)

MAN

F 2000		01.94 -					
19.603 FLS, 19604 FLS T62	04.96 -	D2840		3488 017 447	400 MFZ2/400X	T62 enthält eine Kupplungsscheibe / This part number includes one clutch disc	(67)
				1878 002 643 ▽	400 10 400WGTZ	T62 Lose Kupplungsscheibe / Loose clutch disc	(41)
				3151 262 031	KZISZ-5	T62	
				1878 002 023 △	400 8 400GTZ	T62 In 3483/3488 enthalten / Contained in 3483, 3488	(32)
		D2840LF20		3189 600 036		für Fahrzeuge mit Zweischeibenkupplung / for vehicles with double disc clutch	(77)
23.293 FNLLC T05	01.94 -	D2865LF24		3400 122 301	430 10 MFZ430	T05	
				3482 083 032	430WGTZ		
				1878 080 034	KZISZ-5		
				3151 000 034			
			3482 114 031	430 GMFZ430N	T05 für Nebenantrieb / for PTO	(82)	
	1878 080 034	430 10 430WGTZ	T05 für Nebenantrieb / for PTO	(82)			
	3151 263 031	KZIZ-6	T05 für Nebenantrieb / for PTO	(82)			
D2865LF24, D2865LF20		3189 600 020		Getr. / GBox: ZF Ecosplit-3			























MAN















F 2000		01.94 -				
23.343 FNLLC T05	01.94 -	D2865LF24, D2865LF20, D2865LF22, D2865LF23, D2865LF21		3400 122 301 ● 3482 083 032 ● 1878 080 034 ● 3151 000 034	430 10 MFZ430 430WGTZ KZISZ-5	
24.273 FNLLC T07	01.94 - 12.95			3482 114 031	430 GMFZ430N	für Nebenantrieb / for PTO (82)
24.323 FNLLC T07	01.94 - 12.95			1878 080 034	430 10 430WGTZ	für Nebenantrieb / for PTO (82)
24.343 FNLLC T07	01.94 -			3151 263 031	KZIZ-6	für Nebenantrieb / for PTO (82)
26.273 DFC,26.273 DFCL T09 T10	01.94 - 12.95			3189 600 020		Getr. / GBox: ZF Ecosplit-3
26.273 DFK,26.273 DFLK T10 T09	01.94 - 12.95					
26.273 DFS,26.273 DFSL T09 T10	01.94 - 12.95					
26.273 FNLC,26.273 FNLLC,26.273 FVLC T08 T07 T06	01.94 - 12.95					
26.273 FNLC,26.273 FNLLC,26.273 FVLC T07 T08 T06	01.94 - 12.95					
26.273 FNLS,26.273 FVLS T08 T06	01.94 - 12.95					
26.293 FNLC,26.293 FNLLC,26.293 FVLC T06 T08 T07	01.94 -					
26.293 FNLS,26.293 FVLS T06 T08	01.94 -					
26.323 DFC,26.323 DFCL T09 T10	01.94 - 12.95					
26.323 DFK,26.323 DFLK T10 T09	01.94 - 12.95					
26.323 DFS,26.323 DFSL T09 T10	01.94 - 12.95					
26.323 FNLC,26.323 FNLLC,26.323 FVLC T07 T06 T08	01.94 - 12.95					
26.323 FNLC,26.323 FNLLC,26.323 FVLC T06 T08 T07	01.94 - 12.95					
26.323 FNLS,26.323 FVLS T06 T08	01.94 - 12.95					
27.273 DFC T18	01.94 - 12.95					
27.273 DFK T18	01.94 - 12.95					
27.273 DFS T18	01.94 - 12.95					
27.323 DFC T18	01.94 - 12.95					
27.323 DFK, DF-KI T18	01.94 -					
27.323 DFS T18	01.94 - 12.95					
27.343 DFC T18	01.94 -					
27.343 DFK T18	01.94 -					
27.343 DFS T18	01.94 -					

F 2000		01.94 -				
23.403 FNLLC T35	01.94 -	D2866LF21, D2866LF20, D2866LF22, D2876LF02	 3400 122 201  3482 083 032  1878 004 832  3151 000 034	430 10 MFZ430 430WGTZ KZISZ-5		
23.463 FNLLC T35	01.94 -		 3400 700 327  3482 114 031  1878 004 832  3151 263 031	430 10 GMFZ430N 430WGTZ KZIZ-6	für Nebenantrieb / for PTO	(82)
24.373 FNLLC T37	01.94 - 12.95		 3400 700 641 HD  3482 114 031  1878 007 729  3151 263 031	430 10 GMFZ430N 430WGTZ KZIZ-6	Nebenantriebs-ID / PTO ID: NMV 221	(50)
24.403 FNLLC T37	01.94 -					
24.423 FNLLC T37	01.94 - 12.95					
24.463 FNLLC T37	01.94 -					
26.403 DFC,26.403 DFLLC T39 T40	01.94 -		 3488 017 447	400 MFZ2/400X	Getr. / GBox: ZF Ecosplit-3 für Fahrzeuge mit Zweischeibenkupplung / for vehicles with double disc clutch	(77)
26.403 DFK,26.403 DFLK T40 T39	01.94 -				enthält eine Kupplungsscheibe / This part number includes one clutch disc	(67)
26.403 DFS,26.403 DFLLS T39 T40	01.94 -		 1878 002 643	400 10 400WGTZ	Getr. / GBox: ZF Ecosplit-3 für Fahrzeuge mit Zweischeibenkupplung / for vehicles with double disc clutch	(77)
26.403 FNLC,26.403 FNLLC,26.403 FVLC T38 T36 T37	01.94 -		 3151 262 031	KZISZ-5	Getr. / GBox: ZF Ecosplit-3 für Fahrzeuge mit Zweischeibenkupplung / for vehicles with double disc clutch	(77)
26.403 FNLC,26.403 FNLLC,26.403 FVLC T36 T37 T38	01.94 -		 3189 600 020 3189 600 009		Getr. / GBox: ZF Ecosplit-3	
26.403 FNLS,26.403 FVLS T38 T36	01.94 -				Getr. / GBox: ZF Ecosplit-3 für Fahrzeuge mit Zweischeibenkupplung / for vehicles with double disc clutch	(77)
26.403 FNLS,26.403 FVLS T36 T38	01.94 -					
26.423 FNLC,26.423 FNLLC,26.423 FVLC T36 T38 T37	01.94 - 12.95					
26.423 FNLC,26.423 FNLLC,26.423 FVLC T37 T36 T38	01.94 - 12.95					
26.423 FNLS,26.423 FVLS T36 T38	01.94 - 12.95					
33.423 DFC T48	01.94 -					
33.423 DFK, DF-KI T48	01.94 -					
33.423 DFS, DFRS T48	01.94 -					
26.293 DFC,26.293 DFLLC T10 T09	01.94 -	D2865LF24	 3400 122 301  3482 083 032  1878 080 034  3151 000 034	430 10 MFZ430 430WGTZ KZISZ-5	T08,09,10,12,E53	
26.293 DFK,26.293 DFLK T09 T10	01.94 -					
26.293 DFS,26.293 DFLLS T10 T09	01.94 -		 3482 114 031	430 GMFZ430N	T08,09,10,E53 für Nebenantrieb / for PTO	(82)
26.293 FNLC,26.293 FNLLC,26.293 FVLC T07 T08 T06	01.94 -		 1878 080 034	430 10 430WGTZ	T08,09,10,12,E53 für Nebenantrieb / for PTO	(82)
26.293 FNLS,26.293 FVLS T06 T08	01.94 -		 3151 263 031	KZIZ-6	T08,09,10,E53 für Nebenantrieb / for PTO	(82)
		D2865LF24, D2865LF20	 3189 600 020		Getr. / GBox: ZF Ecosplit-3	
26.343 DFC,26.343 DFLLC T09 T10	01.94 -	D2865LF21	 3400 122 301  3482 083 032  1878 080 034  3151 000 034	430 10 MFZ430 430WGTZ KZISZ-5	T06-10,12,E53	
26.343 DFK,26.343 DFLK T10 T09	01.94 -					
26.343 DFS,26.343 DFLLS T09 T10	01.94 -		 3482 114 031	430 GMFZ430N	T08,09,10,E53 für Nebenantrieb / for PTO	(82)
26.343 FNLC,26.343 FNLLC,26.343 FVLC T06 T07 T08	01.94 -		 1878 080 034	430 10 430WGTZ	T06-10,12,E53 für Nebenantrieb / for PTO	(82)
26.343 FNLC,26.343 FNLLC,26.343 FVLC T06 T08 T07	01.94 -		 3151 263 031	KZIZ-6	T08,09,10,E53 für Nebenantrieb / for PTO	(82)
26.343 FNLS,26.343 FVLS T06 T08	01.94 -		 3189 600 020		Getr. / GBox: ZF Ecosplit-3	
26.343 FNLS,26.343 FVLS T08 T06	01.94 -					

		CODE				
--	--	------	--	---	---	---























MAN

F 2000		01.94 -					
26.373 DF T42				3483 000 509 ⊕	445 GMFZ445W	für Fahrzeuge mit Wandlerschaltkupplung / for vehicles with converter and clutch unit	(76)
26.404 DF T42				1878 051 801	445 24 445GTZC	für Fahrzeuge mit Wandlerschaltkupplung / for vehicles with converter and clutch unit	(76)
26.423 DF T42				3189 600 014		für Fahrzeuge mit Wandlerschaltkupplung / for vehicles with converter and clutch unit	(76)
26.464 DF T42							
26.423 DFC,26.423 DFCL T39 T40	01.94 - 12.95	D2866		3400 122 201 ⊕ 3482 083 032 ⊕ 1878 004 832 ⊕ 3151 000 034	430 10 MFZ430 430WGTZ KZISZ-5	T39,40,42,48	
26.423 DFK,26.423 DFLK T39 T40	01.94 - 12.95						
26.423 DFS,26.423 DFSL T40 T39	01.94 - 12.95			3400 700 327 ⊕ 3482 114 031 ⊕ 1878 004 832 ⊕ 3151 263 031	430 10 GMFZ430N 430WGTZ KZIZ-6	T39,40,48 für Nebenantrieb / for PTO	(82)
27.373 DFC T48	01.94 -						
27.373 DFK, DFK-KI, DFK-L, DF-KI T48	01.94 -			3400 700 641 HD ⊕ 3482 114 031 ⊕ 1878 007 729 ⊕ 3151 263 031	430 10 GMFZ430N 430WGTZ KZIZ-6	T39,40,48 Nebenantriebs-ID / PTO ID: NMV 221	(50)
27.373 DFS T48	01.94 -						
27.403 DFC T48	01.94 -	D2866LF21, D2866LF20, D2866LF22		3488 017 447	400 MFZ2/400X	Getr. / GBox: ZF Ecosplit-3 für Fahrzeuge mit Zweischeibenkupplung / for vehicles with double disc clutch enthält eine Kupplungsscheibe / This part number includes one clutch disc	(77) (67)
27.403 DFK, DFK-KI, DFK-L, DF-KI T48	01.94 -			1878 002 643	400 10 400WGTZ	Getr. / GBox: ZF Ecosplit-3 für Fahrzeuge mit Zweischeibenkupplung / for vehicles with double disc clutch	(77)
27.403 DFS T48	01.94 -			3151 262 031	KZISZ-5	Getr. / GBox: ZF Ecosplit-3 für Fahrzeuge mit Zweischeibenkupplung / for vehicles with double disc clutch	(77)
27.423 DFC T48	01.94 -			3189 600 009		Getr. / GBox: ZF Ecosplit-3 für Fahrzeuge mit Zweischeibenkupplung / for vehicles with double disc clutch	(77)
27.423 DFK, DFK-KI, DFK-L, DF-KI T48	01.94 -			3189 600 020		Getr. / GBox: ZF Ecosplit-3	
27.423 DFS T48	01.94 -						
26.463 T48		D2876		3400 122 201 ⊕ 3482 083 032 ⊕ 1878 004 832 ⊕ 3151 000 034	430 10 MFZ430 430WGTZ KZISZ-5		
				3482 114 031	430 GMFZ430N	für Nebenantrieb / for PTO	(82)
				1878 080 034	430 10 430WGTZ	für Nebenantrieb / for PTO	(82)
				3151 263 031	KZIZ-6	für Nebenantrieb / for PTO	(82)
				3488 017 447	400 MFZ2/400X	Getr. / GBox: ZF Ecosplit-3 für Fahrzeuge mit Zweischeibenkupplung / for vehicles with double disc clutch enthält eine Kupplungsscheibe / This part number includes one clutch disc	(77) (67)
				1878 002 643	400 10 400WGTZ	Getr. / GBox: ZF Ecosplit-3 für Fahrzeuge mit Zweischeibenkupplung / for vehicles with double disc clutch	(77)
				3151 262 031	KZISZ-5	Getr. / GBox: ZF Ecosplit-3 für Fahrzeuge mit Zweischeibenkupplung / for vehicles with double disc clutch	(77)
				3189 600 009		Getr. / GBox: ZF Ecosplit-3 für Fahrzeuge mit Zweischeibenkupplung / for vehicles with double disc clutch	(77)
				3189 600 020		Getr. / GBox: ZF Ecosplit-3	
				3189 600 036		für Fahrzeuge mit Zweischeibenkupplung / for vehicles with double disc clutch	(77)
26.603 DFC, DFLC T70 T78	06.96 -	D2840LF20		3488 017 447	400 MFZ2/400X	T70 enthält eine Kupplungsscheibe / This part number includes one clutch disc	(67)
26.603 DFK, DFLK T70 T78	06.96 -			1878 002 643 ▽	400 10 400WGTZ	T70 Lose Kupplungsscheibe / Loose clutch disc	(41)
26.603 DFS, DFSL T70 T78	06.96 -			3151 262 031	KZISZ-5	T70	
				1878 002 023 △	400 8 400GTZ	T70 In 3483/3488 enthalten / Contained in 3483, 3488	(32)
				3189 600 036		für Fahrzeuge mit Zweischeibenkupplung / for vehicles with double disc clutch	(77)

F 2000		01.94 -						
27.273 DFAC T12	01.94 - 12.95	D2865		3400 122 301 ⊗ 3482 083 032 ⊗ 1878 080 034 ⊙ 3151 000 034	430 10 MFZ430 430WGTZ KZISZ-5			
27.273 DFAS T12	01.94 - 12.95	D2865, 2866		3482 114 031	430 GMFZ430N	für Nebenantrieb / for PTO	(82)	
27.293 DFAC T12	01.94 -			1878 080 034	430 10 430WGTZ	für Nebenantrieb / for PTO	(82)	
27.293 DFAK T12	01.94 -			3151 263 031	KZIZ-6	für Nebenantrieb / for PTO	(82)	
27.293 DFAS T12	01.94 -	D2865LF24, D2865LF20, D2865LF22, D2865LF21, D2865LF23		3189 600 020		Getr. / GBox: ZF Ecosplit-3		
27.293 DFC T18	01.94 -							
27.293 DFK T18	01.94 -							
27.293 DFS T18	01.94 -							
27.323 DFAC T12	01.94 - 12.95							
27.323 DFAK, DFA-KI T12	01.94 -							
27.323 DFAS T12	01.94 - 12.95							
27.343 DFAC T12	01.94 -							
27.343 DFAK T12	01.94 -							
27.343 DFAS T12	01.94 -							
27.373 DFAC T42	01.94 -	D2866		3400 122 201 ⊗ 3482 083 032 ⊗ 1878 004 832 ⊙ 3151 000 034	430 10 MFZ430 430WGTZ KZISZ-5	T39,40,42,48		
27.373 DFAK, DFA-KI, DFAK-L T42	01.94 -							
27.373 DFAS T42	01.94 -	D2866LF21, D2866LF20, D2866LF22		3483 000 509 ⊕	445 GMFZ445W	für Fahrzeuge mit Wandlerschaltkupplung / for vehicles with converter and clutch unit	(76)	
27.403 DFAC T42	01.94 -			1878 051 801	445 24 445GTZC	für Fahrzeuge mit Wandlerschaltkupplung / for vehicles with converter and clutch unit	(76)	
27.403 DFAK, DFA-KI, DFAK-L T42	01.94 -			3189 600 020		Getr. / GBox: ZF Ecosplit-3		
27.403 DFAS T42	01.94 -			3189 600 014		für Fahrzeuge mit Wandlerschaltkupplung / for vehicles with converter and clutch unit	(76)	
27.423 DFAC T42	01.94 -							
27.423 DFAK, DFA-KI, DFAK-L T42	01.94 -							
27.423 DFAS T42	01.94 - 12.95							
27.463 DFAC T42	01.94 -	D2876		3400 122 201 ⊗ 3482 083 032 ⊗ 1878 004 832 ⊙ 3151 000 034	430 10 MFZ430 430WGTZ KZISZ-5			
27.463 DFAK, DFA-KI, DFAK-L T42	01.94 -							
27.463 DFAS T42	01.94 -			3400 700 327 ⊗ 3482 114 031 ⊗ 1878 004 832 ⊙ 3151 263 031	430 10 GMFZ430N 430WGTZ KZIZ-6	für Nebenantrieb / for PTO	(82)	
33.463 DFAC T42	01.94 -			3400 700 641 HD ⊗ 3482 114 031 ⊗ 1878 007 729 ⊙ 3151 263 031	430 10 GMFZ430N 430WGTZ KZIZ-6	Nebenantriebs-ID / PTO ID: NMV 221	(50)	
33.463 DFAK, DFAK-HK, DFA-KI T42	01.94 -							
33.463 DFAS T42	01.94 -	D2876LF02		3483 000 509 ⊕	445 GMFZ445W	für Fahrzeuge mit Wandlerschaltkupplung / for vehicles with converter and clutch unit	(76)	
				1878 051 801	445 24 445GTZC	für Fahrzeuge mit Wandlerschaltkupplung / for vehicles with converter and clutch unit	(76)	
				3189 600 014		für Fahrzeuge mit Wandlerschaltkupplung / for vehicles with converter and clutch unit	(76)	
				3189 600 020		Getr. / GBox: ZF Ecosplit-3		





























		CODE				
--	--	------	--	---	---	---

MAN

F 2000		01.94 -				
27.463 DFC T48	01.94-	D2876	 3400 122 201 ⊗ 3482 083 032 ⊗ 1878 004 832 ⊙ 3151 000 034	430 10 MFZ430 430WGTZ KZISZ-5		
27.463 DFK, DFK-KI, DFK-L, DF-KI T48	01.94-		 3400 700 327 ⊗ 3482 114 031 ⊗ 1878 004 832 ⊙ 3151 263 031	430 10 GMFZ430N 430WGTZ KZIZ-6	für Nebenantrieb / for PTO	(82)
27.463 DFS T48	01.94-		 3400 700 641 HD ⊗ 3482 114 031 ⊗ 1878 007 729 ⊙ 3151 263 031	430 10 GMFZ430N 430WGTZ KZIZ-6	Nebenantriebs-ID / PTO ID: NMV 221	(50)
33.463 DFC T48	01.94-		 3488 017 447	400 MFZ2/400X	enthält eine Kupplungsscheibe / This part number includes one clutch disc	(67)
33.463 DFK, DF-KI T48	01.94-		 1878 002 643 ▽	400 10 400WGTZ	Lose Kupplungsscheibe / Loose clutch disc	(41)
33.463 DFS, DFRS T48	01.94-	D2876LF02	 3151 262 031	KZISZ-5		
			 1878 002 023 △	400 8 400GTZ	In 3483/3488 enthalten / Contained in 3483, 3488	(32)
			 3189 600 009		Getr. / GBox: ZF Ecosplit-3 für Fahrzeuge mit Zweischeibenkupplung / for vehicles with double disc clutch	(77)
			3189 600 020		Getr. / GBox: ZF Ecosplit-3	
			3189 600 036		für Fahrzeuge mit Zweischeibenkupplung / for vehicles with double disc clutch	(77)
27.603 DFAS T72	01.96-	D2840LF20	 3488 017 447	400 MFZ2/400X	enthält eine Kupplungsscheibe / This part number includes one clutch disc	(67)
27.603 DFS T78	01.96-		 1878 002 643 ▽	400 10 400WGTZ	Lose Kupplungsscheibe / Loose clutch disc	(41)
33.603 DFAC T72	06.96-		 3151 262 031	KZISZ-5		
33.603 DFAS T72	06.96-		 1878 002 023 △	400 8 400GTZ	In 3483/3488 enthalten / Contained in 3483, 3488	(32)
33.603 DFC T78	06.96-		 3189 600 036		für Fahrzeuge mit Zweischeibenkupplung / for vehicles with double disc clutch	(77)
33.603 DFS, DFRS T78	06.96-					
33.604 DFAS T72	04.00-					
33.604 DFS T78	04.00-					
32.293 VFC T15	08.95-	D2865LF	 3400 122 301 ⊗ 3482 083 032 ⊗ 1878 080 034 ⊙ 3151 000 034	430 10 MFZ430 430WGTZ KZISZ-5	T15	
32.343 VFC T15	08.95-		 3482 114 031	430 GMFZ430N	T15 für Nebenantrieb / for PTO	(82)
			 1878 080 034	430 10 430WGTZ	T15 für Nebenantrieb / for PTO	(82)
			 3151 263 031	KZIZ-6	T15 für Nebenantrieb / for PTO	(82)
		D2865LF24, D2865LF21	 3189 600 020		Getr. / GBox: ZF Ecosplit-3	
32.343 VFK T15	08.95-	D2865LF	 3400 122 301 ⊗ 3482 083 032 ⊗ 1878 080 034 ⊙ 3151 000 034	430 10 MFZ430 430WGTZ KZISZ-5	T15	
			 3482 114 031	430 GMFZ430N	T15 für Nebenantrieb / for PTO	(82)
			 1878 080 034	430 10 430WGTZ	->02.1996 T15 für Nebenantrieb / for PTO	(82)
			 3151 263 031	KZIZ-6	T15 für Nebenantrieb / for PTO	(82)
		D2865LF21	 3189 600 020		Getr. / GBox: ZF Ecosplit-3	





















		CODE				
--	--	------	--	---	---	---



















MAN

F 2000		01.94 -					
32.403 VFC T45	08.95-	D2866LF20	 3400 122 201  3482 083 032  1878 004 832  3151 000 034	430 10 MFZ430 430WGTZ KZISZ-5	T45,46		
			 3482 114 031	430 GMFZ430N	T45,46 für Nebenantrieb / for PTO	(82)	
			 1878 080 034	430 10 430WGTZ	06.1996-> T45,46 für Nebenantrieb / for PTO	(82)	
			 3151 263 031	KZIZ-6	T45,46 für Nebenantrieb / for PTO	(82)	
			 3488 017 447	400 MFZ2/400X	Getr. / GBox: ZF Ecosplit-3 für Fahrzeuge mit Zweischeibenkupplung / for vehicles with double disc clutch enthält eine Kupplungsscheibe / This part number includes one clutch disc	(77) (67)	
			 1878 002 643	400 10 400WGTZ	Getr. / GBox: ZF Ecosplit-3 für Fahrzeuge mit Zweischeibenkupplung / for vehicles with double disc clutch	(77)	
			 3151 262 031	KZISZ-5	Getr. / GBox: ZF Ecosplit-3 für Fahrzeuge mit Zweischeibenkupplung / for vehicles with double disc clutch	(77)	
			 3189 600 020		Getr. / GBox: ZF Ecosplit-3		
			 3189 600 009		Getr. / GBox: ZF Ecosplit-3 für Fahrzeuge mit Zweischeibenkupplung / for vehicles with double disc clutch	(77)	
32.403 VFK T45	08.95-	D2866LF20	 3400 122 201  3482 083 032  1878 004 832  3151 000 034	430 10 MFZ430 430WGTZ KZISZ-5	T45,46		
			 3400 122 301  3482 083 032  1878 080 034  3151 000 034	430 10 MFZ430 430WGTZ KZISZ-5	06.1996-> T45,46		
			 3482 114 031	430 GMFZ430N	T45,46 für Nebenantrieb / for PTO	(82)	
			 1878 080 034	430 10 430WGTZ	06.1996-> T45,46 für Nebenantrieb / for PTO	(82)	
			 3151 263 031	KZIZ-6	T45,46 für Nebenantrieb / for PTO	(82)	
			 3488 017 447	400 MFZ2/400X	Getr. / GBox: ZF Ecosplit-3 für Fahrzeuge mit Zweischeibenkupplung / for vehicles with double disc clutch enthält eine Kupplungsscheibe / This part number includes one clutch disc	(77) (67)	
			 1878 002 643	400 10 400WGTZ	Getr. / GBox: ZF Ecosplit-3 für Fahrzeuge mit Zweischeibenkupplung / for vehicles with double disc clutch	(77)	
			 3151 262 031	KZISZ-5	Getr. / GBox: ZF Ecosplit-3 für Fahrzeuge mit Zweischeibenkupplung / for vehicles with double disc clutch	(77)	
			 3189 600 009		Getr. / GBox: ZF Ecosplit-3 für Fahrzeuge mit Zweischeibenkupplung / for vehicles with double disc clutch	(77)	
 3189 600 020		Getr. / GBox: ZF Ecosplit-3					

		CODE				
--	--	------	--	---	---	---



















MAN

F 2000		01.94 -				
32.463 VFC T45 32.463 VFK T45	08.95-	D2876LF02	 3400 122 201 ⊗ 3482 083 032 ⊗ 1878 004 832 ⊙ 3151 000 034	430 10 MFZ430 430WGTZ KZISZ-5	T45,46	
	08.95-		 3482 114 031	430 GMFZ430N	T45,46 für Nebenantrieb / for PTO	(82)
			 1878 080 034	430 10 430WGTZ	06.1996-> T45,46 für Nebenantrieb / for PTO	(82)
			 3151 263 031	KZIZ-6	T45,46 für Nebenantrieb / for PTO	(82)
			 3488 017 447	400 MFZ2/400X	Getr. / GBox: ZF Ecosplit-3 für Fahrzeuge mit Zweischeibenkupplung / for vehicles with double disc clutch enthält eine Kupplungsscheibe / This part number includes one clutch disc	(77) (67)
			 1878 002 643	400 10 400WGTZ	Getr. / GBox: ZF Ecosplit-3 für Fahrzeuge mit Zweischeibenkupplung / for vehicles with double disc clutch	(77)
			 3151 262 031	KZISZ-5	Getr. / GBox: ZF Ecosplit-3 für Fahrzeuge mit Zweischeibenkupplung / for vehicles with double disc clutch	(77)
			 3189 600 020 3189 600 009		Getr. / GBox: ZF Ecosplit-3 für Fahrzeuge mit Zweischeibenkupplung / for vehicles with double disc clutch	(77)
33.323 DFAC T12 33.323 DFAK T12 33.323 DFAS T12 33.343 DFAC T12 33.343 DFAK T12 33.343 DFAS T12	01.94 - 12.95 01.94 - 12.95 01.94 - 12.95 01.94 - 01.94 - 01.94 -	D2865LF21, D2865LF23	 3400 122 301 ⊗ 3482 083 032 ⊗ 1878 080 034 ⊙ 3151 000 034	430 10 MFZ430 430WGTZ KZISZ-5		
			 3189 600 020		Getr. / GBox: ZF Ecosplit-3	
33.323 DFC T18 33.323 DFK T18 33.323 DFS T18 33.343 DFC T18 33.343 DFK T18 33.343 DFS T18	01.94 - 12.95 01.94 - 12.95 01.94 - 12.95 01.94 - 01.94 - 01.94 -	D2865LF23	 3482 114 031	430 GMFZ430N	für Nebenantrieb / for PTO	(82)
			 1878 080 034	430 10 430WGTZ	für Nebenantrieb / for PTO	(82)
			 3151 263 031	KZIZ-6	für Nebenantrieb / for PTO	(82)
		D2865LF21, D2865LF23	 3189 600 020		Getr. / GBox: ZF Ecosplit-3	
33.373 DFAC T42 33.373 DFAK, DFAK-HK, DFA- KI T42 33.373 DFAS T42 33.403 DFAC T42 33.403 DFAK, DFAK-HK, DFA- KI T42 33.403 DFAS T42 33.423 DFAC T42 33.423 DFAK, DFAK-HK, DFA- KI T42 33.423 DFAS T42	01.94 - 01.94 - 01.94 - 01.94 - 01.94 - 01.94 - 01.94 - 01.94 -	D2866	 3400 122 201 ⊗ 3482 083 032 ⊗ 1878 004 832 ⊙ 3151 000 034	430 10 MFZ430 430WGTZ KZISZ-5		
			 3400 700 327 ⊗ 3482 114 031 ⊗ 1878 004 832 ⊙ 3151 263 031	430 10 GMFZ430N 430WGTZ KZIZ-6	für Nebenantrieb / for PTO	(82)
			 3400 700 641 HD ⊗ 3482 114 031 ⊗ 1878 007 729 ⊙ 3151 263 031	430 10 GMFZ430N 430WGTZ KZIZ-6	Nebenantriebs-ID / PTO ID: NMV 221	(50)
		D2866LF21, D2866LF20, D2866LF22	 3483 000 509 ⊕	445 GMFZ445W	für Fahrzeuge mit Wandlerschaltkupplung / for vehicles with converter and clutch unit	(76)
			 1878 051 801	445 24 445GTZC	für Fahrzeuge mit Wandlerschaltkupplung / for vehicles with converter and clutch unit	(76)
			 3189 600 014		für Fahrzeuge mit Wandlerschaltkupplung / for vehicles with converter and clutch unit	(76)
			3189 600 020		Getr. / GBox: ZF Ecosplit-3	

F 2000		01.94 -					
33.373 DFC T48	01.94-	D2866LF21		3400 122 201 ⊗ 3482 083 032 ⊗ 1878 004 832 ⊙ 3151 000 034	430 10 MFZ430 430WGTZ KZISZ-5		
33.373 DFK, DF-KI T48	01.94-						
33.373 DFS, DFRS T48	01.94-			3400 700 327 ⊗ 3482 114 031 ⊗ 1878 004 832 ⊙ 3151 263 031	430 10 GMFZ430N 430WGTZ KZISZ-6	für Nebenantrieb / for PTO	(82)
				3400 700 641 HD ⊗ 3482 114 031 ⊗ 1878 007 729 ⊙ 3151 263 031	430 10 GMFZ430N 430WGTZ KZISZ-6	Nebenantriebs-ID / PTO ID: NMV 221	(50)
				3488 017 447	400 MFZ2/400X	Getr. / GBox: ZF Ecosplit-3 für Fahrzeuge mit Zweischeibenkupplung / for vehicles with double disc clutch enthält eine Kupplungsscheibe / This part number includes one clutch disc	(77) (67)
				1878 002 643	400 10 400WGTZ	Getr. / GBox: ZF Ecosplit-3 für Fahrzeuge mit Zweischeibenkupplung / for vehicles with double disc clutch	(77)
				3151 262 031	KZISZ-5	Getr. / GBox: ZF Ecosplit-3 für Fahrzeuge mit Zweischeibenkupplung / for vehicles with double disc clutch	(77)
				3189 600 020 3189 600 009		Getr. / GBox: ZF Ecosplit-3 für Fahrzeuge mit Zweischeibenkupplung / for vehicles with double disc clutch	(77)
35.314 VF (FE310A) T46	06.98-	D2876LF03, D2866LF20, D2866LF34, D2876LF02, D2866LF31, D2866LF35		3400 122 201 ⊗ 3482 083 032 ⊗ 1878 004 832 ⊙ 3151 000 034	430 10 MFZ430 430WGTZ KZISZ-5		
35.364 VF. (FE360A) T46	06.98-						
35.403 VF, VFC, VFRC T46	08.95-			3400 700 327 ⊗ 3482 114 031 ⊗ 1878 004 832 ⊙ 3151 263 031	430 10 GMFZ430N 430WGTZ KZISZ-6	für Nebenantrieb / for PTO	(82)
35.403 VFK, VF-HK, VF-KI T46	03.02-						
35.414 VF. (FE410A) T46	06.98-			3400 700 641 HD ⊗ 3482 114 031 ⊗ 1878 007 729 ⊙ 3151 263 031	430 10 GMFZ430N 430WGTZ KZISZ-6	Nebenantriebs-ID / PTO ID: NMV 221	(50)
35.463 VF, VFC, VFRC T46	08.95-			3488 017 447	400 MFZ2/400X	Getr. / GBox: ZF Ecosplit-3 für Fahrzeuge mit Zweischeibenkupplung / for vehicles with double disc clutch enthält eine Kupplungsscheibe / This part number includes one clutch disc	(77) (67)
35.463 VFK, VF-HK, VF-KI T46	08.95-						
35.464 VF. (FE460A) T46	06.98-			1878 002 643	400 10 400WGTZ	Getr. / GBox: ZF Ecosplit-3 für Fahrzeuge mit Zweischeibenkupplung / for vehicles with double disc clutch	(77)
41.364 VF. (FE360A) T46	06.98-						
41.403 VF, VFC, VFRC T46	08.95-			3151 262 031	KZISZ-5	Getr. / GBox: ZF Ecosplit-3 für Fahrzeuge mit Zweischeibenkupplung / for vehicles with double disc clutch	(77)
41.403 VFK, VF-HK, VF-KI T46	08.95-						
41.414 VF. (FE410A) T46	06.98-			3189 600 036 3189 600 009		für Fahrzeuge mit Zweischeibenkupplung / for vehicles with double disc clutch Getr. / GBox: ZF Ecosplit-3 für Fahrzeuge mit Zweischeibenkupplung / for vehicles with double disc clutch	(77) (77)
41.463 VF, VFC, VFRC T46	08.95-						
41.463 VFK, VF-HK, VF-KI T46	08.95-			3189 600 020		Getr. / GBox: ZF Ecosplit-3	
35.343 VFC T16	08.95-	D2865LF		3400 122 301 ⊗ 3482 083 032 ⊗ 1878 080 034 ⊙ 3151 000 034	430 10 MFZ430 430WGTZ KZISZ-5	T15,16	
35.343 VFK T16	08.95-						
				3482 114 031	430 GMFZ430N	T15,16 für Nebenantrieb / for PTO	(82)
				1878 080 034	430 10 430WGTZ	T15,16 für Nebenantrieb / for PTO	(82)
				3151 263 031	KZISZ-6	T15,16 für Nebenantrieb / for PTO	(82)
		D2865LF21		3189 600 020		Getr. / GBox: ZF Ecosplit-3	











































		CODE				
--	--	------	--	---	---	---

MAN

F 2000		01.94 -				
35.364 VFAK E68 35.414 VFAK E68 35.464 VFAK E68 41.364 VFAK E68 41.414 VFAK E68 41.464 VFAK E68 50.414 VFK/VFAK E68 50.464 VFK/VFAK E68		D2876LF03, D2866LF24, D2866LF25	 3400 122 201 ⊗ 3482 083 032 ⊗ 1878 004 832 ⊙ 3151 000 034	430 10 MFZ430 430WGTZ KZISZ-5	Getr. / GBox: ZF / Eaton	
			 3488 017 447	400 MFZ2/400X	Getr. / GBox: ZF / Eaton für Fahrzeuge mit Zweischeibenkupplung / for vehicles with double disc clutch enthält eine Kupplungsscheibe / This part number includes one clutch disc	(77)
			 1878 002 643	400 10 400WGTZ	Getr. / GBox: ZF / Eaton für Fahrzeuge mit Zweischeibenkupplung / for vehicles with double disc clutch	(77)
			 3151 262 031	KZISZ-5	Getr. / GBox: ZF / Eaton für Fahrzeuge mit Zweischeibenkupplung / for vehicles with double disc clutch	(77)
			 3483 000 509 ⊕	445 GMFZ445W	für Fahrzeuge mit Wandlerschaltkupplung / for vehicles with converter and clutch unit	(76)
			 1878 051 801	445 24 445GTZC	für Fahrzeuge mit Wandlerschaltkupplung / for vehicles with converter and clutch unit	(76)
			 3488 017 447	400 MFZ2/400X	Getr. / GBox: ZF Ecosplit-3 für Fahrzeuge mit Zweischeibenkupplung / for vehicles with double disc clutch enthält eine Kupplungsscheibe / This part number includes one clutch disc	(77) (67)
			 1878 002 643	400 10 400WGTZ	Getr. / GBox: ZF Ecosplit-3 für Fahrzeuge mit Zweischeibenkupplung / for vehicles with double disc clutch	(77)
			 3151 262 031	KZISZ-5	Getr. / GBox: ZF Ecosplit-3 für Fahrzeuge mit Zweischeibenkupplung / for vehicles with double disc clutch	(77)
			 3189 600 036		für Fahrzeuge mit Zweischeibenkupplung / for vehicles with double disc clutch	(77)
			3189 600 009		Getr. / GBox: ZF Ecosplit-3 für Fahrzeuge mit Zweischeibenkupplung / for vehicles with double disc clutch	(77)
			3189 600 014		für Fahrzeuge mit Wandlerschaltkupplung / for vehicles with converter and clutch unit	(76)
			3189 600 020		Getr. / GBox: ZF Ecosplit-3	
			35.604 E94	08.98 - 03.04	D2840LF21	 3483 000 509 ⊕
40.604 E94	08.98 - 03.04	 1864 510 001	445 24 445ZC	für Fahrzeuge mit Wandlerschaltkupplung / for vehicles with converter and clutch unit Anzahl der Beläge / Number of pads: 13		(76) (3)
41.604 E95	02.97 - 03.04	 3189 600 014		für Fahrzeuge mit Wandlerschaltkupplung / for vehicles with converter and clutch unit		(76)
50.604 E98	03.99 - 04.03					
37.403 T45,46 37.463 T45,46		D2866LF20, D2876LF02	 3400 122 201 ⊗ 3482 083 032 ⊗ 1878 004 832 ⊙ 3151 000 034	430 10 MFZ430 430WGTZ KZISZ-5	01.1994 - 05.1996	
			 3400 122 301 ⊗ 3482 083 032 ⊗ 1878 080 034 ⊙ 3151 000 034	430 10 MFZ430 430WGTZ KZISZ-5	06.1996->	
			 3400 700 327 ⊗ 3482 114 031 ⊗ 1878 004 832 ⊙ 3151 263 031	430 10 GMFZ430N 430WGTZ KZISZ-6	01.1994-> für Nebenantrieb / for PTO	(82)
			 3400 700 641 HD ⊗ 3482 114 031 ⊗ 1878 007 729 ⊙ 3151 263 031	430 10 GMFZ430N 430WGTZ KZISZ-6	01.1994-> Nebenantriebs-ID / PTO ID: NMV 221	(50)
			 3189 600 020		Getr. / GBox: ZF Ecosplit-3	

		CODE				
--	--	------	--	---	---	---



















MAN

F 2000		01.94 -				
40.373 T43 40.403 T43 40.423 T43 40.463 T43		D2840	 3488 017 447	400 MFZ2/400X	enthält eine Kupplungsscheibe / This part number includes one clutch disc	(67)
			 1878 002 643 ▽	400 10 400WGTZ	Lose Kupplungsscheibe / Loose clutch disc	(41)
			 3151 262 031	KZISZ-5		
			 1878 002 023 △	400 8 400GTZ	In 3483/3488 enthalten / Contained in 3483, 3488	(32)
			 3400 700 327  3482 114 031  1878 004 832  3151 263 031	430 10 GMFZ430N 430WGTZ KZIZ-6	für Nebenantrieb / for PTO	(82)
			 3400 700 641 HD  3482 114 031  1878 007 729  3151 263 031	430 10 GMFZ430N 430WGTZ KZIZ-6	Nebenantriebs-ID / PTO ID: NMV 221	(50)
		 3488 017 447	400 MFZ2/400X	Getr. / GBox: ZF Ecosplit-3 für Fahrzeuge mit Zweischeibenkupplung / for vehicles with double disc clutch enthält eine Kupplungsscheibe / This part number includes one clutch disc	(77) (67)	
		 1878 002 643	400 10 400WGTZ	Getr. / GBox: ZF Ecosplit-3 für Fahrzeuge mit Zweischeibenkupplung / for vehicles with double disc clutch	(77)	
		 3151 262 031	KZISZ-5	Getr. / GBox: ZF Ecosplit-3 für Fahrzeuge mit Zweischeibenkupplung / for vehicles with double disc clutch	(77)	
		 3189 600 009		Getr. / GBox: ZF Ecosplit-3 für Fahrzeuge mit Zweischeibenkupplung / for vehicles with double disc clutch	(77)	
		3189 600 036	für Fahrzeuge mit Zweischeibenkupplung / for vehicles with double disc clutch	(77)		
40.463		D2876LF01	 3400 122 201  3482 083 032  1878 004 832  3151 000 034	430 10 MFZ430 430WGTZ KZISZ-5		
			 3189 600 020		Getr. / GBox: ZF Ecosplit-3	
41.343 VFC T16 41.343 VFK T16	08.95 - 08.95 -	D2865LF	 3400 122 301  3482 083 032  1878 080 034  3151 000 034	430 10 MFZ430 430WGTZ KZISZ-5	T16	
			 3482 114 031	430 GMFZ430N	T16 für Nebenantrieb / for PTO	(82)
	 1878 080 034		430 10 430WGTZ	T16 für Nebenantrieb / for PTO	(82)	
	 3151 263 031		KZIZ-6	T16 für Nebenantrieb / for PTO	(82)	
			D2865LF21	 3189 600 020		Getr. / GBox: ZF Ecosplit-3
41.373 T45,46	01.94 -	D2866LF21	 3400 122 201  3482 083 032  1878 004 832  3151 000 034	430 10 MFZ430 430WGTZ KZISZ-5	->05.1996	
			 3400 700 327  3482 114 031  1878 004 832  3151 263 031	430 10 GMFZ430N 430WGTZ KZIZ-6	für Nebenantrieb / for PTO	(82)
			 3400 700 641 HD  3482 114 031  1878 007 729  3151 263 031	430 10 GMFZ430N 430WGTZ KZIZ-6	Nebenantriebs-ID / PTO ID: NMV 221	(50)
		 3189 600 020		Getr. / GBox: ZF Ecosplit-3		





		CODE		 Parameter		
--	--	------	--	---	---	---





MAN

F 2000 01.94 -

41.464 VF. (FE460A) T46	06.98-	D2876LF03	 3400 122 201  3482 083 032  1878 004 832  3151 000 034	430 10 MFZ430 430WGTZ KZISZ-5		
			 3400 700 327  3482 114 031  1878 004 832  3151 263 031	430 10 GMFZ430N 430WGTZ KZIZ-6	für Nebenantrieb / for PTO	(82)
			 3400 700 641 HD  3482 114 031  1878 007 729  3151 263 031	430 10 GMFZ430N 430WGTZ KZIZ-6	Nebenantriebs-ID / PTO ID: NMV 221	(50)
			 3483 000 509 ⊕	445 GMFZ445W	E75 für Fahrzeuge mit Wandlerschaltkupplung / for vehicles with converter and clutch unit	(76)
			 1878 051 801	445 24 445GTZC	E75 für Fahrzeuge mit Wandlerschaltkupplung / for vehicles with converter and clutch unit	(76)
			 3488 017 447	400 MFZ2/400X	Getr. / GBox: ZF Ecosplit-3 für Fahrzeuge mit Zweischeibenkupplung / for vehicles with double disc clutch enthält eine Kupplungsscheibe / This part number includes one clutch disc	(77) (67)
			 1878 002 643	400 10 400WGTZ	Getr. / GBox: ZF Ecosplit-3 für Fahrzeuge mit Zweischeibenkupplung / for vehicles with double disc clutch	(77)
			 3151 262 031	KZISZ-5	Getr. / GBox: ZF Ecosplit-3 für Fahrzeuge mit Zweischeibenkupplung / for vehicles with double disc clutch	(77)
			 3189 600 036		für Fahrzeuge mit Zweischeibenkupplung / for vehicles with double disc clutch	(77)
			3189 600 009		Getr. / GBox: ZF Ecosplit-3 für Fahrzeuge mit Zweischeibenkupplung / for vehicles with double disc clutch	(77)
			3189 600 014		für Fahrzeuge mit Wandlerschaltkupplung / for vehicles with converter and clutch unit	(76)
3189 600 020		Getr. / GBox: ZF Ecosplit-3				











F 90 06.86 - 12.97

16.242 F01,02,03 16.262 F01,02,03 16.272 F01,02,03 27.272 F05,06,07,08,09,10 28.272 F05-10,13,14 30.262 F13,14 30.272 F13,14 31.262 F13,14 31.272 F13,14 32.242 F09,10 36.262 F14 36.272 F14	01.85- 01.85-12.92 01.90- 01.90- 01.90- 01.89- 01.90- 01.89- 01.90- 01.87-12.92 01.88-12.93 01.88-12.93	D2866, D2865LF	 3400 700 310  3482 078 133  1862 364 133  3151 000 034	400 10 MFZ400 400WGVZ KZISZ-5	Nabenprofil / Hub Profile: 1 3/4"-10N	(48)
			 3189 600 020		Getr. / GBox: ZF Ecosplit-3	















F 90		06.86 - 12.97					
16.292 F01,02,03	01.85 - 12.92	D2866LF07, D2866LF03,		3400 127 601 ⊗ 3482 078 133 ⊗ 1862 364 031 ⊙ 3151 000 034	400 10 MFZ400 400WGVZ KZISZ-5	Nabenprofil / Hub Profile: 2"-10N Je nach Kundenwunsch mit unterschiedlicher Kupplung / Equipped with different clutch according to customer requirement	(48) (35)
16.332 F01,02,03	01.85 - 12.92	D2866LF05, D2866LF01, D2866LF08					
16.372 F01,02,03	01.90 -			3400 122 201 ⊗ 3482 083 032 ⊗ 1878 004 832 ⊙ 3151 000 034	430 10 MFZ430 430WGTZ KZISZ-5	Je nach Kundenwunsch mit unterschiedlicher Kupplung / Equipped with different clutch according to customer requirement	(35)
28.292 F09,13,14	01.86 -						
28.332 F09,13,14	01.86 -			3189 600 020		Getr. / GBox: ZF Ecosplit-3	
28.372 F09,13,14	01.90 -						
30.292 F13,14	01.87 -						
30.332 F13,14	01.87 -						
30.372 F13,14	01.90 -						
31.292 F13,14	01.87 -						
31.332 F13,14	01.87 -						
31.372 F13,14	01.90 -						
32.292 F09,10,13,14	01.85 -						
36.292 F14	01.88 - 12.93						
36.332 F14	01.88 - 12.93						
38.292 F17	01.85 -						
38.332 F17	01.85 -						
16.302 F01,02,03	01.90 - 12.92	D2866LF/290, D2865LF03,		3400 127 601 ⊗ 3482 078 133 ⊗ 1862 364 031 ⊙ 3151 000 034	400 10 MFZ400 400WGVZ KZISZ-5	Nabenprofil / Hub Profile: 2"-10N	(48)
16.322 F01,02,03,U11	01.90 -	D2865LF06, D2866LF03, D2866LF04, D2866LF08					
23.372 F20	- 06.93			3189 600 020		Getr. / GBox: ZF Ecosplit-3	
24.372 F20	01.92 - 06.93						
26.332 F19	01.91 -						
28.302 F09,13,14	01.90 -						
28.322 F09,13,14	01.90 -						
30.302 F13,14	01.90 -						
30.322 F13,14	01.90 -						
31.302 F13,14	01.90 -						
31.322 F13,14	01.90 -						
38.302 F17	01.89 -						
48.292 VF F15	07.89 - 02.90						
48.292 VFA F15	07.89 - 02.90						
48.292 VFAK F15	07.89 - 02.90						

		CODE				
--	--	------	--	---	---	---

MAN



























F 90		06.86 - 12.97												
16.342 F01,02,03	01.94-	D2865LF, D2865LF21		3400 122 301  3482 083 032  1878 080 034  3151 000 034	430 10 MFZ430 430WGTZ KZISZ-5									
23.342 F20	01.94-													
24.342 F20	01.94-							3189 600 020		Getr. / GBox: ZF Ecosplit-3				
28.342 F14	01.88-													
31.342 F14	01.94-													
32.342 F14	01.94-													
16.362 F01,02,03,U11,13	01.85- 12.92	D2866KF, D2866, D2866LF03, D2866LF, D2865LF, D2866LXF, D2866LF/330, D2866LF06, D2866LF09		3400 122 201  3482 083 032  1878 004 832  3151 000 034	430 10 MFZ430 430WGTZ KZISZ-5									
16.402 F01,02,03	01.94-							3189 600 020		Getr. / GBox: ZF Ecosplit-3				
16.422 F01,02,03,U11	01.90-													
19.432	01.94-													
23.372 F20	01.88-													
23.422 F20	01.92-													
24.372 F20	07.93-													
27.422 F09,10	01.90-													
28.402 F14	01.88-													
28.422 F09,13,14	01.90-													
30.362 F13,14	01.87-													
30.422 F13,14	01.90-													
31.362 F13,14	01.87-													
31.402 F14	01.94-													
31.422 F13,14	01.90-													
35.362 F14	01.88- 12.93													
38.362 F17	01.89-													
38.422 F17	01.89-													
48.332 VF F15	07.89- 02.90													
48.332 VFA F15	07.89- 02.90													
48.332 VFAK F15	07.89- 02.90													
48.362 VF F15	07.89- 02.90													
48.362 VFA F15	07.89- 02.90													
48.362 VFAK F15	07.89- 02.90													























MAN

F 90		06.86 - 12.97					
17.462 F21,22	01.89 -	D2840LF04, D2866, D2840LF01, D2866LF06, D2840LF, D2866LF09	 3400 121 901 ⊗ 3488 017 333 ⊗ 1862 303 031 ⊙ 3151 000 034	400 10 MFZ2/400X 400WGVZ KZISZ-5	für Fahrzeuge mit Zweischeibenkupplung / for vehicles with double disc clutch Je nach Kundenwunsch mit unterschiedlicher Kupplung / Equipped with different clutch according to customer requirement	(77)	
17.502 F21,22			 3400 122 201 ⊗ 3482 083 032 ⊗ 1878 004 832 ⊙ 3151 000 034	430 10 MFZ430 430WGTZ KZISZ-5	Je nach Kundenwunsch mit unterschiedlicher Kupplung / Equipped with different clutch according to customer requirement	(35)	
19.462 F21,22			01.86 - 12.92	 3189 600 020		Getr. / GBox: ZF Ecosplit-3	
22.362 F05,06,07,08,16							
22.422 F05,06,07,08,16			01.89 -				
22.462 F25,28			01.89 - 12.92				
22.502 F25,28,36			01.90 -				
25.362 F05,06,07,08,16			01.86 -				
25.462 F25,28			01.89 - 12.92				
32.462 F29,30			01.88 -				
32.502 F29,30	01.90 -						
19.242 F,19.242 FL,19.242 FLL F02 F03 F01	01.88 - 01.89	D2865LF02, D2865LF/260, D2866F/240, D2865LF05	 3400 127 601 ⊗ 3482 078 133 ⊗ 1862 364 031 ⊙ 3151 000 034	400 10 MFZ400 400WGVZ KZISZ-5	F01,02,03,04 Nabenprofil / Hub Profile: 2"-10N	(48)	
19.242 FK F01	01.88 - 02.89		 3400 700 310 ⊗ 3482 078 133 ⊗ 1862 364 133 ⊙ 3151 000 034	400 10 MFZ400 400WGVZ KZISZ-5	F01,02,03,04 Nabenprofil / Hub Profile: 1 3/4"-10N	(48)	
19.242 FS,19.242 FLS,19.242 FLLS F01 F02 F03	01.88 - 01.89		 1882 017 131	420 GF420XN	für Nebenantrieb / for PTO	(82)	
19.262 F,19.262 FL,19.262 FLL F02 F03 F01	01.88 - 02.90		 1878 086 941	420 10 420WGTZ	für Nebenantrieb / for PTO	(82)	
19.262 FA F04	02.89 - 02.90		 3189 600 020		Getr. / GBox: ZF Ecosplit-3		
19.262 FAK F04	02.89 - 02.90						
19.262 FAS F04	02.89 - 02.90						
19.262 FK F01	01.88 - 02.90						
19.262 FS,19.262 FLS,19.262 FLLS F01 F02 F03	01.88 - 02.90						
19.272 F,19.272 FL,19.272 FLL F01 F02 F03	02.90 - 05.95						
19.272 FA F04	02.90 - 05.95						
19.272 FAK F04	02.90 - 05.95						
19.272 FAS F04	02.90 - 05.95						
19.272 FK F01	02.90 - 05.95						
19.272 FS,19.272 FLS,19.272 FLLS F01 F03 F02	02.90 - 05.95						
19.292 F,19.292 FL,19.292 FLL F03 F01 F02	07.86 - 02.90	D2865LF, D2866LF07	 3400 127 601 ⊗ 3482 078 133 ⊗ 1862 364 031 ⊙ 3151 000 034	400 10 MFZ400 400WGVZ KZISZ-5	F01,02,03,04 Nabenprofil / Hub Profile: 2"-10N Je nach Kundenwunsch mit unterschiedlicher Kupplung / Equipped with different clutch according to customer requirement	(48) (35)	
19.292 FA F04	05.88 - 02.90		 3400 700 310 ⊗ 3482 078 133 ⊗ 1862 364 133 ⊙ 3151 000 034	400 10 MFZ400 400WGVZ KZISZ-5	F01,02,03,04 Nabenprofil / Hub Profile: 1 3/4"-10N	(48)	
19.292 FAK F04	05.88 - 02.90		 3400 122 201 ⊗ 3482 083 032 ⊗ 1878 004 832 ⊙ 3151 000 034	430 10 MFZ430 430WGTZ KZISZ-5	F01,02,03,04 Je nach Kundenwunsch mit unterschiedlicher Kupplung / Equipped with different clutch according to customer requirement	(35)	
19.292 FAS F04	05.88 - 02.90		 1882 017 131	420 GF420XN	für Nebenantrieb / for PTO	(82)	
19.292 FK F01	07.86 - 02.90		 1878 086 941	420 10 420WGTZ	für Nebenantrieb / for PTO	(82)	
19.292 FS,19.292 FLS,19.292 FLLS F01 F03 F02	07.86 - 02.90		 3189 600 020		Getr. / GBox: ZF Ecosplit-3		
			D2865, D2866				
			D2866LF/290				

		CODE				
--	--	------	--	---	---	---





























































MAN

F 90		06.86 - 12.97					
19.302 F01,02,03,04	01.90 - 12.92	D2866LF04	 3400 127 601 ⊗ 3482 078 133 ⊗ 1862 364 031 ⊙ 3151 000 034	400 10 MFZ400 400WGVZ KZISZ-5	Nabenprofil / Hub Profile: 2"-10N	(48)	
			 1882 017 131	420 GF420XN	Nebenantriebs-ID / PTO ID: 130E	(50)	
			 1878 086 941	420 10 420WGTZ	Nebenantriebs-ID / PTO ID: 130E	(50)	
			 3189 600 020		Getr. / GBox: ZF Ecosplit-3		
19.322 F,19.322 FL,19.322 FLL F01 F03 F02 19.322 FA F04 19.322 FAK F04 19.322 FAS F04 19.322 FK F01 19.322 FS,19.322 FLS,19.322 FLLS F01 F02 F03	02.90 - 05.95	D2865LF03, 06	 3400 127 601 ⊗ 3482 078 133 ⊗ 1862 364 031 ⊙ 3151 000 034	400 10 MFZ400 400WGVZ KZISZ-5	->07.1993 F01,02,03,04,U11 Nabenprofil / Hub Profile: 2"-10N	(48)	
	02.90 - 06.96		 3400 122 301 ⊗ 3482 083 032 ⊗ 1878 080 034 ⊙ 3151 000 034	430 10 MFZ430 430WGTZ KZISZ-5	08.1993-> F01,02,03,04,U11		
	02.90 - 06.96	D2865	 1882 017 131	420 GF420XN	für Nebenantrieb / for PTO	(82)	
	02.90 - 06.96		 1878 086 941	420 10 420WGTZ	für Nebenantrieb / for PTO	(82)	
	02.90 - 05.95	D2865LF03, D2865LF06	 3189 600 020		Getr. / GBox: ZF Ecosplit-3		
	02.90 - 05.95		 1882 017 131	420 GF420XN	für Nebenantrieb / for PTO	(82)	
19.332 F,19.332 FL,19.332 FLL F02 F03 F01 19.332 FA F04 19.332 FAK F04 19.332 FAS F04 19.332 FK F01 19.332 FS,19.332 FLS,19.332 FLLS F02 F03 F01	07.86 - 02.90	D2866LF08	 3400 127 601 ⊗ 3482 078 133 ⊗ 1862 364 031 ⊙ 3151 000 034	400 10 MFZ400 400WGVZ KZISZ-5	F01,02,03,04 Nabenprofil / Hub Profile: 2"-10N Je nach Kundenwunsch mit unterschiedlicher Kupplung / Equipped with different clutch according to customer requirement	(48) (35)	
	05.88 - 02.90		 3400 122 201 ⊗ 3482 083 032 ⊗ 1878 004 832 ⊙ 3151 000 034	430 10 MFZ430 430WGTZ KZISZ-5	F01,02,03,04 Je nach Kundenwunsch mit unterschiedlicher Kupplung / Equipped with different clutch according to customer requirement	(35)	
	05.88 - 02.90	D2866	 1882 017 131	420 GF420XN	für Nebenantrieb / for PTO	(82)	
	05.88 - 02.90		 1878 086 941	420 10 420WGTZ	für Nebenantrieb / for PTO	(82)	
	07.86 - 02.90	D2866LF/330	 3189 600 020		Getr. / GBox: ZF Ecosplit-3		
	07.86 - 02.90		 1882 017 131	420 GF420XN	für Nebenantrieb / for PTO	(82)	
19.342 F,19.342 FL,19.342 FLL F03 F02 F01 19.342 FA F04 19.342 FAK F04 19.342 FAS F04 19.342 FK F01 19.342 FS,19.342 FLS,19.342 FLLS F03 F02 F01	05.94 - 05.95	D2865LF09	 3400 122 301 ⊗ 3482 083 032 ⊗ 1878 080 034 ⊙ 3151 000 034	430 10 MFZ430 430WGTZ KZISZ-5	F01,02,03,04		
	05.94 - 06.96		 3189 600 020		Getr. / GBox: ZF Ecosplit-3		
	05.94 - 06.96	D2866	 1882 017 131	420 GF420XN	für Nebenantrieb / for PTO	(82)	
	05.94 - 05.95		 1878 086 941	420 10 420WGTZ	für Nebenantrieb / for PTO	(82)	
	05.94 - 05.95	D2866LF/330	 3189 600 020		Getr. / GBox: ZF Ecosplit-3		
19.362 F,19.362 FL,19.362 FLL F02 F03 F01 19.362 FA F04 19.362 FAK F04 19.362 FAS F04	07.86 - 02.90	D2865LF	 3400 127 601 ⊗ 3482 078 133 ⊗ 1862 364 031 ⊙ 3151 000 034	400 10 MFZ400 400WGVZ KZISZ-5	F01,02,03,04 Nabenprofil / Hub Profile: 2"-10N	(48)	
	05.88 - 02.90		 3400 700 310 ⊗ 3482 078 133 ⊗ 1862 364 133 ⊙ 3151 000 034	400 10 MFZ400 400WGVZ KZISZ-5	F01,02,03,04 Nabenprofil / Hub Profile: 1 3/4"-10N	(48)	
	05.88 - 02.90	D2866KF	 3400 122 201 ⊗ 3482 083 032 ⊗ 1878 004 832 ⊙ 3151 000 034	430 10 MFZ430 430WGTZ KZISZ-5	F01,02,03,04		
	05.88 - 02.90		 1882 017 131	420 GF420XN	für Nebenantrieb / for PTO	(82)	
	05.88 - 02.90	D2865, D2866	 1878 086 941	420 10 420WGTZ	für Nebenantrieb / for PTO	(82)	
			 3189 600 020		Getr. / GBox: ZF Ecosplit-3		















F 90		06.86 - 12.97				
19.362 FK F01 19.362 FS,19.362 FLS,19.362 FLLS F03 F01 F02	07.86 - 02.90	D2866KF	 3400 122 201 ● 3482 083 032 ● 1878 004 832 ● 3151 000 034	430 10 MFZ430 430WGTZ KZISZ-5	F01,02,03,04	
	07.86 - 02.90	D2866	 1882 017 131	420 GF420XN	für Nebenantrieb / for PTO	(82)
			 1878 086 941	420 10 420WGTZ	für Nebenantrieb / for PTO	(82)
		D2866KF, D2866LXF	 3189 600 020		Getr. / GBox: ZF Ecosplit-3	
19.372 F,19.372 FL,19.372 FLL F03 F01 F02 19.372 FK F01 19.372 FS,19.372 FLS,19.372 FLLS F03 F01 F02 25.372 DF F08 25.372 DFK F08 25.372 DFS F08 25.372 FVLS F07	05.90 - 04.95	D2866LXF	 3400 127 601 ● 3482 078 133 ● 1862 364 031 ● 3151 000 034	400 10 MFZ400 400WGVZ KZISZ-5	Nabenprofil / Hub Profile: 2"-10N Je nach Kundenwunsch mit unterschiedlicher Kupplung / Equipped with different clutch according to customer requirement	(48) (35)
	05.90 - 04.95		 3400 122 201 ● 3482 083 032 ● 1878 004 832 ● 3151 000 034	430 10 MFZ430 430WGTZ KZISZ-5	Je nach Kundenwunsch mit unterschiedlicher Kupplung / Equipped with different clutch according to customer requirement	(35)
	09.90 - 12.92		 3400 121 901 ● 3488 017 333 ● 1862 303 031 ● 3151 000 034	400 10 MFZ2/400X 400WGVZ KZISZ-5	für Fahrzeuge mit Zweischeibenkupplung / for vehicles with double disc clutch Je nach Kundenwunsch mit unterschiedlicher Kupplung / Equipped with different clutch according to customer requirement	(77) (35)
	09.90 - 12.92		 1882 017 131	420 GF420XN	für Nebenantrieb / for PTO	(82)
	09.90 - 12.92		 1878 086 941	420 10 420WGTZ	für Nebenantrieb / for PTO	(82)
	09.90 - 10.93		 3151 204 001	KZI-6	für Nebenantrieb / for PTO mit Schmierrohranschluss / with lubrication pipe connection	(82) (91)
			 3189 600 020		Getr. / GBox: ZF Ecosplit-3	
19.372 F,19.372 FL,19.372 FLL F03 F01 F02 19.372 FA F04 19.372 FAK F04 19.372 FAS F04 19.372 FK F01 19.372 FS,19.372 FLS,19.372 FLLS F02 F01 F03	02.90 - 05.95	D2866LF03, D2866LF05, D2866LF15	 3400 127 601 ● 3482 078 133 ● 1862 364 031 ● 3151 000 034	400 10 MFZ400 400WGVZ KZISZ-5	F01,02,03,04 Nabenprofil / Hub Profile: 2"-10N Je nach Kundenwunsch mit unterschiedlicher Kupplung / Equipped with different clutch according to customer requirement	(48) (35)
	02.90 - 06.96		 3400 122 201 ● 3482 083 032 ● 1878 004 832 ● 3151 000 034	430 10 MFZ430 430WGTZ KZISZ-5	F01,02,03,04 Je nach Kundenwunsch mit unterschiedlicher Kupplung / Equipped with different clutch according to customer requirement	(35)
	02.90 - 05.95		 1882 017 131	420 GF420XN	für Nebenantrieb / for PTO	(82)
	02.90 - 05.95		 1878 086 941	420 10 420WGTZ	für Nebenantrieb / for PTO	(82)
			 3189 600 020		Getr. / GBox: ZF Ecosplit-3	
19.402 F,19.402 FL,19.402 FLL F01 F03 F02 19.402 FA F04 19.402 FAK F04 19.402 FAS F04 19.402 FK F01 19.402 FS,19.402 FLS,19.402 FLLS F01 F03 F02	05.94 - 05.95	D2866LF16	 3400 122 201 ● 3482 083 032 ● 1878 004 832 ● 3151 000 034	430 10 MFZ430 430WGTZ KZISZ-5	F01,02,03,04	
	05.94 - 06.96		 3189 600 020		Getr. / GBox: ZF Ecosplit-3	
19.422 F,19.422 FL,19.422 FLL F02 F03 F01 19.422 FA F04 19.422 FAK F04 19.422 FAS F04 19.422 FK F01 19.422 FS,19.422 FLS,19.422 FLLS F01 F02 F03	02.90 - 05.95	D2866LF06, D2866LF10, D2866LF09	 3400 122 201 ● 3482 083 032 ● 1878 004 832 ● 3151 000 034	430 10 MFZ430 430WGTZ KZISZ-5	F01,02,03,04,U11	
	02.90 - 06.96		 1882 017 131	420 GF420XN	für Nebenantrieb / for PTO	(82)
	02.90 - 06.96		 1878 086 941	420 10 420WGTZ	für Nebenantrieb / for PTO	(82)
	02.90 - 05.95		 3151 204 001	KZI-6	für Nebenantrieb / for PTO mit Schmierrohranschluss / with lubrication pipe connection	(82) (91)
	02.90 - 05.95		 3189 600 020		Getr. / GBox: ZF Ecosplit-3	

		CODE				
--	--	------	--	---	---	---

MAN















































F 90		06.86 - 12.97					
19.462 F,19.462 FL F01 F02 19.462 FK F01 19.462 FS,19.462 FLS F02 F01	05.87 - 02.90	D2840LF460	 3400 122 201  3482 083 032  1878 004 832  3151 000 034	430 10 MFZ430 430WGTZ KZISZ-5	-> 07.1989 F01,02		
	05.87 - 02.90		 3400 121 901  3488 017 333  1862 303 031  3151 000 034	400 10 MFZ2/400X 400WGVZ KZISZ-5	08.1989-> F01,02 für Fahrzeuge mit Zweischeibenkupplung / for vehicles with double disc clutch	(77)	
	05.87 - 02.90		 1882 017 131	420 GF420XN	für Nebenantrieb / for PTO	(82)	
			 1878 086 941	420 10 420WGTZ	für Nebenantrieb / for PTO	(82)	
			 3189 600 020		Getr. / GBox: ZF Ecosplit-3		
19.502 F,19.502 FL,19.502 FLL F21 F23 F22 19.502 FS,19.502 FLS,19.502 FLLS F21 F22 F23	02.90 - 06.96	D2840LF04, D2840LF01, D2840LF06	 3400 122 201  3482 083 032  1878 004 832  3151 000 034	430 10 MFZ430 430WGTZ KZISZ-5	F21,22 Je nach Kundenwunsch mit unterschiedlicher Kupplung / Equipped with different clutch according to customer requirement	(35)	
	02.90 - 06.96		 3400 121 901  3488 017 333  1862 303 031  3151 000 034	400 10 MFZ2/400X 400WGVZ KZISZ-5	F21,22 für Fahrzeuge mit Zweischeibenkupplung / for vehicles with double disc clutch Je nach Kundenwunsch mit unterschiedlicher Kupplung / Equipped with different clutch according to customer requirement	(77)	(35)
			 3189 600 020		Getr. / GBox: ZF Ecosplit-3		
22.242 F05,06,07,08,16 22.262 F05,06,07,08,16 22.272 F05,06,07,08,16 25.242 F05,06,07,08,16 25.262 F05,06,07,08,16	01.88 -	D2865LF, D2866LF	 3400 700 310  3482 078 133  1862 364 133  3151 000 034	400 10 MFZ400 400WGVZ KZISZ-5	Nabenprofil / Hub Profile: 1 3/4"-10N Je nach Kundenwunsch mit unterschiedlicher Kupplung / Equipped with different clutch according to customer requirement	(48)	(35)
	01.88 -		 3400 121 901  3488 017 333  1862 303 031  3151 000 034	400 10 MFZ2/400X 400WGVZ KZISZ-5	für Fahrzeuge mit Zweischeibenkupplung / for vehicles with double disc clutch Je nach Kundenwunsch mit unterschiedlicher Kupplung / Equipped with different clutch according to customer requirement	(77)	(35)
	01.90 -		 3189 600 020		Getr. / GBox: ZF Ecosplit-3		
	01.88 -						
	01.88 -						
22.292 F05,06,07,08,16 22.332 F05,06,07,08,16 22.372 F05,06,07,08,16 25.292 F05,06,07,08,16 25.332 F05,06,07,08,16	01.86 - 12.92	D2866LF07, D2866LF03, D2866LF05, D2866LF01, D2866LF08	 3400 127 601  3482 078 133  1862 364 031  3151 000 034	400 10 MFZ400 400WGVZ KZISZ-5	Nabenprofil / Hub Profile: 2"-10N Je nach Kundenwunsch mit unterschiedlicher Kupplung / Equipped with different clutch according to customer requirement	(48)	(35)
	01.86 -		 3400 122 201  3482 083 032  1878 004 832  3151 000 034	430 10 MFZ430 430WGTZ KZISZ-5	Je nach Kundenwunsch mit unterschiedlicher Kupplung / Equipped with different clutch according to customer requirement	(35)	
	01.89 -		 3400 121 901  3488 017 333  1862 303 031  3151 000 034	400 10 MFZ2/400X 400WGVZ KZISZ-5	für Fahrzeuge mit Zweischeibenkupplung / for vehicles with double disc clutch Je nach Kundenwunsch mit unterschiedlicher Kupplung / Equipped with different clutch according to customer requirement	(77)	(35)
	01.86 - 12.92		 3189 600 020		Getr. / GBox: ZF Ecosplit-3		
	01.86 -						
22.302 F05,06,07,08,16 22.322 F05,06,07,08,16	01.90 - 12.92	D2865LF03, D2865LF06, D2866LF04	 3400 127 601  3482 078 133  1862 364 031  3151 000 034	400 10 MFZ400 400WGVZ KZISZ-5	Nabenprofil / Hub Profile: 2"-10N Je nach Kundenwunsch mit unterschiedlicher Kupplung / Equipped with different clutch according to customer requirement	(48)	(35)
	01.89 -		 3400 121 901  3488 017 333  1862 303 031  3151 000 034	400 10 MFZ2/400X 400WGVZ KZISZ-5	für Fahrzeuge mit Zweischeibenkupplung / for vehicles with double disc clutch Je nach Kundenwunsch mit unterschiedlicher Kupplung / Equipped with different clutch according to customer requirement	(77)	(35)
			 3189 600 020		Getr. / GBox: ZF Ecosplit-3		
23.272 F20 23.322 F20		D2865LF02, D2865LF04, D2865LF03, D2865LF05	 3400 127 601  3482 078 133  1862 364 031  3151 000 034	400 10 MFZ400 400WGVZ KZISZ-5	01.1992 - 06.1993 Nabenprofil / Hub Profile: 2"-10N	(48)	
			 3400 122 301  3482 083 032  1878 080 034  3151 000 034	430 10 MFZ430 430WGTZ KZISZ-5	07.1993->		
			 3189 600 020		Getr. / GBox: ZF Ecosplit-3		

MAN













































F 90		06.86 - 12.97					
24.242 DF F08	01.88 - 07.89	D2865LF/260, D2866F/240	 3400 127 601 ⊗ 3482 078 133 ⊗ 1862 364 031 ⊙ 3151 000 034	400 10 MFZ400 400WGVZ KZISZ-5	F05,06,07,08,16 Nabenprofil / Hub Profile: 2"-10N Je nach Kundenwunsch mit unterschiedlicher Kupplung / Equipped with different clutch according to customer requirement	(48) (35)	
24.242 DFK F08	01.88 - 07.89		 3400 700 310 ⊗ 3482 078 133 ⊗ 1862 364 133 ⊙ 3151 000 034	400 10 MFZ400 400WGVZ KZISZ-5	F05,06,07,08,16 Nabenprofil / Hub Profile: 1 3/4"-10N	(48)	
24.242 DFS F08	01.88 - 07.89		 3400 121 901 ⊗ 3488 017 333 ⊗ 1862 303 031 ⊙ 3151 000 034	400 10 MFZ2/400X 400WGVZ KZISZ-5	F05,06,07,08,16 für Fahrzeuge mit Zweischeibenkupplung / for vehicles with double disc clutch Je nach Kundenwunsch mit unterschiedlicher Kupplung / Equipped with different clutch according to customer requirement	(77) (35)	
24.242 FNL,24.242 FNLL,24.242 FVL F07 F05 F06	01.88 - 02.90		 3189 600 020		Getr. / GBox: ZF Ecosplit-3		
24.242 FNL,24.242 FNLL,24.242 FVL F05 F06 F07	01.88 - 02.90						
24.262 DF F08	01.88 - 02.90						
24.262 DFK F08	01.88 - 02.90						
24.262 DFS,24.262 DFLS F16 F08	01.88 - 02.90						
24.262 FNL,24.262 FNLL,24.262 FVL F05 F07 F06	01.88 - 02.90						
24.262 FNL,24.262 FNLL,24.262 FVL F05 F06 F07	01.88 - 02.90						
24.272 DF F08	02.90 - 12.90	D2865LF02, D2865LF05	 3400 127 601 ⊗ 3482 078 133 ⊗ 1862 364 031 ⊙ 3151 000 034	400 10 MFZ400 400WGVZ KZISZ-5	F05,06,07,08,16 Nabenprofil / Hub Profile: 2"-10N Je nach Kundenwunsch mit unterschiedlicher Kupplung / Equipped with different clutch according to customer requirement	(48) (35)	
24.272 DFK F08	02.90 - 12.90		 3400 700 310 ⊗ 3482 078 133 ⊗ 1862 364 133 ⊙ 3151 000 034	400 10 MFZ400 400WGVZ KZISZ-5	F05,06,07,08,16 Nabenprofil / Hub Profile: 1 3/4"-10N	(48)	
24.272 DFS,24.272 DFLS F08 F16	02.90 - 04.95		 3400 121 901 ⊗ 3488 017 333 ⊗ 1862 303 031 ⊙ 3151 000 034	400 10 MFZ2/400X 400WGVZ KZISZ-5	F05,06,07,08,16 für Fahrzeuge mit Zweischeibenkupplung / for vehicles with double disc clutch Je nach Kundenwunsch mit unterschiedlicher Kupplung / Equipped with different clutch according to customer requirement	(77) (35)	
24.272 FNL,24.272 FNLL,24.272 FVL F19 F07 F05 F06 F18	02.90 - 05.95		 1882 017 131	420 GF420XN	07.1990-> für Nebenantrieb / for PTO	(82)	
24.272 FNL,24.272 FNLL,24.272 FVL F07 F19 F18 F05 F06	02.90 - 05.95		 1878 086 941	420 10 420WGTZ	07.1990-> für Nebenantrieb / for PTO	(82)	
24.272 FNLS,24.272 FVLS F05 F18 F07	02.90 - 05.95		 3151 204 001	KZI-6	07.1990-> für Nebenantrieb / for PTO mit Schmierrohranschluss / with lubrication pipe connection	(82) (91)	
			 3189 600 020		Getr. / GBox: ZF Ecosplit-3		
24.292 DF F08	04.87 - 02.90		D2866LF/290, D2866LF/330	 3400 127 601 ⊗ 3482 078 133 ⊗ 1862 364 031 ⊙ 3151 000 034	400 10 MFZ400 400WGVZ KZISZ-5	F05,06,07,08,16 Nabenprofil / Hub Profile: 2"-10N Je nach Kundenwunsch mit unterschiedlicher Kupplung / Equipped with different clutch according to customer requirement	(48) (35)
24.292 DFK F08	04.87 - 02.90			 3400 122 201 ⊗ 3482 083 032 ⊗ 1878 004 832 ⊙ 3151 000 034	430 10 MFZ430 430WGTZ KZISZ-5	F05,06,07,08,16 Je nach Kundenwunsch mit unterschiedlicher Kupplung / Equipped with different clutch according to customer requirement	(35)
24.292 DFS,24.292 DFLS F08 F16	04.87 - 02.90			 3400 121 901 ⊗ 3488 017 333 ⊗ 1862 303 031 ⊙ 3151 000 034	400 10 MFZ2/400X 400WGVZ KZISZ-5	F05,06,07,08,16 für Fahrzeuge mit Zweischeibenkupplung / for vehicles with double disc clutch Je nach Kundenwunsch mit unterschiedlicher Kupplung / Equipped with different clutch according to customer requirement	(77) (35)
24.292 FNL,24.292 FNLL,24.292 FVL F06 F05 F07	10.86 - 02.90	 3189 600 020			Getr. / GBox: ZF Ecosplit-3		
24.292 FNL,24.292 FNLL,24.292 FVL F07 F06 F05	10.86 - 02.90						
24.292 FNLS,24.292 FVLS F05 F07	10.86 - 02.90						
24.332 DF F08	04.87 - 02.90						
24.332 DFK F08	04.87 - 02.90						
24.332 DFS,24.332 DFLS F08 F16	04.87 - 02.90						
24.332 FNL,24.332 FNLL,24.332 FVL F05 F07 F06	10.86 - 02.90						
24.332 FNLS,24.332 FVLS F05 F07	10.86 - 02.90						

		CODE				
--	--	------	--	---	---	---







MAN

F 90		06.86 - 12.97					
24.302 DF F08 24.302 DFK F08 24.302 DFS,24.302 DFLS F08 F16 24.302 FNL,24.302 FNLL,24.302 FVL F05 F07 F06 24.302 FNL,24.302 FNLL,24.302 FVL F07 F06 F05	05.90 - 12.90	D2866LF04	 3400 127 601  3482 078 133  1862 364 031  3151 000 034	400 10 MFZ400 400WGVZ KZISZ-5	Nabenprofil / Hub Profile: 2"-10N	(48)	
	05.90 - 12.90		 3400 121 901  3488 017 333  1862 303 031  3151 000 034	400 10 MFZ2/400X 400WGVZ KZISZ-5	F05,06,07,08,16 für Fahrzeuge mit Zweischeibenkupplung / for vehicles with double disc clutch Je nach Kundenwunsch mit unterschiedlicher Kupplung / Equipped with different clutch according to customer requirement	(77)	
	05.90 - 04.95					(35)	
	05.90 - 10.90			 1882 017 131	420 GF420XN	07.1990-> für Nebenantrieb / for PTO	(82)
	05.90 - 10.90			 1878 086 941	420 10 420WGTZ	07.1990-> für Nebenantrieb / for PTO	(82)
				 3151 204 001	KZI-6	07.1990-> für Nebenantrieb / for PTO mit Schmierrohranschluss / with lubrication pipe connection	(82) (91)
				 3189 600 020		Getr. / GBox: ZF Ecosplit-3	
24.322 F20		D2865LF03, D2865LF06	 3400 127 601  3482 078 133  1862 364 031  3151 000 034	400 10 MFZ400 400WGVZ KZISZ-5	01.1992 - 06.1993 Nabenprofil / Hub Profile: 2"-10N Je nach Kundenwunsch mit unterschiedlicher Kupplung / Equipped with different clutch according to customer requirement	(48) (35)	
			 3400 121 901  3488 017 333  1862 303 031  3151 000 034	400 10 MFZ2/400X 400WGVZ KZISZ-5	01.1992 - 06.1993 für Fahrzeuge mit Zweischeibenkupplung / for vehicles with double disc clutch Je nach Kundenwunsch mit unterschiedlicher Kupplung / Equipped with different clutch according to customer requirement	(77) (35)	
			 3400 122 301  3482 083 032  1878 080 034  3151 000 034	430 10 MFZ430 430WGTZ KZISZ-5	07.1993->		
			 3189 600 020		Getr. / GBox: ZF Ecosplit-3		
24.322 DF F08 24.322 DFK F08 24.322 DFS,24.322 DFLS F16 F08 24.322 FNL,24.322 FNLL,24.322 FVL F19 F18 F05 F06 F07 24.322 FNL,24.322 FNLL,24.322 FVL F05 F18 F07 F19 F06 24.322 FNLS,24.322 FVLS F07 F05 F18 24.322 FNLS,24.322 FVLS F18 F05 F07	02.90 - 12.90	D2865LF03, D2865LF06	 3400 127 601  3482 078 133  1862 364 031  3151 000 034	400 10 MFZ400 400WGVZ KZISZ-5	F05,06,07,08,16 Nabenprofil / Hub Profile: 2"-10N Je nach Kundenwunsch mit unterschiedlicher Kupplung / Equipped with different clutch according to customer requirement	(48) (35)	
	02.90 - 12.90		 3400 121 901  3488 017 333  1862 303 031  3151 000 034	400 10 MFZ2/400X 400WGVZ KZISZ-5	F05,06,07,08,16 für Fahrzeuge mit Zweischeibenkupplung / for vehicles with double disc clutch Je nach Kundenwunsch mit unterschiedlicher Kupplung / Equipped with different clutch according to customer requirement	(77) (35)	
	02.90 - 12.90			 1882 017 131	420 GF420XN	07.1990-> für Nebenantrieb / for PTO	(82)
	02.90 - 05.95			 1878 086 941	420 10 420WGTZ	07.1990-> für Nebenantrieb / for PTO	(82)
	02.90 - 05.95			 3151 204 001	KZI-6	07.1990-> für Nebenantrieb / for PTO mit Schmierrohranschluss / with lubrication pipe connection	(82) (91)
	02.90 - 05.95			 3189 600 020		Getr. / GBox: ZF Ecosplit-3	
	02.90 - 05.95						
	02.90 - 05.95						
24.342 FNL,24.342 FNLL F19 F18	05.94 - 05.95	D2865LF09	 3400 122 301  3482 083 032  1878 080 034  3151 000 034	430 10 MFZ430 430WGTZ KZISZ-5			
			 3400 121 901  3488 017 333  1862 303 031  3151 000 034	400 10 MFZ2/400X 400WGVZ KZISZ-5	für Fahrzeuge mit Zweischeibenkupplung / for vehicles with double disc clutch	(77)	
			 3189 600 020		Getr. / GBox: ZF Ecosplit-3		















MAN

F 90		06.86 - 12.97						
24.362 DF F08 24.362 DFK F08 24.362 DFS,24.362 DFLS F08 F16 24.362 FNL,24.362 FNLL,24.362 FVL F05 F06 F07 24.362 FNL,24.362 FNLL,24.362 FVL F07 F05 F06 24.362 FNLS,24.362 FVLS F05 F07	04.87 - 02.90	D2866KF, KU, LXF		3400 122 201  3482 083 032  1878 004 832  3151 000 034	430 10 MFZ430 430WGTZ KZISZ-5	F05,06,07,08 Je nach Kundenwunsch mit unterschiedlicher Kupplung / Equipped with different clutch according to customer requirement	(35)	
	04.87 - 02.90			3400 121 901  3488 017 333  1862 303 031  3151 000 034	400 10 MFZ2/400X 400WGVZ KZISZ-5	F05,06,07,08 für Fahrzeuge mit Zweischeibenkupplung / for vehicles with double disc clutch Je nach Kundenwunsch mit unterschiedlicher Kupplung / Equipped with different clutch according to customer requirement	(77)	
	04.87 - 02.90	D2866		1882 017 131	420 GF420XN	für Nebenantrieb / for PTO	(82)	
	10.86 - 02.90			1878 086 941	420 10 420WGTZ	für Nebenantrieb / for PTO	(82)	
	10.86 - 02.90			3151 204 001	KZI-6	für Nebenantrieb / for PTO mit Schmierrohranschluss / with lubrication pipe connection	(82) (91)	
	10.86 - 02.90			3189 600 020		Getr. / GBox: ZF Ecosplit-3		
	24.372 DF F08 24.372 DFK F08 24.372 DFS F08 24.372 FNL,24.372 FNLL,24.372 FVL F19 F06 F07 F05 F18 24.372 FNLS,24.372 FVLS F05 F07 F18 24.372 FVL F07 24.372 FVLS F07	05.90 - 12.90	D2866LF03, D2866LXF, D2866LF15		3400 127 601  3482 078 133  1862 364 031  3151 000 034	400 10 MFZ400 400WGVZ KZISZ-5	Nabenprofil / Hub Profile: 2"-10N Je nach Kundenwunsch mit unterschiedlicher Kupplung / Equipped with different clutch according to customer requirement	(48) (35)
		05.90 - 12.90			3400 122 201  3482 083 032  1878 004 832  3151 000 034	430 10 MFZ430 430WGTZ KZISZ-5	Je nach Kundenwunsch mit unterschiedlicher Kupplung / Equipped with different clutch according to customer requirement	(35)
		05.90 - 12.90	D2866		3400 121 901  3488 017 333  1862 303 031  3151 000 034	400 10 MFZ2/400X 400WGVZ KZISZ-5	für Fahrzeuge mit Zweischeibenkupplung / for vehicles with double disc clutch Je nach Kundenwunsch mit unterschiedlicher Kupplung / Equipped with different clutch according to customer requirement	(77) (35)
		02.90 - 05.95			1882 017 131	420 GF420XN	07.1990-> für Nebenantrieb / for PTO	(82)
02.90 - 05.95				1878 086 941	420 10 420WGTZ	07.1990-> für Nebenantrieb / for PTO	(82)	
05.90 - 12.90				3151 204 001	KZI-6	07.1990-> für Nebenantrieb / for PTO mit Schmierrohranschluss / with lubrication pipe connection	(82) (91)	
05.90 - 12.90			3189 600 020		Getr. / GBox: ZF Ecosplit-3			
24.372 DF F16 F08 24.372 DFS, 24.372 DFLS F16 F08		02.90 - 12.90	D2866LF01, 03, 05		3400 127 601  3482 078 133  1862 364 031  3151 000 034	400 10 MFZ400 400WGVZ KZISZ-5	F05,06,07,08,16 Nabenprofil / Hub Profile: 2"-10N Je nach Kundenwunsch mit unterschiedlicher Kupplung / Equipped with different clutch according to customer requirement	(48) (35)
		02.90 - 04.95			3400 122 201  3482 083 032  1878 004 832  3151 000 034	430 10 MFZ430 430WGTZ KZISZ-5	F05,06,07,08,16 Je nach Kundenwunsch mit unterschiedlicher Kupplung / Equipped with different clutch according to customer requirement	(35)
		02.90 - 04.95			3400 121 901  3488 017 333  1862 303 031  3151 000 034	400 10 MFZ2/400X 400WGVZ KZISZ-5	F05,06,07,08,16 für Fahrzeuge mit Zweischeibenkupplung / for vehicles with double disc clutch Je nach Kundenwunsch mit unterschiedlicher Kupplung / Equipped with different clutch according to customer requirement	(77) (35)
	D2866		1882 017 131	420 GF420XN	07.1990-> für Nebenantrieb / for PTO	(82)		
			1878 086 941	420 10 420WGTZ	07.1990-> für Nebenantrieb / for PTO	(82)		
			3151 204 001	KZI-6	07.1990-> für Nebenantrieb / for PTO mit Schmierrohranschluss / with lubrication pipe connection	(82) (91)		
			3189 600 020		Getr. / GBox: ZF Ecosplit-3			
	D2866LF03		3189 600 020		Getr. / GBox: ZF Ecosplit-3			

MAN

















F 90		06.86 - 12.97					
24.372 DFK F08	02.90 - 12.90	D2866LF/290, D2865LF03, D2866LF03, D2866LF05, D2865LF06, D2866LFZ/330,	 3400 127 601 ⊗ 3482 078 133 ⊗ 1862 364 031 ⊙ 3151 000 034	400 10 MFZ400 400WGVZ KZISZ-5	Nabenprofil / Hub Profile: 2"-10N Je nach Kundenwunsch mit unterschiedlicher Kupplung / Equipped with different clutch according to customer requirement	(48) (35)	
24.372 FNL,24.372 FNLL,24.372 FVL F18 F05 F06 F07 F19	02.90 - 05.95	D2866LF03, D2866LF05, D2865LF06, D2866LFZ/330,	 3400 122 201 ⊗ 3482 083 032 ⊗ 1878 004 832 ⊙ 3151 000 034	430 10 MFZ430 430WGTZ KZISZ-5	Je nach Kundenwunsch mit unterschiedlicher Kupplung / Equipped with different clutch according to customer requirement	(35)	
24.372 FNLS,24.372 FVLS F18 F07 F05	02.90 - 05.95	D2866LF16, D2866LXF, D2866LF15, D2866LF06, D2866LF04, D2865LF05,	 3400 121 901 ⊗ 3488 017 333 ⊗ 1862 303 031 ⊙ 3151 000 034	400 10 MFZ2/400X 400WGVZ KZISZ-5	für Fahrzeuge mit Zweischeibenkupplung / for vehicles with double disc clutch	(77)	
24.402 FNL,24.402 FNLL F18 F19	05.94 - 05.95	D2866LF15, D2866LF06, D2866LF04, D2865LF05, D2865LF09, D2866LF09	 3400 700 327 ⊗ 3482 114 031 ⊗ 1878 004 832 ⊙ 3151 263 031	430 10 GMFZ430N 430WGTZ KZISZ-6	Nebenantriebs-ID / PTO ID: NMV-221	(50)	
26.342 DF,26.342 DFL F08 F16	05.94 - 06.96		 3400 700 641 HD ⊗ 3482 114 031 ⊗ 1878 007 729 ⊙ 3151 263 031	430 10 GMFZ430N 430WGTZ KZISZ-6	Nebenantriebs-ID / PTO ID: NMV 221	(50)	
26.342 DFK,26.342 DFLK F16 F08	05.94 - 06.96		 3189 600 020		Getr. / GBox: ZF Ecosplit-3		
26.342 DFS F08	04.94 - 06.96						
26.402 DF,26.402 DFL F08 F16	05.94 - 06.96						
26.402 DFS F08	05.94 - 12.95						
26.402 FNL,26.402 FNLL,26.402 FVL F18 F19 F07	05.94 - 06.96						
26.402 FNL,26.402 FNLL,26.402 FVL F18 F07 F19	05.94 - 06.96						
26.402 FNLS,26.402 FVLS F07 F18	05.94 - 06.96						
32.292 VF F13	03.88 - 02.90						
32.292 VFK F13	03.88 - 02.90						
32.342 VFK F13	05.94 - 06.96						
32.372 VF F13	02.90 - 06.96						
32.372 VFK F13	05.90 - 04.95						
32.402 VFK F13	05.94 - 06.96						
33.272 DF F09	10.92 - 04.95						
33.272 DFA F10	10.92 - 04.95						
33.272 FVL F07	10.92 - 04.95						
33.322 DF F09	09.91 - 06.96						
33.322 FVL F07	09.91 - 06.96						
33.342 DF F09	05.94 - 06.96						
33.342 DFA F10	05.94 - 06.96						
33.372 DFK F09	01.91 - 06.96						
33.372 DFS F09	09.91 - 06.96						
33.402 DF F09	05.94 - 06.96						
33.402 DFA F10	05.94 - 06.96						
33.402 DFAK F10	05.94 - 06.96						
33.402 DFK F09	05.94 - 06.96						
33.402 DFS F09	05.94 - 06.96						
33.422 DF F09	09.91 - 06.96						
33.422 DFK F09	01.94 - 06.96						
33.422 DFS F09	01.94 - 06.96						

MAN









































F 90		06.86 - 12.97				
35.302 VFA E15 35.302 VFAK E15 35.332 VF F14 35.332 VFK F14 35.362 VF F14 35.362 VFK F14 35.372 VF F14 35.372 VFK F14	05.90 - 09.91	D2866LF/290, D2865LF03, D2866LF03, D2866LF05,	 3400 127 601 ● 3482 078 133 ● 1862 364 031 ● 3151 000 034	400 10 MFZ400 400WGVZ KZISZ-5	Nabenprofil / Hub Profile: 2"-10N Je nach Kundenwunsch mit unterschiedlicher Kupplung / Equipped with different clutch according to customer requirement	(48) (35)
	05.90 - 09.91	D2865LF06, D2866LFZ/330, D2866LF16, D2866LXF, D2866LF15,	 3400 122 201 ● 3482 083 032 ● 1878 004 832 ● 3151 000 034	430 10 MFZ430 430WGTZ KZISZ-5	Je nach Kundenwunsch mit unterschiedlicher Kupplung / Equipped with different clutch according to customer requirement	(35)
	10.88 - 04.95	D2866LF06, D2866LF04, D2865LF05, D2865LF09, D2866LF09	 3400 121 901 ● 3488 017 333 ● 1862 303 031 ● 3151 000 034	400 10 MFZ2/400X 400WGVZ KZISZ-5	für Fahrzeuge mit Zweischeibenkupplung / for vehicles with double disc clutch	(77)
	10.88 - 04.95		 3400 700 327 ● 3482 114 031 ● 1878 004 832 ● 3151 263 031	430 10 GMFZ430N 430WGTZ KZISZ-6	Nebenantriebs-ID / PTO ID: NMV-221	(50)
	10.88 - 02.90		 3400 700 641 HD ● 3482 114 031 ● 1878 007 729 ● 3151 263 031	430 10 GMFZ430N 430WGTZ KZISZ-6	Nebenantriebs-ID / PTO ID: NMV 221	(50)
	02.90 - 04.95		 3189 600 020		Getr. / GBox: ZF Ecosplit-3	
	02.90 - 04.95					
24.422 DF F08 24.422 DFK F08 24.422 DFS,24.422 DFSL F16 F08 24.422 FNL,24.422 FNLL,24.422 FVL F05 F19 F06 F18 F07 24.422 FNL,24.422 FNLL,24.422 FVL F07 F05 F06 F19 F18	02.90 - 12.90	D2866LF06, 09	 3400 122 201 ● 3482 083 032 ● 1878 004 832 ● 3151 000 034	430 10 MFZ430 430WGTZ KZISZ-5	F05,06,07,08,16 Je nach Kundenwunsch mit unterschiedlicher Kupplung / Equipped with different clutch according to customer requirement	(35)
	02.90 - 12.90		 3400 121 901 ● 3488 017 333 ● 1862 303 031 ● 3151 000 034	400 10 MFZ2/400X 400WGVZ KZISZ-5	F05,06,07,08,16 für Fahrzeuge mit Zweischeibenkupplung / for vehicles with double disc clutch	(77)
	02.90 - 12.90				Je nach Kundenwunsch mit unterschiedlicher Kupplung / Equipped with different clutch according to customer requirement	(35)
	02.90 - 05.95	D2866	 1882 017 131	420 GF420XN	07.1990-> für Nebenantrieb / for PTO	(82)
	02.90 - 05.95		 1878 086 941	420 10 420WGTZ	07.1990-> für Nebenantrieb / for PTO	(82)
	02.90 - 05.95		 3151 204 001	KZI-6	07.1990-> für Nebenantrieb / for PTO mit Schmierrohranschluss / with lubrication pipe connection	(82) (91)
	02.90 - 05.95		 3189 600 020		Getr. / GBox: ZF Ecosplit-3	
24.462 DF F28 24.462 DFS F28 24.462 FNL F25 24.502 DF F28 24.502 DFK F28 24.502 DFS F28 24.502 FNL F25 25.502 DF F28 25.502 DFS F28 25.502 FNL F25	02.89 - 02.90	D2840LF04, D2840LF460, D2840LF01	 3400 122 201 ● 3482 083 032 ● 1878 004 832 ● 3151 000 034	430 10 MFZ430 430WGTZ KZISZ-5	F25,28,36 Je nach Kundenwunsch mit unterschiedlicher Kupplung / Equipped with different clutch according to customer requirement	(35)
	02.89 - 02.90		 3400 121 901 ● 3488 017 333 ● 1862 303 031 ● 3151 000 034	400 10 MFZ2/400X 400WGVZ KZISZ-5	F25,28,36 für Fahrzeuge mit Zweischeibenkupplung / for vehicles with double disc clutch	(77)
	04.89 - 02.90				Je nach Kundenwunsch mit unterschiedlicher Kupplung / Equipped with different clutch according to customer requirement	(35)
	02.90 - 12.90					
	02.90 - 12.90					
	02.90 - 12.90					
	02.90 - 12.90					
	02.90 - 12.90					
	02.90 - 12.90					
	09.90 - 12.92					
09.90 - 12.92						

		CODE				
--	--	------	--	---	---	---

MAN

























F 90		06.86 - 12.97						
24.462 FVLS F07	05.87 - 07.87	D2840LF460	 3400 127 601 ⊗ 3482 078 133 ⊗ 1862 364 031 ⊙ 3151 000 034	400 10 MFZ400 400WGVZ KZISZ-5	F05,06,07,08,16 Nabenprofil / Hub Profile: 2"-10N Je nach Kundenwunsch mit unterschiedlicher Kupplung / Equipped with different clutch according to customer requirement	(48)	(35)	
			 3400 700 301 #⊕ ⊗ 3483 022 031 ⊗ 1862 349 031	400 10 MFZ400X 400GVZ	F05,06,07,08,16			
			 3400 121 901 ⊗ 3488 017 333 ⊗ 1862 303 031 ⊙ 3151 000 034	400 10 MFZ2/400X 400WGVZ KZISZ-5	F05,06,07,08,16 für Fahrzeuge mit Zweischeibenkupplung / for vehicles with double disc clutch Je nach Kundenwunsch mit unterschiedlicher Kupplung / Equipped with different clutch according to customer requirement	(77)	(35)	
			 3189 600 020		Getr. / GBox: ZF Ecosplit-3			
25.272 DF F08 25.272 DFK F08 25.272 DFS, 25.272 DFLS F16 F08 25.272 FNL, 25.272 FNLL, 25.272 FVL F05 F07 F06 25.272 FNL, 25.272 FNLL, 25.272 FVL F05 F06 F07	09.90 - 12.92	D2865LF01, 02, 04, 05	 3400 127 601 ⊗ 3482 078 133 ⊗ 1862 364 031 ⊙ 3151 000 034	400 10 MFZ400 400WGVZ KZISZ-5	F05,06,07,08,16 Nabenprofil / Hub Profile: 2"-10N Je nach Kundenwunsch mit unterschiedlicher Kupplung / Equipped with different clutch according to customer requirement	(48)	(35)	
			 3400 700 310 ⊗ 3482 078 133 ⊗ 1862 364 133 ⊙ 3151 000 034	400 10 MFZ400 400WGVZ KZISZ-5	F05,06,07,08,16 Nabenprofil / Hub Profile: 1 3/4"-10N	(48)		
	09.90 - 10.93	D2865	 3400 121 901 ⊗ 3488 017 333 ⊗ 1862 303 031 ⊙ 3151 000 034	400 10 MFZ2/400X 400WGVZ KZISZ-5	F05,06,07,08,16 für Fahrzeuge mit Zweischeibenkupplung / for vehicles with double disc clutch Je nach Kundenwunsch mit unterschiedlicher Kupplung / Equipped with different clutch according to customer requirement	(77)	(35)	
			 1882 017 131	420 GF420XN	für Nebenantrieb / for PTO	(82)		
	09.90 - 12.91	D2865LF02, D2865LF05	 1878 086 941	420 10 420WGTZ	für Nebenantrieb / for PTO	(82)		
			 3151 204 001	KZI-6	für Nebenantrieb / for PTO mit Schmierrohranschluss / with lubrication pipe connection	(82)	(91)	
			 3189 600 020		Getr. / GBox: ZF Ecosplit-3			
	25.302 DF F08 25.302 DFK F08 25.302 DFS, 25.302 DFLS F08 F16 25.302 FNL, 25.302 FNLL, 25.302 FVL F06 F05 25.302 FNLS, 25.302 FVLS F07 F05 25.302 FNLS, 25.302 FVLS F05 F07	09.90 - 12.91	D2866LF04	 3400 127 601 ⊗ 3482 078 133 ⊗ 1862 364 031 ⊙ 3151 000 034	400 10 MFZ400 400WGVZ KZISZ-5	F05,06,07,08,16 Nabenprofil / Hub Profile: 2"-10N Je nach Kundenwunsch mit unterschiedlicher Kupplung / Equipped with different clutch according to customer requirement	(48)	(35)
				 3400 121 901 ⊗ 3488 017 333 ⊗ 1862 303 031 ⊙ 3151 000 034	400 10 MFZ2/400X 400WGVZ KZISZ-5	F05,06,07,08,16 für Fahrzeuge mit Zweischeibenkupplung / for vehicles with double disc clutch Je nach Kundenwunsch mit unterschiedlicher Kupplung / Equipped with different clutch according to customer requirement	(77)	(35)
		09.90 - 12.91	D2866	 1882 017 131	420 GF420XN	für Nebenantrieb / for PTO	(82)	
 1878 086 941				420 10 420WGTZ	für Nebenantrieb / for PTO	(82)		
09.90 - 12.91		D2866	 3151 204 001	KZI-6	für Nebenantrieb / for PTO mit Schmierrohranschluss / with lubrication pipe connection	(82)	(91)	
			 3189 600 020		Getr. / GBox: ZF Ecosplit-3			

MAN





































F 90		06.86 - 12.97					
25.322 DF, 25.322 DFL F08 25.322 DFK F08 25.322 DFS, 25.322 DFLS F16 F08 25.322 FNL, 25.322 FNLL, 25.322 FVL F06 F05 25.322 FNLS, 25.322 FVLS F07 F05 25.322 FNLS, 25.322 FVLS F05 F07	09.90 - 12.92	D2865LF03, 06	 3400 127 601  3482 078 133  1862 364 031  3151 000 034	400 10 MFZ400 400WGVZ KZISZ-5	F05,06,07,08,16 Nabenprofil / Hub Profile: 2"-10N Je nach Kundenwunsch mit unterschiedlicher Kupplung / Equipped with different clutch according to customer requirement	(48) (35)	
	09.90 - 12.92		 3400 121 901  3488 017 333  1862 303 031  3151 000 034	400 10 MFZ2/400X 400WGVZ KZISZ-5	F05,06,07,08,16 für Fahrzeuge mit Zweischeibenkupplung / for vehicles with double disc clutch Je nach Kundenwunsch mit unterschiedlicher Kupplung / Equipped with different clutch according to customer requirement	(77) (35)	
	09.90 - 12.92	D2865	 1882 017 131	420 GF420XN	für Nebenantrieb / for PTO	(82)	
	09.90 - 12.92		 1878 086 941	420 10 420WGTZ	für Nebenantrieb / for PTO	(82)	
	09.90 - 12.92		 3151 204 001	KZI-6	für Nebenantrieb / for PTO mit Schmierrohranschluss / with lubrication pipe connection	(82) (91)	
	09.90 - 12.92	D2865LF03, D2865LF06	 3189 600 020		Getr. / GBox: ZF Ecosplit-3		
	25.372 DF F08 25.372 DFK F08 25.372 DFS, 25.372 DFLS F16 F08 25.372 FNL, 25.372 FNLL, 25.372 FVL F05 F06 25.372 FNLS, 25.372 FVLS F05 F07	09.90 - 12.92	D2866LF01, 03, 05	 3400 127 601  3482 078 133  1862 364 031  3151 000 034	400 10 MFZ400 400WGVZ KZISZ-5	F05,06,07,08,16 Nabenprofil / Hub Profile: 2"-10N Je nach Kundenwunsch mit unterschiedlicher Kupplung / Equipped with different clutch according to customer requirement	(48) (35)
		09.90 - 12.92		 3400 122 201  3482 083 032  1878 004 832  3151 000 034	430 10 MFZ430 430WGTZ KZISZ-5	F05,06,07,08,16 Je nach Kundenwunsch mit unterschiedlicher Kupplung / Equipped with different clutch according to customer requirement	(35)
		09.90 - 12.92		 3400 121 901  3488 017 333  1862 303 031  3151 000 034	400 10 MFZ2/400X 400WGVZ KZISZ-5	F05,06,07,08,16 für Fahrzeuge mit Zweischeibenkupplung / for vehicles with double disc clutch Je nach Kundenwunsch mit unterschiedlicher Kupplung / Equipped with different clutch according to customer requirement	(77) (35)
		09.90 - 10.93	D2866	 1882 017 131	420 GF420XN	für Nebenantrieb / for PTO	(82)
			 1878 086 941	420 10 420WGTZ	für Nebenantrieb / for PTO	(82)	
			 3151 204 001	KZI-6	für Nebenantrieb / for PTO mit Schmierrohranschluss / with lubrication pipe connection	(82) (91)	
			 3189 600 020		Getr. / GBox: ZF Ecosplit-3		
25.422 DF F08 25.422 DFK F08 25.422 DFS, 25.422 DFLS F08 F16 25.422 FNL, 25.422 FNLL F06 F05 25.422 FNLS, 25.422 FVLS F05 F07		09.90 - 12.92	D2866LF06, 09	 3400 122 201  3482 083 032  1878 004 832  3151 000 034	430 10 MFZ430 430WGTZ KZISZ-5	F05,06,07,08,16 Je nach Kundenwunsch mit unterschiedlicher Kupplung / Equipped with different clutch according to customer requirement	(35)
		09.90 - 12.92		 3400 121 901  3488 017 333  1862 303 031  3151 000 034	400 10 MFZ2/400X 400WGVZ KZISZ-5	F05,06,07,08,16 für Fahrzeuge mit Zweischeibenkupplung / for vehicles with double disc clutch Je nach Kundenwunsch mit unterschiedlicher Kupplung / Equipped with different clutch according to customer requirement	(77) (35)
		09.90 - 12.92	D2866	 1882 017 131	420 GF420XN	für Nebenantrieb / for PTO	(82)
	09.90 - 12.92		 1878 086 941	420 10 420WGTZ	für Nebenantrieb / for PTO	(82)	
	09.90 - 12.92		 3151 204 001	KZI-6	für Nebenantrieb / for PTO mit Schmierrohranschluss / with lubrication pipe connection	(82) (91)	
			 3189 600 020		Getr. / GBox: ZF Ecosplit-3		

		CODE				
--	--	------	--	---	---	---

MAN



































F 90		06.86 - 12.97					
26.242 DF F09 26.242 DFK F09 26.242 DFS F09	02.90 -	D2866F/240	 3400 127 601 ⊗ 3482 078 133 ⊗ 1862 364 031 ⊙ 3151 000 034	400 10 MFZ400 400WGVZ KZISZ-5	F05-10,16 Nabenprofil / Hub Profile: 2"-10N Je nach Kundenwunsch mit unterschiedlicher Kupplung / Equipped with different clutch according to customer requirement	(48)	(35)
	02.90 -		 3400 700 310 ⊗ 3482 078 133 ⊗ 1862 364 133 ⊙ 3151 000 034	400 10 MFZ400 400WGVZ KZISZ-5	F05-10,16 Nabenprofil / Hub Profile: 1 3/4"-10N	(48)	
	02.90 -		 3400 121 901 ⊗ 3488 017 333 ⊗ 1862 303 031 ⊙ 3151 000 034	400 10 MFZ2/400X 400WGVZ KZISZ-5	F05-10,16 für Fahrzeuge mit Zweischeibenkupplung / for vehicles with double disc clutch Je nach Kundenwunsch mit unterschiedlicher Kupplung / Equipped with different clutch according to customer requirement	(77)	(35)
			 3483 000 509 ⊕	445 GMFZ445W	für Fahrzeuge mit Wandlerschaltkupplung / for vehicles with converter and clutch unit	(76)	
			 1878 051 801	445 24 445GTZC	für Fahrzeuge mit Wandlerschaltkupplung / for vehicles with converter and clutch unit	(76)	
			 3189 600 020		Getr. / GBox: ZF Ecosplit-3		
			 3189 600 014		für Fahrzeuge mit Wandlerschaltkupplung / for vehicles with converter and clutch unit	(76)	
26.242 DFAK F10	01.90 - 01.90	D2866F/240	 3400 127 601 ⊗ 3482 078 133 ⊗ 1862 364 031 ⊙ 3151 000 034	400 10 MFZ400 400WGVZ KZISZ-5	F05-10,16 Nabenprofil / Hub Profile: 2"-10N Je nach Kundenwunsch mit unterschiedlicher Kupplung / Equipped with different clutch according to customer requirement	(48)	(35)
			 3400 700 310 ⊗ 3482 078 133 ⊗ 1862 364 133 ⊙ 3151 000 034	400 10 MFZ400 400WGVZ KZISZ-5	F05-10,16 Nabenprofil / Hub Profile: 1 3/4"-10N	(48)	
			 3400 121 901 ⊗ 3488 017 333 ⊗ 1862 303 031 ⊙ 3151 000 034	400 10 MFZ2/400X 400WGVZ KZISZ-5	F05-10,16 für Fahrzeuge mit Zweischeibenkupplung / for vehicles with double disc clutch Je nach Kundenwunsch mit unterschiedlicher Kupplung / Equipped with different clutch according to customer requirement	(77)	(35)
			 3483 000 510 ⊕	445 GMFZ445W	für Fahrzeuge mit Wandlerschaltkupplung / for vehicles with converter and clutch unit	(76)	
			 1878 051 801	445 24 445GTZC	für Fahrzeuge mit Wandlerschaltkupplung / for vehicles with converter and clutch unit	(76)	
			 3189 600 020		Getr. / GBox: ZF Ecosplit-3		
			 3189 600 014		für Fahrzeuge mit Wandlerschaltkupplung / for vehicles with converter and clutch unit	(76)	
26.262 DF F09 26.262 DFK F09 26.262 DFS F09	01.88 - 02.90	D2865LF/260	 3400 127 601 ⊗ 3482 078 133 ⊗ 1862 364 031 ⊙ 3151 000 034	400 10 MFZ400 400WGVZ KZISZ-5	F05-10,16 Nabenprofil / Hub Profile: 2"-10N Je nach Kundenwunsch mit unterschiedlicher Kupplung / Equipped with different clutch according to customer requirement	(48)	(35)
	01.88 - 02.90		 3400 700 310 ⊗ 3482 078 133 ⊗ 1862 364 133 ⊙ 3151 000 034	400 10 MFZ400 400WGVZ KZISZ-5	F05-10,16 Nabenprofil / Hub Profile: 1 3/4"-10N	(48)	
	01.88 - 02.90		 3400 121 901 ⊗ 3488 017 333 ⊗ 1862 303 031 ⊙ 3151 000 034	400 10 MFZ2/400X 400WGVZ KZISZ-5	F05-10,16 für Fahrzeuge mit Zweischeibenkupplung / for vehicles with double disc clutch Je nach Kundenwunsch mit unterschiedlicher Kupplung / Equipped with different clutch according to customer requirement	(77)	(35)
			 1882 017 131	420 GF420XN	F05-10,16 Nebenantriebs-ID / PTO ID: 130E	(50)	
			 1878 086 941	420 10 420WGTZ	F05-10,16 Nebenantriebs-ID / PTO ID: 130E	(50)	
			 3151 204 001	KZI-6	F05-10,16 mit Schmierrohranschluss / with lubrication pipe connection Nebenantriebs-ID / PTO ID: 130E	(91)	(50)
			 3483 000 509 ⊕	445 GMFZ445W	für Fahrzeuge mit Wandlerschaltkupplung / for vehicles with converter and clutch unit	(76)	
			 1878 051 801	445 24 445GTZC	für Fahrzeuge mit Wandlerschaltkupplung / for vehicles with converter and clutch unit	(76)	
			 3189 600 020		Getr. / GBox: ZF Ecosplit-3		
			 3189 600 014		für Fahrzeuge mit Wandlerschaltkupplung / for vehicles with converter and clutch unit	(76)	

MAN

















F 90		06.86 - 12.97					
26.262 DFA F10 26.262 DFAK F10 26.262 DFAS F10	02.89 - 02.90	D2865LF/260	 3400 127 601  3482 078 133  1862 364 031  3151 000 034	400 10 MFZ400 400WGVZ KZISZ-5	F05-10,16 Nabenprofil / Hub Profile: 2"-10N Je nach Kundenwunsch mit unterschiedlicher Kupplung / Equipped with different clutch according to customer requirement	(48) (35)	
	02.89 - 02.90		 3400 700 310  3482 078 133  1862 364 133  3151 000 034	400 10 MFZ400 400WGVZ KZISZ-5	F05-10,16 Nabenprofil / Hub Profile: 1 3/4"-10N	(48)	
	02.89 - 02.90		 3400 121 901  3488 017 333  1862 303 031  3151 000 034	400 10 MFZ2/400X 400WGVZ KZISZ-5	F05-10,16 für Fahrzeuge mit Zweischeibenkupplung / for vehicles with double disc clutch Je nach Kundenwunsch mit unterschiedlicher Kupplung / Equipped with different clutch according to customer requirement	(77) (35)	
			 1882 017 131	420 GF420XN	F05-10,16 Nebenantriebs-ID / PTO ID: 130E	(50)	
			 1878 086 941	420 10 420WGTZ	F05-10,16 Nebenantriebs-ID / PTO ID: 130E	(50)	
			 3151 204 001	KZI-6	F05-10,16 mit Schmierrohranschluss / with lubrication pipe connection Nebenantriebs-ID / PTO ID: 130E	(91) (50)	
			 3483 000 510 ⊕	445 GMFZ445W	für Fahrzeuge mit Wandlerschaltkupplung / for vehicles with converter and clutch unit	(76)	
			 1878 051 801	445 24 445GTZC	für Fahrzeuge mit Wandlerschaltkupplung / for vehicles with converter and clutch unit	(76)	
			 3189 600 020		Getr. / GBox: ZF Ecosplit-3		
	26.272 DF F08 F09 26.272 DFK F08 F09 26.272 DFS,26.272 DFLS F16 F08 F09		02.90 - 06.96	D2865LF01, 02, 04, 05	 3400 121 901  3488 017 333  1862 303 031  3151 000 034	400 10 MFZ2/400X 400WGVZ KZISZ-5	F05-10,16,18 für Fahrzeuge mit Zweischeibenkupplung / for vehicles with double disc clutch Je nach Kundenwunsch mit unterschiedlicher Kupplung / Equipped with different clutch according to customer requirement
02.90 - 06.96		 3400 127 601  3482 078 133  1862 364 031  3151 000 034	400 10 MFZ400 400WGVZ KZISZ-5		F05-10,16,18,19 Nabenprofil / Hub Profile: 2"-10N Je nach Kundenwunsch mit unterschiedlicher Kupplung / Equipped with different clutch according to customer requirement	(48) (35)	
02.90 - 06.96		 3400 700 310  3482 078 133  1862 364 133  3151 000 034	400 10 MFZ400 400WGVZ KZISZ-5		F05-10,16,18,19 Nabenprofil / Hub Profile: 1 3/4"-10N	(48)	
		 1882 017 131	420 GF420XN		für Nebenantrieb / for PTO	(82)	
		 1878 086 941	420 10 420WGTZ		für Nebenantrieb / for PTO	(82)	
		 3151 204 001	KZI-6		für Nebenantrieb / for PTO mit Schmierrohranschluss / with lubrication pipe connection	(82) (91)	
		 3483 000 509 ⊕	445 GMFZ445W		F09 für Fahrzeuge mit Wandlerschaltkupplung / for vehicles with converter and clutch unit	(76)	
		 1878 051 801	445 24 445GTZC		F09 für Fahrzeuge mit Wandlerschaltkupplung / for vehicles with converter and clutch unit	(76)	
		 3189 600 020			Getr. / GBox: ZF Ecosplit-3		
		 3189 600 014			für Fahrzeuge mit Wandlerschaltkupplung / for vehicles with converter and clutch unit	(76)	
			D2865				
			D2865LF02, D2865LF05				

		CODE		 Parameter	 i	
--	--	------	--	---	---	---

MAN





















F 90		06.86 - 12.97					
26.272 DFA F10 26.272 DFAK F10 26.272 DFAS F10	02.90 - 12.92	D2865LF01, 02, 04, 05	 3400 121 901  3488 017 333  1862 303 031  3151 000 034	400 10 MFZ2/400X 400WGVZ KZISZ-5	F05-10,16,18 für Fahrzeuge mit Zweischeibenkupplung / for vehicles with double disc clutch Je nach Kundenwunsch mit unterschiedlicher Kupplung / Equipped with different clutch according to customer requirement	(77) (35)	
	02.90 - 12.92		 3400 127 601  3482 078 133  1862 364 031  3151 000 034	400 10 MFZ400 400WGVZ KZISZ-5	F05-10,16,18,19 Nabenprofil / Hub Profile: 2"-10N Je nach Kundenwunsch mit unterschiedlicher Kupplung / Equipped with different clutch according to customer requirement	(48) (35)	
	02.90 - 12.92		 3400 700 310  3482 078 133  1862 364 133  3151 000 034	400 10 MFZ400 400WGVZ KZISZ-5	F05-10,16,18,19 Nabenprofil / Hub Profile: 1 3/4"-10N	(48)	
			D2865	 1882 017 131	420 GF420XN	für Nebenantrieb / for PTO	(82)
				 1878 086 941	420 10 420WGTZ	für Nebenantrieb / for PTO	(82)
				 3151 204 001	KZI-6	für Nebenantrieb / for PTO mit Schmierrohranschluss / with lubrication pipe connection	(82) (91)
			D2865LF02, D2865LF05	 3483 000 510 ⊕	445 GMFZ445W	für Fahrzeuge mit Wandlerschaltkupplung / for vehicles with converter and clutch unit	(76)
				 1878 051 801	445 24 445GTZC	für Fahrzeuge mit Wandlerschaltkupplung / for vehicles with converter and clutch unit	(76)
				 3189 600 020		Getr. / GBox: ZF Ecosplit-3	
	26.272 FNL,26.272 FNLL F19 F18 26.272 FNLS,26.272 FVLS F07 F18	03.91 - 05.95	D2865LF01, 02, 04, 05	 3400 121 901  3488 017 333  1862 303 031  3151 000 034	400 10 MFZ2/400X 400WGVZ KZISZ-5	F05-10,16,18 für Fahrzeuge mit Zweischeibenkupplung / for vehicles with double disc clutch Je nach Kundenwunsch mit unterschiedlicher Kupplung / Equipped with different clutch according to customer requirement	(77) (35)
09.90 - 12.95		 3400 127 601  3482 078 133  1862 364 031  3151 000 034		400 10 MFZ400 400WGVZ KZISZ-5	F05-10,16,18,19 Nabenprofil / Hub Profile: 2"-10N Je nach Kundenwunsch mit unterschiedlicher Kupplung / Equipped with different clutch according to customer requirement	(48) (35)	
		 3400 700 310  3482 078 133  1862 364 133  3151 000 034		400 10 MFZ400 400WGVZ KZISZ-5	F05-10,16,18,19 Nabenprofil / Hub Profile: 1 3/4"-10N	(48)	
			D2865	 1882 017 131	420 GF420XN	für Nebenantrieb / for PTO	(82)
				 1878 086 941	420 10 420WGTZ	für Nebenantrieb / for PTO	(82)
				 3151 204 001	KZI-6	für Nebenantrieb / for PTO mit Schmierrohranschluss / with lubrication pipe connection	(82) (91)
			D2865LF02, D2865LF05	 3189 600 020		Getr. / GBox: ZF Ecosplit-3	

MAN

F 90		06.86 - 12.97					
26.292 DF, 26.292 DFL F09 26.292 DFK F09 26.292 DFS F09	09.87 - 02.90	D2866LF07	 3400 127 601 ⊗ 3482 078 133 ⊗ 1862 364 031 ⊙ 3151 000 034	400 10 MFZ400 400WGVZ KZISZ-5	F05-10,16 Nabenprofil / Hub Profile: 2"-10N Je nach Kundenwunsch mit unterschiedlicher Kupplung / Equipped with different clutch according to customer requirement	(48) (35)	
	09.87 - 02.90		 3400 122 201 ⊗ 3482 083 032 ⊗ 1878 004 832 ⊙ 3151 000 034	430 10 MFZ430 430WGTZ KZISZ-5	F05-10,16 Je nach Kundenwunsch mit unterschiedlicher Kupplung / Equipped with different clutch according to customer requirement	(35)	
	09.87 - 02.90		 3400 121 901 ⊗ 3488 017 333 ⊗ 1862 303 031 ⊙ 3151 000 034	400 10 MFZ2/400X 400WGVZ KZISZ-5	F05-10,16 für Fahrzeuge mit Zweischeibenkupplung / for vehicles with double disc clutch Je nach Kundenwunsch mit unterschiedlicher Kupplung / Equipped with different clutch according to customer requirement	(77) (35)	
		D2866LF/290	 3483 000 509 ⊕	445 GMFZ445W	für Fahrzeuge mit Wandlerschaltkupplung / for vehicles with converter and clutch unit	(76)	
			 1878 051 801	445 24 445GTZC	für Fahrzeuge mit Wandlerschaltkupplung / for vehicles with converter and clutch unit	(76)	
			 3189 600 020		Getr. / GBox: ZF Ecosplit-3		
			 3189 600 014		für Fahrzeuge mit Wandlerschaltkupplung / for vehicles with converter and clutch unit	(76)	
		D2866	 1882 017 131	420 GF420XN	Nebenantriebs-ID / PTO ID: 130E	(50)	
			 1878 086 941	420 10 420WGTZ	Nebenantriebs-ID / PTO ID: 130E	(50)	
	26.292 DFA F10 26.292 DFAS F10	05.88 - 02.90	D2866LF/290	 3400 127 601 ⊗ 3482 078 133 ⊗ 1862 364 031 ⊙ 3151 000 034	400 10 MFZ400 400WGVZ KZISZ-5	F05-10,16 Nabenprofil / Hub Profile: 2"-10N Je nach Kundenwunsch mit unterschiedlicher Kupplung / Equipped with different clutch according to customer requirement	(48) (35)
05.88 - 02.90		 3400 122 201 ⊗ 3482 083 032 ⊗ 1878 004 832 ⊙ 3151 000 034		430 10 MFZ430 430WGTZ KZISZ-5	F05-10,16 Je nach Kundenwunsch mit unterschiedlicher Kupplung / Equipped with different clutch according to customer requirement	(35)	
		 3400 121 901 ⊗ 3488 017 333 ⊗ 1862 303 031 ⊙ 3151 000 034		400 10 MFZ2/400X 400WGVZ KZISZ-5	F05-10,16 für Fahrzeuge mit Zweischeibenkupplung / for vehicles with double disc clutch Je nach Kundenwunsch mit unterschiedlicher Kupplung / Equipped with different clutch according to customer requirement	(77) (35)	
		 3483 000 510 ⊕		445 GMFZ445W	für Fahrzeuge mit Wandlerschaltkupplung / for vehicles with converter and clutch unit	(76)	
		 1878 051 801		445 24 445GTZC	für Fahrzeuge mit Wandlerschaltkupplung / for vehicles with converter and clutch unit	(76)	
		 1882 017 131		420 GF420XN	Nebenantriebs-ID / PTO ID: 130E	(50)	
		 1878 086 941		420 10 420WGTZ	Nebenantriebs-ID / PTO ID: 130E	(50)	
		 3189 600 020			Getr. / GBox: ZF Ecosplit-3		









































		CODE				
--	--	------	--	---	---	---

MAN

F 90		06.86 - 12.97				
26.292 DFAK F10	05.88 - 02.90	D2866LF/290	 3400 127 601 ⊗ 3482 078 133 ⊗ 1862 364 031 ⊙ 3151 000 034	400 10 MFZ400 400WGVZ KZISZ-5	F05,06,07,08,16 Nabenprofil / Hub Profile: 2"-10N Je nach Kundenwunsch mit unterschiedlicher Kupplung / Equipped with different clutch according to customer requirement	(48) (35)
			 3400 700 310 ⊗ 3482 078 133 ⊗ 1862 364 133 ⊙ 3151 000 034	400 10 MFZ400 400WGVZ KZISZ-5	F05,06,07,08,16 Nabenprofil / Hub Profile: 1 3/4"-10N	(48)
			 3400 121 901 ⊗ 3488 017 333 ⊗ 1862 303 031 ⊙ 3151 000 034	400 10 MFZ2/400X 400WGVZ KZISZ-5	F05,06,07,08,16 für Fahrzeuge mit Zweischeibenkupplung / for vehicles with double disc clutch Je nach Kundenwunsch mit unterschiedlicher Kupplung / Equipped with different clutch according to customer requirement	(77) (35)
			 3400 122 201 ⊗ 3482 083 032 ⊗ 1878 004 832 ⊙ 3151 000 034	430 10 MFZ430 430WGTZ KZISZ-5	F05-10,16 Je nach Kundenwunsch mit unterschiedlicher Kupplung / Equipped with different clutch according to customer requirement	(35)
			 1882 017 131	420 GF420XN	für Nebenantrieb / for PTO	(82)
			 1878 086 941	420 10 420WGTZ	für Nebenantrieb / for PTO	(82)
			 3151 204 001	KZI-6	für Nebenantrieb / for PTO mit Schmierrohranschluss / with lubrication pipe connection	(82) (91)
			 3483 000 510 ⊕	445 GMFZ445W	für Fahrzeuge mit Wandlerschaltkupplung / for vehicles with converter and clutch unit	(76)
			 1878 051 801	445 24 445GTZC	für Fahrzeuge mit Wandlerschaltkupplung / for vehicles with converter and clutch unit	(76)
			 3189 600 020		Getr. / GBox: ZF Ecosplit-3	
26.302 DF F09 26.302 DFK F09 26.302 DFS F09 26.302 FNLS,26.302 FVLS F07 F18	05.90 - 12.91	D2866LF04	 3400 127 601 ⊗ 3482 078 133 ⊗ 1862 364 031 ⊙ 3151 000 034	400 10 MFZ400 400WGVZ KZISZ-5	F05-10,16,18,19 Nabenprofil / Hub Profile: 2"-10N Je nach Kundenwunsch mit unterschiedlicher Kupplung / Equipped with different clutch according to customer requirement	(48) (35)
			 3400 121 901 ⊗ 3488 017 333 ⊗ 1862 303 031 ⊙ 3151 000 034	400 10 MFZ2/400X 400WGVZ KZISZ-5	F05-10,16,18,19 für Fahrzeuge mit Zweischeibenkupplung / for vehicles with double disc clutch Je nach Kundenwunsch mit unterschiedlicher Kupplung / Equipped with different clutch according to customer requirement	(77) (35)
	05.90 - 12.91	D2866LF01, 02, 04, 05	 3483 000 509 ⊕	445 GMFZ445W	für Fahrzeuge mit Wandlerschaltkupplung / for vehicles with converter and clutch unit	(76)
			 1878 051 801	445 24 445GTZC	für Fahrzeuge mit Wandlerschaltkupplung / for vehicles with converter and clutch unit	(76)
	09.90 - 12.91	D2866	 3189 600 020		Getr. / GBox: ZF Ecosplit-3	
			 3189 600 014		für Fahrzeuge mit Wandlerschaltkupplung / for vehicles with converter and clutch unit	(76)
			 3400 700 310 ⊗ 3482 078 133 ⊗ 1862 364 133 ⊙ 3151 000 034	400 10 MFZ400 400WGVZ KZISZ-5	F05,06,07,08,16 Nabenprofil / Hub Profile: 1 3/4"-10N	(48)
			 1882 017 131	420 GF420XN	für Nebenantrieb / for PTO	(82)
			 1878 086 941	420 10 420WGTZ	für Nebenantrieb / for PTO	(82)
			 3151 204 001	KZI-6	für Nebenantrieb / for PTO mit Schmierrohranschluss / with lubrication pipe connection	(82) (91)



















































		CODE				
--	--	------	--	---	---	---

MAN

























F 90		06.86 - 12.97					
26.302 DFA F10 26.302 DFAK F10 26.302 DFAS F10 26.302 FNL, 26.302 FNLL, 26.302 FVL F18 F19 26.302 FNLS,26.302 FVLS F07 F18	05.90 - 12.91	D2866LF04		3400 127 601  3482 078 133  1862 364 031  3151 000 034	400 10 MFZ400 400WGVZ KZISZ-5	F05-10,16,18,19 Nabenprofil / Hub Profile: 2"-10N Je nach Kundenwunsch mit unterschiedlicher Kupplung / Equipped with different clutch according to customer requirement	(48) (35)
	05.90 - 12.91			3400 121 901  3488 017 333  1862 303 031  3151 000 034	400 10 MFZ2/400X 400WGVZ KZISZ-5	F05-10,16,18,19 für Fahrzeuge mit Zweischeibenkupplung / for vehicles with double disc clutch Je nach Kundenwunsch mit unterschiedlicher Kupplung / Equipped with different clutch according to customer requirement	(77) (35)
	05.90 - 12.91			3483 000 510 ⊕	445 GMFZ445W	für Fahrzeuge mit Wandlerschaltkupplung / for vehicles with converter and clutch unit	(76)
	03.91 - 12.91			1878 051 801	445 24 445GTZC	für Fahrzeuge mit Wandlerschaltkupplung / for vehicles with converter and clutch unit	(76)
	09.90 - 12.91			1882 017 131	420 GF420XN	für Nebenantrieb / for PTO	(82)
				1878 086 941	420 10 420WGTZ	für Nebenantrieb / for PTO	(82)
				3189 600 020		Getr. / GBox: ZF Ecosplit-3	
26.322 DF F08 F09 26.322 DFS,26.322 DFLS F09 F08 F16 26.322 FNLS,26.322 FVLS F18 F07	02.90 - 06.96	D2865LF03, 06		3400 127 601  3482 078 133  1862 364 031  3151 000 034	400 10 MFZ400 400WGVZ KZISZ-5	F05-10,16,18,19 Nabenprofil / Hub Profile: 2"-10N Je nach Kundenwunsch mit unterschiedlicher Kupplung / Equipped with different clutch according to customer requirement	(48) (35)
	02.90 - 06.96			3400 121 901  3488 017 333  1862 303 031  3151 000 034	400 10 MFZ2/400X 400WGVZ KZISZ-5	F05-10,16,18,19 für Fahrzeuge mit Zweischeibenkupplung / for vehicles with double disc clutch Je nach Kundenwunsch mit unterschiedlicher Kupplung / Equipped with different clutch according to customer requirement	(77) (35)
	09.90 - 12.95			1882 017 131	420 GF420XN	07.1990-> für Nebenantrieb / for PTO	(82)
				1878 086 941	420 10 420WGTZ	07.1990-> für Nebenantrieb / for PTO	(82)
				3483 000 509 ⊕	445 GMFZ445W	F09 für Fahrzeuge mit Wandlerschaltkupplung / for vehicles with converter and clutch unit	(76)
				1878 051 801	445 24 445GTZC	F09 für Fahrzeuge mit Wandlerschaltkupplung / for vehicles with converter and clutch unit	(76)
				3189 600 020		Getr. / GBox: ZF Ecosplit-3	
26.322 DFA F10 26.322 DFAK F10 26.322 DFAS F10	02.90 - 12.92	D2865LF03, 06		3400 127 601  3482 078 133  1862 364 031  3151 000 034	400 10 MFZ400 400WGVZ KZISZ-5	F05-10,16,18,19 Nabenprofil / Hub Profile: 2"-10N Je nach Kundenwunsch mit unterschiedlicher Kupplung / Equipped with different clutch according to customer requirement	(48) (35)
	02.90 - 12.92			3400 121 901  3488 017 333  1862 303 031  3151 000 034	400 10 MFZ2/400X 400WGVZ KZISZ-5	F05-10,16,18,19 für Fahrzeuge mit Zweischeibenkupplung / for vehicles with double disc clutch Je nach Kundenwunsch mit unterschiedlicher Kupplung / Equipped with different clutch according to customer requirement	(77) (35)
	02.90 - 12.92			1882 017 131	420 GF420XN	07.1990-> für Nebenantrieb / for PTO	(82)
				1878 086 941	420 10 420WGTZ	07.1990-> für Nebenantrieb / for PTO	(82)
				3483 000 510 ⊕	445 GMFZ445W	für Fahrzeuge mit Wandlerschaltkupplung / for vehicles with converter and clutch unit	(76)
				3483 000 509 ⊕	445 GMFZ445W	F09 für Fahrzeuge mit Wandlerschaltkupplung / for vehicles with converter and clutch unit	(76)
				1878 051 801	445 24 445GTZC	F09 für Fahrzeuge mit Wandlerschaltkupplung / for vehicles with converter and clutch unit	(76)
		3189 600 014		für Fahrzeuge mit Wandlerschaltkupplung / for vehicles with converter and clutch unit	(76)		
		3189 600 020		Getr. / GBox: ZF Ecosplit-3			

		CODE				
--	--	------	--	---	---	---

MAN























F 90		06.86 - 12.97					
26.322 DFK F09 F08 26.322 FNL,26.322 FNLL F18 F19 26.322 FNLS,26.322 FVLS F18 F07	02.92 - 06.96	D2865LF03, 06	 3400 127 601  3482 078 133  1862 364 031  3151 000 034	400 10 MFZ400 400WGVZ KZISZ-5	F05-10,16,18,19 Nabenprofil / Hub Profile: 2"-10N Je nach Kundenwunsch mit unterschiedlicher Kupplung / Equipped with different clutch according to customer requirement	(48) (35)	
	03.91 - 05.95		 3400 121 901  3488 017 333  1862 303 031  3151 000 034	400 10 MFZ2/400X 400WGVZ KZISZ-5	F05-10,16,18,19 für Fahrzeuge mit Zweischeibenkupplung / for vehicles with double disc clutch Je nach Kundenwunsch mit unterschiedlicher Kupplung / Equipped with different clutch according to customer requirement	(77) (35)	
	09.90 - 12.95		D2865	 1882 017 131	420 GF420XN	für Nebenantrieb / for PTO	(82)
				 1878 086 941	420 10 420WGTZ	für Nebenantrieb / for PTO	(82)
			D2865LF03, D2865LF06	 3189 600 020		Getr. / GBox: ZF Ecosplit-3	
26.332 DF, 26.332 DFL F09 26.332 DFK F09 26.332 DFS F09	09.87 - 02.90	D2866LF08	 3400 127 601  3482 078 133  1862 364 031  3151 000 034	400 10 MFZ400 400WGVZ KZISZ-5	F05-10,16 Nabenprofil / Hub Profile: 2"-10N Je nach Kundenwunsch mit unterschiedlicher Kupplung / Equipped with different clutch according to customer requirement	(48) (35)	
	09.87 - 02.90		 3400 122 201  3482 083 032  1878 004 832  3151 000 034	430 10 MFZ430 430WGTZ KZISZ-5	F05-10,16 Je nach Kundenwunsch mit unterschiedlicher Kupplung / Equipped with different clutch according to customer requirement	(35)	
	09.87 - 02.90		 3400 121 901  3488 017 333  1862 303 031  3151 000 034	400 10 MFZ2/400X 400WGVZ KZISZ-5	F05-10,16 für Fahrzeuge mit Zweischeibenkupplung / for vehicles with double disc clutch Je nach Kundenwunsch mit unterschiedlicher Kupplung / Equipped with different clutch according to customer requirement	(77) (35)	
			D2866LF/330	 3483 000 509 ⊕	445 GMFZ445W	für Fahrzeuge mit Wandlerschaltkupplung / for vehicles with converter and clutch unit	(76)
				 1878 051 801	445 24 445GTZC	für Fahrzeuge mit Wandlerschaltkupplung / for vehicles with converter and clutch unit	(76)
26.332 DFA F10 26.332 DFAK F10 26.332 DFAS F10	05.88 - 02.90	D2866LF08	 3400 127 601  3482 078 133  1862 364 031  3151 000 034	400 10 MFZ400 400WGVZ KZISZ-5	F05-10,16 Nabenprofil / Hub Profile: 2"-10N Je nach Kundenwunsch mit unterschiedlicher Kupplung / Equipped with different clutch according to customer requirement	(48) (35)	
	05.88 - 02.90		 3400 122 201  3482 083 032  1878 004 832  3151 000 034	430 10 MFZ430 430WGTZ KZISZ-5	F05-10,16 Je nach Kundenwunsch mit unterschiedlicher Kupplung / Equipped with different clutch according to customer requirement	(35)	
	05.88 - 02.90		 3400 121 901  3488 017 333  1862 303 031  3151 000 034	400 10 MFZ2/400X 400WGVZ KZISZ-5	F05-10,16 für Fahrzeuge mit Zweischeibenkupplung / for vehicles with double disc clutch Je nach Kundenwunsch mit unterschiedlicher Kupplung / Equipped with different clutch according to customer requirement	(77) (35)	
			D2866LF/330	 3483 000 510 ⊕	445 GMFZ445W	für Fahrzeuge mit Wandlerschaltkupplung / for vehicles with converter and clutch unit	(76)
				 1878 051 801	445 24 445GTZC	für Fahrzeuge mit Wandlerschaltkupplung / for vehicles with converter and clutch unit	(76)
26.362 DF, 26.362 DFL F16 F09 26.362 DFK F09 26.362 DFS F09	09.87 - 02.90	D2866KF, KU, LXF	 3400 122 201  3482 083 032  1878 004 832  3151 000 034	430 10 MFZ430 430WGTZ KZISZ-5	F05-10,16 Je nach Kundenwunsch mit unterschiedlicher Kupplung / Equipped with different clutch according to customer requirement	(35)	
	09.87 - 02.90		 3400 121 901  3488 017 333  1862 303 031  3151 000 034	400 10 MFZ2/400X 400WGVZ KZISZ-5	F05-10,16 für Fahrzeuge mit Zweischeibenkupplung / for vehicles with double disc clutch Je nach Kundenwunsch mit unterschiedlicher Kupplung / Equipped with different clutch according to customer requirement	(77) (35)	
	09.87 - 02.90		D2866KF, D2866LXF	 3483 000 509 ⊕	445 GMFZ445W	für Fahrzeuge mit Wandlerschaltkupplung / for vehicles with converter and clutch unit	(76)
				 1878 051 801	445 24 445GTZC	für Fahrzeuge mit Wandlerschaltkupplung / for vehicles with converter and clutch unit	(76)
				 3189 600 020		Getr. / GBox: ZF Ecosplit-3	
			 3189 600 014		für Fahrzeuge mit Wandlerschaltkupplung / for vehicles with converter and clutch unit	(76)	

MAN























F 90		06.86 - 12.97					
26.362 DFA F10 26.362 DFAK F10 26.362 DFAS F10	05.88 - 02.90	D2866KF, KU, LXF	 3400 122 201 ⊗ 3482 083 032 ⊗ 1878 004 832 ⊙ 3151 000 034	430 10 MFZ430 430WGTZ KZISZ-5	F05-10,16 Je nach Kundenwunsch mit unterschiedlicher Kupplung / Equipped with different clutch according to customer requirement	(35)	
	05.88 - 02.90		 3400 121 901 ⊗ 3488 017 333 ⊗ 1862 303 031 ⊙ 3151 000 034	400 10 MFZ2/400X 400WGVZ KZISZ-5	F05-10,16 für Fahrzeuge mit Zweischeibenkupplung / for vehicles with double disc clutch Je nach Kundenwunsch mit unterschiedlicher Kupplung / Equipped with different clutch according to customer requirement	(77) (35)	
	05.88 - 02.90	D2866LXF	 3483 000 510 ⊕	445 GMFZ445W	für Fahrzeuge mit Wandlerschaltkupplung / for vehicles with converter and clutch unit	(76)	
			 1878 051 801	445 24 445GTZC	für Fahrzeuge mit Wandlerschaltkupplung / for vehicles with converter and clutch unit	(76)	
			 3189 600 020		Getr. / GBox: ZF Ecosplit-3		
26.372 DF,26.372 DFL F16 F08 F09 26.372 DFS F08 F09	02.90 - 06.96	D2866LF01, 03, 05	 3400 127 601 ⊗ 3482 078 133 ⊗ 1862 364 031 ⊙ 3151 000 034	400 10 MFZ400 400WGVZ KZISZ-5	F05-10,16,18,19 Nabenprofil / Hub Profile: 2"-10N Je nach Kundenwunsch mit unterschiedlicher Kupplung / Equipped with different clutch according to customer requirement	(48) (35)	
	02.90 - 06.96		 3400 122 201 ⊗ 3482 083 032 ⊗ 1878 004 832 ⊙ 3151 000 034	430 10 MFZ430 430WGTZ KZISZ-5	F05-10,16,18,19 Je nach Kundenwunsch mit unterschiedlicher Kupplung / Equipped with different clutch according to customer requirement	(35)	
			 3400 121 901 ⊗ 3488 017 333 ⊗ 1862 303 031 ⊙ 3151 000 034	400 10 MFZ2/400X 400WGVZ KZISZ-5	F05-10,16,18,19 für Fahrzeuge mit Zweischeibenkupplung / for vehicles with double disc clutch Je nach Kundenwunsch mit unterschiedlicher Kupplung / Equipped with different clutch according to customer requirement	(77) (35)	
		D2866	 1882 017 131	420 GF420XN	F05-10,16,18,19 Nebenantriebs-ID / PTO ID: 130E	(50)	
			 1878 086 941	420 10 420WGTZ	F05-10,16,18,19 Nebenantriebs-ID / PTO ID: 130E	(50)	
			 3151 204 001	KZI-6	F05-10,16,18,19 mit Schmierrohranschluss / with lubrication pipe connection Nebenantriebs-ID / PTO ID: 130E	(91) (50)	
		D2866LF03, D2866LF05, D2866LF15	 3483 000 509 ⊕	445 GMFZ445W	F09 für Fahrzeuge mit Wandlerschaltkupplung / for vehicles with converter and clutch unit	(76)	
			 1878 051 801	445 24 445GTZC	F09 für Fahrzeuge mit Wandlerschaltkupplung / for vehicles with converter and clutch unit	(76)	
			 3189 600 020		Getr. / GBox: ZF Ecosplit-3		
			 3189 600 014		für Fahrzeuge mit Wandlerschaltkupplung / for vehicles with converter and clutch unit	(76)	
26.372 DFA F10 26.372 DFAK F10 26.372 DFAS F10 26.372 FNL,26.372 FNLL,26.372 FVL F07 F19 F18 26.372 FNLS,26.372 FVLS F18 F07	02.90 - 12.92	D2866LF01, 03, 05	 3400 127 601 ⊗ 3482 078 133 ⊗ 1862 364 031 ⊙ 3151 000 034	400 10 MFZ400 400WGVZ KZISZ-5	F05-10,16,18,19 Nabenprofil / Hub Profile: 2"-10N Je nach Kundenwunsch mit unterschiedlicher Kupplung / Equipped with different clutch according to customer requirement	(48) (35)	
	01.92 - 06.96		 3400 122 201 ⊗ 3482 083 032 ⊗ 1878 004 832 ⊙ 3151 000 034	430 10 MFZ430 430WGTZ KZISZ-5	F05-10,16,18,19 Je nach Kundenwunsch mit unterschiedlicher Kupplung / Equipped with different clutch according to customer requirement	(35)	
	02.90 - 12.92		 3400 121 901 ⊗ 3488 017 333 ⊗ 1862 303 031 ⊙ 3151 000 034	400 10 MFZ2/400X 400WGVZ KZISZ-5	F05-10,16,18,19 für Fahrzeuge mit Zweischeibenkupplung / for vehicles with double disc clutch Je nach Kundenwunsch mit unterschiedlicher Kupplung / Equipped with different clutch according to customer requirement	(77) (35)	
	09.90 - 12.95	D2866	 1882 017 131	420 GF420XN	F05-10,16,18,19 Nebenantriebs-ID / PTO ID: 130E	(50)	
	01.92 - 06.96		 1878 086 941	420 10 420WGTZ	F05-10,16,18,19 Nebenantriebs-ID / PTO ID: 130E	(50)	
			 3151 204 001	KZI-6	F05-10,16,18,19 mit Schmierrohranschluss / with lubrication pipe connection Nebenantriebs-ID / PTO ID: 130E	(91) (50)	
		D2866LF03, D2866LF05, D2866LF15	 3483 000 510 ⊕	445 GMFZ445W	für Fahrzeuge mit Wandlerschaltkupplung / for vehicles with converter and clutch unit	(76)	
			 1878 051 801	445 24 445GTZC	für Fahrzeuge mit Wandlerschaltkupplung / for vehicles with converter and clutch unit	(76)	
			 3189 600 020		Getr. / GBox: ZF Ecosplit-3		

		CODE				
--	--	------	--	---	---	---

MAN





























F 90		06.86 - 12.97					
26.372 DFK F08 26.372 FNL,26.372 FNLL,26.372 FVL F19 F18 F07 26.372 FNLS,26.372 FVLS F18 F07	01.92 - 06.96	D2866LF01, 03, 05	 3400 127 601 ⊗ 3482 078 133 ⊗ 1862 364 031 ⊙ 3151 000 034	400 10 MFZ400 400WGVZ KZISZ-5	F05-10,16,18,19 Nabenprofil / Hub Profile: 2"-10N Je nach Kundenwunsch mit unterschiedlicher Kupplung / Equipped with different clutch according to customer requirement	(48) (35)	
	09.90 - 12.95		 3400 122 201 ⊗ 3482 083 032 ⊗ 1878 004 832 ⊙ 3151 000 034	430 10 MFZ430 430WGTZ KZISZ-5	F05-10,16,18,19 Je nach Kundenwunsch mit unterschiedlicher Kupplung / Equipped with different clutch according to customer requirement	(35)	
	01.92 - 06.96		 3400 121 901 ⊗ 3488 017 333 ⊗ 1862 303 031 ⊙ 3151 000 034	400 10 MFZ2/400X 400WGVZ KZISZ-5	F05-10,16,18,19 für Fahrzeuge mit Zweischeibenkupplung / for vehicles with double disc clutch Je nach Kundenwunsch mit unterschiedlicher Kupplung / Equipped with different clutch according to customer requirement	(77) (35)	
			D2866	 1882 017 131	420 GF420XN	F05-10,16,18,19 Nebenantriebs-ID / PTO ID: 130E	(50)
				 1878 086 941	420 10 420WGTZ	F05-10,16,18,19 Nebenantriebs-ID / PTO ID: 130E	(50)
				 3151 204 001	KZI-6	F05-10,16,18,19 mit Schmierrohranschluss / with lubrication pipe connection Nebenantriebs-ID / PTO ID: 130E	(91) (50)
			D2866LF03, D2866LF05, D2866LF15	 3189 600 020		Getr. / GBox: ZF Ecosplit-3	
	26.402 DFK,26.402 DFLK F08 F16 26.402 FNLS,26.402 FVLS F07 F18	05.94 - 06.96	D2866LF16	 3400 127 601 ⊗ 3482 078 133 ⊗ 1862 364 031 ⊙ 3151 000 034	400 10 MFZ400 400WGVZ KZISZ-5	Nabenprofil / Hub Profile: 2"-10N Je nach Kundenwunsch mit unterschiedlicher Kupplung / Equipped with different clutch according to customer requirement	(48) (35)
		05.94 - 06.96		 3400 122 201 ⊗ 3482 083 032 ⊗ 1878 004 832 ⊙ 3151 000 034	430 10 MFZ430 430WGTZ KZISZ-5	Je nach Kundenwunsch mit unterschiedlicher Kupplung / Equipped with different clutch according to customer requirement	(35)
				 3400 121 901 ⊗ 3488 017 333 ⊗ 1862 303 031 ⊙ 3151 000 034	400 10 MFZ2/400X 400WGVZ KZISZ-5	für Fahrzeuge mit Zweischeibenkupplung / for vehicles with double disc clutch	(77)
		 3400 700 327 ⊗ 3482 114 031 ⊗ 1878 004 832 ⊙ 3151 263 031		430 10 GMFZ430N 430WGTZ KZIZ-6	Nebenantriebs-ID / PTO ID: NMV 221	(50)	
		 3400 700 641 HD ⊗ 3482 114 031 ⊗ 1878 007 729 ⊙ 3151 263 031		430 10 GMFZ430N 430WGTZ KZIZ-6	Nebenantriebs-ID / PTO ID: NMV 221	(50)	
				 3189 600 020		Getr. / GBox: ZF Ecosplit-3	
26.422 DF,26.422 DFL F09 F16 F08 26.422 DFK F08 F09 26.422 DFS F08 F09 26.422 FNL,26.422 FNLL,26.422 FVL F07 F18 F19 26.422 FNLS,26.422 FVLS F07 F18	02.90 - 06.96	D2866LF06, 09	 3400 122 201 ⊗ 3482 083 032 ⊗ 1878 004 832 ⊙ 3151 000 034	430 10 MFZ430 430WGTZ KZISZ-5	F05-10,16,18,19 Je nach Kundenwunsch mit unterschiedlicher Kupplung / Equipped with different clutch according to customer requirement	(35)	
	02.90 - 12.95		 3400 121 901 ⊗ 3488 017 333 ⊗ 1862 303 031 ⊙ 3151 000 034	400 10 MFZ2/400X 400WGVZ KZISZ-5	F05-10,16,18,19 für Fahrzeuge mit Zweischeibenkupplung / for vehicles with double disc clutch Je nach Kundenwunsch mit unterschiedlicher Kupplung / Equipped with different clutch according to customer requirement	(77) (35)	
	02.90 - 12.95		D2866	 1882 017 131	420 GF420XN	F05-10,16,18,19 Nebenantriebs-ID / PTO ID: 130E	(50)
	09.90 - 12.95			 1878 086 941	420 10 420WGTZ	F05-10,16,18,19 Nebenantriebs-ID / PTO ID: 130E	(50)
	01.92 - 12.95			 3151 204 001	KZI-6	F05-10,16,18,19 mit Schmierrohranschluss / with lubrication pipe connection Nebenantriebs-ID / PTO ID: 130E	(91) (50)
			D2866LF06, D2866LF09	 3483 000 509 ⊕	445 GMFZ445W	F09 für Fahrzeuge mit Wandlerschaltkupplung / for vehicles with converter and clutch unit	(76)
				 1878 051 801	445 24 445GTZC	F09 für Fahrzeuge mit Wandlerschaltkupplung / for vehicles with converter and clutch unit	(76)
				 3189 600 020		Getr. / GBox: ZF Ecosplit-3	
				 3189 600 014		für Fahrzeuge mit Wandlerschaltkupplung / for vehicles with converter and clutch unit	(76)





























MAN

F 90		06.86 - 12.97					
26.422 DFA F10	02.90 - 12.92	D2866LF06, 09	 3400 122 201 ⊗ 3482 083 032 ⊗ 1878 004 832 ⊙ 3151 000 034	430 10 MFZ430 430WGTZ KZISZ-5	F05-10,16,18,19 Je nach Kundenwunsch mit unterschiedlicher Kupplung / Equipped with different clutch according to customer requirement	(35)	
26.422 DFAK F10	02.90 - 12.92						
26.422 DFAS F10	02.90 - 12.92		 3400 121 901 ⊗ 3488 017 333 ⊗ 1862 303 031 ⊙ 3151 000 034	400 10 MFZ2/400X 400WGVZ KZISZ-5	F05-10,16,18,19 für Fahrzeuge mit Zweischeibenkupplung / for vehicles with double disc clutch	(77)	
26.422 FNL,26.422 FNLL,26.422 FVL F19 F18 F07	09.90 - 12.95				Je nach Kundenwunsch mit unterschiedlicher Kupplung / Equipped with different clutch according to customer requirement	(35)	
26.422 FNLS,26.422 FVLS F18 F07	01.92 - 12.95	D2866	 1882 017 131	420 GF420XN	F05-10,16,18,19 Nebenantriebs-ID / PTO ID: 130E	(50)	
			 1878 086 941	420 10 420WGTZ	F05-10,16,18,19 Nebenantriebs-ID / PTO ID: 130E	(50)	
			 3151 204 001	KZI-6	F05-10,16,18,19 mit Schmierrohranschluss / with lubrication pipe connection	(91)	
					Nebenantriebs-ID / PTO ID: 130E	(50)	
		D2866LF06, D2866LF09	 3483 000 510 ⊕	445 GMFZ445W	für Fahrzeuge mit Wandlerschaltkupplung / for vehicles with converter and clutch unit	(76)	
			 1878 051 801	445 24 445GTZC	für Fahrzeuge mit Wandlerschaltkupplung / for vehicles with converter and clutch unit	(76)	
			 3189 600 020		Getr. / GBox: ZF Ecosplit-3		
26.462 DF F29	02.89 - 02.90	D2840LF	 3400 122 201 ⊗ 3482 083 032 ⊗ 1878 004 832 ⊙ 3151 000 034	430 10 MFZ430 430WGTZ KZISZ-5	F25,28,29 Je nach Kundenwunsch mit unterschiedlicher Kupplung / Equipped with different clutch according to customer requirement	(35)	
26.462 DFA F30	08.89 - 02.90						
26.462 DFAS F30	08.89 - 02.90		 3400 121 901 ⊗ 3488 017 333 ⊗ 1862 303 031 ⊙ 3151 000 034	400 10 MFZ2/400X 400WGVZ KZISZ-5	F25,28,29 für Fahrzeuge mit Zweischeibenkupplung / for vehicles with double disc clutch	(77)	
26.462 DFS F29	02.89 - 02.90				Je nach Kundenwunsch mit unterschiedlicher Kupplung / Equipped with different clutch according to customer requirement	(35)	
26.502 DFA F30	02.90 - 12.92						
26.502 DFAS F30	02.90 - 12.92	D2840LF04, D2840LF460, D2840LF01	 3483 000 510 ⊕	445 GMFZ445W	für Fahrzeuge mit Wandlerschaltkupplung / for vehicles with converter and clutch unit	(76)	
			 1878 051 801	445 24 445GTZC	für Fahrzeuge mit Wandlerschaltkupplung / for vehicles with converter and clutch unit	(76)	
			 3189 600 020		Getr. / GBox: ZF Ecosplit-3		
26.502 DF F28 F29	02.90 - 06.96	D2840LF01, 04	 3400 122 201 ⊗ 3482 083 032 ⊗ 1878 004 832 ⊙ 3151 000 034	430 10 MFZ430 430WGTZ KZISZ-5	F25,28,29,36 Je nach Kundenwunsch mit unterschiedlicher Kupplung / Equipped with different clutch according to customer requirement	(35)	
26.502 DFS,26.502 DFLS F29 F36 F28	02.90 - 06.96						
26.502 FNL,26.502 FNLL F39 F25	09.91 - 06.96		 3400 121 901 ⊗ 3488 017 333 ⊗ 1862 303 031 ⊙ 3151 000 034	400 10 MFZ2/400X 400WGVZ KZISZ-5	F25,28,29,36 für Fahrzeuge mit Zweischeibenkupplung / for vehicles with double disc clutch	(77)	
					Je nach Kundenwunsch mit unterschiedlicher Kupplung / Equipped with different clutch according to customer requirement	(35)	
		D2840LF04, D2840LF01, D2840LF06	 3483 000 510 ⊕	445 GMFZ445W	für Fahrzeuge mit Wandlerschaltkupplung / for vehicles with converter and clutch unit	(76)	
			 1878 051 801	445 24 445GTZC	für Fahrzeuge mit Wandlerschaltkupplung / for vehicles with converter and clutch unit	(76)	
			 3189 600 020		Getr. / GBox: ZF Ecosplit-3		
27.292 F10	01.86 - 12.92	D2866LF07, D2866LF08	 3400 127 601 ⊗ 3482 078 133 ⊗ 1862 364 031 ⊙ 3151 000 034	400 10 MFZ400 400WGVZ KZISZ-5	Nabenprofil / Hub Profile: 2"-10N Je nach Kundenwunsch mit unterschiedlicher Kupplung / Equipped with different clutch according to customer requirement	(48) (35)	
27.332 F10	01.86 - 12.92						
			 3400 122 201 ⊗ 3482 083 032 ⊗ 1878 004 832 ⊙ 3151 000 034	430 10 MFZ430 430WGTZ KZISZ-5	Je nach Kundenwunsch mit unterschiedlicher Kupplung / Equipped with different clutch according to customer requirement	(35)	
			 3483 000 510 ⊕	445 GMFZ445W	für Fahrzeuge mit Wandlerschaltkupplung / for vehicles with converter and clutch unit	(76)	
			 1878 051 801	445 24 445GTZC	für Fahrzeuge mit Wandlerschaltkupplung / for vehicles with converter and clutch unit	(76)	
			 3189 600 020		Getr. / GBox: ZF Ecosplit-3		

		CODE				
--	--	------	--	---	---	---

























MAN



























F 90		06.86 - 12.97						
27.302 F10	01.90 - 12.92	D2866LF04	 3400 127 601 ⊗ 3482 078 133 ⊗ 1862 364 031 ⊙ 3151 000 034	400 10 MFZ400 400WGVZ KZISZ-5	Nabenprofil / Hub Profile: 2"-10N	(48)		
			 3483 000 510 ⊕	445 GMFZ445W	für Fahrzeuge mit Wandlerschaltkupplung / for vehicles with converter and clutch unit	(76)		
			 1878 051 801	445 24 445GTZC	für Fahrzeuge mit Wandlerschaltkupplung / for vehicles with converter and clutch unit	(76)		
			 3189 600 020		Getr. / GBox: ZF Ecosplit-3			
27.322 F09,10	01.90 -	D2865LF03, D2865LF06	 3400 127 601 ⊗ 3482 078 133 ⊗ 1862 364 031 ⊙ 3151 000 034	400 10 MFZ400 400WGVZ KZISZ-5	Nabenprofil / Hub Profile: 2"-10N	(48)		
			 1882 017 131	420 GF420XN	für Nebenantrieb / for PTO	(82)		
			 1878 086 941	420 10 420WGTZ	für Nebenantrieb / for PTO	(82)		
			 3151 204 001	KZI-6	für Nebenantrieb / for PTO mit Schmierrohranschluss / with lubrication pipe connection	(82) (91)		
			 3189 600 020		Getr. / GBox: ZF Ecosplit-3			
27.362 F10	01.87 - 12.92	D2866KF	 3400 122 201 ⊗ 3482 083 032 ⊗ 1878 004 832 ⊙ 3151 000 034	430 10 MFZ430 430WGTZ KZISZ-5				
			 3483 000 510 ⊕	445 GMFZ445W	für Fahrzeuge mit Wandlerschaltkupplung / for vehicles with converter and clutch unit	(76)		
			 1878 051 801	445 24 445GTZC	für Fahrzeuge mit Wandlerschaltkupplung / for vehicles with converter and clutch unit	(76)		
			 3189 600 020		Getr. / GBox: ZF Ecosplit-3			
27.372 F09,10	01.90 -	D2866LF03, D2866LF05, D2866LF01	 3400 127 601 ⊗ 3482 078 133 ⊗ 1862 364 031 ⊙ 3151 000 034	400 10 MFZ400 400WGVZ KZISZ-5	Nabenprofil / Hub Profile: 2"-10N Je nach Kundenwunsch mit unterschiedlicher Kupplung / Equipped with different clutch according to customer requirement	(48) (35)		
			 3400 122 201 ⊗ 3482 083 032 ⊗ 1878 004 832 ⊙ 3151 000 034	430 10 MFZ430 430WGTZ KZISZ-5				
			 3189 600 020		Getr. / GBox: ZF Ecosplit-3			
27.462 F30 27.502 F30	01.89 -	D2840LF07, D2840LF01, D2840LF	 3400 122 201 ⊗ 3482 083 032 ⊗ 1878 004 832 ⊙ 3151 000 034	430 10 MFZ430 430WGTZ KZISZ-5	Je nach Kundenwunsch mit unterschiedlicher Kupplung / Equipped with different clutch according to customer requirement	(35)		
			 3400 121 901 ⊗ 3488 017 333 ⊗ 1862 303 031 ⊙ 3151 000 034	400 10 MFZ2/400X 400WGVZ KZISZ-5	für Fahrzeuge mit Zweischeibenkupplung / for vehicles with double disc clutch Je nach Kundenwunsch mit unterschiedlicher Kupplung / Equipped with different clutch according to customer requirement	(77) (35)		
	01.90 -			 3483 000 510 ⊕	445 GMFZ445W	für Fahrzeuge mit Wandlerschaltkupplung / for vehicles with converter and clutch unit	(76)	
				 1878 051 801	445 24 445GTZC	für Fahrzeuge mit Wandlerschaltkupplung / for vehicles with converter and clutch unit	(76)	
				 3189 600 020		Getr. / GBox: ZF Ecosplit-3		
				 3189 600 014		für Fahrzeuge mit Wandlerschaltkupplung / for vehicles with converter and clutch unit	(76)	
28.242 F09	01.87 - 12.92	D2866LF	 3400 700 310 ⊗ 3482 078 133 ⊗ 1862 364 133 ⊙ 3151 000 034	400 10 MFZ400 400WGVZ KZISZ-5	Nabenprofil / Hub Profile: 1 3/4"-10N	(48)		
			 1882 017 131	420 GF420XN	Nebenantriebs-ID / PTO ID: 130E	(50)		
			 1878 086 941	420 10 420WGTZ	Nebenantriebs-ID / PTO ID: 130E	(50)		
			 3483 000 509 ⊕	445 GMFZ445W	für Fahrzeuge mit Wandlerschaltkupplung / for vehicles with converter and clutch unit	(76)		
			 1878 051 801	445 24 445GTZC	für Fahrzeuge mit Wandlerschaltkupplung / for vehicles with converter and clutch unit	(76)		
			 3189 600 020		Getr. / GBox: ZF Ecosplit-3			
			 3189 600 014		für Fahrzeuge mit Wandlerschaltkupplung / for vehicles with converter and clutch unit	(76)		

F 90		06.86 - 12.97					
28.262 F09,13,14 33.272 F13,14	01.87 -	D2865LF	 3400 700 310 ⊗ 3482 078 133 ⊗ 1862 364 133 ⊙ 3151 000 034	400 10 MFZ400 400WGVZ KZISZ-5	Nabenprofil / Hub Profile: 1 3/4"-10N	(48)	
	01.90 -		 1882 017 131	420 GF420XN	Nebenantriebs-ID / PTO ID: 130E	(50)	
			 1878 086 941	420 10 420WGTZ	Nebenantriebs-ID / PTO ID: 130E	(50)	
			 3189 600 020		Getr. / GBox: ZF Ecosplit-3		
28.362 F09,13,14 32.402 F14 40.462 DF 41.402 VF F14 48.462 VF F15	01.87 -	D2866KF, D2840LF460, D2866, D2866LF16, D2866LXF	 3400 122 201 ⊗ 3482 083 032 ⊗ 1878 004 832 ⊙ 3151 000 034	430 10 MFZ430 430WGTZ KZISZ-5			
	01.94 -		 1882 017 131	420 GF420XN	Nebenantriebs-ID / PTO ID: 130E	(50)	
	07.89 - 02.90		 1878 086 941	420 10 420WGTZ	Nebenantriebs-ID / PTO ID: 130E	(50)	
	05.94 - 06.96		 3189 600 020		Getr. / GBox: ZF Ecosplit-3		
48.462 VF F15	07.89 - 02.90						
	30.342 F14 41.342 VF F14	01.94 -	D2865LF, D2865LF09	 3400 122 301 ⊗ 3482 083 032 ⊗ 1878 080 034 ⊙ 3151 000 034	430 10 MFZ430 430WGTZ KZISZ-5		
		05.94 - 06.96		 1882 017 131	420 GF420XN	Nebenantriebs-ID / PTO ID: 130E	(50)
				 1878 086 941	420 10 420WGTZ	Nebenantriebs-ID / PTO ID: 130E	(50)
		 3189 600 020			Getr. / GBox: ZF Ecosplit-3		
30.402 F14	01.94 -	D2866	 3400 122 201 ⊗ 3482 083 032 ⊗ 1878 004 832 ⊙ 3151 000 034	430 10 MFZ430 430WGTZ KZISZ-5			
		D2865	 1882 017 131	420 GF420XN	Nebenantriebs-ID / PTO ID: 130E	(50)	
			 1878 086 941	420 10 420WGTZ	Nebenantriebs-ID / PTO ID: 130E	(50)	
			 3189 600 020		Getr. / GBox: ZF Ecosplit-3		
32.262 VF F13 32.262 VFK F13 32.262 VFTM F13	02.89 - 02.90	D2865LF/260	 3400 700 310 ⊗ 3482 078 133 ⊗ 1862 364 133 ⊙ 3151 000 034	400 10 MFZ400 400WGVZ KZISZ-5	F09,10,13,14 Nabenprofil / Hub Profile: 1 3/4"-10N	(48)	
	02.89 - 02.90		 3189 600 020		Getr. / GBox: ZF Ecosplit-3		
	02.89 - 02.90						
32.272 VF F13 32.272 VFK F13	02.90 - 04.95	D2865LF	 3400 700 310 ⊗ 3482 078 133 ⊗ 1862 364 133 ⊙ 3151 000 034	400 10 MFZ400 400WGVZ KZISZ-5	F09,10,13,14 Nabenprofil / Hub Profile: 1 3/4"-10N	(48)	
	02.90 - 04.95		 1882 017 131	420 GF420XN	Nebenantriebs-ID / PTO ID: 130E	(50)	
			 1878 086 941	420 10 420WGTZ	Nebenantriebs-ID / PTO ID: 130E	(50)	
			 3189 600 020		Getr. / GBox: ZF Ecosplit-3		
32.302 VF F13 32.302 VFK F13	05.90 - 09.91	D2866LF04	 3400 127 601 ⊗ 3482 078 133 ⊗ 1862 364 031 ⊙ 3151 000 034	400 10 MFZ400 400WGVZ KZISZ-5	F10,13,14 Nabenprofil / Hub Profile: 2"-10N	(48)	
	05.90 - 09.91		 1882 017 131	420 GF420XN	Nebenantriebs-ID / PTO ID: 130E	(50)	
			 1878 086 941	420 10 420WGTZ	Nebenantriebs-ID / PTO ID: 130E	(50)	
			 3151 204 001	KZI-6	mit Schmierrohranschluss / with lubrication pipe connection Nebenantriebs-ID / PTO ID: 130E	(91) (50)	
			 3189 600 020		Getr. / GBox: ZF Ecosplit-3		
32.322 VF F13 32.322 VFK F13	02.90 - 06.96	D2865LF03, D2865LF06	 3400 127 601 ⊗ 3482 078 133 ⊗ 1862 364 031 ⊙ 3151 000 034	400 10 MFZ400 400WGVZ KZISZ-5	E15,F10,13,14 Nabenprofil / Hub Profile: 2"-10N	(48)	
	02.90 - 06.96		 3189 600 020		Getr. / GBox: ZF Ecosplit-3		

		CODE				
--	--	------	--	---	---	---

























MAN

F 90		06.86 - 12.97					
32.332 VF F13 32.332 VFK F13	03.88 - 02.90	D2866LF08	 3400 127 601 ⊗ 3482 078 133 ⊗ 1862 364 031 ⊙ 3151 000 034	400 10 MFZ400 400WGVZ KZISZ-5	E15,F09,10,13,14 Nabenprofil / Hub Profile: 2"-10N Je nach Kundenwunsch mit unterschiedlicher Kupplung / Equipped with different clutch according to customer requirement	(48)	(35)
	03.88 - 02.90		 3400 122 201 ⊗ 3482 083 032 ⊗ 1878 004 832 ⊙ 3151 000 034	430 10 MFZ430 430WGTZ KZISZ-5	E15,F09,10,13,14 Je nach Kundenwunsch mit unterschiedlicher Kupplung / Equipped with different clutch according to customer requirement	(35)	
		D2866LF/330	 3189 600 020		Getr. / GBox: ZF Ecosplit-3		
32.362 VF F13 32.362 VFK F13	03.88 - 02.90	D2866KF, KU, LXF	 3400 122 201 ⊗ 3482 083 032 ⊗ 1878 004 832 ⊙ 3151 000 034	430 10 MFZ430 430WGTZ KZISZ-5	E15,F09,10,13,14		
	03.88 - 02.90		 1882 017 131	420 GF420XN	Nebenantriebs-ID / PTO ID: 130	(50)	
			 1878 086 941	420 10 420WGTZ	Nebenantriebs-ID / PTO ID: 130	(50)	
		D2866LXF	 3189 600 020		Getr. / GBox: ZF Ecosplit-3		
32.372 VF F13 32.372 VFK F13	02.90 - 06.96	D2866LF01, 03, 05	 3400 127 601 ⊗ 3482 078 133 ⊗ 1862 364 031 ⊙ 3151 000 034	400 10 MFZ400 400WGVZ KZISZ-5	E15,F10,13,14 Nabenprofil / Hub Profile: 2"-10N Je nach Kundenwunsch mit unterschiedlicher Kupplung / Equipped with different clutch according to customer requirement	(48)	(35)
	02.90 - 06.96		 3400 122 201 ⊗ 3482 083 032 ⊗ 1878 004 832 ⊙ 3151 000 034	430 10 MFZ430 430WGTZ KZISZ-5	E15,F10,13,14 Je nach Kundenwunsch mit unterschiedlicher Kupplung / Equipped with different clutch according to customer requirement	(35)	
		D2866LF03, D2866LF05, D2866LF15	 3189 600 020		Getr. / GBox: ZF Ecosplit-3		
32.422 VF F13 32.422 VFK	02.90 - 06.96	D2866LF06, 09	 3400 122 201 ⊗ 3482 083 032 ⊗ 1878 004 832 ⊙ 3151 000 034	430 10 MFZ430 430WGTZ KZISZ-5	E15,F10,13,14		
	02.90 - 06.96	D2866LF06, D2866LF09	 3189 600 020		Getr. / GBox: ZF Ecosplit-3		
33.242 DFAK F09 33.242 DFK F09	01.88 - 08.88	D2866F/240	 3400 700 310 ⊗ 3482 078 133 ⊗ 1862 364 133 ⊙ 3151 000 034	400 10 MFZ400 400WGVZ KZISZ-5	F09,10 Nabenprofil / Hub Profile: 1 3/4"-10N	(48)	
			 3483 000 509 ⊕	445 GMFZ445W	für Fahrzeuge mit Wandlerschaltkupplung / for vehicles with converter and clutch unit	(76)	
			 1878 051 801	445 24 445GTZC	für Fahrzeuge mit Wandlerschaltkupplung / for vehicles with converter and clutch unit	(76)	
			 3189 600 014		für Fahrzeuge mit Wandlerschaltkupplung / for vehicles with converter and clutch unit	(76)	
			 3189 600 020		Getr. / GBox: ZF Ecosplit-3		
33.262 DF F09 33.262 DFK F09	08.88 - 02.90	D2865LF/260	 3400 700 310 ⊗ 3482 078 133 ⊗ 1862 364 133 ⊙ 3151 000 034	400 10 MFZ400 400WGVZ KZISZ-5	F09,10,13,14 Nabenprofil / Hub Profile: 1 3/4"-10N	(48)	
	08.88 - 02.90		 1882 017 131	420 GF420XN	F09,10,13,14 Nebenantriebs-ID / PTO ID: 230E	(50)	
			 1878 086 941	420 10 420WGTZ	F09,10,13,14 Nebenantriebs-ID / PTO ID: 230E	(50)	
			 3483 000 509 ⊕	445 GMFZ445W	für Fahrzeuge mit Wandlerschaltkupplung / for vehicles with converter and clutch unit	(76)	
			 1878 051 801	445 24 445GTZC	für Fahrzeuge mit Wandlerschaltkupplung / for vehicles with converter and clutch unit	(76)	
			 3189 600 014		für Fahrzeuge mit Wandlerschaltkupplung / for vehicles with converter and clutch unit	(76)	
			 3189 600 020		Getr. / GBox: ZF Ecosplit-3		

F 90		06.86 - 12.97					
33.262 DFA F10 33.262 DFAK F10	07.89 - 02.90	D2865LF/260	 3400 700 310 ⊗ 3482 078 133 ⊗ 1862 364 133 ⊙ 3151 000 034	400 10 MFZ400 400WGVZ KZISZ-5	F09,10,13,14 Nabenprofil / Hub Profile: 1 3/4"-10N	(48)	
	07.89 - 02.90		 1882 017 131	420 GF420XN	F09,10,13,14 Nebenantriebs-ID / PTO ID: 230E	(50)	
			 1878 086 941	420 10 420WGTZ	F09,10,13,14 Nebenantriebs-ID / PTO ID: 230E	(50)	
			 3483 000 510 ⊕	445 GMFZ445W	für Fahrzeuge mit Wandlerschaltkupplung / for vehicles with converter and clutch unit	(76)	
			 1878 051 801	445 24 445GTZC	für Fahrzeuge mit Wandlerschaltkupplung / for vehicles with converter and clutch unit	(76)	
			 3189 600 020		Getr. / GBox: ZF Ecosplit-3		
33.292 DF F10 33.292 DFA F10 33.292 DFAK F10 33.292 DFAS F10 33.332 DFA F10 33.332 DFAK F10 33.332 DFAS F10	09.87 - 02.90	D2866LF08	 3400 127 601 ⊗ 3482 078 133 ⊗ 1862 364 031 ⊙ 3151 000 034	400 10 MFZ400 400WGVZ KZISZ-5	F09,10,13,14 Nabenprofil / Hub Profile: 2"-10N Je nach Kundenwunsch mit unterschiedlicher Kupplung / Equipped with different clutch according to customer requirement	(48) (35)	
	05.88 - 02.90		 3400 122 201 ⊗ 3482 083 032 ⊗ 1878 004 832 ⊙ 3151 000 034	430 10 MFZ430 430WGTZ KZISZ-5	F09,10,13,14 Je nach Kundenwunsch mit unterschiedlicher Kupplung / Equipped with different clutch according to customer requirement	(35)	
	05.88 - 02.90		 1882 017 131	420 GF420XN	F09,10,13,14 Nebenantriebs-ID / PTO ID: 130E	(50)	
	05.88 - 02.90		 1878 086 941	420 10 420WGTZ	F09,10,13,14 Nebenantriebs-ID / PTO ID: 130E	(50)	
	05.88 - 02.90		 3483 000 510 ⊕	445 GMFZ445W	für Fahrzeuge mit Wandlerschaltkupplung / for vehicles with converter and clutch unit	(76)	
	05.88 - 02.90		 1878 051 801	445 24 445GTZC	für Fahrzeuge mit Wandlerschaltkupplung / for vehicles with converter and clutch unit	(76)	
	05.88 - 02.90		 3189 600 020		Getr. / GBox: ZF Ecosplit-3		
	09.87 - 02.90		D2866LF/290, D2866LF/330	 3400 127 601 ⊗ 3482 078 133 ⊗ 1862 364 031 ⊙ 3151 000 034	400 10 MFZ400 400WGVZ KZISZ-5	F09,10,13,14 Nabenprofil / Hub Profile: 2"-10N Je nach Kundenwunsch mit unterschiedlicher Kupplung / Equipped with different clutch according to customer requirement	(48) (35)
	09.87 - 02.90			 3400 122 201 ⊗ 3482 083 032 ⊗ 1878 004 832 ⊙ 3151 000 034	430 10 MFZ430 430WGTZ KZISZ-5	F09,10,13,14 Je nach Kundenwunsch mit unterschiedlicher Kupplung / Equipped with different clutch according to customer requirement	(35)
	09.87 - 02.90			 1882 017 131	420 GF420XN	F09,10,13,14 Nebenantriebs-ID / PTO ID: 130E	(50)
09.87 - 02.90	 1878 086 941	420 10 420WGTZ		F09,10,13,14 Nebenantriebs-ID / PTO ID: 130E	(50)		
09.87 - 02.90	 3483 000 509 ⊕	445 GMFZ445W		für Fahrzeuge mit Wandlerschaltkupplung / for vehicles with converter and clutch unit	(76)		
09.87 - 02.90	 1878 051 801	445 24 445GTZC		für Fahrzeuge mit Wandlerschaltkupplung / for vehicles with converter and clutch unit	(76)		
09.87 - 02.90	 3189 600 014			für Fahrzeuge mit Wandlerschaltkupplung / for vehicles with converter and clutch unit	(76)		
09.87 - 02.90	 3189 600 020			Getr. / GBox: ZF Ecosplit-3			
33.302 F10,13,14 36.302 F14 41.262 VF F14 41.262 VFK F14 41.272 VF F14 41.302 F14	01.90 -	D2865LF02, D2866LF, D2865LF/260, D2866LF04	 3400 127 601 ⊗ 3482 078 133 ⊗ 1862 364 031 ⊙ 3151 000 034	400 10 MFZ400 400WGVZ KZISZ-5	Nabenprofil / Hub Profile: 2"-10N	(48)	
	01.90 - 12.93		 1882 017 131	420 GF420XN	Nebenantriebs-ID / PTO ID: 130E	(50)	
	07.89 - 02.90		 1878 086 941	420 10 420WGTZ	Nebenantriebs-ID / PTO ID: 130E	(50)	
	07.89 - 02.90		 3151 204 001	KZI-6	mit Schmierrohranschluss / with lubrication pipe connection	(91)	
	02.90 - 12.91		 3189 600 020		Nebenantriebs-ID / PTO ID: 130E	(50)	
	01.90 - 12.93		 3189 600 020		Getr. / GBox: ZF Ecosplit-3		
	01.90 - 12.93						























		CODE				
--	--	------	--	---	---	---

MAN

F 90		06.86 - 12.97							
33.322 DFA F10	09.91 - 06.96	D2865LF03, D2865LF06	 3400 127 601 ⊗ 3482 078 133 ⊗ 1862 364 031 ⊙ 3151 000 034	400 10 MFZ400 400WGVZ KZISZ-5	F10,13,14 Nabenprofil / Hub Profile: 2"-10N	(48)			
			 1882 017 131	420 GF420XN	Nebenantriebs-ID / PTO ID: 130E	(50)			
			 1878 086 941	420 10 420WGTZ	Nebenantriebs-ID / PTO ID: 130E	(50)			
			 3151 204 001	KZI-6	mit Schmierrohranschluss / with lubrication pipe connection Nebenantriebs-ID / PTO ID: 130E	(91) (50)			
			 3483 000 510 ⊕	445 GMFZ445W	für Fahrzeuge mit Wandlerschaltkupplung / for vehicles with converter and clutch unit	(76)			
			 1878 051 801	445 24 445GTZC	für Fahrzeuge mit Wandlerschaltkupplung / for vehicles with converter and clutch unit	(76)			
			 3189 600 020		Getr. / GBox: ZF Ecosplit-3				
			33.332 DF F09	09.87 - 02.90	D2866LF08	 3400 127 601 ⊗ 3482 078 133 ⊗ 1862 364 031 ⊙ 3151 000 034	400 10 MFZ400 400WGVZ KZISZ-5	F09,10,13,14 Nabenprofil / Hub Profile: 2"-10N Je nach Kundenwunsch mit unterschiedlicher Kupplung / Equipped with different clutch according to customer requirement	(48) (35)
 3400 122 201 ⊗ 3482 083 032 ⊗ 1878 004 832 ⊙ 3151 000 034	430 10 MFZ430 430WGTZ KZISZ-5	F09,10,13,14 Je nach Kundenwunsch mit unterschiedlicher Kupplung / Equipped with different clutch according to customer requirement				(35)			
 1882 017 131	420 GF420XN	F09,10,13,14 Nebenantriebs-ID / PTO ID: 130E				(50)			
 1878 086 941	420 10 420WGTZ	F09,10,13,14 Nebenantriebs-ID / PTO ID: 130E				(50)			
 3151 204 001	KZI-6	F09,10,13,14 mit Schmierrohranschluss / with lubrication pipe connection Nebenantriebs-ID / PTO ID: 130E				(91) (50)			
 3483 000 509 ⊕	445 GMFZ445W	F09 für Fahrzeuge mit Wandlerschaltkupplung / for vehicles with converter and clutch unit				(76)			
 1878 051 801	445 24 445GTZC	F09 für Fahrzeuge mit Wandlerschaltkupplung / for vehicles with converter and clutch unit				(76)			
 3189 600 014		für Fahrzeuge mit Wandlerschaltkupplung / for vehicles with converter and clutch unit				(76)			
 3189 600 020		Getr. / GBox: ZF Ecosplit-3							
33.362 DF F09 33.362 DFS F09	09.87 - 02.90	D2866KF, D2866LXF				 3400 122 201 ⊗ 3482 083 032 ⊗ 1878 004 832 ⊙ 3151 000 034	430 10 MFZ430 430WGTZ KZISZ-5	F09,10,13,14	
	09.87 - 02.90					 1882 017 131	420 GF420XN	Nebenantriebs-ID / PTO ID: 130E	(50)
			 1878 086 941	420 10 420WGTZ	Nebenantriebs-ID / PTO ID: 130E	(50)			
			 3151 204 001	KZI-6	mit Schmierrohranschluss / with lubrication pipe connection Nebenantriebs-ID / PTO ID: 130E	(91) (50)			
			 3483 000 509 ⊕	445 GMFZ445W	für Fahrzeuge mit Wandlerschaltkupplung / for vehicles with converter and clutch unit	(76)			
			 1878 051 801	445 24 445GTZC	für Fahrzeuge mit Wandlerschaltkupplung / for vehicles with converter and clutch unit	(76)			
			 3189 600 014		für Fahrzeuge mit Wandlerschaltkupplung / for vehicles with converter and clutch unit	(76)			
			 3189 600 020		Getr. / GBox: ZF Ecosplit-3				























		CODE				
--	--	------	--	---	---	---

MAN

F 90		06.86 - 12.97					
33.362 DFA F10 33.362 DFAK F10 33.362 DFAS F10	05.88 - 02.90	D2866LXF	 3400 122 201 ⊗ 3482 083 032 ⊗ 1878 004 832 ⊙ 3151 000 034	430 10 MFZ430 430WGTZ KZISZ-5	F09,10,13,14		
	05.88 - 02.90		 1882 017 131	420 GF420XN	Nebenantriebs-ID / PTO ID: 130E	(50)	
	05.88 - 02.90		 1878 086 941	420 10 420WGTZ	Nebenantriebs-ID / PTO ID: 130E	(50)	
			 3483 000 510 ⊕	445 GMFZ445W	für Fahrzeuge mit Wandlerschaltkupplung / for vehicles with converter and clutch unit	(76)	
			 1878 051 801	445 24 445GTZC	für Fahrzeuge mit Wandlerschaltkupplung / for vehicles with converter and clutch unit	(76)	
			 3189 600 020		Getr. / GBox: ZF Ecosplit-3		
33.362 DFK F09	09.87 - 02.90	D2866KF, D2866LXF	 3400 122 201 ⊗ 3482 083 032 ⊗ 1878 004 832 ⊙ 3151 000 034	430 10 MFZ430 430WGTZ KZISZ-5	F09,10,13,14		
			 1882 017 131	420 GF420XN	Nebenantriebs-ID / PTO ID: 130E	(50)	
			 1878 086 941	420 10 420WGTZ	Nebenantriebs-ID / PTO ID: 130E	(50)	
			 3189 600 020		Getr. / GBox: ZF Ecosplit-3		
33.372 DF F10 33.372 DFA F10 33.372 DFAK F10	09.91 - 06.96	D2866LF01, 03, 05	 3400 127 601 ⊗ 3482 078 133 ⊗ 1862 364 031 ⊙ 3151 000 034	400 10 MFZ400 400WGVZ KZISZ-5	F10,13,14 Nabenprofil / Hub Profile: 2"-10N Je nach Kundenwunsch mit unterschiedlicher Kupplung / Equipped with different clutch according to customer requirement	(48) (35)	
	09.91 - 06.96		 3400 122 201 ⊗ 3482 083 032 ⊗ 1878 004 832 ⊙ 3151 000 034	430 10 MFZ430 430WGTZ KZISZ-5	F10,13,14 Je nach Kundenwunsch mit unterschiedlicher Kupplung / Equipped with different clutch according to customer requirement	(35)	
	01.91 - 06.96	D2866LF	 1882 017 131	420 GF420XN	für Nebenantrieb / for PTO	(82)	
			 1878 086 941	420 10 420WGTZ	für Nebenantrieb / for PTO	(82)	
		D2866LF03, D2866LF05, D2866LF15	 3483 000 510 ⊕	445 GMFZ445W	für Fahrzeuge mit Wandlerschaltkupplung / for vehicles with converter and clutch unit	(76)	
			 1878 051 801	445 24 445GTZC	für Fahrzeuge mit Wandlerschaltkupplung / for vehicles with converter and clutch unit	(76)	
			 3189 600 020		Getr. / GBox: ZF Ecosplit-3		
	33.422 DFA F10 33.422 DFAK F10	09.91 - 06.96	D2866LF06, D2866LF09	 3400 122 201 ⊗ 3482 083 032 ⊗ 1878 004 832 ⊙ 3151 000 034	430 10 MFZ430 430WGTZ KZISZ-5	F10,13,14	
		01.94 - 06.96		 3483 000 510 ⊕	445 GMFZ445W	für Fahrzeuge mit Wandlerschaltkupplung / for vehicles with converter and clutch unit	(76)
				 1878 051 801	445 24 445GTZC	für Fahrzeuge mit Wandlerschaltkupplung / for vehicles with converter and clutch unit	(76)
		 3189 600 020			Getr. / GBox: ZF Ecosplit-3		
		D2866LF	 1882 017 131	420 GF420XN	Nebenantriebs-ID / PTO ID: 130E	(50)	
			 1878 086 941	420 10 420WGTZ	Nebenantriebs-ID / PTO ID: 130E	(50)	





























		CODE				
--	--	------	--	---	---	---

MAN

F 90		06.86 - 12.97						
33.462 DF F29 33.462 DFA F30	07.89 - 02.90	D2840LF460	 3400 122 201 ⊗ 3482 083 032 ⊗ 1878 004 832 ⊙ 3151 000 034	430 10 MFZ430 430WGTZ KZISZ-5	Je nach Kundenwunsch mit unterschiedlicher Kupplung / Equipped with different clutch according to customer requirement	(35)		
	07.89 - 02.90		 3400 121 901 ⊗ 3488 017 333 ⊗ 1862 303 031 ⊙ 3151 000 034	400 10 MFZ2/400X 400WGVZ KZISZ-5	für Fahrzeuge mit Zweischeibenkupplung / for vehicles with double disc clutch Je nach Kundenwunsch mit unterschiedlicher Kupplung / Equipped with different clutch according to customer requirement	(77)		
			 1882 017 131	420 GF420XN	Nebenantriebs-ID / PTO ID: 130E	(50)		
			 1878 086 941	420 10 420WGTZ	Nebenantriebs-ID / PTO ID: 130E	(50)		
			 3483 000 510 ⊕	445 GMFZ445W	für Fahrzeuge mit Wandlerschaltkupplung / for vehicles with converter and clutch unit	(76)		
			 1878 051 801	445 24 445GTZC	für Fahrzeuge mit Wandlerschaltkupplung / for vehicles with converter and clutch unit	(76)		
			 3189 600 020		Getr. / GBox: ZF Ecosplit-3			
33.502 DF F29 33.502 DFA F30	09.91 - 06.96	D2840LF01, 04	 3400 122 201 ⊗ 3482 083 032 ⊗ 1878 004 832 ⊙ 3151 000 034	430 10 MFZ430 430WGTZ KZISZ-5	Je nach Kundenwunsch mit unterschiedlicher Kupplung / Equipped with different clutch according to customer requirement	(35)		
	09.91 - 06.96		 3400 121 901 ⊗ 3488 017 333 ⊗ 1862 303 031 ⊙ 3151 000 034	400 10 MFZ2/400X 400WGVZ KZISZ-5	für Fahrzeuge mit Zweischeibenkupplung / for vehicles with double disc clutch Je nach Kundenwunsch mit unterschiedlicher Kupplung / Equipped with different clutch according to customer requirement	(77)		
			 3483 000 510 ⊕	445 GMFZ445W	für Fahrzeuge mit Wandlerschaltkupplung / for vehicles with converter and clutch unit	(76)		
			 1878 051 801	445 24 445GTZC	für Fahrzeuge mit Wandlerschaltkupplung / for vehicles with converter and clutch unit	(76)		
			 3189 600 020		Getr. / GBox: ZF Ecosplit-3			
			01.94 - 01.90 -	D2865LF03, D2865LF06	 3400 127 601 ⊗ 3482 078 133 ⊗ 1862 364 031 ⊙ 3151 000 034	400 10 MFZ400 400WGVZ KZISZ-5	Nabenprofil / Hub Profile: 2"-10N Je nach Kundenwunsch mit unterschiedlicher Kupplung / Equipped with different clutch according to customer requirement	(48)
					 3400 122 301 ⊗ 3482 083 032 ⊗ 1878 080 034 ⊙ 3151 000 034	430 10 MFZ430 430WGTZ KZISZ-5	Je nach Kundenwunsch mit unterschiedlicher Kupplung / Equipped with different clutch according to customer requirement	(35)
 1882 017 131	420 GF420XN	Nebenantriebs-ID / PTO ID: 130E			(50)			
 1878 086 941	420 10 420WGTZ	Nebenantriebs-ID / PTO ID: 130E			(50)			
 3151 204 001	KZI-6	mit Schmierrohranschluss / with lubrication pipe connection Nebenantriebs-ID / PTO ID: 130E			(91)			
 3189 600 020		Getr. / GBox: ZF Ecosplit-3						
34.342 F14 36.342 F14	01.94 - 01.94 -	D2865LF	 3400 122 301 ⊗ 3482 083 032 ⊗ 1878 080 034 ⊙ 3151 000 034	430 10 MFZ430 430WGTZ KZISZ-5				
	01.94 -		 1882 017 131	420 GF420XN	Nebenantriebs-ID / PTO ID: 130E	(50)		
			 1878 086 941	420 10 420WGTZ	Nebenantriebs-ID / PTO ID: 130E	(50)		
			 3151 204 001	KZI-6	mit Schmierrohranschluss / with lubrication pipe connection Nebenantriebs-ID / PTO ID: 130E	(91)		
			 3189 600 020		Getr. / GBox: ZF Ecosplit-3	(50)		



























		CODE				
--	--	------	--	---	---	---

MAN

F 90		06.86 - 12.97					
34.372 F14	01.90 -	D2865LF01, 03, 06	 3400 127 601 ⊗ 3482 078 133 ⊗ 1862 364 031 ⊙ 3151 000 034	400 10 MFZ400 400WGVZ KZISZ-5	Nabenprofil / Hub Profile: 2"-10N Je nach Kundenwunsch mit unterschiedlicher Kupplung / Equipped with different clutch according to customer requirement	(48)	
			 3400 122 301 ⊗ 3482 083 032 ⊗ 1878 080 034 ⊙ 3151 000 034	430 10 MFZ430 430WGTZ KZISZ-5	Je nach Kundenwunsch mit unterschiedlicher Kupplung / Equipped with different clutch according to customer requirement	(35)	
		D2865LF	 1882 017 131	420 GF420XN	Nebenantriebs-ID / PTO ID: 130E	(50)	
			 1878 086 941	420 10 420WGTZ	Nebenantriebs-ID / PTO ID: 130E	(50)	
			 3151 204 001	KZI-6	mit Schmierrohranschluss / with lubrication pipe connection Nebenantriebs-ID / PTO ID: 130E	(91) (50)	
		 3189 600 020		Getr. / GBox: ZF Ecosplit-3			
34.402 F14 36.402 F14 36.422 F14	01.94 - 01.94 - 01.90 -	D2866, D2866LF	 3400 122 201 ⊗ 3482 083 032 ⊗ 1878 004 832 ⊙ 3151 000 034	430 10 MFZ430 430WGTZ KZISZ-5			
			 1882 017 131	420 GF420XN	Nebenantriebs-ID / PTO ID: 130E	(50)	
			 1878 086 941	420 10 420WGTZ	Nebenantriebs-ID / PTO ID: 130E	(50)	
			 3151 204 001	KZI-6	mit Schmierrohranschluss / with lubrication pipe connection Nebenantriebs-ID / PTO ID: 130E	(91) (50)	
			 3189 600 020		Getr. / GBox: ZF Ecosplit-3		
			35.262 VF F14 35.262 VFA F14 35.262 VFK F14 35.272 VF F14 35.272 VFK F14	02.89 - 02.90 07.89 - 02.90 02.89 - 02.90 02.90 - 12.91 02.90 - 12.92	D2865LF02, D2865LF/260	 3400 700 310 ⊗ 3482 078 133 ⊗ 1862 364 133 ⊙ 3151 000 034	400 10 MFZ400 400WGVZ KZISZ-5
 1882 017 131	420 GF420XN	Nebenantriebs-ID / PTO ID: 130E				(50)	
 1878 086 941	420 10 420WGTZ	Nebenantriebs-ID / PTO ID: 130E				(50)	
 3151 204 001	KZI-6	mit Schmierrohranschluss / with lubrication pipe connection Nebenantriebs-ID / PTO ID: 130E				(91) (50)	
 3189 600 020		Getr. / GBox: ZF Ecosplit-3					
35.292 VF F14 35.292 VFK F14	10.88 - 04.95 10.88 - 04.95	D2866LF				 3400 127 601 ⊗ 3482 078 133 ⊗ 1862 364 031 ⊙ 3151 000 034	400 10 MFZ400 400WGVZ KZISZ-5
			 3400 122 201 ⊗ 3482 083 032 ⊗ 1878 004 832 ⊙ 3151 000 034	430 10 MFZ430 430WGTZ KZISZ-5	->12.1993 E15,F14 Je nach Kundenwunsch mit unterschiedlicher Kupplung / Equipped with different clutch according to customer requirement	(35)	
			 1882 017 131	420 GF420XN	Nebenantriebs-ID / PTO ID: 130E	(50)	
			 1878 086 941	420 10 420WGTZ	Nebenantriebs-ID / PTO ID: 130E	(50)	
		 3151 204 001	KZI-6	mit Schmierrohranschluss / with lubrication pipe connection Nebenantriebs-ID / PTO ID: 130E	(91) (50)		
		 3189 600 020		Getr. / GBox: ZF Ecosplit-3			
		D2866LFZ/290	 3189 600 020		Getr. / GBox: ZF Ecosplit-3		
			35.302 VF F14 35.302 VFK F14	05.90 - 09.91 05.90 - 09.91	D2866LF04	 3400 127 601 ⊗ 3482 078 133 ⊗ 1862 364 031 ⊙ 3151 000 034	400 10 MFZ400 400WGVZ KZISZ-5
 3189 600 020						Getr. / GBox: ZF Ecosplit-3	
D2866LF	 1882 017 131				420 GF420XN	Nebenantriebs-ID / PTO ID: 130 E	(50)
	 1878 086 941	420 10 420WGTZ			Nebenantriebs-ID / PTO ID: 130 E	(50)	
 3151 204 001	KZI-6	mit Schmierrohranschluss / with lubrication pipe connection Nebenantriebs-ID / PTO ID: 130 E	(91) (50)				





























		CODE				
--	--	------	--	---	---	---

MAN

F 90		06.86 - 12.97					
35.322 VFAK E15 35.322 VFK E15	02.90 - 06.96	D2865LF03, 06	 3400 127 601 ⊗ 3482 078 133 ⊗ 1862 364 031 ⊙ 3151 000 034	400 10 MFZ400 400WGVZ KZISZ-5	Nabenprofil / Hub Profile: 2"-10N	(48)	
	02.90 - 06.96	D2865LF	 1882 017 131	420 GF420XN	Nebenantriebs-ID / PTO ID: 130E	(50)	
			 1878 086 941	420 10 420WGTZ	Nebenantriebs-ID / PTO ID: 130E	(50)	
			 3151 204 001	KZI-6	mit Schmierrohranschluss / with lubrication pipe connection Nebenantriebs-ID / PTO ID: 130E	(91)	
	02.90 - 06.96	D2865LF03, D2865LF06	 3483 000 510 ⊕	445 GMFZ445W	für Fahrzeuge mit Wandlerschaltkupplung / for vehicles with converter and clutch unit	(76)	
			 1878 051 801	445 24 445GTZC	für Fahrzeuge mit Wandlerschaltkupplung / for vehicles with converter and clutch unit	(76)	
 3189 600 020				Getr. / GBox: ZF Ecosplit-3			
35.322 VFK F14 35.322 VK F14	02.90 - 06.96	D2865LF03, 06	 3400 127 601 ⊗ 3482 078 133 ⊗ 1862 364 031 ⊙ 3151 000 034	400 10 MFZ400 400WGVZ KZISZ-5	Nabenprofil / Hub Profile: 2"-10N	(48)	
	02.90 - 06.96	D2865LF	 1882 017 131	420 GF420XN	Nebenantriebs-ID / PTO ID: 130E	(50)	
			 1878 086 941	420 10 420WGTZ	Nebenantriebs-ID / PTO ID: 130E	(50)	
			 3151 204 001	KZI-6	mit Schmierrohranschluss / with lubrication pipe connection Nebenantriebs-ID / PTO ID: 130E	(91)	
	02.90 - 06.96	D2865LF03, D2865LF06	 3189 600 020		Getr. / GBox: ZF Ecosplit-3		
	35.342 VF F14 35.342 VFK F14	05.94 - 06.96	D2865	 3400 122 301 ⊗ 3482 083 032 ⊗ 1878 080 034 ⊙ 3151 000 034	430 10 MFZ430 430WGTZ KZISZ-5	F14	
05.94 - 06.96		D2865	 1882 017 131	420 GF420XN	Nebenantriebs-ID / PTO ID: 130E	(50)	
			 1878 086 941	420 10 420WGTZ	Nebenantriebs-ID / PTO ID: 130E	(50)	
			 3151 204 001	KZI-6	mit Schmierrohranschluss / with lubrication pipe connection Nebenantriebs-ID / PTO ID: 130E	(91)	
05.94 - 06.96		D2865LF09	 3189 600 020		Getr. / GBox: ZF Ecosplit-3		
35.372 VF F14 35.372 VF F14 35.372 VFK F14 35.372 VFK F14	02.90 - 06.96	D2866LF01, 03, 04, 05	 3400 127 601 ⊗ 3482 078 133 ⊗ 1862 364 031 ⊙ 3151 000 034	400 10 MFZ400 400WGVZ KZISZ-5	E15,F14 Nabenprofil / Hub Profile: 2"-10N	(48)	
	02.90 - 12.97	D2866LF03, D2866LF05, D2866LF15	 3400 122 201 ⊗ 3482 083 032 ⊗ 1878 004 832 ⊙ 3151 000 034	430 10 MFZ430 430WGTZ KZISZ-5	Je nach Kundenwunsch mit unterschiedlicher Kupplung / Equipped with different clutch according to customer requirement	(35)	
	02.90 - 06.96				Getr. / GBox: ZF Ecosplit-3		
	02.90 - 12.97		 3189 600 020		Getr. / GBox: ZF Ecosplit-3		
35.402 VF F14 35.402 VF F14 35.402 VFK F14 35.402 VFK F14	05.94 - 06.96	D2866	 3400 122 201 ⊗ 3482 083 032 ⊗ 1878 004 832 ⊙ 3151 000 034	430 10 MFZ430 430WGTZ KZISZ-5	F14		
	05.94 - 12.97	D2866LF16	 1882 017 131	420 GF420XN	Nebenantriebs-ID / PTO ID: 130E	(50)	
	05.94 - 06.96				 1878 086 941	420 10 420WGTZ	Nebenantriebs-ID / PTO ID: 130E
	05.94 - 12.97		 3189 600 020		Getr. / GBox: ZF Ecosplit-3		
35.422 VF F14 35.422 VF F14 35.422 VFK F14 35.422 VFK F14	02.90 - 06.96	D2866LF09	 3400 122 201 ⊗ 3482 083 032 ⊗ 1878 004 832 ⊙ 3151 000 034	430 10 MFZ430 430WGTZ KZISZ-5			
	02.90 - 12.97	D2866LF06, D2866LF09	 3189 600 020				
	02.90 - 06.96				Getr. / GBox: ZF Ecosplit-3		
	02.90 - 12.97						

























		CODE				
--	--	------	--	---	---	---















MAN









F 90		06.86 - 12.97					
36.262	01.91 -	D2866LF,		1882 017 131	420	Nebenantriebs-ID / PTO ID: 130E	(50)
36.272	01.91 -	D2865LF			GF420XN		
36.292	01.91 -			1878 086 941	420 10	Nebenantriebs-ID / PTO ID: 130E	(50)
36.332	01.91 -				420WGTZ		
36.362 F14	01.88 - 12.93	D2866KF		3400 122 201 ⊕ 3482 083 032 ⊕ 1878 004 832 ⊕ 3151 000 034	430 10 MFZ430 430WGTZ KZISZ-5		
		D2865		1882 017 131	420	Nebenantriebs-ID / PTO ID: 130E	(50)
				1878 086 941	420 10	Nebenantriebs-ID / PTO ID: 130E	(50)
				3151 204 001	KZI-6	mit Schmierrohranschluss / with lubrication pipe connection	(91)
						Nebenantriebs-ID / PTO ID: 130E	(50)
				3189 600 020		Getr. / GBox: ZF Ecosplit-3	
36.372 F14	01.90 -	D2866LF		3400 127 601 ⊕ 3482 078 133 ⊕ 1862 364 031 ⊕ 3151 000 034	400 10 MFZ400 400WGVZ KZISZ-5	Nabenprofil / Hub Profile: 2"-10N Je nach Kundenwunsch mit unterschiedlicher Kupplung / Equipped with different clutch according to customer requirement	(48) (35)
				3400 122 201 ⊕ 3482 083 032 ⊕ 1878 004 832 ⊕ 3151 000 034	430 10 MFZ430 430WGTZ KZISZ-5	Je nach Kundenwunsch mit unterschiedlicher Kupplung / Equipped with different clutch according to customer requirement	(35)
				1882 017 131	420	Nebenantriebs-ID / PTO ID: 130E	(50)
				1878 086 941	420 10	Nebenantriebs-ID / PTO ID: 130E	(50)
				3151 204 001	KZI-6	mit Schmierrohranschluss / with lubrication pipe connection	(91)
						Nebenantriebs-ID / PTO ID: 130E	(50)
				3189 600 020		Getr. / GBox: ZF Ecosplit-3	
38.372		D2866LF03, D2866LF05, D2866LF01		3400 127 601 ⊕ 3482 078 133 ⊕ 1862 364 031 ⊕ 3151 000 034	400 10 MFZ400 400WGVZ KZISZ-5	01.1989-> F17 Nabenprofil / Hub Profile: 2"-10N	(48)
				3400 121 901 ⊕ 3488 017 333 ⊕ 1862 303 031 ⊕ 3151 000 034	400 10 MFZ2/400X 400WGVZ KZISZ-5	01.1991-> F12 für Fahrzeuge mit Zweischeibenkupplung / for vehicles with double disc clutch	(77)
				3189 600 020		Getr. / GBox: ZF Ecosplit-3	
40.362 F12	01.90 -	D2866KF		3400 121 901 ⊕ 3488 017 333 ⊕ 1862 303 031 ⊕ 3151 000 034	400 10 MFZ2/400X 400WGVZ KZISZ-5	für Fahrzeuge mit Zweischeibenkupplung / for vehicles with double disc clutch	(77)
				3483 000 510 ⊕	445 GMFZ445W	für Fahrzeuge mit Wandlerkupplung / for vehicles with converter and clutch unit	(76)
				1878 051 801	445 24 445GTZC	für Fahrzeuge mit Wandlerkupplung / for vehicles with converter and clutch unit	(76)
				3151 032 341	KZIZ-5	für Fahrzeuge mit Wandlerkupplung / for vehicles with converter and clutch unit	(76)
				3189 600 020		Getr. / GBox: ZF Ecosplit-3	
40.372 DF F11	12.91 - 06.96	D2866LF01, 03, 05		3400 121 901 ⊕ 3488 017 333 ⊕ 1862 303 031 ⊕ 3151 000 034	400 10 MFZ2/400X 400WGVZ KZISZ-5	für Fahrzeuge mit Zweischeibenkupplung / for vehicles with double disc clutch	(77)
40.422 F11	01.90 -	D2866LF03, D2866LF05, D2866LF15		3483 000 510 ⊕	445 GMFZ445W	für Fahrzeuge mit Wandlerkupplung / for vehicles with converter and clutch unit	(76)
				1878 051 801	445 24 445GTZC	für Fahrzeuge mit Wandlerkupplung / for vehicles with converter and clutch unit	(76)
				3189 600 020		Getr. / GBox: ZF Ecosplit-3	
40.372 DFA F12	12.91 - 06.96	D2866LF03, D2866LF05, D2866LF16, D2866LF15		3483 000 510 ⊕	445 GMFZ445W	für Fahrzeuge mit Wandlerkupplung / for vehicles with converter and clutch unit	(76)
40.402 DFA F12	05.95 - 06.96			1878 051 801	445 24 445GTZC	für Fahrzeuge mit Wandlerkupplung / for vehicles with converter and clutch unit	(76)
				3151 032 341	KZIZ-5	für Fahrzeuge mit Wandlerkupplung / for vehicles with converter and clutch unit	(76)

		CODE				
--	--	------	--	---	---	---

MAN

F 90		06.86 - 12.97						
40.402 DF F11 40.422 DF F11	05.95 - 06.96	D2866LF16, D2866LF06, D2866LF09	 3400 122 201 ⊗ 3482 083 032 ⊗ 1878 004 832 ⊙ 3151 000 034	430 10 MFZ430 430WGTZ KZISZ-5				
	12.91 - 06.96		 3400 121 901 ⊗ 3488 017 333 ⊗ 1862 303 031 ⊙ 3151 000 034	400 10 MFZ2/400X 400WGVZ KZISZ-5	für Fahrzeuge mit Zweischeibenkupplung / for vehicles with double disc clutch	(77)		
			 3189 600 020		Getr. / GBox: ZF Ecosplit-3			
40.422 DFA F12	12.91 - 06.96	D2866LF06, D2866LF09	 3400 122 201 ⊗ 3482 083 032 ⊗ 1878 004 832 ⊙ 3151 000 034	430 10 MFZ430 430WGTZ KZISZ-5	Je nach Kundenwunsch mit unterschiedlicher Kupplung / Equipped with different clutch according to customer requirement	(35)		
			 3400 121 901 ⊗ 3488 017 333 ⊗ 1862 303 031 ⊙ 3151 000 034	400 10 MFZ2/400X 400WGVZ KZISZ-5	für Fahrzeuge mit Zweischeibenkupplung / for vehicles with double disc clutch	(77)		
				 3483 000 510 ⊕	445 GMFZ445W	für Fahrzeuge mit Wandlerschaltkupplung / for vehicles with converter and clutch unit	(76)	
				 1878 051 801	445 24 445GTZC	für Fahrzeuge mit Wandlerschaltkupplung / for vehicles with converter and clutch unit	(76)	
				 3151 032 341	KZIZ-5	für Fahrzeuge mit Wandlerschaltkupplung / for vehicles with converter and clutch unit	(76)	
				 3189 600 020		Getr. / GBox: ZF Ecosplit-3		
40.462 DFA F32 40.502 DFA F32	07.89 - 02.90	D2840LF04, D2840LF460, D2840LF01, D2840LF06	 3400 122 201 ⊗ 3482 083 032 ⊗ 1878 004 832 ⊙ 3151 000 034	430 10 MFZ430 430WGTZ KZISZ-5				
	02.90 - 06.96		 3400 121 901 ⊗ 3488 017 333 ⊗ 1862 303 031 ⊙ 3151 000 034	400 10 MFZ2/400X 400WGVZ KZISZ-5	für Fahrzeuge mit Zweischeibenkupplung / for vehicles with double disc clutch	(77)		
			 3400 700 327 ⊗ 3482 114 031 ⊗ 1878 004 832 ⊙ 3151 263 031	430 10 GMFZ430N 430WGTZ KZIZ-6	Nebenantriebs-ID / PTO ID: NMV-221	(50)		
			 3400 700 641 HD ⊗ 3482 114 031 ⊗ 1878 007 729 ⊙ 3151 263 031	430 10 GMFZ430N 430WGTZ KZIZ-6	Nebenantriebs-ID / PTO ID: NMV 221	(50)		
			 3189 600 020		Getr. / GBox: ZF Ecosplit-3			
41.292 VF F14 41.292 VFK F14 41.332 VF F14 41.332 VFK F14	10.88 - 02.90	D2866LF/290, D2866LF/330	 3400 127 601 ⊗ 3482 078 133 ⊗ 1862 364 031 ⊙ 3151 000 034	400 10 MFZ400 400WGVZ KZISZ-5	E15,26,F14 Nabenprofil / Hub Profile: 2"-10N	(48)		
	10.88 - 02.90			Je nach Kundenwunsch mit unterschiedlicher Kupplung / Equipped with different clutch according to customer requirement	(35)			
	10.88 - 02.90		 3400 122 201 ⊗ 3482 083 032 ⊗ 1878 004 832 ⊙ 3151 000 034	430 10 MFZ430 430WGTZ KZISZ-5	E15,26,F14 Je nach Kundenwunsch mit unterschiedlicher Kupplung / Equipped with different clutch according to customer requirement	(35)		
	10.88 - 02.90		 1882 017 131	420 GF420XN	Nebenantriebs-ID / PTO ID: 130E	(50)		
			 1878 086 941	420 10 420WGTZ	Nebenantriebs-ID / PTO ID: 130E	(50)		
			 3189 600 020		Getr. / GBox: ZF Ecosplit-3			
41.322 VF F14	02.90 - 06.96	D2865LF03, D2865LF06	 3400 127 601 ⊗ 3482 078 133 ⊗ 1862 364 031 ⊙ 3151 000 034	400 10 MFZ400 400WGVZ KZISZ-5	E15,F14 Nabenprofil / Hub Profile: 2"-10N Je nach Kundenwunsch mit unterschiedlicher Kupplung / Equipped with different clutch according to customer requirement	(48)	(35)	
			 3400 122 301 ⊗ 3482 083 032 ⊗ 1878 080 034 ⊙ 3151 000 034	430 10 MFZ430 430WGTZ KZISZ-5	E15,F14 Je nach Kundenwunsch mit unterschiedlicher Kupplung / Equipped with different clutch according to customer requirement	(35)		
			 1882 017 131	420 GF420XN	Nebenantriebs-ID / PTO ID: 130E	(50)		
			 1878 086 941	420 10 420WGTZ	Nebenantriebs-ID / PTO ID: 130E	(50)		
			 3189 600 020		Getr. / GBox: ZF Ecosplit-3			

























F 90		06.86 - 12.97					
41.362 VF F14 41.362 VFK F14	10.88 - 02.90	D2866KF, KU, LXF		3400 122 201 ⊗ 3482 083 032 ⊗ 1878 004 832 ⊙ 3151 000 034	430 10 MFZ430 430WGTZ KZISZ-5	E12,15,26,F14	
	10.88 - 02.90	D2866LXF		1882 017 131	420 GF420XN	Nebenantriebs-ID / PTO ID: 130E	(50)
				1878 086 941	420 10 420WGTZ	Nebenantriebs-ID / PTO ID: 130E	(50)
				3189 600 020		Getr. / GBox: ZF Ecosplit-3	
41.372 VF F14	02.90 - 06.96	D2866LF01, 03, 04, 05		3400 127 601 ⊗ 3482 078 133 ⊗ 1862 364 031 ⊙ 3151 000 034	400 10 MFZ400 400WGVZ KZISZ-5	E15,F14 Nabenprofil / Hub Profile: 2"-10N Je nach Kundenwunsch mit unterschiedlicher Kupplung / Equipped with different clutch according to customer requirement	(48) (35)
				3400 122 201 ⊗ 3482 083 032 ⊗ 1878 004 832 ⊙ 3151 000 034	430 10 MFZ430 430WGTZ KZISZ-5	E15,F14 Je nach Kundenwunsch mit unterschiedlicher Kupplung / Equipped with different clutch according to customer requirement	(35)
				1882 017 131	420 GF420XN	Nebenantriebs-ID / PTO ID: 130E	(50)
		D2866		1878 086 941	420 10 420WGTZ	Nebenantriebs-ID / PTO ID: 130E	(50)
				3189 600 020		Getr. / GBox: ZF Ecosplit-3	
			D2866LF03, D2866LF05, D2866LF15		3189 600 020		Getr. / GBox: ZF Ecosplit-3
41.422 VF F14	02.90 - 06.96	D2866LF06, D2866LF09		3400 122 201 ⊗ 3482 083 032 ⊗ 1878 004 832 ⊙ 3151 000 034	430 10 MFZ430 430WGTZ KZISZ-5	E12,15,26,F14	
				1882 017 131	420 GF420XN	Nebenantriebs-ID / PTO ID: 130E	(50)
				1878 086 941	420 10 420WGTZ	Nebenantriebs-ID / PTO ID: 130E	(50)
				3189 600 020		Getr. / GBox: ZF Ecosplit-3	

F 90 Unterflur		06.86 - 09.96					
14.262 U20 14.272 U20 17.262 U20 17.272 U20	01.89 - 12.94	D2865LF		3400 700 310 ⊗ 3482 078 133 ⊗ 1862 364 133 ⊙ 3151 000 034	400 10 MFZ400 400WGVZ KZISZ-5	Getr. / GBox: ZF Nabenprofil / Hub Profile: 1 3/4"-10N	(48)
	01.90 - 12.94			3400 127 601 ⊗ 3482 078 133 ⊗ 1862 364 031 ⊙ 3151 000 034	400 10 MFZ400 400WGVZ KZISZ-5	Getr. / GBox: Fuller Nabenprofil / Hub Profile: 2"-10N	(48)
	01.89 - 12.94			3189 600 020		Getr. / GBox: ZF Ecosplit-3	
16.332 U01,03 22.332 U05,06 25.332 U05,06 26.332 U05,06 16.372	01.86 - 12.92	D2866LF, LU		3400 122 201 ⊗ 3482 083 032 ⊗ 1878 004 832 ⊙ 3151 000 034	430 10 MFZ430 430WGTZ KZISZ-5		
	01.86 - 12.92			3189 600 020		Getr. / GBox: ZF Ecosplit-3	
	01.86 - 12.92			3400 127 601 ⊗ 3482 078 133 ⊗ 1862 364 031 ⊙ 3151 000 034	400 10 MFZ400 400WGVZ KZISZ-5	01.1989-> U11 Nabenprofil / Hub Profile: 2"-10N	(48)
16.372		D2866LF03		3400 122 201 ⊗ 3482 083 032 ⊗ 1878 004 832 ⊙ 3151 000 034	430 10 MFZ430 430WGTZ KZISZ-5	01.1990-> U13	
				3189 600 020		Getr. / GBox: ZF Ecosplit-3	



MAN























F 90 Unterflur		06.86 - 09.96				
19.322 U, 19.322 UL, 19.322 ULL U13 U11	02.90 - 05.94	D2865LF03, 06	3400 127 601 Ⓢ 3482 078 133 Ⓢ 1862 364 031 Ⓢ 3151 000 034	400 10 MFZ400 400WGVZ KZISZ-5	->07.1993 F01,02,03,04,U11 Nabenprofil / Hub Profile: 2"-10N	(48)
			3400 122 301 Ⓢ 3482 083 032 Ⓢ 1878 080 034 Ⓢ 3151 000 034	430 10 MFZ430 430WGTZ KZISZ-5	08.1993-> F01,02,03,04,U11	
		D2865	1882 017 131	420 GF420XN		
			1878 086 941	420 10 420WGTZ		
		D2865LF03, D2865LF06, D2865LUH08	3189 600 020		Getr. / GBox: ZF Ecosplit-3	
19.332 U, 19.322 UL, 19.322 ULL U01 U03	07.86 - 02.90	D2866LF, LU	3400 122 201 Ⓢ 3482 083 032 Ⓢ 1878 004 832 Ⓢ 3151 000 034	430 10 MFZ430 430WGTZ KZISZ-5	U01,03	
		D2866	1882 017 131	420 GF420XN	für Nebenantrieb / for PTO	(82)
			1878 086 941	420 10 420WGTZ	für Nebenantrieb / for PTO	(82)
		D2866LUL/330	3189 600 020		Getr. / GBox: ZF Ecosplit-3	
19.362 U, 19.362 UL, 19.362 ULL U01 U03	07.86 - 01.91	D2866KF, LU	3400 122 201 Ⓢ 3482 083 032 Ⓢ 1878 004 832 Ⓢ 3151 000 034	430 10 MFZ430 430WGTZ KZISZ-5	U01,03,11,13	
		D2866	1882 017 131	420 GF420XN	für Nebenantrieb / for PTO	(82)
			1878 086 941	420 10 420WGTZ	für Nebenantrieb / for PTO	(82)
		D2866KUL	3189 600 020		Getr. / GBox: ZF Ecosplit-3	
19.372 U, 19.372 ULL U11 U13	02.90 - 05.94	D2866LF03	3400 127 601 Ⓢ 3482 078 133 Ⓢ 1862 364 031 Ⓢ 3151 000 034	400 10 MFZ400 400WGVZ KZISZ-5	U11 Nabenprofil / Hub Profile: 2"-10N	(48)
			3400 122 201 Ⓢ 3482 083 032 Ⓢ 1878 004 832 Ⓢ 3151 000 034	430 10 MFZ430 430WGTZ KZISZ-5	U13	
		D2866	1882 017 131	420 GF420XN	für Nebenantrieb / for PTO	(82)
			1878 086 941	420 10 420WGTZ	für Nebenantrieb / for PTO	(82)
		D2866LF03, D2866LF05	3189 600 020		Getr. / GBox: ZF Ecosplit-3	
19.422 U, 19.422 ULL U11 U13	02.90 - 05.94	D2866LF06, 09	3400 122 201 Ⓢ 3482 083 032 Ⓢ 1878 004 832 Ⓢ 3151 000 034	430 10 MFZ430 430WGTZ KZISZ-5	F01,02,03,04,U11	
		D2866	1882 017 131	420 GF420XN	für Nebenantrieb / for PTO	(82)
			1878 086 941	420 10 420WGTZ	für Nebenantrieb / for PTO	(82)
		D2866LF06, D2866LF09	3189 600 020		Getr. / GBox: ZF Ecosplit-3	
22.322 U15	01.89 -	D2865LF03, 06	3400 127 601 Ⓢ 3482 078 133 Ⓢ 1862 364 031 Ⓢ 3151 000 034	400 10 MFZ400 400WGVZ KZISZ-5	Nabenprofil / Hub Profile: 2"-10N	(48)
			3189 600 020		Getr. / GBox: ZF Ecosplit-3	
22.362 U05,06,16 25.362 U05,06,16 26.362 U05,06,16	01.86 -	D2866KF, LU	3400 122 201 Ⓢ 3482 083 032 Ⓢ 1878 004 832 Ⓢ 3151 000 034	430 10 MFZ430 430WGTZ KZISZ-5		
	01.86 -					
	01.86 -		3189 600 020		Getr. / GBox: ZF Ecosplit-3	

F 90 Unterflur		06.86 - 09.96				
22.372	01.90-	D2866LF03	 3400 127 601 ⊗ 3482 078 133 ⊗ 1862 364 031 ⊙ 3151 000 034	400 10 MFZ400 400WGVZ KZISZ-5	U15 Nabenprofil / Hub Profile: 2"-10N	(48)
			 3400 122 201 ⊗ 3482 083 032 ⊗ 1878 004 832 ⊙ 3151 000 034	430 10 MFZ430 430WGTZ KZISZ-5	U16	
			 3189 600 020		Getr. / GBox: ZF Ecosplit-3	
22.422 U15	01.89-	D2866LF06	 3400 122 201 ⊗ 3482 083 032 ⊗ 1878 004 832 ⊙ 3151 000 034	430 10 MFZ430 430WGTZ KZISZ-5		
			 3189 600 020		Getr. / GBox: ZF Ecosplit-3	
23.362 U07	01.88-	D2866LF, KUL	 3400 122 201 ⊗ 3482 083 032 ⊗ 1878 004 832 ⊙ 3151 000 034	430 10 MFZ430 430WGTZ KZISZ-5		
			 3189 600 020		Getr. / GBox: ZF Ecosplit-3	
24.322 UNL,24.322 UNLL U15 U16	02.90 - 12.90	D2865LF03	 3400 127 601 ⊗ 3482 078 133 ⊗ 1862 364 031 ⊙ 3151 000 034	400 10 MFZ400 400WGVZ KZISZ-5	U15 Nabenprofil / Hub Profile: 2"-10N	(48)
			 3189 600 020		Getr. / GBox: ZF Ecosplit-3	
		D2865	 1882 017 131	420 GF420XN	07.1990-> für Nebenantrieb / for PTO	(82)
			 1878 086 941	420 10 420WGTZ	07.1990-> für Nebenantrieb / for PTO	(82)
		 3151 204 001	KZI-6	07.1990-> für Nebenantrieb / for PTO mit Schmierrohranschluss / with lubrication pipe connection	(82) (91)	
24.332 UNL,24.332 UNLL U05 U06 U07 24.362 UNL,24.362 UNLL U06 U05 U07	10.86 - 02.90	D2866KF, LU	 3400 122 201 ⊗ 3482 083 032 ⊗ 1878 004 832 ⊙ 3151 000 034	430 10 MFZ430 430WGTZ KZISZ-5	U05,06,16	
	10.86 - 02.90		 3189 600 020		Getr. / GBox: ZF Ecosplit-3	
24.372 UNL,24.372 UNLL U07 U15 U16	02.90 - 12.90	D2866LF03	 3400 122 201 ⊗ 3482 083 032 ⊗ 1878 004 832 ⊙ 3151 000 034	430 10 MFZ430 430WGTZ KZISZ-5	U16	
			 3400 127 601 ⊗ 3482 078 133 ⊗ 1862 364 031 ⊙ 3151 000 034	400 10 MFZ400 400WGVZ KZISZ-5	U15 Nabenprofil / Hub Profile: 2"-10N	(48)
		 3189 600 020		Getr. / GBox: ZF Ecosplit-3		
		D2866	 1882 017 131	420 GF420XN	07.1990-> für Nebenantrieb / for PTO	(82)
 1878 086 941	420 10 420WGTZ		07.1990-> für Nebenantrieb / for PTO	(82)		
 3151 204 001	KZI-6		07.1990-> für Nebenantrieb / for PTO mit Schmierrohranschluss / with lubrication pipe connection	(82) (91)		
24.422 UNL,24.422 UNLL U15 U16 U07	02.90 - 12.90	D2866LF06	 3400 122 201 ⊗ 3482 083 032 ⊗ 1878 004 832 ⊙ 3151 000 034	430 10 MFZ430 430WGTZ KZISZ-5	F20,U15	
			 3189 600 020		Getr. / GBox: ZF Ecosplit-3	
		D2866	 1882 017 131	420 GF420XN	07.1990-> für Nebenantrieb / for PTO	(82)
			 1878 086 941	420 10 420WGTZ	07.1990-> für Nebenantrieb / for PTO	(82)
		 3151 204 001	KZI-6	07.1990-> für Nebenantrieb / for PTO mit Schmierrohranschluss / with lubrication pipe connection	(82) (91)	

		CODE				
--	--	------	--	---	---	---

MAN

























F 90 Unterflur 06.86 - 09.96

25.322 UNL,25.322 UNLL U16 U15	09.90 - 12.92	D2865LF03		3400 127 601 ⊗ 3482 078 133 ⊗ 1862 364 031 ⊙ 3151 000 034	400 10 MFZ400 400WGVZ KZISZ-5	U15 Nabenprofil / Hub Profile: 2"-10N	(48)
		D2865		1882 017 131	420 GF420XN	für Nebenantrieb / for PTO	(82)
				1878 086 941	420 10 420WGTZ	für Nebenantrieb / for PTO	(82)
		D2865LF03, D2865LF06		3189 600 020		Getr. / GBox: ZF Ecosplit-3	
25.372 UNL,25.372 UNLL U16 U15 U07	09.90 - 12.92	D2866LF03		3400 127 601 ⊗ 3482 078 133 ⊗ 1862 364 031 ⊙ 3151 000 034	400 10 MFZ400 400WGVZ KZISZ-5	U15 Nabenprofil / Hub Profile: 2"-10N	(48)
		D2866		3400 122 201 ⊗ 3482 083 032 ⊗ 1878 004 832 ⊙ 3151 000 034	430 10 MFZ430 430WGTZ KZISZ-5	U16	
				1882 017 131	420 GF420XN	für Nebenantrieb / for PTO	(82)
		D2866LF03, D2866LF05		1878 086 941	420 10 420WGTZ	für Nebenantrieb / for PTO	(82)
	3189 600 020			Getr. / GBox: ZF Ecosplit-3			
25.422 UNL,25.422 UNLL U07 U16 U15	09.90 - 12.92	D2866LF06		3400 122 201 ⊗ 3482 083 032 ⊗ 1878 004 832 ⊙ 3151 000 034	430 10 MFZ430 430WGTZ KZISZ-5	U15	
		D2866		1882 017 131	420 GF420XN	für Nebenantrieb / for PTO	(82)
				1878 086 941	420 10 420WGTZ	für Nebenantrieb / for PTO	(82)
		D2866LF06, D2866LF09		3189 600 020		Getr. / GBox: ZF Ecosplit-3	
26.322 UNL,26.322 UNLL U15 U16	09.90 - 05.94	D2865LF03		3400 127 601 ⊗ 3482 078 133 ⊗ 1862 364 031 ⊙ 3151 000 034	400 10 MFZ400 400WGVZ KZISZ-5	U15,16,18,19 Nabenprofil / Hub Profile: 2"-10N	(48)
		D2865		1882 017 131	420 GF420XN	für Nebenantrieb / for PTO	(82)
				1878 086 941	420 10 420WGTZ	für Nebenantrieb / for PTO	(82)
		D2865LF03, D2865LF06		3189 600 020		Getr. / GBox: ZF Ecosplit-3	
26.372 UNL,26.372 UNLL U15 U16	09.90 - 05.94	D2866LF03		3400 127 601 ⊗ 3482 078 133 ⊗ 1862 364 031 ⊙ 3151 000 034	400 10 MFZ400 400WGVZ KZISZ-5	U 15 Nabenprofil / Hub Profile: 2"-10N	(48)
		D2866LF03, D2866LF05		3400 122 201 ⊗ 3482 083 032 ⊗ 1878 004 832 ⊙ 3151 000 034	430 10 MFZ430 430WGTZ KZISZ-5	U 16	
				3189 600 020		Getr. / GBox: ZF Ecosplit-3	
		D2866LF06, D2866LF09		3189 600 020		Getr. / GBox: ZF Ecosplit-3	
26.422 UNL,26.422 UNLL U15 U16	09.90 - 05.94	D2866LF06		3400 122 201 ⊗ 3482 083 032 ⊗ 1878 004 832 ⊙ 3151 000 034	430 10 MFZ430 430WGTZ KZISZ-5	U 15	
		D2866LF06, D2866LF09		3189 600 020		Getr. / GBox: ZF Ecosplit-3	



























G 10.79 - 08.88

6.90 F 560	10.79 - 09.87	D0224		3400 124 201 # ⊗ 3482 032 331 ⊗ 1861 841 132 ⊙ 3151 600 541	280 28 MFZ280 280GTPZ KZIZ-2	560	
6.90 FK 560	10.79 - 09.87						
8.90 F 560	10.79 - 09.87						
8.90 FK 560	10.79 - 09.87						

G	10.79 - 08.88					
----------	----------------------	--	--	--	--	--





















































8.136 F,8.136 FL 561 8.136 FK 561	10.79-09.87	D0226		3400 124 201 #  3482 032 331  1861 841 132  3151 600 541	280 28 MFZ280 280GTPZ KZIZ-2	561	
	10.79-08.88			3400 125 801  3482 102 031  1862 219 031  3151 600 541	310 28 MFZ310 310GTPD KZIZ-2	561 Je nach Kundenwunsch mit unterschiedlicher Kupplung / Equipped with different clutch according to customer requirement	(35)
8.136 FA, FAR 565 8.136 FAE 565 9.136 FA, FAR 565 9.136 FAE 565	05.83-05.90	D0226MF		3400 125 801  3482 102 031  1862 219 031  3151 600 541	310 28 MFZ310 310GTPD KZIZ-2		
9.136 F,9.136 FL 561 9.136 FK 561	10.79-09.87	D0226		3400 124 201 #  3482 032 331  1861 841 132  3151 600 541	280 28 MFZ280 280GTPZ KZIZ-2		
	10.79-08.88			3400 125 801  3482 102 031  1862 219 031  3151 600 541	310 28 MFZ310 310GTPD KZIZ-2	Je nach Kundenwunsch mit unterschiedlicher Kupplung / Equipped with different clutch according to customer requirement	(35)
10.136 F,10.136 FL 491 562 10.136 FK 491	09.81-09.87	D0226		3400 125 801  3482 102 031  1862 219 031  3151 600 541	310 28 MFZ310 310GTPD KZIZ-2	491,562	























































G 90	09.87 - 05.95					
-------------	----------------------	--	--	--	--	--

6.100 F L01 6.100 FK L01 8.100 F L01 8.100 FK L01	09.87-10.93	D0824F, GF		3400 124 201 #  3482 032 331  1861 841 132  3151 600 541	280 28 MFZ280 280GTPZ KZIZ-2	L01	
	09.87-10.93			3400 125 801  3482 102 031  1862 219 031  3151 600 541	310 28 MFZ310 310GTPD KZIZ-2	L01 Je nach Kundenwunsch mit unterschiedlicher Kupplung / Equipped with different clutch according to customer requirement	(35)
8.150 F,8.150 FL L02 8.150 FK L02 8.150 FS,8.150 FLS L02 9.150 F,9.150 FL L02 9.150 FK L02 9.150 FS,9.150 FLS L02	09.87-10.93	D0826F, GF		3400 125 801  3482 102 031  1862 219 031  3151 600 541	310 28 MFZ310 310GTPD KZIZ-2	L02,03,05	
8.150 FAE L03 9.150 FAE L03	05.88-05.95	D0826GF/03		3400 125 801  3482 102 031  1862 219 031  3151 600 541	310 28 MFZ310 310GTPD KZIZ-2	L3	
8.170 L05 9.170 L05	01.88-12.94	D0226MCFO		3482 060 233	350 MF350		
	01.88-12.94			1861 777 037	350 10 350GTD		
				3151 199 001	KZIS-3		
10.150 F,10.150 FL L04	05.90-10.93	D0226MF		3400 125 801  3482 102 031  1862 219 031  3151 600 541	310 28 MFZ310 310GTPD KZIZ-2		
10.150 F,10.150 FL L04 10.150 FK L04	09.87-10.93	D0826F, GF		3400 125 801  3482 102 031  1862 219 031  3151 600 541	310 28 MFZ310 310GTPD KZIZ-2	L04	

		CODE				
--	--	------	--	---	---	---

















MAN





























L 2000		10.93 -				
6.103 L20 L33 6.153 L20 L33 6.163 L20 7.153 L33 L20 7.163 L20	01.93-	D0824FL	 3400 700 322 ☉  3482 093 032  1862 438 032	330 10 MFZ330 330WTB	->03.1996 Je nach Kundenwunsch mit unterschiedlicher Kupplung / Equipped with different clutch according to customer requirement	(35)
	01.93-		 3400 121 801 ☉  3482 120 031  1878 044 631	362 10 MFZ362 362GTZ	Je nach Kundenwunsch mit unterschiedlicher Kupplung / Equipped with different clutch according to customer requirement	(35)
	01.93-		 3182 005 231	HHISZ-3	Füllmedium: Bremsflüssigkeit / Fill Medium: Brake Fluid Immer erneuern / Renew everytime	(25)
	01.93-		 3400 710 001  3482 120 031  1878 044 631  3182 005 231	362 10 MFZ362 362GTZ HHISZ-3		
6.103 L L20 6.164 L20 L33 7.164 L20 L33 8.163 LAC, LAEC, LARC, LAERC, LA-LF, LAE-LF L22 8.163 LAEC L22 8.164 L33 L22 L20 9.164 L22 L20 L33 10.164 L35	05.93-	D0824FL07, D0824FL06, D0824FL09, D0824FL, D0824LFL, D0824LFL02	 3400 700 322 ☉  3482 093 032  1862 438 032	330 10 MFZ330 330WTB	Je nach Kundenwunsch mit unterschiedlicher Kupplung / Equipped with different clutch according to customer requirement	(35)
	01.93-		 3400 121 801 ☉  3482 120 031  1878 044 631	362 10 MFZ362 362GTZ	Je nach Kundenwunsch mit unterschiedlicher Kupplung / Equipped with different clutch according to customer requirement	(35)
	01.93-		 3182 005 231	HHISZ-3	Füllmedium: Bremsflüssigkeit / Fill Medium: Brake Fluid Immer erneuern / Renew everytime	(25)
	01.95-					
	08.95-03.97		 3400 710 001  3482 120 031  1878 044 631  3182 005 231	362 10 MFZ362 362GTZ HHISZ-3		
7.103 L33 L20	04.96-	D0824FL	 3400 121 801 ☉  3482 120 031  1878 044 631	362 10 MFZ362 362GTZ		
			 3400 710 001  3482 120 031  1878 044 631  3182 005 231	362 10 MFZ362 362GTZ HHISZ-3		
			 3182 005 231	HHISZ-3	Füllmedium: Bremsflüssigkeit / Fill Medium: Brake Fluid Immer erneuern / Renew everytime	(25)
8.. - 12..		D0834LFL	 3400 700 303 ☉  3482 000 461  1878 079 331	362 10 MF362 362WGTZ	Getr. / GBox: S 5-42; 6S 850	
			 3400 710 002  3482 000 461  1878 079 331  3182 998 501	362 10 MF362 362WGTZ HHIS-3	Getr. / GBox: S 5-42; 6 S850	
			 3182 998 501	HHIS-3	Getr. / GBox: S 5-42; 6 S850 ohne Sensor / without sensor Füllmedium: Bremsflüssigkeit / Fill Medium: Brake Fluid Immer erneuern / Renew everytime	(105) (25)
			 3400 121 701  3482 000 467  1862 506 131  3151 253 031	395 10 MFZ395 395WGTZ KZIZ-4,5	Getr. / GBox: FS 8309	(30)
8.103 LC, 8.103 LLC L33 L20 8.103 LK L20	10.93-06.96	D0824FL01	 3400 700 322 ☉  3482 093 032  1862 438 032	330 10 MFZ330 330WTB	->03.1996 L20,33 Je nach Kundenwunsch mit unterschiedlicher Kupplung / Equipped with different clutch according to customer requirement	(35)
	10.93-06.96		 3400 121 801 ☉  3482 120 031  1878 044 631	362 10 MFZ362 362GTZ	L20,33 Je nach Kundenwunsch mit unterschiedlicher Kupplung / Equipped with different clutch according to customer requirement	(35)
			 3182 005 231	HHISZ-3	L20,33 Füllmedium: Bremsflüssigkeit / Fill Medium: Brake Fluid Immer erneuern / Renew everytime	(25)
			 3400 710 001  3482 120 031  1878 044 631  3182 005 231	362 10 MFZ362 362GTZ HHISZ-3	L20,33	(30)

L 2000		10.93 -					
8.113 LC, 8.113 LLC L20 L33 8.113 LC,8.113 LLC, LRC, LLRC (LE110C) L20 L33 L20 L33 8.113 LK, L-KI, LRK, LR-KI, LRK-L, LK-L L20	08.95-	D0824LFL04		3400 700 322   3482 093 032  1862 438 032	330 10 MFZ330 330WTB	->03.1996 L20,33 Je nach Kundenwunsch mit unterschiedlicher Kupplung / Equipped with different clutch according to customer requirement	(35)
	09.00-			3400 121 801   3482 120 031  1878 044 631	362 10 MFZ362 362GTZ	L20,33 Je nach Kundenwunsch mit unterschiedlicher Kupplung / Equipped with different clutch according to customer requirement	(35)
	08.95-			3182 005 231	HHISZ-3	L20,33 Füllmedium: Bremsflüssigkeit / Fill Medium: Brake Fluid Immer erneuern / Renew everytime	(25)
				3400 710 001   3482 120 031  1878 044 631  3182 005 231	362 10 MFZ362 362GTZ HHISZ-3	L20,33	(30)
8.145 LA-LF, LAE-LF L22 8.145 LC, LLC, LLRC, LRC (LE140C) L33 L20 L33 L20 8.145 L-LF L20 8.145, LA-LF LAE-LF L22 9.145 LC,9.145 LLC, LRC, LLRC (LE140C) L20 L20 L33 L33	07.00-	D0834LFL02		3400 700 303   3482 000 461  1878 079 331	362 10 MF362 362WGTZ	L20,33	
	09.00-			3400 710 002   3482 000 461  1878 079 331  3182 998 501	362 10 MF362 362WGTZ HHIS-3	L20,33	
	09.00-			3182 998 501	HHIS-3	L20,33 ohne Sensor / without sensor Füllmedium: Bremsflüssigkeit / Fill Medium: Brake Fluid Immer erneuern / Renew everytime	(105)
	07.00-						(25)
8.145 LLS, LLRS (LE140C) L33	09.00-	D0834LFL02		3400 700 303   3482 000 461  1878 079 331	362 10 MF362 362WGTZ	L33	
				3400 710 002   3482 000 461  1878 079 331  3182 998 501	362 10 MF362 362WGTZ HHIS-3	L33	
				3182 998 501	HHIS-3	L33 ohne Sensor / without sensor Füllmedium: Bremsflüssigkeit / Fill Medium: Brake Fluid Immer erneuern / Renew everytime	(105)
8.145 LK, LRK, L-KI, LRK-L, LK-L, LR-KILK (LE140C) L20 9.145 LK, L-KI, LRK, LR-KI, LRK-L, LK-L (LE140C) L20	09.00-	D0834LFL02		3400 700 303   3482 000 461  1878 079 331	362 10 MF362 362WGTZ	L20	
	09.00-			3400 710 002   3482 000 461  1878 079 331  3182 998 501	362 10 MF362 362WGTZ HHIS-3	L20	
				3182 998 501	HHIS-3	L20 ohne Sensor / without sensor Füllmedium: Bremsflüssigkeit / Fill Medium: Brake Fluid Immer erneuern / Renew everytime	(105)
8.153 L20 L22 L33	04.96-	D0826LFL		3400 121 801   3482 120 031  1878 044 631	362 10 MFZ362 362GTZ		
				3400 710 001   3482 120 031  1878 044 631  3182 005 231	362 10 MFZ362 362GTZ HHISZ-3		
				3182 005 231	HHISZ-3	Füllmedium: Bremsflüssigkeit / Fill Medium: Brake Fluid Immer erneuern / Renew everytime	(25)
							(30)

		CODE				
--	--	------	--	---	---	---

















MAN

L 2000		10.93 -					
8.153 LAEC L22	01.95-06.96	D0824LFL		3400 700 322 ☉ ⊗ 3482 093 032 ⊗ 1862 438 032	330 10 MFZ330 330WTB	->03.1996 L22 Je nach Kundenwunsch mit unterschiedlicher Kupplung / Equipped with different clutch according to customer requirement	(35)
8.153 LAEK L22	01.95-09.96			3400 121 801 ☉ ⊗ 3482 120 031 ⊗ 1878 044 631	362 10 MFZ362 362GTZ	->03.1996 L22 Je nach Kundenwunsch mit unterschiedlicher Kupplung / Equipped with different clutch according to customer requirement	(35)
9.153 LA L22	07.93-			3182 005 231	HHISZ-3	->03.1996 L22 Füllmedium: Bremsflüssigkeit / Fill Medium: Brake Fluid Immer erneuern / Renew everytime	(25)
9.155 L, LC, LLC, LRC, LLRC L20 L33	02.04-			3400 710 001 ⊗ 3482 120 031 ⊗ 1878 044 631 🔧 3182 005 231	362 10 MFZ362 362GTZ HHISZ-3	->03.1996 L22	(30)
9.155 LK, L-KI, LRK, LR-KI, LRK-L, LK-L L20	02.04-						
9.155 LLS, LLRS L33	02.04-						
10.153 F 10.153 FA 10.153 LA L27 L26	10.93- 10.93-						
10.155 LC, LLC, LLRC, LRC, LLRC L24	09.00-						
10.155 LK, L-KI, LRK, LR-KI, LK-L L24	02.04-						
8.153 LC,8.153 LLC L20 L33	10.93-07.97	D0824LFL01, 05		3400 700 322 ☉ ⊗ 3482 093 032 ⊗ 1862 438 032	330 10 MFZ330 330WTB	->03.1996 L20,33 Je nach Kundenwunsch mit unterschiedlicher Kupplung / Equipped with different clutch according to customer requirement	(35)
9.153 LC,9.153 LLC L33 L20	10.93-06.96			3400 121 801 ☉ ⊗ 3482 120 031 ⊗ 1878 044 631	362 10 MFZ362 362GTZ	L20,33 Je nach Kundenwunsch mit unterschiedlicher Kupplung / Equipped with different clutch according to customer requirement	(35)
				3182 005 231	HHISZ-3	L20,33 Füllmedium: Bremsflüssigkeit / Fill Medium: Brake Fluid Immer erneuern / Renew everytime	(25)
				3400 710 001 ⊗ 3482 120 031 ⊗ 1878 044 631 🔧 3182 005 231	362 10 MFZ362 362GTZ HHISZ-3	L20,33	(30)
8.153 LK L20	10.93-07.97	D0824LFL01, 05		3400 700 322 ☉ ⊗ 3482 093 032 ⊗ 1862 438 032	330 10 MFZ330 330WTB	->03.1996 L20 Je nach Kundenwunsch mit unterschiedlicher Kupplung / Equipped with different clutch according to customer requirement	(35)
9.153 LK L20	10.93-06.96			3400 121 801 ☉ ⊗ 3482 120 031 ⊗ 1878 044 631	362 10 MFZ362 362GTZ	L20 Je nach Kundenwunsch mit unterschiedlicher Kupplung / Equipped with different clutch according to customer requirement	(35)
				3182 005 231	HHISZ-3	L20 Füllmedium: Bremsflüssigkeit / Fill Medium: Brake Fluid Immer erneuern / Renew everytime	(25)
				3400 710 001 ⊗ 3482 120 031 ⊗ 1878 044 631 🔧 3182 005 231	362 10 MFZ362 362GTZ HHISZ-3	L20	(30)
8.153 LLS L33	10.93-06.96	D0824LFL01, 05		3400 700 322 ☉ ⊗ 3482 093 032 ⊗ 1862 438 032	330 10 MFZ330 330WTB	->03.1996 L33 Je nach Kundenwunsch mit unterschiedlicher Kupplung / Equipped with different clutch according to customer requirement	(35)
				3400 121 801 ☉ ⊗ 3482 120 031 ⊗ 1878 044 631	362 10 MFZ362 362GTZ	L33 Je nach Kundenwunsch mit unterschiedlicher Kupplung / Equipped with different clutch according to customer requirement	(35)
				3182 005 231	HHISZ-3	L33 Füllmedium: Bremsflüssigkeit / Fill Medium: Brake Fluid Immer erneuern / Renew everytime	(25)
				3400 710 001 ⊗ 3482 120 031 ⊗ 1878 044 631 🔧 3182 005 231	362 10 MFZ362 362GTZ HHISZ-3	L33	(30)























L 2000		10.93 -						
8.155 L, LR, LC, LLC, LRC, LLRC, L-LF <small>L20 L33</small> 8.155 LC, LLC, LRC, LLRC <small>L33 L20</small> 8.155 LK, L-KI, LR-KI, LRK-L, LK-L <small>L20</small> 8.155 LK, LRK <small>L20</small> 8.155 L-LF <small>L20</small> 8.155 LLS, LLRS <small>L33</small> 10.153 LAEK <small>L26</small> 10.153 LC,10.153 LLC <small>L24 L35</small> 10.153 LK <small>L24</small> 10.153 LLS <small>L35</small> 10.163 LAC, LAEC, LARC, LAERC <small>L26</small> 10.163 LAEK, LAEK-L, LAERK, LAERK-L, LAK, LAK-L, LARK <small>L26</small> 10.163 LC,10.163 LLC <small>L35 L24</small> 10.163 LK, L-KI, LRK, LR-KI, LRK-L, LK-L <small>L24</small> 10.163 LLS, LLRS <small>L35</small>	02.04 -	D0824LFL		3400 700 322   3482 093 032  1862 438 032	330 10 MFZ330 330WTB	->03.1996 L24,26,35 Je nach Kundenwunsch mit unterschiedlicher Kupplung / Equipped with different clutch according to customer requirement	(35)	
	02.04 -			3400 121 801   3482 120 031  1878 044 631	362 10 MFZ362 362GTZ	L24,26,35 Je nach Kundenwunsch mit unterschiedlicher Kupplung / Equipped with different clutch according to customer requirement	(35)	
	02.04 -			3182 005 231	HHISZ-3	L24,26,35 Füllmedium: Bremsflüssigkeit / Fill Medium: Brake Fluid Immer erneuern / Renew everytime	(25)	
	02.04 -			3400 710 001   3482 120 031  1878 044 631  3182 005 231	362 10 MFZ362 362GTZ HHISZ-3	L24,26,35	(30)	
	10.93 - 06.96							
	10.93 - 06.96							
	10.93 - 06.96							
	10.93 - 06.96							
	05.94 -							
	01.95 -							
	05.94 -							
	05.94 -							
	05.94 -							
	05.94 -							
8.160 <small>L50 L51</small>	01.94 -	D0824		3400 700 322   3482 093 032  1862 438 032	330 10 MFZ330 330WTB	Je nach Kundenwunsch mit unterschiedlicher Kupplung / Equipped with different clutch according to customer requirement	(35)	
				3400 121 801   3482 120 031  1878 044 631	362 10 MFZ362 362GTZ	Je nach Kundenwunsch mit unterschiedlicher Kupplung / Equipped with different clutch according to customer requirement	(35)	
				3182 005 231	HHISZ-3	Füllmedium: Bremsflüssigkeit / Fill Medium: Brake Fluid Immer erneuern / Renew everytime	(25)	
				3400 710 001   3482 120 031  1878 044 631  3182 005 231	362 10 MFZ362 362GTZ HHISZ-3		(30)	

		CODE				
--	--	------	--	---	---	---











MAN



















L 2000		10.93 -					
8.163 LAC, LAEC, LARC, LAERC L22 8.163 LAEK, LAEK-L, LAERK, LAERK-L, LAK, LAK-L, LARK, LARK-L L22 8.163 LAK, LARK, LAEK, LAERK L22 8.163 LA-LF, LAE-LF L22 8.163 LK, L-KI, LRK, LR-KI, LRK-L, LK-L L20 8.163 L-LF L22 8.163 LLS, LLRS L33 8.185 LA-LF, LAE-LF L22 8.185 L-LF L20 9.164 L L20 9.164 LA L22 10.163 F L27 L26 10.163 FA L27 L26 10.163 LA L27 L26 10.185 LAE-GT, LAE-LF L26	01.95-	D0824LFL		3400 700 322 ☉ ⚙️ 3482 093 032 ⚙️ 1862 438 032	330 10 MFZ330 330WTB	->03.1996 L72,74,76 Je nach Kundenwunsch mit unterschiedlicher Kupplung / Equipped with different clutch according to customer requirement	(35)
			3400 121 801 ☉ ⚙️ 3482 120 031 ⚙️ 1878 044 631	362 10 MFZ362 362GTZ	L72,74,76 Je nach Kundenwunsch mit unterschiedlicher Kupplung / Equipped with different clutch according to customer requirement	(35)	
			3182 005 231	HHISZ-3	L72,74,76 Füllmedium: Bremsflüssigkeit / Fill Medium: Brake Fluid Immer erneuern / Renew everytime	(25)	
			3400 710 001 ⚙️ 3482 120 031 ⚙️ 1878 044 631 🗑️ 3182 005 231	362 10 MFZ362 362GTZ HHISZ-3	L72,74,76	(30)	
			3400 121 701 ⚙️ 3482 000 467 ⚙️ 1862 506 131 ⚙️ 3151 253 031	395 10 MFZ395 395WGTZ KZIZ-4,5	04.1996-> T72,74,76 Je nach Kundenwunsch mit unterschiedlicher Kupplung / Equipped with different clutch according to customer requirement	(35)	
8.163 LC, LLC, LLRC, LRC (LE160C) L20 L33 L20 L33	09.00-	D0824LFL09		3400 121 801 ☉ ⚙️ 3482 120 031 ⚙️ 1878 044 631	362 10 MFZ362 362GTZ	L20,33	
			3400 710 001 ⚙️ 3482 120 031 ⚙️ 1878 044 631 🗑️ 3182 005 231	362 10 MFZ362 362GTZ HHISZ-3	L20,33		
			3182 005 231	HHISZ-3	L20,33 Füllmedium: Bremsflüssigkeit / Fill Medium: Brake Fluid Immer erneuern / Renew everytime	(25)	
8.163 LC,8.163 LLC L20 L33 9.163 LC,9.163 LLC, LRC, LLRC L20 L33	05.94-	D0824LFL02, 06, 09		3400 700 322 ☉ ⚙️ 3482 093 032 ⚙️ 1862 438 032	330 10 MFZ330 330WTB	->03.1996 L20,33 Je nach Kundenwunsch mit unterschiedlicher Kupplung / Equipped with different clutch according to customer requirement	(35)
			3400 121 801 ☉ ⚙️ 3482 120 031 ⚙️ 1878 044 631	362 10 MFZ362 362GTZ	L20,33 Je nach Kundenwunsch mit unterschiedlicher Kupplung / Equipped with different clutch according to customer requirement	(35)	
			3182 005 231	HHISZ-3	L20,33 Füllmedium: Bremsflüssigkeit / Fill Medium: Brake Fluid Immer erneuern / Renew everytime	(25)	
			3400 710 001 ⚙️ 3482 120 031 ⚙️ 1878 044 631 🗑️ 3182 005 231	362 10 MFZ362 362GTZ HHISZ-3	L20,33	(30)	
8.163 LC,8.163 LLC, LRC, LLRC, L-LF L33 L20	08.95-	D0824LFL07		3400 700 322 ☉ ⚙️ 3482 093 032 ⚙️ 1862 438 032	330 10 MFZ330 330WTB	->03.1996 L20,33 Je nach Kundenwunsch mit unterschiedlicher Kupplung / Equipped with different clutch according to customer requirement	(35)
			3400 121 801 ☉ ⚙️ 3482 120 031 ⚙️ 1878 044 631	362 10 MFZ362 362GTZ	L20,33 Je nach Kundenwunsch mit unterschiedlicher Kupplung / Equipped with different clutch according to customer requirement	(35)	
			3182 005 231	HHISZ-3	L20,33 Füllmedium: Bremsflüssigkeit / Fill Medium: Brake Fluid Immer erneuern / Renew everytime	(25)	
			3400 710 001	362 10	L20,33	(30)	

MAN

L 2000		10.93 -					
8.163 LK, L-KI, LRK, LR-KI, LRK-L, LK-L L20 9.163 LK, L-KI, LRK, LR-KI, LRK-L, LK-L L20	05.94 -	D0824LFL02, 06, 09	 3400 700 322 ☉  3482 093 032  1862 438 032	330 10 MFZ330 330WTB	->03.1996 L20 Je nach Kundenwunsch mit unterschiedlicher Kupplung / Equipped with different clutch according to customer requirement	(35)	
	05.94 -		 3400 121 801 ☉  3482 120 031  1878 044 631	362 10 MFZ362 362GTZ		L20 Je nach Kundenwunsch mit unterschiedlicher Kupplung / Equipped with different clutch according to customer requirement	(35)
			 3182 005 231	HHISZ-3		L20 Füllmedium: Bremsflüssigkeit / Fill Medium: Brake Fluid Immer erneuern / Renew everytime	(25)
			 3400 710 001  3482 120 031  1878 044 631  3182 005 231	362 10 MFZ362 362GTZ HHISZ-3		L20	
8.163 LLS, LLRS L33 9.163 LLS, LLRS L33	05.94 -	D0824LFL02, 06, 09	 3400 700 322 ☉  3482 093 032  1862 438 032	330 10 MFZ330 330WTB	->03.1996 L33 Je nach Kundenwunsch mit unterschiedlicher Kupplung / Equipped with different clutch according to customer requirement	(35)	
	05.94 -		 3400 121 801 ☉  3482 120 031  1878 044 631	362 10 MFZ362 362GTZ		L33 Je nach Kundenwunsch mit unterschiedlicher Kupplung / Equipped with different clutch according to customer requirement	(35)
			 3182 005 231	HHISZ-3		L33 Füllmedium: Bremsflüssigkeit / Fill Medium: Brake Fluid Immer erneuern / Renew everytime	(25)
			 3400 710 001  3482 120 031  1878 044 631  3182 005 231	362 10 MFZ362 362GTZ HHISZ-3		L33	



















































MAN

L 2000		10.93 -					
8.185 LAC, LAEC, LARC, LAERC, LA-LF, LAE-LF (LE180C) L22	09.00-	D0834LFL03, D0836LFL02, D0834LFL02		3400 700 303   3482 000 461  1878 079 331	362 10 MF362 362WGTZ		
8.185 LAEK, LAEK-L, LAERK, LAERK-L, LAK, LAK-L, LARK, LARK-L L22	09.00-			3400 710 002   3482 000 461  1878 079 331  3182 998 501	362 10 MF362 362WGTZ HHIS-3		
8.185 LC, LLC, LRC, LLRC (LE180C) L33 L33 L20 L20	09.00-			3182 998 501	HHIS-3	ohne Sensor / without sensor Füllmedium: Bremsflüssigkeit / Fill Medium: Brake Fluid Immer erneuern / Renew everytime	(105) (25) (30)
8.185 LK, L-KI, LRK, LR-KI LRK-L, LK-L(LE180C) L20	09.00-						
8.185 LLS, LLRS (LE180C) L33	09.00-						
8.225 LAC, LAEC, LARC, LAERC (LE220C) L23	09.00-						
8.225 LAEK, LAEK-L, LAERK, LAERK-L, LAK, LAK-L, LARK, LARK-L L23	09.00-						
8.225 LLS, LLRS (LE220C) L34	09.00-						
9.185 LC,9.185 LLC, LRC, LLRC (LE180C) L33 L20 L33 L20	09.00-						
9.185 LK, L-KI, LRK, LR-KI, LRK-L, LK-L (LE180C) L20	09.00-						
9.185 LLS, LLRS (LE 180C) L33	09.00-						
9.225 LLS, LLRS (LE220C) L34	09.00-						
10.145 LC,10.145 LLC, LRC, LLRC (LE140C) L24 L35	09.00-						
10.145 LK, L-KI, LRK, LR-KI, LRK-L, LK-L (LE140C) L24	09.00-						
10.145 LLS, LLRS (LE140C) L35	09.00-						
10.185 LAC, LAEC, LARC, LAERC, LA-LA (LE180C) L26	09.00-						
10.185 LAEK, LAEK-L, LAERK, LAERK-L, LAK, LAK-L, LARK L26	09.00-						
10.185 LC,10.185 LLC, LRC, LLRC (LE180C) L35 L24 L35 L24	09.00-						
10.185 LK, L-KI, LRK, LR-KI, LRK-L, LK-L (LE180C) L24	09.00-						
10.185 LLS, LLRS (LE180C) L35	09.00-						
10.225 LAC, LAEC, LARC, LAERC (LE220C) L26 L27	09.00-						
10.225 LAEK, LAEK-L, LAERK, LAERK-L, LAK, LAK-L, LARK L27	09.00-						
10.225 LC, 10.225 LLC, LRC, LLRC (LE220C) L25 L36 L25 L36	09.00-						
10.225 LK, L-KI, LRK, LR-KI, LRK-L, LK-L (LE220C) L25	09.00-						
10.225 LLS, LLRS (LE220C) L24 L36	09.00-						
12.185 LC, LLC (LE180C) L70 L72	09.99-						



















L 2000		10.93 -					
12.225 LC, LLC (LE220C) L71 L72 L73	09.99-	D0834LFL03, D0836LFL02, D0834LFL02	 3400 700 303 ⊗ 3482 000 461 ⊗ 1878 079 331	362 10 MF362 362WGTZ			
			 3400 710 002 ⊗ 3482 000 461 ⊗ 1878 079 331 ⊗ 3182 998 501	362 10 MF362 362WGTZ HHIS-3			
			 3182 998 501	HHIS-3	ohne Sensor / without sensor Füllmedium: Bremsflüssigkeit / Fill Medium: Brake Fluid Immer erneuern / Renew everytime	(105) (25)	(30)
8.223 LAEC L23	01.95 - 06.96	D0826LFL	 3482 060 132	350 MF350	L21,23,34		
8.224 LAC, LAEC, LARC, LAERC L23	01.95 -		 1878 001 145	350 10 350WGTZ	L21,23,34		
8.224 LAK, LAEK, LARK, LAERK L23	01.95 -		 3151 199 001	KZIS-3	L21,23,34		
8.224 LC,8.224 LLC, LRC, LLRC L34 L21	05.94 -						
8.224 LK, LRK, L-KI, LR-KI L21	05.94 -						
8.224 LLS, LLRS L34	05.94 -						
9.224 LC,9.224 LLC, LRC, LLRC L21 L34	05.94 -						
9.224 LK, L-KI, LRK, LR-KI, LRK-L, LK-L L21	05.94 -						
9.224 LLS, LLRS L34	05.94 -						
8.223 LC,8.223 LLC L34 L21	10.93 - 06.96	D0826LFL	 3400 125 501 ⊗ 3482 060 132 ⊗ 1878 001 077 ⊗ 3151 199 001	350 10 MF350 350GTZ KZIS-3	->02.1994 L34		
8.223 LK L21	10.93 - 06.96		 3482 060 132	350 MF350	03.1994-> L23,34		
9.223 LC,9.223 LLC L34 L21	10.93 - 06.96		 1878 001 145	350 10 350WGTZ	03.1994-> L23,34		
9.223 LK L21	10.93 - 06.96		 3151 199 001	KZIS-3	03.1994-> L23,34		
			 3482 060 132	350 MF350	L21		
			 1878 001 145	350 10 350WGTZ	L21		
			 3151 199 001	KZIS-3	L21		
8.223 LLS L34	10.93 - 06.96	D0826LFL	 3400 125 501 ⊗ 3482 060 132 ⊗ 1878 001 077 ⊗ 3151 199 001	350 10 MF350 350GTZ KZIS-3	->02.1994 L21,34		
9.223 LLS L34	10.93 - 06.96		 3482 060 132	350 MF350	03.1994-> L21,23,34		
			 1878 001 145	350 10 350WGTZ	03.1994-> L21,23,34		
			 3151 199 001	KZIS-3	03.1994-> L21,23,34		
8.224 L34 L21	01.93 - 02.94	D0826LFL	 3400 125 501 ⊗ 3482 060 132 ⊗ 1878 001 077 ⊗ 3151 199 001	350 10 MF350 350GTZ KZIS-3			
9.224 L21 L34	01.93 - 02.94						
10.224 L25,36	01.93 - 02.94						

		CODE				
--	--	------	--	---	---	---























MAN

L 2000		10.93 -					
8.224 LAC, LAEC, LARC, LAERC L23 8.224 LAEK, LAEK-L, LAERK, LAERK-L, LAK, LAK-L, LARK, LARK-L L23 8.224 LC, LLC, LRC, LLRC L21 L34 8.224 LK, LRK, L-KI, LR-KI L21 8.224 LLS, LLRS L34 9.224 LA L23	01.95 -	D0826LF		3400 121 701  3482 000 467  1862 506 131  3151 253 031	395 10 MFZ395 395WGTZ KZIZ-4,5	M32,33,34	
	01.95 -						
	05.94 -						
	05.94 -						
	05.94 -						
8.225 LC,8.225 LLC, LRC, LLRC (LE220C) L34 L21 L21 L34 8.225 LK, L-KI, LRK, LR-KI, LRK-L, LK-L (LE220C) L21 9.145 LLS, LLRS (LE140C) L33 9.225 LK, L-KI, LRK, LR-KI, LRK-KI, LK-L (LE220C) L21	09.00 -	D0836LFL02		3400 700 303   3482 000 461  1878 079 331	362 10 MF362 362WGTZ	L21	
	09.00 -			3400 710 002  3482 000 461  1878 079 331  3182 998 501	362 10 MF362 362WGTZ HHIS-3	L21	
	09.00 -			3182 998 501	HHIS-3	L21 ohne Sensor / without sensor Füllmedium: Bremsflüssigkeit / Fill Medium: Brake Fluid Immer erneuern / Renew everytime	(105) (25)
	09.00 -						(30)
9.153 LLS L33	10.93 - 12.95	D0824LFL01, 05		3400 700 322   3482 093 032  1862 438 032	330 10 MFZ330 330WTB	L33 Je nach Kundenwunsch mit unterschiedlicher Kupplung / Equipped with different clutch according to customer requirement	(35)
				3400 121 801   3482 120 031  1878 044 631	362 10 MFZ362 362GTZ	L33 Je nach Kundenwunsch mit unterschiedlicher Kupplung / Equipped with different clutch according to customer requirement	(35)
				3182 005 231	HHISZ-3	L33 Füllmedium: Bremsflüssigkeit / Fill Medium: Brake Fluid Immer erneuern / Renew everytime	(25) (30)
					3400 710 001  3482 120 031  1878 044 631  3182 005 231	362 10 MFZ362 362GTZ HHISZ-3	L33
9.163 LC L20 9.163 LK L20	08.95 - 03.97	D0824LFL07		3400 700 322   3482 093 032  1862 438 032	330 10 MFZ330 330WTB	-> 03.1996 L20 Je nach Kundenwunsch mit unterschiedlicher Kupplung / Equipped with different clutch according to customer requirement	(35)
	08.95 - 03.97			3400 121 801   3482 120 031  1878 044 631	362 10 MFZ362 362GTZ	L20 Je nach Kundenwunsch mit unterschiedlicher Kupplung / Equipped with different clutch according to customer requirement	(35)
				3182 005 231	HHISZ-3	L20 Füllmedium: Bremsflüssigkeit / Fill Medium: Brake Fluid Immer erneuern / Renew everytime	(25) (30)
					3400 710 001  3482 120 031  1878 044 631  3182 005 231	362 10 MFZ362 362GTZ HHISZ-3	L20
9.225 LC,9.225 LLC, LRC, LLRC (LE220C) L34 L21 L34 L21	09.00 -	D0836LFL02		3400 700 303   3482 000 461  1878 079 331	362 10 MF362 362WGTZ	L21	
				3182 998 501	HHIS-3	L21 ohne Sensor / without sensor Füllmedium: Bremsflüssigkeit / Fill Medium: Brake Fluid Immer erneuern / Renew everytime	(105) (25) (30)
10.163 LC,10.163 LLC, LRC, LLRC (LE160C) L24 L35 L24 L35	09.00 -	D0824LFL09		3400 121 801   3482 120 031  1878 044 631	362 10 MFZ362 362GTZ	Je nach Kundenwunsch mit unterschiedlicher Kupplung / Equipped with different clutch according to customer requirement	(35)
				3182 005 231	HHISZ-3	Füllmedium: Bremsflüssigkeit / Fill Medium: Brake Fluid Immer erneuern / Renew everytime	(25) (30)
					3400 710 001	362 10	









L 2000 10.93 -

10.223 F, 10.223 FL 10.223 FA 10.223 LC, 10.223 LLC L25 L36 L35 10.223 LK L25 10.223 LLS L36 L35 10.224 F, 10.224 FL 10.224 FA 10.225 LAE-GT, LAE-LF L26 10.225 LC, 10.225 LLC, LRC, LLRC L36 L25	10.93-06.96 10.93-06.96 10.93-06.96 10.93-06.96 10.93-06.96 05.94- 05.94- 09.00- 09.00-	D0826LFL	        	3400 125 501  3482 060 132  1878 001 077  3151 199 001	350 10 MF350 350GTZ KZIS-3	->02.1994 L25,36	
10.223 LAEC L27 10.224 LAC, LAEC, LARC, LAERC L27 10.224 LAEK, LAEK-L, LAERK, LAERK-L, LAK, LAK-L, LARK L27 10.224 LC, 10.224 LLC, LRC, LLRC L35 L25 L36 10.224 LK, L-KI, LRK, LR-KI, LRK-L, LK-L L25 10.224 LLS, LLRS L36	01.95-06.96 01.95- 01.95- 05.94- 05.94- 05.94-	D0826LFL	    	3482 060 132  1878 001 145  3151 199 001	350 MF350 350 10 350WGTZ KZIS-3	L25,27,36 L25,27,36 L25,27,36	









M 2000 L 08.95 -

11.153 L72 11.163 L72 12.153 L72,74,76	-03.96 -03.96 -03.96	D0824LFL	    	3400 700 322   3482 093 032  1862 438 032	330 10 MFZ330 330WTB	Je nach Kundenwunsch mit unterschiedlicher Kupplung / Equipped with different clutch according to customer requirement	(35)
			  	3400 121 801   3482 120 031  1878 044 631	362 10 MFZ362 362GTZ	Je nach Kundenwunsch mit unterschiedlicher Kupplung / Equipped with different clutch according to customer requirement	(35)
			  	3182 005 231	HHISZ-3	Füllmedium: Bremsflüssigkeit / Fill Medium: Brake Fluid Immer erneuern / Renew everytime	(25) (30)
11.174 L72			  	3482 120 031  1878 044 631  3182 005 231	362 MFZ362 362 10 362GTZ HHISZ-3	Füllmedium: Bremsflüssigkeit / Fill Medium: Brake Fluid Immer erneuern / Renew everytime	(25) (30)

MAN

M 2000 L		08.95 -				
11.223 L73	01.96-	D0826LF	 3400 121 701 ⊗ 3482 000 467 ⊗ 1862 506 131 ⊙ 3151 253 031	395 10 MFZ395 395WGTZ KZIZ-4,5		
11.224 L73	01.96-					
12.224, 12.225, LK, LRK L71 L75	08.95-					
12.225 LC, LLC, LLLC, LRC, LLRC L79 L71 L75 L77 L73	05.01-					
14.224, 14.225, LA-LF L80	07.03-					
14.225 LAC, LARC, (LE220B) L80	09.00-					
14.225 LAK, LARK, LAK-L, (LE220B) L80	09.00-					
14.225 LC, LLC, LLLC, LRC, LLRC, LLLRC (LE220B) L77 L79 L75	09.00-					
14.225 LK, LRK (LE220B) L75	09.00-					
14.255 LAC, LARC L80	11.02-					
14.255 LAK, LARK, LAK-L L80	11.02-					
14.255 LA-LF L80	07.03-					
14.255 LC, LLC, LLLC, LRC, LLRC, LLLRC (LE250B) L75 L79 L77	09.00-					
14.255 LK, LRK L75	11.02-					
20.264 LNLC, LNLLC L84 L86	05.01-					
12.145 LC, LLC, LRC, LLRC L70 L72	05.01-	D0834LFL02	 3400 700 303 ⊙ ⊗ 3482 000 461 ⊗ 1878 079 331	362 10 MF362 362WGTZ	L20,33	
12.145 LK, LRK L70	05.01-		 3400 710 002 ⊗ 3482 000 461 ⊗ 1878 079 331 ⚡ 3182 998 501	362 10 MF362 362WGTZ HHIS-3	L20,33	
			 3182 998 501	HHIS-3	L20,33 ohne Sensor / without sensor Füllmedium: Bremsflüssigkeit / Fill Medium: Brake Fluid Immer erneuern / Renew everytime	(105) (25) (30)
12.163 LC, LLC, LRC, LLRC L70 L72	08.95-	D0824LFL	 3400 700 322 ⊙ ⊗ 3482 093 032 ⊗ 1862 438 032	330 10 MFZ330 330WTB	->03.1996 L72,74,76	
12.163 LK, LRK L70	08.95-				Je nach Kundenwunsch mit unterschiedlicher Kupplung / Equipped with different clutch according to customer requirement	(35)
12.185 LC, LLC, LRC, LLRC L70 L72	05.01-		 3400 121 801 ⊙ ⊗ 3482 120 031 ⊗ 1878 044 631	362 10 MFZ362 362GTZ	L72,74,76	
12.185 LK, LRK L70	05.01-				Je nach Kundenwunsch mit unterschiedlicher Kupplung / Equipped with different clutch according to customer requirement	(35)
14.185 LC, LLC, LRC, LLRC L74 L76	05.01-		 3182 005 231	HHISZ-3	L72,74,76 Füllmedium: Bremsflüssigkeit / Fill Medium: Brake Fluid Immer erneuern / Renew everytime	(25) (30)
14.185 LK, LRK L74	05.01-		 3400 710 001 ⊗ 3482 120 031 ⊗ 1878 044 631 ⚡ 3182 005 231	362 10 MFZ362 362GTZ HHISZ-3	L72,74,76	
			 3400 121 701 ⊗ 3482 000 467 ⊗ 1862 506 131 ⊙ 3151 253 031	395 10 MFZ395 395WGTZ KZIZ-4,5	04.1996-> T72,74,76	
					Je nach Kundenwunsch mit unterschiedlicher Kupplung / Equipped with different clutch according to customer requirement	(35)









































MAN

M 2000 L		08.95 -				
12.223 L73,75,77,79	01.96-	D0826LFL		3400 121 701  3482 000 467  1862 506 131  3151 253 031	395 10 MFZ395 395WGTZ KZIZ-4,5	
12.263 L73,75,77,79	01.96-					
12.264 L73,75,77,79	01.96-					
13.223 L75,77,79,80	01.96-					
13.224 L75,77,79,80	01.96-					
13.263 L75,77,79,80	01.96-					
13.264 L75,77,79,80	01.96-					
13.283 L75,77,79,80	01.96-					
14.223 L75,77,79,80,86	01.96-					
14.263 L75,77,79,80,86	01.96-					
15.223 L82,84,86	01.96-					
15.263 L82,84,86	01.96-					
15.283 L82,84,86	01.96-					
18.223 L87,88,89,90	01.96-					
18.263 L87,88,89,90	01.96-					
18.283 L87,88,89,90	01.96-					
12.224 LC, LLC, LRC, LLRC L73 L71	08.95-	D0826LFL		3400 121 701  3482 000 467  1862 506 131  3151 253 031	395 10 MFZ395 395WGTZ KZIZ-4,5	L73,75,77,79

MAN











M 2000 L		08.95 -		
12.255 LC, LLC, LLLC, LLRC, LRC L79 L77 L75	08.02-	D0826LFL10, D0836LF01, D0836LFL01, D0836LFL05, D0836LFL02, D0826LFL03, D0836LFL03	 3400 121 701 ⊗ 3482 000 467 ⊗ 1862 506 131 ⊙ 3151 253 031	395 10 MFZ395 395WGTZ KZIZ-4,5
12.255 LK, LRK L75	10.03-			
14.284 LC, LLC, LLLC, LRC, LLRC, LLLRC L77 L79 L75	10.98-			
14.284, 14.285, LAC, LARC L80	06.98-			
14.284, 14.285, LAK, LARK, LAK-L L80	06.98-			
14.284, 14.285, LA-LF L80	06.98-			
14.284, 14.285, LK, LRK L75	10.98-			
14.285 LC, LLC, LLLC, LRC, LLRC, LLLRC, (LE280B) L77 L75 L79	09.00-			
15.284 LC, LLC, LLLC, LRC, LLRC, LLLRC L86 L82 L84	06.98-			
15.284 LK, LRK, LK-L L82	06.98-			
15.285 LC, LLC, LLLC, LRC, LLRC, LLLRC, (LE280B) L86 L84 L82	09.99-			
15.285 LK, LRK, LK-L, (LE280B) L82	09.99-			
18.284 LAC, LARC L90	06.98-			
18.284 LAK, LARK, LAK-L L90	06.98-			
18.285 LAC, LARC (LE280B) L90	09.99-			
18.285 LAK, LARK, LAK-L, (LE280B) L90	09.99-			
19.284, 19.285, LC, LLC, LLLC, LLLRC, LLRC, LRC L88	05.01-			
20.284, 20.285, LNLC, LNLLC L84 L86	05.01-			
26.224 DL-HK 6x4/2 L95	02.99-			
26.224 DLR-HK 6x4/2 L95	02.99-			
26.225 DL-HK 6x4/2 L95	09.00-			
26.225 DLR-HK 6x4/2 L95	09.00-			
26.255 DL-HK 6x4/2 L95	09.00-			
26.255 DLR-HK 6x4/2 L95	09.00-			
26.284 DL-HK 6x4/2 L95	02.99-			
26.284 DLR-HK 6x4/2 L95	02.99-			
26.284 DLR-TM 6x4/2 L95	02.99-			
26.284 DL-TM 6x4/2 L95	02.99-			
26.285 DL-HK 6x4/2 L95	09.00-			
26.285 DLR-HK 6x4/2 L95	09.00-			
26.285 DL-TM 6x4/2 L95	09.00-			
26.285 DL-TM, DLR-TM L95	05.01-			











MAN

M 2000 L		08.95 -					
13.153 L74,76 13.163 L74,76 14.153 L74,76,81,83 15.153 L81,83	-03.96	D0824L, LFL		3400 700 322 ☉  3482 093 032  1862 438 032	330 10 MFZ330 330WTB	Je nach Kundenwunsch mit unterschiedlicher Kupplung / Equipped with different clutch according to customer requirement	(35)
	-03.96			3400 121 801 ☉  3482 120 031  1878 044 631	362 10 MFZ362 362GTZ	Je nach Kundenwunsch mit unterschiedlicher Kupplung / Equipped with different clutch according to customer requirement	(35)
	-03.96			3182 005 231	HHISZ-3	Füllmedium: Bremsflüssigkeit / Fill Medium: Brake Fluid	(25)
	-03.96			3400 710 001  3482 120 031  1878 044 631  3182 005 231	362 10 MFZ362 362GTZ HHISZ-3	Immer erneuern / Renew everytime	(30)
14.. - 18..		D0836LF		3400 121 701  3482 000 467  1862 506 131  3151 253 031	395 10 MFZ395 395WGTZ KZIZ-4,5	Getr. / GBox: FS 8309; 16 S109	
				3400 700 303 ☉  3482 000 461  1878 079 331	362 10 MF362 362WGTZ	Getr. / GBox: 6S 850, SAE 3	
				3400 700 302 ☉  3482 000 464  1862 506 131	395 10 MF395 395WGTZ	Getr. / GBox: 6S 850, SAE 2	
14.163 LC, LLC, LRC, LLRC L74 L76 14.163 LK, LRK L74	08.95-	D0824L, LFL		3400 700 322 ☉  3482 093 032  1862 438 032	330 10 MFZ330 330WTB	-> 03.1996 L74,76,81,83 Je nach Kundenwunsch mit unterschiedlicher Kupplung / Equipped with different clutch according to customer requirement	(35)
	08.95-			3400 121 801 ☉  3482 120 031  1878 044 631	362 10 MFZ362 362GTZ	L74,76,81,83 Je nach Kundenwunsch mit unterschiedlicher Kupplung / Equipped with different clutch according to customer requirement	(35)
				3182 005 231	HHISZ-3	L74,76,81,83 Füllmedium: Bremsflüssigkeit / Fill Medium: Brake Fluid	(25)
				3400 710 001  3482 120 031  1878 044 631  3182 005 231	362 10 MFZ362 362GTZ HHISZ-3	L74,76,81,83 Immer erneuern / Renew everytime	(30)
				3400 121 701  3482 000 467  1862 506 131  3151 253 031	395 10 MFZ395 395WGTZ KZIZ-4,5	04.1996-> L74,76,81,83 Je nach Kundenwunsch mit unterschiedlicher Kupplung / Equipped with different clutch according to customer requirement	(35)
14.224 LAC, LARC L80 14.224 LAK, LARK, LAK-L L80 14.224 LC, LLC, LLLC, LRC, LLRC, LLLRC L79 L75 L77 14.224 LK, LRK L75 14.263, 14.264 LAC, LARC L80 14.263, 14.264 LAK, LARK, LAK-L L80 14.263, 14.264 LC, LLC, LLLC, LRC, LLRC, LLLRC L79 L75 L77 14.263, 14.264 LK, LRK L75	08.95-	D0826LFL		3400 121 701  3482 000 467  1862 506 131  3151 253 031	395 10 MFZ395 395WGTZ KZIZ-4,5	L75,77,79,80,86	
	08.95-						
	08.95-						
	08.95-						
	08.95-						
	08.95-						
	08.95-						
	08.95-						
	08.95-						

		CODE				
--	--	------	--	---	---	---



MAN





M 2000 L		08.95 -				
14.264 LA-LF L80	07.03-	D0836LF01, D0826LFL09, D0836LFL05, D0836LFL03	 3400 121 701 ⊗ 3482 000 467 ⊗ 1862 506 131 ⊙ 3151 253 031	395 10 MFZ395 395WGTZ KZIZ-4,5	Getr. / GBox: Eaton	
15.255 LC, LLC, LLLC, LRC, LLRC, LLLRC, (LE250B) L86 L84 L82	09.99-		 1878 000 964	380 10 380GTZ	Nebenantriebs-ID / PTO ID: NMV130E	(50)
15.255 LK, LRK, LK-L, (LE250B) L82	09.99-		 3151 204 001	KZI-6	mit Schmierrohranschluss / with lubrication pipe connection Nebenantriebs-ID / PTO ID: NMV130E	(91) (50)
18.255 LC, LLC, LLLC, LRC, LLRC, LLLRC, (LE250B) L89 L87 L88	09.99-					
18.263, 18.264, LC, LLC, LLLC, LRC, LLRC, LLLRC L89 L87 L88	08.95-					
18.263, 18.264, LK, LK-L, LLK, LLK-L, LLRK, LRK L88 L87	08.95-					
18.263, 18.264, L-KO, LR-KO L87	05.01-					
18.284 LC, LLC, LLLC, LRC, LLRC, LLLRC L87 L88 L89	06.98-					
18.284, 18.285, LK, LK-L, LLK, LLK-L, LLRK, LRK L88 L87	06.98-					
18.284, 18.285, L-KO, LR-KO L87	06.98-					
18.285 LC, LLC, LLLC, LRC, LLRC, LLLRC, (LE280B) L87 L89 L88	09.99-					
19.264 LC, LLC, LLLC, LLLRC, LLRC, LRC L88	05.01-					
20.255 LNLC, LNLLC L86 L84	05.01-					
15.163 LC, LLC, LLLC, LLLRC, LLRC, LRC L83 L81	08.95-	D0824L, LFL	 3400 700 322 ☾ ⊗ 3482 093 032 ⊗ 1862 438 032	330 10 MFZ330 330WTB	->03.1996 L81,83 Je nach Kundenwunsch mit unterschiedlicher Kupplung / Equipped with different clutch according to customer requirement	(35)
15.163 LK, LRK, LK-L L81	08.95-		 3400 121 801 ☾ ⊗ 3482 120 031 ⊗ 1878 044 631	362 10 MFZ362 362GTZ	->03.1996 L81,83 Je nach Kundenwunsch mit unterschiedlicher Kupplung / Equipped with different clutch according to customer requirement	(35)
			 3182 005 231	HHISZ-3	->03.1996 L81,83 Füllmedium: Bremsflüssigkeit / Fill Medium: Brake Fluid Immer erneuern / Renew everytime	(25) (30)
			 3400 710 001 ⊗ 3482 120 031 ⊗ 1878 044 631 ⚡ 3182 005 231	362 10 MFZ362 362GTZ HHISZ-3	->03.1996 L81,83	
15.185 LC, LLC, LLLC, LLLRC, LLRC, LRC L81	05.01-	D0834LFL03	 3400 700 303 ☾ ⊗ 3482 000 461 ⊗ 1878 079 331	362 10 MF362 362WGTZ	L20,33	
15.185 LK, LRK, LK-L L81	11.02-		 3400 710 002 ⊗ 3482 000 461 ⊗ 1878 079 331 ⚡ 3182 998 501	362 10 MF362 362WGTZ HHIS-3	L20,33	
			 3182 998 501	HHIS-3	L20,33 ohne Sensor / without sensor Füllmedium: Bremsflüssigkeit / Fill Medium: Brake Fluid Immer erneuern / Renew everytime	(105) (25) (30)





M 2000 L		08.95 -					
15.224 LC, LLC, LLLC, LRC, LLRC, LLLRC L86 L82 L84	08.95-	D0826LFL		3400 121 701 ⊗ 3482 000 467 ⊗ 1862 506 131 ⊙ 3151 253 031	395 10 MFZ395 395WGTZ KZIZ-4,5	L82,84,86	
15.224 LK, LRK, LK-L L82	08.95-						
15.263, 15.264 LC, LLC, LLLC, LRC, LLRC, LLLRC L86 L84 L82	08.95-						
15.263, 15.264 LK, LRK, LK-L L82	08.95-						
15.225 LC, LLC, LLLC, LRC, LLRC, LLLRC, (LE220B) L86 L84 L82	09.99-	D0826LF		3400 121 701 ⊗ 3482 000 467 ⊗ 1862 506 131 ⊙ 3151 253 031	395 10 MFZ395 395WGTZ KZIZ-4,5	M32,33,34	
15.225 LK, LRK, LK-L, (LE220B) L82	09.99-						
18.224, 18.225, L-KO, LR-KO L87	05.01-						
18.255 LAC, LARC L90	05.01-						
18.255 LAK, LARK, LAK-L L90	05.01-						
18.255 LK, LK-L, LLK, LLK-L, LLRK, LRK L88 L87	11.02-						
18.255 L-KO, LR-KO L87	05.01-						
19.224, 19.225, LC, LLC, LLLC, LLLRC, LLRC, LRC L88	05.01-						
19.255 LC, LLC, LLLC, LLLRC, LLRC, LRC L88	05.01-						
20.224 LNLC, LNLLC L84 L86	05.01-						
20.224, 20225 LNLC, LNLLC L86 L84	05.01-						
18.224, 18.225, LAC, LARC L90	08.95-	D0826LFL		3400 121 701 ⊗ 3482 000 467 ⊗ 1862 506 131 ⊙ 3151 253 031	395 10 MFZ395 395WGTZ KZIZ-4,5	L87,88,89,90	
18.224, 18.225, LAK, LARK, LAK-L L90	08.95-						
18.263, 18.264, LAC, LARC L90	08.95-						
18.263, 18.264, LAK, LARK, LAK-L L90	08.95-						
18.224, 18.225, LC, LLC, LLLC, LRC, LLRC, LLLRC L88 L87 L89	08.95-	D0826LFL10, D0836LFL02, D0826LFL03		3400 700 302 ⚙ ⊗ 3482 000 464 ⊗ 1862 506 131	395 10 MF395 395WGTZ	->09.2002 Getr. / GBox: ZF 6S850 (SAE2)	
18.224, 18.225, LK, LK-L, LLK, LLK-L, LLRK, LRK L87 L88	08.95-			3400 710 003 ⊗ 3482 000 464 ⊗ 1862 506 131 ⊙ 3182 998 501	395 10 MF395 395WGTZ HHIS-3	10.2002-> Getr. / GBox: ZF 6S850 (SAE2)	
				3182 998 501	HHIS-3	Getr. / GBox: ZF 6S850 (SAE2) ohne Sensor / without sensor Füllmedium: Bremsflüssigkeit / Fill Medium: Brake Fluid Immer erneuern / Renew everytime	(105) (25) (30)
				3496 006 000		Getr. / GBox: ZF 6S850 (SAE2) langer Bügel / long handle	(86)
				3400 121 701 ⊗ 3482 000 467 ⊗ 1862 506 131 ⊙ 3151 253 031	395 10 MFZ395 395WGTZ KZIZ-4,5	Getr. / GBox: Eaton	
				3496 006 000		Getr. / GBox: Eaton langer Bügel / long handle	(86)
				1878 000 964	380 10 380GTZ	Nebenantriebs-ID / PTO ID: NMV130E	(50)
				3151 204 001	KZI-6	mit Schmierrohranschluss / with lubrication pipe connection Nebenantriebs-ID / PTO ID: NMV130E	(91) (50)

		CODE				
--	--	------	--	---	---	---

MAN

M 2000 L		08.95 -				
26.224, 26.225, DL-HK, DLR-HK L95	11.02-		3400 121 701 ⊗ 3482 000 467 ⊗ 1862 506 131 ⊙ 3151 253 031	395 10 MFZ395 395WGTZ KZIZ-4,5		
26.255 DL-HK, DLR-HK L95	11.02-					
26.284 DL-TM, DLR-TM L95	05.01-		1878 000 964	380 10 380GTZ	für Nebenantrieb / for PTO	(82)
26.284, 26.285, DL-HK, DLR-HK L95	11.02-					

M 2000 M		08.95 - 12.05					
14.. - 18..		D0836LF		3400 121 701 ⊗ 3482 000 467 ⊗ 1862 506 131 ⊙ 3151 253 031	395 10 MFZ395 395WGTZ KZIZ-4,5	Getr. / GBox: FS 8309; 16 S109	
				3400 700 303 ⊗ 3482 000 461 ⊗ 1878 079 331	362 10 MF362 362WGTZ	Getr. / GBox: 6S 850, SAE 3	
				3400 700 302 ⊗ 3482 000 464 ⊗ 1862 506 131	395 10 MF395 395WGTZ	Getr. / GBox: 6S 850, SAE 2	
12.224 M32,33,34	08.95-	D0826LF		3400 121 701 ⊗ 3482 000 467 ⊗ 1862 506 131 ⊙ 3151 253 031	395 10 MFZ395 395WGTZ KZIZ-4,5		
12.264 M32,33,34	08.95-						
13.224 M32,33,34	08.95-						
13.264 M32,33,34	08.95-						
13.283 M32,33,34	08.95-						
14.224 MC, MLC, MLLC, MLRC, MRC, MLLRC M31 M33 M32	08.95-12.05						
18.225 MLS, MLRS M39	02.03-						
18.283 M38-41	03.95-						
23.224 M42,44	06.95-						
23.264 M42,44	06.95-						
23.283 M42,44	06.95-						
25.255 MNLC, MNLLC, MNLRC, MNLLRC, MVLC M42 M43 M44	10.00-						
25.255 MNLC, MNLLC, MNLRC, MNLLRC, MVLC M44 M43 M42	10.00-						
25.283 M42,44	06.95-						
25.283 M43	06.95-						

M 2000 M		08.95 - 12.05				
12.224 MC, MLC, MLLC, MLRC, MRC, MLLRC M31 M32	02.03-	D0826LF		3400 121 701 ⊗ 3482 000 467 ⊗ 1862 506 131 ⊕ 3151 253 031	395 10 MFZ395 395WGTZ KZIZ-4,5	M32,33,34
12.224 ML, 12.224 MLL M33 M32	07.95-					
12.224 MLS, MLRS M32	02.03-					
12.225 MC, MLC, MLLC, MLRC, MRC, MLLRC M32 M31	02.03-					
12.225 MLS, MLRS M32	02.03-					
14.224 MAK, MAK-L, MARK M34	08.95-12.05					
14.224 MA-KO, MA-LF M34	11.02-					
14.224 MK M31	08.95-12.05					
14.224 MLS, MLRS M32	08.95-12.05					
14.225 MAK, MAK-L, MARK M34	08.95-07.05					
14.225 MA-KO, MA-LF M34	02.03-					
14.225 MC, MLC, MLLC, MLRC, MRC, MLLRC M31 M32 M33	10.00-					
14.225 MLS, MLRS M32	02.03-					
14.264 MC, MLC, MLLC, MLRC, MRC, MLLRC M33 M31 M32	08.95-12.05					
14.264 MLS, MLRS M32	08.95-12.05					
18.224 M-KO, MR-KO M38	02.00-					
18.225 MAC, MARC M41	02.03-					
18.225 MAK, MAK-L, MARK M41	01.96-07.05					
18.225 MC, MLC, MLLC, MRC, MLRC, MLLRC M38 M39 M40	10.00-					
18.225 MK, MK-L, MLK, MLRK, MRK M39 M38	10.00-					
18.225 M-KO, MR-KO M38	02.03-					
12.255 MC, MLC, MLLC, MLRC, MRC, MLLRC M32 M31	02.03-	D0836LF05		3400 121 701 ⊗ 3482 000 467 ⊗ 1862 506 131 ⊕ 3151 253 031	395 10 MFZ395 395WGTZ KZIZ-4,5	Getr. / GBox: Eaton
12.255 MLS M32	02.03-			1878 000 964	380 10 380GTZ	Nebenantriebs-ID / PTO ID: NMV130E (50)
12.264 MC, MLC, MLLC, MLRC, MRC, MLLRC M32 M31	02.03-			3151 204 001	KZI-6	mit Schmierrohranschluss / with lubrication pipe connection Nebenantriebs-ID / PTO ID: NMV130E (91)
12.264 ML, 12.264 MLL M33 M32	01.96-					Nebenantriebs-ID / PTO ID: NMV130E (50)
12.264 MLS, MLRS M32	02.03-					
14.255 MAK, MAK-L, MARK M34	11.02-					
14.255 MA-KO, MA-LF M34	11.02-					
14.255 MC, MLC, MLLC, MLRC, MRC, MLLRC M33 M32 M31	10.00-					
14.255 MLS, MLRS M32	10.00-					
14.264 MAK, MAK-L, MARK M34	11.02-					
14.264 MA-KO, MA-LF M34	11.02-					



CODE



SACHS

Parameter

i









MAN

M 2000 M		08.95 - 12.05		
12.284 MC, MLC, MLLC, MLRC, MRC, MLLRC M32 M31	02.00-	D0826LFL10, D0836LF01, D0826LF15, D0826LF18, D0836LF03, D0826LF17, D0836LF05, D0836LFL03	3400 121 701 3482 000 467 1862 506 131 3151 253 031	395 10 MFZ395 395WGTZ KZIZ-4,5
12.284 MLS, MLRS M32	02.00-			
12.285 MC, MLC, MLLC, MLRC, MRC, MLLRC M31 M32	02.03-			
12.285 MLS, MLRS M32	02.00-			
14.284 MAK, MAK-L, MARK M34	06.98-12.05			
14.284 MA-KO, MA-LF M34	06.98-12.05			
14.284 MC, MLC, MLLC, MLRC, MRC, MLLRC M31 M33 M32	06.98-12.05			
14.284 MLS, MLRS M32	06.98-12.05			
14.285 MAK, MAK-L, MARK M34	02.03-			
14.285 MA-KO, MA-LF M34	02.03-			
14.285 MC, MLC, MLLC, MLRC, MRC, MLLRC (ME280C) M31 M32 M33	09.99-12.05			
14.285 MLS, MLRS M32	02.03-			
18.224 MAC, MARC M41	08.95-12.05			
18.224 MAK, MAK-L, MARK M41	08.95-12.05			
18.224 MC, MLC, MLLC, MRC, MLRC, MLLRC M38 M40 M39	08.95-12.05			
18.224 MK, MK-L, MLK, MLRK, MRK M39 M38	08.95-12.05			
18.224 MLS, MLRS M39	08.95-12.05			
18.255 MAC, MARC M41	10.00-			
18.255 MAK, MAK-L, MARK M41	10.00-			
18.255 MC, MLC, MLLC, MLRC, MRC, MLLRC M39 M40 M38	10.00-			
18.255 MK, MK-L, MLK, MLRK, MRK M38 M39	11.02-			
18.255 M-KO, MR-KO M38	10.00-			
18.255 MLS, MLRS M39	10.00-			
18.264 MAC, MARC M41	08.95-12.05			
18.264 MAK, MAK-L, MARK M41	08.95-12.05			
18.264 MC, MLC, MLLC, MRC, MLRC, MLLRC M39 M38 M40	08.95-12.05			
18.264 MK, MK-L, MLK, MLRK, MRK M38 M39	08.95-12.05			
18.264 M-KO, MR-KO M38	02.00-			
18.264 MLS, MLRS M39	08.95-12.05			
18.284 MAC, MARC M41	06.98-12.05			
18.284 MAK, MAK-L, MARK M41	06.98-12.05			

M 2000 M 08.95 - 12.05























18.284 MC, MLC, MLLC, MLRC, MRC, MLLRC M40 M39 M38	06.98 - 12.05	D0826LFL10, D0836LF01, D0826LF15, D0826LF18, D0836LF03, D0826LF17, D0836LF05, D0836LFL03	 3400 121 701 ⊗ 3482 000 467 ⊗ 1862 506 131 ⊗ 3151 253 031	395 10 MFZ395 395WGTZ KZIZ-4,5	
18.284 MK, MK-L, MLK, MLRK, MRK M38 M39	06.98 - 12.05				
18.284 M-KO, MR-KO M38	02.00 -				
18.284 MLS, MLRS M39	06.98 - 12.05				
18.285 MAC, MARC M41	02.03 -				
18.285 MAK, MAK-L, MARK M41	01.96 - 07.05				
18.285 MC, MLC, MLLC, MLRC, MRC, MLLRC M38 M40 M39	06.98 - 12.05				
18.285 MK, MK-L, MLK, MLRK, MRK M38 M39	02.03 -				
18.285 M-KO, MR-KO M38	02.03 -				
18.285 MLS, MLRS M39	02.03 -				
25.224 MNLC, MNLLC, MNLRC, MNLLRC, MVLC M43 M42 M44	08.95 - 12.05				
25.224 MNLC, MNLLC, MNLRC, MNLLRC, MVLC M42 M44 M43	08.95 - 12.05				
25.264 MNLC, MNLLC, MNLRC, MNLLRC, MVLC M42 M43 M44	08.95 - 12.05				
25.264 MNLC, MNLLC, MNLRC, MNLLRC, MVLC M42 M44 M43	08.95 - 12.05				
25.284 MNLC, MNLLC, MNLRC, MNLLRC, MVLC M43 M44 M42	02.00 -				
25.284 MNLC, MNLLC, MNLRC, MNLLRC, MVLC M42 M43 M44	02.00 -				
25.285 MNLC, MNLLC, MNLRC, MNLLRC, MVLC M42 M44 M43	02.03 -				
25.285 MNLC, MNLLC, MNLRC, MNLLRC, MVLC M43 M44 M42	02.03 -				





























M 90 08.88 - 12.98

12.152 F, 12.152 FL M01 M02	12.88 - 05.94	D0826F01, 02	 3482 008 141 #	310 MF310	M01,02 Je nach Kundenwunsch mit unterschiedlicher Kupplung / Equipped with different clutch according to customer requirement	(35)
12.152 FK M01	12.88 - 05.94		 3151 199 001	KZIS-3	M01,02	
12.152 FS, 12.152 FLS M02 M01	12.88 - 05.94		 3400 700 322 ⊗ 3482 093 032 ⊗ 1862 438 032	330 10 MFZ330 330WTB	M01,02 Je nach Kundenwunsch mit unterschiedlicher Kupplung / Equipped with different clutch according to customer requirement	(35)
			 3400 121 801 ⊗ 3482 120 031 ⊗ 1878 044 631	362 10 MFZ362 362GTZ	M01,02 Je nach Kundenwunsch mit unterschiedlicher Kupplung / Equipped with different clutch according to customer requirement	(35)
			 3182 005 231	HHISZ-3	M01,02 Füllmedium: Bremsflüssigkeit / Fill Medium: Brake Fluid Immer erneuern / Renew everytime	(25) (30)
			 3400 710 001 ⊗ 3482 120 031 ⊗ 1878 044 631 ⊗ 3182 005 231	362 10 MFZ362 362GTZ HHISZ-3	M01,02	

		CODE		 Parameter		
--	--	------	--	---	---	---

































MAN

M 90		08.88 - 12.98				
12.192 F,12.192 FL M01 M02 12.192 FA M07	07.90 - 06.96	D0826TF01, 05	 3400 125 501 ⊗ 3482 060 132 ⊗ 1878 001 077 ⊙ 3151 199 001	350 10 MF350 350GTZ KZIS-3	M01,02,07 Je nach Kundenwunsch mit unterschiedlicher Kupplung / Equipped with different clutch according to customer requirement	(35)
	10.92 - 06.96		 3482 017 035	380 GMF380	M01,02,07 Je nach Kundenwunsch mit unterschiedlicher Kupplung / Equipped with different clutch according to customer requirement	(35)
			 3482 017 034	380 GMF380	M01,02,07 für Fahrzeuge mit Kupplungskraftverstärker / for vehicles with clutch booster	(73)
			 1878 001 152	380 10 380WGTZ	M01,02,07	
			 3151 000 395	KZIS-4	M01,02,07	
12.192 FAK M07 12.192 FK M01 12.192 FS,12.192 FLS M01 M02	10.92 - 06.96	D0826TF01, 05	 3400 125 501 ⊗ 3482 060 132 ⊗ 1878 001 077 ⊙ 3151 199 001	350 10 MF350 350GTZ KZIS-3	M01,02,07 Je nach Kundenwunsch mit unterschiedlicher Kupplung / Equipped with different clutch according to customer requirement	(35)
	07.90 - 06.96		D0826LF02, 06	 3482 017 035	380 GMF380	M03,04
		 1878 000 957		380 10 380GTZ	M03,04	
		 3151 000 395		KZIS-4	M03,04	
		 3482 017 034		380 GMF380	M03,04 für Fahrzeuge mit Kupplungskraftverstärker / for vehicles with clutch booster	(73)
		 1878 001 152		380 10 380WGTZ	M03,04 für Fahrzeuge mit Kupplungskraftverstärker / for vehicles with clutch booster	(73)
	 3151 000 395	KZIS-4	M03,04 für Fahrzeuge mit Kupplungskraftverstärker / for vehicles with clutch booster	(73)		
12.222 F,12.222 FL M01 M02 12.222 FA M07 12.222 FAK M07 12.222 FK M01 12.222 FLS M02 12.262 F,12.262 FL M01 M02 12.262 FK M01 12.262 FS,12.262 FLS M01 M02 14.162 F,14.162 FL M03 M04 14.162 FK M03 14.162 FS,14.162 FLS M03 M04 14.222 F,14.222 FL M03 M04 14.222 FK M03 14.222 FLS M04 14.262 F,14.262 FL M03 M04 14.262 FK M03 14.262 FS,14.262 FLS M04 M03	05.94 - 06.96	D0826LF13, D0824LF02, D0826LF11	 3482 008 141 #	310 MF310	Je nach Kundenwunsch mit unterschiedlicher Kupplung / Equipped with different clutch according to customer requirement	(35)
	05.94 - 06.96		 3151 199 001	KZIS-3		
	05.94 - 06.96		 3400 700 322 ⊗ 3482 093 032 ⊗ 1862 438 032	330 10 MFZ330 330WTB	Je nach Kundenwunsch mit unterschiedlicher Kupplung / Equipped with different clutch according to customer requirement	(35)
	05.94 - 06.96		 3182 005 231	HHISZ-3	nur in Verbindung mit / only in connection with: 3482 093 032 Füllmedium: Bremsflüssigkeit / Fill Medium: Brake Fluid Immer erneuern / Renew everytime	(101) (25)
	08.95 - 06.96		 3400 125 501 ⊗ 3482 060 132 ⊗ 1878 001 077 ⊙ 3151 199 001	350 10 MF350 350GTZ KZIS-3	Je nach Kundenwunsch mit unterschiedlicher Kupplung / Equipped with different clutch according to customer requirement	(35)
	08.95 - 06.96		 3482 017 035	380 GMF380	Je nach Kundenwunsch mit unterschiedlicher Kupplung / Equipped with different clutch according to customer requirement	(35)
	08.95 - 06.96		 1878 000 957	380 10 380GTZ		
	08.95 - 06.96		 3151 000 395	KZIS-4		
	05.94 - 06.96		 3482 017 034	380 GMF380	für Fahrzeuge mit Kupplungskraftverstärker / for vehicles with clutch booster	(73)
	05.94 - 06.96		 1878 001 152	380 10 380WGTZ	für Fahrzeuge mit Kupplungskraftverstärker / for vehicles with clutch booster	(73)
	05.94 - 06.96		 3151 000 395	KZIS-4	für Fahrzeuge mit Kupplungskraftverstärker / for vehicles with clutch booster	(73)

M 90		08.88 - 12.98					
12.232 F,12.232 FL M01 M02	08.88 - 06.96	D0826LF02, 06	 3482 017 035	380 GMF380	M01,02,07		
12.232 FA M07	05.90 - 06.96		 1878 000 957	380 10 380GTZ	M01,02,07		
12.232 FAK M07	05.90 - 06.96		 3151 000 395	KZIS-4	M01,02,07		
12.232 FK M01	08.88 - 06.96		 3482 017 034	380 GMF380	M01,02,07 für Fahrzeuge mit Kupplungskraftverstärker / for vehicles with clutch booster	(73)	
12.232 FS,12.232 FLS M01 M02	08.88 - 06.96		 1878 001 152	380 10 380WGTZ	M01,02,07 für Fahrzeuge mit Kupplungskraftverstärker / for vehicles with clutch booster	(73)	
12.272 F,12.272 FL M02 M01	09.91 - 10.92		 3151 000 395	KZIS-4	M01,02,07 für Fahrzeuge mit Kupplungskraftverstärker / for vehicles with clutch booster	(73)	
12.272 F,12.272 FL M01 M02	10.92 - 06.96						
12.272 FA M07	10.93 - 04.95						
12.272 FAK M07	10.93 - 04.95						
12.272 FK M01	09.91 - 10.92						
12.272 FK M01	10.92 - 06.96						
12.272 FS,12.272 FLS M01 M02	09.91 - 10.92						
12.272 FS,12.272 FLS M01 M02	10.92 - 06.96						
14.272 F,14.272 FL M03 M04	09.91 - 10.92						
14.272 FK M03	09.91 - 10.92						
14.272 FS,14.272 FLS M03 M04	09.91 - 10.92						
15.272 M03,04	01.91 -						
13.152 M01,02	01.88 -	D0826F01, D0826F02	 3482 008 141 #	310 MF310	Je nach Kundenwunsch mit unterschiedlicher Kupplung / Equipped with different clutch according to customer requirement	(35)	
14.152 F,14.152 FL M03 M04	12.88 - 04.94		 3151 199 001	KZIS-3			
14.152 FK M03	12.88 - 05.94		 3400 700 322	330 10 MFZ330	Je nach Kundenwunsch mit unterschiedlicher Kupplung / Equipped with different clutch according to customer requirement	(35)	
14.152 FS,14.152 FLS M03 M04	12.88 - 05.94		 3482 093 032  1862 438 032	330WTB			
			 3400 121 801	362 10 MFZ362	Je nach Kundenwunsch mit unterschiedlicher Kupplung / Equipped with different clutch according to customer requirement	(35)	
			 3482 120 031  1878 044 631	362GTZ			
		 3182 005 231	HHISZ-3	Füllmedium: Bremsflüssigkeit / Fill Medium: Brake Fluid Immer erneuern / Renew everytime	(25)		
		 3400 710 001	362 10 MFZ362				
		 3482 120 031  1878 044 631  3182 005 231	362GTZ HHISZ-3				
13.192 M01,02	01.88 -	D0826TF	 3400 125 501	350 10 MF350	Je nach Kundenwunsch mit unterschiedlicher Kupplung / Equipped with different clutch according to customer requirement	(35)	
15.192 M03,04	01.88 -		 3482 060 132  1878 001 077  3151 199 001	350GTZ KZIS-3			
			 3482 017 035	380 GMF380	Je nach Kundenwunsch mit unterschiedlicher Kupplung / Equipped with different clutch according to customer requirement	(35)	
			 1878 000 957	380 10 380GTZ			
			 3151 000 395	KZIS-4			
			 3482 017 034	380 GMF380	für Fahrzeuge mit Kupplungskraftverstärker / for vehicles with clutch booster	(73)	
			 1878 001 152	380 10 380WGTZ	für Fahrzeuge mit Kupplungskraftverstärker / for vehicles with clutch booster	(73)	
		 3151 000 395	KZIS-4	für Fahrzeuge mit Kupplungskraftverstärker / for vehicles with clutch booster	(73)		



































		CODE				
--	--	------	--	---	---	---

MAN

M 90		08.88 - 12.98					
13.232 M01,02	01.88-	D0826LFL06, D0826LFL02, D0826LF02, D0826LF06	 3482 017 035	380 GMF380			
13.272 M01,02	01.91-		 1878 000 957	380 10 380GTZ			
15.232 M03,04	01.88-		 3151 000 395	KZIS-4			
			 3482 017 034	380 GMF380	für Fahrzeuge mit Kupplungskraftverstärker / for vehicles with clutch booster	(73)	
			 1878 001 152	380 10 380WGTZ	für Fahrzeuge mit Kupplungskraftverstärker / for vehicles with clutch booster	(73)	
			 3151 000 395	KZIS-4	für Fahrzeuge mit Kupplungskraftverstärker / for vehicles with clutch booster	(73)	
14.152 F,14.152 FL M03 M04	05.94 - 06.96	D0824LF01	 3482 008 141 #	310 MF310	Je nach Kundenwunsch mit unterschiedlicher Kupplung / Equipped with different clutch according to customer requirement	(35)	
14.152 FK M03	05.94 - 06.96		 3151 199 001	KZIS-3			
14.152 FS,14.152 FLS M04 M03	05.94 - 06.96		 3400 700 322	330 10 MFZ330	Je nach Kundenwunsch mit unterschiedlicher Kupplung / Equipped with different clutch according to customer requirement	(35)	
			 3482 093 032  1862 438 032	330WTTB			
			 3182 005 231	HHISZ-3	nur in Verbindung mit / only in connection with: 3482 093 032 Füllmedium: Bremsflüssigkeit / Fill Medium: Brake Fluid Immer erneuern / Renew everytime	(101) (25) (30)	
14.192 F,14.192 FL M04 M03	08.88 - 06.90	D0826TF	 3400 125 501	350 10 MF350	Je nach Kundenwunsch mit unterschiedlicher Kupplung / Equipped with different clutch according to customer requirement	(35)	
14.192 FS,14.192 FLS M04 M03	08.88 - 06.90		 3482 060 132  1878 001 077  3151 199 001	350GTZ KZIS-3			
			 3482 017 035	380 GMF380	Je nach Kundenwunsch mit unterschiedlicher Kupplung / Equipped with different clutch according to customer requirement	(35)	
			 3482 017 034	380 GMF380	für Fahrzeuge mit Kupplungskraftverstärker / for vehicles with clutch booster	(73)	
			 1878 001 152	380 10 380WGTZ			
			 3151 000 395	KZIS-4			
14.192 F,14.192 FL M03 M04	07.90 - 06.96	D0826LF13, D0826LF11, D0826LF01, D0826LF05, D0826LF07	 3400 125 501	350 10 MF350	Je nach Kundenwunsch mit unterschiedlicher Kupplung / Equipped with different clutch according to customer requirement	(35)	
14.192 FK M03	07.90 - 06.96		 3482 060 132  1878 001 077  3151 199 001	350GTZ KZIS-3			
14.192 FS,14.192 FLS M04 M03	07.90 - 06.96		 3482 017 035	380 GMF380	Je nach Kundenwunsch mit unterschiedlicher Kupplung / Equipped with different clutch according to customer requirement	(35)	
17.222 FA M08	05.94 - 06.96		 1878 000 957	380 10 380GTZ			
17.222 FAK M08	05.94 - 06.96		 3482 017 034	380 GMF380	für Fahrzeuge mit Kupplungskraftverstärker / for vehicles with clutch booster	(73)	
18.222 F,18.222 FL,18.222 FLL M05 M16 M06	05.94 - 06.96		 1878 001 152	380 10 380WGTZ			
18.222 FK M05	05.94 - 06.96		 3151 000 395	KZIS-4			
18.262 F,18.262 FL,18.262 FLL M05 M06 M16	08.95 - 06.96						
18.262 FK M05	08.95 - 06.96						
24.222 FNL,24.222 FNLL,24.222 FVL M09 M19 M10	05.94 - 06.96						
24.222 FNL,24.222 FNLL,24.222 FVL M09 M10 M19	05.94 - 06.96						
24.262 FNL,24.262 FNLL,24.262 FVL M09 M10 M19	08.95 - 06.96						
14.192 FK M03	08.88 - 06.90	D0826TF	 3400 125 501	350 10 MF350			
			 3482 060 132  1878 001 077  3151 199 001	350GTZ KZIS-3			

































		CODE				
--	--	------	--	---	---	---









































MAN

M 90		08.88 - 12.98					
14.232 F,14.232 FL M03 M04	05.90 - 04.95	D0826LF02, 06	 3482 017 035	380 GMF380	M03,04		
14.232 F,14.232 FL M03 M04	08.88 - 06.96		 1878 000 957	380 10 380GTZ	M03,04		
14.232 FK M03	08.88 - 06.96		 3482 017 034	380 GMF380	M03,04 für Fahrzeuge mit Kupplungskraftverstärker / for vehicles with clutch booster	(73)	
14.232 FS,14.232 FLS M03 M04	05.90 - 04.95		 1878 001 152	380 10 380WGTZ	M03,04		
14.232 FS,14.232 FLS M04 M03	08.88 - 06.96		 3151 000 395	KZIS-4	M03,04		
14.272 F,14.272 FL M03 M04	10.92 - 06.96		D0826LF04	 3482 017 035	380 GMF380	M03,04	
14.272 FK M03	10.92 - 06.96	 1878 000 957		380 10 380GTZ	M03,04		
14.272 FS,14.272 FLS M04 M03	12.92 - 06.96	 3482 017 034		380 GMF380	M03,04 für Fahrzeuge mit Kupplungskraftverstärker / for vehicles with clutch booster	(73)	
		 1878 001 152		380 10 380WGTZ	M03,04		
		 3151 000 395		KZIS-4	M03,04		
17.192 F,17.192 FL M05 M06	08.88 - 06.90	D0826TF, D2865LF02	 3400 125 501	350 10 MF350	Je nach Kundenwunsch mit unterschiedlicher Kupplung / Equipped with different clutch according to customer requirement	(35)	
17.192 FA M08	02.89 - 06.90		 3482 060 132	350GTZ			
17.192 FAK M08	02.89 - 06.90		 1878 001 077	KZIS-3			
17.192 FK M05	08.88 - 06.90		 3151 199 001				
17.192 FS,17.192 FLS M05 M06	08.88 - 06.90		 3482 017 035	380 GMF380	Je nach Kundenwunsch mit unterschiedlicher Kupplung / Equipped with different clutch according to customer requirement	(35)	
17.272 FLS M06	09.91 - 05.95		 1878 000 957	380 10 380GTZ			
18.272 F,18.272 FL,18.272 FLL M05 M06 M16	09.91 - 05.94		 3482 017 034	380 GMF380	für Fahrzeuge mit Kupplungskraftverstärker / for vehicles with clutch booster	(73)	
18.272 FK M05	09.91 - 05.94		 1878 001 152	380 10 380WGTZ			
			 3151 000 395	KZIS-4			
			 1878 000 964	380 10 380GTZ	für Nebenantrieb / for PTO	(82)	
17.192 F,17.192 FL M05 M06	07.90 - 04.95	D0826LF01, 05	 3400 125 501	350 10 MF350	M05,06,08 Je nach Kundenwunsch mit unterschiedlicher Kupplung / Equipped with different clutch according to customer requirement	(35)	
17.192 FA M08	07.90 - 06.96		 3482 060 132	350GTZ			
17.192 FAK M08	07.90 - 06.96		 1878 001 077	KZIS-3			
17.192 FK M05	07.90 - 01.91		 3151 199 001				
17.192 FS,17.192 FLS M06 M05	07.90 - 04.95		 3482 017 035	380 GMF380	M05,06,08 Je nach Kundenwunsch mit unterschiedlicher Kupplung / Equipped with different clutch according to customer requirement	(35)	
			 1878 000 957	380 10 380GTZ	M05,06,08		
			 3482 017 034	380 GMF380	M05,06,08 für Fahrzeuge mit Kupplungskraftverstärker / for vehicles with clutch booster	(73)	
			 1878 001 152	380 10 380WGTZ	M05,06,08		
			 3151 000 395	KZIS-4	M05,06,08		
			 3400 700 412	380 10 GMF380	M05,06,08 für Fahrzeuge mit Kupplungskraftverstärker / for vehicles with clutch booster	(73)	
		 3482 017 034	380GTZ				
		 1878 000 964	KZIS-4				
		 3151 000 395					
		 1878 000 964	380 10 380GTZ	für Nebenantrieb / for PTO	(82)		

		CODE				
--	--	------	--	---	---	---







MAN

M 90		08.88 - 12.98						
17.232 F,17.232 FL M06 M05	05.90 - 04.95	D0826LF02, 06	 3482 017 035	380 GMF380	M05,06,08			
17.232 F,17.232 FL M05 M06	08.88 - 04.95		 1878 000 957	380 10 380GTZ	M05,06,08			
17.232 FA M08	05.90 - 04.95		 3482 017 034	380 GMF380	M05,06,08 für Fahrzeuge mit Kupplungskraftverstärker / for vehicles with clutch booster	(73)		
17.232 FA M08	02.89 - 06.96		 1878 001 152	380 10 380WGTZ	M05,06,08			
17.232 FAK M08	05.90 - 04.95		 3151 000 395	KZIS-4	M05,06,08			
17.232 FAK M08	02.89 - 06.96		 3400 700 412  3482 017 034  1878 000 964  3151 000 395	380 10 GMF380 380GTZ KZIS-4	M05,06,08 für Fahrzeuge mit Kupplungskraftverstärker / for vehicles with clutch booster	(73)		
17.232 FK M05	05.90 - 01.91		D0826LF	 1878 000 964	380 10 380GTZ	für Nebenantrieb / for PTO	(82)	
17.232 FS,17.232 FLS M05 M06	05.90 - 04.95							
17.232 FS,17.232 FLS M05 M06	08.88 - 04.95							
17.272 FLS M06	10.92 - 05.95			D0826LF04	 3482 017 035	380 GMF380	M05,06,16	
18.272 F,18.272 FL,18.272 FLL M06 M05 M16	10.92 - 06.96	 1878 000 957	380 10 380GTZ		M05,06,16			
18.272 FK M05	10.92 - 06.96	 3482 017 034	380 GMF380		M05,06,16 für Fahrzeuge mit Kupplungskraftverstärker / for vehicles with clutch booster	(73)		
		 1878 001 152	380 10 380WGTZ		M05,06,16			
		 3151 000 395	KZIS-4		M05,06,16			
		 3400 700 412  3482 017 034  1878 000 964  3151 000 395	380 10 GMF380 380GTZ KZIS-4		M05,06,16 für Fahrzeuge mit Kupplungskraftverstärker / for vehicles with clutch booster	(73)		
		 1878 000 964	380 10 380GTZ		für Nebenantrieb / for PTO	(82)		
18.192 F,18.192 FL,18.192 FLL M06 M16 M05	09.90 - 06.96	D0826LF01, 05	 3400 125 501  3482 060 132  1878 001 077  3151 199 001	350 10 MF350 350GTZ KZIS-3	M05,06,08,16 Je nach Kundenwunsch mit unterschiedlicher Kupplung / Equipped with different clutch according to customer requirement	(35)		
18.192 FK M05	09.90 - 06.96		 3482 017 035	380 GMF380	M05,06,08,16 Je nach Kundenwunsch mit unterschiedlicher Kupplung / Equipped with different clutch according to customer requirement	(35)		
			 3482 017 034	380 GMF380	M05,06,08,16 für Fahrzeuge mit Kupplungskraftverstärker / for vehicles with clutch booster	(73)		
			 1878 001 152	380 10 380WGTZ	M05,06,08,16			
			 3151 000 395	KZIS-4	M05,06,08,16			
			 3400 700 412  3482 017 034  1878 000 964  3151 000 395	380 10 GMF380 380GTZ KZIS-4	M05,06,08,16 für Fahrzeuge mit Kupplungskraftverstärker / for vehicles with clutch booster	(73)		
			 1878 000 964	380 10 380GTZ	für Nebenantrieb / for PTO	(82)		

















M 90		08.88 - 12.98					
18.232 F,18.232 FL,18.232 FLL M05 M16 M06 18.232 FK M05	09.90 - 06.96	D0826LF	 3400 121 701  3482 000 467  1862 506 131  3151 253 031	395 10 MFZ395 395WGTZ KZIZ-4,5	X43		
	09.90 - 06.96		 1878 000 964	380 10 380GTZ	für Nebenantrieb / for PTO	(82)	
			 3482 017 035	380 GMF380	M05,06,08,16		
			 1878 000 957	380 10 380GTZ	M05,06,08,16		
			 3482 017 034	380 GMF380	M05,06,08,16 für Fahrzeuge mit Kupplungskraftverstärker / for vehicles with clutch booster	(73)	
			 1878 001 152	380 10 380WGTZ	M05,06,08,16		
			 3151 000 395	KZIS-4	M05,06,08,16		
			 3400 700 412  3482 017 034  1878 000 964  3151 000 395	380 10 GMF380 380GTZ KZIS-4	M05,06,08,16 für Fahrzeuge mit Kupplungskraftverstärker / for vehicles with clutch booster	(73)	
18.310		D2866LOH25	 3482 083 032	430 MFZ430	Getr. / GBox: ZF 6S85		
			 1878 061 841	430 10 430WGTZ	Getr. / GBox: ZF 6S85		
			 3151 000 034	KZISZ-5	Getr. / GBox: ZF 6S85		
			 3189 600 020		Getr. / GBox: ZF Ecosplit-3		
18.350 18.400		D2866LOH23, D2866LOH26	 3400 122 201  3482 083 032  1878 004 832  3151 000 034	430 10 MFZ430 430WGTZ KZISZ-5	Getr. / GBox: ZF 8S180		
			 3189 600 020		Getr. / GBox: ZF Ecosplit-3		
24.192 FNL,24.192 FNLL,24.192 FVL M09 M10 M19	07.89 - 06.96	D0826LF01, 05	 3400 125 501  3482 060 132  1878 001 077  3151 199 001	350 10 MF350 350GTZ KZIS-3	M09,10 Je nach Kundenwunsch mit unterschiedlicher Kupplung / Equipped with different clutch according to customer requirement	(35)	
			 3482 017 035	380 GMF380	M09,10 Je nach Kundenwunsch mit unterschiedlicher Kupplung / Equipped with different clutch according to customer requirement	(35)	
			 3482 017 034	380 GMF380	M09,10 für Fahrzeuge mit Kupplungskraftverstärker / for vehicles with clutch booster	(73)	
			 1878 001 152	380 10 380WGTZ	M09,10		
			 3151 000 395	KZIS-4	M09,10		
24.232 FNL M09 24.232 FNL,24.232 FNLL,24.232 FVL M09 M10 M19	05.90 - 04.95	D0826LF02, 06	 3482 017 035	380 GMF380	M09,10		
	07.89 - 06.96		 1878 000 957	380 10 380GTZ	M09,10		
			 3482 017 034	380 GMF380	M09,10 für Fahrzeuge mit Kupplungskraftverstärker / for vehicles with clutch booster	(73)	
			 1878 001 152	380 10 380WGTZ	M09,10		
			 3151 000 395	KZIS-4	M09,10		
24.272 FNL,24.272 FNLL,24.272 FVL M09 M19 M10	10.92 - 06.96	D0826LF04	 3482 017 035	380 GMF380	M09,10		
			 1878 000 957	380 10 380GTZ	M09,10		
			 3482 017 034	380 GMF380	M09,10 für Fahrzeuge mit Kupplungskraftverstärker / for vehicles with clutch booster	(73)	
			 1878 001 152	380 10 380WGTZ	M09,10		
			 3151 000 395	KZIS-4	M09,10		

		CODE		 Parameter		
--	--	------	--	---	---	---

MAN







M 90		08.88 - 12.98				
24.272 FNL, 24.272 FVL M10 M09	09.91 - 05.94	D2865LF02, 04, 05	 3400 127 601 ⊗ 3482 078 133 ⊗ 1862 364 031 ⊙ 3151 000 034	400 10 MFZ400 400WGVZ KZISZ-5	->06.1993 F20 Nabenprofil / Hub Profile: 2"-10N	(48)
			 3400 122 301 ⊗ 3482 083 032 ⊗ 1878 080 034 ⊙ 3151 000 034	430 10 MFZ430 430WGTZ KZISZ-5	07.1993-> F20	
	D2865		 1882 017 131	420 GF420XN	für Nebenantrieb / for PTO	(82)
			 1878 086 941	420 10 420WGTZ	für Nebenantrieb / for PTO	(82)
			 3151 204 001	KZI-6	für Nebenantrieb / for PTO mit Schmierrohranschluss / with lubrication pipe connection	(82) (91)
	D2865LF02		 3189 600 020		Getr. / GBox: ZF Ecosplit-3	

MAN-BÜSSING





400-SERIE 400 L 1 400-SERIE 415 L 1 H,HA,F 400-SERIE 420 HOC 500-SERIE 520 L 1 H,HA,F 600-SERIE 626 F,H,HA			 1880 083 132 #	280 G280		
			 1863 600 125	GR-3	mit Anlauftring / with thrust ring	(88)
400-SERIE 450 HALF 600-SERIE 635 FM Büssing Mowag SW II			 1880 092 415 #	310 G310		
			 1863 600 125	GR-3	mit Anlauftring / with thrust ring	(88)
500-SERIE 515 L 1 600-SERIE 620 L 1 600-SERIE 630 L 1 A 700-SERIE 745 L 1 700-SERIE 750 L 1, L 13 Büssing MK, 25, 26			 1861 034 147 #	350 10		
700-SERIE 770 L 1 1000-SERIE 1070 L 1,A,F 2000-SERIE 2170 L 1 D			 1882 110 532 #	350 GF350		
			 1878 001 074	350 10 350GTZ	->04.1972	
			1878 005 367	350 10 350WGTZ	05.1972->	
			 1863 600 125	GR-3	mit Anlauftring / with thrust ring	(88)
700-SERIE 780 H,HA 1000-SERIE 1080 H 1000-SERIE 1580			 1882 110 532 #	350 GF350		
			 1878 001 074	350 10 350GTZ	->04.1972	
			1878 005 367	350 10 350WGTZ	05.1972->	
1000-SERIE 1580 DF, DH 2000-SERIE 2180 DH, DHA			 1882 110 532 #	350 GF350		
1000-SERIE 1580 FN MA			 1882 110 542 ▲	350 GF350		
			 1878 001 074	350 10 350GTZ	->04.1972	
			1878 005 367	350 10 350WGTZ	05.1972->	
			 3151 000 395	KZIS-4		
BS 13 L 15L		U10D	 1882 325 134	380 G380		
			 1861 470 234	380 10 380GSZ		

MAN

MAN-BÜSSING





Burglöwe K,L,S 10 126M36,T Burglöwe L 10 126M43,50 Burglöwe U,UK,US,UMK,UMW Büssing 8 RU 5 Büssing 11 RU 5HR Büssing 12 RU 5HR Büssing 4000 T,K Büssing 4500 T,U Büssing LS 5 TU Büssing LU,TU 5,10 Büssing LU,TU,LS,OLU 55				1880 092 415 #	310 G310		
				1861 600 033 #	310 10 310GTD		
				1863 600 125	GR-3	mit Anlaufring / with thrust ring	(88)
Burglöwe L09 110 M36				1861 600 033 #	310 10 310GTD		
Burglöwe U BS 11,L09				1880 092 415 #	310 G310		
				1861 600 033 #	310 10 310GTD		

Sonderfahrzeuge



FE 26T 6x4 BL D28 Schweiz E66	04.95 - 03.05			3488 017 447	400 MFZ2/400X	Getr. / GBox: ZF Ecosplit-3 für Fahrzeuge mit Zweis Scheibenkupplung / for vehicles with double disc clutch	(77)
FE 41T 8x4 BB D29 E41	06.97 - 03.05					enthält eine Kupplungsscheibe / This part number includes one clutch disc	(67)
FE 41T 8x8 BB D28 E41	06.97 - 03.05			1878 002 643	400 10 400WGTZ	Getr. / GBox: ZF Ecosplit-3 für Fahrzeuge mit Zweis Scheibenkupplung / for vehicles with double disc clutch	(77)
FE 50T 10x8-8 BH D28 E79	03.96 - 03.04			3151 262 031	KZISZ-5	Getr. / GBox: ZF Ecosplit-3 für Fahrzeuge mit Zweis Scheibenkupplung / for vehicles with double disc clutch	(77)
				3189 600 009		Getr. / GBox: ZF Ecosplit-3 für Fahrzeuge mit Zweis Scheibenkupplung / for vehicles with double disc clutch	(77)



















TGA

03.00 -

18.280 LL H04	02.01 - 08.01	D0836LF44, D0836LF43, D0836LF41		3400 121 701	395 10 MFZ395		
18.330 LL H04	02.01 - 08.01			  	3482 000 467 1862 506 131 3151 253 031	395WGTZ KZIZ-4,5	
				3496 006 000		langer Bügel / long handle	(86)

























































MAN





























TGA		03.00 -				
18.310 FAC, FARC H51	09.02-	D2866LF27, D2866LF26, D2866LF28, D2866LF37, D2866LF32	 3400 127 401 ⊗ 3482 000 361 ⊗ 1878 004 832 ⊙ 3151 000 034	430 10 MFZ430 430WGTZ KZISZ-5		
18.310 FAK, FAK-L, FALK, FALK-L, FHLK H70 H51	09.02-		3400 700 403 ⊗ 3482 000 361 ⊗ 1878 004 832 ⊙ 3151 000 144	430 10 MFZ430 430WGTZ KZISZ-5	Getr. / GBox: AS-Tronic für Ausrückgabel mit Nocken / for release fork with cams	(70)
18.310 FALS, FARS, FAS H51	09.02-		3400 700 450 ⊗ 3482 000 361 ⊗ 1878 004 832 ⊙ 3151 000 493	430 10 MFZ430 430WGTZ KZISZ-5	Getr. / GBox: AS-Tronic für Ausrückgabel mit Rollen / for release fork with rollers	(71)
18.360 FAC, FARC H51	09.02-					
18.360 FAK, FAK-L, FALK, FALK-L, FHLK H51 H70	09.02-					
18.360 FALS, FARS, FAS, FHLS H70 H51	09.02-		 3189 600 004		Getr. / GBox: ZF AS Tronic Rollenausführung / roller version	(58)
18.410 FAC, FARC H51	09.02-		3189 600 020		Getr. / GBox: ZF Ecosplit-3	
18.410 FAS, FALS, FARS H51 H70	09.02-					
18.410, 18.420 FAK, FAK-L, FALK, FALK-L H70 H51	09.02-					
24.360 FNLLC/N, FNLLW, FNLLRW, FNLLRC H44	09.01-					
24.410 FNLLC, FNLLW, FNLLRW, FNLLRC H44	09.01-					
26.310 FDAC, FDARC, FDHC H55	02.02-					
26.310 FDAK, FDHK H55	02.02-					
26.310 FDARS, FDAS, FDHS H55	02.02-					
26.360 FDAC, FDARC, FDHC, FDHLC H55	02.02-					
26.360 FDAK, FDALK, FDHK, FDHLK H72 H55	02.02-					
26.360 FDARS, FDAS, FDHLS, FDHS H55	02.02-					
26.410 FDAC, FDARC H55	02.02-					
26.410 FDAK, FDALK H55 H72	02.02-					
26.410 FDALS, FDARS, FDAS H55 H72	02.02-					
28.360 FNLC, FNLLC H71	07.06-					
28.410 FNLC, FNLLC H71	07.06-					
32.310 FFDC, FFDLC, FFDLRC, FFDRC H40 H36	01.02-					
32.310 FFDK, FFDLK H36 H40	01.02-					
32.310 FFD-TM, FFDR-TM H36	01.02-					
32.360 FFDC, FFDLC, FFDLRC, FFDRC H40 H36	01.02-					
32.360 FFDK, FFDLK H40 H36	01.02-					
32.410 FFDC, FFDLC, FFDRC, FFDLRC H40 H36	01.02-					
32.410 FFDK, FFDLK H40 H36	01.02-					
32.410 FFD-TM, FFDR-TM H36 H48	01.02-					

TGA		03.00 -					
33.360 FDAC, FDARC, FDHC H54 H55	09.02-	D2866LF27, D2866LF26, D2866LF28, D2866LF37, D2866LF32		3400 127 401 ⊗ 3482 000 361 ⊗ 1878 004 832 ⊙ 3151 000 034	430 10 MFZ430 430WGTZ KZISZ-5		
33.360 FDAK, FDARK, FDHK H55 H54	09.02-			3400 700 403 ⊗ 3482 000 361 ⊗ 1878 004 832 ⊙ 3151 000 144	430 10 MFZ430 430WGTZ KZISZ-5	Getr. / GBox: AS-Tronic für Ausrückgabel mit Nocken / for release fork with cams	(70)
33.360 FDARS, FDAS, FDHS H54 H55	09.02-			3400 700 450 ⊗ 3482 000 361 ⊗ 1878 004 832 ⊙ 3151 000 493	430 10 MFZ430 430WGTZ KZISZ-5	Getr. / GBox: AS-Tronic für Ausrückgabel mit Rollen / for release fork with rollers	(71)
33.410 FDAC, FDALC, FDARC H54 H72 H55	09.02-			3189 600 004		Getr. / GBox: ZF AS Tronic Rollenausführung / roller version	(58)
33.410 FDAK, FDALK H55 H72 H54	09.02-			3189 600 020		Getr. / GBox: ZF Ecosplit-3	
33.410 FDALS, FDARS, FDAS H55 H72 H54	09.02-			3189 600 004		Getr. / GBox: ZF AS Tronic Rollenausführung / roller version	(58)
41.360 FFDC, FFDC/M, FFDC/M-WW, FFDC H46 HW3 H38	01.03-		3189 600 020		Getr. / GBox: ZF Ecosplit-3		
18.310 FLLRS, FLLS, FLRS, FLS, FLS-TS H05 H09 H12 H01	04.00-	D2866LF26, D2866LF27, D2866LF36, D2866LF28, D2866LF37, D2866LF32		3400 127 401 ⊗ 3482 000 361 ⊗ 1878 004 832 ⊙ 3151 000 034	430 10 MFZ430 430WGTZ KZISZ-5	Getr. / GBox: ZF Ecosplit-3	
18.310, 18.320 FC, FLC, FLLC, FLLRC, FLLRW, FLLW, FLRC, FRC H05 H14 H09 H02	04.00-			3488 017 447	400 MFZ2/400X	Getr. / GBox: ZF Ecosplit-3 für Fahrzeuge mit Zweischeibenkupplung / for vehicles with double disc clutch enthält eine Kupplungsscheibe / This part number includes one clutch disc	(77) (67)
18.310, 18.320 FK, FLK, FK-L, FLRK H02 H05	12.00-			1878 002 643	400 10 400WGTZ	Getr. / GBox: ZF Ecosplit-3 für Fahrzeuge mit Zweischeibenkupplung / for vehicles with double disc clutch	(77)
18.360 FC, FLC, FLLC, FLLRC, FLLW, FLRC, FLLRW, FRC H14 H02 H09 H05	04.00-			3151 262 031	KZISZ-5	Getr. / GBox: ZF Ecosplit-3 für Fahrzeuge mit Zweischeibenkupplung / for vehicles with double disc clutch	(77)
18.360 FK, FLK, FK-L, FLRK H02 H05	12.00-			3400 700 327 ⊗ 3482 114 031 ⊗ 1878 004 832 ⊙ 3151 263 031	430 10 GMFZ430N 430WGTZ KZIZ-6	Getr. / GBox: ZF 16S-151/181 für Nebenantrieb / for PTO	(82)
18.360 FLLRS, FLLS, FLRS, FLS, FLS-TS H12 H01 H61 H05 H09	04.00-			3400 700 641 HD ⊗ 3482 114 031 ⊗ 1878 007 729 ⊙ 3151 263 031	430 10 GMFZ430N 430WGTZ KZIZ-6	Getr. / GBox: ZF 16S-151/181 Nebenantriebs-ID / PTO ID: NMV 221	(50)
18.410 FLLRS, FLLS, FLRS, FLS, FLS-TS H12 H05 H61 H01 H09	04.00-			3400 700 403 ⊗ 3482 000 361 ⊗ 1878 004 832 ⊙ 3151 000 144	430 10 MFZ430 430WGTZ KZISZ-5	Getr. / GBox: AS-Tronic für Ausrückgabel mit Nocken / for release fork with cams	(70)
18.410, 18.420 FC, FRC, FLC, FLRC, FLLC, FLLW, FLLRC, FLLRW H05 H02 H09 H14	04.00-			3400 700 450 ⊗ 3482 000 361 ⊗ 1878 004 832 ⊙ 3151 000 493	430 10 MFZ430 430WGTZ KZISZ-5	Getr. / GBox: AS-Tronic für Ausrückgabel mit Rollen / for release fork with rollers	(71)
18.410, 18.420 FK, FK-L, FLK, FLRK H02 H05	12.00-			3496 006 000		langer Bügel / long handle	(86)
26.310 FDC, FDLC, FDLRC, FDRC, FNHLC, FVHLC H25 H29	01.01-			3189 600 004		Getr. / GBox: ZF AS Tronic Rollenausführung / roller version	(58)
26.310 FDK, FDLK, FDLRK, FDRK H29 H25	09.02-			3189 600 020		Getr. / GBox: ZF Ecosplit-3	
26.310 FDS, FDLS, FDRS, FDLRS, FNHLS H25 H29	01.01-			3189 600 036		für Fahrzeuge mit Zweischeibenkupplung / for vehicles with double disc clutch	(77)
26.310 FD-TM, FDR-TM H25	10.00-						
26.310 FPLS, FVLS, FNLS, FNLLS, FPLRS, FNLRS, FVLRS H23 H17 H20	12.00-						
26.310 FVL-KO H23	12.00-						
26.360 FDC, FDLC, FDLRC, FDRC, FNHLC, FVHLC H25 H63 H67 H29	01.01-						











		CODE				
--	--	------	--	---	---	---









MAN

TGA		03.00 -					
18.310, 18.320 FAC, FARC, FHLC H22 H52 18.310, 18.320 FAK, FAK-L, FALK, FALK-L, FHLK H22 H80 H52 18.310, 18.320 FALS, FARS, FAS, FHLS H80 H52 H22 18.350, 18.360 FAC, FARC, FHLC H22 HV5 H52 18.350, 18.360 FAK, FAK-L, FALK, FALK-L, FHLK, FHLK/M HV5 H80 H22 H52 18.350, 18.360 FALS, FARS, FAS, FHLS HV5 H22 H52 H80 18.390, 18.400 FAC, FARC, FHLC H22 HV5 H52 18.390, 18.400 FAK, FAK-L, FALK, FALK-L, FHLK, FHLK/M H52 H80 H22 HV5 18.390, 18.400 FALS, FAS, FHLS H52 H80 HV5 H22	05.04-	D2066LF37, D2066LF03, D2066LF39, D2066LF33, D2066LF02, D2066LF35, D2066LF12, D2066LF32, D2066LF14, D2066LF13, D2066LF38, D2066LF04	 3400 700 380  3482 000 361  1878 080 037  3151 000 034	430 10 MFZ430 430WGTZ KZISZ-5	Getr. / GBox: ZF Ecosplit-3 H22		
		05.04-		 3482 000 361	430 MFZ430	Getr. / GBox: AS-Tronic H22	
		05.04-		 1878 080 037	430 10 430WGTZ	Getr. / GBox: AS-Tronic H22	
		05.04-		 3151 000 144	KZISZ-5	Getr. / GBox: AS-Tronic H22 für Ausrückgabel mit Nocken / for release fork with cams	(70)
		05.04-		 3400 700 381  3482 000 361  1878 080 037  3151 000 493	430 10 MFZ430 430WGTZ KZISZ-5	Getr. / GBox: AS-Tronic H22 für Ausrückgabel mit Rollen / for release fork with rollers	(71)
		05.04-		 3400 700 327  3482 114 031  1878 004 832  3151 263 031	430 10 GMFZ430N 430WGTZ KZIZ-6	Getr. / GBox: ZF 16S-151/181 H22 für Nebenantrieb / for PTO	(82)
		05.04-		 3400 700 641 HD  3482 114 031  1878 007 729  3151 263 031	430 10 GMFZ430N 430WGTZ KZIZ-6	Getr. / GBox: ZF 16S-151/181 H22 Nebenantriebs-ID / PTO ID: NMV 221	(50)
		05.04-		 3496 006 000		H22 langer Bügel / long handle	(86)
				 3189 600 020		Getr. / GBox: ZF Ecosplit-3	
	18.310, 18.320 FC, FLC, FLLC, FLLRC, FLLRW, FLLW, FLRC, FRC H15 H03 H06 H10 18.310, 18.320 FK, FK-L, FLK, FLRK H03 H06 H02 18.350, 18.360 FC, FLC, FLLC, FLLRC, FLLW, FLRC, FLLRW, FRC H10 H06 H03 H15 18.350, 18.360 FK, FK-L, FLK, FLRK H06 H03 18.390, 18.400 FC, FLC, FLLC, FLLRC, FLLRW, FLLW, FLRC H03 H15 H10 H06 18.390, 18.400 FK, FK-L, FLK, FLRK H03 H06	05.04-	D2066LF27, D2066LF37, D2066LF28, D2066LF03, D2066LF39, D2066LF33, D2066LF02, D2066LF26, D2066LF35, D2066LF12, D2066LF32, D2066LF14, D2066LF13, D2066LF38, D2066LF04	 3400 700 380  3482 000 361  1878 080 037  3151 000 034	430 10 MFZ430 430WGTZ KZISZ-5	Getr. / GBox: ZF Ecosplit-3 H03	
		05.04-		 3482 000 361	430 MFZ430	Getr. / GBox: AS-Tronic H03	
		05.04-		 1878 080 037	430 10 430WGTZ	Getr. / GBox: AS-Tronic H03	
		05.04-		 3151 000 144	KZISZ-5	Getr. / GBox: AS-Tronic H03 für Ausrückgabel mit Nocken / for release fork with cams	(70)
		05.04-		 3400 700 381  3482 000 361  1878 080 037  3151 000 493	430 10 MFZ430 430WGTZ KZISZ-5	Getr. / GBox: AS-Tronic H03 für Ausrückgabel mit Rollen / for release fork with rollers	(71)
		05.04-		 3400 700 327  3482 114 031  1878 004 832  3151 263 031	430 10 GMFZ430N 430WGTZ KZIZ-6	Getr. / GBox: ZF 16S-151/181 H03 für Nebenantrieb / for PTO	(82)
		05.04-		 3400 700 641 HD  3482 114 031  1878 007 729  3151 263 031	430 10 GMFZ430N 430WGTZ KZIZ-6	Getr. / GBox: ZF 16S-151/181 H03 Nebenantriebs-ID / PTO ID: NMV 221	(50)
		05.04-		 3496 006 000		H03 langer Bügel / long handle	(86)
				 3189 600 020		Getr. / GBox: ZF Ecosplit-3	
18.310, 18.320 FLLRS, FLLS, FLRS, FLS, FLS-TS H13 H10 H06 H08		05.04-	D2066LF28, D2066LF39, D2066LF35, D2066LF14, D2066LF04	 3400 127 401  3482 000 361  1878 004 832  3151 000 034	430 10 MFZ430 430WGTZ KZISZ-5	Getr. / GBox: ZF Ecosplit-3	
			 3400 700 403  3482 000 361  1878 004 832  3151 000 144	430 10 MFZ430 430WGTZ KZISZ-5	Getr. / GBox: AS-Tronic für Ausrückgabel mit Nocken / for release fork with cams	(70)	
			 3400 700 450  3482 000 361  1878 004 832  3151 000 493	430 10 MFZ430 430WGTZ KZISZ-5	Getr. / GBox: AS-Tronic für Ausrückgabel mit Rollen / for release fork with rollers	(71)	
			 3496 006 000		langer Bügel / long handle	(86)	
			 3189 600 004		Getr. / GBox: ZF AS Tronic Rollenausführung / roller version	(58)	
			 3189 600 020		Getr. / GBox: ZF Ecosplit-3		

TGA		03.00 -				
18.350 FLLRS, FLLS, FLRS, FLS, FLS-TS H65 H13 H08 H10 H06 18.390 FLS, FLS-TS, FLLS, FLLRS H06 H08 H65 H13 H10 18.430 FLLRS, FLLS, FLRS, FLS, FLS-TS H08 H13 H06 H65 H10	05.04-	D2066LF03, D2066LF02, D2066LF11, D2066LF12, D2066LF01, D2066LF13	 3400 700 380  3482 000 361  1878 080 037  3151 000 034	430 10 MFZ430 430WGTZ KZISZ-5	Getr. / GBox: ZF Ecosplit-3	
	05.04-		 3400 700 381  3482 000 361  1878 080 037  3151 000 493	430 10 MFZ430 430WGTZ KZISZ-5	Getr. / GBox: ZF AS-Tronic für Ausrückgabel mit Rollen / for release fork with rollers	(71)
	05.04-		 3400 700 403  3482 000 361  1878 004 832  3151 000 144	430 10 MFZ430 430WGTZ KZISZ-5	Getr. / GBox: ZF AS-Tronic für Ausrückgabel mit Nocken / for release fork with cams	(70)
			 3400 700 327  3482 114 031  1878 004 832  3151 263 031	430 10 GMFZ430N 430WGTZ KZIZ-6	Getr. / GBox: ZF Ecosplit-3 für Nebenantrieb / for PTO	(82)
			 3400 700 641 HD  3482 114 031  1878 007 729  3151 263 031	430 10 GMFZ430N 430WGTZ KZIZ-6	Getr. / GBox: ZF Ecosplit-3 Nebenantriebs-ID / PTO ID: NMV 221	(50)
			 3488 017 447	400 MFZ2/400X	Getr. / GBox: ZF Ecosplit-3 für Fahrzeuge mit Zweischeibenkupplung / for vehicles with double disc clutch enthält eine Kupplungsscheibe / This part number includes one clutch disc	(77) (67)
			 1878 002 643	400 10 400WGTZ	Getr. / GBox: ZF Ecosplit-3 für Fahrzeuge mit Zweischeibenkupplung / for vehicles with double disc clutch	(77)
			 3151 262 031	KZISZ-5	Getr. / GBox: ZF Ecosplit-3 für Fahrzeuge mit Zweischeibenkupplung / for vehicles with double disc clutch	(77)
			 3496 006 000		Getr. / GBox: ZF langer Bügel / long handle	(86)
			 1863 869 038		Getr. / GBox: ZF	
			 3189 600 004		Getr. / GBox: ZF AS Tronic Rollenausführung / roller version	(58)
			 3189 600 020		Getr. / GBox: ZF Ecosplit-3	
			 3189 600 036		für Fahrzeuge mit Zweischeibenkupplung / for vehicles with double disc clutch	(77)











MAN











TGA		03.00 -			
18.360 FLLRS, FLLS, FLRS, FLS, FLS-TS H10 H65 H08 H13 H06	01.06-	 3400 700 380 ⊗ 3482 000 361 ⊗ 1878 080 037 ⊙ 3151 000 034	430 10 MFZ430 430WGTZ KZISZ-5	Getr. / GBox: ZF Ecosplit-3	
18.400 FLS, FLLS, FLRS, FLLRS, FLS-TS H65 H08 H06 H10 H13	10.05-	 3482 000 361	430 MFZ430	Getr. / GBox: AS-Tronic	
18.440 FLLRS, FLLS, FLRS, FLS, FLS-TS H08 H06 H13 H10	09.05-	 1878 080 037	430 10 430WGTZ	Getr. / GBox: AS-Tronic	
19.350 FLRS, FLS, FRS, FS HW7 HW1 H64	05.04-	 3151 000 144	KZISZ-5	Getr. / GBox: AS-Tronic für Ausrückgabel mit Nocken / for release fork with cams	(70)
19.360 FLRS, FLS, FRS, FS H60 H43	05.04-	 3400 700 381 ⊗ 3482 000 361 ⊗ 1878 080 037 ⊙ 3151 000 493	430 10 MFZ430 430WGTZ KZISZ-5	Getr. / GBox: AS-Tronic für Ausrückgabel mit Rollen / for release fork with rollers	(71)
19.360 FLRS, FLS, FRS, FS HW1 HW7 HW5 H64	05.04-	 3400 700 327 ⊗ 3482 114 031 ⊗ 1878 004 832 ⊙ 3151 263 031	430 10 GMFZ430N 430WGTZ KZISZ-6	Getr. / GBox: ZF 16S-151/181 für Nebenantrieb / for PTO	(82)
19.390 FLRS, FLS, FRS, FS H64 HW1 HW7	05.04-	 3400 700 641 HD ⊗ 3482 114 031 ⊗ 1878 007 729 ⊙ 3151 263 031	430 10 GMFZ430N 430WGTZ KZISZ-6	Getr. / GBox: ZF 16S-151/181 Nebenantriebs-ID / PTO ID: NMV 221	(50)
19.400 FLRS, FLS, FRS, FS HW7 H64 HW1 HW5	05.04-	 3496 006 000		langer Bügel / long handle	(86)
19.410 FRS, FS H43 H60	05.04-	 1863 869 038			
19.430 FLRS, FLS, FRS, FS HW7 HW1 H64	05.04-	 3189 600 020		Getr. / GBox: ZF Ecosplit-3	
24.350, 24.360 FLLRW, FNLLC, FNLLRC, FNLLRW, FNLLW H45	02.04-				
24.350, 24.360 FPLS, FPLRS H24	05.04-				
24.390, 24.400 FLLRW, FNLLC, FNLLRC, FNLLW, FNLLRC H45	05.04-				
24.390, 24.400 FPLS, FPLRS H24	05.04-				
24.430, 24.440 FNLLC, FNLR, FNLLW, FNLLRC, FNLLRW H45	05.04-				
24.430, 24.440 FPLS, FPLRS H24	05.04-				
26.310 FDAC, FDARC, FDH, FDHC H56 H47	01.04-				
26.310 FDAQ, FDHK H56	01.04-				
26.310 FDARS, FDAS, FDHS H47 H56	01.04-				
26.310 FNLC, FNLLC, FNLLRC, FNLLRW, FNLLW, FNLR, FVLC H17 H23 H20	09.00-				
26.310 FPLS, FVLS, FNLS, FNLLS, FPLRS, FNLR, FVLR H23 H17 H20	12.00-				
26.310 FVLC H23	09.03-				
26.310, 26.320 FDAQ, FDHK H56 H47	06.05-				
26.310, 26.320 FDAS, FDHS H47	06.05-				
26.310, 26.320 FDH, FDHC, FDHC/M H47	06.05-				
26.310, 26.320 FDH-TM H47	06.05-				
26.310, 26.320 FVLC H24	02.04-				
26.310, 26.320 FVL-KO H24	02.04-				
26.320 FDAC, FDH, FDHC H56 H47	06.05-				

TGA		03.00 -				
26.320 FDAK, FDHK H56	04.06-		3400 700 380 ⊗ 3482 000 361 ⊗ 1878 080 037 ⊙ 3151 000 034	430 10 MFZ430 430WGTZ KZISZ-5	Getr. / GBox: ZF Ecosplit-3	
26.320 FDAS, FDHS H56	04.06-					
26.350 FDAC, FDHC H56 H47	02.04-		3482 000 361	430 MFZ430	Getr. / GBox: AS-Tronic	
26.350 FDAK H56	02.04-		1878 080 037	430 10 430WGTZ	Getr. / GBox: AS-Tronic	
26.350 FDAS, FDHS H56 H47	02.04-		3151 000 144	KZISZ-5	Getr. / GBox: AS-Tronic für Ausrückgabel mit Nocken / for release fork with cams	(70)
26.350 FDHC, FDHC/M H47	04.05-					
26.350 FDLRC-WW H67	05.04-		3400 700 381 ⊗ 3482 000 361 ⊗ 1878 080 037 ⊙ 3151 000 493	430 10 MFZ430 430WGTZ KZISZ-5	Getr. / GBox: AS-Tronic für Ausrückgabel mit Rollen / for release fork with rollers	(71)
26.350 FDLRS, FDLRS, FDLRS/M, FDLRS-WW HV2 H67 H30	05.04-		3400 700 327 ⊗ 3482 114 031 ⊗ 1878 004 832 ⊙ 3151 263 031	430 10 GMFZ430N 430WGTZ KZIZ-6	Getr. / GBox: ZF 16S-151/181 für Nebenantrieb / for PTO	(82)
26.350 FVHLC H42	06.05-					
26.350 FVHLS H42	07.05-		3400 700 641 HD ⊗ 3482 114 031 ⊗ 1878 007 729 ⊙ 3151 263 031	430 10 GMFZ430N 430WGTZ KZIZ-6	Getr. / GBox: ZF 16S-151/181 Nebenantriebs-ID / PTO ID: NMV 221	(50)
26.350 FVLC H24	01.04-					
26.350 FVLS, FVLRS H24	07.05-		3496 006 000		langer Bügel / long handle	(86)
26.350, 26.360 FDAK, FDALK, FDHK, FDHLK HH1 H47 H56	05.04-		1863 869 038			
26.350, 26.360 FDARS, FDAS, FDHLS, FDHS H47 HH1	05.04-					
26.350, 26.360 FDH-TM H47	05.04-					
26.350, 26.360 FVL-KO H24	01.04-					
26.360 FDAC, FDARC, FDHC, FDHLC HH1 H47 H56	06.04-					
26.360 FVHLC H42	04.06-					
26.360 FVHLS H42	04.06-					
26.360 FVLC H24	04.06-					
26.360 FVLS, FVLRS H24	04.06-					
26.390 FDAC, FDALC, FDHC H56 H82 H47	01.04-					
26.390 FDAK, FDALK, FDHK H56 H82	02.04-					
26.390 FDALS, FDAS, FDALS, FDHS H82 H56	02.04-					











		CODE				
--	--	------	--	---	---	---











MAN

TGA		03.00 -				
26.390 FDH-TM H47	06.05-		3400 700 380 ⊗ 3482 000 361 ⊗ 1878 080 037 ⊙ 3151 000 034	430 10 MFZ430 430WGTZ KZISZ-5	Getr. / GBox: ZF Ecosplit-3	
26.390 FVLC H24	02.04-					
26.390 FVLS, FVLRS H24	07.05-		3482 000 361	430 MFZ430	Getr. / GBox: AS-Tronic	
26.390, 26.400 FDAK, FDALK, FDHK, FDHLK H47 H56 H82 HH1	06.05-		1878 080 037	430 10 430WGTZ	Getr. / GBox: AS-Tronic	
26.390, 26.400 FDALS, FDAS, FDHLS, FDHS HH1 H47	06.05-		3151 000 144	KZISZ-5	Getr. / GBox: AS-Tronic für Ausrückgabel mit Nocken / for release fork with cams	(70)
26.390, 26.400 FDHC, FDHC/M, FDHLC HH1 H47	06.05-		3400 700 381 ⊗ 3482 000 361 ⊗ 1878 080 037 ⊙ 3151 000 493	430 10 MFZ430 430WGTZ KZISZ-5	Getr. / GBox: AS-Tronic für Ausrückgabel mit Rollen / for release fork with rollers	(71)
26.390, 26.400 FVL-KO H24	02.04-		3400 700 327 ⊗ 3482 114 031 ⊗ 1878 004 832 ⊙ 3151 263 031	430 10 GMFZ430N 430WGTZ KZIZ-6	Getr. / GBox: ZF 16S-151/181 für Nebenantrieb / for PTO	(82)
26.400 FDAC, FDALC, FDHC, FDHLC H47 H56 HH1 H82	01.04-		3400 700 641 HD ⊗ 3482 114 031 ⊗ 1878 007 729 ⊙ 3151 263 031	430 10 GMFZ430N 430WGTZ KZIZ-6	Getr. / GBox: ZF 16S-151/181 Nebenantriebs-ID / PTO ID: NMV 221	(50)
26.400 FVLC H24	02.04-					
26.400 FVLS, FVLRS H24	04.06-					
26.410 FVLC H23	09.03-					
26.410 FVLS, FVLRS H23	07.05-					
26.430 FDAC, FDALC, FDHC H47 H56 H82	01.04-		3496 006 000		langer Bügel / long handle	(86)
26.430 FVLC H24	04.06-		1863 869 038			
26.430 FVLS, FVLRS H24	04.06-		3189 600 020		Getr. / GBox: ZF Ecosplit-3	
26.430 FDALS, FDAS, FDHLS, FDHS H56 H82	01.04-					
26.430 FDLS, FDLS/M, FDLRS- WW HV2 H67	02.04-					
26.430 FVL-KO H24	12.00-					
26.430 FVLS, FVLRS H24	07.05-					
26.430, 26.440 FDAK, FDALK, FDHK, FDHLK H82 HH1 H47 H56	06.05-					
26.430, 26.440 FDALS, FDAS, FDHLS, FDHS H47 HH1	06.05-					
26.430, 26.440 FDHC, FDHC/M, FDHLC HH1 H47	06.05-					
26.430, 26.440 FDH-TM H47	06.05-					
26.440 FDAC, FDALC, FDHC, FDHLC H47 HH1 H56 H82	09.05-					
26.440 FVLC H24	09.05-					
26.440 FVLS, FVLRS H24	09.05-					











TGA		03.00 -				
28.310 FNLC, FNLLC H71	09.02-		3400 700 380 ⊗ 3482 000 361 ⊗ 1878 080 037 ⊙ 3151 000 034	430 10 MFZ430 430WGTZ KZISZ-5	Getr. / GBox: ZF Ecosplit-3	
28.310 FNLC, FNLLC, FNLR H89 H85	09.02-					
28.310 FNLS, FNLR H89	06.04-		3482 000 361	430 MFZ430	Getr. / GBox: AS-Tronic	
28.310, 28.320 FNLC, FNLLC, FNLL-LE, FNLLR-LE H75 H74 H99	07.06-		1878 080 037	430 10 430WGTZ	Getr. / GBox: AS-Tronic	
28.320 FNLC, FNLLC, FNLLRC, FNLLR-LE H74 H89 H99	07.06-		3151 000 144	KZISZ-5	Getr. / GBox: AS-Tronic für Ausrückgabel mit Nocken / for release fork with cams	(70)
28.320 FNLC, FNLLC, FNLLRC, FNLLR-LE H99 H74 H89	07.06-		3400 700 381 ⊗ 3482 000 361 ⊗ 1878 080 037 ⊙ 3151 000 493	430 10 MFZ430 430WGTZ KZISZ-5	Getr. / GBox: AS-Tronic für Ausrückgabel mit Rollen / for release fork with rollers	(71)
28.320 FNLC, FNLLC, FNLR H85 H89	06.04-		3400 700 327 ⊗ 3482 114 031 ⊗ 1878 004 832 ⊙ 3151 263 031	430 10 GMFZ430N 430WGTZ KZIZ-6	Getr. / GBox: ZF 16S-151/181 für Nebenantrieb / for PTO	(82)
28.320 FNLS, FNLR H89	06.04-					
28.350 FANLC H84	07.06-		3400 700 641 HD ⊗ 3482 114 031 ⊗ 1878 007 729 ⊙ 3151 263 031	430 10 GMFZ430N 430WGTZ KZIZ-6	Getr. / GBox: ZF 16S-151/181 Nebenantriebs-ID / PTO ID: NMV 221	(50)
28.350 FANLK H84	07.06-					
28.350 FNLS, FNLR HV7 HV4 H89	02.04-		3496 006 000		langer Bügel / long handle	(86)
28.350, 28.360 FNLC, FNLLC, FNLL-LE, FNLLR-LE H85 H99 H75 H89 H74	07.06-		1863 869 038			
28.350, 28.360 FNLC, FNLLC, FNLR, FNLL-LE, FNLLR-LE H89 H74 H75 HV7 HV4 H99 H85	06.04-		3189 600 020		Getr. / GBox: ZF Ecosplit-3	
28.350, 28.360 FNLC, FNLLC, FNLR, FNLL-LE, FNLLR-LE HV7 HV4 H85 H75 H89 H74 H99	06.04-					
28.360 FANLC H81	07.06-					
28.360 FANLC H84	07.06-					
28.360 FANLK H81	07.06-					
28.360 FANLK H84	07.06-					
28.360 FNLC, FNLLC H71	09.02-					
28.360 FNLS, FNLR H89	04.06-					
28.390 FANLC H84	07.06-					
28.390 FANLK H84	07.06-					
28.390 FNLC, FNLLC H74 H75	07.06-					
28.390 FNLS, FNLR H89 HV7 HV4	05.04-					
28.390, 28.400 FNLC, FNLLC, FNLR H89 H85 H74 H75 HV7 HV4	06.04-					
28.390, 28.400 FNLC, FNLLC, FNLR HV7 H74 H89 HV4 H75 H85	06.04-					
28.400 FANLC H84	07.06-					
28.400 FANLK H74	07.06-					
28.400 FNLS, FNLR H89	04.06-					
28.410 FANLC H81	07.06-					
28.410 FANLK H81	07.06-					
28.410 FNLC, FNLLC H71	09.02-					











MAN

TGA		03.00 -				
28.430 FANLC H84	07.06-		3400 700 380 3482 000 361 1878 080 037 3151 000 034	430 10 MFZ430 430WGTZ KZISZ-5	Getr. / GBox: ZF Ecosplit-3	
28.430 FANLK H84	07.06-					
28.430 FNLS, FNLRS HV7 H89 HV4	05.04-		3482 000 361	430 MFZ430	Getr. / GBox: AS-Tronic	
28.430, 28.440 FNLC, FNLLC, FNLRC H85 H89 HV7 HV4 H75 H74	06.04-		1878 080 037	430 10 430WGTZ	Getr. / GBox: AS-Tronic	
28.430, 28.440 FNLC, FNLLC, FNLRC H74 HV7 H89 HV4 H85 H75	06.04-		3151 000 144	KZISZ-5	Getr. / GBox: AS-Tronic für Ausrückgabel mit Nocken / for release fork with cams	(70)
28.440 FANLC H84	07.06-		3400 700 381 3482 000 361 1878 080 037 3151 000 493	430 10 MFZ430 430WGTZ KZISZ-5	Getr. / GBox: AS-Tronic für Ausrückgabel mit Rollen / for release fork with rollers	(71)
28.440 FANLK H84	07.06-		3400 700 327 3482 114 031 1878 004 832 3151 263 031	430 10 GMFZ430N 430WGTZ KZIZ-6	Getr. / GBox: ZF 16S-151/181 für Nebenantrieb / for PTO	(82)
28.440 FNLS, FNLRS H89	09.05-					
32.350, 32.360 FFDC, FFDLC, FFDLRC, FFDRC HV8 H49	05.04-		3400 700 641 HD 3482 114 031 1878 007 729 3151 263 031	430 10 GMFZ430N 430WGTZ KZIZ-6	Getr. / GBox: ZF 16S-151/181 Nebenantriebs-ID / PTO ID: NMV 221	(50)
32.350, 32.360 FFD-TM, FFDRC- TM H49	02.04-		3496 006 000		langer Bügel / long handle	(86)
32.390, 32.400 FFDRC H49 HV8	05.04-		1863 869 038			
32.390, 32.400 FFD-TM, FFDRC- TM H49	05.04-		3189 600 020		Getr. / GBox: ZF Ecosplit-3	
32.430, 32.440 FFDRC H49	05.04-					
32.430, 32.440 FFD-TM, FFDRC- TM H49	05.04-					
33.350 FDC-TM, FDCRC-TM HW2	09.07-					
33.350, 33.360 FDAC, FDARC, FDHC H47 H56 HW4	06.05-					
33.350, 33.360 FDAK, FDARK, FDHK H56 H47 HW4	06.05-					
33.350, 33.360 FDARS, FDAS, FDHS HW4 H47 H56	06.05-					
33.360 FDC-TM, FDCRC-TM, FDR-TM, FD-TM HW2	09.07-					
33.390, 33.400 FDAC, FDHC HW4 H56 H47	06.05-					
33.390, 33.400 FDAK, FDARK, FDHK H47 H56 HW4	06.05-					
33.390, 33.400 FDARS, FDAS, FDHS H47 HW4 H56	06.05-					
33.390, 33.400 FDC-TM, FDCRC- TM HW2	09.07-					
33.430, 33.440 FDAC, FDALC, FDHC H56 H82 HW4 H47	06.05-					
33.430, 33.440 FDAK, FDALK, FDARK, FDHK HW4 H56 H82 H47	06.05-					
33.430, 33.440 FDALS, FDARS, FDAS, FDHS HW4 H47 H56 H82	06.05-					
35.310, 35.320 FFDC, FFDLC H37 H41	02.04-					
35.310, 35.320 FFDK, FFDLK H37 H41	02.04-					
35.310, 35.320 FFD-TM H37	02.04-					













TGA		03.00 -					
35.350 FFDHK, FFDHLK H59 H50	07.06-		3400 700 380 ⊗ 3482 000 361 ⊗ 1878 080 037 ⊙ 3151 000 034	430 10 MFZ430 430WGTZ KZISZ-5	Getr. / GBox: ZF Ecosplit-3		
35.350 FFDH-TM H50	07.06-						
35.350 FFNLC H90	07.06-		3482 000 361	430 MFZ430	Getr. / GBox: AS-Tronic		
35.350, 35.360 FFDC, FFDRC, FFDLC HH4 H37 H41	02.04-		1878 080 037	430 10 430WGTZ	Getr. / GBox: AS-Tronic		
35.350, 35.360 FFDK, FFDK, FFDLK H41 H37	02.04-		3151 000 144	KZISZ-5	Getr. / GBox: AS-Tronic für Ausrückgabel mit Nocken / for release fork with cams	(70)	
35.350, 35.360 FFD-TM H37	02.04-		3400 700 381 ⊗ 3482 000 361 ⊗ 1878 080 037 ⊙ 3151 000 493	430 10 MFZ430 430WGTZ KZISZ-5	Getr. / GBox: AS-Tronic für Ausrückgabel mit Rollen / for release fork with rollers	(71)	
35.360 FFDK, FFDHK, FFDHLK H50 H59	07.06-		3400 700 327 ⊗ 3482 114 031 ⊗ 1878 004 832 ⊙ 3151 263 031	430 10 GMFZ430N 430WGTZ KZIZ-6	Getr. / GBox: ZF 16S-151/181 für Nebenantrieb / for PTO	(82)	
35.360 FFDH-TM H50	07.06-						
35.360 FFNHLC H88	07.06-		3400 700 641 HD ⊗ 3482 114 031 ⊗ 1878 007 729 ⊙ 3151 263 031	430 10 GMFZ430N 430WGTZ KZIZ-6	Getr. / GBox: ZF 16S-151/181 Nebenantriebs-ID / PTO ID: NMV 221	(50)	
35.360 FFNLC H90	07.06-		3496 006 000		langer Bügel / long handle	(86)	
35.390 FDNLC H92	07.06-		1863 869 038				
35.390 FFDK H96 HV6	02.04-		3189 600 020		Getr. / GBox: ZF Ecosplit-3		
35.390 FFDK, FFDHK, FFDHLK H93 H50 H59	07.06-						
35.390 FFDH-TM H50	07.06-						
35.390 FFNLC H90	07.06-						
35.390, 35.400 FFDC, FFDRC, FFDLC H37 HW3 H41	02.04-						
35.390, 35.400 FFDK, FFDK, FFDLK H37 H41	02.04-						
35.390, 35.400 FFD-TM H37	02.04-						
35.400 FDNLC H92	07.06-						
35.400 FFDK H96	02.04-						
35.400 FFDK, FFDHK, FFDHLK H59 H93 H50	07.06-						
35.400 FFDH-TM H50	07.06-						
35.400 FFNHLC HH4	11.06-						
35.400 FFNLC H90	07.06-						
35.410 FDNLC H91	07.06-						
35.410 FFDK H73	07.06-						
35.410 FFDK H76	07.06-						
35.410 FFNLC H88	07.06-						
35.430 FDNLC H92	07.06-						
35.430 FFDK, FFDHK, FFDHLK H59 H93 H50	07.06-						
35.430 FFDK, FFDHK, FFDHLK H96 HV6	07.06-						











MAN

TGA		03.00 -				
35.430 FFDH-TM H50	07.06-		3400 700 380 ⊗ 3482 000 361 ⊗ 1878 080 037 ⊙ 3151 000 034	430 10 MFZ430 430WGTZ KZISZ-5	Getr. / GBox: ZF Ecosplit-3	
35.430 FFNLC H90	07.06-					
35.430, 35.440 FFDC, FFDRC, FFDLC	02.04-		3482 000 361	430 MFZ430	Getr. / GBox: AS-Tronic	
H37 H41			1878 080 037	430 10 430WGTZ	Getr. / GBox: AS-Tronic	
35.430, 35.440 FFDK, FFDRC, FFDLK	02.04-		3151 000 144	KZISZ-5	Getr. / GBox: AS-Tronic für Ausrückgabel mit Nocken / for release fork with cams	(70)
H41 H37						
35.430, 35.440 FFD-TM H37	02.04-		3400 700 381 ⊗ 3482 000 361 ⊗ 1878 080 037 ⊙ 3151 000 493	430 10 MFZ430 430WGTZ KZISZ-5	Getr. / GBox: AS-Tronic für Ausrückgabel mit Rollen / for release fork with rollers	(71)
35.440 FDNLC H92	07.06-					
35.440 FFDK, FFDHK, FFDHLK	07.06-		3400 700 327 ⊗ 3482 114 031 ⊗ 1878 004 832 ⊙ 3151 263 031	430 10 GMFZ430N 430WGTZ KZISZ-6	Getr. / GBox: ZF 16S-151/181 für Nebenantrieb / for PTO	(82)
H50 H59 H96						
35.440 FFDH-TM H50	07.06-		3400 700 641 HD ⊗ 3482 114 031 ⊗ 1878 007 729 ⊙ 3151 263 031	430 10 GMFZ430N 430WGTZ KZISZ-6	Getr. / GBox: ZF 16S-151/181 Nebenantriebs-ID / PTO ID: NMV 221	(50)
35.440 FFNHLK HH4	11.06-					
35.440 FFNLC H90	07.06-					
37.310 FFDC H38	12.04-		3496 006 000		langer Bügel / long handle	(86)
37.310 FFDK H38	12.04-		1863 869 038			
37.310 FFD-TM H38	12.04-		3189 600 020		Getr. / GBox: ZF Ecosplit-3	
37.310, 37.320 FFDC H39	12.04-					
37.310, 37.320 FFDK H39	12.04-					
37.310, 37.320 FFD-TM H39	12.04-					
37.350, 37.360 FFDC H39	12.04-					
37.350, 37.360 FFDK H39	12.04-					
37.350, 37.360 FFD-TM H39	12.04-					
37.360 FFDC H38	12.04-					
37.360 FFDK H38	12.04-					
37.360 FFD-TM H38	12.04-					
37.390, 37.400 FFDC H39	12.04-					
37.390, 37.400 FFDK H39	12.04-					
37.390, 37.400 FFD-TM H39	12.04-					
37.410 FFDC H38	12.04-					
37.410 FFDK H38	12.04-					
37.410 FFD-TM H38	12.04-					
37.430, 37.440 FFDC H39	12.04-					
37.430, 37.440 FFDK H39	12.04-					
37.430, 37.440 FFD-TM H39	12.04-					
39.390 FVNLC H69	07.06-					
39.400 FVNLC H69	07.06-					
39.430 FVNLC H69	07.06-					
39.440 FVNLC H69	07.06-					

TGA	03.00 -					
40.390, 40.400 FDAK, FDARK H58	06.05-		 3400 700 380 ⊗ 3482 000 361 ⊗ 1878 080 037 ⊙ 3151 000 034	430 10 MFZ430 430WGTZ KZISZ-5	Getr. / GBox: ZF Ecosplit-3	
40.390, 40.400 FDARS, FDAS H58	06.05-					
40.390, 40.400 FDK, FDRK H11 H34	06.05-		 3482 000 361	430 MFZ430	Getr. / GBox: AS-Tronic	
40.390, 40.400 FDRS, FDS H34	06.05-		 1878 080 037	430 10 430WGTZ	Getr. / GBox: AS-Tronic	
40.410 FDAK H57	04.04-		 3151 000 144	KZISZ-5	Getr. / GBox: AS-Tronic für Ausrückgabel mit Nocken / for release fork with cams	(70)
40.410 FDAS H57	04.04-					
40.410 FDK H68 H33	04.04-		 3400 700 381 ⊗ 3482 000 361 ⊗ 1878 080 037 ⊙ 3151 000 493	430 10 MFZ430 430WGTZ KZISZ-5	Getr. / GBox: AS-Tronic für Ausrückgabel mit Rollen / for release fork with rollers	(71)
40.410 FDS H33	04.04-					
40.430 FDK, FDRK H34	06.05-		 3400 700 327 ⊗ 3482 114 031 ⊗ 1878 004 832 ⊙ 3151 263 031	430 10 GMFZ430N 430WGTZ KZIZ-6	Getr. / GBox: ZF 16S-151/181 für Nebenantrieb / for PTO	(82)
40.430 FDRS, FDS H34	06.05-					
40.430, 40.440 FDAK, FDARK H58	06.05-		 3400 700 641 HD ⊗ 3482 114 031 ⊗ 1878 007 729 ⊙ 3151 263 031	430 10 GMFZ430N 430WGTZ KZIZ-6	Getr. / GBox: ZF 16S-151/181 Nebenantriebs-ID / PTO ID: NMV 221	(50)
40.430, 40.440 FDARS, FDAS H58	06.05-		 3496 006 000		langer Bügel / long handle	(86)
40.480 FDRS, FDS H34 H33	06.05-		 1863 869 038			
41.350 FFDC-TM, FFDRC-TM HW3	09.07-		 3189 600 020		Getr. / GBox: ZF Ecosplit-3	
41.350, 41.360 FFD, FFDC, FFDRC HW6 HW3 H39	12.04-					
41.350, 41.360 FFDC-TM, FFDRC-TM, FFD-TM H39 HW6	12.04-					
41.350, 41.360 FFDK, FFDRK HW6 HW3 H39	12.04-					
41.360 FFD HW6	12.08-					
41.360 FFDC-TM, FDRC-TM HW3	09.07-					
41.360 FFDC-TM, FFDRC-TM, FFD-TM H38	12.04-					
41.360 FFDK, FFDRK H46 H38	09.03-					
41.390 FFDAK HV6	12.04-					
41.390 FFDC-TM, FDRC-TM HW3	09.07-					
41.390, 41.400 FFD, FFDC, FFDRC H39 HW3	12.04-					
41.390, 41.400 FFDC-TM, FFDRC-TM, FFD-TM H39 HW6	12.04-					
41.390, 41.400 FFDK, FFDRK H39 HW6 HW3	12.04-					
41.400 FFD HW6	12.08-					
41.400 FFDC-TM, FDRC-TM HW3	09.07-					
41.410 FFDAK H73	07.06-					
41.410 FFDAK H76	07.06-					
41.410 FFDC, FFDRC, FDRC H46 H38	09.03-					
41.410 FFDC-TM, FFDRC-TM, FFD-TM H38	12.04-					
41.410 FFDK, FFDRK H46 H38	09.03-					

MAN

TGA		03.00 -				
41.430 FFDK HV6 H96	12.04-		 3400 700 380 ⊗ 3482 000 361 ⊗ 1878 080 037 ⊙ 3151 000 034	430 10 MFZ430 430WGTZ KZISZ-5	Getr. / GBox: ZF Ecosplit-3	
41.430 FFDK H93	07.06-					
41.430 FFDC-TM, FFDC HW3	09.07-		 3482 000 361	430 MFZ430	Getr. / GBox: AS-Tronic	
41.430, 41.440 FFD, FFDC, FFDC	12.04-		 1878 080 037	430 10 430WGTZ	Getr. / GBox: AS-Tronic	
41.430, 41.440 FFDC-TM, FFDC-TM, FFD-TM H39	12.04-		 3151 000 144	KZISZ-5	Getr. / GBox: AS-Tronic für Ausrückgabel mit Nocken / for release fork with cams	(70)
41.430, 41.440 FFDK, FFDK HW3 H39	12.04-		 3400 700 381 ⊗ 3482 000 361 ⊗ 1878 080 037 ⊙ 3151 000 493	430 10 MFZ430 430WGTZ KZISZ-5	Getr. / GBox: AS-Tronic für Ausrückgabel mit Rollen / for release fork with rollers	(71)
41.440 FFDK H93	07.06-		 3400 700 327 ⊗ 3482 114 031 ⊗ 1878 004 832 ⊙ 3151 263 031	430 10 GMFZ430N 430WGTZ KZISZ-6	Getr. / GBox: ZF 16S-151/181 für Nebenantrieb / for PTO	(82)
41.440 FFDK H96	07.06-		 3400 700 641 HD ⊗ 3482 114 031 ⊗ 1878 007 729 ⊙ 3151 263 031	430 10 GMFZ430N 430WGTZ KZISZ-6	Getr. / GBox: ZF 16S-151/181 Nebenantriebs-ID / PTO ID: NMV 221	(50)
			 3496 006 000		langer Bügel / long handle	(86)
			 1863 869 038			
			 3189 600 020		Getr. / GBox: ZF Ecosplit-3	
18.380 FLRC H07	05.04-	Cummins	 3400 700 380 ⊗ 3482 000 361 ⊗ 1878 080 037 ⊙ 3151 000 034	430 10 MFZ430 430WGTZ KZISZ-5	Getr. / GBox: ZF Ecosplit-3	
18.380 FLRS H07	05.04-					
18.420 FLRC H07	05.04-		 3189 600 020		Getr. / GBox: ZF Ecosplit-3	
18.420 FLRS H07	05.04-					
24.380 FPLS, FPLRS H32	02.04-					
24.420 FPLS, FPLRS H32	05.04-					
26.380 FNLLRC, FNLR H27 H31	05.04-					
26.380 FPLS, FPLRS H32	02.04-					
26.420 FNLLRC, FNLR H31 H27	04.00-					
26.420 FPLS, FPLRS H32	02.04-					

TGA	03.00 -						
18.430, 18.440 FAC, FARC, FHLC H22 H52 HV5	05.04-	D2676LF04, D2866LF27, D2866LF26, D2866LF28,		3400 700 402 ⊗ 3482 000 246 ⊗ 1878 002 139 ⊙ 3151 000 034	430 10 MFZ430 430WGTZ KZISZ-5	Getr. / GBox: ZF Ecosplit-3	
18.430, 18.440 FAK, FALK, FALK-L, FHLK, FHLK/M H52 H22 HV5 H80	05.04-	D2676LF13, D2876LF07, D2676LF14, D2066LF11, D2066LF31, D2066LF25, D2676LF05, D2066LF01, D2066LF36,		3400 700 460 HD ⊗ 3482 000 246 ⊗ 1878 004 104 ⊙ 3151 000 034	430 10 MFZ430 430WGTZ KZISZ-5	Getr. / GBox: ZF Ecosplit-3	
18.430, 18.440 FALS, FAS, FHLS H52 H22 HV5 H80	05.04-	D2676LF12, D2676LF01, D2676LF02, D2676LF12,		3400 700 404 ⊗ 3482 000 246 ⊗ 1878 002 139 ⊙ 3151 000 144	430 10 MFZ430 430WGTZ KZISZ-5	Getr. / GBox: AS-Tronic für Ausrückgabel mit Nocken / for release fork with cams	(70)
18.430, 18.440 FC, FLC, FLLC, FLLRC, FLLRW, FLLW, FLRC H06 H03 H15 H10	05.04-	D2676LF01, D2676LF36, D2876LF12, D2676LF01, D2676LF02, D2676LF12,		3400 700 445 ⊗ 3482 000 246 ⊗ 1878 002 139 ⊙ 3151 000 493	430 10 MFZ430 430WGTZ KZISZ-5	Getr. / GBox: AS-Tronic für Ausrückgabel mit Rollen / for release fork with rollers	(71)
18.460 FAK H03 H06	12.00-	D2676LF11, D2876LF25, D2876LF13, D2676LF03, D2876LF04		3400 700 459 HD ⊗ 3482 000 246 ⊗ 1878 004 104 ⊙ 3151 000 493	430 10 MFZ430 430WGTZ KZISZ-5	Getr. / GBox: AS-Tronic für Ausrückgabel mit Rollen / for release fork with rollers	(71)
18.480 FAC, FARC H52	02.06-			3400 700 327 ⊗ 3482 114 031 ⊗ 1878 004 832 ⊙ 3151 263 031	430 10 GMFZ430N 430WGTZ KZIZ-6	Getr. / GBox: ZF 16S-151/181 für Nebenantrieb / for PTO	(82)
18.480 FAK, FAK-L, FALK, FALK-L, FHLK H52 H80 H22	02.06-			3400 700 641 HD ⊗ 3482 114 031 ⊗ 1878 007 729 ⊙ 3151 263 031	430 10 GMFZ430N 430WGTZ KZIZ-6	Getr. / GBox: ZF 16S-151/181 Nebenantriebs-ID / PTO ID: NMV 221	(50)
18.480 FALS, FARS, FAS, FHLS H22 H52 H80	02.06-			3496 006 000		langer Bügel / long handle	(86)
18.480 FC, FLC, FLLC, FLLRC, FLLRW, FLLW, FLRC H15 H06 H10 H03	01.06-			1863 869 038			
18.480 FHLK, FHLK/M H22	04.06-			3189 600 004		Getr. / GBox: ZF AS Tronic Rollenausführung / roller version	(58)
18.480 FHLK, FHLK/M H22	04.06-			3189 600 020		Getr. / GBox: ZF Ecosplit-3	
18.480 FALS, FALS H22	04.06-						
18.480 FK, FK-L, FLK, FLRK H03 H06	01.06-						
18.480 FLLRS, FLLS, FLRS, FLS, FLS-TS H08 H13 H06 H10	01.06-						
18.530 FAC, FARC H51	04.04-						
18.530 FAK, FAK-L, FALK, FALK-L H51 H70	04.04-						
18.530 FAS, FALS H51 H70	04.04-						
18.540 FLC, FLLC, FLLRC, FLLW, FLRC H06 H15 H10	08.06-						
18.540 FLLRS, FLLS, FLRS, FLS H13 H06 H10	08.06-						
19.440 FLRS, FLS, FRS, FS HW1 HW5 H64 HW7	02.06-						
19.460 FRS, FS H43 H60	05.04-						
19.480 FLRS, FLS, FRS, FS HW1 HW5 HW7 H64	02.06-						
19.480 FRS, FS H60 H43	05.04-						
19.480 FS/M, FRS/M-WW HW1 H64	02.06-						
24.480 FNLLC, FNLLRC, FNLLRW, FNLLW H45	01.06-						
24.480 FPLS, FPLRS H23	07.05-						
24.480 FPLS, FPLRS H24	01.06-						
24.530 FPLS, FPLRS H23	07.05-						
24.540 FNLLC, FNLLW H45	01.06-						



CODE













Parameter





















MAN

TGA		03.00 -				
26.440 FDC, FDLG, FDLRC, FDRG, FNHLC H67	02.06-	D2676LF04, D2866LF27, D2866LF26, D2866LF28,	3400 700 402 3482 000 246 1878 002 139 3151 000 034	430 10 MFZ430 430WGTZ KZISZ-5	Getr. / GBox: ZF Ecosplit-3	
26.440 FDLRS, FDLS, FDRS, FDS, FNHLS, FPHLS, FVHLS H67	02.06-	D2676LF13, D2876LF07, D2676LF14, D2066LF11, D2066LF31,	3400 700 460 HD 3482 000 246 1878 004 104 3151 000 034	430 10 MFZ430 430WGTZ KZISZ-5	Getr. / GBox: ZF Ecosplit-3	
26.480 FDAC, FDALC, FDARC, FDHC, FDHLC H82 H47 HH1 H56	02.06-	D2066LF25, D2676LF05, D2066LF01,	3400 700 404 3482 000 246 1878 002 139 3151 000 144	430 10 MFZ430 430WGTZ KZISZ-5	Getr. / GBox: AS-Tronic für Ausrückgabel mit Nocken / for release fork with cams	(70)
26.480 FDAK, FDALK H82 H56	02.06-	D2066LF36, D2876LF12, D2676LF01,	3400 700 445 3482 000 246 1878 002 139 3151 000 493	430 10 MFZ430 430WGTZ KZISZ-5	Getr. / GBox: AS-Tronic für Ausrückgabel mit Rollen / for release fork with rollers	(71)
26.480 FDAK, FDALK, FDHK, FDHLK HH1 H56 H47 H82	02.06-	D2676LF02, D2676LF12, D2676LF11, D2876LF25, D2876LF13,	3400 700 459 HD 3482 000 246 1878 004 104 3151 000 493	430 10 MFZ430 430WGTZ KZISZ-5	Getr. / GBox: AS-Tronic für Ausrückgabel mit Rollen / for release fork with rollers	(71)
26.480 FDALS, FDARS, FDAS, FDHLS, FDHS H82 H56	02.06-	D2676LF03, D2876LF04	3400 700 327 3482 114 031 1878 004 832 3151 263 031	430 10 GMFZ430N 430WGTZ KZIZ-6	Getr. / GBox: ZF 16S-151/181 für Nebenantrieb / for PTO	(82)
26.480 FDHC, FDHC/M, FDHLC H47 HH1	02.06-		3400 700 641 HD 3482 114 031 1878 007 729 3151 263 031	430 10 GMFZ430N 430WGTZ KZIZ-6	Getr. / GBox: ZF 16S-151/181 Nebenantriebs-ID / PTO ID: NMV 221	(50)
26.480 FDH-TM H47	02.06-		3496 006 000		langer Bügel / long handle	(86)
26.480 FNLG, FNLLG, FNLLRC, FNLLW, FNLRC, FVLC H21 H24 HV1 H18	02.06-		1863 869 038			
26.480 FVL-KO H24	01.06-		3189 600 004		Getr. / GBox: ZF AS Tronic Rollenausführung / roller version	(58)
26.530 FDAC, FDALC H72 H55	07.06-		3189 600 020		Getr. / GBox: ZF Ecosplit-3	
26.530 FDAK, FDALK H55 H72	09.02-					
26.530 FDAS, FDALS H72 H55	07.06-					
26.540 FNLG, FNLLG, FNLLRC, FNLLW, FNLRC H18 H21	08.06-					
26.540 FNLG, FNLLG, FNLLRC, FNLLW, FNLRC H21 H18	08.06-					
27.440 FDS, FDLS, FDRS, FDLRS	10.08-					
28.390 FNLLC H81	07.06-					
28.480 FANLC H84	07.06-					
28.480 FANLC H81	07.06-					
28.480 FANLK H81	07.06-					
28.480 FANLK H84	07.06-					
28.480 FNLG, FNLRC, FNLLC H89 H85 HV7 HV4	02.06-					
28.480 FNLS, FNLRS H89 HV7 HV4	02.06-					
28.530 FANLC H81	07.06-					
28.530 FANLK H81	07.06-					
28.540 FNLG, FNLLC H89 H85	08.06-					
28.540 FNLS H89	08.06-					
32.480 FFDRC H49	02.06-					
32.480 FFD-TM, FFDR-TM H49	02.06-					
33.440 FDAC, FDALC, FDHC HW4	06.05-					

TGA	03.00 -					
33.440 FDAK, FDALK, FDARK, FDHK HW4	06.05-	D2676LF04, D2866LF27, D2866LF26, D2866LF28,	 3400 700 402 ⊗ 3482 000 246 ⊗ 1878 002 139 ⊙ 3151 000 034	430 10 MFZ430 430WGTZ KZISZ-5	Getr. / GBox: ZF Ecosplit-3	
33.440 FDALS, FDARS, FDAS, FDHS HW4	06.05-	D2676LF13, D2876LF07, D2676LF14, D2066LF11, D2066LF31,	 3400 700 460 HD ⊗ 3482 000 246 ⊗ 1878 004 104 ⊙ 3151 000 034	430 10 MFZ430 430WGTZ KZISZ-5	Getr. / GBox: ZF Ecosplit-3	
33.440 FDC, FDLK, FDRK HW2 H66	06.05-	D2066LF25, D2676LF05, D2066LF01, D2066LF36,	 3400 700 404 ⊗ 3482 000 246 ⊗ 1878 002 139 ⊙ 3151 000 144	430 10 MFZ430 430WGTZ KZISZ-5	Getr. / GBox: AS-Tronic für Ausrückgabel mit Nocken / for release fork with cams	(70)
33.440 FDC-TM, FDRK-TM HW2	09.07-	D2676LF12, D2676LF01, D2676LF02, D2676LF12,	 3400 700 445 ⊗ 3482 000 246 ⊗ 1878 002 139 ⊙ 3151 000 493	430 10 MFZ430 430WGTZ KZISZ-5	Getr. / GBox: AS-Tronic für Ausrückgabel mit Rollen / for release fork with rollers	(71)
33.440 FDK, FDLK, FDRK HW2 H66	06.05-	D2676LF11, D2876LF11, D2876LF25, D2876LF13, D2676LF03, D2876LF04	 3400 700 459 HD ⊗ 3482 000 246 ⊗ 1878 004 104 ⊙ 3151 000 493	430 10 MFZ430 430WGTZ KZISZ-5	Getr. / GBox: AS-Tronic für Ausrückgabel mit Rollen / for release fork with rollers	(71)
33.440 FDLS, FDRS, FDS H66 HW8 HW9 HW2	06.05-		 3400 700 327 ⊗ 3482 114 031 ⊗ 1878 004 832 ⊙ 3151 263 031	430 10 GMFZ430N 430WGTZ KZIZ-6	Getr. / GBox: ZF 16S-151/181 für Nebenantrieb / for PTO	(82)
33.460 FDAC H54	09.02-		 3400 700 641 HD ⊗ 3482 114 031 ⊗ 1878 007 729 ⊙ 3151 263 031	430 10 GMFZ430N 430WGTZ KZIZ-6	Getr. / GBox: ZF 16S-151/181 Nebenantriebs-ID / PTO ID: NMV 221	(50)
33.460 FDAK H54	09.02-		 3496 006 000		langer Bügel / long handle	(86)
33.460 FDAS H54	09.02-		 1863 869 038			
33.480 FDAC, FDALC, FDARC, FDHC HW4 H56 H82 H47	02.06-		 3189 600 004		Getr. / GBox: ZF AS Tronic Rollenausführung / roller version	(58)
33.480 FDAK, FDALK, FDARK, FDHK H82 H56 HW4 H47	02.06-		3189 600 020		Getr. / GBox: ZF Ecosplit-3	
33.480 FDALS, FDARS, FDAS, FDHS H56 HW4 H82 H47	02.06-					
33.480 FDC-TM, FDRK-TM, FDTM HW2	09.07-					
33.530 FDAC, FDALC H55 H72	09.02-					
35.310 FFDC, FFDLC H40 H36	06.03-					
35.310 FFDK, FFDLK H36 H40	06.03-					
35.310 FFD-TM H36	11.03-					
35.360 FFDC, FFDLC, FFDRC H40 H36	10.03-					
35.360 FFDK, FFDLK, FFDRC H36 H40	10.03-					
35.360 FFD-TM H36	11.03-					
35.410 FFDC, FFDLC H40 H36	10.03-					
35.410 FFDK, FFDLK H40 H36	10.03-					
35.410 FFD-TM H36	11.03-					
35.460 FFDC, FFDLC H40 H36	10.03-					
35.460 FFDK, FFDLK H36 H40	10.03-					
35.460 FFD-TM H36	11.03-					
35.460 FFNLC H88	07.06-					
35.480 FDNLC H91	07.06-					
35.480 FDNLC H92	07.06-					
35.480 FDDAK H76	07.06-					
35.480 FDDAK HV6 H96	07.06-					
35.480 FDDAK, FDDHK, FDDHLK H73	07.06-					

































MAN

TGA		03.00 -				
35.480 FFD AK, FFDHK, FFDHLK H59 H50 H93	07.06-	D2676LF04, D2866LF27, D2866LF26, D2866LF28,	 3400 700 402 ⊗ 3482 000 246 ⊗ 1878 002 139 ⊙ 3151 000 034	430 10 MFZ430 430WGTZ KZISZ-5	Getr. / GBox: ZF Ecosplit-3	
35.480 FFD ARS H76	07.06-	D2676LF13, D2876LF07,	 3400 700 460 HD ⊗ 3482 000 246 ⊗ 1878 004 104 ⊙ 3151 000 034	430 10 MFZ430 430WGTZ KZISZ-5	Getr. / GBox: ZF Ecosplit-3	
35.480 FFD C, FFDLC H40 H36	10.03-	D2676LF14, D2066LF11,				
35.480 FFD C, FFDLC H41 H37	02.04-	D2066LF31, D2066LF25,	 3400 700 404 ⊗ 3482 000 246 ⊗ 1878 002 139 ⊙ 3151 000 144	430 10 MFZ430 430WGTZ KZISZ-5	Getr. / GBox: AS-Tronic für Ausrückgabel mit Nocken / for release fork with cams	(70)
35.480 FFD H-TM H50	07.06-	D2676LF05, D2066LF01,				
35.480 FFD K, FFDLK H40 H36	10.03-	D2066LF36, D2876LF12,	 3400 700 445 ⊗ 3482 000 246 ⊗ 1878 002 139 ⊙ 3151 000 493	430 10 MFZ430 430WGTZ KZISZ-5	Getr. / GBox: AS-Tronic für Ausrückgabel mit Rollen / for release fork with rollers	(71)
35.480 FFD K, FFDLK H41 H37	02.04-	D2676LF02, D2676LF12,				
35.480 FFD -TM H36	11.03-	D2676LF11, D2876LF25,	 3400 700 459 HD ⊗ 3482 000 246 ⊗ 1878 004 104 ⊙ 3151 000 493	430 10 MFZ430 430WGTZ KZISZ-5	Getr. / GBox: AS-Tronic für Ausrückgabel mit Rollen / for release fork with rollers	(71)
35.480 FFD -TM H37	02.04-	D2876LF13, D2676LF03,				
35.480 FFN HLC HH4	11.06-	D2876LF04	 3400 700 327 ⊗ 3482 114 031 ⊗ 1878 004 832 ⊙ 3151 263 031	430 10 GMFZ430N 430WGTZ KZIZ-6	Getr. / GBox: ZF 16S-151/181 für Nebenantrieb / for PTO	(82)
35.480 FFN LC H90	07.06-					
35.480 FFN LC H88	07.06-		 3400 700 641 HD ⊗ 3482 114 031 ⊗ 1878 007 729 ⊙ 3151 263 031	430 10 GMFZ430N 430WGTZ KZIZ-6	Getr. / GBox: ZF 16S-151/181 Nebenantriebs-ID / PTO ID: NMV 221	(50)
35.530 FDN LC H91	04.04-					
35.530 FFD AK H73	07.06-		 3496 006 000		langer Bügel / long handle	(86)
35.530 FFD AK H76	07.06-		 1863 869 038			
35.530 FFD C, FFDLC H40 H36	04.04-		 3189 600 004		Getr. / GBox: ZF AS Tronic Rollenausführung / roller version	(58)
35.530 FFD K, FFDLK H36 H40	04.04-		3189 600 020		Getr. / GBox: ZF Ecosplit-3	
35.530 FFD -TM H36	04.04-					
35.530 FFN LC H88	07.06-					
37.460 FFD C H38	12.04-					
37.460 FFD K H38	12.04-					
37.460 FFD -TM H38	12.04-					
37.480 FFD C H38	12.04-					
37.480 FFD C H39	02.06-					
37.480 FFD K H38	12.04-					
37.480 FFD K H39	02.06-					
37.480 FFD -TM H38	12.04-					
37.480 FFD -TM H39	02.06-					
37.530 FFD C H38	12.04-					
37.530 FFD K H38	12.04-					
37.530 FFD -TM H38	12.04-					
37.530 FVDS , FVDLS	07.06-					
39.480 FVN LC H69	07.06-					
40.440 FDA K, FDARK H58	06.05-					
40.440 FDA RS, FDAS H58	06.05-					
40.440 FDK , FDRK H34 H11	06.05-					

TGA		03.00 -					
40.440 FDRS, FDS H34	06.05-	D2676LF04, D2866LF27,		3400 700 402 ⊗ 3482 000 246 ⊗ 1878 002 139 ⊙ 3151 000 034	430 10 MFZ430 430WGTZ KZISZ-5	Getr. / GBox: ZF Ecosplit-3	
40.460 FDAK H57	04.04-	D2866LF26, D2866LF28,					
40.460 FDAS H57	04.04-	D2676LF13, D2876LF07,		3400 700 460 HD ⊗ 3482 000 246 ⊗ 1878 004 104 ⊙ 3151 000 034	430 10 MFZ430 430WGTZ KZISZ-5	Getr. / GBox: ZF Ecosplit-3	
40.460 FDK H33	04.04-	D2676LF14, D2066LF11, D2066LF31,					
40.460 FDS H33	04.04-	D2066LF25, D2676LF05,		3400 700 404 ⊗ 3482 000 246 ⊗ 1878 002 139 ⊙ 3151 000 144	430 10 MFZ430 430WGTZ KZISZ-5	Getr. / GBox: AS-Tronic für Ausrückgabel mit Nocken / for release fork with cams	(70)
40.480 FDAK, FDARK H57	04.04-	D2066LF01, D2066LF36,					
40.480 FDAK, FDARK H58	06.05-	D2876LF12, D2676LF01,		3400 700 445 ⊗ 3482 000 246 ⊗ 1878 002 139 ⊙ 3151 000 493	430 10 MFZ430 430WGTZ KZISZ-5	Getr. / GBox: AS-Tronic für Ausrückgabel mit Rollen / for release fork with rollers	(71)
40.480 FDARS, FDAS H58 H57	04.04-	D2676LF02, D2676LF12,					
40.480 FDK, FDRK H33	04.04-	D2676LF11, D2876LF25,		3400 700 459 HD ⊗ 3482 000 246 ⊗ 1878 004 104 ⊙ 3151 000 493	430 10 MFZ430 430WGTZ KZISZ-5	Getr. / GBox: AS-Tronic für Ausrückgabel mit Rollen / for release fork with rollers	(71)
40.480 FDK, FDRK H34 H11	06.05-	D2876LF13, D2676LF03, D2876LF04					
40.480 FDRS, FDAS H58	06.05-			3400 700 327 ⊗ 3482 114 031 ⊗ 1878 004 832 ⊙ 3151 263 031	430 10 GMFZ430N 430WGTZ KZIZ-6	Getr. / GBox: ZF 16S-151/181 für Nebenantrieb / for PTO	(82)
40.480 FDRS, FDS H33	04.04-						
41.440 FFD, FFDC, FFDRK HW3 HW6	12.04-			3400 700 641 HD ⊗ 3482 114 031 ⊗ 1878 007 729 ⊙ 3151 263 031	430 10 GMFZ430N 430WGTZ KZIZ-6	Getr. / GBox: ZF 16S-151/181 Nebenantriebs-ID / PTO ID: NMV 221	(50)
41.440 FFD/M HW6	12.04-						
41.440 FFDC-TM, FFDRK-TM, FFD-TM HW3	09.07-			3496 006 000		langer Bügel / long handle	(86)
41.440 FFDK, FFDRK HW3 HW6	12.04-			1863 869 038			
41.460 FFDC, FFDRK H46 H38	09.03-						
41.460 FFDC-TM, FFDRK-TM, FFD-TM H38	12.04-						
41.460 FFDK, FFDRK H38 H46	09.03-						
41.480 FFD, FFDC, FFDRK H46 H38	06.05-						
41.480 FFD, FFDC, FFDRK HW3 HW6 H39	02.06-						
41.480 FFDAK H73	07.06-						
41.480 FFDAK H93	07.06-						
41.480 FFDAK H96 HV6	07.06-						
41.480 FFDAK, FFDRK H76	07.06-						
41.480 FFDAR H76	07.06-						
41.480 FFDC-TM, FFDRK-TM HW3	09.07-						
41.480 FFDC-TM, FFDRK-TM, FFD-TM H38	12.04-						
41.480 FFDC-TM, FFDRK-TM, FFD-TM H39 HW6	02.06-						
41.480 FFDK HW6	12.08-						
41.480 FFDK, FFDRK H38 H46	06.05-						
41.480 FFDK, FFDRK H39 HW6 HW3	02.06-						
41.480 FVDS, FVDLS H94	07.06-						
41.530 FFDAK H76	07.06-						



































		CODE				
--	--	------	--	---	---	---

MAN

TGA		03.00 -				
41.530 FFDK H73 41.530 FFDK H76 41.530 FFDC H38 41.530 FFDC-TM, FFDRK-TM, FFD-TM H38 41.530 FFDK, FFDRK H38 41.540 FVDS, FVDLS H94	07.06-	D2676LF04, D2866LF27, D2866LF26, D2866LF28,	 3400 700 402  3482 000 246  1878 002 139  3151 000 034	430 10 MFZ430 430WGTZ KZISZ-5	Getr. / GBox: ZF Ecosplit-3	
	07.06-	D2676LF13, D2876LF07, D2676LF14, D2066LF11, D2066LF31,	 3400 700 460 HD  3482 000 246  1878 004 104  3151 000 034	430 10 MFZ430 430WGTZ KZISZ-5	Getr. / GBox: ZF Ecosplit-3	
	12.04-	D2066LF25, D2676LF05, D2066LF01, D2066LF36, D2876LF12, D2676LF01, D2676LF02, D2676LF12,	 3400 700 404  3482 000 246  1878 002 139  3151 000 144	430 10 MFZ430 430WGTZ KZISZ-5	Getr. / GBox: AS-Tronic für Ausrückgabel mit Nocken / for release fork with cams	(70)
	12.04-	D2676LF11, D2876LF25, D2876LF13, D2676LF03, D2876LF04	 3400 700 445  3482 000 246  1878 002 139  3151 000 493	430 10 MFZ430 430WGTZ KZISZ-5	Getr. / GBox: AS-Tronic für Ausrückgabel mit Rollen / for release fork with rollers	(71)
	11.06-		 3400 700 459 HD  3482 000 246  1878 004 104  3151 000 493	430 10 MFZ430 430WGTZ KZISZ-5	Getr. / GBox: AS-Tronic für Ausrückgabel mit Rollen / for release fork with rollers	(71)
			 3400 700 327  3482 114 031  1878 004 832  3151 263 031	430 10 GMFZ430N 430WGTZ KZIZ-6	Getr. / GBox: ZF 16S-151/181 für Nebenantrieb / for PTO	(82)
			 3400 700 641 HD  3482 114 031  1878 007 729  3151 263 031	430 10 GMFZ430N 430WGTZ KZIZ-6	Getr. / GBox: ZF 16S-151/181 Nebenantriebs-ID / PTO ID: NMV 221	(50)
			 3496 006 000		langer Bügel / long handle	(86)
			 1863 869 038			
			 3189 600 004		Getr. / GBox: ZF AS Tronic Rollenausführung / roller version	(58)
		 3189 600 020		Getr. / GBox: ZF Ecosplit-3		







		CODE				
--	--	------	--	---	---	---

MAN

















TGA		03.00 -				
18.460 FC, FLC, FLLC, FLLRC, FLLRW, FLLW, FLRC, FRC H14 H05 H09 H02	04.00-	D2876LF07, D2066LF11, D2066LF31, D2876LF05, D2676LF05, D2066LF01, D2066LF36, D2876LF12, D2676LF01, D2876LF25, D2876LF04, D2876LF13	 3400 700 402  3482 000 246  1878 002 139  3151 000 034	430 10 MFZ430 430WGTZ KZISZ-5	Getr. / GBox: ZF Ecosplit-3 Getr. / GBox: Eaton	
18.460 FK, FK-L, FLK, FLRK H02 H05	12.00-		 3400 700 460 HD  3482 000 246  1878 004 104  3151 000 034	430 10 MFZ430 430WGTZ KZISZ-5	Getr. / GBox: ZF Ecosplit-3 Getr. / GBox: Eaton	
18.460 FLLRS, FLLS, FLRS, FLS, FLS-TS H09 H05 H61 H12 H01	04.00-		 3488 017 447	400 MFZ2/400X	Getr. / GBox: ZF Ecosplit-3 für Fahrzeuge mit Zweischeibenkupplung / for vehicles with double disc clutch enthält eine Kupplungsscheibe / This part number includes one clutch disc	(77) (67)
18.480 FC, FLC, FLLC, FLLRC, FLLRW, FLLW, FLRC H14 H05 H02 H09	09.02-		 1878 002 643	400 10 400WGTZ	Getr. / GBox: ZF Ecosplit-3 für Fahrzeuge mit Zweischeibenkupplung / for vehicles with double disc clutch	(77)
18.480 FK, FLK, FK-L, FLRK H05 H02	09.02-		 3151 262 031	KZISZ-5	Getr. / GBox: ZF Ecosplit-3 für Fahrzeuge mit Zweischeibenkupplung / for vehicles with double disc clutch	(77)
18.480 FLLRS, FLLS, FLRS, FLS, FLS-TS H12 H01 H61 H09 H05	09.02-		 3400 700 327  3482 114 031  1878 004 832  3151 263 031	430 10 GMFZ430N 430WGTZ KZIZ-6	Getr. / GBox: ZF 16S-151/181 für Nebenantrieb / for PTO	(82)
18.510 FC, FLC, FLLC, FLLRC, FLLRW, FLLW, FLRC, FRC H02 H05 H14 H09	09.00-		 3400 700 641 HD  3482 114 031  1878 007 729  3151 263 031	430 10 GMFZ430N 430WGTZ KZIZ-6	Getr. / GBox: ZF 16S-151/181 Nebenantriebs-ID / PTO ID: NMV 221	(50)
18.510 FLLRS, FLLS, FLRS, FLS H09 H05 H12	04.00-		 3400 700 404  3482 000 246  1878 002 139  3151 000 144	430 10 MFZ430 430WGTZ KZISZ-5	Getr. / GBox: AS-Tronic für Ausrückgabel mit Nocken / for release fork with cams	(70)
18.530 FC, FLC, FLLC, FLLRC, FLLRW, FLLW, FLRC H14 H09 H02 H05	09.02-		 3400 700 445  3482 000 246  1878 002 139  3151 000 493	430 10 MFZ430 430WGTZ KZISZ-5	Getr. / GBox: AS-Tronic für Ausrückgabel mit Rollen / for release fork with rollers	(71)
18.530 FLLRS, FLLS, FLRS, FLS H09 H05 H12	09.02-		 3400 700 459 HD  3482 000 246  1878 004 104  3151 000 493	430 10 MFZ430 430WGTZ KZISZ-5	Getr. / GBox: AS-Tronic für Ausrückgabel mit Rollen / for release fork with rollers	(71)
26.430, 26.440 FDK, FDLK H26 H30	05.04-		 3496 006 000		langer Bügel / long handle	(86)
26.460 FPLS, FPLRS, FVLS, FVLRS, FNLS, FNLLS, FNLR H17 H20 H23	12.00-		 3189 600 004		Getr. / GBox: ZF AS Tronic Rollenausführung / roller version	(58)
26.460 FVLC H23	02.01-		 3189 600 020		Getr. / GBox: ZF Ecosplit-3	
26.460 FVL-KO H23	12.00-		 3189 600 036		für Fahrzeuge mit Zweischeibenkupplung / for vehicles with double disc clutch	(77)
26.480 FDK, FDLK, FDLRK H30 H26	02.06-					
26.480 FNLC, FNLLC, FNLLRC, FNLLW, FNLR H17 H20 H23	09.02-					
26.480 FNLS, FNLLS, FNLR H20 H23 H17	09.02-					
26.480 FVL-KO H23	09.02-					
26.510 FNLC, FNLLC, FNLLRC, FNLLRW, FNLLW, FNLR H23 H17 H20	12.00-					
26.510 FNLS, FNLLS, FNLR H23 H20 H17	12.00-					
26.510 FNLS, FNLLS, FNLR H20 H23 H17	12.00-					
26.530 FNLC, FNLLC, FNLLRC, FNLLRW, FNLLW, FNLR, FVLC, FVLR H20 H23 H17	09.02-					
26.530 FNLS, FNLLS, FNLR H20 H17 H23	09.02-					

		CODE				
--	--	------	--	---	---	---

MAN

TGA		03.00 -						
18.480 FAC, FARC H51	09.02-	D2876LF05, D2876LF12, D2876LF25, D2876LF13, D2876LF04	 3400 700 402 ⊗ 3482 000 246 ⊗ 1878 002 139 ⊙ 3151 000 034	430 10 MFZ430 430WGTZ KZISZ-5				
18.480 FAK, FAK-L, FALK, FALK-L, FHLK H51 H70	09.02-		 3400 700 460 HD ⊗ 3482 000 246 ⊗ 1878 004 104 ⊙ 3151 000 034	430 10 MFZ430 430WGTZ KZISZ-5				
18.480 FAS, FALS, FARS H51 H70	09.02-							
24.460 FNLLC, FNLLRC, FNLLRW, FNLLW H44	09.01-			 3400 700 404 ⊗ 3482 000 246 ⊗ 1878 002 139 ⊙ 3151 000 144	430 10 MFZ430 430WGTZ KZISZ-5	Getr. / GBox: AS-Tronic für Ausrückgabel mit Nocken / for release fork with cams		(70)
24.480 FNLLC, FNLLRC, FNLLRW, FNLLW H44	09.02-			 3400 700 445 ⊗ 3482 000 246 ⊗ 1878 002 139 ⊙ 3151 000 493	430 10 MFZ430 430WGTZ KZISZ-5	Getr. / GBox: AS-Tronic für Ausrückgabel mit Rollen / for release fork with rollers		(71)
24.510 FNLLC/N, FNLLW, FNLLRW H44	09.01-			 3400 700 459 HD ⊗ 3482 000 246 ⊗ 1878 004 104 ⊙ 3151 000 493	430 10 MFZ430 430WGTZ KZISZ-5	Getr. / GBox: AS-Tronic für Ausrückgabel mit Rollen / for release fork with rollers		(71)
24.530 FNLLC, FNLLRC, FNLLRW, FNLLW H44	09.01-							
26.480 FDAC, FDALC, FDARC, FDHC, FDHLC H55 H72	09.02-			 3189 600 004		Getr. / GBox: ZF AS Tronic Rollenausführung / roller version		(58)
26.480 FDAK, FDALK, FDHK, FDHLK H55 H72	09.02-			3189 600 020		Getr. / GBox: ZF Ecosplit-3		
26.480 FDALS, FDARS, FDAS, FDHLS, FDHS H72 H55	09.02-							
26.480 FNLC, FNLLC, FNLLRC, FNLLW, FNLR, FVLC H17 H23 H20	09.02-							
26.480 FNLS, FNLLS, FNLR, FPLS, FVLS, FVLR H20 H23 H17	09.02-							
32.460 FFDC, FFDLC, FFDLRC, FFDRC H36 H40	01.02-							
32.460 FFDK, FFDLK H36 H40	01.02-							
32.460 FFD-TM, FFDRC-TM H36 H48	01.02-							
32.480 FFDC, FFDLC, FFDLRC, FFDRC H40 H36	09.02-							
32.480 FFDK, FFDLK H36 H40	09.02-							
32.480 FFD-TM, FFDRC-TM H36 H48	09.02-							
33.480 FDAC, FDAC-WW, FDALC, FDARC H54 H72 H55	09.02-							
33.480 FDAK, FDALK, FDARK, FDHK H55 H72 H54	09.02-							
33.480 FDALS, FDARS, FDAS, FDHS H55 H72 H54	09.02-							
33.530 FDAK, FDALK H72 H55	09.02-							
33.530 FDAS, FDALS H72 H55	09.02-							

MAN

TGA		03.00 -				
26.280 FNLC, FNLLC, FNLLW H19 H16	11.02-	D0836LF44, D0836LF41	 3400 121 701  3482 000 467  1862 506 131  3151 253 031	395 10 MFZ395 395WGTZ KZIZ-4,5	Getr. / GBox: EATON FS/FSO-8309	
	26.330 FNLC, FNLLC, FNLLW H19 H16		11.02-	 3496 006 000		Getr. / GBox: EATON FS/FSO-8309 langer Bügel / long handle
			 3482 000 546	395 MFZ395	Getr. / GBox: 12AS-1210TO Getr. / GBox: AS-Tronic	
			 1862 506 131	395 10 395WGTZ	Getr. / GBox: 12AS-1210TO Getr. / GBox: AS-Tronic	
			 3151 000 144	KZISZ-5	Getr. / GBox: AS-Tronic Getr. / GBox: 12AS-1210TO für Ausrückgabel mit Nocken / for release fork with cams	(70)
			 3400 700 364  3482 000 546  1862 506 131  3151 000 493	395 10 MFZ395 395WGTZ KZISZ-5	Getr. / GBox: 12AS-1210TO Getr. / GBox: AS-Tronic für Ausrückgabel mit Rollen / for release fork with rollers	(71)
			 3400 700 396  3482 000 679  1862 506 131  3151 000 515	395 10 MF395 395WGTZ KZIS-4	Getr. / GBox: ZF-9S-1310TO	
			 3189 600 004		Getr. / GBox: ZF AS Tronic Rollenausführung / roller version	(58)
			3189 600 044		Getr. / GBox: ZF-9S-1310TO	



























MAN



































TGA		03.00 -				
26.310 FNLC, FNLLC, FNLLRC, FNLLRW, FNLLW, FNLC, FVLC H17 H23 H20	09.00-	D2866LF27, D2866LF26, D2866LF28, D2866LF36, D2866LF37, D2866LF32	3400 127 401 3482 000 361 1878 004 832 3151 000 034	430 10 MFZ430 430WGTZ KZISZ-5	Getr. / GBox: ZF Ecosplit-3	
	09.02-		3488 017 447	400 MFZ2/400X	Getr. / GBox: ZF Ecosplit-3 für Fahrzeuge mit Zweischeibenkupplung / for vehicles with double disc clutch enthält eine Kupplungsscheibe / This part number includes one clutch disc	(77)
26.360 FDK, FDLK, FDRK, FDLRK H29 H25	09.02-					
26.360 FDLS, FDLS/M, FDLRS, FDLRS/M, FDLRS-WW, FDRS H29 H25 H63 H67	09.03-					
26.360 FDS, FDLS, FNLS, FNLS, FPLS, FPLRS, FVLS, FVLS H23 H17 H20 H25	12.00-		1878 002 643	400 10 400WGTZ	Getr. / GBox: ZF Ecosplit-3 für Fahrzeuge mit Zweischeibenkupplung / for vehicles with double disc clutch	(77)
26.360 FD-TM, FDR-TM H25	01.01-					
26.360 FNLC, FNLLC, FNLLRC, FNLLRW, FNLLW, FNLC, FVLC H20 H23 H17	09.00-		3400 700 403 3482 000 361 1878 004 832 3151 000 144	430 10 MFZ430 430WGTZ KZISZ-5	Getr. / GBox: ZF AS-Tronic für Ausrückgabel mit Nocken / for release fork with cams	(70)
26.360 FVL-KO H23	12.00-		3400 700 450 3482 000 361 1878 004 832 3151 000 493	430 10 MFZ430 430WGTZ KZISZ-5	Getr. / GBox: ZF AS-Tronic für Ausrückgabel mit Rollen / for release fork with rollers	(71)
26.410 FDC, FDLC, FDLRC, FDRK H29 H63 H25	01.01-		3400 700 327 3482 114 031 1878 004 832 3151 263 031	430 10 GMFZ430N 430WGTZ KZISZ-6	Getr. / GBox: ZF 16S-151/181 für Nebenantrieb / for PTO	(82)
26.410 FDK, FDRK, FDLK, FDLRK H29 H25	09.01-		3400 700 641 HD 3482 114 031 1878 007 729 3151 263 031	430 10 GMFZ430N 430WGTZ KZISZ-6	Getr. / GBox: ZF 16S-151/181 Nebenantriebs-ID / PTO ID: NMV 221	(50)
26.410 FDLRS, FDLS, FDRS, FDS H29 H63 H25	06.01-		3496 006 000		langer Bügel / long handle	(86)
26.410 FD-TM, FDR-TM H25	01.01-		3189 600 004		Getr. / GBox: ZF AS Tronic Rollenausführung / roller version	(58)
26.410 FNLC, FNLLC, FNLLRC, FNLLRW, FNLLW, FNLC, FVLC H20 H17 H23	04.00-		3189 600 020		Getr. / GBox: ZF Ecosplit-3	
26.410 FPLS, FPLRS, FVLS, FNLS, FNLLS, FNLS H20 H17 H23	12.00-		3189 600 036		für Fahrzeuge mit Zweischeibenkupplung / for vehicles with double disc clutch	(77)
26.410 FPLS, FPLRS, FVLS, FNLS, FNLLS, FNLS H17 H20 H23	12.00-					
26.410 FVL-KO H23	12.00-					
28.310 FNLC, FNLLC, FNLC H87 H86	09.02-					
28.310 FNLS, FNLS H86	09.02-					
28.360 FNLC, FNLLC, FNLC H87 H86	09.02-					
28.360 FNLS, FNLS H86	09.02-					
28.410 FNLC, FNLLC, FNLC H86 H87	09.02-					
28.410 FNLS, FNLS H86	09.02-					

TGA		03.00 -				
26.310, 26.320 FDC, FDLC, FDLRC, FDRC, FNHLC, FVHLC H35 H42 H30 H26	05.04-	D2066LF37, D2066LF03, D2066LF39, D2066LF02, D2066LF07, D2066LF33, D2066LF35, D2066LF12, D2066LF32, D2066LF14, D2066LF06, D2066LF13, D2066LF38, D2066LF04	3400 700 380 3482 000 361 1878 080 037 3151 000 034	430 10 MFZ430 430WGTZ KZISZ-5	Getr. / GBox: ZF-Ecosplit-3 H26,H30,H42	
26.310, 26.320 FDK, FDLK, FDLRK, FDRK H30 H26	05.04-		3488 017 447	400 MFZ2/400X	Getr. / GBox: ZF-Ecosplit-3 H26,H30,H42 für Fahrzeuge mit Zweischeibenkupplung / for vehicles with double disc clutch enthält eine Kupplungsscheibe / This part number includes one clutch disc	(77) (67)
26.310, 26.320 FDS, FDLS, FDRS, FNHLS, FDLRS H26 H35 H30	05.04-		1878 002 643	400 10 400WGTZ	Getr. / GBox: ZF-Ecosplit-3 H26,H30,H42 für Fahrzeuge mit Zweischeibenkupplung / for vehicles with double disc clutch	(77)
26.310, 26.320 FD-TM, FDR-TM H26	06.05-		3151 262 031	KZISZ-5	Getr. / GBox: ZF-Ecosplit-3 H26,H30,H42 für Fahrzeuge mit Zweischeibenkupplung / for vehicles with double disc clutch	(77)
26.350, 26.360 FDC, FDLC, FDLRC, FDRC, FNHLC, FVHLC H30 H35 H26 H42 H67	05.04-		3482 000 361	430 MFZ430	Getr. / GBox: AS-Tronic H26,H30,H42	
26.350, 26.360 FDK, FDLK, FDLRK, FDRK H26 H30	05.04-		1878 080 037	430 10 430WGTZ	Getr. / GBox: AS-Tronic H26,H30,H42	
26.350, 26.360 FDLRS, FDLS, FDRS, FDS, FNHLS, FPHLS, FVHLS H26 H42 H67 HV2 H30 H35	05.04-		3151 000 144	KZISZ-5	Getr. / GBox: AS-Tronic H26,H30,H42 für Ausrückgabel mit Nocken / for release fork with cams	(70)
26.350, 26.360 FD-TM, FDR-TM H26	02.04-		3400 700 381 3482 000 361 1878 080 037 3151 000 493	430 10 MFZ430 430WGTZ KZISZ-5	Getr. / GBox: AS-Tronic H26,H30,H42 für Ausrückgabel mit Rollen / for release fork with rollers	(71)
26.390, 26.400 FDC, FDLC, FDLRC, FDRC, FNHLC, FVHLC H30 H35 H67 H26 H42	05.04-		3400 700 327 3482 114 031 1878 004 832 3151 263 031	430 10 GMFZ430N 430WGTZ KZIZ-6	Getr. / GBox: ZF 16S-151/181 H26,H30,H42 für Nebenantrieb / for PTO	(82)
26.390, 26.400 FDLRS, FDLS, FDRS, FDS, FNHLS, FPHLS, FVHLS H26 H30 H67 HV2 H35 H42	05.04-		3400 700 641 HD 3482 114 031 1878 007 729 3151 263 031	430 10 GMFZ430N 430WGTZ KZIZ-6	Getr. / GBox: ZF 16S-151/181 H26,H30,H42 Nebenantriebs-ID / PTO ID: NMV 221	(50)
26.390, 26.400 FD-TM H26	05.04-		3496 006 000		H26,H30,H42 langer Bügel / long handle	(86)
33.350, 33.360 FDC, FDLC, FDRC H26 HW2 H66 H30	05.04-		3189 600 036		für Fahrzeuge mit Zweischeibenkupplung / for vehicles with double disc clutch	(77)
33.350, 33.360 FDK, FDLK, FDLRK, FDRK H30 H66 HW2 H26	05.04-		3189 600 004		Getr. / GBox: ZF AS Tronic Rollenausführung / roller version	(58)
33.350, 33.360 FDLRS, FDLS, FDRS, FDS H26 H30 HV2 H66 HW2	05.04-		3189 600 020		Getr. / GBox: ZF Ecosplit-3	
33.390, 33.400 FDC, FDLC, FDRC, FDLRC H30 H66 HW2 H26	05.04-					
33.390, 33.400 FDK, FDLK, FDLRK, FDRK H30 H66 H26 HW2	05.04-					
33.390, 33.400 FDS, FDLS, FDLRS, FDRS H26 H30 HW8 HW9 HW2 HV2 H66	05.04-					

		CODE				
--	--	------	--	---	---	---

































MAN

TGA		03.00 -					
26.310, 26.320 FNLC, FNLLC, FNLLRC, FNLLRW, FNLLW, FNLR H18 H21 26.310, 26.320 FNLS, FNLLS, FNLR, FNLLRS, FPLRS, FPLS H18 H21 26.310, 26.320 FVHL-KO H42 26.350, 26.360 FNLC, FNLLC, FNLLRC, FNLLRW, FNLLW, FNLR H21 HV1 H18 26.350, 26.360 FNLS, FNLLS, FNLR, FNLLRS, FPLRS, FPLRS HV1 H21 H24 H18 26.350, 26.360 FVHL-KO H42 26.390, 26.400 FNLC, FNLLC, FNLLRC, FNLLRW, FNLLW, FNLR H21 HV1 H18 26.390, 26.400 FNLS, FNLLS, FNLR, FNLLRS, FPLRS, FPLRS HV1 H18 H24 H21 26.390, 26.400 FVHL-KO H42	05.04-	D2066LF37, D2066LF27, D2066LF28, D2066LF03, D2066LF39, D2066LF02, D2066LF33, D2066LF26, D2066LF35, D2066LF12, D2066LF32, D2066LF14, D2066LF13, D2066LF38, D2066LF04, D2066LF24	 3400 700 380  3482 000 361  1878 080 037  3151 000 034	430 10 MFZ430 430WGTZ KZISZ-5	Getr. / GBox: ZF-Ecosplit-3 H18,H42		
		05.04-		 3488 017 447	400 MFZ2/400X	Getr. / GBox: ZF-Ecosplit-3 H18,H42 für Fahrzeuge mit Zweischeibenkupplung / for vehicles with double disc clutch enthält eine Kupplungsscheibe / This part number includes one clutch disc	(77) (67)
		06.05-		 1878 002 643	400 10 400WGTZ	Getr. / GBox: ZF-Ecosplit-3 H18,H42 für Fahrzeuge mit Zweischeibenkupplung / for vehicles with double disc clutch	(77)
		05.04-		 3151 262 031	KZISZ-5	Getr. / GBox: ZF-Ecosplit-3 H18,H42 für Fahrzeuge mit Zweischeibenkupplung / for vehicles with double disc clutch	(77)
		06.05-		 3482 000 361	430 MFZ430	Getr. / GBox: AS-Tronic H18,H42	
		05.04-		 1878 080 037	430 10 430WGTZ	Getr. / GBox: AS-Tronic H18,H42	
		05.04-		 3151 000 144	KZISZ-5	Getr. / GBox: AS-Tronic H18,H42 für Ausrückgabel mit Nocken / for release fork with cams	(70)
		05.04-		 3400 700 381  3482 000 361  1878 080 037  3151 000 493	430 10 MFZ430 430WGTZ KZISZ-5	Getr. / GBox: AS-Tronic H18,H42 für Ausrückgabel mit Rollen / for release fork with rollers	(71)
		06.05-		 3400 700 327  3482 114 031  1878 004 832  3151 263 031	430 10 GMFZ430N 430WGTZ KZISZ-6	Getr. / GBox: ZF 16S-151/181 H18,H42 für Nebenantrieb / for PTO	(82)
		05.04-		 3400 700 641 HD  3482 114 031  1878 007 729  3151 263 031	430 10 GMFZ430N 430WGTZ KZISZ-6	Getr. / GBox: ZF 16S-151/181 H18,H42 Nebenantriebs-ID / PTO ID: NMV 221	(50)
				 3496 006 000		H18,H42 langer Bügel / long handle	(86)
				 3189 600 036		für Fahrzeuge mit Zweischeibenkupplung / for vehicles with double disc clutch	(77)
				3189 600 004		Getr. / GBox: ZF AS Tronic Rollenausführung / roller version	(58)
				3189 600 020		Getr. / GBox: ZF Ecosplit-3	

TGA		03.00 -				
26.430, 26.440 FDC, FDLC, FDLRC, FDRC, FNHLC, FVHLC H26 H67 H42 H30 H35	05.04-	D2066LF11, D2066LF31, D2066LF23, D2066LF25, D2676LF05, D2066LF01, D2066LF36, D2676LF01, D2676LF02, D2676LF03	 3400 700 402  3482 000 246  1878 002 139  3151 000 034	430 10 MFZ430 430WGTZ KZISZ-5	Getr. / GBox: ZF-Ecosplit-3 H26,H30,H42	
26.430, 26.440 FDLRS, FDLS, FDRS, FDS, FNHLS, FPHLS, FVHLS H35 H30 H42 HV2 H26 H67	02.04-		 3400 700 460 HD  3482 000 246  1878 004 104  3151 000 034	430 10 MFZ430 430WGTZ KZISZ-5	Getr. / GBox: ZF-Ecosplit-3 H26,H30,H42	
26.430, 26.440 FD-TM, FDR-TM H26	05.04-		 3488 017 447	400 MFZ2/400X	Getr. / GBox: ZF-Ecosplit-3 H26,H30,H42 für Fahrzeuge mit Zweis Scheibenkupplung / for vehicles with double disc clutch enthält eine Kupplungsscheibe / This part number includes one clutch disc	(77) (67)
26.430, 26.440 FVLH-KO H42	06.05-					
26.430, 26.440, FNLC, FNLLC, FNLLW, FNLRC, FNLLRC, FVLC H18 H21 H24 HV1	05.04-					
26.480 FDC, FDLC, FDLRC, FDRC, FNHLC, FVHLC H35 H26 H67 H42 H30	02.06-		 1878 002 643	400 10 400WGTZ	Getr. / GBox: ZF-Ecosplit-3 H26,H30,H42 für Fahrzeuge mit Zweis Scheibenkupplung / for vehicles with double disc clutch	(77)
26.480 FDLRS, FDLS, FDRS, FDS, FNHLS, FPHLS, FVHLS HV2 H35 H42 H67 H26 H30	02.06-		 3151 262 031	KZISZ-5	Getr. / GBox: ZF-Ecosplit-3 H26,H30,H42 für Fahrzeuge mit Zweis Scheibenkupplung / for vehicles with double disc clutch	(77)
26.480 FD-TM H26	02.06-		 3400 700 404  3482 000 246  1878 002 139  3151 000 144	430 10 MFZ430 430WGTZ KZISZ-5	Getr. / GBox: AS-Tronic H26,H30,H42 für Ausrückgabel mit Nocken / for release fork with cams	(70)
26.480 FVHL-KO H42	02.06-					
33.430, 33.440 FDC, FDLC, FDRC, FDLRC HW2 H30 H66 H26	05.04-		 3400 700 445  3482 000 246  1878 002 139  3151 000 493	430 10 MFZ430 430WGTZ KZISZ-5	Getr. / GBox: AS-Tronic H26,H30,H42 für Ausrückgabel mit Rollen / for release fork with rollers	(71)
33.430, 33.440 FDK, FDLK, FDRK H26 H30 HW2 H66	05.04-		 3400 700 459 HD  3482 000 246  1878 004 104  3151 000 493	430 10 MFZ430 430WGTZ KZISZ-5	Getr. / GBox: AS-Tronic H26,H30,H42 für Ausrückgabel mit Rollen / for release fork with rollers	(71)
33.430, 33.440 FDLRS, FDLS, FDRS, FDS HW8 HW2 H26 H30 H66 HV2	05.04-		 3400 700 327  3482 114 031  1878 004 832  3151 263 031	430 10 GMFZ430N 430WGTZ KZIZ-6	Getr. / GBox: ZF 16S-151/181 H26,H30,H42 für Nebenantrieb / for PTO	(82)
33.480 FDC, FDLC, FDRC H26 H30 HW2 H66	01.06-		 3400 700 641 HD  3482 114 031  1878 007 729  3151 263 031	430 10 GMFZ430N 430WGTZ KZIZ-6	Getr. / GBox: ZF 16S-151/181 H26,H30,H42 Nebenantriebs-ID / PTO ID: NMV 221	(50)
33.480 FDK, FDLK, FDRK HW2 H30 H26 H66	01.06-		 3496 006 000		H26,H30,H42 langer Bügel / long handle	(86)
33.480 FDLRS, FDLS, FDRS, FDS HW9 HW2 HW8 H26 H66 HV2 H30	01.06-		 3189 600 004		Getr. / GBox: ZF AS Tronic Rollenausführung / roller version	(58)
			 3189 600 020		Getr. / GBox: ZF Ecosplit-3	
			 3189 600 036		für Fahrzeuge mit Zweis Scheibenkupplung / for vehicles with double disc clutch	(77)

		CODE				
--	--	------	--	---	---	---

MAN

TGA		03.00 -				
26.430, 26.440, FNLC, FNLLC, FNLLW, FNLR, FNLLRC, FVLC H18 H24 H21 HV1 26.430, 26.440, FNLS, FNLLS, FNLR, FNLLRS, FPLS, FPLRS H24 H18 HV1 H21 26.480 FNLC, FNLLC, FNLLRC, FNLLW, FNLR, FVLC H18 H21 H24 HV1 26.480 FNLS, FNLLS, FNLR, FPLS, FVLS, FVLR HV1 H18 H21 H24	05.04-	D2676LF14, D2066LF11, D2066LF23, D2066LF25, D2066LF31, D2676LF05, D2066LF01, D2676LF01, D2676LF02, D2676LF12	 3400 700 402  3482 000 246  1878 002 139  3151 000 034	430 10 MFZ430 430WGTZ KZISZ-5	Getr. / GBox: ZF-Ecosplit-3 H18	
	05.04-		 3400 700 460 HD  3482 000 246  1878 004 104  3151 000 034	430 10 MFZ430 430WGTZ KZISZ-5	Getr. / GBox: ZF-Ecosplit-3 H18	
	02.06-		 3488 017 447	400 MFZ2/400X	Getr. / GBox: ZF-Ecosplit-3 H18 für Fahrzeuge mit Zweischeibenkupplung / for vehicles with double disc clutch enthält eine Kupplungsscheibe / This part number includes one clutch disc	(77) (67)
	02.06-		 1878 002 643	400 10 400WGTZ	Getr. / GBox: ZF-Ecosplit-3 H18 für Fahrzeuge mit Zweischeibenkupplung / for vehicles with double disc clutch	(77)
			 3151 262 031	KZISZ-5	Getr. / GBox: ZF-Ecosplit-3 H18 für Fahrzeuge mit Zweischeibenkupplung / for vehicles with double disc clutch	(77)
			 3400 700 404  3482 000 246  1878 002 139  3151 000 144	430 10 MFZ430 430WGTZ KZISZ-5	Getr. / GBox: AS-Tronic H18 für Ausrückgabel mit Nocken / for release fork with cams	(70)
			 3400 700 445  3482 000 246  1878 002 139  3151 000 493	430 10 MFZ430 430WGTZ KZISZ-5	Getr. / GBox: AS-Tronic H18 für Ausrückgabel mit Rollen / for release fork with rollers	(71)
			 3400 700 459 HD  3482 000 246  1878 004 104  3151 000 493	430 10 MFZ430 430WGTZ KZISZ-5	Getr. / GBox: AS-Tronic H18 für Ausrückgabel mit Rollen / for release fork with rollers	(71)
			 3400 700 327  3482 114 031  1878 004 832  3151 263 031	430 10 GMFZ430N 430WGTZ KZISZ-6	Getr. / GBox: ZF 16S-151/181 H18 für Nebenantrieb / for PTO	(82)
			 3400 700 641 HD  3482 114 031  1878 007 729  3151 263 031	430 10 GMFZ430N 430WGTZ KZISZ-6	Getr. / GBox: ZF 16S-151/181 H18 Nebenantriebs-ID / PTO ID: NMV 221	(50)
			 3496 006 000		H18 langer Bügel / long handle	(86)
			 3189 600 004		Getr. / GBox: ZF AS Tronic Rollenausführung / roller version	(58)
			3189 600 020		Getr. / GBox: ZF Ecosplit-3	
			3189 600 036		für Fahrzeuge mit Zweischeibenkupplung / for vehicles with double disc clutch	(77)

















































MAN

TGA		03.00 -				
26.460 FDC, FDLC, FDLRC, FDRC H63 H29 H25	01.01-	D2876LF07, D2876LF05, D2876LF12, D2876LF25, D2876LF13, D2876LF04	3400 700 402 ③ 3482 000 246 ④ 1878 002 139 ⑤ 3151 000 034	430 10 MFZ430 430WGTZ KZISZ-5	Getr. / GBox: ZF Ecosplit-3, Eaton	
26.460 FDK, FDLK, FDLRK, FDRK H29 H25	01.01-		3400 700 460 HD ③ 3482 000 246 ④ 1878 004 104 ⑤ 3151 000 034	430 10 MFZ430 430WGTZ KZISZ-5	Getr. / GBox: ZF Ecosplit-3, Eaton	
26.460 FDLRS, FDLS, FDRS, FDS H25 H63 H29	06.01-		3488 017 447	400 MFZ2/400X	Getr. / GBox: ZF Ecosplit-3 für Fahrzeuge mit Zweischeibenkupplung / for vehicles with double disc clutch enthält eine Kupplungsscheibe / This part number includes one clutch disc	(77) (67)
26.460 FD-TM, FDR-TM H25	01.01-					
26.460 FNLC, FNLLC, FNLLRC, FNLLRW, FNLLW, FNLRK H17 H20	04.00-		1878 002 643	400 10 400WGTZ	Getr. / GBox: ZF Ecosplit-3 für Fahrzeuge mit Zweischeibenkupplung / for vehicles with double disc clutch	(77)
26.460 FPLS, FPLRS, FVLS, FVLRK, FNLS, FNLLS, FNLRS H23 H17 H20	12.00-		3151 262 031	KZISZ-5	Getr. / GBox: ZF Ecosplit-3 für Fahrzeuge mit Zweischeibenkupplung / for vehicles with double disc clutch	(77)
26.480 FDC, FDLC, FDLRC, FDRK, FNHLK, FVHLK H63 H25 H29	09.02-		3400 700 404 ③ 3482 000 246 ④ 1878 002 139 ⑤ 3151 000 144	430 10 MFZ430 430WGTZ KZISZ-5	Getr. / GBox: ZF Ecosplit-3 für Ausrückgabel mit Nocken / for release fork with cams	(70)
26.480 FDK, FDLK, FDLRK H25 H29	09.02-		3400 700 445 ③ 3482 000 246 ④ 1878 002 139 ⑤ 3151 000 493	430 10 MFZ430 430WGTZ KZISZ-5	Getr. / GBox: ZF-AS-Tronic für Ausrückgabel mit Rollen / for release fork with rollers	(71)
26.480 FDLRS, FDLS, FDRS, FDS, FNHLS, FPHLS, FVHLS H25 H63 H29	09.02-		3400 700 459 HD ③ 3482 000 246 ④ 1878 004 104 ⑤ 3151 000 493	430 10 MFZ430 430WGTZ KZISZ-5	Getr. / GBox: ZF-AS-Tronic für Ausrückgabel mit Rollen / for release fork with rollers	(71)
26.480 FD-TM H63 H25	09.02-					
26.510 FDC, FDLC, FDLRC, FDRK H25 H29	01.01-		3400 700 327 ③ 3482 114 031 ④ 1878 004 832 ⑤ 3151 263 031	430 10 GMFZ430N 430WGTZ KZISZ-6	Getr. / GBox: ZF 16S-151/181 für Nebenantrieb / for PTO	(82)
26.510 FDS, FDLS, FDLS/M, FDRS, FDLRS H29 H25	01.01-					
26.510 FNLC, FNLLC, FNLLRC, FNLLRW, FNLLW, FNLRK, FVLC H17 H20 H23	12.00-		3400 700 641 HD ③ 3482 114 031 ④ 1878 007 729 ⑤ 3151 263 031	430 10 GMFZ430N 430WGTZ KZISZ-6	Getr. / GBox: ZF 16S-151/181 Nebenantriebs-ID / PTO ID: NMV 221	(50)
26.530 FDC, FDLC, FDLRC, FDRK H29 H25	01.01-		3496 006 000		langer Bügel / long handle	(86)
26.530 FDS, FDLS, FDLS/M, FDRS, FDLRS H29 H25	01.01-		3189 600 004		Getr. / GBox: ZF AS Tronic Rollenausführung / roller version	(58)
26.530 FDK, FDLK, FDLRK H25 H29	09.02-				Getr. / GBox: ZF Ecosplit-3	
26.530 FDLRS, FDLS, FDRS, FDS H29 H25	01.01-				für Fahrzeuge mit Zweischeibenkupplung / for vehicles with double disc clutch	(77)
26.530 FNLC, FNLLC, FNLLRC, FNLLRW, FNLLW, FNLRK, FVLC, FVLRK H20 H17 H23	09.02-					
26.530 FNLS, FNLLS, FNLRS, FPLS, FVLS, FVLRK H23 H20 H17	09.02-					
28.460 FNLC, FNLLC, FNLRC H87 H86	09.02-					
28.460 FNLS, FNLRS H86	09.02-					
28.480 FNLC, FNLLC, FNLRC H86 H87	09.02-					
28.480 FNLS, FNLRS H86	09.02-					
28.510 FNLC, FNLLC, FNLRC H87 H86	09.02-					
28.510 FNLS, FNLRS H86	09.02-					
28.530 FNLC, FNLLC, FNLRC H86 H87	09.02-					
28.530 FNLS, FNLRS H86	09.02-					
33.460 FDC, FDLC, FDLRC, FDRK H62 H28 H25 H29	09.02-					

		CODE				
--	--	------	--	---	---	---































MAN

TGA		03.00 -					
33.460 FDK, FDLK, FDRK H29 H28 H62 H25 33.460 FDLRS, FDLS, FDRS, FDS H29 H62 H28 H25 33.460 FD-TM, FDR-TM H25 33.480 FDC, FDLC, FDRC, FDLRC H29 H28 H62 H25 33.480 FDC-TM, FDRC-TM, FD-TM H25 33.480 FDK, FDLK, FDRK H25 H28 H29 H62 33.480 FDLRS, FDLS, FDRS, FDS H62 H25 H29 H28 33.510 FDC, FDLC, FDRC, FDLRC H29 H25 33.510 FDLRS, FDLS, FDRS, FDS H29 H25 33.530 FDC, FDLC, FDRC, FDLRC H25 H29 33.530 FDK, FDLK H25 H29 33.530 FDLRS, FDLS, FDRS, FDS H25 H29	09.02- 09.02- 09.02- 09.02- 09.02- 09.02- 09.02- 09.02- 09.02- 09.02- 07.03- 07.03-	D2876LF07, D2876LF05, D2876LF12, D2876LF25, D2876LF13, D2876LF04	 3400 700 402  3482 000 246  1878 002 139  3151 000 034	430 10 MFZ430 430WGTZ KZISZ-5	Getr. / GBox: ZF Ecosplit-3, Eaton		
				 3400 700 460 HD  3482 000 246  1878 004 104  3151 000 034	430 10 MFZ430 430WGTZ KZISZ-5	Getr. / GBox: ZF Ecosplit-3, Eaton	
				 3488 017 447	400 MFZ2/400X	Getr. / GBox: ZF Ecosplit-3 für Fahrzeuge mit Zweischeibenkupplung / for vehicles with double disc clutch enthält eine Kupplungsscheibe / This part number includes one clutch disc	(77) (67)
				 1878 002 643	400 10 400WGTZ	Getr. / GBox: ZF Ecosplit-3 für Fahrzeuge mit Zweischeibenkupplung / for vehicles with double disc clutch	(77)
				 3151 262 031	KZISZ-5	Getr. / GBox: ZF Ecosplit-3 für Fahrzeuge mit Zweischeibenkupplung / for vehicles with double disc clutch	(77)
				 3400 700 404  3482 000 246  1878 002 139  3151 000 144	430 10 MFZ430 430WGTZ KZISZ-5	Getr. / GBox: ZF-AS-Tronic für Ausrückgabel mit Nocken / for release fork with cams	(70)
				 3400 700 445  3482 000 246  1878 002 139  3151 000 493	430 10 MFZ430 430WGTZ KZISZ-5	Getr. / GBox: ZF-AS-Tronic für Ausrückgabel mit Rollen / for release fork with rollers	(71)
				 3400 700 459 HD  3482 000 246  1878 004 104  3151 000 493	430 10 MFZ430 430WGTZ KZISZ-5	Getr. / GBox: ZF-AS-Tronic für Ausrückgabel mit Rollen / for release fork with rollers	(71)
				 3400 700 327  3482 114 031  1878 004 832  3151 263 031	430 10 GMFZ430N 430WGTZ KZISZ-6	Getr. / GBox: ZF 16S-151/181 für Nebenantrieb / for PTO	(82)
				 3400 700 641 HD  3482 114 031  1878 007 729  3151 263 031	430 10 GMFZ430N 430WGTZ KZISZ-6	Getr. / GBox: ZF 16S-151/181 Nebenantriebs-ID / PTO ID: NMV 221	(50)
				 3496 006 000		langer Bügel / long handle	(86)
				 3189 600 004		Getr. / GBox: ZF AS Tronic Rollenausführung / roller version	(58)
				3189 600 020		Getr. / GBox: ZF Ecosplit-3	
				3189 600 036		für Fahrzeuge mit Zweischeibenkupplung / for vehicles with double disc clutch	(77)

TGA		03.00 -						
28.400 FNLC, FNLLC H75 H74 28.430 FNLC, FNLLC 28.440 FNLC, FNLLC H74 H75 33.430 FDC-TM, FDRC-TM HW2 35.360 FFNHLC HH4 35.400 FFNHLC HH4 35.440 FFDK, FFDHK, FFDHLK H50 H93 H59 35.440 FFNHLC HH4	07.06-	D2066LF37, D2066LF26, D2066LF11, D2066LF36, D2066LF01, D2066LF38	 3400 700 380 ⊗ 3482 000 361 ⊗ 1878 080 037 ⊖ 3151 000 034	430 10 MFZ430 430WGTZ KZISZ-5	Getr. / GBox: ZF Ecosplit-3 03S, 06S, 10S, 13S Euro4/Euro5 / Euro4/Euro5 Euro 6 / Euro 6	(20) (18)		
	07.06-		 3400 700 381 ⊗ 3482 000 361 ⊗ 1878 080 037 ⊖ 3151 000 493	430 10 MFZ430 430WGTZ KZISZ-5	Getr. / GBox: ZF AS-Tronic 03S, 06S, 10S, 13S Euro4/Euro5 / Euro4/Euro5 Euro 6 / Euro 6 für Ausrückgabel mit Rollen / for release fork with rollers	(20) (18) (71)		
	09.07-		 3400 700 403 ⊗ 3482 000 361 ⊗ 1878 004 832 ⊖ 3151 000 144	430 10 MFZ430 430WGTZ KZISZ-5	Getr. / GBox: ZF AS-Tronic 03S, 06S, 10S, 13S Euro4/Euro5 / Euro4/Euro5 Euro 6 / Euro 6 für Ausrückgabel mit Nocken / for release fork with cams	(20) (18) (70)		
	07.06-		 3400 700 327 ⊗ 3482 114 031 ⊗ 1878 004 832 ⊖ 3151 263 031	430 10 GMFZ430N 430WGTZ KZIZ-6	Getr. / GBox: ZF Ecosplit-3 03S, 06S, 10S, 13S Euro4/Euro5 / Euro4/Euro5 Euro 6 / Euro 6 für Nebenantrieb / for PTO	(20) (18) (82)		
	11.06-		 3400 700 641 HD ⊗ 3482 114 031 ⊗ 1878 007 729 ⊖ 3151 263 031	430 10 GMFZ430N 430WGTZ KZIZ-6	Getr. / GBox: ZF Ecosplit-3 03S, 06S, 10S, 13S Euro4/Euro5 / Euro4/Euro5 Euro 6 / Euro 6 Nebenantriebs-ID / PTO ID: NMV 221	(20) (18) (50)		
	07.06-		 3488 017 447	400 MFZ2/400X	Getr. / GBox: ZF Ecosplit-3 03S, 06S, 10S, 13S Euro4/Euro5 / Euro4/Euro5 Euro 6 / Euro 6 für Fahrzeuge mit Zweischeibenkupplung / for vehicles with double disc clutch enthält eine Kupplungsscheibe / This part number includes one clutch disc	(20) (18) (77) (67)		
			 1878 002 643	400 10 400WGTZ	Getr. / GBox: ZF Ecosplit-3 03S, 06S, 10S, 13S Euro4/Euro5 / Euro4/Euro5 Euro 6 / Euro 6 für Fahrzeuge mit Zweischeibenkupplung / for vehicles with double disc clutch	(20) (18) (77)		
			 3151 262 031	KZISZ-5	Getr. / GBox: ZF Ecosplit-3 03S, 06S, 10S, 13S Euro4/Euro5 / Euro4/Euro5 Euro 6 / Euro 6 für Fahrzeuge mit Zweischeibenkupplung / for vehicles with double disc clutch	(20) (18) (77)		
			 3496 006 000		Getr. / GBox: ZF 03S, 06S, 10S, 13S Euro4/Euro5 / Euro4/Euro5 Euro 6 / Euro 6 langer Bügel / long handle	(20) (18) (86)		
			 1863 869 038		Getr. / GBox: ZF 03S, 06S, 10S, 13S Euro4/Euro5 / Euro4/Euro5 Euro 6 / Euro 6	(20) (18)		
			 3189 600 036		für Fahrzeuge mit Zweischeibenkupplung / for vehicles with double disc clutch	(77)		
			3189 600 004		Getr. / GBox: ZF AS Tronic Rollenausführung / roller version	(58)		
			3189 600 020		Getr. / GBox: ZF Ecosplit-3			
	32.360 FFD-TM, FFFDR-TM H36 H48		01.02-	D2866LF27	 3400 127 401 ⊗ 3482 000 361 ⊗ 1878 004 832 ⊖ 3151 000 034	430 10 MFZ430 430WGTZ KZISZ-5	Getr. / GBox: Ecosplit 3	
					 3400 700 403 ⊗ 3482 000 361 ⊗ 1878 004 832 ⊖ 3151 000 144	430 10 MFZ430 430WGTZ KZISZ-5	Getr. / GBox: AS-Tronic für Ausrückgabel mit Nocken / for release fork with cams	(70)
 3189 600 020					Getr. / GBox: ZF Ecosplit-3			























		CODE				
--	--	------	--	---	---	---

MAN

TGA		03.00 -				
33.360 FDC, FDLC, FDRC, FDLRC H25 H28 H29 H62 33.360 FDK, FDK-WW, FDLK, FDRK-WW H29 H62 H28 H25 33.360 FDLRS, FDLS, FDRS, FDS H29 H25 H62 H28 33.360 FD-TM, FDR-TM, FDC-TM, FDRK-TM H25 33.410 FDC, FDLC, FDLRC, FDRC H29 H62 H28 H25 33.410 FDK, FDK-WW, FDLK, FDRK-WW H28 H62 H29 H25 33.410 FDLRS, FDLS, FDRS, FDS H29 H62 H28 H25 33.410 FD-TM, FDR-TM H25	10.00-	D2866LF27, D2866LF28, D2866LF37, D2866LF32	 3400 127 401  3482 000 361  1878 004 832  3151 000 034	430 10 MFZ430 430WGTZ KZISZ-5	Getr. / GBox: ZF Ecosplit-3	
	01.01-		 3400 700 380 HD  3482 000 361  1878 080 037  3151 000 034	430 10 MFZ430 430WGTZ KZISZ-5	Getr. / GBox: ZF Ecosplit-3	
	10.00-		 3488 017 447	400 MFZ2/400X	Getr. / GBox: ZF Ecosplit-3 für Fahrzeuge mit Zweischeibenkupplung / for vehicles with double disc clutch enthält eine Kupplungsscheibe / This part number includes one clutch disc	(77) (67)
	10.00-		 1878 002 643	400 10 400WGTZ	Getr. / GBox: ZF Ecosplit-3 für Fahrzeuge mit Zweischeibenkupplung / for vehicles with double disc clutch	(77)
	10.00-		 3400 700 327  3482 114 031  1878 004 832  3151 263 031	430 10 GMFZ430N 430WGTZ KZIZ-6	Getr. / GBox: ZF 16S-151/181 für Nebenantrieb / for PTO	(82)
	10.00-		 3400 700 641 HD  3482 114 031  1878 007 729  3151 263 031	430 10 GMFZ430N 430WGTZ KZIZ-6	Getr. / GBox: ZF 16S-151/181 Nebenantriebs-ID / PTO ID: NMV 221	(50)
	10.00-		 3151 262 031	KZISZ-5	Getr. / GBox: ZF Ecosplit-3 für Fahrzeuge mit Zweischeibenkupplung / for vehicles with double disc clutch	(77)
			 3400 700 403  3482 000 361  1878 004 832  3151 000 144	430 10 MFZ430 430WGTZ KZISZ-5	Getr. / GBox: ZF-AS-Tronic für Ausrückgabel mit Nocken / for release fork with cams	(70)
			 3400 700 450  3482 000 361  1878 004 832  3151 000 493	430 10 MFZ430 430WGTZ KZISZ-5	Getr. / GBox: ZF-AS-Tronic für Ausrückgabel mit Rollen / for release fork with rollers	(71)
			 3496 006 000		langer Bügel / long handle	(86)
			 1863 869 038			
			 3189 600 004		Getr. / GBox: ZF AS Tronic Rollenausführung / roller version	(58)
			3189 600 020		Getr. / GBox: ZF Ecosplit-3	
			3189 600 036		für Fahrzeuge mit Zweischeibenkupplung / for vehicles with double disc clutch	(77)

		CODE				
--	--	------	--	---	---	---















MAN

TGA		03.00 -					
33.440 FDLS, FDRS, FDS HW2 HW8 HW9 H66 35.480 FFNHLC HH4	06.05-	D2676LF04, D2676LF05		3400 700 460 HD  3482 000 246  1878 004 104  3151 000 034	430 10 MFZ430 430WGTZ KZISZ-5	Getr. / GBox: ZF Ecosplit 3 Euro 6 / Euro 6	(18)
	11.06-			3400 700 459 HD  3482 000 246  1878 004 104  3151 000 493	430 10 MFZ430 430WGTZ KZISZ-5	Getr. / GBox: ZF AS-Tronic Euro 6 / Euro 6 für Ausrückgabel mit Rollen / for release fork with rollers	(18) (71)
				3151 000 144	KZISZ-5	Getr. / GBox: ZF AS-Tronic Euro 6 / Euro 6 für Ausrückgabel mit Nocken / for release fork with cams	(18) (70)
				3400 700 327  3482 114 031  1878 004 832  3151 263 031	430 10 GMFZ430N 430WGTZ KZIZ-6	Getr. / GBox: ZF Ecosplit 3 Euro 6 / Euro 6 für Nebenantrieb / for PTO	(18) (82)
				3400 700 641 HD  3482 114 031  1878 007 729  3151 263 031	430 10 GMFZ430N 430WGTZ KZIZ-6	Getr. / GBox: ZF Ecosplit 3 Euro 6 / Euro 6 Nebenantriebs-ID / PTO ID: NMV 221	(18) (50)
				3488 017 447	400 MFZ2/400X	Getr. / GBox: ZF Ecosplit 3 Euro 6 / Euro 6 für Fahrzeuge mit Zweischeibenkupplung / for vehicles with double disc clutch enthält eine Kupplungsscheibe / This part number includes one clutch disc	(18) (77) (67)
				1878 002 643	400 10 400WGTZ	Getr. / GBox: ZF Ecosplit 3 Euro 6 / Euro 6 für Fahrzeuge mit Zweischeibenkupplung / for vehicles with double disc clutch	(18) (77)
				3151 262 031	KZISZ-5	Getr. / GBox: ZF Ecosplit 3 Euro 6 / Euro 6 für Fahrzeuge mit Zweischeibenkupplung / for vehicles with double disc clutch	(18) (77)
				3496 006 000		Euro 6 / Euro 6 langer Bügel / long handle	(18) (86)
				1863 869 038		Euro 6 / Euro 6	(18)
				3189 600 036		für Fahrzeuge mit Zweischeibenkupplung / for vehicles with double disc clutch	(77)
				3189 600 004		Getr. / GBox: ZF AS Tronic Rollenausführung / roller version	(58)





		CODE				
--	--	------	--	---	---	---

MAN

TGA 03.00 -



































41.530 FVDS, FVDLS H94	09.02-	D2876LF13	 3400 700 402 ⊗ 3482 000 246 ⊗ 1878 002 139 ⊙ 3151 000 034	430 10 MFZ430 430WGTZ KZISZ-5	Getr. / GBox: ZF Ecosplit-3	
			 3400 700 460 HD ⊗ 3482 000 246 ⊗ 1878 004 104 ⊙ 3151 000 034	430 10 MFZ430 430WGTZ KZISZ-5	Getr. / GBox: ZF Ecosplit-3	
			 3488 017 447	400 MFZ2/400X	Getr. / GBox: ZF Ecosplit-3 für Fahrzeuge mit Zweischeibenkupplung / for vehicles with double disc clutch enthält eine Kupplungsscheibe / This part number includes one clutch disc	(77) (67)
			 1878 002 643	400 10 400WGTZ	Getr. / GBox: ZF Ecosplit-3 für Fahrzeuge mit Zweischeibenkupplung / for vehicles with double disc clutch	(77)
			 3151 262 031	KZISZ-5	Getr. / GBox: ZF Ecosplit-3 für Fahrzeuge mit Zweischeibenkupplung / for vehicles with double disc clutch	(77)
			 3400 700 404 ⊗ 3482 000 246 ⊗ 1878 002 139 ⊙ 3151 000 144	430 10 MFZ430 430WGTZ KZISZ-5	Getr. / GBox: AS-Tronic für Ausrückgabel mit Nocken / for release fork with cams	(70)
			 3400 700 445 ⊗ 3482 000 246 ⊗ 1878 002 139 ⊙ 3151 000 493	430 10 MFZ430 430WGTZ KZISZ-5	Getr. / GBox: AS-Tronic für Ausrückgabel mit Rollen / for release fork with rollers	(71)
			 3400 700 459 HD ⊗ 3482 000 246 ⊗ 1878 004 104 ⊙ 3151 000 493	430 10 MFZ430 430WGTZ KZISZ-5	Getr. / GBox: AS-Tronic für Ausrückgabel mit Rollen / for release fork with rollers	(71)
			 3496 006 000		langer Bügel / long handle	(86)
			 3189 600 036		für Fahrzeuge mit Zweischeibenkupplung / for vehicles with double disc clutch	(77)
		3189 600 004	Getr. / GBox: ZF AS Tronic Rollenausführung / roller version	(58)		
		3189 600 020	Getr. / GBox: ZF Ecosplit-3			
41.660 FVDS, FVDLS H95	09.02-	D2840LF25	 3488 017 447	400 MFZ2/400X	Getr. / GBox: ZF Ecosplit-3 für Fahrzeuge mit Zweischeibenkupplung / for vehicles with double disc clutch enthält eine Kupplungsscheibe / This part number includes one clutch disc	(77) (67)
			 1878 002 643	400 10 400WGTZ	Getr. / GBox: ZF Ecosplit-3 für Fahrzeuge mit Zweischeibenkupplung / for vehicles with double disc clutch	(77)
			 3151 262 031	KZISZ-5	Getr. / GBox: ZF Ecosplit-3 für Fahrzeuge mit Zweischeibenkupplung / for vehicles with double disc clutch	(77)
			 3496 006 000		Getr. / GBox: ZF Ecosplit-3 für Fahrzeuge mit Zweischeibenkupplung / for vehicles with double disc clutch langer Bügel / long handle	(77) (86)
			 3189 600 036		für Fahrzeuge mit Zweischeibenkupplung / for vehicles with double disc clutch	(77)

TGL 04.05 -

7.150, 8.150 FC, FRC, FLC, FLRC N03 N01 N13 N11 8.150 FK, FK-L, FLK, FLK-L, FLRK, FLRK-L, FRK, FRK-L N03 N11 N01 N13	04.05-	D0834LFL63/66	 3400 710 011 ⊗ 3482 000 461 ⊗ 1878 079 331 ⊙ 3182 600 142	362 10 MF362 362WGTZ	Getr. / GBox: ZF 6S-850 N03,N13 Euro5/Euro6 / Euro5/Euro6 Füllmedium: Mineralöl / Fill Medium: Mineral Oil	(21) (26)
			 3400 700 303 ⊗ 3482 000 461 ⊗ 1878 079 331	362 10 MF362 362WGTZ	Getr. / GBox: ZF 6S-850 Getr. / GBox: ZF 6AS-850 N03,N13 Euro5/Euro6 / Euro5/Euro6	(21)
	 3400 700 394 ⊗ 3482 000 664 ⊗ 1878 004 540 ⊙ 3151 000 515		395 10 MF395 395WGTZ KZIS-4	Getr. / GBox: ZF 6S-800 TO Getr. / GBox: ZF 6AS-800/1000 N03,N13 Euro5/Euro6 / Euro5/Euro6	(21)	
	 3151 000 515		KZIS-4	Getr. / GBox: ZF 6AS-850 Getr. / GBox: ZF 6S-800 TO Getr. / GBox: ZF 6AS-800/1000 N03,N13 Euro5/Euro6 / Euro5/Euro6	(21)	
	 1863 869 042			N03,N13 Euro5/Euro6 / Euro5/Euro6	(21)	
				3189 600 041	Getr. / GBox: ZF 6 AS 850	
		3189 600 045	Getr. / GBox: ZF 6S/6AS-800/1000			























		CODE				
--	--	------	--	---	---	---





























MAN

TGL		04.05 -				
7.180, 8.180 FC, FLC, FRC, FLRC N13 N11 N03 N01 8.180 FC, FRC, FLC, FLRC N12 N03 N13 N60 N02 8.180 FK, FK-L, FLK, FLK-L, FLRK, FLRK-L, FRK, FRK-L N12 N13 N02 N03	04.05 -	D0834LFL64/67 D0834LFL41, D0834LFL54, D0834LFL51, D0834LFL67, D0834LFL61, D0834LFL64, D0834LFL75	 3400 710 011  3482 000 461  1878 079 331  3182 600 142	362 10 MF362 362WGTZ	Getr. / GBox: ZF 6S-850 N03,N13 Euro5/Euro6 / Euro5/Euro6 Füllmedium: Mineralöl / Fill Medium: Mineral Oil	(21) (26)
	04.05 -		 3400 700 303	362 10 MF362 362WGTZ	Getr. / GBox: ZF 6S-850 Getr. / GBox: ZF 6AS-850 N03,N13 Euro5/Euro6 / Euro5/Euro6	(21)
	04.05 -		 3400 700 394  3482 000 664  1878 004 540  3151 000 515	395 10 MF395 395WGTZ KZIS-4	Getr. / GBox: ZF 6S-800 TO Getr. / GBox: ZF 6AS-800/1000 N03,N13 Euro5/Euro6 / Euro5/Euro6	(21)
			 3151 000 515	KZIS-4	Getr. / GBox: ZF 6AS-850 Getr. / GBox: ZF 6S-800 TO Getr. / GBox: ZF 6AS-800/1000 N03,N13 Euro5/Euro6 / Euro5/Euro6	(21)
			 1863 869 042		N03,N13 Euro5/Euro6 / Euro5/Euro6	(21)
7.220 FC, FLC, FRC, FLRC N03 N11 N01 N13 7.250 FC, FLC, FRC, FLRC N11 N01 N03 N13	04.05 -	D0834LFL63/65	 3400 710 011  3482 000 461  1878 079 331  3182 600 142	362 10 MF362 362WGTZ	Getr. / GBox: ZF 6S-850 N03,N13 Euro5/Euro6 / Euro5/Euro6 Füllmedium: Mineralöl / Fill Medium: Mineral Oil	(21) (26)
	04.05 -		 3400 700 303	362 10 MF362 362WGTZ	Getr. / GBox: ZF 6S-850 Getr. / GBox: ZF 6AS-850 N03,N13 Euro5/Euro6 / Euro5/Euro6	(21)
			 3400 700 394  3482 000 664  1878 004 540  3151 000 515	395 10 MF395 395WGTZ KZIS-4	Getr. / GBox: ZF 6S-800 TO Getr. / GBox: ZF 6AS-800/1000 N03,N13 Euro5/Euro6 / Euro5/Euro6	(21)
			 3151 000 515	KZIS-4	Getr. / GBox: ZF 6AS-850 Getr. / GBox: ZF 6S-800 TO Getr. / GBox: ZF 6AS-800/1000 N03,N13 Euro5/Euro6 / Euro5/Euro6	(21)
			 1863 869 042		N03,N13 Euro5/Euro6 / Euro5/Euro6	(21)
8.210 FC, FRC, FLC, FLRC N03 N02 N12 N13 N60 8.210 FK, FK-L, FLK, FLK-L, FLRK, FLRK-L, FRK, FRK-L N02 N03 N12 N13	04.05 -	D0834LFL55	 3400 710 011  3482 000 461  1878 079 331  3182 600 142	362 10 MF362 362WGTZ	Getr. / GBox: ZF 6S-850 N03,N13 Euro 4 (D4) / Euro 4 (D4) Füllmedium: Mineralöl / Fill Medium: Mineral Oil	(16) (26)
	04.05 -		 3400 700 303	362 10 MF362 362WGTZ	Getr. / GBox: ZF 6S-850 Getr. / GBox: ZF 6AS-850 N03,N13 Euro 4 (D4) / Euro 4 (D4)	(16)
			 3400 700 394  3482 000 664  1878 004 540  3151 000 515	395 10 MF395 395WGTZ KZIS-4	Getr. / GBox: ZF 6S-800 TO Getr. / GBox: ZF 6AS-800/1000 N03,N13 Euro 4 (D4) / Euro 4 (D4)	(16)
			 3151 000 515	KZIS-4	Getr. / GBox: ZF 6AS-850 Getr. / GBox: ZF 6S-800 TO Getr. / GBox: ZF 6AS-800/1000 N03,N13 Euro 4 (D4) / Euro 4 (D4)	(16)
			 1863 869 042		N03,N13 Euro 4 (D4) / Euro 4 (D4)	(16)
		D0834LFL52, D0834LFL42, D0834LFL55	 3189 600 041 3189 600 045		Getr. / GBox: ZF 6 AS 850 Getr. / GBox: ZF 6S/6AS-800/1000	

		CODE				
--	--	------	--	---	---	---









MAN







TGL		04.05 -				
8.220 FC, FLC, FRC, FLRC N03 N02 N60 N12 N13 8.220 FK, FK-L, FLK, FLK-L, FLRK, FLRK-L, FRK, FRK-L N02 N13 N12 N03	04.05 -	D0834LFL65/68	 3400 710 011 ⊗ 3482 000 461 ⊗ 1878 079 331 ⬠ 3182 600 142	362 10 MF362 362WGTZ	Getr. / GBox: ZF 6S-850 N03,N13 Euro5/Euro6 / Euro5/Euro6 Füllmedium: Mineralöl / Fill Medium: Mineral Oil	(21) (26)
	04.05 -		 3400 700 303 ⊗ 3482 000 461 ⊗ 1878 079 331	362 10 MF362 362WGTZ	Getr. / GBox: ZF 6S-850 Getr. / GBox: ZF 6AS-850 N03,N13 Euro5/Euro6 / Euro5/Euro6	(21)
			 3400 700 394 ⊗ 3482 000 664 ⊗ 1878 004 540 ⬠ 3151 000 515	395 10 MF395 395WGTZ KZIS-4	Getr. / GBox: ZF 6S-800 TO Getr. / GBox: ZF 6AS-800/1000 N03,N13 Euro5/Euro6 / Euro5/Euro6	(21)
			 3151 000 515	KZIS-4	Getr. / GBox: ZF 6AS-850 Getr. / GBox: ZF 6S-800 TO Getr. / GBox: ZF 6AS-800/1000 N03,N13 Euro5/Euro6 / Euro5/Euro6	(21)
			 1863 869 042		N03,N13 Euro5/Euro6 / Euro5/Euro6	(21)
		D0834LFL65, D0834LFL68	 3189 600 041 3189 600 045		Getr. / GBox: ZF 6 AS 850 Getr. / GBox: ZF 6S/6AS-800/1000	
8.240 FC, FRC, FLC, FLRC N60 N12 N02 8.240 FK, FK-L, FLK, FLK-L, FLRK, FLRK-L, FRK, FRK-L N02 N12	04.05 -	D0836LFL50, D0836LFL40, D0836LFL53	 3400 121 701 ⊗ 3482 000 467 ⊗ 1862 506 131 ⬠ 3151 253 031	395 10 MFZ395 395WGTZ KZIZ-4,5	Getr. / GBox: EATON FS/FSO-8309	
	04.05 -		 3496 006 000		Getr. / GBox: EATON FS/FSO-8309 langer Bügel / long handle	(86)
			 3482 000 546	395 MFZ395	Getr. / GBox: 12 AS 1210 TO Getr. / GBox: AS-Tronic	
			 1862 506 131	395 10 395WGTZ	Getr. / GBox: 12 AS 1210 TO Getr. / GBox: AS-Tronic	
			 3151 000 144	KZISZ-5	Getr. / GBox: 12 AS 1210 TO Getr. / GBox: AS-Tronic für Ausrückgabel mit Nocken / for release fork with cams	(70)
			 3400 700 364 ⊗ 3482 000 546 ⊗ 1862 506 131 ⬠ 3151 000 493	395 10 MFZ395 395WGTZ KZISZ-5	Getr. / GBox: 12 AS 1210 TO Getr. / GBox: AS-Tronic für Ausrückgabel mit Rollen / for release fork with rollers	(71)
			 3400 700 396 ⊗ 3482 000 679 ⊗ 1862 506 131 ⬠ 3151 000 515	395 10 MF395 395WGTZ KZIS-4	Getr. / GBox: ZF-9S-1310TO	
			 3189 600 044 3189 600 004		Getr. / GBox: ZF-9S-1310TO Getr. / GBox: ZF AS Tronic Rollenausführung / roller version	(58)
8.250 FC, FLC, FLRC, FRC N60 N12 N02 8.250 FK, FK-L, FLK, FLK-L, FLRK, FLRK-L, FRK, FRK-L N02 N12	04.05 -	D0836LFL63/66	 3400 700 364 ⊗ 3482 000 546 ⊗ 1862 506 131 ⬠ 3151 000 493	395 10 MFZ395 395WGTZ KZISZ-5	Getr. / GBox: ZF 12AS-1210 TO N02,N12 Euro5/Euro6 / Euro5/Euro6 für Ausrückgabel mit Rollen / for release fork with rollers	(21) (71)
	04.05 -		 3482 000 546	395 MFZ395	Getr. / GBox: ZF 12AS-1010/1210 Getr. / GBox: ZF 12AS-1210 TO N02,N12 Euro5/Euro6 / Euro5/Euro6	(21)
			 1862 506 131	395 10 395WGTZ	Getr. / GBox: ZF 12AS-1010/1210 Getr. / GBox: ZF 12AS-1210 TO Getr. / GBox: ZF 9S-1310 TO, HD N02,N12 Euro5/Euro6 / Euro5/Euro6	(21)
			 3151 000 144	KZISZ-5	Getr. / GBox: ZF 12AS-1210 TO N02,N12 Euro5/Euro6 / Euro5/Euro6 für Ausrückgabel mit Nocken / for release fork with cams	(21) (70)
			 3400 700 396 ⊗ 3482 000 679 ⊗ 1862 506 131 ⬠ 3151 000 515	395 10 MF395 395WGTZ KZIS-4	Getr. / GBox: ZF 9S-1310 TO, HD N02,N12 Euro5/Euro6 / Euro5/Euro6	(21)
			 1878 006 713 HD	395 10 395WGTZ	N02,N12 Euro5/Euro6 / Euro5/Euro6	(21)
			 1863 869 042		N02,N12 Euro5/Euro6 / Euro5/Euro6	(21)
			 3189 600 044 3189 600 004		Getr. / GBox: ZF-9S-1310TO Getr. / GBox: ZF AS Tronic Rollenausführung / roller version	(58)

TGL		04.05 -				
10.180 FC, FRC, FLC, FLRC N15 N04 N05 N61 N14	04.05-	D0834LFL41, D0834LFL54, D0834LFL65, D0834LFL52, D0834LFL68, D0834LFL42, D0834LFL51, D0834LFL67, D0834LFL55, D0834LFL76, D0834LFL64, D0834LFL62	 3400 710 011  3482 000 461  1878 079 331  3182 600 142	362 10 MF362 362WGTZ	Getr. / GBox: ZF 6S-850 N05,N15 Euro5/Euro6 / Euro5/Euro6 Füllmedium: Mineralöl / Fill Medium: Mineral Oil	(21) (26)
10.180 FK, FLK, FLRK, FRK N05 N15 N04 N14	04.05-					
10.210 FC, FRC, FLC, FLRC N15 N14 N04 N05	04.05-		 3400 700 303  3482 000 461  1878 079 331	362 10 MF362 362WGTZ	Getr. / GBox: ZF 6S-850 Getr. / GBox: ZF 6AS-850 N05,N15 Euro5/Euro6 / Euro5/Euro6	(21)
10.210 FK, FLK, FLRK, FRK N14 N15 N04 N05	04.05-					
10.220 FC, FLC, FRC, FLRC N14 N05 N15 N04	04.05-		 3400 700 394  3482 000 664  1878 004 540  3151 000 515	395 10 MF395 395WGTZ KZIS-4	Getr. / GBox: ZF 6S-800 TO Getr. / GBox: ZF 6AS-800/1000 N05,N15 Euro5/Euro6 / Euro5/Euro6	(21)
10.220 FK, FLK, FLRK, FRK N14 N04 N15 N05	04.05-					
12.180 FC, FRC, FLC, FLRC N15 N04 N05 N14 N61	04.05-		 3151 000 515	KZIS-4	Getr. / GBox: ZF 6AS-850 Getr. / GBox: ZF 6S-800 TO Getr. / GBox: ZF 6AS-800/1000 N05,N15 Euro5/Euro6 / Euro5/Euro6	(21)
12.180 FK, FLK, FLRK, FRK N05 N04 N15 N14	04.05-					
12.210 FC, FRC, FLC, FLRC N14 N04 N05 N15 N61	04.05-		 1863 869 042		N05,N15 Euro5/Euro6 / Euro5/Euro6	(21)
12.210 FK, FLK, FLRK, FRK N14 N04 N15 N05	04.05-		 3189 600 041 3189 600 045		Getr. / GBox: ZF 6 AS 850 Getr. / GBox: ZF 6S/6AS-800/1000	
12.220 FC, FRC, FLC, FLRC N04 N05 N15 N14	04.05-					
12.220 FK, FLK, FLRK, FRK N14 N15 N04 N05	04.05-					
10.240 FC, FRC, FLC, FLRC N04 N14 N15 N05	04.05-	D0836LFL50, D0836LFL75, D0836LFL40, D0836LFL60, D0836LFL53, D0836LFL63, D0836LFL66	 3400 700 364  3482 000 546  1862 506 131  3151 000 493	395 10 MFZ395 395WGTZ KZISZ-5	Getr. / GBox: ZF 12AS-1210 TO N04,N14 Euro 4 (D4) / Euro 4 (D4) für Ausrückgabel mit Rollen / for release fork with rollers	(16) (71)
10.240 FK, FLK, FLRK, FRK N04 N15 N14 N05	04.05-					
10.250 FC, FLC, FRC, FLRC N05 N04 N14 N15	04.05-		 3482 000 546	395 MFZ395	Getr. / GBox: ZF 12AS-1010/1210 Getr. / GBox: ZF 12AS-1210 TO N04,N14 Euro 4 (D4) / Euro 4 (D4)	(16)
10.250 FK, FLK, FLRK, FRK N04 N05 N14 N15	04.05-					
12.240 FC, FRC, FLC, FLRC N04 N14 N05 N15	04.05-		 1862 506 131	395 10 395WGTZ	Getr. / GBox: ZF 12AS-1010/1210 Getr. / GBox: ZF 12AS-1210 TO Getr. / GBox: ZF 9S-1310 TO, HD N04,N14 Euro 4 (D4) / Euro 4 (D4)	(16)
12.240 FK, FLK, FLRK, FRK N15 N14 N04 N05	04.05-					
12.250 FC, FLC, FRC, FLRC N04 N14 N15 N05	04.05-		 3151 000 144	KZISZ-5	Getr. / GBox: ZF 12AS-1210 TO N04,N14 Euro 4 (D4) / Euro 4 (D4) für Ausrückgabel mit Nocken / for release fork with cams	(16) (70)
12.250 FK, FLK, FLRK, FRK N05 N14 N15 N04	04.05-					
			 3400 700 396  3482 000 679  1862 506 131  3151 000 515	395 10 MF395 395WGTZ KZIS-4	Getr. / GBox: ZF 9S-1310 TO, HD N04,N14 Euro 4 (D4) / Euro 4 (D4)	(16)
			 1878 006 713 HD	395 10 395WGTZ	N04,N14 Euro 4 (D4) / Euro 4 (D4)	(16)
			 1863 869 042		N04,N14 Euro 4 (D4) / Euro 4 (D4)	(16)
			 3189 600 004 3189 600 044		Getr. / GBox: ZF AS Tronic Rollenausführung / roller version Getr. / GBox: ZF-9S-1310TO	(58)

		CODE		 Parameter		
--	--	------	--	---	---	---













MAN

TGM		10.05 -					
12.240 FLC, FLLC N16 N26	10.05-	D0836LFL50, D0836LFL51, D0836LFL44, D0836LFL40,	 3400 121 701 ⊗ 3482 000 467 ⊗ 1862 506 131 ⊙ 3151 253 031	395 10 MFZ395 395WGTZ KZIZ-4,5	Getr. / GBox: Eaton FS/FSO-8309		
12.280 FC, FLC, FLLC N16 N26	10.05-	D0836LFL54, D0836LFL41, D0836LFL67, D0836LFL64, D0836LFL55, D0836LFL52	 3400 700 364 ⊗ 3482 000 546 ⊗ 1862 506 131 ⊙ 3151 000 493	395 10 MFZ395 395WGTZ KZISZ-5	Getr. / GBox: AS-Tronic 12AS-1010 für Ausrückgabel mit Rollen / for release fork with rollers	(71)	
13.240 FALK, FALRK, FALK-L, FALRK-L N34 N36 N37	04.06-		 3482 000 546	395 MFZ395	Getr. / GBox: AS-Tronic 12AS-1010		
15.240 FLK, FLRK N18	10.05-		 1862 506 131	395 10 395WGTZ	Getr. / GBox: AS-Tronic 12AS-1010		
15.280 FC, FLC, FLLC, FLRC, FLLRC N18 N08 N16 N26	10.05-		 3151 000 144	KZISZ-5	Getr. / GBox: AS-Tronic 12AS-1010 für Ausrückgabel mit Nocken / for release fork with cams	(70)	
15.290 FC, FLC, FLRC, FLLC, FLLRC N16 N18 N26 N08	10.05-		 3400 700 396 ⊗ 3482 000 679 ⊗ 1862 506 131 ⊙ 3151 000 515	395 10 MF395 395WGTZ KZIS-4	Getr. / GBox: ZF-9S-1310TO		
22.240 FNLLC N26	10.05-		 1863 869 042				
22.280 FNLC, FNLLC, FNLLRC, FNLRC N26	10.05-		 3189 600 004		Getr. / GBox: ZF AS Tronic Rollenausführung / roller version	(58)	
26.280 FDK-HK, FDRK-HK N48	04.06-		3189 600 044		Getr. / GBox: ZF-9S-1310TO		
26.280 FD-TM, FDR-TM N48	04.06-						
26.330 FD, FDR N48	10.05-						
26.330 FDK-HK, FDRK-HK N48	04.06-						
26.330 FD-TM, FDR-TM N48	04.06-						

TGM		10.05 -					
12.250 FLC, FLLC N26 N16	10.05-	D0836LFL54, D0836LFL65, D0836LFL67, D0836LFL68, D0836LFL64, D0836LFL55, D0836LFL63, D0836LFL53, D0836LFL66		3400 121 701 ⊗ 3482 000 467 ⊗ 1862 506 131 ⊙ 3151 253 031	395 10 MFZ395 395WGTZ KZIZ-4,5	Getr. / GBox: Eaton FS/FSO-8309	
12.290 FLC, FLLC N26 N16	10.05-						
13.240 FAL-LF, FALR-LF N34 N37 N36	10.05-			3400 700 364 ⊗ 3482 000 546 ⊗ 1862 506 131 ⊙ 3151 000 493	395 10 MFZ395 395WGTZ KZISZ-5	Getr. / GBox: AS-Tronic 12AS-1010 für Ausrückgabel mit Rollen / for release fork with rollers	(71)
13.250 FAEC, FAERC, FALC, FAL, FALRC, FALR N34 N37 N36	10.05-			3482 000 546	395 MFZ395	Getr. / GBox: AS-Tronic 12AS-1010	
13.250 FAL-LF, FALR-LF N34	10.05-			1862 506 131	395 10 395WGTZ	Getr. / GBox: AS-Tronic 12AS-1010	
13.250 FALK, FALRK, FALK-L, FALRK-L N37 N36 N34	10.05-			3151 000 144	KZISZ-5	Getr. / GBox: AS-Tronic 12AS-1010 für Ausrückgabel mit Nocken / for release fork with cams	(70)
13.280 FAL-LF, FALR-LF N34	10.05-			1863 869 042			
13.290 FAEC, FAERC, FAL, FALR, FALC, FALRC N37 N34 N36	10.05-			3189 600 004		Getr. / GBox: ZF AS Tronic Rollenausführung / roller version	(58)
13.290 FAL-LF, FALR-LF N34	10.05-						
13.290 FALK, FALRK, FALK-L, FALRK-L N36 N34 N37	10.05-						
15.250 FC, FLC, FLRC, FLLC, FLLRC N18 N16 N26 N08	10.05-						
15.250 FK, FK-L, FLK, FLK-L, FLRK N18 N08	10.05-						
15.290 FK, FK-L, FLK, FLK-L, FLRK N18 N08	10.05-						
15.340 FC, FLC, FLRC N18 N08	10.05-						
15.340 FK, FK-L, FLK, FLK-L, FLRK N08 N18	10.05-						
18.250 C/L/LX N28							
18.250 FAC, FARC N38	10.05-						
18.250 FAK, FARK, FAK-L, FARK-L N38	10.05-						
18.250 FC, FLC, FLLC, FRC, FLRC, FLLRC N18 N28 N08	10.05-						
18.250 FK, FK-L, FLK, FLK-L, FLRK, FLRK-L, FRK, FRK-L N18 N08	10.05-						
18.290 C/L/LX N28							
18.290 FAC, FARC N38	10.05-						
18.290 FAK, FARK, FAK-L, FARK-L N38	10.05-						
18.290 FC, FLC, FRC, FLRC, FLLC, FLLRC N18 N28 N08	10.05-						
18.290 FK, FK-L, FLK, FLK-L, FLRK, FLRK-L, FRK, FRK-L N08 N18	10.05-						
18.340 C/L/LX N28							
18.340 FAC, FARC N38	10.05-						
18.340 FAK, FARK, FAK-L, FARK-L N38	10.05-						
18.340 FC, FLC, FLRC, FLLC, FLLRC, FRC N08 N28 N18	10.05-						

		CODE				
--	--	------	--	---	---	---

MAN

TGM		10.05 -				
18.340 FK, FK-L, FLK, FLK-L, FLRK, FLRK-L, FRK, FRK-L N18 N08	10.05-	D0836LFL54, D0836LFL65, D0836LFL67, D0836LFL68, D0836LFL64, D0836LFL55, D0836LFL63, D0836LFL53, D0836LFL66	 3400 121 701  3482 000 467  1862 506 131  3151 253 031	395 10 MFZ395 395WGTZ KZIZ-4,5	Getr. / GBox: Eaton FS/FSO-8309	
22.250 FNLLC N26	10.05-		 3400 700 364  3482 000 546  1862 506 131  3151 000 493	395 10 MFZ395 395WGTZ KZISZ-5	Getr. / GBox: AS-Tronic 12AS-1010 für Ausrückgabel mit Rollen / for release fork with rollers	(71)
22.290 FNLC, 22.290 FNLLC N26	10.05-		 3482 000 546	395 MFZ395	Getr. / GBox: AS-Tronic 12AS-1010	
26.280 FD N48	10.05-		 1862 506 131	395 10 395WGTZ	Getr. / GBox: AS-Tronic 12AS-1010	
26.280 FNLC, FNLLC, FNLRC, FNLLRC N44 N46	10.05-		 3151 000 144	KZISZ-5	Getr. / GBox: AS-Tronic 12AS-1010 für Ausrückgabel mit Nocken / for release fork with cams	(70)
26.290 FD, FDR N48	10.05-		 1863 869 042			
26.290 FD-TM, FDR-TM N48	07.08-		 3189 600 004		Getr. / GBox: ZF AS Tronic Rollenausführung / roller version	(58)
26.290 FDK-HK, FDRK-HK N48	10.05-					
26.290 FNLC, FNLLC, FNLRC, FNLLRC, FVL N44 N46	10.05-					
26.330 FNLC, FNLLC, FNLRC, FNLLRC, FVL N46 N44	10.05-					
26.340 FD, FDR N48	10.05-					
26.340 FDK-HK, FDRK-HK N48	10.05-					
26.340 FNLC, FNLLC, FNLRC, FNLLRC N44 N46	10.05-					
26.340 FD-TM, FDR-TM N48	07.08-					



MAN

TGM 10.05 -













13.240 FAL, FALC, FALRC, FAEC, FAERC, FALR N34 N36 N37	04.06-	D0836LFL51, D0836LFL50, D0836LFL44, D0836LFL40, D0836LFL41, D0836LFL54, D0836LFL55, D0836LFL53, D0836LFL52		3400 121 701 ⊗ 3482 000 467 ⊗ 1862 506 131 ⊙ 3151 253 031	395 10 MFZ395 395WGTZ KZIZ-4,5	Getr. / GBox: Eaton FS/FSO-8309	
13.280 FAEC, FAERC, FAL, FALC, FALRC N36 N34 N37	04.06-			3400 700 364 ⊗ 3482 000 546 ⊗ 1862 506 131 ⊙ 3151 000 493	395 10 MFZ395 395WGTZ KZISZ-5	Getr. / GBox: AS-Tronic 12AS-1010 für Ausrückgabel mit Rollen / for release fork with rollers	(71)
13.280 FALK, FALRK, FALK-L, FALRK-L N34 N36 N37	04.06-			3482 000 546	395 MFZ395	Getr. / GBox: AS-Tronic 12AS-1010	
15.240 FC, FLC, FLLC, FLRC, FLLRC N63 N16 N18 N08 N26	10.05-			1862 506 131	395 10 395WGTZ	Getr. / GBox: AS-Tronic 12AS-1010	
15.280 FLK, FLRK N18	10.05-			3151 000 144	KZISZ-5	Getr. / GBox: AS-Tronic 12AS-1010 für Ausrückgabel mit Nocken / for release fork with cams	(70)
15.330 FLK, FLRK N18	10.05-			3400 700 396 ⊗ 3482 000 679 ⊗ 1862 506 131 ⊙ 3151 000 515	395 10 MFZ395 395WGTZ KZIS-4	Getr. / GBox: ZF-9S-1310TO	
18.240 FAC, FARC N64 N38	10.05-			3400 710 001 ⊗ 3482 120 031 ⊗ 1878 044 631 ⊙ 3182 005 231	362 10 MFZ362 362GTZ HHISZ-3		
18.240 FAK, FARK, FAK-L, FARK-L N38	05.06-			3482 083 032	430 MFZ430	Getr. / GBox: ZF S6-85/1600/1200	
18.240 FC, FRC, FLC, FLRC, FLLC, FLLRC N08 N18 N28 N62	10.05-			1878 080 031	430 10 430WGTZ	Getr. / GBox: ZF S6-85/1600/1200	
18.240 FK, FK-L, FLK, FLK-L, FLRK, FLRK-L, FRK, FRK-L N18 N08 N62	10.05-			3151 000 034	KZISZ-5	Getr. / GBox: ZF S6-85/1600/1200	
18.280 FAC, FARC N38	10.05-			3496 006 000		Getr. / GBox: ZF S6-85/1600/1200 langer Bügel / long handle	(86)
18.280 FAK, FARK, FAK-L, FARK-L N38	10.05-			1863 869 042			
18.280 FC, FRC, FLC, FLRC, FLLC, FLLRC N62 N65 N18 N28 N08	10.05-			3189 600 044		Getr. / GBox: ZF-9S-1310TO	
18.280 FK, FK-L, FLK, FLK-L, FLRK, FLRK-L, FRK, FRK-L N18 N62 N08	10.05-			3189 600 004		Getr. / GBox: ZF AS Tronic Rollenausführung / roller version	(58)
18.280 FK, FK-L, FLK, FLK-L, FLRK, FLRK-L, FRK, FRK-L N18 N62 N08	10.05-			3189 600 020		Getr. / GBox: ZF Ecosplit-3	
18.330 FAC, FARC N38	10.05-						
18.330 FAK, FARK, FAK-L, FARK-L N38	10.05-						
18.330 FC, FRC, FLC, FLRC, FLLC, FLLRC N18 N28 N08	10.05-						
18.330 FK, FK-L, FLK, FLK-L, FLRK, FLRK-L, FRK, FRK-L N18 N08	10.05-						













TGS 08.07 -

TGS Euro 6	01.14-	D3876LF		3400 700 613 ⊗ 3482 001 145 ⊗ 1878 007 126 ⊙ 3151 000 493	430 10 MZ430 430WGTPZ KZISZ-5	Getr. / GBox: AS Tronic Euro 6 / Euro 6	(18)
				3400 700 614 ⊗ 3482 001 180 ⊗ 1878 007 126	430 10 M430 430WGTPZ	Getr. / GBox: Traxon Euro 6 / Euro 6	(18)
				6482 000 216	PHIS-6/38	Getr. / GBox: Traxon Euro 6 / Euro 6 Immer erneuern / Renew everytime	(18) (30)
				3189 600 004		Getr. / GBox: ZF AS Tronic Rollenausführung / roller version	(58)

		CODE				
--	--	------	--	---	---	---



























MAN

TGS		08.07 -				
18.320 FAC, FHLC 52S 22S	10.07-		3400 700 380 ⊕ 3482 000 361 ⊕ 1878 080 037 ⊕ 3151 000 034	430 10 MFZ430 430WGTZ KZISZ-5	Getr. / GBox: ZF Ecosplit-3 18S,22S,24S,52S,80S Euro5/Euro6 / Euro5/Euro6	(21)
18.320 FAK, FAK-L, FALK, FALK-L, FHLK, FHLK/M 22S 52S 80S	10.07-		3400 700 381 ⊕ 3482 000 361 ⊕ 1878 080 037 ⊕ 3151 000 493	430 10 MFZ430 430WGTZ KZISZ-5	Getr. / GBox: ZF AS-Tronic 18S,22S,24S,52S,80S Euro5/Euro6 / Euro5/Euro6 für Ausrückgabel mit Rollen / for release fork with rollers	(21) (71)
18.320 FAS, FHLS, FHLS/M, FALS 80S 22S 52S	10.07-		3400 700 403 ⊕ 3482 000 361 ⊕ 1878 004 832 ⊕ 3151 000 144	430 10 MFZ430 430WGTZ KZISZ-5	Getr. / GBox: ZF AS-Tronic 18S,22S,24S,52S,80S Euro5/Euro6 / Euro5/Euro6 für Ausrückgabel mit Nocken / for release fork with cams	(21) (70)
18.350 FAC 52W	10.07-		3400 700 327 ⊕ 3482 114 031 ⊕ 1878 004 832 ⊕ 3151 263 031	430 10 GMFZ430N 430WGTZ KZIZ-6	Getr. / GBox: ZF Ecosplit-3 18S,22S,24S,52S,80S Euro5/Euro6 / Euro5/Euro6 für Nebenantrieb / for PTO	(21) (82)
18.350 FAK 52W	10.07-		3400 700 641 HD ⊕ 3482 114 031 ⊕ 1878 007 729 ⊕ 3151 263 031	430 10 GMFZ430N 430WGTZ KZIZ-6	Getr. / GBox: ZF Ecosplit-3 18S,22S,24S,52S,80S Euro5/Euro6 / Euro5/Euro6 Nebenantriebs-ID / PTO ID: NMV 221	(21) (50)
18.350 FAS 52W	10.07-		3488 017 447	400 MFZ2/400X	Getr. / GBox: ZF Ecosplit-3 18S,22S,24S,52S,80S Euro5/Euro6 / Euro5/Euro6 für Fahrzeuge mit Zweis Scheibenkupplung / for vehicles with double disc clutch enthält eine Kupplungsscheibe / This part number includes one clutch disc	(21) (77) (67)
18.360 FAC, FHLC 22S 52W 52S	10.07-		1878 002 643	400 10 400WGTZ	Getr. / GBox: ZF Ecosplit-3 18S,22S,24S,52S,80S Euro5/Euro6 / Euro5/Euro6 für Fahrzeuge mit Zweis Scheibenkupplung / for vehicles with double disc clutch	(21) (77)
18.360 FAK, FAK-L, FALK, FALK-L, FHLK, FHLK/M 80S 52W 22S 52S	10.07-		3151 262 031	KZISZ-5	Getr. / GBox: ZF Ecosplit-3 18S,22S,24S,52S,80S Euro5/Euro6 / Euro5/Euro6 für Fahrzeuge mit Zweis Scheibenkupplung / for vehicles with double disc clutch	(21) (77)
18.360 FAS, FALS, FHLS, FHLS/M 52S 52W 22S 80S	10.07-		3496 006 000		Getr. / GBox: ZF 18S,22S,24S,52S,80S Euro5/Euro6 / Euro5/Euro6 langer Bügel / long handle	(21) (86)
18.390 FAC, FHLC 52W	06.08-		1863 869 038		Getr. / GBox: ZF 18S,22S,24S,52S,80S Euro5/Euro6 / Euro5/Euro6	(21)
18.390 FAK 52W	06.08-		3189 600 036		für Fahrzeuge mit Zweis Scheibenkupplung / for vehicles with double disc clutch	(77)
18.390 FAS 52W	06.08-		3189 600 004		Getr. / GBox: ZF AS Tronic Rollenausführung / roller version	(58)
18.400 FAC, FHLC 52W 52S 22S	10.07-		3189 600 020		Getr. / GBox: ZF Ecosplit-3	
18.400 FAK, FAK-L, FALK, FALK-L, FHLK, FHLK/M 80S 22S 52S	10.07-					
18.400 FAS, FALS, FHLS, FHLS/M 52W 52S 80S 22S	10.07-					
18.430 FAC 52W	10.07-					
18.430 FAK 52W	10.07-					
18.430 FAS 52W	10.07-					
32.350 FFDRC 49W	08.08-					
32.390 FFDRC 49W	06.08-					
33.350 FDAC, FDARC 56W	06.08-					
33.350 FDAK, FDALK 56W	06.08-					
33.350 FDAS, FDALS 56W	06.08-					
33.390 FDAC, FDALC, FDARC 56W	06.08-					
33.390 FDAK, FDARK 56W	06.08-					
33.390 FDAS, FDARS 56W	06.08-					
33.430 FDAC, FDARC 56W	07.08-					
33.430 FDAK, FDARK 56W	07.08-					
33.430 FDAS, FDARS 56W	07.08-					
35.350 FDAC, FDARC 56W	06.08-					
35.390 FFDAK 60W	06.08-					
35.430 FFDAK 60W	06.08-					
40.360 FDK, FDRK 34W 77W	06.08-					

TGS		08.07 -				
40.360 FDS, FDRS 34W	06.08-		3400 700 380 ⊗ 3482 000 361 ⊗ 1878 080 037 ⊙ 3151 000 034	430 10 MFZ430 430WGTZ KZISZ-5	Getr. / GBox: ZF Ecosplit-3 18S,22S,24S,52S,80S Euro5/Euro6 / Euro5/Euro6	(21)
40.390 FDK, FDRK 34W	06.08-		3400 700 381 ⊗ 3482 000 361 ⊗ 1878 080 037 ⊙ 3151 000 493	430 10 MFZ430 430WGTZ KZISZ-5	Getr. / GBox: ZF AS-Tronic 18S,22S,24S,52S,80S Euro5/Euro6 / Euro5/Euro6 für Ausrückgabel mit Rollen / for release fork with rollers	(21) (71)
40.390 FDS, FDRS 34W	06.08-		3400 700 403 ⊗ 3482 000 361 ⊗ 1878 004 832 ⊙ 3151 000 144	430 10 MFZ430 430WGTZ KZISZ-5	Getr. / GBox: ZF AS-Tronic 18S,22S,24S,52S,80S Euro5/Euro6 / Euro5/Euro6 für Ausrückgabel mit Nocken / for release fork with cams	(21) (70)
40.400 FDK, FDRK 34W 77W	06.08-		3400 700 327 ⊗ 3482 114 031 ⊗ 1878 004 832 ⊙ 3151 263 031	430 10 GMFZ430N 430WGTZ KZIZ-6	Getr. / GBox: ZF Ecosplit-3 18S,22S,24S,52S,80S Euro5/Euro6 / Euro5/Euro6 für Nebenantrieb / for PTO	(21) (82)
40.400 FDS, FDRS 34W	06.08-		3400 700 641 HD ⊗ 3482 114 031 ⊗ 1878 007 729 ⊙ 3151 263 031	430 10 GMFZ430N 430WGTZ KZIZ-6	Getr. / GBox: ZF Ecosplit-3 18S,22S,24S,52S,80S Euro5/Euro6 / Euro5/Euro6 Nebenantriebs-ID / PTO ID: NMV 221	(21) (50)
40.400 FDK, FDRK 34W 77W	06.08-		3488 017 447	400 MFZ2/400X	Getr. / GBox: ZF Ecosplit-3 18S,22S,24S,52S,80S Euro5/Euro6 / Euro5/Euro6 für Fahrzeuge mit Zweischeibenkupplung / for vehicles with double disc clutch enthält eine Kupplungsscheibe / This part number includes one clutch disc	(21) (77) (67)
40.400 FDS, FDRS 34W	06.08-		1878 002 643	400 10 400WGTZ	Getr. / GBox: ZF Ecosplit-3 18S,22S,24S,52S,80S Euro5/Euro6 / Euro5/Euro6 für Fahrzeuge mit Zweischeibenkupplung / for vehicles with double disc clutch	(21) (77)
40.480 FDK, FDRK 34W 77W	06.08-		3151 262 031	KZISZ-5	Getr. / GBox: ZF Ecosplit-3 18S,22S,24S,52S,80S Euro5/Euro6 / Euro5/Euro6 für Fahrzeuge mit Zweischeibenkupplung / for vehicles with double disc clutch	(21) (77)
41.360 FFDAAK 60W 96S	07.08-		3496 006 000		Getr. / GBox: ZF 18S,22S,24S,52S,80S Euro5/Euro6 / Euro5/Euro6 langer Bügel / long handle	(21) (86)
41.390 FFDAAK 60W	06.08-		1863 869 038		Getr. / GBox: ZF 18S,22S,24S,52S,80S Euro5/Euro6 / Euro5/Euro6	(21)
41.400 FFDAAK 60W 96S	07.08-		3189 600 036		für Fahrzeuge mit Zweischeibenkupplung / for vehicles with double disc clutch	(77)
41.430 FFDAAK 60W	07.08-		3189 600 004		Getr. / GBox: ZF AS Tronic Rollenausführung / roller version	(58)
			3189 600 020		Getr. / GBox: ZF Ecosplit-3	



























		CODE		 Parameter		
--	--	------	--	---	---	---

MAN

TGS		08.07 -					
18.320 FC, FLC, FLRC, FLLC, FLLRC, FLLW, FLLW/N 06S 15S 03S 10S 18.320 FK, FK-L, FLK, FLK/M 06S 03S 18.320 FLS, FLS/M, FLS-TS, FLRS, FLRS/M, FLLS, FLLS/N, FLLRS 08S 13S 10S 06S 18.360 FK, FK-L, FLK, FLK/M 06S 03S 18.400 FC, FLC, FLRC, FLLC, FLLRC, FLLW, FLLW/N 15S 10S 03S 06S	10.07-	D2066LF37, D2066LF42, D2066LF43, D2066LF28, D2066LF41, D2066LF39, D2066LF26, D2066LF53, D2066LF61, D2066LF68, D2066LF67, D2066LF51, D2066LF38	 3400 700 380  3482 000 361  1878 080 037  3151 000 034	430 10 MFZ430 430WGTZ KZISZ-5	Getr. / GBox: ZF Ecosplit-3 03S, 06S, 10S, 13S Euro4/Euro5 / Euro4/Euro5 Euro 6 / Euro 6	(20) (18)	
		10.07-		 3400 700 381  3482 000 361  1878 080 037  3151 000 493	430 10 MFZ430 430WGTZ KZISZ-5	Getr. / GBox: ZF AS-Tronic 03S, 06S, 10S, 13S Euro4/Euro5 / Euro4/Euro5 Euro 6 / Euro 6 für Ausrückgabel mit Rollen / for release fork with rollers	(20) (18) (71)
		10.07-		 3400 700 403  3482 000 361  1878 004 832  3151 000 144	430 10 MFZ430 430WGTZ KZISZ-5	Getr. / GBox: ZF AS-Tronic 03S, 06S, 10S, 13S Euro4/Euro5 / Euro4/Euro5 Euro 6 / Euro 6 für Ausrückgabel mit Nocken / for release fork with cams	(20) (18) (70)
		10.07-		 3400 700 327  3482 114 031  1878 004 832  3151 263 031	430 10 GMFZ430N 430WGTZ KZIZ-6	Getr. / GBox: ZF Ecosplit-3 03S, 06S, 10S, 13S Euro4/Euro5 / Euro4/Euro5 Euro 6 / Euro 6 für Nebenantrieb / for PTO	(20) (18) (82)
				 3400 700 641 HD  3482 114 031  1878 007 729  3151 263 031	430 10 GMFZ430N 430WGTZ KZIZ-6	Getr. / GBox: ZF Ecosplit-3 03S, 06S, 10S, 13S Euro4/Euro5 / Euro4/Euro5 Euro 6 / Euro 6 Nebenantriebs-ID / PTO ID: NMV 221	(20) (18) (50)
				 3488 017 447	400 MFZ2/400X	Getr. / GBox: ZF Ecosplit-3 03S, 06S, 10S, 13S Euro4/Euro5 / Euro4/Euro5 Euro 6 / Euro 6 für Fahrzeuge mit Zweis Scheibenkupplung / for vehicles with double disc clutch enthält eine Kupplungsscheibe / This part number includes one clutch disc	(20) (18) (77) (67)
				 1878 002 643	400 10 400WGTZ	Getr. / GBox: ZF Ecosplit-3 03S, 06S, 10S, 13S Euro4/Euro5 / Euro4/Euro5 Euro 6 / Euro 6 für Fahrzeuge mit Zweis Scheibenkupplung / for vehicles with double disc clutch	(20) (18) (77)
				 3151 262 031	KZISZ-5	Getr. / GBox: ZF Ecosplit-3 03S, 06S, 10S, 13S Euro4/Euro5 / Euro4/Euro5 Euro 6 / Euro 6 für Fahrzeuge mit Zweis Scheibenkupplung / for vehicles with double disc clutch	(20) (18) (77)
				 3496 006 000		Getr. / GBox: ZF 03S, 06S, 10S, 13S Euro4/Euro5 / Euro4/Euro5 Euro 6 / Euro 6 langer Bügel / long handle	(20) (18) (86)
				 1863 869 038		Getr. / GBox: ZF 03S, 06S, 10S, 13S Euro4/Euro5 / Euro4/Euro5 Euro 6 / Euro 6	(20) (18)
				 3189 600 036		für Fahrzeuge mit Zweis Scheibenkupplung / for vehicles with double disc clutch	(77)
				3189 600 004		Getr. / GBox: ZF AS Tronic Rollenausführung / roller version	(58)
				3189 600 020		Getr. / GBox: ZF Ecosplit-3	













		CODE		 Parameter		
--	--	------	--	---	---	---

MAN

TGS		08.07 -					
18.360 FC, FLC, FLRC, FLLC, FLLRC, FLLW, FLLW/N 06S 10S 15S 03S 18.360 FLS, FLS/M, FLS-TS, FLRS, FLRS/M, FLLS, FLLS/N, FLLRS 06S 10S 13S 08S 18.400 FK, FK-L, FLK, FLK/M 03S 06S 18.400 FLS, FLS/M, FLS-TS, FLRS, FLRS/M, FLLS, FLLS/N, FLLRS 10S 06S 08S 13S	10.07 -	D2066LF37, D2066LF42, D2066LF27, D2066LF41, D2066LF26, D2066LF52, D2066LF61, D2066LF67, D2066LF51, D2066LF38	 3400 700 380  3482 000 361  1878 080 037  3151 000 034	430 10 MFZ430 430WGTZ KZISZ-5	Getr. / GBox: ZF Ecosplit-3 03S,06S,10S,13S,24S Euro4/Euro5 / Euro4/Euro5 Euro 6 / Euro 6	(20) (18)	
	10.07 -		 3400 700 381  3482 000 361  1878 080 037  3151 000 493	430 10 MFZ430 430WGTZ KZISZ-5	Getr. / GBox: ZF AS-Tronic 03S,06S,10S,13S,24S Euro4/Euro5 / Euro4/Euro5 Euro 6 / Euro 6 für Ausrückgabel mit Rollen / for release fork with rollers	(20) (18) (71)	
	10.07 -		 3400 700 403  3482 000 361  1878 004 832  3151 000 144	430 10 MFZ430 430WGTZ KZISZ-5	Getr. / GBox: ZF AS-Tronic 03S,06S,10S,13S,24S Euro4/Euro5 / Euro4/Euro5 Euro 6 / Euro 6 für Ausrückgabel mit Nocken / for release fork with cams	(20) (18) (70)	
	10.07 -		 3400 700 327  3482 114 031  1878 004 832  3151 263 031	430 10 GMFZ430N 430WGTZ KZIZ-6	Getr. / GBox: ZF Ecosplit-3 03S,06S,10S,13S,24S Euro4/Euro5 / Euro4/Euro5 Euro 6 / Euro 6 für Nebenantrieb / for PTO	(20) (18) (82)	
				 3400 700 641 HD  3482 114 031  1878 007 729  3151 263 031	430 10 GMFZ430N 430WGTZ KZIZ-6	Getr. / GBox: ZF Ecosplit-3 03S,06S,10S,13S,24S Euro4/Euro5 / Euro4/Euro5 Euro 6 / Euro 6 Nebenantriebs-ID / PTO ID: NMV 221	(20) (18) (50)
				 3488 017 447	400 MFZ2/400X	Getr. / GBox: ZF Ecosplit-3 03S,06S,10S,13S,24S Euro4/Euro5 / Euro4/Euro5 Euro 6 / Euro 6 für Fahrzeuge mit Zweischeibenkupplung / for vehicles with double disc clutch enthält eine Kupplungsscheibe / This part number includes one clutch disc	(20) (18) (77) (67)
				 1878 002 643	400 10 400WGTZ	Getr. / GBox: ZF Ecosplit-3 03S,06S,10S,13S,24S Euro4/Euro5 / Euro4/Euro5 Euro 6 / Euro 6 für Fahrzeuge mit Zweischeibenkupplung / for vehicles with double disc clutch	(20) (18) (77)
				 3151 262 031	KZISZ-5	Getr. / GBox: ZF Ecosplit-3 03S,06S,10S,13S,24S Euro4/Euro5 / Euro4/Euro5 Euro 6 / Euro 6 für Fahrzeuge mit Zweischeibenkupplung / for vehicles with double disc clutch	(20) (18) (77)
				 3496 006 000		Getr. / GBox: ZF 03S,06S,10S,13S,24S Euro4/Euro5 / Euro4/Euro5 Euro 6 / Euro 6 langer Bügel / long handle	(20) (18) (86)
				 1863 869 038		Getr. / GBox: ZF 03S,06S,10S,13S,24S Euro4/Euro5 / Euro4/Euro5 Euro 6 / Euro 6	(20) (18)
				 3189 600 036		für Fahrzeuge mit Zweischeibenkupplung / for vehicles with double disc clutch	(77)
				3189 600 004		Getr. / GBox: ZF AS Tronic Rollenausführung / roller version	(58)
				3189 600 020		Getr. / GBox: ZF Ecosplit-3	













		CODE				
--	--	------	--	---	---	---

MAN

TGS		08.07 -				
18.440 FAC, FHLC 22S 52S	10.07-	D2676LF04, D2676LF26, D2066LF02, D2676LF22	 3400 700 460 HD ⊙ 3482 000 246 ⊙ 1878 004 104 ⬤ 3151 000 034	430 10 MFZ430 430WGTZ KZISZ-5	Getr. / GBox: ZF Ecosplit 3 Euro 6 / Euro 6	(18)
18.440 FAK, FAK-L, FALK, FALK-L, FHLK, FHLK/M 22S 52S 80S	10.07-		 3400 700 459 HD ⊙ 3482 000 246 ⊙ 1878 004 104 ⬤ 3151 000 493	430 10 MFZ430 430WGTZ KZISZ-5	Getr. / GBox: ZF AS-Tronic Euro 6 / Euro 6 für Ausrückgabel mit Rollen / for release fork with rollers	(18) (71)
18.440 FAS, FALS, FHLS 52S 22S 80S	10.07-		 3151 000 144	KZISZ-5	Getr. / GBox: ZF AS-Tronic Euro 6 / Euro 6 für Ausrückgabel mit Nocken / for release fork with cams	(18) (70)
18.440 FC, FLC, FLRC, FLLC, FLLRC, FLLW, FLLW/N 10S 03S 15S 06S	10.07-		 3400 700 327 ⊙ 3482 114 031 ⊙ 1878 004 832 ⬤ 3151 263 031	430 10 GMFZ430N 430WGTZ KZIZ-6	Getr. / GBox: ZF Ecosplit 3 Euro 6 / Euro 6 für Nebenantrieb / for PTO	(18) (82)
18.440 FK, FK-L, FLK 06S 03S	10.07-		 3400 700 641 HD ⊙ 3482 114 031 ⊙ 1878 007 729 ⬤ 3151 263 031	430 10 GMFZ430N 430WGTZ KZIZ-6	Getr. / GBox: ZF Ecosplit 3 Euro 6 / Euro 6 Nebenantriebs-ID / PTO ID: NMV 221	(18) (50)
18.440 FLS, FLS/M, FLS-TS, FLRS, FLRS/M, FLLS, FLLS/N, FLLRS 10S 06S 08S 13S	10.07-		 3488 017 447	400 MFZ2/400X	Getr. / GBox: ZF Ecosplit 3 Euro 6 / Euro 6 für Fahrzeuge mit Zweischeibenkupplung / for vehicles with double disc clutch enthält eine Kupplungsscheibe / This part number includes one clutch disc	(18) (77) (67)
24.440 FNLLW/N 45S	10.07-		 1878 002 643	400 10 400WGTZ	Getr. / GBox: ZF Ecosplit 3 Euro 6 / Euro 6 für Fahrzeuge mit Zweischeibenkupplung / for vehicles with double disc clutch	(18) (77)
24.440 FPLS, FPLRS 24S	10.07-		 3151 262 031	KZISZ-5	Getr. / GBox: ZF Ecosplit 3 Euro 6 / Euro 6 für Fahrzeuge mit Zweischeibenkupplung / for vehicles with double disc clutch	(18) (77)
26.440 FDAC, FDALC, FDHLC 82S 70S 56S	02.09-		 3496 006 000		Euro 6 / Euro 6 langer Bügel / long handle	(18) (86)
26.440 FDAK, FDALK, FDHK, FDHLK 56S 82S 70S	02.09-		 1863 869 038		Euro 6 / Euro 6	(18)
26.440 FDAS, FDALS, FDHS, FDHLS 56S 70S 82S	02.09-		 3189 600 036		für Fahrzeuge mit Zweischeibenkupplung / for vehicles with double disc clutch	(77)
26.440 FDC, FDR, FDLC, FDLRC, FNHLC, FVHLC 30S 78W 26S 35S	02.09-		 3189 600 004		Getr. / GBox: ZF AS Tronic Rollenausführung / roller version	(58)
26.440 FDK, FDLK 30S 26S	07.08-					
26.440 FDS, FDRS, FDLS, FDLRS, FNHLS, FPHLS, FVHLS 78W 35S 26S 30S	05.08-					
26.440 FD-TM 26S	07.08-					
26.440 FNLC, FNLLC, FNLLRC, FNLLW, FNLR, C, FVLC 24S 18S 21S	10.07-					
26.440 FNLS, FNLLS, FNLR, S, FPLS, FPLRS, FVLS 18S 24S	10.07-					
28.440 FANLC, FNHLC 71S 84S	08.08-					
28.440 FANLK 84S	08.08-					
28.440 FNLC, FNLR, C 89S 74S	08.08-					
28.440 FNLS, FNLR, S 89S	08.08-					
32.440 FFDR, C 49S	08.08-					
32.440 FFD-TM, FFDR-TM 49S	08.08-					
33.440 FDAC, FDALC, FDARC 56W 82S 56S	07.08-					
33.440 FDAK, FDALK, FDARK, FDHK 56S 82S 56W	07.08-					
33.440 FDAS, FDALS, FDARS, FDHS 56S 56W 82S	07.08-					
33.440 FDC, FDLC, FDLRC, FDR, FDR, C 76W 30S 26W 26S	08.08-					
33.440 FDK, FDLK, FDRK 26S 30S 26W 76W	10.07-					































		CODE				
--	--	------	--	---	---	---































MAN

TGS		08.07 -					
33.440 FDS, FDLS, FDLS/M, FDRS 76W 30S 26W 26S 30W	10.07-	D2676LF04, D2676LF26, D2066LF02, D2676LF22		3400 700 460 HD ⊗ 3482 000 246 ⊗ 1878 004 104 ⊙ 3151 000 034	430 10 MFZ430 430WGTZ KZISZ-5	Getr. / GBox: ZF Ecosplit 3 Euro 6 / Euro 6	(18)
35.440 FFDK 96S	06.08-			3400 700 459 HD ⊗ 3482 000 246 ⊗ 1878 004 104 ⊙ 3151 000 493	430 10 MFZ430 430WGTZ KZISZ-5	Getr. / GBox: ZF AS-Tronic Euro 6 / Euro 6 für Ausrückgabel mit Rollen / for release fork with rollers	(18) (71)
35.440 FFDK, FFDLK, FFDRK 41S 37S	08.08-			3151 000 144	KZISZ-5	Getr. / GBox: ZF AS-Tronic Euro 6 / Euro 6 für Ausrückgabel mit Nocken / for release fork with cams	(18) (70)
35.440 FFD-TM 37S	08.08-			3400 700 327 ⊗ 3482 114 031 ⊗ 1878 004 832 ⊙ 3151 263 031	430 10 GMFZ430N 430WGTZ KZIZ-6	Getr. / GBox: ZF Ecosplit 3 Euro 6 / Euro 6 für Nebenantrieb / for PTO	(18) (82)
35.440 FFNHLC 73S	06.08-			3400 700 641 HD ⊗ 3482 114 031 ⊗ 1878 007 729 ⊙ 3151 263 031	430 10 GMFZ430N 430WGTZ KZIZ-6	Getr. / GBox: ZF Ecosplit 3 Euro 6 / Euro 6 Nebenantriebs-ID / PTO ID: NMV 221	(18) (50)
35.440 FFNC 90S	06.08-			3488 017 447	400 MFZ2/400X	Getr. / GBox: ZF Ecosplit 3 Euro 6 / Euro 6 für Fahrzeuge mit Zweischeibenkupplung / for vehicles with double disc clutch enthält eine Kupplungsscheibe / This part number includes one clutch disc	(18) (77) (67)
37.440 FFDC 39S	07.08-			1878 002 643	400 10 400WGTZ	Getr. / GBox: ZF Ecosplit 3 Euro 6 / Euro 6 für Fahrzeuge mit Zweischeibenkupplung / for vehicles with double disc clutch	(18) (77)
37.440 FFDK 39S	07.08-			3151 262 031	KZISZ-5	Getr. / GBox: ZF Ecosplit 3 Euro 6 / Euro 6 für Fahrzeuge mit Zweischeibenkupplung / for vehicles with double disc clutch	(18) (77)
37.440 FFD-TM 39S	07.08-			3496 006 000		Euro 6 / Euro 6 langer Bügel / long handle	(18) (86)
41.390 FFDK, FFDRK 39W	06.08-			1863 869 038		Euro 6 / Euro 6	(18)
41.440 FFD, FFDC, FFDRK 39S 39W 79W	06.08-			3189 600 036		für Fahrzeuge mit Zweischeibenkupplung / for vehicles with double disc clutch	(77)
41.440 FFDK 93S	06.08-			3189 600 004		Getr. / GBox: ZF AS Tronic Rollenausführung / roller version	(58)

		CODE				
--	--	------	--	---	---	---























MAN































TGS		08.07 -					
18.440 FAC, FHLC 52W 52S 22S 18.440 FAK, FAK-L, FALK, FALK-L, FHLK, FHLK/M 52W 80S 22S 52S 18.440 FAS, FALS, FHLS, FHLS/M 52S 52W 80S 22S	10.07 -	D2066LF25, D2066LF36, D2066LF62, D2066LF40, D2066LF50		3400 700 402  3482 000 246  1878 002 139  3151 000 034	430 10 MFZ430 430WGTZ KZISZ-5	Getr. / GBox: ZF Ecosplit 3 52S,80S	
	10.07 -			3400 700 460 HD  3482 000 246  1878 004 104  3151 000 034	430 10 MFZ430 430WGTZ KZISZ-5	Getr. / GBox: ZF Ecosplit 3 52S,80S	
	10.07 -			3400 700 381  3482 000 361  1878 080 037  3151 000 493	430 10 MFZ430 430WGTZ KZISZ-5	Getr. / GBox: ZF AS-Tronic 52S,80S für Ausrückgabel mit Rollen / for release fork with rollers	(71)
				3400 700 403  3482 000 361  1878 004 832  3151 000 144	430 10 MFZ430 430WGTZ KZISZ-5	Getr. / GBox: ZF AS-Tronic 52S,80S für Ausrückgabel mit Nocken / for release fork with cams	(70)
				3400 700 327  3482 114 031  1878 004 832  3151 263 031	430 10 GMFZ430N 430WGTZ KZISZ-6	Getr. / GBox: ZF Ecosplit 3 52S,80S für Nebenantrieb / for PTO	(82)
				3400 700 641 HD  3482 114 031  1878 007 729  3151 263 031	430 10 GMFZ430N 430WGTZ KZISZ-6	Getr. / GBox: ZF Ecosplit 3 52S,80S Nebenantriebs-ID / PTO ID: NMV 221	(50)
				3488 017 447	400 MFZ2/400X	Getr. / GBox: ZF Ecosplit 3 52S,80S für Fahrzeuge mit Zweischeibenkupplung / for vehicles with double disc clutch enthält eine Kupplungsscheibe / This part number includes one clutch disc	(77) (67)
				1878 002 643	400 10 400WGTZ	Getr. / GBox: ZF Ecosplit 3 52S,80S für Fahrzeuge mit Zweischeibenkupplung / for vehicles with double disc clutch	(77)
				3151 262 031	KZISZ-5	Getr. / GBox: ZF Ecosplit 3 52S,80S für Fahrzeuge mit Zweischeibenkupplung / for vehicles with double disc clutch	(77)
				3496 006 000		52S,80S langer Bügel / long handle	(86)
				1863 869 038		52S,80S	
				3189 600 036		für Fahrzeuge mit Zweischeibenkupplung / for vehicles with double disc clutch	(77)
				3189 600 004		Getr. / GBox: ZF AS Tronic Rollenausführung / roller version	(58)
				3189 600 020		Getr. / GBox: ZF Ecosplit-3	

TGS		08.07 -					
18.440 FC, FLC, FLRC, FLLC, FLLRC, FLLW, FLLW/N 06S 03S 10S 15S 18.440 FK, FK-L, FLK, FLK/M 03S 06S 18.440 FLS, FLS/M, FLS-TS, FLRS, FLRS/M, FLLS, FLLS/N, FLLRS 06S 08S 10S 13S 24.440 FPLS, FPLRS 24S	10.07 -	D2066LF25EUR O5, D2066LF36EUR O4	 3400 700 402  3482 000 246  1878 002 139  3151 000 034	430 10 MFZ430 430WGTZ KZISZ-5	Getr. / GBox: ZF Ecosplit-3 03S,06S,10S,13S,24S		
	10.07 -		 3400 700 460 HD  3482 000 246  1878 004 104  3151 000 034	430 10 MFZ430 430WGTZ KZISZ-5	Getr. / GBox: ZF Ecosplit-3 03S,06S,10S,13S,24S		
	10.07 -		 3400 700 381  3482 000 361  1878 080 037  3151 000 493	430 10 MFZ430 430WGTZ KZISZ-5	Getr. / GBox: ZF AS-Tronic 03S,06S,10S,13S,24S für Ausrückgabel mit Rollen / for release fork with rollers	(71)	
	10.07 -		 3400 700 403  3482 000 361  1878 004 832  3151 000 144	430 10 MFZ430 430WGTZ KZISZ-5	Getr. / GBox: ZF AS-Tronic 03S,06S,10S,13S,24S für Ausrückgabel mit Nocken / for release fork with cams	(70)	
			 3400 700 327  3482 114 031  1878 004 832  3151 263 031	430 10 GMFZ430N 430WGTZ KZISZ-6	Getr. / GBox: ZF Ecosplit-3 03S,06S,10S,13S,24S für Nebenantrieb / for PTO	(82)	
			 3400 700 641 HD  3482 114 031  1878 007 729  3151 263 031	430 10 GMFZ430N 430WGTZ KZISZ-6	Getr. / GBox: ZF Ecosplit-3 03S,06S,10S,13S,24S Nebenantriebs-ID / PTO ID: NMV 221	(50)	
			 3488 017 447	400 MFZ2/400X	Getr. / GBox: ZF Ecosplit-3 03S,06S,10S,13S,24S für Fahrzeuge mit Zweischeibenkupplung / for vehicles with double disc clutch enthält eine Kupplungsscheibe / This part number includes one clutch disc	(77) (67)	
			 1878 002 643	400 10 400WGTZ	Getr. / GBox: ZF Ecosplit-3 03S,06S,10S,13S,24S für Fahrzeuge mit Zweischeibenkupplung / for vehicles with double disc clutch	(77)	
			 3151 262 031	KZISZ-5	Getr. / GBox: ZF Ecosplit-3 03S,06S,10S,13S,24S für Fahrzeuge mit Zweischeibenkupplung / for vehicles with double disc clutch	(77)	
			 3496 006 000		Getr. / GBox: ZF 03S,06S,10S,13S,24S langer Bügel / long handle	(86)	
			 1863 869 038		Getr. / GBox: ZF 03S,06S,10S,13S,24S		
			 3189 600 004		Getr. / GBox: ZF AS Tronic Rollenausführung / roller version	(58)	
					3189 600 020	Getr. / GBox: ZF Ecosplit-3	
					3189 600 036	für Fahrzeuge mit Zweischeibenkupplung / for vehicles with double disc clutch	(77)

		CODE		 Parameter		
--	--	------	--	---	---	---























MAN































TGS		08.07 -				
18.480 FAC, FHLC 52W 52S 22S 18.480 FAK, FAK-L, FALK, FALK-L, FHLK, FHLK/M 80S 52S 22S 18.480 FAS, FALS, FHLS 80S 22S 52W 52S	10.07 -	D2676LF20, D2676LF07, D2676LF05, D2676LF02, D2676LF25	 3400 700 460 HD  3482 000 246  1878 004 104  3151 000 034	430 10 MFZ430 430WGTZ KZISZ-5	Getr. / GBox: ZF Ecosplit 3 52S,80S Euro5/Euro6 / Euro5/Euro6	(21)
	10.07 -		 3400 700 459 HD  3482 000 246  1878 004 104  3151 000 493	430 10 MFZ430 430WGTZ KZISZ-5	Getr. / GBox: ZF AS-Tronic 52S,80S Euro5/Euro6 / Euro5/Euro6 für Ausrückgabel mit Rollen / for release fork with rollers	(21) (71)
	10.07 -		 3151 000 144	KZISZ-5	Getr. / GBox: ZF AS-Tronic 52S,80S Euro5/Euro6 / Euro5/Euro6 für Ausrückgabel mit Nocken / for release fork with cams	(21) (70)
			 3400 700 327  3482 114 031  1878 004 832  3151 263 031	430 10 GMFZ430N 430WGTZ KZIZ-6	Getr. / GBox: ZF Ecosplit 3 52S,80S Euro5/Euro6 / Euro5/Euro6 für Nebenantrieb / for PTO	(21) (82)
			 3400 700 641 HD  3482 114 031  1878 007 729  3151 263 031	430 10 GMFZ430N 430WGTZ KZIZ-6	Getr. / GBox: ZF Ecosplit 3 52S,80S Euro5/Euro6 / Euro5/Euro6 Nebenantriebs-ID / PTO ID: NMV 221	(21) (50)
			 3488 017 447	400 MFZ2/400X	Getr. / GBox: ZF Ecosplit 3 52S,80S Euro5/Euro6 / Euro5/Euro6 für Fahrzeuge mit Zweischeibenkupplung / for vehicles with double disc clutch enthält eine Kupplungsscheibe / This part number includes one clutch disc	(21) (77) (67)
			 1878 002 643	400 10 400WGTZ	Getr. / GBox: ZF Ecosplit 3 52S,80S Euro5/Euro6 / Euro5/Euro6 für Fahrzeuge mit Zweischeibenkupplung / for vehicles with double disc clutch	(21) (77)
			 3151 262 031	KZISZ-5	Getr. / GBox: ZF Ecosplit 3 52S,80S Euro5/Euro6 / Euro5/Euro6 für Fahrzeuge mit Zweischeibenkupplung / for vehicles with double disc clutch	(21) (77)
			 3496 006 000		52S,80S Euro5/Euro6 / Euro5/Euro6 langer Bügel / long handle	(21) (86)
			 1863 869 038		52S,80S Euro5/Euro6 / Euro5/Euro6	(21)
			 3189 600 036		für Fahrzeuge mit Zweischeibenkupplung / for vehicles with double disc clutch	(77)
			3189 600 004		Getr. / GBox: ZF AS Tronic Rollenausführung / roller version	(58)

TGS		08.07 -				
18.480 FC, FLC, FLRC, FLLC, FLLRC, FLLW, FLLW/N 10S 15S 06S 03S 18.480 FK, FK-L, FLK, FLK/M 06S 03S 18.480 FLS, FLS/M, FLS-TS, FLRS, FLRS/M, FLLS, FLLS/N, FLLRS 10S 13S 08S 06S 24.480 FNLLW/N 45S 24.480 FPLS, FPLRS 24S	10.07 -	D2676LF07, D2676LF14, D2676LF05, D2676LF25	 3400 700 402  3482 000 246  1878 002 139  3151 000 034	430 10 MFZ430 430WGTZ KZISZ-5	Getr. / GBox: ZF Ecosplit-3 03S,06S,08S,13S / 10S,18S,22S,24S Euro4/Euro5 / Euro4/Euro5 Euro 6 / Euro 6	(20) (18)
	10.07 -		 3400 700 460 HD  3482 000 246  1878 004 104  3151 000 034	430 10 MFZ430 430WGTZ KZISZ-5	Getr. / GBox: ZF Ecosplit-3 03S,06S,08S,13S / 10S,18S,22S,24S Euro4/Euro5 / Euro4/Euro5 Euro 6 / Euro 6	(20) (18)
	10.07 -		 3400 700 459 HD  3482 000 246  1878 004 104  3151 000 493	430 10 MFZ430 430WGTZ KZISZ-5	Getr. / GBox: ZF AS-Tronic 03S,06S,08S,13S / 10S,18S,22S,24S Euro4/Euro5 / Euro4/Euro5 Euro 6 / Euro 6 für Ausrückgabel mit Rollen / for release fork with rollers	(20) (18) (71)
	10.07 -		 3400 700 404  3482 000 246  1878 002 139  3151 000 144	430 10 MFZ430 430WGTZ KZISZ-5	Getr. / GBox: ZF AS-Tronic 03S,06S,08S,13S / 10S,18S,22S,24S Euro4/Euro5 / Euro4/Euro5 Euro 6 / Euro 6 für Ausrückgabel mit Nocken / for release fork with cams	(20) (18) (70)
	10.07 -		 3400 700 327  3482 114 031  1878 004 832  3151 263 031	430 10 GMFZ430N 430WGTZ KZIZ-6	Getr. / GBox: ZF Ecosplit-3 03S,06S,08S,13S / 10S,18S,22S,24S Euro4/Euro5 / Euro4/Euro5 Euro 6 / Euro 6 für Nebenantrieb / for PTO	(20) (18) (82)
	10.07 -		 3400 700 641 HD  3482 114 031  1878 007 729  3151 263 031	430 10 GMFZ430N 430WGTZ KZIZ-6	Getr. / GBox: ZF Ecosplit-3 03S,06S,08S,13S / 10S,18S,22S,24S Euro4/Euro5 / Euro4/Euro5 Euro 6 / Euro 6 Nebenantriebs-ID / PTO ID: NMV 221	(20) (18) (50)
	10.07 -		 3488 017 447	400 MFZ2/400X	Getr. / GBox: ZF Ecosplit-3 03S,06S,08S,13S / 10S,18S,22S,24S Euro4/Euro5 / Euro4/Euro5 Euro 6 / Euro 6 für Fahrzeuge mit Zweischeibenkupplung / for vehicles with double disc clutch enthält eine Kupplungsscheibe / This part number includes one clutch disc	(20) (18) (77) (67)
	10.07 -		 1878 002 643	400 10 400WGTZ	Getr. / GBox: ZF Ecosplit-3 03S,06S,08S,13S / 10S,18S,22S,24S Euro4/Euro5 / Euro4/Euro5 Euro 6 / Euro 6 für Fahrzeuge mit Zweischeibenkupplung / for vehicles with double disc clutch	(20) (18) (77)
	10.07 -		 3151 262 031	KZISZ-5	Getr. / GBox: ZF Ecosplit-3 03S,06S,08S,13S / 10S,18S,22S,24S Euro4/Euro5 / Euro4/Euro5 Euro 6 / Euro 6 für Fahrzeuge mit Zweischeibenkupplung / for vehicles with double disc clutch	(20) (18) (77)
	10.07 -		 3496 006 000		Getr. / GBox: ZF 03S,06S,08S,13S / 10S,18S,22S,24S Euro4/Euro5 / Euro4/Euro5 Euro 6 / Euro 6 langer Bügel / long handle	(20) (18) (86)
	10.07 -		 1863 869 038		Getr. / GBox: ZF 03S,06S,08S,13S / 10S,18S,22S,24S Euro4/Euro5 / Euro4/Euro5 Euro 6 / Euro 6	(20) (18)
	10.07 -		 3189 600 036		für Fahrzeuge mit Zweischeibenkupplung / for vehicles with double disc clutch	(77)
	10.07 -		 3189 600 020		Getr. / GBox: ZF Ecosplit-3	

		CODE				
--	--	------	--	---	---	---











MAN











TGS		08.07 -				
18.540 FAC, FHLC 52S 22S 18.540 FAK, FAK-L, FALK, FALK-L, FHLK, FHLK/M 80S 52S 22S 18.540 FAS, FALS, FHLS, FHLS/M 52S 22S 80S	10.07 -	D2676LF13, D2676LF06	 3400 700 460 HD  3482 000 246  1878 004 104  3151 000 034	430 10 MFZ430 430WGTZ KZISZ-5	Getr. / GBox: ZF Ecosplit 3 52S,80S	
	10.07 -		 3400 700 459 HD  3482 000 246  1878 004 104  3151 000 493	430 10 MFZ430 430WGTZ KZISZ-5	Getr. / GBox: ZF AS-Tronic 52S,80S für Ausrückgabel mit Rollen / for release fork with rollers	(71)
	10.07 -		 3151 000 144	KZISZ-5	Getr. / GBox: ZF AS-Tronic 52S,80S für Ausrückgabel mit Nocken / for release fork with cams	(70)
			 3400 700 327  3482 114 031  1878 004 832  3151 263 031	430 10 GMFZ430N 430WGTZ KZIZ-6	Getr. / GBox: ZF Ecosplit 3 52S,80S für Nebenantrieb / for PTO	(82)
			 3400 700 641 HD  3482 114 031  1878 007 729  3151 263 031	430 10 GMFZ430N 430WGTZ KZIZ-6	Getr. / GBox: ZF Ecosplit 3 52S,80S Nebenantriebs-ID / PTO ID: NMV 221	(50)
			 3488 017 447	400 MFZ2/400X	Getr. / GBox: ZF Ecosplit 3 52S,80S für Fahrzeuge mit Zweischeibenkupplung / for vehicles with double disc clutch enthält eine Kupplungsscheibe / This part number includes one clutch disc	(77) (67)
			 1878 002 643	400 10 400WGTZ	Getr. / GBox: ZF Ecosplit 3 52S,80S für Fahrzeuge mit Zweischeibenkupplung / for vehicles with double disc clutch	(77)
			 3151 262 031	KZISZ-5	Getr. / GBox: ZF Ecosplit 3 52S,80S für Fahrzeuge mit Zweischeibenkupplung / for vehicles with double disc clutch	(77)
			 3496 006 000		52S,80S langer Bügel / long handle	(86)
			 1863 869 038		52S,80S	
			 3189 600 036		für Fahrzeuge mit Zweischeibenkupplung / for vehicles with double disc clutch	(77)
			3189 600 004		Getr. / GBox: ZF AS Tronic Rollenausführung / roller version	(58)

TGS		08.07 -				
18.540 FC, FLC, FLRC, FLLC, FLLRC, FLLW, FLLW/N 10S 03S 06S 18.540 FK, FK-L, FLK, FLK/M 06S 03S 18.540 FLS, FLS/M, FLRS, FLRS/M, FLLS, FLLS/N, FLLRS 06S 10S 08S 24.540 FPLS, FPLRS 24S 26.540 FNLC, FNLCRC, FNLLC, FNLLRC, FNLLW, FVLC, FVL-KO 18S 21S 24S 26.540 FNLC, FNLCRC, FNLLC, FNLLRC, FNLLW, FVLC, FVL-KO 21S 24S 18S 26.540 FNLS, FNLLS, FPLS, FPLRS, FVLS, FNLRS, FNLS 18S 21S 24S 26.540 FNLS, FNLLS, FPLS, FPLRS, FVLS, FNLRS, FNLS 21S 18S 24S 26.540 FVL-KO 24S	10.07 -	D2676LF13EUR O5	 3400 700 402  3482 000 246  1878 002 139  3151 000 034	430 10 MFZ430 430WGTZ KZISZ-5	Getr. / GBox: ZF Ecosplit-3 03S,06S,08S,10S / 18S,22S,24S	
	10.07 -		 3400 700 460 HD  3482 000 246  1878 004 104  3151 000 034	430 10 MFZ430 430WGTZ KZISZ-5	Getr. / GBox: ZF Ecosplit-3 03S,06S,08S,10S / 18S,22S,24S	
	10.07 -		 3400 700 459 HD  3482 000 246  1878 004 104  3151 000 493	430 10 MFZ430 430WGTZ KZISZ-5	Getr. / GBox: ZF AS-Tronic 03S,06S,08S,10S / 18S,22S,24S für Ausrückgabel mit Rollen / for release fork with rollers	(71)
	10.07 -		 3400 700 404  3482 000 246  1878 002 139  3151 000 144	430 10 MFZ430 430WGTZ KZISZ-5	Getr. / GBox: ZF AS-Tronic 03S,06S,08S,10S / 18S,22S,24S für Ausrückgabel mit Nocken / for release fork with cams	(70)
	10.07 -		 3400 700 327  3482 114 031  1878 004 832  3151 263 031	430 10 GMFZ430N 430WGTZ KZIZ-6	Getr. / GBox: ZF Ecosplit-3 03S,06S,08S,10S / 18S,22S,24S für Nebenantrieb / for PTO	(82)
	02.09 -		 3400 700 641 HD  3482 114 031  1878 007 729  3151 263 031	430 10 GMFZ430N 430WGTZ KZIZ-6	Getr. / GBox: ZF Ecosplit-3 03S,06S,08S,10S / 18S,22S,24S Nebenantriebs-ID / PTO ID: NMV 221	(50)
	10.07 -		 3488 017 447	400 MFZ2/400X	Getr. / GBox: ZF Ecosplit-3 03S,06S,08S,10S / 18S,22S,24S für Fahrzeuge mit Zweischeibenkupplung / for vehicles with double disc clutch enthält eine Kupplungsscheibe / This part number includes one clutch disc	(77) (67)
			 1878 002 643	400 10 400WGTZ	Getr. / GBox: ZF Ecosplit-3 03S,06S,08S,10S / 18S,22S,24S für Fahrzeuge mit Zweischeibenkupplung / for vehicles with double disc clutch	(77)
			 3151 262 031	KZISZ-5	Getr. / GBox: ZF Ecosplit-3 03S,06S,08S,10S / 18S,22S,24S für Fahrzeuge mit Zweischeibenkupplung / for vehicles with double disc clutch	(77)
			 3496 006 000		Getr. / GBox: ZF 03S,06S,08S,10S / 18S,22S,24S langer Bügel / long handle	(86)
			 1863 869 038		Getr. / GBox: ZF 03S,06S,08S,10S / 18S,22S,24S	
			 3189 600 036		für Fahrzeuge mit Zweischeibenkupplung / for vehicles with double disc clutch	(77)
			 3189 600 020		Getr. / GBox: ZF Ecosplit-3	

		CODE				
--	--	------	--	---	---	---























MAN

TGS		08.07 -				
19.350 FLRS, FLS, FRS, FS 06W 71W 03W 72W	10.07-	D2066LF03, D2066LF63, D2066LF02, D2066LF07, D2066LF01, D2066LF62, D2066LF48, D2066LF50, D2066LF06, D2066LF64, D2066LF49	 3400 700 380 ⊗ 3482 000 361 ⊗ 1878 080 037 ⊙ 3151 000 034	430 10 MFZ430 430WGTZ KZISZ-5	Getr. / GBox: ZF Ecosplit 3	
19.360 FS, FLS, FRS, FLRS 06W 71W 72W 03W	02.11-		 3400 700 381 ⊗ 3482 000 361 ⊗ 1878 080 037 ⊙ 3151 000 493	430 10 MFZ430 430WGTZ KZISZ-5	Getr. / GBox: ZF AS-Tronic für Ausrückgabel mit Rollen / for release fork with rollers	(71)
19.390 FLRS, FLS, FRS, FS 71W 72W 06W 03W	06.08-		 3400 700 327 ⊗ 3482 114 031 ⊗ 1878 004 832 ⊙ 3151 263 031	430 10 GMFZ430N 430WGTZ KZIZ-6	Getr. / GBox: ZF Ecosplit 3 für Nebenantrieb / for PTO	(82)
19.400 FS/M-WW, FLS/M-WW, FRS/M-WW, FLRS/M-WW 71W 06W 72W 03W	02.11-		 3400 700 641 HD ⊗ 3482 114 031 ⊗ 1878 007 729 ⊙ 3151 263 031	430 10 GMFZ430N 430WGTZ KZIZ-6	Getr. / GBox: ZF Ecosplit 3 Nebenantriebs-ID / PTO ID: NMV 221	(50)
19.430 FLRS, FLS, FRS, FS 06W 71W 72W 03W	10.07-		 3488 017 447	400 MFZ2/400X	Getr. / GBox: ZF Ecosplit 3 für Fahrzeuge mit Zweischeibenkupplung / for vehicles with double disc clutch enthält eine Kupplungsscheibe / This part number includes one clutch disc	(77) (67)
19.440 FS-WW, FRS-WW, FLS- WW, FLRS-WW 06W 71W 72W 03W	02.11-		 1878 002 643	400 10 400WGTZ	Getr. / GBox: ZF Ecosplit 3 für Fahrzeuge mit Zweischeibenkupplung / for vehicles with double disc clutch	(77)
21.360 FS, FLS 06W 72W 03W 71W	10.07-		 3151 262 031	KZISZ-5	Getr. / GBox: ZF Ecosplit 3 für Fahrzeuge mit Zweischeibenkupplung / for vehicles with double disc clutch	(77)
21.400 FS, FLS 72W 71W 03W 06W	10.07-		 3496 006 000		langer Bügel / long handle	(86)
21.440 FS, FLS 06W 72W 03W 71W	10.07-		 1863 869 038			
26.350 FDLR, FDLRC 78W	10.07-		 3189 600 036		für Fahrzeuge mit Zweischeibenkupplung / for vehicles with double disc clutch	(77)
26.350 FDLR, FDLRS 30W 78W	10.07-		3189 600 004		Getr. / GBox: ZF AS Tronic Rollenausführung / roller version	(58)
26.350 FNL, FNLRC 18W	10.07-		3189 600 020		Getr. / GBox: ZF Ecosplit-3	
26.350 FNLS, FNLRS 18W	10.07-					
26.390 FDLR, FDLRC 78W	06.08-					
26.390 FDLR, FDLRS 78W 30W	06.08-					
26.390 FNL, FNLRC 18W	06.08-					
26.390 FNLS, FNLRS 18W	06.08-					
26.430 FDLR, FDLRC 78W	10.07-					
26.430 FDLR, FDLRS 30W 78W	10.07-					
26.430 FNL, FNLRC 18W	10.07-					
26.430 FNLS, FNLRS 18W	10.07-					
28.350 FNLLC, FNL, FNLRC 73W 19W	08.08-					
28.350 FNLR, FNLS 19W 73W	08.08-					
28.390 FNL, FNLRC 73W 19W	06.08-					
28.390 FNLS, FNLRS 19W 73W	06.08-					
28.430 FNL, FNLRC 73W 19W	08.08-					
28.430 FNLS, FNLRS 19W 73W	08.08-					
33.350 FDC, FDLR, FDR, FDR 26W 76W	06.08-					
33.350 FDC-TM, FDR-TM 26W	06.08-					
33.350 FDK, FDRK 26W 76W	06.08-					
33.350 FDLR, FDRS, FDS 76W 30W 26W	06.08-					
33.390 FDC, FDR, FDR 26W 76W	06.08-					
33.390 FDC-TM, FDR-TM 26W	06.08-					
33.390 FDK, FDRK 76W 26W	06.08-					
33.390 FDLR, FDRS, FDS 30W 26W 76W	06.08-					

TGS		08.07 -					
33.400 FDC-TM, FDRC-TM 26W	07.08-	D2066LF03, D2066LF63, D2066LF02, D2066LF07, D2066LF01, D2066LF62, D2066LF48, D2066LF50, D2066LF06, D2066LF64, D2066LF49		3400 700 380 ⊗ 3482 000 361 ⊗ 1878 080 037 ⊙ 3151 000 034	430 10 MFZ430 430WGTZ KZISZ-5	Getr. / GBox: ZF Ecosplit 3	
33.430 FDC, FDLC, FDR, FDRC 26W 76W	06.08-			3400 700 381 ⊗ 3482 000 361 ⊗ 1878 080 037 ⊙ 3151 000 493	430 10 MFZ430 430WGTZ KZISZ-5	Getr. / GBox: ZF AS-Tronic für Ausrückgabel mit Rollen / for release fork with rollers	(71)
33.430 FDC-TM, FDRC-TM 26W	06.08-			3400 700 327 ⊗ 3482 114 031 ⊗ 1878 004 832 ⊙ 3151 263 031	430 10 GMFZ430N 430WGTZ KZIZ-6	Getr. / GBox: ZF Ecosplit 3 für Nebenantrieb / for PTO	(82)
33.430 FDK, FDRK 76W 26W	06.08-			3400 700 641 HD ⊗ 3482 114 031 ⊗ 1878 007 729 ⊙ 3151 263 031	430 10 GMFZ430N 430WGTZ KZIZ-6	Getr. / GBox: ZF Ecosplit 3 Nebenantriebs-ID / PTO ID: NMV 221	(50)
33.430 FDLS, FDRS, FDS 76W 30W 26W	06.08-			3488 017 447	400 MFZ2/400X	Getr. / GBox: ZF Ecosplit 3 für Fahrzeuge mit Zweischeibenkupplung / for vehicles with double disc clutch enthält eine Kupplungsscheibe / This part number includes one clutch disc	(77) (67)
40.360 FDAK, FDARK 58W	06.08-			1878 002 643	400 10 400WGTZ	Getr. / GBox: ZF Ecosplit 3 für Fahrzeuge mit Zweischeibenkupplung / for vehicles with double disc clutch	(77)
40.360 FDAS, FDARS 58W	10.07-			3151 262 031	KZISZ-5	Getr. / GBox: ZF Ecosplit 3 für Fahrzeuge mit Zweischeibenkupplung / for vehicles with double disc clutch	(77)
40.390 FDAK, FDARK 58W	10.07-			3496 006 000		langer Bügel / long handle	(86)
40.390 FDAS, FDARS 58W	10.07-			1863 869 038			
40.400 FDAK-WW, FDARK- WW 58W	02.11-			3189 600 036		für Fahrzeuge mit Zweischeibenkupplung / for vehicles with double disc clutch	(77)
40.400 FDAS-WW, FDARS-WW 58W	02.11-			3189 600 004		Getr. / GBox: ZF AS Tronic Rollenausführung / roller version	(58)
40.430 FDAK, FDARK 58W	06.08-			3189 600 020		Getr. / GBox: ZF Ecosplit-3	
40.430 FDAS, FDARS 58W	06.08-						
40.440 FDAK-WW, FDARK- WW 58W	02.11-						
40.440 FDAS-WW, FDARS-WW 58W	02.11-						
41.350 FFDC, FFDRK 39W	06.08-						
41.350 FFDC-TM, FFDRK-TM 39W	06.08-						
41.350 FFDC, FFDRK 39W	06.08-						
41.390 FFDC, FFDRK 39W	06.08-						
41.390 FFDC-TM, FFDRK-TM 39W	06.08-						
41.430 FFDC, FFDRK 39W	10.07-						
41.430 FFDC-TM, FFDRK-TM 39W	10.07-						
41.430 FFDC, FFDRK 39W	10.07-						



























		CODE				
--	--	------	--	---	---	---

MAN

TGS		08.07 -					
19.440 FS-WW, FRS-WW, FLS-WW, FLRS-WW 03W 06W 72W 71W 19.480 FS/M-WW, FRS/M-WW, FLS/M-WW, FLRS/M-WW 72W 03W 06W 71W 21.440 FS, FLS 71W 03W 06W 72W 21.480 FS, FLS 72W 03W 06W 71W 33.440 FDC-TM, FDRC-TM 26W 40.440 FDAK-WW, FDARK-WW 58W 40.440 FDAS-WW, FDARS-WW 58W 40.480 FDAK, FDARK 58W 40.480 FDAS, FDARS 58W	02.11-	D2676LF04, D2676LF20, D2676LF31, D2676LF02, D2676LF03	 3400 700 460 HD  3482 000 246  1878 004 104  3151 000 034	430 10 MFZ430 430WGTZ KZISZ-5	Getr. / GBox: ZF Ecosplit 3		
		02.11-		 3400 700 459 HD  3482 000 246  1878 004 104  3151 000 493	430 10 MFZ430 430WGTZ KZISZ-5	Getr. / GBox: ZF AS-Tronic für Ausrückgabel mit Rollen / for release fork with rollers	(71)
		10.07-		 3400 700 327  3482 114 031  1878 004 832  3151 263 031	430 10 GMFZ430N 430WGTZ KZIZ-6	Getr. / GBox: ZF Ecosplit 3 für Nebenantrieb / for PTO	(82)
		10.07-		 3400 700 641 HD  3482 114 031  1878 007 729  3151 263 031	430 10 GMFZ430N 430WGTZ KZIZ-6	Getr. / GBox: ZF Ecosplit 3 Nebenantriebs-ID / PTO ID: NMV 221	(50)
		02.11-		 3488 017 447	400 MFZ2/400X	Getr. / GBox: ZF Ecosplit 3 für Fahrzeuge mit Zweischeibenkupplung / for vehicles with double disc clutch	(77)
		06.08-		 1878 002 643	400 10 400WGTZ	enthält eine Kupplungsscheibe / This part number includes one clutch disc	(67)
		06.08-		 3151 262 031	KZISZ-5	Getr. / GBox: ZF Ecosplit 3 für Fahrzeuge mit Zweischeibenkupplung / for vehicles with double disc clutch	(77)
				 3496 006 000		langer Bügel / long handle	(86)
				 1863 869 038			
				 3189 600 036		für Fahrzeuge mit Zweischeibenkupplung / for vehicles with double disc clutch	(77)
				3189 600 004		Getr. / GBox: ZF AS Tronic Rollenausführung / roller version	(58)
				3189 600 020		Getr. / GBox: ZF Ecosplit-3	











		CODE				
--	--	------	--	---	---	---













MAN

TGS		08.07 -						
24.320 FNLLW/N 45S 24.320 FPLS, FPLRS 24S 24.360 FNLLW/N 45S 24.400 FNLLW/N 45S 26.400 FNLS, FNLRS, FNLLS, FNLLRS, FPLS, FPLRS, FVLS 21S 18W 18S 24S	10.07-	D2066LF37, D2066LF27, D2066LF42, D2066LF28, 24S		3400 700 380  3482 000 361  1878 080 037  3151 000 034	430 10 MFZ430 430WGTZ KZISZ-5	Getr. / GBox: ZF Ecosplit-3 21S,42S,45S Euro5/Euro6 / Euro5/Euro6 Euro 6 / Euro 6	(21) (18)	
	10.07-	D2066LF43, D2066LF41, D2066LF63, D2066LF39, D2066LF26,		3400 700 381  3482 000 361  1878 080 037  3151 000 493	430 10 MFZ430 430WGTZ KZISZ-5	Getr. / GBox: ZF AS-Tronic 21S,42S,45S Euro5/Euro6 / Euro5/Euro6 Euro 6 / Euro 6 für Ausrückgabel mit Rollen / for release fork with rollers	(21) (18) (71)	
	02.09-	D2066LF53, D2066LF61, D2066LF68, D2066LF67, D2066LF51, D2066LF49, D2066LF38		3400 700 403  3482 000 361  1878 004 832  3151 000 144	430 10 MFZ430 430WGTZ KZISZ-5	Getr. / GBox: ZF AS-Tronic 21S,42S,45S Euro5/Euro6 / Euro5/Euro6 Euro 6 / Euro 6 für Ausrückgabel mit Nocken / for release fork with cams	(21) (18) (70)	
					3400 700 327  3482 114 031  1878 004 832  3151 263 031	430 10 GMFZ430N 430WGTZ KZIZ-6	Getr. / GBox: ZF Ecosplit-3 21S,42S,45S Euro5/Euro6 / Euro5/Euro6 Euro 6 / Euro 6 für Nebenantrieb / for PTO	(21) (18) (82)
					3400 700 641 HD  3482 114 031  1878 007 729  3151 263 031	430 10 GMFZ430N 430WGTZ KZIZ-6	Getr. / GBox: ZF Ecosplit-3 21S,42S,45S Euro5/Euro6 / Euro5/Euro6 Euro 6 / Euro 6 Nebenantriebs-ID / PTO ID: NMV 221	(21) (18) (50)
					3488 017 447	400 MFZ2/400X	Getr. / GBox: ZF Ecosplit-3 21S,42S,45S Euro5/Euro6 / Euro5/Euro6 Euro 6 / Euro 6 für Fahrzeuge mit Zweischeibenkupplung / for vehicles with double disc clutch enthält eine Kupplungsscheibe / This part number includes one clutch disc	(21) (18) (77) (67)
					1878 002 643	400 10 400WGTZ	Getr. / GBox: ZF Ecosplit-3 21S,42S,45S Euro5/Euro6 / Euro5/Euro6 Euro 6 / Euro 6 für Fahrzeuge mit Zweischeibenkupplung / for vehicles with double disc clutch	(21) (18) (77)
					3151 262 031	KZISZ-5	Getr. / GBox: ZF Ecosplit-3 21S,42S,45S Euro5/Euro6 / Euro5/Euro6 Euro 6 / Euro 6 für Fahrzeuge mit Zweischeibenkupplung / for vehicles with double disc clutch	(21) (18) (77)
					3496 006 000		Getr. / GBox: ZF 21S,42S,45S Euro5/Euro6 / Euro5/Euro6 Euro 6 / Euro 6 langer Bügel / long handle	(21) (18) (86)
					1863 869 038		Getr. / GBox: ZF 21S,42S,45S Euro5/Euro6 / Euro5/Euro6 Euro 6 / Euro 6	(21) (18)
					3189 600 036		für Fahrzeuge mit Zweischeibenkupplung / for vehicles with double disc clutch	(77)
					3189 600 004		Getr. / GBox: ZF AS Tronic Rollenausführung / roller version	(58)
					3189 600 020		Getr. / GBox: ZF Ecosplit-3	

		CODE				
--	--	------	--	---	---	---





























MAN

TGS		08.07 -				
24.360 FPLS, FPLRS 24S	10.07-	D2066LF42, D2066LF27, D2066LF43, D2066LF28, 24S	 3400 700 380 ⊗ 3482 000 361 ⊗ 1878 080 037 ⊙ 3151 000 034	430 10 MFZ430 430WGTZ KZISZ-5	Getr. / GBox: ZF Ecosplit-3 06S,10S,18S,22S,24S Euro4/Euro5 / Euro4/Euro5 Euro 6 / Euro 6	(20) (18)
24.400 FPLS, FPLRS 24S	10.07-	D2066LF37, D2066LF39, D2066LF41, D2066LF53, D2066LF26, 24S	 3400 700 381 ⊗ 3482 000 361 ⊗ 1878 080 037 ⊙ 3151 000 493	430 10 MFZ430 430WGTZ KZISZ-5	Getr. / GBox: ZF AS-Tronic 06S,10S,18S,22S,24S für Ausrückgabel mit Rollen / for release fork with rollers	(71)
26.320 FNLC, FNLRC, FNLLC, FNLLRC, FNLLW, FVLC, FVL- KO 21S 18S 24S	07.08-	D2066LF52, D2066LF48, D2066LF68, D2066LF26, 24S	 3400 700 403 ⊗ 3482 000 361 ⊗ 1878 004 832 ⊙ 3151 000 144	430 10 MFZ430 430WGTZ KZISZ-5	Getr. / GBox: ZF AS-Tronic 06S,10S,18S,22S,24S für Ausrückgabel mit Nocken / for release fork with cams	(70)
26.320 FNLS, FNLRS, FNLLS, FPLS, FVLS, FPLRS 24S 18S 21S	10.07-	D2066LF61, D2066LF64, D2066LF67, D2066LF38	 3400 700 327 ⊗ 3482 114 031 ⊗ 1878 004 832 ⊙ 3151 263 031	430 10 GMFZ430N 430WGTZ KZIZ-6	Getr. / GBox: ZF Ecosplit-3 06S,10S,18S,22S,24S für Nebenantrieb / for PTO	(82)
26.360 FNLC, FNLRC, FNLLC, FNLLRC, FVLC, FVL-KO 21S 18S 24S 18W	08.08-		 3400 700 641 HD ⊗ 3482 114 031 ⊗ 1878 007 729 ⊙ 3151 263 031	430 10 GMFZ430N 430WGTZ KZIZ-6	Getr. / GBox: ZF Ecosplit-3 06S,10S,18S,22S,24S Nebenantriebs-ID / PTO ID: NMV 221	(50)
26.360 FNLS, FNLLS, FNLRS, FPLS, FPLRS, FVLS 18S 18W 21S 24S			 3488 017 447	400 MFZ2/400X	Getr. / GBox: ZF Ecosplit-3 06S,10S,18S,22S,24S für Fahrzeuge mit Zweischeibenkupplung / for vehicles with double disc clutch enthält eine Kupplungsscheibe / This part number includes one clutch disc	(77) (67)
			 1878 002 643	400 10 400WGTZ	Getr. / GBox: ZF Ecosplit-3 06S,10S,18S,22S,24S für Fahrzeuge mit Zweischeibenkupplung / for vehicles with double disc clutch	(77)
			 3151 262 031	KZISZ-5	Getr. / GBox: ZF Ecosplit-3 06S,10S,18S,22S,24S für Fahrzeuge mit Zweischeibenkupplung / for vehicles with double disc clutch	(77)
			 3496 006 000		Getr. / GBox: ZF 06S,10S,18S,22S,24S langer Bügel / long handle	(86)
			 1863 869 038		Getr. / GBox: ZF 06S,10S,18S,22S,24S	
			 3189 600 036		für Fahrzeuge mit Zweischeibenkupplung / for vehicles with double disc clutch	(77)
			3189 600 004		Getr. / GBox: ZF AS Tronic Rollenausführung / roller version	(58)
			3189 600 020		Getr. / GBox: ZF Ecosplit-3	

TGS		08.07 -					
24.440 FNLLW/N 45S 26.440 FNLC, FNLLC, FNLLW, FNLRC, FNLLRC, FVLC, FVL- KO 24S 21S 18W 18S 26.440 FNLS, FNLLS, FNLRS, FPLS, FPLRS, FVLS 18S 18W 21S 24S	10.07 -	D2066LF25EUR	 3400 700 402 ⊗ 3482 000 246 ⊗ 1878 002 139 ⊙ 3151 000 034	430 10 MFZ430 430WGTZ KZISZ-5	Getr. / GBox: ZF Ecosplit-3 18S,22S,24S,45S		
	10.07 -	D2066LF36EUR O4	 3400 700 460 HD ⊗ 3482 000 246 ⊗ 1878 004 104 ⊙ 3151 000 034	430 10 MFZ430 430WGTZ KZISZ-5	Getr. / GBox: ZF Ecosplit-3		
	02.09 -		 3400 700 381 ⊗ 3482 000 361 ⊗ 1878 080 037 ⊙ 3151 000 493	430 10 MFZ430 430WGTZ KZISZ-5	Getr. / GBox: ZF AS-Tronic für Ausrückgabel mit Rollen / for release fork with rollers	(71)	
			 3400 700 403 ⊗ 3482 000 361 ⊗ 1878 004 832 ⊙ 3151 000 144	430 10 MFZ430 430WGTZ KZISZ-5	Getr. / GBox: ZF AS-Tronic für Ausrückgabel mit Nocken / for release fork with cams	(70)	
			 3400 700 327 ⊗ 3482 114 031 ⊗ 1878 004 832 ⊙ 3151 263 031	430 10 GMFZ430N 430WGTZ KZIZ-6	Getr. / GBox: ZF Ecosplit-3 für Nebenantrieb / for PTO	(82)	
			 3400 700 641 HD ⊗ 3482 114 031 ⊗ 1878 007 729 ⊙ 3151 263 031	430 10 GMFZ430N 430WGTZ KZIZ-6	Getr. / GBox: ZF Ecosplit-3 Nebenantriebs-ID / PTO ID: NMV 221	(50)	
			 3488 017 447	400 MFZ2/400X	Getr. / GBox: ZF Ecosplit-3 für Fahrzeuge mit Zweischeibenkupplung / for vehicles with double disc clutch	(77)	
			 1878 002 643	400 10 400WGTZ	Getr. / GBox: ZF Ecosplit-3 für Fahrzeuge mit Zweischeibenkupplung / for vehicles with double disc clutch	(77)	
			 3151 262 031	KZISZ-5	Getr. / GBox: ZF Ecosplit-3 für Fahrzeuge mit Zweischeibenkupplung / for vehicles with double disc clutch	(77)	
			 3496 006 000		Getr. / GBox: ZF langer Bügel / long handle	(86)	
			 1863 869 038		Getr. / GBox: ZF		
			D2066LF25, D2066LF36, D2066LF62, D2066LF40, D2066LF50	 3189 600 004		Getr. / GBox: ZF AS Tronic Rollenausführung / roller version	(58)
				3189 600 020		Getr. / GBox: ZF Ecosplit-3	
				3189 600 036		für Fahrzeuge mit Zweischeibenkupplung / for vehicles with double disc clutch	(77)













		CODE				
--	--	------	--	---	---	---

MAN

TGS		08.07 -				
26.320 FDAC, FDALC, FDHLC, FDHLC/M 70S 82S 56S	07.08-	D2066LF37, D2066LF42, D2066LF27, D2066LF43, D2066LF28, D2066LF41, D2066LF63, D2066LF39, D2066LF26, D2066LF07, D2066LF53, D2066LF48, D2066LF61, D2066LF68, D2066LF06, D2066LF64, D2066LF67, D2066LF51, D2066LF49, D2066LF38	 3400 700 380  3482 000 361  1878 080 037  3151 000 034	430 10 MFZ430 430WGTZ KZISZ-5	Getr. / GBox: ZF Ecosplit-3 56S,70S,82S Euro5/Euro6 / Euro5/Euro6	(21)
26.320 FDAK, FDALK, FDHK, FDHLK 56S 47S 70S 82S	07.08-		 3400 700 381  3482 000 361  1878 080 037  3151 000 493	430 10 MFZ430 430WGTZ KZISZ-5	Getr. / GBox: ZF AS-Tronic 56S,70S,82S Euro5/Euro6 / Euro5/Euro6 für Ausrückgabel mit Rollen / for release fork with rollers	(21) (71)
26.320 FDAS, FDALS, FDHS, FDHLS, FDHLS/M 82S 56S 47S 70S	07.08-		 3400 700 403  3482 000 361  1878 004 832  3151 000 144	430 10 MFZ430 430WGTZ KZISZ-5	Getr. / GBox: ZF AS-Tronic 56S,70S,82S Euro5/Euro6 / Euro5/Euro6 für Ausrückgabel mit Nocken / for release fork with cams	(21) (70)
26.320 FNLC, FNLRC, FNLLC, FNLLRC, FNLLW, FVLC, FVL-KO 21S 18S 24S	10.07-		 3400 700 327  3482 114 031  1878 004 832  3151 263 031	430 10 GMFZ430N 430WGTZ KZIZ-6	Getr. / GBox: ZF Ecosplit-3 56S,70S,82S Euro5/Euro6 / Euro5/Euro6 für Nebenantrieb / for PTO	(21) (82)
26.320 FNLS, FNLRS, FNLLS, FPLS, FPLRS 24S 21S 18S	07.08-		 3400 700 641 HD  3482 114 031  1878 007 729  3151 263 031	430 10 GMFZ430N 430WGTZ KZIZ-6	Getr. / GBox: ZF Ecosplit-3 56S,70S,82S Euro5/Euro6 / Euro5/Euro6 Nebenantriebs-ID / PTO ID: NMV 221	(21) (50)
26.360 FDAC, FDALC, FDHLC, FDHLC/M 70S 56S 82S	08.08-		 3488 017 447	400 MFZ2/400X	Getr. / GBox: ZF Ecosplit-3 56S,70S,82S Euro5/Euro6 / Euro5/Euro6 für Fahrzeuge mit Zweischeibenkupplung / for vehicles with double disc clutch enthält eine Kupplungsscheibe / This part number includes one clutch disc	(21) (77) (67)
26.360 FDAK, FDALK, FDHK, FDHLK 70S 82S 47S 56S	08.08-		 1878 002 643	400 10 400WGTZ	Getr. / GBox: ZF Ecosplit-3 56S,70S,82S Euro5/Euro6 / Euro5/Euro6 für Fahrzeuge mit Zweischeibenkupplung / for vehicles with double disc clutch	(21) (77)
26.360 FDAS, FDALS, FDHS, FDHLS, FDHLS/M 56S 70S 47S 82S	08.08-		 3151 262 031	KZISZ-5	Getr. / GBox: ZF Ecosplit-3 56S,70S,82S Euro5/Euro6 / Euro5/Euro6 für Fahrzeuge mit Zweischeibenkupplung / for vehicles with double disc clutch	(21) (77)
26.400 47S 70S 82S 56S	11.07-		 3496 006 000		Getr. / GBox: ZF 56S,70S,82S Euro5/Euro6 / Euro5/Euro6 langer Bügel / long handle	(21) (86)
26.400 FDAC, FDALC, FDHLC, FDHLC/M 70S 56S 82S	02.09-		 1863 869 038		Getr. / GBox: ZF 56S,70S,82S Euro5/Euro6 / Euro5/Euro6	(21)
26.400 FDAK, FDALK, FDHLK, FDHK 47S 82S 56S 70S	02.09-		 3189 600 036		für Fahrzeuge mit Zweischeibenkupplung / for vehicles with double disc clutch	(77)
26.400 FDAS, FDALS, FDHS, FDHLS, FDHLS/M 70S 56S 82S 47S	09.07-		 3189 600 004		Getr. / GBox: ZF AS Tronic Rollenausführung / roller version	(58)
26.400 FNLC, FNLRC, FNLLC, FNLLRC, FVLC, FVL-KO, FNLLW 21S 24S 18S	10.07-		 3189 600 020		Getr. / GBox: ZF Ecosplit-3	
26.400 FNLS, FNLRS, FNLLS, FNLLRS, FPLS, FPLRS, FVLS 21S 18W 24S 18S	02.09-					
33.360 FDAC, FDALC, FDARC 56W 82S 56S	06.08-					
33.360 FDAK, FDALK, FDHK, FDARK 47S 56W 82S 56S	10.07-					
33.360 FDAS, FDALS, FDHS, FDARS 47S 82S 56S 56W	10.07-					
33.400 FDAC, FDALC, FDARC 56S 56W 82S	07.08-					
33.400 FDAK, FDALK, FDHK, FDARK 56S 56W 47S 82S	07.08-					
33.400 FDAS, FDALS, FDHS, FDARS 82S 56S 47S 56W	07.08-					











		CODE				
--	--	------	--	---	---	---











MAN

TGS		08.07 -				
26.320 FDC, FDRC, FDLC, FDLC/M, FDLRC, FDLRC/M, FNHLC, FVHLC 26S 35S 30S 42S	07.08-	D2066LF42, D2066LF37, D2066LF27, D2066LF43, D2066LF41, D2066LF39, D2066LF63, D2066LF07, D2066LF48, D2066LF52, D2066LF61, D2066LF68, D2066LF64, D2066LF67, D2066LF06, D2066LF38, D2066LF49	 3400 700 380 ⊕ 3482 000 361 ⊕ 1878 080 037 ⊕ 3151 000 034	430 10 MFZ430 430WGTZ KZISZ-5	Getr. / GBox: ZF Ecosplit-3 26S,30S,35S Euro4/Euro5 / Euro4/Euro5 Euro 6 / Euro 6	(20) (18)
	26.320 FDK, FDLK 26S 30S		07.08-	 3400 700 381 ⊕ 3482 000 361 ⊕ 1878 080 037 ⊕ 3151 000 493	430 10 MFZ430 430WGTZ KZISZ-5	Getr. / GBox: ZF AS-Tronic 26S,30S,35S Euro4/Euro5 / Euro4/Euro5 Euro 6 / Euro 6 für Ausrückgabel mit Rollen / for release fork with rollers
26.320 FDS, FDLS, FDRS, FDLRS, FNHLS, FPHLS, FVHLS 26S 30S 35S	07.08-		 3400 700 403 ⊕ 3482 000 361 ⊕ 1878 004 832 ⊕ 3151 000 144	430 10 MFZ430 430WGTZ KZISZ-5	Getr. / GBox: ZF AS-Tronic 26S,30S,35S Euro4/Euro5 / Euro4/Euro5 Euro 6 / Euro 6 für Ausrückgabel mit Nocken / for release fork with cams	(20) (18) (70)
26.320 FD-TM 26S	07.08-		 3400 700 327 ⊕ 3482 114 031 ⊕ 1878 004 832 ⊕ 3151 263 031	430 10 GMFZ430N 430WGTZ KZIZ-6	Getr. / GBox: ZF Ecosplit-3 26S,30S,35S Euro4/Euro5 / Euro4/Euro5 Euro 6 / Euro 6 für Nebenantrieb / for PTO	(20) (18) (82)
26.360 FDC, FDRC, FDRC/M, FDLC, FDLRC, FNHLC 42S 26S 30S 35S	08.08-		 3400 700 641 HD ⊕ 3482 114 031 ⊕ 1878 007 729 ⊕ 3151 263 031	430 10 GMFZ430N 430WGTZ KZIZ-6	Getr. / GBox: ZF Ecosplit-3 26S,30S,35S Euro4/Euro5 / Euro4/Euro5 Euro 6 / Euro 6 Nebenantriebs-ID / PTO ID: NMV 221	(20) (18) (50)
26.360 FDK, FDLK, FDRK 30S 26S	08.08-		 3488 017 447	400 MFZ2/400X	Getr. / GBox: ZF Ecosplit-3 26S,30S,35S Euro4/Euro5 / Euro4/Euro5 Euro 6 / Euro 6 für Fahrzeuge mit Zweis Scheibenkupplung / for vehicles with double disc clutch enthält eine Kupplungsscheibe / This part number includes one clutch disc	(20) (18) (77) (67)
26.360 FDS, FDRS, FDLS, FDLRS, FNHLS, FPHLS, FVHLS 42S 30S 78W 35S 26S 30W	08.08-		 1878 002 643	400 10 400WGTZ	Getr. / GBox: ZF Ecosplit-3 26S,30S,35S Euro4/Euro5 / Euro4/Euro5 Euro 6 / Euro 6 für Fahrzeuge mit Zweis Scheibenkupplung / for vehicles with double disc clutch	(20) (18) (77)
26.360 FD-TM 26S	07.08-		 3151 262 031	KZISZ-5	Getr. / GBox: ZF Ecosplit-3 26S,30S,35S Euro4/Euro5 / Euro4/Euro5 Euro 6 / Euro 6 für Fahrzeuge mit Zweis Scheibenkupplung / for vehicles with double disc clutch	(20) (18) (77)
26.400 FDC, FDRC, FDC/M, FDLC, FDLC/M, FDLRC, FDLRC/M, FNHLC 30S 78W 35S 42S 26S	06.08-		 3496 006 000		Getr. / GBox: ZF 26S,30S,35S Euro4/Euro5 / Euro4/Euro5 Euro 6 / Euro 6 langer Bügel / long handle	(20) (18) (86)
26.400 FDK, FDLK 30S 26S	02.09-		 1863 869 038		Getr. / GBox: ZF 26S,30S,35S Euro4/Euro5 / Euro4/Euro5 Euro 6 / Euro 6	(20) (18)
26.400 FDS, FDLS, FDRS, FDLRS, FNHLS, FPHLS, FVHLS 78W 26S 30S 30W 35S 42S	06.08-		 3189 600 036		für Fahrzeuge mit Zweis Scheibenkupplung / for vehicles with double disc clutch	(77)
26.400 FD-TM 26S	07.08-		 3189 600 004		Getr. / GBox: ZF AS Tronic Rollenausführung / roller version	(58)
33.360 FDC, FDLC, FDLRC, FDR, FDRC 30S 76W 26S 26W	07.08-		 3189 600 020		Getr. / GBox: ZF Ecosplit-3	

		CODE				
--	--	------	--	---	---	---













MAN















TGS		08.07 -					
26.320 FVHLC 42S	10.07-	D2066LF37, D2066LF42,	 3400 700 380 ⊗ 3482 000 361 ⊗ 1878 080 037 ⊙ 3151 000 034	430 10 MFZ430 430WGTZ KZISZ-5	Getr. / GBox: ZF Ecosplit-3		
26.320 FVL-KO 24S	10.07-	D2066LF27, D2066LF28, D2066LF39, D2066LF41,	 3400 700 381 ⊗ 3482 000 361 ⊗ 1878 080 037 ⊙ 3151 000 493	430 10 MFZ430 430WGTZ KZISZ-5	Getr. / GBox: ZF AS-Tronic für Ausrückgabel mit Rollen / for release fork with rollers	(71)	
26.360 FNLLW 21S	04.08-	D2066LF26, D2066LF61, D2066LF67, D2066LF38	 3400 700 403 ⊗ 3482 000 361 ⊗ 1878 004 832 ⊙ 3151 000 144	430 10 MFZ430 430WGTZ KZISZ-5	Getr. / GBox: ZF AS-Tronic für Ausrückgabel mit Nocken / for release fork with cams	(70)	
26.360 FPHLS 42S	05.08-		 3400 700 327 ⊗ 3482 114 031 ⊗ 1878 004 832 ⊙ 3151 263 031	430 10 GMFZ430N 430WGTZ KZISZ-6	Getr. / GBox: ZF Ecosplit-3 für Nebenantrieb / for PTO	(82)	
26.360 FVHLC 42S	10.07-		 3400 700 641 HD ⊗ 3482 114 031 ⊗ 1878 007 729 ⊙ 3151 263 031	430 10 GMFZ430N 430WGTZ KZISZ-6	Getr. / GBox: ZF Ecosplit-3 Nebenantriebs-ID / PTO ID: NMV 221	(50)	
26.360 FVHLS 42S	05.08-		 3488 017 447	400 MFZ2/400X	Getr. / GBox: ZF Ecosplit-3 für Fahrzeuge mit Zweischeibenkupplung / for vehicles with double disc clutch enthält eine Kupplungsscheibe / This part number includes one clutch disc	(77)	(67)
26.400 FPHLS 42S	05.08-		 1878 002 643	400 10 400WGTZ	Getr. / GBox: ZF Ecosplit-3 für Fahrzeuge mit Zweischeibenkupplung / for vehicles with double disc clutch	(77)	
26.400 FVHLC 42S	10.07-		 3151 262 031	KZISZ-5	Getr. / GBox: ZF Ecosplit-3 für Fahrzeuge mit Zweischeibenkupplung / for vehicles with double disc clutch	(77)	
26.400 FVHLS 42S	10.07-		 3496 006 000		Getr. / GBox: ZF langer Bügel / long handle	(86)	
26.400 FVL-KO 24S	10.07-		 1863 869 038		Getr. / GBox: ZF		
35.400 FFHLC 73S	10.07-		 3189 600 036		für Fahrzeuge mit Zweischeibenkupplung / for vehicles with double disc clutch	(77)	
35.400 FFHLC 73S	10.07-		3189 600 004		Getr. / GBox: ZF AS Tronic Rollenausführung / roller version	(58)	
			3189 600 020		Getr. / GBox: ZF Ecosplit-3		

TGS		08.07 -				
26.400 FNLC, FNLCR, FNLLC, FNLLR, FVLC, FVL-KO, FNLLW 24S 18S 21S	10.07-	D2066LF42, D2066LF43, D2066LF37, D2066LF39,	 3400 700 380 ⊗ 3482 000 361 ⊗ 1878 080 037 ⊙ 3151 000 034	430 10 MFZ430 430WGTZ KZISZ-5	Getr. / GBox: ZF Ecosplit-3	
32.360 FFDR 49S	08.08-	D2066LF41, D2066LF63, D2066LF26, D2066LF48, D2066LF52,	 3400 700 381 ⊗ 3482 000 361 ⊗ 1878 080 037 ⊙ 3151 000 493	430 10 MFZ430 430WGTZ KZISZ-5	für Ausrückgabel mit Rollen / for release fork with rollers	(71)
33.320 FDAC, FDALC 56S 82S	06.08-	D2066LF41, D2066LF63, D2066LF26, D2066LF48, D2066LF52,	 3400 700 403 ⊗ 3482 000 361 ⊗ 1878 004 832 ⊙ 3151 000 144	430 10 MFZ430 430WGTZ KZISZ-5	für Ausrückgabel mit Nocken / for release fork with cams	(70)
33.320 FDAK, FDALK 82S 56S	06.08-	D2066LF68, D2066LF61, D2066LF64, D2066LF67, D2066LF38, D2066LF51, D2066LF49	 3400 700 327 ⊗ 3482 114 031 ⊗ 1878 004 832 ⊙ 3151 263 031	430 10 GMFZ430N 430WGTZ KZISZ-6	Getr. / GBox: ZF Ecosplit-3 für Nebenantrieb / for PTO	(82)
33.320 FDAS, FDALS 82S 56S	06.08-		 3400 700 641 HD ⊗ 3482 114 031 ⊗ 1878 007 729 ⊙ 3151 263 031	430 10 GMFZ430N 430WGTZ KZISZ-6	Getr. / GBox: ZF Ecosplit-3 Nebenantriebs-ID / PTO ID: NMV 221	(50)
33.320 FDC, FDL, FDLR, FDR 78W 26S	06.08-		 3488 017 447	400 MFZ2/400X	Getr. / GBox: ZF Ecosplit-3 für Fahrzeuge mit Zweis Scheibenkupplung / for vehicles with double disc clutch enthält eine Kupplungsscheibe / This part number includes one clutch disc	(77) (67)
33.320 FDK, FDLK 26S	06.08-		 1878 002 643	400 10 400WGTZ	Getr. / GBox: ZF Ecosplit-3 für Fahrzeuge mit Zweis Scheibenkupplung / for vehicles with double disc clutch	(77)
33.320 FDL, FDS 26S 30S	06.08-		 3151 262 031	KZISZ-5	Getr. / GBox: ZF Ecosplit-3 für Fahrzeuge mit Zweis Scheibenkupplung / for vehicles with double disc clutch	(77)
35.320 FFDAK 96S	06.08-		 3496 006 000		Getr. / GBox: ZF langer Bügel / long handle	(86)
35.320 FFDAK, FFDHLK 59S 93S	06.08-		 1863 869 038		Getr. / GBox: ZF	
35.360 FFDAK 96W 96S	06.08-		 3189 600 036		für Fahrzeuge mit Zweis Scheibenkupplung / for vehicles with double disc clutch	(77)
35.400 FFDAK 96S 60W	06.08-		3189 600 004		Getr. / GBox: ZF AS Tronic Rollenausführung / roller version	(58)
35.400 FFDAK, FFDHLK 96S 59S 93S	06.08-		3189 600 020		Getr. / GBox: ZF Ecosplit-3	
41.320 FFDAK 93S	06.08-					
41.320 FFDAK 96S	06.08-					
41.320 FFDC 39S	06.08-					
41.320 FFDK 39S	06.08-					
41.320 FFD-TM 39S	06.08-					

		CODE				
--	--	------	--	---	---	---













MAN













TGS		08.07 -					
26.440 FDAC, FDALC, FDHLC, FDHLC/M 82S 70S 56S	02.09-	D2676LF26, D2676LF22, D2066LF25, D2066LF36, D2066LF62, D2066LF40, D2066LF50		3400 700 402 ⊗ 3482 000 246 ⊗ 1878 002 139 ⊙ 3151 000 034	430 10 MFZ430 430WGTZ KZISZ-5	Getr. / GBox: ZF Ecosplit 3	
26.440 FDAK, FDALK, FDHK, FDHLK 56S 82S 47S 70S	11.07-			3400 700 460 HD ⊗ 3482 000 246 ⊗ 1878 004 104 ⊙ 3151 000 034	430 10 MFZ430 430WGTZ KZISZ-5	Getr. / GBox: ZF Ecosplit 3	
26.440 FDAS, FDALS, FDHS, FDHLS, FDHLS/M 82S 70S 56S 47S	02.09-			3400 700 381 ⊗ 3482 000 361 ⊗ 1878 080 037 ⊙ 3151 000 493	430 10 MFZ430 430WGTZ KZISZ-5	Getr. / GBox: ZF AS-Tronic für Ausrückgabel mit Rollen / for release fork with rollers	(71)
26.440 FDC, FDR, FDC/M, FDLC, FDLC/M, FDLRC, FNHLC, FVHLC 42S 78W 35S 30S 26S	02.09-			3400 700 403 ⊗ 3482 000 361 ⊗ 1878 004 832 ⊙ 3151 000 144	430 10 MFZ430 430WGTZ KZISZ-5	Getr. / GBox: ZF AS-Tronic für Ausrückgabel mit Nocken / for release fork with cams	(70)
26.440 FDK, FDLK 30S 26S	07.08-			3400 700 327 ⊗ 3482 114 031 ⊗ 1878 004 832 ⊙ 3151 263 031	430 10 GMFZ430N 430WGTZ KZIZ-6	Getr. / GBox: ZF Ecosplit 3 für Nebenantrieb / for PTO	(82)
26.440 FDS, FDRS, FDLs, FDLRS, FNHLS, FPHLS, FVHLS 78W 30S 30W 35S 26S 42S	05.08-			3400 700 641 HD ⊗ 3482 114 031 ⊗ 1878 007 729 ⊙ 3151 263 031	430 10 GMFZ430N 430WGTZ KZIZ-6	Getr. / GBox: ZF Ecosplit 3 Nebenantriebs-ID / PTO ID: NMV 221	(50)
26.440 FD-TM 26S	07.08-			3488 017 447	400 MFZ2/400X	Getr. / GBox: ZF Ecosplit 3 für Fahrzeuge mit Zweischeibenkupplung / for vehicles with double disc clutch enthält eine Kupplungsscheibe / This part number includes one clutch disc	(77) (67)
26.440 FNLC, FNLLC, FNLLRC, FNLLW, FNLC, FVLC 21S 24S 18S	10.07-			1878 002 643	400 10 400WGTZ	Getr. / GBox: ZF Ecosplit 3 für Fahrzeuge mit Zweischeibenkupplung / for vehicles with double disc clutch	(77)
26.440 FNLS, FNLLS, FNLRs, FPLS, FPLRS, FVLS 24S 18S	10.07-			3151 262 031	KZISZ-5	Getr. / GBox: ZF Ecosplit 3 für Fahrzeuge mit Zweischeibenkupplung / for vehicles with double disc clutch	(77)
26.440 FNLS, FNLLS, FNLRs, FPLS, FPLRS, FVLS 24S 21S 18S 18W	02.09-			3496 006 000		langer Bügel / long handle	(86)
26.440 FPHLS 42S	05.08-			1863 869 038			
26.440 FVHLC 42S	10.07-			3189 600 036		für Fahrzeuge mit Zweischeibenkupplung / for vehicles with double disc clutch	(77)
26.440 FVHLS 42S	05.08-			3189 600 004		Getr. / GBox: ZF AS Tronic Rollenausführung / roller version	(58)
26.440 FVL-KO 24S	10.07-			3189 600 020		Getr. / GBox: ZF Ecosplit-3	
32.440 FFD-TM, FFDR-TM 49S	10.07-						
33.440 FDAC, FDALC, FDARC 82S 56W 56S	07.08-						
33.440 FDAK, FDALK, FDHK, FDARK 56W 56S 47S 82S	11.07-						
33.440 FDAS, FDALS, FDHS, FDARS 56S 56W 47S 82S	10.07-						
33.440 FDC, FDLC, FDLRC, FDR, FDRC 30S 26W 26S 76W	06.08-						
33.440 FDC-TM, FDR-TM 26W	06.08-						
33.440 FDK, FDLK, FDRK 26S 26W 30S 76W	06.08-						
33.440 FDS, FDLs, FDLs/M, FDRS 30S 76W 30W 26S 26W	06.08-						

TGS		08.07 -					
26.480 FDAC, FDALC, FDHLC 70S 56S 82S	02.09-	D2676LF20, D2676LF07, D2676LF14, D2676LF13, D2676LF06, D2676LF05, D2676LF02, D2676LF25, D2676LF03		3400 700 402 ⊗ 3482 000 246 ⊗ 1878 002 139 ⊙ 3151 000 034	430 10 MFZ430 430WGTZ KZISZ-5	Getr. / GBox: ZF Ecosplit-3 Euro4/Euro5 / Euro4/Euro5 Euro 6 / Euro 6	(20) (18)
26.480 FDAK, FDALK, FDHK, FDHLK 56S 82S 47S 70S	02.09-			3400 700 460 HD ⊗ 3482 000 246 ⊗ 1878 004 104 ⊙ 3151 000 034	430 10 MFZ430 430WGTZ KZISZ-5	Getr. / GBox: ZF Ecosplit-3	
26.480 FDAS, FDALS, FDHS, FDHLS 70S 47S 56S 82S	02.09-			3400 700 459 HD ⊗ 3482 000 246 ⊗ 1878 004 104 ⊙ 3151 000 493	430 10 MFZ430 430WGTZ KZISZ-5	Getr. / GBox: ZF AS-Tronic für Ausrückgabel mit Rollen / for release fork with rollers	(71)
26.480 FDC, FDC/M, FDLC, FDRC, FDLRC, FNLC, FVHLC 35S 26S 78W 42S 30S	02.09-			3400 700 404 ⊗ 3482 000 246 ⊗ 1878 002 139 ⊙ 3151 000 144	430 10 MFZ430 430WGTZ KZISZ-5	Getr. / GBox: ZF AS-Tronic für Ausrückgabel mit Nocken / for release fork with cams	(70)
26.480 FDK, FDLK 30S 26S	07.08-			3400 700 327 ⊗ 3482 114 031 ⊗ 1878 004 832 ⊙ 3151 263 031	430 10 GMFZ430N 430WGTZ KZIZ-6	Getr. / GBox: ZF Ecosplit-3 für Nebenantrieb / for PTO	(82)
26.480 FDS, FDLS, FDRS, FDLRS, FNHLS, FPHLS, FVHLS 30S 42S 35S 26S 30W 78W	05.08-			3400 700 641 HD ⊗ 3482 114 031 ⊗ 1878 007 729 ⊙ 3151 263 031	430 10 GMFZ430N 430WGTZ KZIZ-6	Getr. / GBox: ZF Ecosplit-3 Nebenantriebs-ID / PTO ID: NMV 221	(50)
26.480 FD-TM 26S	05.08-			3488 017 447	400 MFZ2/400X	Getr. / GBox: ZF Ecosplit-3 für Fahrzeuge mit Zweischeibenkupplung / for vehicles with double disc clutch	(77)
26.480 FNLK, FNLRC, FNLLC, FNLLRC, FNLLW, FVLC, FVL- KO 18S 18W 21S 24S	10.07-			1878 002 643	400 10 400WGTZ	Getr. / GBox: ZF Ecosplit-3 für Fahrzeuge mit Zweischeibenkupplung / for vehicles with double disc clutch	(77)
26.480 FNLK, FNLRC, FNLLC, FNLLRC, FNLLW, FVLC, FVL- KO 21S 18S 18W 24S	10.07-			3151 262 031	KZISZ-5	Getr. / GBox: ZF Ecosplit-3 für Fahrzeuge mit Zweischeibenkupplung / for vehicles with double disc clutch	(77)
26.480 FNLS, FNLLS, FNLRS, FPLS, FPLRS, FVLS 18W 21S 24S 18S	02.09-			3496 006 000		Getr. / GBox: ZF langer Bügel / long handle	(86)
26.480 FNLS, FNLLS, FNLRS, FPLS, FPLRS, FVLS 18W 18S 21S 24S	02.09-			1863 869 038		Getr. / GBox: ZF	
26.480 FPHLS 42S	05.08-			3189 600 036		für Fahrzeuge mit Zweischeibenkupplung / for vehicles with double disc clutch	(77)
26.480 FVHLC 42S	10.07-			3189 600 004		Getr. / GBox: ZF AS Tronic Rollenausführung / roller version	(58)
26.480 FVHLS 42S	05.08-			3189 600 020		Getr. / GBox: ZF Ecosplit-3	
26.480 FVL-KO 24S	10.07-						
26.540 FDAC, FDALC, FDHLC, FDHLC/M 56S 70S 82S	02.09-						
26.540 FDAK, FDALK, FDHLK 56S 70S 82S	11.07-						
26.540 FDAS, FDALS, FDHLS 56S 82S 70S	02.09-						
26.540 FDC, FDC/M, FDLC, FDLC/M, FDLRC, FNHLC, FVHLC 30S 35S 26S	02.09-						
26.540 FDK, FDLK 26S 30S	02.09-						
26.540 FDS, FDLS, FDRS, FDLRS, FNHLS, FPHLS, FVHLS 42S 35S 30S 26S	05.08-						
28.540 FANLC, FNHLC 71S 84S	06.08-						
28.540 FANLK 84S	06.08-						
28.540 FNLC 89S 74S	02.09-						
28.540 FNLS 89S	02.09-						
33.480 FDAC, FDALC, FDARC 56S 82S 56W	08.08-						
33.480 FDAK, FDALK, FDARK, FDHK 47S 82S 56W 56S	08.08-						

		CODE				
--	--	------	--	---	---	---



























MAN































TGS		08.07 -				
33.480 FDAS, FDALS, FDHS, FDARS 82S 56S 56W 47S	10.07 -	D2676LF20, D2676LF07, D2676LF14, D2676LF13, D2676LF06, D2676LF05, D2676LF02, D2676LF25, D2676LF03	 3400 700 402 ⊗ 3482 000 246 ⊗ 1878 002 139 ⊙ 3151 000 034	430 10 MFZ430 430WGTZ KZISZ-5	Getr. / GBox: ZF Ecosplit-3 Euro4/Euro5 / Euro4/Euro5 Euro 6 / Euro 6	(20) (18)
33.480 FDC, FDC/M, FDLC, FDLC/M, FDLRC, FDR, FDRC 26S 26W 76W 30S	08.08 -		 3400 700 460 HD ⊗ 3482 000 246 ⊗ 1878 004 104 ⊙ 3151 000 034	430 10 MFZ430 430WGTZ KZISZ-5	Getr. / GBox: ZF Ecosplit-3	
33.480 FDC-TM, FDRC-TM 26W	08.08 -		 3400 700 459 HD ⊗ 3482 000 246 ⊗ 1878 004 104 ⊙ 3151 000 493	430 10 MFZ430 430WGTZ KZISZ-5	Getr. / GBox: ZF AS-Tronic für Ausrückgabel mit Rollen / for release fork with rollers	(71)
33.480 FDK, FDLK 76W 26S 30S 26W	08.08 -		 3400 700 404 ⊗ 3482 000 246 ⊗ 1878 002 139 ⊙ 3151 000 144	430 10 MFZ430 430WGTZ KZISZ-5	Getr. / GBox: ZF AS-Tronic für Ausrückgabel mit Nocken / for release fork with cams	(70)
33.480 FDS, FDLS, FDLS/M, FDRS 76W 26S 30W 26W 30S	08.08 -		 3400 700 327 ⊗ 3482 114 031 ⊗ 1878 004 832 ⊙ 3151 263 031	430 10 GMFZ430N 430WGTZ KZIZ-6	Getr. / GBox: ZF Ecosplit-3 für Nebenantrieb / for PTO	(82)
33.540 FDAC, FDALC 82S 56S	02.09 -		 3400 700 641 HD ⊗ 3482 114 031 ⊗ 1878 007 729 ⊙ 3151 263 031	430 10 GMFZ430N 430WGTZ KZIZ-6	Getr. / GBox: ZF Ecosplit-3 Nebenantriebs-ID / PTO ID: NMV 221	(50)
33.540 FDAK, FDALK 82S 56S	02.09 -		 3488 017 447	400 MFZ2/400X	Getr. / GBox: ZF Ecosplit-3 für Fahrzeuge mit Zweischeibenkupplung / for vehicles with double disc clutch	(77)
33.540 FDAS, FDALS 82S 56S	02.09 -		 1878 002 643	400 10 400WGTZ	Getr. / GBox: ZF Ecosplit-3 für Fahrzeuge mit Zweischeibenkupplung / for vehicles with double disc clutch	(77)
33.540 FDC, FDLC, FDLC/M, FDLRC, FDRC 30S 26S	02.09 -		 3151 262 031	KZISZ-5	Getr. / GBox: ZF Ecosplit-3 für Fahrzeuge mit Zweischeibenkupplung / for vehicles with double disc clutch	(77)
33.540 FDK, FDLK 26S 30S	02.09 -		 3496 006 000		Getr. / GBox: ZF langer Bügel / long handle	(86)
33.540 FDS, FDLS, FDLS/M 30S 26S	02.09 -		 1863 869 038		Getr. / GBox: ZF	
			 3189 600 036		für Fahrzeuge mit Zweischeibenkupplung / for vehicles with double disc clutch	(77)
			3189 600 004		Getr. / GBox: ZF AS Tronic Rollenausführung / roller version	(58)
			3189 600 020		Getr. / GBox: ZF Ecosplit-3	

TGS		08.07 -				
28.320 FANLC, FNHLC 71S 84S	07.08-	D2066LF37, D2066LF43, D2066LF42, D2066LF41, 84S	 3400 700 380 ⊗ 3482 000 361 ⊗ 1878 080 037 ⊙ 3151 000 034	430 10 MFZ430 430WGTZ KZISZ-5	Getr. / GBox: ZF Ecosplit-3 71S,74S,84S,89S Euro5/Euro6 / Euro5/Euro6	(21)
28.320 FANLK 84S	07.08-	D2066LF63, D2066LF39, D2066LF48, D2066LF61, D2066LF68, D2066LF67, D2066LF64, D2066LF49, D2066LF38	 3400 700 381 ⊗ 3482 000 361 ⊗ 1878 080 037 ⊙ 3151 000 493	430 10 MFZ430 430WGTZ KZISZ-5	Getr. / GBox: ZF AS-Tronic 71S,74S,84S,89S Euro5/Euro6 / Euro5/Euro6 für Ausrückgabel mit Rollen / for release fork with rollers	(21) (71)
28.320 FNLC 74S 89S	07.08-		 3400 700 403 ⊗ 3482 000 361 ⊗ 1878 004 832 ⊙ 3151 000 144	430 10 MFZ430 430WGTZ KZISZ-5	Getr. / GBox: ZF AS-Tronic 71S,74S,84S,89S Euro5/Euro6 / Euro5/Euro6 für Ausrückgabel mit Nocken / for release fork with cams	(21) (70)
28.320 FNLS 89S 74S	07.08-		 3400 700 327 ⊗ 3482 114 031 ⊗ 1878 004 832 ⊙ 3151 263 031	430 10 GMFZ430N 430WGTZ KZISZ-6	Getr. / GBox: ZF Ecosplit-3 71S,74S,84S,89S Euro5/Euro6 / Euro5/Euro6 für Nebenantrieb / for PTO	(21) (82)
28.320 FANLK 84S	08.08-		 3400 700 641 HD ⊗ 3482 114 031 ⊗ 1878 007 729 ⊙ 3151 263 031	430 10 GMFZ430N 430WGTZ KZISZ-6	Getr. / GBox: ZF Ecosplit-3 71S,74S,84S,89S Euro5/Euro6 / Euro5/Euro6 Nebenantriebs-ID / PTO ID: NMV 221	(21) (50)
28.320 FNLC, FNLRC 89S 73W 19W 74S	08.08-		 3488 017 447	400 MFZ2/400X	Getr. / GBox: ZF Ecosplit-3 71S,74S,84S,89S Euro5/Euro6 / Euro5/Euro6 für Fahrzeuge mit Zweischeibenkupplung / for vehicles with double disc clutch enthält eine Kupplungsscheibe / This part number includes one clutch disc	(21) (77) (67)
28.320 FNLS, FNLRS 89S 73W 19W	08.08-		 1878 002 643	400 10 400WGTZ	Getr. / GBox: ZF Ecosplit-3 71S,74S,84S,89S Euro5/Euro6 / Euro5/Euro6 für Fahrzeuge mit Zweischeibenkupplung / for vehicles with double disc clutch	(21) (77)
28.400 FANLC, FNHLC 71S 84S	08.08-		 3151 262 031	KZISZ-5	Getr. / GBox: ZF Ecosplit-3 71S,74S,84S,89S Euro5/Euro6 / Euro5/Euro6 für Fahrzeuge mit Zweischeibenkupplung / for vehicles with double disc clutch	(21) (77)
28.400 FANLK 84S	08.08-		 3496 006 000		Getr. / GBox: ZF 71S,74S,84S,89S Euro5/Euro6 / Euro5/Euro6 langer Bügel / long handle	(21) (86)
28.400 FNLC, FNLRC 19W 73W 74S 89S	08.08-		 1863 869 038		Getr. / GBox: ZF 71S,74S,84S,89S Euro5/Euro6 / Euro5/Euro6	(21)
28.400 FNLC, FNLRC 73W 74S 89S 19W	08.08-		 3189 600 036		für Fahrzeuge mit Zweischeibenkupplung / for vehicles with double disc clutch	(77)
28.400 FNLS, FBLRS 73W 19W 89S	08.08-		 3189 600 004		Getr. / GBox: ZF AS Tronic Rollenausführung / roller version	(58)
			 3189 600 020		Getr. / GBox: ZF Ecosplit-3	

		CODE				
--	--	------	--	---	---	---

























MAN











TGS		08.07 -				
28.360 FANLC, FNHLC 84S 71S 28.360 FNLC, FNLRC 74S 89S 19W 73W	08.08-	D2066LF42, D2066LF48, D2066LF64, D2066LF67, D2066LF38	 3400 700 380  3482 000 361  1878 080 037  3151 000 034	430 10 MFZ430 430WGTZ KZISZ-5	Getr. / GBox: ZF Ecosplit-3 71S,74S,84S,89S	
	08.08-		 3400 700 381  3482 000 361  1878 080 037  3151 000 493	430 10 MFZ430 430WGTZ KZISZ-5	Getr. / GBox: ZF AS-Tronic 71S,74S,84S,89S für Ausrückgabel mit Rollen / for release fork with rollers	(71)
			 3400 700 403  3482 000 361  1878 004 832  3151 000 144	430 10 MFZ430 430WGTZ KZISZ-5	Getr. / GBox: ZF AS-Tronic 71S,74S,84S,89S für Ausrückgabel mit Nocken / for release fork with cams	(70)
			 3400 700 327  3482 114 031  1878 004 832  3151 263 031	430 10 GMFZ430N 430WGTZ KZIZ-6	Getr. / GBox: ZF Ecosplit-3 71S,74S,84S,89S für Nebenantrieb / for PTO	(82)
			 3400 700 641 HD  3482 114 031  1878 007 729  3151 263 031	430 10 GMFZ430N 430WGTZ KZIZ-6	Getr. / GBox: ZF Ecosplit-3 71S,74S,84S,89S Nebenantriebs-ID / PTO ID: NMV 221	(50)
			 3488 017 447	400 MFZ2/400X	Getr. / GBox: ZF Ecosplit-3 71S,74S,84S,89S für Fahrzeuge mit Zweischeibenkupplung / for vehicles with double disc clutch enthält eine Kupplungsscheibe / This part number includes one clutch disc	(77) (67)
			 1878 002 643	400 10 400WGTZ	Getr. / GBox: ZF Ecosplit-3 71S,74S,84S,89S für Fahrzeuge mit Zweischeibenkupplung / for vehicles with double disc clutch	(77)
			 3151 262 031	KZISZ-5	Getr. / GBox: ZF Ecosplit-3 71S,74S,84S,89S für Fahrzeuge mit Zweischeibenkupplung / for vehicles with double disc clutch	(77)
			 3496 006 000		Getr. / GBox: ZF 71S,74S,84S,89S langer Bügel / long handle	(86)
			 1863 869 038		Getr. / GBox: ZF 71S,74S,84S,89S	
			 3189 600 036		für Fahrzeuge mit Zweischeibenkupplung / for vehicles with double disc clutch	(77)
			3189 600 004		Getr. / GBox: ZF AS Tronic Rollenausführung / roller version	(58)
			3189 600 020		Getr. / GBox: ZF Ecosplit-3	

TGS		08.07 -						
28.440 FANLC, FNHLC 84S 71S 28.440 FANLK 84S 28.440 FNLC, FNLRC 74S 73W 19W 89S 28.440 FNLC, FNLRC 73W 74S 19W 89S 28.440 FNLS, FNLRS 89S 19W 73W 32.440 FFDRC 49S	08.08-	D2066LF36, D2066LF62, D2066LF40, D2066LF50		3400 700 402  3482 000 246  1878 002 139  3151 000 034	430 10 MFZ430 430WGTZ KZISZ-5	Getr. / GBox: ZF Ecosplit 3 49S,71S,74S,84S,89S		
	08.08-			3400 700 460 HD  3482 000 246  1878 004 104  3151 000 034	430 10 MFZ430 430WGTZ KZISZ-5	Getr. / GBox: ZF Ecosplit 3 49S,71S,74S,84S,89S		
	08.08-			3400 700 381  3482 000 361  1878 080 037  3151 000 493	430 10 MFZ430 430WGTZ KZISZ-5	Getr. / GBox: ZF AS-Tronic 49S,71S,74S,84S,89S für Ausrückgabel mit Rollen / for release fork with rollers	(71)	
	08.08-			3400 700 403  3482 000 361  1878 004 832  3151 000 144	430 10 MFZ430 430WGTZ KZISZ-5	Getr. / GBox: ZF AS-Tronic 49S,71S,74S,84S,89S für Ausrückgabel mit Nocken / for release fork with cams	(70)	
	08.08-			3400 700 327  3482 114 031  1878 004 832  3151 263 031	430 10 GMFZ430N 430WGTZ KZISZ-6	Getr. / GBox: ZF Ecosplit 3 49S,71S,74S,84S,89S für Nebenantrieb / for PTO	(82)	
	08.08-			3400 700 641 HD  3482 114 031  1878 007 729  3151 263 031	430 10 GMFZ430N 430WGTZ KZISZ-6	Getr. / GBox: ZF Ecosplit-3 49S,71S,74S,84S,89S Nebenantriebs-ID / PTO ID: NMV 221	(50)	
						400 MFZ2/400X	Getr. / GBox: ZF Ecosplit-3 49S,71S,74S,84S,89S für Fahrzeuge mit Zweischeibenkupplung / for vehicles with double disc clutch enthält eine Kupplungsscheibe / This part number includes one clutch disc	(77) (67)
						1878 002 643 400 10 400WGTZ	Getr. / GBox: ZF Ecosplit 3 49S,71S,74S,84S,89S für Fahrzeuge mit Zweischeibenkupplung / for vehicles with double disc clutch	(77)
						3151 262 031 KZISZ-5	Getr. / GBox: ZF Ecosplit 3 49S,71S,74S,84S,89S für Fahrzeuge mit Zweischeibenkupplung / for vehicles with double disc clutch	(77)
						3496 006 000	49S,71S,74S,84S,89S langer Bügel / long handle	(86)
						1863 869 038	49S,71S,74S,84S,89S	
						3189 600 036	für Fahrzeuge mit Zweischeibenkupplung / for vehicles with double disc clutch	(77)
						3189 600 004	Getr. / GBox: ZF AS Tronic Rollenausführung / roller version	(58)
						3189 600 020	Getr. / GBox: ZF Ecosplit-3	

		CODE		 Parameter		
--	--	------	--	---	---	---























MAN











TGS		08.07 -				
28.480 FANLC, FNHLC 84S 71S 28.480 FANLK 84S 28.480 FNLC, FNLRC 19W 89S 73W 74S 28.480 FNLC, FNLRC 89S 74S 19W 73W 28.480 FNLS, FNLRS 89S 19W 73W	08.08-	D2676LF20, D2676LF07, D2676LF05, D2676LF25, D2676LF02	 3400 700 460 HD  3482 000 246  1878 004 104  3151 000 034	430 10 MFZ430 430WGTZ KZISZ-5	Getr. / GBox: ZF Ecosplit 3 42S,71S,74S,84S,89S Euro5/Euro6 / Euro5/Euro6	(21)
	08.08-		 3400 700 459 HD  3482 000 246  1878 004 104  3151 000 493	430 10 MFZ430 430WGTZ KZISZ-5	Getr. / GBox: ZF AS-Tronic 42S,71S,74S,84S,89S Euro5/Euro6 / Euro5/Euro6 für Ausrückgabel mit Rollen / for release fork with rollers	(21) (71)
	08.08-		 3151 000 144	KZISZ-5	Getr. / GBox: ZF AS-Tronic 42S,71S,74S,84S,89S Euro5/Euro6 / Euro5/Euro6 für Ausrückgabel mit Nocken / for release fork with cams	(21) (70)
	08.08-		 3400 700 327  3482 114 031  1878 004 832  3151 263 031	430 10 GMFZ430N 430WGTZ KZIZ-6	Getr. / GBox: ZF Ecosplit 3 42S,71S,74S,84S,89S Euro5/Euro6 / Euro5/Euro6 für Nebenantrieb / for PTO	(21) (82)
	08.08-		 3400 700 641 HD  3482 114 031  1878 007 729  3151 263 031	430 10 GMFZ430N 430WGTZ KZIZ-6	Getr. / GBox: ZF Ecosplit 3 42S,71S,74S,84S,89S Euro5/Euro6 / Euro5/Euro6 Nebenantriebs-ID / PTO ID: NMV 221	(21) (50)
	08.08-		 3488 017 447	400 MFZ2/400X	Getr. / GBox: ZF Ecosplit 3 42S,71S,74S,84S,89S Euro5/Euro6 / Euro5/Euro6 für Fahrzeuge mit Zweischeibenkupplung / for vehicles with double disc clutch enthält eine Kupplungsscheibe / This part number includes one clutch disc	(21) (77) (67)
	08.08-		 1878 002 643	400 10 400WGTZ	Getr. / GBox: ZF Ecosplit 3 42S,71S,74S,84S,89S Euro5/Euro6 / Euro5/Euro6 für Fahrzeuge mit Zweischeibenkupplung / for vehicles with double disc clutch	(21) (77)
	08.08-		 3151 262 031	KZISZ-5	Getr. / GBox: ZF Ecosplit 3 42S,71S,74S,84S,89S Euro5/Euro6 / Euro5/Euro6 für Fahrzeuge mit Zweischeibenkupplung / for vehicles with double disc clutch	(21) (77)
	08.08-		 3496 006 000		42S,71S,74S,84S,89S Euro5/Euro6 / Euro5/Euro6 langer Bügel / long handle	(21) (86)
	08.08-		 1863 869 038		42S,71S,74S,84S,89S Euro5/Euro6 / Euro5/Euro6	(21)
	08.08-		 3189 600 036		für Fahrzeuge mit Zweischeibenkupplung / for vehicles with double disc clutch	(77)
	08.08-		 3189 600 004		Getr. / GBox: ZF AS Tronic Rollenausführung / roller version	(58)

TGS		08.07 -				
32.320 FFDRC 49S	08.08-	D2066LF37, D2066LF27, D2066LF42, D2066LF43, 49S	 3400 700 380 ⊗ 3482 000 361 ⊗ 1878 080 037 ⊙ 3151 000 034	430 10 MFZ430 430WGTZ KZISZ-5	Getr. / GBox: ZF Ecosplit-3 49S,59S,93S,90S,96S Euro5/Euro6 / Euro5/Euro6	(21)
32.320 FFD-TM 49S	02.09-	D2066LF41, D2066LF39, D2066LF26, D2066LF53, D2066LF61, D2066LF68, D2066LF67, D2066LF38, D2066LF51, D2066LF49	 3400 700 381 ⊗ 3482 000 361 ⊗ 1878 080 037 ⊙ 3151 000 493	430 10 MFZ430 430WGTZ KZISZ-5	Getr. / GBox: ZF AS-Tronic 49S,59S,93S,90S,96S Euro5/Euro6 / Euro5/Euro6 für Ausrückgabel mit Rollen / for release fork with rollers	(21) (71)
32.400 FFDRC 49S 49W	08.08-		 3400 700 403 ⊗ 3482 000 361 ⊗ 1878 004 832 ⊙ 3151 000 144	430 10 MFZ430 430WGTZ KZISZ-5	Getr. / GBox: ZF AS-Tronic 49S,59S,93S,90S,96S Euro5/Euro6 / Euro5/Euro6 für Ausrückgabel mit Nocken / for release fork with cams	(21) (70)
32.400 FFD-TM, FFDR-TM 49S	10.07-		 3400 700 327 ⊗ 3482 114 031 ⊗ 1878 004 832 ⊙ 3151 263 031	430 10 GMFZ430N 430WGTZ KZIZ-6	Getr. / GBox: ZF Ecosplit-3 49S,59S,93S,90S,96S Euro5/Euro6 / Euro5/Euro6 für Nebenantrieb / for PTO	(21) (82)
35.320 FFNHLC 73S	10.07-		 3400 700 641 HD ⊗ 3482 114 031 ⊗ 1878 007 729 ⊙ 3151 263 031	430 10 GMFZ430N 430WGTZ KZIZ-6	Getr. / GBox: ZF Ecosplit-3 49S,59S,93S,90S,96S Euro5/Euro6 / Euro5/Euro6 Nebenantriebs-ID / PTO ID: NMV 221	(21) (50)
35.320 FFNLC 90S	01.09-		 3488 017 447	400 MFZ2/400X	Getr. / GBox: ZF Ecosplit-3 49S,59S,93S,90S,96S Euro5/Euro6 / Euro5/Euro6 für Fahrzeuge mit Zweischeibenkupplung / for vehicles with double disc clutch enthält eine Kupplungsscheibe / This part number includes one clutch disc	(21) (77) (67)
35.360 FFNHLC 73S	10.07-		 1878 002 643	400 10 400WGTZ	Getr. / GBox: ZF Ecosplit-3 49S,59S,93S,90S,96S Euro5/Euro6 / Euro5/Euro6 für Fahrzeuge mit Zweischeibenkupplung / for vehicles with double disc clutch	(21) (77)
35.360 FFNLC 90S	06.08-		 3151 262 031	KZISZ-5	Getr. / GBox: ZF Ecosplit-3 49S,59S,93S,90S,96S Euro5/Euro6 / Euro5/Euro6 für Fahrzeuge mit Zweischeibenkupplung / for vehicles with double disc clutch	(21) (77)
35.400 FFNLC 90S	06.08-		 3496 006 000		Getr. / GBox: ZF 49S,59S,93S,90S,96S Euro5/Euro6 / Euro5/Euro6 langer Bügel / long handle	(21) (86)
			 1863 869 038		Getr. / GBox: ZF 49S,59S,93S,90S,96S Euro5/Euro6 / Euro5/Euro6	(21)
			 3189 600 036		für Fahrzeuge mit Zweischeibenkupplung / for vehicles with double disc clutch	(77)
			3189 600 004		Getr. / GBox: ZF AS Tronic Rollenausführung / roller version	(58)
			3189 600 020		Getr. / GBox: ZF Ecosplit-3	

		CODE		 Parameter		
--	--	------	--	---	---	---































MAN

TGS		08.07 -				
32.480 FFDRC 49S	08.08-	D2676LF07, D2676LF05, D2676LF25	 3400 700 460 HD  3482 000 246  1878 004 104  3151 000 034	430 10 MFZ430 430WGTZ KZISZ-5	Getr. / GBox: ZF Ecosplit 3 Euro5/Euro6 / Euro5/Euro6	(21)
32.480 FFD-TM 49S	08.08-		 3400 700 459 HD  3482 000 246  1878 004 104  3151 000 493	430 10 MFZ430 430WGTZ KZISZ-5	Getr. / GBox: ZF AS-Tronic Euro5/Euro6 / Euro5/Euro6 für Ausrückgabel mit Rollen / for release fork with rollers	(21) (71)
35.480 FFNLC 90S	06.08-		 3151 000 144	KZISZ-5	Getr. / GBox: ZF AS-Tronic Euro5/Euro6 / Euro5/Euro6 für Ausrückgabel mit Nocken / for release fork with cams	(21) (70)
			 3400 700 327  3482 114 031  1878 004 832  3151 263 031	430 10 GMFZ430N 430WGTZ KZIZ-6	Getr. / GBox: ZF Ecosplit 3 Euro5/Euro6 / Euro5/Euro6 für Nebenantrieb / for PTO	(21) (82)
			 3400 700 641 HD  3482 114 031  1878 007 729  3151 263 031	430 10 GMFZ430N 430WGTZ KZIZ-6	Getr. / GBox: ZF Ecosplit 3 Euro5/Euro6 / Euro5/Euro6 Nebenantriebs-ID / PTO ID: NMV 221	(21) (50)
			 3488 017 447	400 MFZ2/400X	Getr. / GBox: ZF Ecosplit 3 Euro5/Euro6 / Euro5/Euro6 für Fahrzeuge mit Zweischeibenkupplung / for vehicles with double disc clutch enthält eine Kupplungsscheibe / This part number includes one clutch disc	(21) (77) (67)
			 1878 002 643	400 10 400WGTZ	Getr. / GBox: ZF Ecosplit 3 Euro5/Euro6 / Euro5/Euro6 für Fahrzeuge mit Zweischeibenkupplung / for vehicles with double disc clutch	(21) (77)
			 3151 262 031	KZISZ-5	Getr. / GBox: ZF Ecosplit 3 Euro5/Euro6 / Euro5/Euro6 für Fahrzeuge mit Zweischeibenkupplung / for vehicles with double disc clutch	(21) (77)
			 3496 006 000		Euro5/Euro6 / Euro5/Euro6 langer Bügel / long handle	(21) (86)
			 1863 869 038		Euro5/Euro6 / Euro5/Euro6	(21)
			 3189 600 036		für Fahrzeuge mit Zweischeibenkupplung / for vehicles with double disc clutch	(77)
			3189 600 004		Getr. / GBox: ZF AS Tronic Rollenausführung / roller version	(58)

TGS		08.07 -				
35.320 FFDC, FFDLC, FDNLC 92S 41S 37S	06.08-	D2066LF37, D2066LF27,	 3400 700 380 ⊕ 3482 000 361 ⊕ 1878 080 037 ⊕ 3151 000 034	430 10 MFZ430 430WGTZ KZISZ-5	Getr. / GBox: ZF Ecosplit-3 37S,41S,42S,92S Euro5/Euro6 / Euro5/Euro6	(21)
35.320 FFDK, FFDLK, FFDRK 37S 41S	08.08-	D2066LF42, D2066LF28,	 3400 700 381 ⊕ 3482 000 361 ⊕ 1878 080 037 ⊕ 3151 000 493	430 10 MFZ430 430WGTZ KZISZ-5	Getr. / GBox: ZF AS-Tronic 37S,41S,42S,92S Euro5/Euro6 / Euro5/Euro6	(21)
35.320 FFD-TM 37S	10.07-	D2066LF43, D2066LF41, D2066LF39, D2066LF26, D2066LF53, D2066LF52, D2066LF61, D2066LF68, D2066LF67, D2066LF38, D2066LF51			für Ausrückgabel mit Rollen / for release fork with rollers	(71)
35.360 FFDK, FFDHLK 59S 93S	06.08-		 3400 700 403 ⊕ 3482 000 361 ⊕ 1878 004 832 ⊕ 3151 000 144	430 10 MFZ430 430WGTZ KZISZ-5	Getr. / GBox: ZF AS-Tronic 37S,41S,42S,92S Euro5/Euro6 / Euro5/Euro6 für Ausrückgabel mit Nocken / for release fork with cams	(21) (70)
35.360 FFDC, FFDLC, FDNLC 37S 41S 92S	06.08-		 3400 700 327 ⊕ 3482 114 031 ⊕ 1878 004 832 ⊕ 3151 263 031	430 10 GMFZ430N 430WGTZ KZISZ-6	Getr. / GBox: ZF Ecosplit-3 37S,41S,42S,92S Euro5/Euro6 / Euro5/Euro6 für Nebenantrieb / for PTO	(21) (82)
35.360 FFDK, FFDLK, FFDRK 37S 41S	08.08-					
35.360 FFD-TM 37S	10.07-		 3400 700 641 HD ⊕ 3482 114 031 ⊕ 1878 007 729 ⊕ 3151 263 031	430 10 GMFZ430N 430WGTZ KZISZ-6	Getr. / GBox: ZF Ecosplit-3 37S,41S,42S,92S Euro5/Euro6 / Euro5/Euro6 Nebenantriebs-ID / PTO ID: NMV 221	(21) (50)
35.400 FFDC, FFDLC, FDNLC 92S 37S 41S	06.08-		 3488 017 447	400 MFZ2/400X	Getr. / GBox: ZF Ecosplit-3 37S,41S,42S,92S Euro5/Euro6 / Euro5/Euro6 für Fahrzeuge mit Zweischeibenkupplung / for vehicles with double disc clutch enthält eine Kupplungsscheibe / This part number includes one clutch disc	(21) (77) (67)
35.400 FFDK, FFDLK, FFDRK 41S 37S	08.08-		 1878 002 643	400 10 400WGTZ	Getr. / GBox: ZF Ecosplit-3 37S,41S,42S,92S Euro5/Euro6 / Euro5/Euro6 für Fahrzeuge mit Zweischeibenkupplung / for vehicles with double disc clutch	(21) (77)
35.400 FFD-TM 37S	10.07-		 3151 262 031	KZISZ-5	Getr. / GBox: ZF Ecosplit-3 37S,41S,42S,92S Euro5/Euro6 / Euro5/Euro6 für Fahrzeuge mit Zweischeibenkupplung / for vehicles with double disc clutch	(21) (77)
			 3496 006 000		Getr. / GBox: ZF 37S,41S,42S,92S Euro5/Euro6 / Euro5/Euro6 langer Bügel / long handle	(21) (86)
			 1863 869 038		Getr. / GBox: ZF 37S,41S,42S,92S Euro5/Euro6 / Euro5/Euro6	(21)
			 3189 600 036		für Fahrzeuge mit Zweischeibenkupplung / for vehicles with double disc clutch	(77)
			3189 600 004		Getr. / GBox: ZF AS Tronic Rollenausführung / roller version	(58)
			3189 600 020		Getr. / GBox: ZF Ecosplit-3	













		CODE				
--	--	------	--	---	---	---

MAN

TGS		08.07 -					
35.440 FDNLC, FFDC, FFDLC 37S 41S 92S 42S 35.440 FFDK, FFDLK, FFDRK 37S 41S 35.440 FFD-TM 37S 35.440 FFNLC 90S	06.08-	D2066LF25, D2066LF36, D2066LF40		3400 700 402  3482 000 246  1878 002 139  3151 000 034	430 10 MFZ430 430WGTZ KZISZ-5	Getr. / GBox: ZF Ecosplit 3 37S,41S,90S,92S	
	08.08-			3400 700 460 HD  3482 000 246  1878 004 104  3151 000 034	430 10 MFZ430 430WGTZ KZISZ-5	Getr. / GBox: ZF Ecosplit 3 37S,41S,90S,92S	
	10.07-			3400 700 381  3482 000 361  1878 080 037  3151 000 493	430 10 MFZ430 430WGTZ KZISZ-5	Getr. / GBox: ZF AS-Tronic 37S,41S,90S,92S für Ausrückgabel mit Rollen / for release fork with rollers	(71)
	06.08-			3400 700 403  3482 000 361  1878 004 832  3151 000 144	430 10 MFZ430 430WGTZ KZISZ-5	Getr. / GBox: ZF AS-Tronic 37S,41S,90S,92S für Ausrückgabel mit Nocken / for release fork with cams	(70)
				3400 700 327  3482 114 031  1878 004 832  3151 263 031	430 10 GMFZ430N 430WGTZ KZIZ-6	Getr. / GBox: ZF Ecosplit 3 37S,41S,90S,92S für Nebenantrieb / for PTO	(82)
				3400 700 641 HD  3482 114 031  1878 007 729  3151 263 031	430 10 GMFZ430N 430WGTZ KZIZ-6	Getr. / GBox: ZF Ecosplit 3 37S,41S,90S,92S Nebenantriebs-ID / PTO ID: NMV 221	(50)
				3488 017 447	400 MFZ2/400X	Getr. / GBox: ZF Ecosplit 3 37S,41S,90S,92S für Fahrzeuge mit Zweischeibenkupplung / for vehicles with double disc clutch enthält eine Kupplungsscheibe / This part number includes one clutch disc	(77) (67)
				1878 002 643	400 10 400WGTZ	Getr. / GBox: ZF Ecosplit 3 37S,41S,90S,92S für Fahrzeuge mit Zweischeibenkupplung / for vehicles with double disc clutch	(77)
				3151 262 031	KZISZ-5	Getr. / GBox: ZF Ecosplit 3 37S,41S,90S,92S für Fahrzeuge mit Zweischeibenkupplung / for vehicles with double disc clutch	(77)
				3496 006 000		37S,41S,90S,92S langer Bügel / long handle	(86)
				1863 869 038		37S,41S,90S,92S	
				3189 600 036		für Fahrzeuge mit Zweischeibenkupplung / for vehicles with double disc clutch	(77)
				3189 600 004		Getr. / GBox: ZF AS Tronic Rollenausführung / roller version	(58)
				3189 600 020		Getr. / GBox: ZF Ecosplit-3	























		CODE				
--	--	------	--	---	---	---















































MAN

TGS		08.07 -					
35.440 FFDK 96S 60W	06.08-	D2676LF04, D2676LF26, D2066LF25, D2066LF36, 59S 93S	 3400 700 402 ⊗ 3482 000 246 ⊗ 1878 002 139 ⊙ 3151 000 034	430 10 MFZ430 430WGTZ KZISZ-5	Getr. / GBox: ZF Ecosplit 3 39S,59S,73S,93S,96S		
35.440 FFDK, FFDHLK 59S 93S	06.08-	D2066LF62, D2066LF40, D2066LF50	 3400 700 460 HD ⊗ 3482 000 246 ⊗ 1878 004 104 ⊙ 3151 000 034	430 10 MFZ430 430WGTZ KZISZ-5	Getr. / GBox: ZF Ecosplit 3 39S,59S,73S,93S,96S		
35.440 FFHLC 73S	10.07-						
35.440 FFHLC 73S	06.08-						
37.440 FFDC 39S	07.08-		 3400 700 381 ⊗ 3482 000 361 ⊗ 1878 080 037 ⊙ 3151 000 493	430 10 MFZ430 430WGTZ KZISZ-5	Getr. / GBox: ZF AS-Tronic 39S,59S,73S,93S,96S für Ausrückgabel mit Rollen / for release fork with rollers	(71)	
37.440 FFDK 39S	07.08-						
37.440 FFD-TM 39S	10.07-		 3400 700 403 ⊗ 3482 000 361 ⊗ 1878 004 832 ⊙ 3151 000 144	430 10 MFZ430 430WGTZ KZISZ-5	Getr. / GBox: ZF AS-Tronic 39S,59S,73S,93S,96S für Ausrückgabel mit Nocken / for release fork with cams	(70)	
41.440 FFD, FFDC, FFDC 79W 39W 39S	07.08-						
41.440 FFDK 93S	06.08-		 3400 700 327 ⊗ 3482 114 031 ⊗ 1878 004 832 ⊙ 3151 263 031	430 10 GMFZ430N 430WGTZ KZISZ-6	Getr. / GBox: ZF Ecosplit 3 39S,59S,73S,93S,96S für Nebenantrieb / for PTO	(82)	
41.440 FFDK 96S 60W	06.08-						
41.440 FFDARC 96S	06.08-		 3400 700 641 HD ⊗ 3482 114 031 ⊗ 1878 007 729 ⊙ 3151 263 031	430 10 GMFZ430N 430WGTZ KZISZ-6	Getr. / GBox: ZF Ecosplit 3 39S,59S,73S,93S,96S Nebenantriebs-ID / PTO ID: NMV 221	(50)	
41.440 FFDC-TM, FFDC-TM, FFD-TM 39S 39W 79W	10.07-		 3488 017 447	400 MFZ2/400X	Getr. / GBox: ZF Ecosplit 3 39S,59S,73S,93S,96S für Fahrzeuge mit Zweis Scheibenkupplung / for vehicles with double disc clutch enthält eine Kupplungsscheibe / This part number includes one clutch disc	(77)	(67)
41.440 FFDC-TM, FFDC-TM, FFD-TM 39S 39W 79W	06.08-						
41.440 FFDK 39S	07.08-		 1878 002 643	400 10 400WGTZ	Getr. / GBox: ZF Ecosplit 3 39S,59S,73S,93S,96S für Fahrzeuge mit Zweis Scheibenkupplung / for vehicles with double disc clutch	(77)	
41.440 FFDK, FFDRK 79W 39W 39S	10.07-		 3151 262 031	KZISZ-5	Getr. / GBox: ZF Ecosplit 3 39S,59S,73S,93S,96S für Fahrzeuge mit Zweis Scheibenkupplung / for vehicles with double disc clutch	(77)	
41.440 FFDK, FFDRK 39W 39S 79W	06.08-		 3496 006 000		39S,59S,73S,93S,96S langer Bügel / long handle	(86)	
			 1863 869 038		39S,59S,73S,93S,96S		
			 3189 600 036		für Fahrzeuge mit Zweis Scheibenkupplung / for vehicles with double disc clutch	(77)	
			3189 600 004		Getr. / GBox: ZF AS Tronic Rollenausführung / roller version	(58)	
			3189 600 020		Getr. / GBox: ZF Ecosplit-3		

		CODE		 Parameter		
--	--	------	--	---	---	---













MAN

TGS		08.07 -				
35.480 FDNLC, FFDC, FFDLC 92S 41S 37S 35.480 FFDK, FFDLK, FFDRK 41S 37S 35.480 FFD-TM 37S	06.08-	D2676LF07, D2676LF14, D2676LF05, D2676LF25	 3400 700 460 HD  3482 000 246  1878 004 104  3151 000 034	430 10 MFZ430 430WGTZ KZISZ-5	Getr. / GBox: ZF Ecosplit 3 37S,41S,92S,96S Euro5/Euro6 / Euro5/Euro6	(21)
	08.08-		 3400 700 459 HD  3482 000 246  1878 004 104  3151 000 493	430 10 MFZ430 430WGTZ KZISZ-5	Getr. / GBox: ZF AS-Tronic 37S,41S,92S,96S Euro5/Euro6 / Euro5/Euro6 für Ausrückgabel mit Rollen / for release fork with rollers	(21) (71)
	10.07-		 3151 000 144	430 10 KZISZ-5	Getr. / GBox: ZF AS-Tronic 37S,41S,92S,96S Euro5/Euro6 / Euro5/Euro6 für Ausrückgabel mit Nocken / for release fork with cams	(21) (70)
			 3400 700 327  3482 114 031  1878 004 832  3151 263 031	430 10 GMFZ430N 430WGTZ KZIZ-6	Getr. / GBox: ZF Ecosplit 3 37S,41S,92S,96S Euro5/Euro6 / Euro5/Euro6 für Nebenantrieb / for PTO	(21) (82)
			 3400 700 641 HD  3482 114 031  1878 007 729  3151 263 031	430 10 GMFZ430N 430WGTZ KZIZ-6	Getr. / GBox: ZF Ecosplit 3 37S,41S,92S,96S Euro5/Euro6 / Euro5/Euro6 Nebenantriebs-ID / PTO ID: NMV 221	(21) (50)
			 3488 017 447	400 MFZ2/400X	Getr. / GBox: ZF Ecosplit 3 37S,41S,92S,96S Euro5/Euro6 / Euro5/Euro6 für Fahrzeuge mit Zweischeibenkupplung / for vehicles with double disc clutch enthält eine Kupplungsscheibe / This part number includes one clutch disc	(21) (77) (67)
			 1878 002 643	400 10 400WGTZ	Getr. / GBox: ZF Ecosplit 3 37S,41S,92S,96S Euro5/Euro6 / Euro5/Euro6 für Fahrzeuge mit Zweischeibenkupplung / for vehicles with double disc clutch	(21) (77)
			 3151 262 031	400 10 KZISZ-5	Getr. / GBox: ZF Ecosplit 3 37S,41S,92S,96S Euro5/Euro6 / Euro5/Euro6 für Fahrzeuge mit Zweischeibenkupplung / for vehicles with double disc clutch	(21) (77)
			 3496 006 000		37S,41S,92S,96S Euro5/Euro6 / Euro5/Euro6 langer Bügel / long handle	(21) (86)
			 1863 869 038		37S,41S,92S,96S Euro5/Euro6 / Euro5/Euro6	(21)
			 3189 600 036		für Fahrzeuge mit Zweischeibenkupplung / for vehicles with double disc clutch	(77)
			3189 600 004		Getr. / GBox: ZF AS Tronic Rollenausführung / roller version	(58)

TGS	08.07 -								
35.480 FFDK 60W 96S 35.480 FFDK, FFDHLK 59S 93S 35.480 FFHLC 73S 35.480 FFHLC 73S 35.540 FDNLK, FFDC, FFDLC 92S 41S 37S 35.540 FFDK, FFDLK, FFDRK 41S 37S 35.540 FFHLC 73S 35.540 FFNLC 90S 41.480 FFDK 93S 41.480 FFDK 60W 96S	06.08-	D2676LF20, D2676LF13, D2676LF14, D2676LF07, D2676LF06, D2676LF05, D2676LF02, D2676LF25		3400 700 460 HD  3482 000 246  1878 004 104  3151 000 034	430 10 MFZ430 430WGTZ KZISZ-5	Getr. / GBox: ZF Ecosplit 3			
	06.08-			3400 700 459 HD  3482 000 246  1878 004 104  3151 000 493	430 10 MFZ430 430WGTZ KZISZ-5	Getr. / GBox: ZF AS-Tronic für Ausrückgabel mit Rollen / for release fork with rollers	(71)		
	06.08-			3151 000 144	KZISZ-5	Getr. / GBox: ZF AS-Tronic für Ausrückgabel mit Nocken / for release fork with cams	(70)		
	02.09-			3400 700 327  3482 114 031  1878 004 832  3151 263 031	430 10 GMFZ430N 430WGTZ KZIZ-6	Getr. / GBox: ZF Ecosplit 3 für Nebenantrieb / for PTO	(82)		
	06.08-			3400 700 641 HD  3482 114 031  1878 007 729  3151 263 031	430 10 GMFZ430N 430WGTZ KZIZ-6	Getr. / GBox: ZF Ecosplit 3 Nebenantriebs-ID / PTO ID: NMV 221	(50)		
	06.08-			3488 017 447	400 MFZ2/400X	Getr. / GBox: ZF Ecosplit 3 für Fahrzeuge mit Zweischeibenkupplung / for vehicles with double disc clutch enthält eine Kupplungsscheibe / This part number includes one clutch disc	(77) (67)		
				1878 002 643	400 10 400WGTZ	Getr. / GBox: ZF Ecosplit 3 für Fahrzeuge mit Zweischeibenkupplung / for vehicles with double disc clutch	(77)		
				3151 262 031	KZISZ-5	Getr. / GBox: ZF Ecosplit 3 für Fahrzeuge mit Zweischeibenkupplung / for vehicles with double disc clutch	(77)		
				3496 006 000		langer Bügel / long handle	(86)		
				1863 869 038					
				3189 600 036		für Fahrzeuge mit Zweischeibenkupplung / for vehicles with double disc clutch	(77)		
				3189 600 004		Getr. / GBox: ZF AS Tronic Rollenausführung / roller version	(58)		
	35.540 FFDK 96S 35.540 FFDK, FFDHLK 59S 93S 35.540 FFD-TM 37S 37.540 FFDC 39S 37.540 FFDK 39S 37.540 FFD-TM 39S 41.540 FFDK 93S 41.540 FFDK 96S 41.540 FFDC 39S 41.540 FFDK 39S 41.540 FFD-TM 39S		02.09-	D2676LF13, D2676LF06		3400 700 460 HD  3482 000 246  1878 004 104  3151 000 034	430 10 MFZ430 430WGTZ KZISZ-5	Getr. / GBox: ZF Ecosplit 3 37S,39S,93S,96S	
			02.09-			3400 700 459 HD  3482 000 246  1878 004 104  3151 000 493	430 10 MFZ430 430WGTZ KZISZ-5	Getr. / GBox: ZF AS-Tronic für Ausrückgabel mit Rollen / for release fork with rollers	(71)
02.09-			3151 000 144		KZISZ-5	Getr. / GBox: ZF AS-Tronic für Ausrückgabel mit Nocken / for release fork with cams	(70)		
02.09-			3400 700 327  3482 114 031  1878 004 832  3151 263 031		430 10 GMFZ430N 430WGTZ KZIZ-6	Getr. / GBox: ZF Ecosplit 3 37S,39S,93S,96S für Nebenantrieb / for PTO	(82)		
02.09-			3400 700 641 HD  3482 114 031  1878 007 729  3151 263 031		430 10 GMFZ430N 430WGTZ KZIZ-6	Getr. / GBox: ZF Ecosplit 3 37S,39S,93S,96S Nebenantriebs-ID / PTO ID: NMV 221	(50)		
02.09-			3488 017 447		400 MFZ2/400X	Getr. / GBox: ZF Ecosplit 3 37S,39S,93S,96S für Fahrzeuge mit Zweischeibenkupplung / for vehicles with double disc clutch enthält eine Kupplungsscheibe / This part number includes one clutch disc	(77) (67)		
			1878 002 643		400 10 400WGTZ	Getr. / GBox: ZF Ecosplit 3 37S,39S,93S,96S für Fahrzeuge mit Zweischeibenkupplung / for vehicles with double disc clutch	(77)		
			3151 262 031		KZISZ-5	Getr. / GBox: ZF Ecosplit 3 37S,39S,93S,96S für Fahrzeuge mit Zweischeibenkupplung / for vehicles with double disc clutch	(77)		
			3496 006 000			37S,39S,93S,96S langer Bügel / long handle	(86)		
			1863 869 038			37S,39S,93S,96S			
			3189 600 036			für Fahrzeuge mit Zweischeibenkupplung / for vehicles with double disc clutch	(77)		
			3189 600 004			Getr. / GBox: ZF AS Tronic			























		CODE				
--	--	------	--	---	---	---

MAN

TGS		08.07 -				
37.320 FFDC 39S	07.08-	D2066LF37, D2066LF27, D2066LF42, D2066LF28,	 3400 700 380 ⊗ 3482 000 361 ⊗ 1878 080 037 ⊖ 3151 000 034	430 10 MFZ430 430WGTZ KZISZ-5	Getr. / GBox: ZF Ecosplit-3 39S Euro4/Euro5 / Euro4/Euro5 Euro 6 / Euro 6	(20) (18)
37.320 FFDC 39S	07.08-	D2066LF43, D2066LF41, D2066LF63, D2066LF39, D2066LF26, D2066LF07, D2066LF48, D2066LF61, D2066LF68, D2066LF06, D2066LF64, D2066LF67, D2066LF49, D2066LF38	 3400 700 381 ⊗ 3482 000 361 ⊗ 1878 080 037 ⊖ 3151 000 493	430 10 MFZ430 430WGTZ KZISZ-5	Getr. / GBox: ZF AS-Tronic 39S Euro4/Euro5 / Euro4/Euro5 Euro 6 / Euro 6 für Ausrückgabel mit Rollen / for release fork with rollers	(20) (18) (71)
37.320 FFD-TM 39S	10.07-		 3400 700 403 ⊗ 3482 000 361 ⊗ 1878 004 832 ⊖ 3151 000 144	430 10 MFZ430 430WGTZ KZISZ-5	Getr. / GBox: ZF AS-Tronic 39S Euro4/Euro5 / Euro4/Euro5 Euro 6 / Euro 6 für Ausrückgabel mit Nocken / for release fork with cams	(20) (18) (70)
37.360 FFDC 39S	07.08-		 3400 700 327 ⊗ 3482 114 031 ⊗ 1878 004 832 ⊖ 3151 263 031	430 10 GMFZ430N 430WGTZ KZIZ-6	Getr. / GBox: ZF Ecosplit-3 39S Euro4/Euro5 / Euro4/Euro5 Euro 6 / Euro 6 für Nebenantrieb / for PTO	(20) (18) (82)
37.360 FFD-TM 39S	10.07-		 3400 700 641 HD ⊗ 3482 114 031 ⊗ 1878 007 729 ⊖ 3151 263 031	430 10 GMFZ430N 430WGTZ KZIZ-6	Getr. / GBox: ZF Ecosplit-3 39S Euro4/Euro5 / Euro4/Euro5 Euro 6 / Euro 6 Nebenantriebs-ID / PTO ID: NMV 221	(20) (18) (50)
37.400 FFDC 39S	07.08-		 3488 017 447	400 MFZ2/400X	Getr. / GBox: ZF Ecosplit-3 39S Euro4/Euro5 / Euro4/Euro5 Euro 6 / Euro 6 für Fahrzeuge mit Zweis Scheibenkupplung / for vehicles with double disc clutch enthält eine Kupplungsscheibe / This part number includes one clutch disc	(20) (18) (77) (67)
37.400 FFDK 39S	07.08-		 1878 002 643	400 10 400WGTZ	Getr. / GBox: ZF Ecosplit-3 39S Euro4/Euro5 / Euro4/Euro5 Euro 6 / Euro 6 für Fahrzeuge mit Zweis Scheibenkupplung / for vehicles with double disc clutch	(20) (18) (77)
37.400 FFDK 39S	07.08-		 3151 262 031	KZISZ-5	Getr. / GBox: ZF Ecosplit-3 39S Euro4/Euro5 / Euro4/Euro5 Euro 6 / Euro 6 für Fahrzeuge mit Zweis Scheibenkupplung / for vehicles with double disc clutch	(20) (18) (77)
37.400 FFD-TM 39S	10.07-		 3496 006 000		Getr. / GBox: ZF 39S Euro4/Euro5 / Euro4/Euro5 Euro 6 / Euro 6 langer Bügel / long handle	(20) (18) (86)
37.400 FFD-TM 39S	10.07-		 1863 869 038		Getr. / GBox: ZF 39S Euro4/Euro5 / Euro4/Euro5 Euro 6 / Euro 6	(20) (18)
37.400 FFDK 39S	07.08-		 3189 600 036		für Fahrzeuge mit Zweis Scheibenkupplung / for vehicles with double disc clutch	(77)
			 3189 600 004		Getr. / GBox: ZF AS Tronic Rollenausführung / roller version	(58)
			 3189 600 020		Getr. / GBox: ZF Ecosplit-3	











		CODE				
--	--	------	--	---	---	---

MAN













TGS		08.07 -					
37.480 FFDC 39S 37.480 FFDK 39S 37.480 FFD-TM 39S 41.480 FFD, FFDC, FFDR 39W 79W 39S 41.480 FFDC, FFDR, FFDARC 96S 41.480 FFDC-TM, FFDR-TM, FFD-TM 39W 39S 79W 41.480 FFDK, FDRK 39S 39W 79W	07.08-	D2676LF20, D2676LF07, D2676LF14, D2676LF05, D2676LF02, D2676LF25, D2676LF03		3400 700 460 HD  3482 000 246  1878 004 104  3151 000 034	430 10 MFZ430 430WGTZ KZISZ-5	Getr. / GBox: ZF Ecosplit 3 37S,39S,93S,96S Euro4/Euro5 / Euro4/Euro5 Euro 6 / Euro 6	(20) (18)
	07.08-			3400 700 459 HD  3482 000 246  1878 004 104  3151 000 493	430 10 MFZ430 430WGTZ KZISZ-5	Getr. / GBox: ZF AS-Tronic 37S,39S,93S,96S Euro4/Euro5 / Euro4/Euro5 Euro 6 / Euro 6 für Ausrückgabel mit Rollen / for release fork with rollers	(20) (18) (71)
	06.08-			3151 000 144	KZISZ-5	Getr. / GBox: ZF AS-Tronic 37S,39S,93S,96S Euro4/Euro5 / Euro4/Euro5 Euro 6 / Euro 6 für Ausrückgabel mit Nocken / for release fork with cams	(20) (18) (70)
	10.07-			3400 700 327  3482 114 031  1878 004 832  3151 263 031	430 10 GMFZ430N 430WGTZ KZIZ-6	Getr. / GBox: ZF Ecosplit 3 37S,39S,93S,96S Euro4/Euro5 / Euro4/Euro5 Euro 6 / Euro 6 für Nebenantrieb / for PTO	(20) (18) (82)
	07.08-			3400 700 641 HD  3482 114 031  1878 007 729  3151 263 031	430 10 GMFZ430N 430WGTZ KZIZ-6	Getr. / GBox: ZF Ecosplit 3 37S,39S,93S,96S Euro4/Euro5 / Euro4/Euro5 Euro 6 / Euro 6 Nebenantriebs-ID / PTO ID: NMV 221	(20) (18) (50)
				3488 017 447	400 MFZ2/400X	Getr. / GBox: ZF Ecosplit 3 37S,39S,93S,96S Euro4/Euro5 / Euro4/Euro5 Euro 6 / Euro 6 für Fahrzeuge mit Zweischeibenkupplung / for vehicles with double disc clutch enthält eine Kupplungsscheibe / This part number includes one clutch disc	(20) (18) (77) (67)
				1878 002 643	400 10 400WGTZ	Getr. / GBox: ZF Ecosplit 3 37S,39S,93S,96S Euro4/Euro5 / Euro4/Euro5 Euro 6 / Euro 6 für Fahrzeuge mit Zweischeibenkupplung / for vehicles with double disc clutch	(20) (18) (77)
				3151 262 031	KZISZ-5	Getr. / GBox: ZF Ecosplit 3 37S,39S,93S,96S Euro4/Euro5 / Euro4/Euro5 Euro 6 / Euro 6 für Fahrzeuge mit Zweischeibenkupplung / for vehicles with double disc clutch	(20) (18) (77)
				3496 006 000		37S,39S,93S,96S Euro4/Euro5 / Euro4/Euro5 Euro 6 / Euro 6 langer Bügel / long handle	(20) (18) (86)
				1863 869 038		37S,39S,93S,96S Euro4/Euro5 / Euro4/Euro5 Euro 6 / Euro 6	(20) (18)
				3189 600 036		für Fahrzeuge mit Zweischeibenkupplung / for vehicles with double disc clutch	(77)
				3189 600 004		Getr. / GBox: ZF AS Tronic Rollenausführung / roller version	(58)

		CODE				
--	--	------	--	---	---	---

MAN











TGX		09.07 -				
18.360 FHLC 22X	10.07-	D2066LF37, D2066LF27,	 3400 700 380 ⊗ 3482 000 361 ⊗ 1878 080 037 ⊙ 3151 000 034	430 10 MFZ430 430WGTZ KZISZ-5	Getr. / GBox: ZF Ecosplit 3	
18.360 FHLS, FHLS/M 22X	10.07-	D2066LF42, D2066LF41, D2066LF26, D2676LF13, D2676LF14, D2676LF07, D2676LF06,	 3400 700 381 ⊗ 3482 000 361 ⊗ 1878 080 037 ⊙ 3151 000 493	430 10 MFZ430 430WGTZ KZISZ-5	Getr. / GBox: ZF AS-Tronic für Ausrückgabel mit Rollen / for release fork with rollers	(71)
18.360 FLC, FLRC, FLLC, FLLRC, FLLW, FLLW/N 06X 10X 15X	10.07-	D2676LF13, D2676LF14, D2676LF07, D2676LF06,	 3400 700 403 ⊗ 3482 000 361 ⊗ 1878 004 832 ⊙ 3151 000 144	430 10 MFZ430 430WGTZ KZISZ-5	Getr. / GBox: ZF AS-Tronic für Ausrückgabel mit Nocken / for release fork with cams	(70)
18.360 FLS, FLS/M, FLRS, FLRS/N, FLLS, FLLS/N, FLLRS,FLLRS/N 10X 15X 13X 06X	10.07-	D2066LF25, D2066LF52, D2066LF36, D2676LF05, D2066LF61, D2676LF25, D2066LF67, D2066LF40, D2066LF38, D2676LF51	 3400 700 327 ⊗ 3482 114 031 ⊗ 1878 004 832 ⊙ 3151 263 031	430 10 GMFZ430N 430WGTZ KZISZ-6	Getr. / GBox: ZF Ecosplit 3 für Nebenantrieb / for PTO	(82)
18.400 FHLC 22X	10.07-	D2676LF05, D2066LF61, D2676LF25, D2066LF67, D2066LF40, D2066LF38, D2676LF51	 3400 700 641 HD ⊗ 3482 114 031 ⊗ 1878 007 729 ⊙ 3151 263 031	430 10 GMFZ430N 430WGTZ KZISZ-6	Getr. / GBox: ZF Ecosplit 3 Nebenantriebs-ID / PTO ID: NMV 221	(50)
18.400 FHLS, FHLS/M 22X	10.07-	D2066LF67, D2066LF40, D2066LF38, D2676LF51	 3488 017 447	400 MFZ2/400X	Getr. / GBox: ZF Ecosplit 3 für Fahrzeuge mit Zweis Scheibenkupplung / for vehicles with double disc clutch enthält eine Kupplungsscheibe / This part number includes one clutch disc	(77) (67)
18.400 FLC, FLRC, FLLC, FLLRC, FLLW, FLLW/N 06X 15X 10X	10.07-	D2066LF38, D2676LF51	 1878 002 643	400 10 400WGTZ	Getr. / GBox: ZF Ecosplit 3 für Fahrzeuge mit Zweis Scheibenkupplung / for vehicles with double disc clutch	(77)
18.400 FLS, FLS/M, FLRS, FLRS/N, FLLS, FLLS/N, FLLRS,FLLRS/N 13X 05X 10X 06X	10.07-		 3151 262 031	KZISZ-5	Getr. / GBox: ZF Ecosplit 3 für Fahrzeuge mit Zweis Scheibenkupplung / for vehicles with double disc clutch	(77)
26.360 FDHLC 70X	10.07-		 3496 006 000		langer Bügel / long handle	(86)
26.360 FDHLS 70X	10.07-		 1863 869 038			
26.360 FNHLC 35X	10.07-		 3189 600 036		für Fahrzeuge mit Zweis Scheibenkupplung / for vehicles with double disc clutch	(77)
26.360 FNHLS 35X	10.07-		3189 600 004		Getr. / GBox: ZF AS Tronic Rollenausführung / roller version	(58)
26.360 FNLS, FNLLS, FNLRS, FNLLRS, FPLS, FPLRS, FVLS 18X 21X 24X	10.07-		3189 600 020		Getr. / GBox: ZF Ecosplit-3	
26.400 FDHLC 70X	10.07-					
26.400 FDHLS 70X	10.07-					
26.400 FNHLC 35X	12.07-					
26.400 FNHLS 35X	12.07-					
26.400 FNLS, FNLLS, FNLRS, FNLLRS, FPLS, FPLRS, FVLS 18X 21X 24X	10.07-					
28.360 FNLC 89X	10.07-					
28.360 FNLS 89X	10.07-					
28.400 FNLC 89X	10.07-					
28.400 FNLS 89X	10.07-					
33.400 FDC, FDC/M, FDLC, FDLRC, FDRC 26X 30X	10.07-					
33.400 FDS, FDS/M, FDLS, FDLS/M 26X 30X	10.07-					
35.360 FDNLC 92X	06.08-					
35.400 FDNLC 92X	06.08-					
35.440 FDNLC 92X	06.08-					
35.480 FDNLC 92X	06.08-					
35.540 FDNLC 92X	06.08-					

MAN

TGX		09.07 -				
18.440 FHLC 22X	10.07-	D2066LF25, D2066LF36, D2066LF40	 3400 700 402 ⊗ 3482 000 246 ⊗ 1878 002 139 ⊙ 3151 000 034	430 10 MFZ430 430WGTZ KZISZ-5	Getr. / GBox: ZF Ecosplit 3 22X,35X,70X	
18.440 FHLS, FHLS/M 22X	10.07-		 3400 700 460 HD ⊗ 3482 000 246 ⊗ 1878 004 104 ⊙ 3151 000 034	430 10 MFZ430 430WGTZ KZISZ-5	Getr. / GBox: ZF Ecosplit 3 22X,35X,70X	
26.440 FDHLC 70X	09.07-		 3400 700 381 ⊗ 3482 000 361 ⊗ 1878 080 037 ⊙ 3151 000 493	430 10 MFZ430 430WGTZ KZISZ-5	Getr. / GBox: ZF AS-Tronic 22X,35X,70X für Ausrückgabel mit Rollen / for release fork with rollers	(71)
26.440 FDHLS 70X	10.07-		 3400 700 403 ⊗ 3482 000 361 ⊗ 1878 004 832 ⊙ 3151 000 144	430 10 MFZ430 430WGTZ KZISZ-5	Getr. / GBox: ZF AS-Tronic 22X,35X,70X für Ausrückgabel mit Nocken / for release fork with cams	(70)
26.440 FNHLC 35X	12.07-		 3400 700 327 ⊗ 3482 114 031 ⊗ 1878 004 832 ⊙ 3151 263 031	430 10 GMFZ430N 430WGTZ KZISZ-6	Getr. / GBox: ZF Ecosplit 3 22X,35X,70X für Nebenantrieb / for PTO	(82)
26.440 FNHLS 35X	12.07-		 3400 700 641 HD ⊗ 3482 114 031 ⊗ 1878 007 729 ⊙ 3151 263 031	430 10 GMFZ430N 430WGTZ KZISZ-6	Getr. / GBox: ZF Ecosplit 3 22X,35X,70X Nebenantriebs-ID / PTO ID: NMV 221	(50)
			 3488 017 447	400 MFZ2/400X	Getr. / GBox: ZF Ecosplit 3 22X,35X,70X für Fahrzeuge mit Zweischeibenkupplung / for vehicles with double disc clutch enthält eine Kupplungsscheibe / This part number includes one clutch disc	(77) (67)
			 1878 002 643	400 10 400WGTZ	Getr. / GBox: ZF Ecosplit 3 22X,35X,70X für Fahrzeuge mit Zweischeibenkupplung / for vehicles with double disc clutch	(77)
			 3151 262 031	KZISZ-5	Getr. / GBox: ZF Ecosplit 3 22X,35X,70X für Fahrzeuge mit Zweischeibenkupplung / for vehicles with double disc clutch	(77)
			 3496 006 000		22X,35X,70X langer Bügel / long handle	(86)
			 1863 869 038		22X,35X,70X	
			 3189 600 036		für Fahrzeuge mit Zweischeibenkupplung / for vehicles with double disc clutch	(77)
			3189 600 004		Getr. / GBox: ZF AS Tronic Rollenausführung / roller version	(58)
			3189 600 020		Getr. / GBox: ZF Ecosplit-3	































		CODE				
--	--	------	--	---	---	---

MAN

TGX		09.07 -				
18.440 FHLS, FHLS/M 22X	10.12-	D2676LF26, D2676LF13, D2676LF07, D2676LF14, D2676LF22, D2676LF06, D2676LF05, D2676LF25, D2676440	 3400 700 460 HD ⊗ 3482 000 246 ⊗ 1878 004 104 ⊙ 3151 000 034	430 10 MFZ430 430WGTZ KZISZ-5	Getr. / GBox: ZF Ecosplit 3 Euro 6 / Euro 6	(18)
18.440 FLC, FLLC, FLLRC, FLLW, FLRC 06X 15X 10X	10.07-		 3400 700 459 HD ⊗ 3482 000 246 ⊗ 1878 004 104 ⊙ 3151 000 493	430 10 MFZ430 430WGTZ KZISZ-5	Getr. / GBox: ZF AS-Tronic Euro 6 / Euro 6 für Ausrückgabel mit Rollen / for release fork with rollers	(18) (71)
18.440 FLS, FLSS, FLSS/N, FLRS, FLRS/N, FLLRS, FLLS 06X 10X 13X 05X	10.07-		 3151 000 144	KZISZ-5	Getr. / GBox: ZF AS-Tronic Euro 6 / Euro 6 für Ausrückgabel mit Nocken / for release fork with cams	(18) (70)
18.480 FHLC 22X	10.07-		 3400 700 327 ⊗ 3482 114 031 ⊗ 1878 004 832 ⊙ 3151 263 031	430 10 GMFZ430N 430WGTZ KZIZ-6	Getr. / GBox: ZF Ecosplit 3 Euro 6 / Euro 6 für Nebenantrieb / for PTO	(18) (82)
18.480 FHLS, FHLS/M 22X	10.07-		 3400 700 641 HD ⊗ 3482 114 031 ⊗ 1878 007 729 ⊙ 3151 263 031	430 10 GMFZ430N 430WGTZ KZIZ-6	Getr. / GBox: ZF Ecosplit 3 Euro 6 / Euro 6 Nebenantriebs-ID / PTO ID: NMV 221	(18) (50)
18.540 FHLC 22X	10.07-		 3488 017 447	400 MFZ2/400X	Getr. / GBox: ZF Ecosplit 3 Euro 6 / Euro 6 für Fahrzeuge mit Zweischeibenkupplung / for vehicles with double disc clutch	(18) (77)
18.540 FHLS, FHLS/M 22X	10.07-		 1878 002 643	400 10 400WGTZ	Getr. / GBox: ZF Ecosplit 3 Euro 6 / Euro 6 für Fahrzeuge mit Zweischeibenkupplung / for vehicles with double disc clutch	(18) (77)
24.440 FNLLW/N 45X	10.12-		 3151 262 031	KZISZ-5	Getr. / GBox: ZF Ecosplit 3 Euro 6 / Euro 6 für Fahrzeuge mit Zweischeibenkupplung / for vehicles with double disc clutch	(18) (77)
24.440 FPLS, FPLRS 24X	10.07-		 3496 006 000		Euro 6 / Euro 6 langer Bügel / long handle	(18) (86)
26.440 FDLRS, FDLS, FDRS, FDS, FNHLS, FPHLS, FVHLS 30X 26X	10.12-		 1863 869 038		Euro 6 / Euro 6	(18)
26.440 FNLC, FNLRC, FNLLC, FNLLRC, FNLLW 21X 18X	10.12-		 3189 600 036		für Fahrzeuge mit Zweischeibenkupplung / for vehicles with double disc clutch	(77)
26.440 FNLS, FNLLS, FNLRS, FNLLRS, FPLS, FPLRS, FVLS 21X 18X 24X	10.12-		3189 600 004		Getr. / GBox: ZF AS Tronic Rollenausführung / roller version	(58)
26.440 FPLRS 24X	07.08-					
28.440 FNLC 89X	10.12-					
28.440 FNLS 89X	10.12-					
33.440 FDC, FDC/M, FDLC, FDLRC, FDRC 26X 30X	09.09-					
33.440 FDS, FDS/M, FDLS, FDLS/M 26X 30X	10.12-					







































		CODE				
--	--	------	--	---	---	---

MAN

TGX		09.07 -				
18.440 FLC, FLRC, FLLC, FLLRC, FLLW, FLLW/N 15X 10X 06X 18.440 FLS, FLS/M, FLRS, FLRS/M, FLLS, FLLS/N, FLLRS, FLLRS/ 13X 10X 06X 05X	10.07 -	D2066LF25, D2066LF36, D2066LF40	 3400 700 402  3482 000 246  1878 002 139  3151 000 034	430 10 MFZ430 430WGTZ KZISZ-5	Getr. / GBox: ZF Ecosplit 3 05X,06X10X,13X,15X	
	10.07 -		 3400 700 460 HD  3482 000 246  1878 004 104  3151 000 034	430 10 MFZ430 430WGTZ KZISZ-5	Getr. / GBox: ZF Ecosplit 3 05X,06X10X,13X,15X	
			 3400 700 381  3482 000 361  1878 080 037  3151 000 493	430 10 MFZ430 430WGTZ KZISZ-5	Getr. / GBox: ZF AS-Tronic 05X,06X10X,13X,15X für Ausrückgabel mit Rollen / for release fork with rollers	(71)
			 3400 700 403  3482 000 361  1878 004 832  3151 000 144	430 10 MFZ430 430WGTZ KZISZ-5	Getr. / GBox: ZF AS-Tronic 05X,06X10X,13X,15X für Ausrückgabel mit Nocken / for release fork with cams	(70)
			 3400 700 327  3482 114 031  1878 004 832  3151 263 031	430 10 GMFZ430N 430WGTZ KZIZ-6	Getr. / GBox: ZF Ecosplit 3 05X,06X10X,13X,15X für Nebenantrieb / for PTO	(82)
			 3400 700 641 HD  3482 114 031  1878 007 729  3151 263 031	430 10 GMFZ430N 430WGTZ KZIZ-6	Getr. / GBox: ZF Ecosplit 3 05X,06X10X,13X,15X Nebenantriebs-ID / PTO ID: NMV 221	(50)
			 3488 017 447	400 MFZ2/400X	Getr. / GBox: ZF Ecosplit 3 05X,06X10X,13X,15X für Fahrzeuge mit Zweischeibenkupplung / for vehicles with double disc clutch enthält eine Kupplungsscheibe / This part number includes one clutch disc	(77) (67)
			 1878 002 643	400 10 400WGTZ	Getr. / GBox: ZF Ecosplit 3 05X,06X10X,13X,15X für Fahrzeuge mit Zweischeibenkupplung / for vehicles with double disc clutch	(77)
			 3151 262 031	KZISZ-5	Getr. / GBox: ZF Ecosplit 3 05X,06X10X,13X,15X für Fahrzeuge mit Zweischeibenkupplung / for vehicles with double disc clutch	(77)
			 3496 006 000		05X,06X10X,13X,15X langer Bügel / long handle	(86)
			 1863 869 038		05X,06X10X,13X,15X	
			 3189 600 036		für Fahrzeuge mit Zweischeibenkupplung / for vehicles with double disc clutch	(77)
			3189 600 004		Getr. / GBox: ZF AS Tronic Rollenausführung / roller version	(58)
	3189 600 020		Getr. / GBox: ZF Ecosplit-3			











		CODE				
--	--	------	--	---	---	---

MAN

TGX		09.07 -					
18.480 FLC, FLRC, FLLC, FLLRC, FLLW, FLLW/N 06X 10X 15X 18.480 FLS, FLS/M, FLRS, FLRS/N, FLLS, FLLS/N, FLLRS, FLLRS/N 06X 13X 05X 10X 18.540 FLC, FLRC, FLLC, FLLRC, FLLW, FLLW/N 06X 10X 15X 18.540 FLS, FLS/M, FLRS, FLRS/N, FLLS, FLLS/N, FLLRS, FLLRS/N 13X 10X 05X 06X	10.07 -	D2676LF07, D2676LF14, D2676LF13, D2676LF06, D2676LF05, D2676LF21, D2676LF25	 3400 700 460 HD  3482 000 246  1878 004 104  3151 000 034	430 10 MFZ430 430WGTZ KZISZ-5	Getr. / GBox: ZF Ecosplit 3 05X,06X,10X,13X,15X		
	10.07 -		 3400 700 459 HD  3482 000 246  1878 004 104  3151 000 493	430 10 MFZ430 430WGTZ KZISZ-5	Getr. / GBox: ZF AS-Tronic 05X,06X,10X,13X,15X für Ausrückgabel mit Rollen / for release fork with rollers	(71)	
	10.07 -		 3151 000 144	KZISZ-5	Getr. / GBox: ZF AS-Tronic 05X,06X,10X,13X,15X für Ausrückgabel mit Nocken / for release fork with cams	(70)	
	10.07 -		 3400 700 327  3482 114 031  1878 004 832  3151 263 031	430 10 GMFZ430N 430WGTZ KZIZ-6	Getr. / GBox: ZF Ecosplit 3 05X,06X,10X,13X,15X für Nebenantrieb / for PTO	(82)	
			 3400 700 641 HD  3482 114 031  1878 007 729  3151 263 031	430 10 GMFZ430N 430WGTZ KZIZ-6	Getr. / GBox: ZF Ecosplit 3 05X,06X,10X,13X,15X Nebenantriebs-ID / PTO ID: NMV 221	(50)	
			 3488 017 447	400 MFZ2/400X	Getr. / GBox: ZF Ecosplit 3 05X,06X,10X,13X,15X für Fahrzeuge mit Zweischeibenkupplung / for vehicles with double disc clutch enthält eine Kupplungsscheibe / This part number includes one clutch disc	(77) (67)	
			 1878 002 643	400 10 400WGTZ	Getr. / GBox: ZF Ecosplit 3 05X,06X,10X,13X,15X für Fahrzeuge mit Zweischeibenkupplung / for vehicles with double disc clutch	(77)	
			 3151 262 031	KZISZ-5	Getr. / GBox: ZF Ecosplit 3 05X,06X,10X,13X,15X für Fahrzeuge mit Zweischeibenkupplung / for vehicles with double disc clutch	(77)	
			 3496 006 000		05X,06X,10X,13X,15X langer Bügel / long handle	(86)	
			 1863 869 038		05X,06X,10X,13X,15X		
	 3189 600 036		für Fahrzeuge mit Zweischeibenkupplung / for vehicles with double disc clutch	(77)			
	3189 600 004		Getr. / GBox: ZF AS Tronic Rollenausführung / roller version	(58)			
18.520 FLS 18.560 FLS 18.640 FLS 41.640 FLS	09.14 -	D3876LF03, D3876LF01, D3876LF02	 3400 700 613  3482 001 145  1878 007 126  3151 000 493	430 10 MZ430 430WGTPZ KZISZ-5	Getr. / GBox: AS Tronic Euro 6 / Euro 6	(18)	
	09.14 -		 3400 700 614  3482 001 180  1878 007 126	430 10 M430 430WGTPZ	Getr. / GBox: Traxon Euro 6 / Euro 6	(18)	
	09.16 -		 6482 000 216	PHIS-6/38	Getr. / GBox: Traxon Euro 6 / Euro 6 Immer erneuern / Renew everytime	(18) (30)	
	09.14 -		 3189 600 004		Getr. / GBox: ZF AS Tronic Rollenausführung / roller version	(58)	
18.680 FLS 78X 33.680 FDLC 79X 33.680 FDLs 79X 41.680 FVDS, FVDLS 94X 95X	10.07 -	D2868LF03, D2868LF06, D2868LF02, D2868LF05	 3400 700 494  3482 000 819  1878 005 411  3151 000 493	430 10 MFZ430 430WGTZ KZISZ-5	Getr. / GBox: ZF AS-Tronic		
	10.07 -		 1863 869 038				
	10.07 -		 3189 600 004		Getr. / GBox: ZF AS Tronic Rollenausführung / roller version	(58)	















		CODE				
--	--	------	--	---	---	---











MAN

TGX		09.07 -				
24.360 FNLLW/N 45X	10.07-	D2066LF37, D2066LF27, D2066LF42, D2066LF41, D2066LF26, D2066LF52, D2066LF61, D2066LF67, D2066LF38, D2066LF51	 3400 700 380 ⊗ 3482 000 361 ⊗ 1878 080 037 ⊙ 3151 000 034	430 10 MFZ430 430WGTZ KZISZ-5	Getr. / GBox: ZF Ecosplit 3 24X,42X,45X	
24.360 FPLS, FPLRS 24X 45X	10.07-		 3400 700 381 ⊗ 3482 000 361 ⊗ 1878 080 037 ⊙ 3151 000 493	430 10 MFZ430 430WGTZ KZISZ-5	Getr. / GBox: ZF AS-Tronic 24X,42X,45X für Ausrückgabel mit Rollen / for release fork with rollers	(71)
24.400 FNLLW/N 45X	10.07-		 3400 700 403 ⊗ 3482 000 361 ⊗ 1878 004 832 ⊙ 3151 000 144	430 10 MFZ430 430WGTZ KZISZ-5	Getr. / GBox: ZF AS-Tronic 24X,42X,45X für Ausrückgabel mit Nocken / for release fork with cams	(70)
24.400 FPLS, FPLRS 45X 24X	10.07-		 3400 700 327 ⊗ 3482 114 031 ⊗ 1878 004 832 ⊙ 3151 263 031	430 10 GMFZ430N 430WGTZ KZIZ-6	Getr. / GBox: ZF Ecosplit 3 24X,42X,45X für Nebenantrieb / for PTO	(82)
26.360 FVHLS 42X	05.08-		 3400 700 641 HD ⊗ 3482 114 031 ⊗ 1878 007 729 ⊙ 3151 263 031	430 10 GMFZ430N 430WGTZ KZIZ-6	Getr. / GBox: ZF Ecosplit 3 24X,42X,45X Nebenantriebs-ID / PTO ID: NMV 221	(50)
26.400 FPHLS 42X	05.08-		 3488 017 447	400 MFZ2/400X	Getr. / GBox: ZF Ecosplit 3 24X,42X,45X für Fahrzeuge mit Zweischeibenkupplung / for vehicles with double disc clutch enthält eine Kupplungsscheibe / This part number includes one clutch disc	(77) (67)
26.400 FVHLS 42X	05.08-		 1878 002 643	400 10 400WGTZ	Getr. / GBox: ZF Ecosplit 3 24X,42X,45X für Fahrzeuge mit Zweischeibenkupplung / for vehicles with double disc clutch	(77)
			 3151 262 031	KZISZ-5	Getr. / GBox: ZF Ecosplit 3 24X,42X,45X für Fahrzeuge mit Zweischeibenkupplung / for vehicles with double disc clutch	(77)
			 3496 006 000		24X,42X,45X langer Bügel / long handle	(86)
			 1863 869 038		24X,42X,45X	
			 3189 600 036		für Fahrzeuge mit Zweischeibenkupplung / for vehicles with double disc clutch	(77)
			3189 600 004		Getr. / GBox: ZF AS Tronic Rollenausführung / roller version	(58)
			3189 600 020		Getr. / GBox: ZF Ecosplit-3	

		CODE				
--	--	------	--	---	---	---

























MAN

TGX		09.07 -				
24.440 FNLLW/N 45X	10.07-	D2066LF25, D2066LF36, D2066LF40	 3400 700 402 ⊗ 3482 000 246 ⊗ 1878 002 139 ⊙ 3151 000 034	430 10 MFZ430 430WGTZ KZISZ-5	Getr. / GBox: ZF Ecosplit 3 24X,42X,45X	
24.440 FPLS, FPLRS 24X 45X	10.07-		 3400 700 460 HD ⊗ 3482 000 246 ⊗ 1878 004 104 ⊙ 3151 000 034	430 10 MFZ430 430WGTZ KZISZ-5	Getr. / GBox: ZF Ecosplit 3 24X,42X,45X	
26.440 FPHLS 42X	05.08-		 3400 700 381 ⊗ 3482 000 361 ⊗ 1878 080 037 ⊙ 3151 000 493	430 10 MFZ430 430WGTZ KZISZ-5	Getr. / GBox: ZF AS-Tronic 24X,42X,45X für Ausrückgabel mit Rollen / for release fork with rollers	(71)
26.440 FVHLS 42X	05.08-		 3400 700 403 ⊗ 3482 000 361 ⊗ 1878 004 832 ⊙ 3151 000 144	430 10 MFZ430 430WGTZ KZISZ-5	Getr. / GBox: ZF AS-Tronic 24X,42X,45X für Ausrückgabel mit Nocken / for release fork with cams	(70)
			 3400 700 327 ⊗ 3482 114 031 ⊗ 1878 004 832 ⊙ 3151 263 031	430 10 GMFZ430N 430WGTZ KZIZ-6	Getr. / GBox: ZF Ecosplit 3 24X,42X,45X für Nebenantrieb / for PTO	(82)
			 3400 700 641 HD ⊗ 3482 114 031 ⊗ 1878 007 729 ⊙ 3151 263 031	430 10 GMFZ430N 430WGTZ KZIZ-6	Getr. / GBox: ZF Ecosplit 3 24X,42X,45X Nebenantriebs-ID / PTO ID: NMV 221	(50)
			 3488 017 447	400 MFZ2/400X	Getr. / GBox: ZF Ecosplit 3 24X,42X,45X für Fahrzeuge mit Zweischeibenkupplung / for vehicles with double disc clutch enthält eine Kupplungsscheibe / This part number includes one clutch disc	(77) (67)
			 1878 002 643	400 10 400WGTZ	Getr. / GBox: ZF Ecosplit 3 24X,42X,45X für Fahrzeuge mit Zweischeibenkupplung / for vehicles with double disc clutch	(77)
			 3151 262 031	KZISZ-5	Getr. / GBox: ZF Ecosplit 3 24X,42X,45X für Fahrzeuge mit Zweischeibenkupplung / for vehicles with double disc clutch	(77)
			 3496 006 000		24X,42X,45X langer Bügel / long handle	(86)
			 1863 869 038		24X,42X,45X	
			 3189 600 036		für Fahrzeuge mit Zweischeibenkupplung / for vehicles with double disc clutch	(77)
			 3189 600 004		Getr. / GBox: ZF AS Tronic Rollenausführung / roller version	(58)
			 3189 600 020		Getr. / GBox: ZF Ecosplit-3	

TGX		09.07 -					
24.480 FNLLW/N 45X	10.07-	D2676LF16, D2676LF07, D2676LF13, D2676LF14, D2676LF06, D2676LF05, D2676LF25, D2676LF21, D2676440		3400 700 460 HD ⊗ 3482 000 246 ⊗ 1878 004 104 ⊙ 3151 000 034	430 10 MFZ430 430WGTZ KZISZ-5	Getr. / GBox: ZF Ecosplit 3	
24.480 FPLS, FPLRS 45X 24X	10.07-						
24.540 FNLLW/N 45X	02.09-			3400 700 459 HD ⊗ 3482 000 246 ⊗ 1878 004 104 ⊙ 3151 000 493	430 10 MFZ430 430WGTZ KZISZ-5	Getr. / GBox: ZF AS-Tronic für Ausrückgabel mit Rollen / for release fork with rollers	(71)
24.540 FPLS, FPLRS 45X 24X	10.07-						
26.480 FDC, FDC/M, FDLC, FDRC, FDRC/M, FDLRC, FNHLC 26X 30X 35X	07.08-			3151 000 144	KZISZ-5	Getr. / GBox: ZF AS-Tronic für Ausrückgabel mit Nocken / for release fork with cams	(70)
26.480 FDHLC 70X	09.07-			3400 700 327 ⊗ 3482 114 031 ⊗ 1878 004 832 ⊙ 3151 263 031	430 10 GMFZ430N 430WGTZ KZIZ-6	Getr. / GBox: ZF Ecosplit 3 für Nebenantrieb / for PTO	(82)
26.480 FDHLS 70X	10.07-			3400 700 641 HD ⊗ 3482 114 031 ⊗ 1878 007 729 ⊙ 3151 263 031	430 10 GMFZ430N 430WGTZ KZIZ-6	Getr. / GBox: ZF Ecosplit 3 Nebenantriebs-ID / PTO ID: NMV 221	(50)
26.480 FDLRS, FDLS, FDRS, FDS, FNHLS, FPHLS, FVHLS 30X 35X 42X 26X	12.07-			3488 017 447	400 MFZ2/400X	Getr. / GBox: ZF Ecosplit 3 für Fahrzeuge mit Zweischeibenkupplung / for vehicles with double disc clutch enthält eine Kupplungsscheibe / This part number includes one clutch disc	(77) (67)
26.480 FNHLC 35X	12.07-						
26.480 FNLC, FNLRC, FNLLC, FNLLRC, FNLLW 21X 18X	10.07-			1878 002 643	400 10 400WGTZ	Getr. / GBox: ZF Ecosplit 3 für Fahrzeuge mit Zweischeibenkupplung / for vehicles with double disc clutch	(77)
26.480 FNLS, FNLLS, FNLRS, FNLLRS, FPLS, FPLRS, FVLS 18X 21X 24X	10.07-			3151 262 031	KZISZ-5	Getr. / GBox: ZF Ecosplit 3 für Fahrzeuge mit Zweischeibenkupplung / for vehicles with double disc clutch	(77)
26.480 FNLS, FNLLS, FNLRS, FNLLRS, FPLS, FPLRS, FVLS 21X 18X 24X	10.07-			3496 006 000		langer Bügel / long handle	(86)
26.480 FPHLS 42X	05.08-			1863 869 038			
26.480 FVHLS 42X	05.08-			3189 600 036		für Fahrzeuge mit Zweischeibenkupplung / for vehicles with double disc clutch	(77)
26.540 FDC, FDC/M, FDLC, FDRC, FDRC/M, FDLRC 26X 30X	02.09-			3189 600 004		Getr. / GBox: ZF AS Tronic Rollenausführung / roller version	(58)
26.540 FDLRS, FDLS, FDRS, FDS, FVHLS 26X 42X 30X	02.09-						
26.540 FNLC, FNLRC, FNLLC, FNLLRC, FNLLW 21X 18X	10.07-						
26.540 FNLS, FNLRS, FNLLS, FPLS, FPLRS, FVLS 18X 24X 21X	10.07-						
26.540 FNLS, FNLRS, FNLLS, FPLS, FPLRS, FVLS 24X 21X 18X	10.07-						
28.480 FNLC 89X	10.07-						
28.480 FNLS 89X	10.07-						
28.540 FNLC 89X	10.07-						
28.540 FNLS 89X	02.09-						
29.440	01.09-						
29.440 XLX	01.13-						
29.480	08.15-						
33.480 FDC, FDC/M, FDLC, FDLRC, FDRC 30X 26X	10.07-						
33.480 FDS, FDS/M, FDLS, FDLS/M 26X 30X	10.07-						
33.540 FDC, FDC/M, FDLC, FDLRC, FDRC 30X 26X	10.07-						











		CODE		 Parameter		
--	--	------	--	---	---	---

MAN

TGX		09.07 -				
33.540 FDS, FDS/M, FDLS, FDLS/M 26X 30X 41.540 FVDS, FVDLS 86X 87X	10.07 -	D2676LF16, D2676LF07, D2676LF13, D2676LF14, D2676LF06, D2676LF05, D2676LF25, D2676LF21, D2676440	 3400 700 460 HD  3482 000 246  1878 004 104  3151 000 034	430 10 MFZ430 430WGTZ KZISZ-5	Getr. / GBox: ZF Ecosplit 3	
	06.08 -		 3400 700 459 HD  3482 000 246  1878 004 104  3151 000 493	430 10 MFZ430 430WGTZ KZISZ-5	Getr. / GBox: ZF AS-Tronic für Ausrückgabel mit Rollen / for release fork with rollers	(71)
			 3151 000 144	KZISZ-5	Getr. / GBox: ZF AS-Tronic für Ausrückgabel mit Nocken / for release fork with cams	(70)
			 3400 700 327  3482 114 031  1878 004 832  3151 263 031	430 10 GMFZ430N 430WGTZ KZISZ-6	Getr. / GBox: ZF Ecosplit 3 für Nebenantrieb / for PTO	(82)
			 3400 700 641 HD  3482 114 031  1878 007 729  3151 263 031	430 10 GMFZ430N 430WGTZ KZISZ-6	Getr. / GBox: ZF Ecosplit 3 Nebenantriebs-ID / PTO ID: NMV 221	(50)
			 3488 017 447	400 MFZ2/400X	Getr. / GBox: ZF Ecosplit 3 für Fahrzeuge mit Zweischeibenkupplung / for vehicles with double disc clutch enthält eine Kupplungsscheibe / This part number includes one clutch disc	(77) (67)
			 1878 002 643	400 10 400WGTZ	Getr. / GBox: ZF Ecosplit 3 für Fahrzeuge mit Zweischeibenkupplung / for vehicles with double disc clutch	(77)
			 3151 262 031	KZISZ-5	Getr. / GBox: ZF Ecosplit 3 für Fahrzeuge mit Zweischeibenkupplung / for vehicles with double disc clutch	(77)
			 3496 006 000		langer Bügel / long handle	(86)
			 1863 869 038			
			 3189 600 036		für Fahrzeuge mit Zweischeibenkupplung / for vehicles with double disc clutch	(77)
			 3189 600 004		Getr. / GBox: ZF AS Tronic Rollenausführung / roller version	(58)































		CODE				
--	--	------	--	---	---	---

MAN

TGX		09.07 -				
26.320 FNLS, FNLLS, FNLRS 21X 18X	10.07 -	D2066LF42, D2066LF37,	 3400 700 380 ⊗ 3482 000 361 ⊗ 1878 080 037 ⊙ 3151 000 034	430 10 MFZ430 430WGTZ KZISZ-5	Getr. / GBox: ZF Ecosplit 3 18X,21X,26X,30X	
26.360 FDC, FDC/M, FDLC, FDRC, FDRC/M, FDLRC, FNHLC 26X 30X 35X	07.08 -	D2066LF27, D2066LF28, D2066LF43, D2066LF41,	 3400 700 381 ⊗ 3482 000 361 ⊗ 1878 080 037 ⊙ 3151 000 493	430 10 MFZ430 430WGTZ KZISZ-5	Getr. / GBox: ZF AS-Tronic 18X,21X,26X,30X für Ausrückgabel mit Rollen / for release fork with rollers	(71)
26.360 FDLRS, FDLS, FDRS, FDS, FNHLS, FPHLS, FVHLS 35X 30X 26X 42X	10.07 -	D2066LF26, D2066LF52, D2066LF61, D2066LF67, D2066LF38, D2066LF51	 3400 700 403 ⊗ 3482 000 361 ⊗ 1878 004 832 ⊙ 3151 000 144	430 10 MFZ430 430WGTZ KZISZ-5	Getr. / GBox: ZF AS-Tronic 18X,21X,26X,30X für Ausrückgabel mit Nocken / for release fork with cams	(70)
26.360 FNLC, FNLRC, FNLLC, FNLLRC, FNLLW 18X 21X	10.07 -		 3400 700 327 ⊗ 3482 114 031 ⊗ 1878 004 832 ⊙ 3151 263 031	430 10 GMFZ430N 430WGTZ KZIZ-6	Getr. / GBox: ZF Ecosplit 3 18X,21X,26X,30X für Nebenantrieb / for PTO	(82)
26.360 FNLS, FNLLS, FNLRS, FNLLRS, FPLS, FPLRS, FVLS 18X 24X 21X	10.07 -		 3400 700 641 HD ⊗ 3482 114 031 ⊗ 1878 007 729 ⊙ 3151 263 031	430 10 GMFZ430N 430WGTZ KZIZ-6	Getr. / GBox: ZF Ecosplit 3 18X,21X,26X,30X Nebenantriebs-ID / PTO ID: NMV 221	(50)
26.400 FDC, FDC/M, FDLC, FDRC, FDRC/M, FDLRC, FNHLC 30X 26X 35X	07.08 -		 3488 017 447	400 MFZ2/400X	Getr. / GBox: ZF Ecosplit 3 18X,21X,26X,30X für Fahrzeuge mit Zweischeibenkupplung / for vehicles with double disc clutch enthält eine Kupplungsscheibe / This part number includes one clutch disc	(77) (67)
26.400 FDLRS, FDLS, FDRS, FDS, FNHLS, FPHLS, FVHLS 30X 26X	12.07 -		 1878 002 643	400 10 400WGTZ	Getr. / GBox: ZF Ecosplit 3 18X,21X,26X,30X für Fahrzeuge mit Zweischeibenkupplung / for vehicles with double disc clutch	(77)
26.400 FNLC, FNLRC, FNLLC, FNLLRC, FNLLW 18X 21X	10.07 -		 3151 262 031	KZISZ-5	Getr. / GBox: ZF Ecosplit 3 18X,21X,26X,30X für Fahrzeuge mit Zweischeibenkupplung / for vehicles with double disc clutch	(77)
26.400 FNLS, FNLLS, FNLRS, FNLLRS, FPLS, FPLRS, FVLS 21X 24X 18X	10.07 -		 3496 006 000		18X,21X,26X,30X langer Bügel / long handle	(86)
32.440 FDC, FDLC, FDLRC, FDRC 30X 26X	10.07 -		 1863 869 038		18X,21X,26X,30X	
33.360 FDC, FDC/M, FDLC, FDLC 26X 30X	10.07 -		 3189 600 036		für Fahrzeuge mit Zweischeibenkupplung / for vehicles with double disc clutch	(77)
33.360 FDS, FDS/M, FDLS, FDLS/M 26X 30X	10.07 -		3189 600 004		Getr. / GBox: ZF AS Tronic Rollenausführung / roller version	(58)
			3189 600 020		Getr. / GBox: ZF Ecosplit-3	























		CODE				
--	--	------	--	---	---	---

MAN

TGX		09.07 -				
26.440 FDC, FDC/M, FDLC, FDR, FDR/M, FDLRC, FNHLC 30X 26X 35X 26.440 FDLRS, FDLS, FDRS, FDS, FNHLS, FPHLS, FVHLS 30X 35X 42X 26X 26.440 FNLS, FNLLS, FNLRS, FNLLRS, FPLS, FPLRS, FVLS 21X 18X 24X 26.440 FNLS, FNLLS, FNLRS, FNLLRS, FPLS, FPLRS, FVLS 18X 21X 24X 28.440 FNLC 89X 28.440 FNLS 89X 33.440 FDC, FDC/M, FDLC, FDLRC, FDR 26X 30X 33.440 FDS, FDS/M, FDLS, FDLS/M 30X 26X	07.08-	D2676LF26, D2066LF25, D2676LF22, D2066LF36, D2066LF40	 3400 700 402  3482 000 246  1878 002 139  3151 000 034	430 10 MFZ430 430WGTZ KZISZ-5	Getr. / GBox: ZF Ecosplit 3 26X,30X,89X	
	12.07-		 3400 700 460 HD  3482 000 246  1878 004 104  3151 000 034	430 10 MFZ430 430WGTZ KZISZ-5	Getr. / GBox: ZF Ecosplit 3 26X,30X,89X	
	10.07-		 3400 700 381  3482 000 361  1878 080 037  3151 000 493	430 10 MFZ430 430WGTZ KZISZ-5	Getr. / GBox: ZF AS-Tronic 26X,30X,89X für Ausrückgabel mit Rollen / for release fork with rollers	(71)
	10.12-		 3400 700 403  3482 000 361  1878 004 832  3151 000 144	430 10 MFZ430 430WGTZ KZISZ-5	Getr. / GBox: ZF AS-Tronic 26X,30X,89X für Ausrückgabel mit Nocken / for release fork with cams	(70)
	10.07-		 3400 700 327  3482 114 031  1878 004 832  3151 263 031	430 10 GMFZ430N 430WGTZ KZISZ-6	Getr. / GBox: ZF Ecosplit 3 26X,30X,89X für Nebenantrieb / for PTO	(82)
	10.07-		 3400 700 641 HD  3482 114 031  1878 007 729  3151 263 031	430 10 GMFZ430N 430WGTZ KZISZ-6	Getr. / GBox: ZF Ecosplit 3 26X,30X,89X Nebenantriebs-ID / PTO ID: NMV 221	(50)
			 3488 017 447	400 MFZ2/400X	Getr. / GBox: ZF Ecosplit 3 26X,30X,89X für Fahrzeuge mit Zweischeibenkupplung / for vehicles with double disc clutch enthält eine Kupplungsscheibe / This part number includes one clutch disc	(77) (67)
			 1878 002 643	400 10 400WGTZ	Getr. / GBox: ZF Ecosplit 3 26X,30X,89X für Fahrzeuge mit Zweischeibenkupplung / for vehicles with double disc clutch	(77)
			 3151 262 031	KZISZ-5	Getr. / GBox: ZF Ecosplit 3 26X,30X,89X für Fahrzeuge mit Zweischeibenkupplung / for vehicles with double disc clutch	(77)
			 3496 006 000		26X,30X,89X langer Bügel / long handle	(86)
			 1863 869 038		26X,30X,89X	
			 3189 600 036		für Fahrzeuge mit Zweischeibenkupplung / for vehicles with double disc clutch	(77)
			3189 600 004		Getr. / GBox: ZF AS Tronic Rollenausführung / roller version	(58)
			3189 600 020		Getr. / GBox: ZF Ecosplit-3	

		CODE		 Parameter		
--	--	------	--	---	---	---































MAN

TGX		09.07 -					
26.440 FDC, FDC/M, FDLC, FDRC, FDRC/M, FDLRC, FNHLC 26X 30X 26.440 FDK, FDLK 26.480 FDK, FDLK 26.540 FDLRS, FDLS, FDRS, FDS, FVHLS 42X 27.440 FNS 88X 28.440 FDS 27X 28X 33.440 FDK, FDLK 33.480 FDK, FDLK 35.440 FDNLC 92X	10.12-	D2676LF16, D2676LF28, D2676LF10, D2676LF14, D2676LF07, D2676LF26, D2676LF06, D2676LF05, D2676LF25		3400 700 460 HD  3482 000 246  1878 004 104  3151 000 034	430 10 MFZ430 430WGTZ KZISZ-5	Getr. / GBox: ZF Ecosplit 3	
	01.14- 12.07- 10.12-			3400 700 459 HD  3482 000 246  1878 004 104  3151 000 493	430 10 MFZ430 430WGTZ KZISZ-5	Getr. / GBox: ZF AS-Tronic für Ausrückgabel mit Rollen / for release fork with rollers	(71)
	10.12-			3400 700 327  3482 114 031  1878 004 832  3151 263 031	430 10 GMFZ430N 430WGTZ KZISZ-6	Getr. / GBox: ZF Ecosplit 3 für Nebenantrieb / for PTO	(82)
	10.12-			3400 700 641 HD  3482 114 031  1878 007 729  3151 263 031	430 10 GMFZ430N 430WGTZ KZISZ-6	Getr. / GBox: ZF Ecosplit 3 Nebenantriebs-ID / PTO ID: NMV 221	(50)
	01.14- 01.14- 06.08-			3488 017 447	400 MFZ2/400X	Getr. / GBox: ZF Ecosplit 3 für Fahrzeuge mit Zweischeibenkupplung / for vehicles with double disc clutch	(77)
						enthält eine Kupplungsscheibe / This part number includes one clutch disc	(67)
				1878 002 643	400 10 400WGTZ	Getr. / GBox: ZF Ecosplit 3 für Fahrzeuge mit Zweischeibenkupplung / for vehicles with double disc clutch	(77)
				3151 262 031	KZISZ-5	Getr. / GBox: ZF Ecosplit 3 für Fahrzeuge mit Zweischeibenkupplung / for vehicles with double disc clutch	(77)
				3496 006 000		langer Bügel / long handle	(86)
				1863 869 038			
				3189 600 036		für Fahrzeuge mit Zweischeibenkupplung / for vehicles with double disc clutch	(77)
				3189 600 004		Getr. / GBox: ZF AS Tronic Rollenausführung / roller version	(58)
				3189 600 020		Getr. / GBox: ZF Ecosplit-3	

		CODE				
--	--	------	--	---	---	---

MAN





TGX 09.07 -

26.440 FNLC, FNLCR, FNLLC, FNLLRC, FNLLW 21X 18X 26.440 FNLS, FNLLS, FNLRs, FNLLRS, FPLS, FPLRS, FVLS 18X 24X 21X	10.07-	D2066LF25, D2066LF36, D2066LF57, D2066LF40		3400 700 402  3482 000 246  1878 002 139  3151 000 034	430 10 MFZ430 430WGTZ KZISZ-5	Getr. / GBox: ZF Ecosplit 3 18X,21X,24X	
	10.07-			3400 700 460 HD  3482 000 246  1878 004 104  3151 000 034	430 10 MFZ430 430WGTZ KZISZ-5	Getr. / GBox: ZF Ecosplit 3 18X,21X,24X	
				3400 700 381  3482 000 361  1878 080 037  3151 000 493	430 10 MFZ430 430WGTZ KZISZ-5	Getr. / GBox: ZF AS-Tronic 18X,21X,24X für Ausrückgabel mit Rollen / for release fork with rollers	(71)
				3400 700 403  3482 000 361  1878 004 832  3151 000 144	430 10 MFZ430 430WGTZ KZISZ-5	Getr. / GBox: ZF AS-Tronic 18X,21X,24X für Ausrückgabel mit Nocken / for release fork with cams	(70)
				3400 700 327  3482 114 031  1878 004 832  3151 263 031	430 10 GMFZ430N 430WGTZ KZISZ-6	Getr. / GBox: ZF Ecosplit 3 18X,21X,24X für Nebenantrieb / for PTO	(82)
				3400 700 641 HD  3482 114 031  1878 007 729  3151 263 031	430 10 GMFZ430N 430WGTZ KZISZ-6	Getr. / GBox: ZF Ecosplit 3 18X,21X,24X Nebenantriebs-ID / PTO ID: NMV 221	(50)
				3488 017 447	400 MFZ2/400X	Getr. / GBox: ZF Ecosplit 3 18X,21X,24X für Fahrzeuge mit Zweischeibenkupplung / for vehicles with double disc clutch enthält eine Kupplungsscheibe / This part number includes one clutch disc	(77) (67)
				1878 002 643	400 10 400WGTZ	Getr. / GBox: ZF Ecosplit 3 18X,21X,24X für Fahrzeuge mit Zweischeibenkupplung / for vehicles with double disc clutch	(77)
				3151 262 031	KZISZ-5	Getr. / GBox: ZF Ecosplit 3 18X,21X,24X für Fahrzeuge mit Zweischeibenkupplung / for vehicles with double disc clutch	(77)
				3496 006 000		18X,21X,24X langer Bügel / long handle	(86)
				1863 869 038		18X,21X,24X	
				3189 600 036		für Fahrzeuge mit Zweischeibenkupplung / for vehicles with double disc clutch	(77)
				3189 600 004		Getr. / GBox: ZF AS Tronic Rollenausführung / roller version	(58)
				3189 600 020		Getr. / GBox: ZF Ecosplit-3	





6 ...

6.115 H				1880 083 132 #	280 G280		
				1863 600 125	GR-3	mit Anlauftring / with thrust ring	(88)
6.126 H				1863 600 125	GR-3	mit Anlauftring / with thrust ring	(88)





7 ...

7.126 H				1880 083 132 #	280 G280		
				1863 600 125	GR-3	mit Anlauftring / with thrust ring	(88)
				1863 600 125	GR-3	mit Anlauftring / with thrust ring	(88)
7.136 H				1863 600 125	GR-3	mit Anlauftring / with thrust ring	(88)









8 ...

8.126 H				1863 600 125	GR-3	mit Anlauftring / with thrust ring	(88)
8.156 F 8.160 F 8.186 FW				1882 110 532 #	350 GF350		
				1878 005 367	350 10 350WGTZ		
				3151 000 395	KZISZ-4		









8 ...

8.156 H			 1880 083 132 #	280 G280		
			 3151 199 001	KZIS-3		
8.192			 1882 209 335 #	350 GF350		
			 1878 001 144	350 10 350WGTZ		
			1878 001 147 #	350 10 350WGTZ		
			 3151 000 958	KZIS-4		







9 ...

9.156 H,F 9.168 FL 9.186 F,H,HKA 9.192 FL			 1882 110 532 #	350 GF350		
			 1878 005 367	350 10 350WGTZ		
			 3151 000 395	KZIS-4		
9.160 HAK			 1882 110 532 #	350 GF350		
			 1878 005 367	350 10 350WGTZ		
9.192 HA			 3482 002 234	350 GMF350X		
			 1878 001 144	350 10 350WGTZ		
			1878 001 147 #	350 10 350WGTZ		
			 3151 000 958	KZIS-4		

10 ...

10.150 10.152	01.87 - 12.91	D0826OH	 3400 125 501  3482 060 132  1878 001 077  3151 199 001	350 10 MF350 350GTZ KZIS-3		
	01.87 - 12.92					
10.210		D2146MT	 3482 002 234	350 GMF350X		
			 1878 001 144	350 10 350WGTZ		
			1878 001 147 #	350 10 350WGTZ		
			 3151 000 958	KZIS-4		
10.212	- 11.65		 1861 470 234	380 10 380GSZ		
			 3151 000 395	KZIS-4		

























11 ...

































11.168		D2555M	 3482 002 234	350 GMF350X		
			 1878 001 144	350 10 350WGTZ		
			1878 001 147 #	350 10 350WGTZ		
			 3151 000 958	KZIS-4		
11.190 752 11.220 752 11.230 752		D0826LOH	 3482 060 132	350 MF350		
			 1878 001 145	350 10 350WGTZ		
			 3151 199 001	KZIS-3		

		CODE				
--	--	------	--	---	---	---

MAN









11 ...						
11.192 HA				1882 209 335 #	350 GF350	
				1878 001 144	350 10 350WGTZ	
				1878 001 147 #	350 10 350WGTZ	
				3151 000 958	KZIS-4	

























13 ...							
13.168	D2555M, MF, MXF			3482 002 234 HD	350 GMF350X		
				1878 001 147 #	350 10 350WGTZ		
				1878 001 144	350 10 350WGTZ		
				3151 000 958	KZIS-4		
	D2565MF				1882 209 335 #	350 GF350	
					1878 001 144	350 10 350WGTZ	
					1878 001 147 #	350 10 350WGTZ	
				3151 000 958	KZIS-4		
	D2855BYUL				1882 325 134	380 G380	
					1861 470 234	380 10 380GSZ	
	D2538M				1882 302 131 HD	380 GF380	
					1878 001 152 HD	380 10 380WGTZ	
				3151 000 395 HD	KZIS-4		
13.192	D2555, D2565M			1882 209 335 #	350 GF350		
				3482 002 234 HD	350 GMF350X		
				1878 001 144	350 10 350WGTZ		
				1878 001 147 #	350 10 350WGTZ		
			3151 000 958	KZIS-4			
13.192 F,H,HA				1882 110 532 #	350 GF350		
				1878 005 367	350 10 350WGTZ		
				3151 000 395	KZIS-4		
13.192 U,UL 903	D2555			1882 209 335 #	350 GF350		
				1878 001 144	350 10 350WGTZ		
				1878 001 147 #	350 10 350WGTZ		
				3151 000 958	KZIS-4		
13.250 F 13.256 F 13.275 F 13.304 F				3482 124 541	430 GMF430		
				1882 330 032 ●#	420 GF420		
				1878 634 039 ▲	420 10 420WGTZ		
				3151 000 395	KZIS-4		
13.304 DFR RT9509				3482 124 541	430 GMF430		
				1882 330 032 ●#	420 GF420		













14 ...							
14.136		D0226MF	 3482 008 110	310 MF310			
			 1861 577 037 #	310 10 310GTD			
			 3151 199 001	KZIS-3			
14.168		D2555MF, MXF	 3482 002 234	350 GMF350X			
			 1878 001 144	350 10 350WGTZ			
			 1878 001 147 #	350 10 350WGTZ			
			 3151 000 958	KZIS-4			
		D2565MF	 1882 209 335 #	350 GF350			
			 1878 001 144	350 10 350WGTZ			
			 1878 001 147 #	350 10 350WGTZ			
			 3151 000 958	KZIS-4			
14.170		D0226MKF	 3482 060 233	350 MF350	Getr. / GBox: ZF-S6-36		
			 1861 777 037	350 10 350GTD	Getr. / GBox: ZF-S6-36		
			 3151 199 001	KZIS-3	Getr. / GBox: ZF-S6-36		
			 3482 017 033	380 GMF380	Getr. / GBox: ZF-S6-65		
			 1878 001 152	380 10 380WGTZ	Getr. / GBox: ZF-S6-65		
			 3151 000 395	KZIS-4	Getr. / GBox: ZF-S6-65		
14.192 903		D2555, D2565M	 1882 209 335 #	350 GF350			
			 3482 002 234 HD	350 GMF350X			
			 1878 001 144	350 10 350WGTZ			
			 1878 001 147 #	350 10 350WGTZ			
			 3151 000 958	KZIS-4			
14.192		D0826MKF	 3482 017 033	380 GMF380			
			 1878 001 152	380 10 380WGTZ			
			 3151 000 395	KZIS-4			
14.192 F,H		D2555	 1882 209 335 #	350 GF350			
			 1878 001 144	350 10 350WGTZ			
			 1878 001 147 #	350 10 350WGTZ			
			 3151 000 958	KZIS-4			
14.200		D2538M	 1882 302 131	380 GF380			
			 1878 001 152	380 10 380WGTZ			
			 3151 000 395	KZIS-4			





















		CODE				
--	--	------	--	---	---	---

MAN

14 ...							
14.220 526	01.83-	D2566MF		1882 302 131	380 GF380	Je nach Kundenwunsch mit unterschiedlicher Kupplung / Equipped with different clutch according to customer requirement	(35)
				1878 001 152	380 10 380WGTZ		
				3482 124 534	430 GMF430	Je nach Kundenwunsch mit unterschiedlicher Kupplung / Equipped with different clutch according to customer requirement	(35)
				1882 301 239 ●	420 GF420	Je nach Kundenwunsch mit unterschiedlicher Kupplung / Equipped with different clutch according to customer requirement	(35)
				1878 003 657	420 10 420WGTZ		
				3151 000 395	KZIS-4		
14.220				1878 000 964	380 10 380GTZ	für Nebenantrieb / for PTO	(82)
14.285 DFR RT9509				3482 124 541	430 GMF430		
				1882 330 032 ●#	420 GF420		



































15 ...							
15.168 15.192				1878 001 079	350 10 350GTZ	Nebenantriebs-ID / PTO ID: 80	(50)
15.168		D2568, D2555M, MF, MXF		3482 002 234	350 GMF350X		
				1878 001 144	350 10 350WGTZ		
				1878 001 147 #	350 10 350WGTZ		
				3151 000 958	KZIS-4		
		D2538M		1882 302 131 HD	380 GF380		
				1878 001 152 HD	380 10 380WGTZ		
	3151 000 395 HD		KZIS-4				
15.168 FM,HOC 15.192 F,H,HA				1882 110 532 #	350 GF350		
				1878 005 367	350 10 350WGTZ		
				3151 000 395	KZIS-4		
15.192		D2238M		1882 302 131	380 GF380		
				1878 001 152	380 10 380WGTZ		
				3151 000 395	KZIS-4		
				1882 209 335 #	350 GF350		
		D2565M		3482 002 234 HD	350 GMF350X		
				1878 001 144	350 10 350WGTZ		
				1878 001 147 #	350 10 350WGTZ		
				3151 000 958	KZIS-4		
		D2568		3482 002 234	350 GMF350X		
				1878 001 144	350 10 350WGTZ		
				1878 001 147 #	350 10 350WGTZ		
				3151 000 958	KZIS-4		
		D2855BYUL		1882 325 134	380 G380		
				1861 470 234	380 10		







































15 ...						
15.200 15.216				1882 302 131	380 GF380	
				1878 001 152	380 10 380WGTZ	
				3151 000 395	KZIS-4	
15.220 526 15.240 526	01.83- 01.83-	D2566MF		1882 302 131	380 GF380	Je nach Kundenwunsch mit unterschiedlicher Kupplung / Equipped with different clutch according to customer requirement (35)
				1878 001 152	380 10 380WGTZ	
				3482 124 534	430 GMF430	Je nach Kundenwunsch mit unterschiedlicher Kupplung / Equipped with different clutch according to customer requirement (35)
				1882 301 239	420 GF420	Je nach Kundenwunsch mit unterschiedlicher Kupplung / Equipped with different clutch according to customer requirement (35)
				1878 003 657	420 10 420WGTZ	
				3151 000 395	KZIS-4	
15.220 15.240				1878 000 964	380 10 380GTZ	für Nebenantrieb / for PTO (82)
15.240		D2238M		1882 302 131	380 GF380	
				1878 001 152	380 10 380WGTZ	
				3151 000 395	KZIS-4	

16 ...						
16.132 FKO				1882 209 335 HD#	350 GF350	
				1878 001 144 HD	350 10 350WGTZ	
				1878 001 147 HD#	350 10 350WGTZ	
				3151 000 958 HD	KZIS-4	
16.136		D0226MF		3482 008 110	310 MF310	
				1861 577 037 #	310 10 310GTD	
				3151 199 001	KZIS-3	
16.168 16.192				1878 001 079	350 10 350GTZ	Nebenantriebs-ID / PTO ID: 80 (50)
16.168		D2555M, MF, MXF		3482 002 234	350 GMF350X	
				1878 001 144	350 10 350WGTZ	
				1878 001 147 #	350 10 350WGTZ	
				3151 000 958	KZIS-4	
16.168 FL 16.186 FN				1882 110 532 #	350 GF350	
				1878 005 367	350 10 350WGTZ	
				3151 000 395	KZIS-4	
16.170		D0226MKF		3482 060 233	350 MF350	Getr. / GBox: ZF-S6-36
				1861 777 037	350 10 350GTD	Getr. / GBox: ZF-S6-36
				3151 199 001	KZIS-3	Getr. / GBox: ZF-S6-36
				3482 017 033	380 GMF380	Getr. / GBox: ZF-S6-65
				1878 001 152	380 10 380WGTZ	Getr. / GBox: ZF-S6-65
				3151 000 395	KZIS-4	Getr. / GBox: ZF-S6-65

		CODE				
--	--	------	--	---	---	---







MAN















16 ...							
16.192		D2565M	 1882 209 335 #	350 GF350			
			 3482 002 234 HD	350 GMF350X			
			 1878 001 144	350 10 350WGTZ			
			 1878 001 147 #	350 10 350WGTZ			
			 3151 000 958	KZIS-4			
		D0226MKF	 3482 017 033	380 GMF380			
			 1878 001 152	380 10 380WGTZ			
			 3151 000 395	KZIS-4			
16.200 16.220 527		D2566MF	 1882 302 131	380 GF380			
			 1878 001 152	380 10 380WGTZ			
			 3151 000 395	KZIS-4			
16.232 16.240 520			 1882 302 131	380 GF380			
			 1878 001 152	380 10 380WGTZ			
			 3151 000 395	KZIS-4			
16.240			 3482 124 534 HD	430 GMF430			
			 1882 301 239 HD ●	420 GF420			
			 1878 003 657 HD	420 10 420WGTZ			
			 3151 000 395 HD	KZIS-4	Getr. / GBox: ZF		
			 3151 067 032 HD	KZI4,5	Getr. / GBox: Fuller		
			 1878 000 964	380 10 380GTZ	für Nebenantrieb / for PTO	(82)	
16.242	01.85-	D2866F	 1882 017 131	420 GF420XN	Nebenantriebs-ID / PTO ID: 130E	(50)	
			 1878 086 941	420 10 420WGTZ	Nebenantriebs-ID / PTO ID: 130E	(50)	
16.250 FN 16.256 H 16.275 FN 16.304 FN,FVS			 3482 124 541	430 GMF430			
			 1882 330 032 ●#	420 GF420			
			 1878 634 039 ▲	420 10 420WGTZ			
			 3151 000 395	KZIS-4			
16.256		D2538M, MF	 1882 302 131	380 GF380			
			 1878 001 152	380 10 380WGTZ			
			 3151 000 395	KZIS-4			
			 3482 124 534	430 GMF430			
			 1882 301 239 ●	420 GF420			
			 1878 003 657	420 10 420WGTZ			
			 3151 000 395	KZIS-4	ZF-Getriebe / ZF Transmission	(62)	
		 3151 067 032	KZI4,5	Fuller-Getriebe / Fuller Transmission	(24)		
		D2566MF	 1878 002 955	420 10 420GTZ	Nebenantriebs-ID / PTO ID: 110	(50)	











16 ...						
16.262	01.85 - 12.92	D2865LF		1882 017 131	420 GF420XN	Nebenantriebs-ID / PTO ID: 130E (50)
16.272	01.90 -			1878 086 941	420 10 420WGTZ	Nebenantriebs-ID / PTO ID: 130E (50)
16.322	01.90 -			3482 124 534	430 GMF430	
16.280				1882 301 239 ●	420 GF420	
				1878 003 657	420 10 420WGTZ	
				3151 000 395	KZIS-4	ZF-Getriebe / ZF Transmission (62)
				3151 067 032	KZI4,5	Fuller-Getriebe / Fuller Transmission (24)
16.281		D2566MKF		1882 346 131 #	420 GF420XN	Nebenantriebs-ID / PTO ID: 130 (50)
16.321				1861 876 134 #	420 10 420GVZ	Nebenantriebs-ID / PTO ID: 130 (50)
16.281		D2866		1800 125 501 #	420 10 GF420X	
16.291				1882 342 134	420WGVZ	
504				1861 911 232	KZI4,5	
16.321				1888 015 346	380 GF2/380	Je nach Kundenwunsch mit unterschiedlicher Kupplung / Equipped with different clutch according to customer requirement (35)
16.331						enthält eine Kupplungsscheibe / This part number includes one clutch disc (67)
504				1861 748 132 ▽	380 6 380GSZ	Lose Kupplungsscheibe / Loose clutch disc (41)
16.361				3151 000 395	KZIS-4	
504				1882 280 112	380 GF2/380	In 1888 enthalten / Contained in 1888 (31)
16.361				1861 749 132 △	380 10 380WGSZ	In 1888 enthalten / Contained in 1888 (31)
504				1859 212 001	380 GF2/380	In 1888 enthalten / Contained in 1888 (31)
16.292	01.85 - 12.92	D2866LF		1882 017 131	420 GF420XN	Nebenantriebs-ID / PTO ID: 130E (50)
16.302	01.90 - 12.92			1878 086 941	420 10 420WGTZ	Nebenantriebs-ID / PTO ID: 130E (50)
16.332	01.85 - 12.92					
16.372	01.90 -					
16.422	01.90 -					
16.320		D2538MT, D2530MF		3482 124 534	430 GMF430	
				1882 301 239 ●	420 GF420	
				1878 003 657	420 10 420WGTZ	
				3151 000 395	KZIS-4	ZF-Getriebe / ZF Transmission (62)
				3151 067 032	KZI4,5	Fuller-Getriebe / Fuller Transmission (24)
16.320 U,UL 902,908,909,918				1878 000 967 ▽	380 10 380GTZ	Lose Kupplungsscheibe / Loose clutch disc (41)
				3151 000 395	KZIS-4	
				1882 280 213	380 GF2/380	In 1888 enthalten / Contained in 1888 (31)
				1859 212 000	380 GF2/380	In 1888 enthalten / Contained in 1888 (31)
				1878 000 964 △	380 10 380GTZ	In 1888 enthalten / Contained in 1888 (31)
16.361		D2866		1800 125 501 #	420 10 GF420X	
				1882 342 134	420WGVZ	
				1861 911 232	KZI4,5	
				3151 067 032		
		D2566KFZ		1882 346 131 #	420 GF420XN	Nebenantriebs-ID / PTO ID: 130 (50)
				1861 876 134 #	420 10 420GVZ	Nebenantriebs-ID / PTO ID: 130 (50)
16.362	01.85 - 12.92	D2866KF, KU, LXF		1882 017 131	420 GF420XN	Nebenantriebs-ID / PTO ID: 130E (50)
				1878 086 941	420 10	Nebenantriebs-ID / PTO ID: 130E (50)









































		CODE		 Parameter		
--	--	------	--	---	---	---

MAN

16 ...						
16.462	01.85-	D2840LF	 3400 122 201  3482 083 032  1878 004 832  3151 000 034	430 10 MFZ430 430WGTZ KZISZ-5		
			 1882 017 131	420 GF420XN	Nebenantriebs-ID / PTO ID: 130E	(50)
			 1878 086 941	420 10 420WGTZ	Nebenantriebs-ID / PTO ID: 130E	(50)
			 3189 600 020		Getr. / GBox: ZF Ecosplit-3	





































17 ...						
17.170		D0226MKF	 3482 060 233	350 MF350	Getr. / GBox: ZF-S6-36	
			 1861 777 037	350 10 350GTD	Getr. / GBox: ZF-S6-36	
			 3151 199 001	KZIS-3	Getr. / GBox: ZF-S6-36	
			 3482 017 033	380 GMF380	Getr. / GBox: ZF-S6-65	
			 1878 001 152	380 10 380WGTZ	Getr. / GBox: ZF-S6-65	
			 3151 000 395	KZIS-4	Getr. / GBox: ZF-S6-65	
17.192		D0826MKF	 3482 017 033	380 GMF380		
			 1878 001 152	380 10 380WGTZ		
			 3151 000 395	KZIS-4		
17.220 529		D2566MF	 1882 302 131	380 GF380		
			 1878 001 152	380 10 380WGTZ		
			 3151 000 395	KZIS-4		
17.240 520			 1882 302 131	380 GF380		
			 1878 001 152	380 10 380WGTZ		
			 3151 000 395	KZIS-4		





























19 ...						
19.168			 1878 001 079	350 10 350GTZ	Nebenantriebs-ID / PTO ID: 80	(50)
19.192						
19.168		D2555M	 3482 002 234	350 GMF350X		
			 1878 001 144	350 10 350WGTZ		
			 1878 001 147 #	350 10 350WGTZ		
			 3151 000 958	KZIS-4		
19.186 FN 19.192 FNM			 1882 110 532 #	350 GF350		
			 1878 005 367	350 10 350WGTZ		
			 3151 000 395	KZIS-4		
19.186 H			 1882 110 532 #	350 GF350		
			 3151 000 395	KZIS-4		

19 ...						
19.192	D2565M	 3482 002 234 HD	350 GMF350X			
		 1882 209 335 ●#	350 GF350			
		 1878 001 144	350 10 350WGTZ			
		 1878 001 147 #	350 10 350WGTZ			
		 3151 000 958	KZIS-4			
19.220 527,529	D2566MF	 1882 302 131	380 GF380			
		 1878 001 152	380 10 380WGTZ			
		 3151 000 395	KZIS-4			
19.232		 1882 302 131	380 GF380			
		 1878 001 152	380 10 380WGTZ			
		 3151 000 395	KZIS-4			
19.233	D2866LF	 3400 700 327  3482 114 031  1878 004 832  3151 263 031	430 10 GMFZ430N 430WGTZ KZIZ-6	für Nebenantrieb / for PTO	(82)	
		 3400 700 641 HD  3482 114 031  1878 007 729  3151 263 031	430 10 GMFZ430N 430WGTZ KZIZ-6	Nebenantriebs-ID / PTO ID: NMV 221	(50)	
19.240	D2566MF	 1882 302 131	380 GF380			
		 1878 001 152	380 10 380WGTZ			
		 3151 000 395	KZIS-4			
	 3482 124 534 HD	430 GMF430				
	 1882 301 239 HD●	420 GF420				
	 1878 003 657 HD	420 10 420WGTZ				
	 3151 000 395 HD	KZIS-4	ZF-Getriebe / ZF Transmission	(62)		
	 3151 067 032 HD	KZI4,5	Fuller-Getriebe / Fuller Transmission	(24)		
19.250 DF 19.256 DH 19.275 D,DF 19.304 DF		 3482 124 541	430 GMF430			
		 1882 330 032 ●#	420 GF420			
		 1878 634 039 ▲	420 10 420WGTZ			
		 3151 000 395	KZIS-4			
19.256	D2566MF	 1878 002 955	420 10 420GTZ	Nebenantriebs-ID / PTO ID: 110	(50)	
19.256		 3482 124 534	430 GMF430			
		 1882 301 239 ●	420 GF420			
		 1878 003 657	420 10 420WGTZ			
		 3151 067 032	KZI4,5	Fuller-Getriebe / Fuller Transmission	(24)	
		 3151 000 395	KZIS-4	ZF-Getriebe / ZF Transmission	(62)	
	D2538M	 1882 302 131	380 GF380			
	 1878 001 152	380 10 380WGTZ				
 3151 000 395	KZIS-4					

		CODE				
--	--	------	--	---	---	---











MAN























19 ...						
19.280			 3482 124 534	430 GMF430		
			 1882 301 239 ●	420 GF420		
			 1878 003 657	420 10 420WGTZ		
			 3151 000 395	KZIS-4	ZF-Getriebe / ZF Transmission	(62)
			 3151 067 032	KZI4,5	Fuller-Getriebe / Fuller Transmission	(24)
19.281 19.291 19.321		D2566MKF	 1882 346 131 #	420 GF420XN	Nebenantriebs-ID / PTO ID: 130	(50)
			 1861 876 134 #	420 10 420GVZ	Nebenantriebs-ID / PTO ID: 130	(50)
19.281 19.291 504 19.321 19.331 504 19.361 504		D2866	 1800 125 501 #  1882 342 134  1861 911 232  3151 067 032	420 10 GF420X 420WGVZ KZI4,5		
			 1888 015 346	380 GF2/380	Je nach Kundenwunsch mit unterschiedlicher Kupplung / Equipped with different clutch according to customer requirement enthält eine Kupplungsscheibe / This part number includes one clutch disc	(35) (67)
			 1861 748 132 ▽	380 6 380GSZ	Lose Kupplungsscheibe / Loose clutch disc	(41)
			 3151 000 395	KZIS-4		
			 1882 280 112	380 GF2/380	In 1888 enthalten / Contained in 1888	(31)
			 1859 212 001	380 GF2/380	In 1888 enthalten / Contained in 1888	(31)
			 1861 749 132 △	380 10 380WGSZ	In 1888 enthalten / Contained in 1888	(31)
19.320		D2538MT, D2530MF	 3482 124 534	430 GMF430		
			 1882 301 239 ●	420 GF420		
			 1878 003 657	420 10 420WGTZ		
			 3151 000 395	KZIS-4	ZF-Getriebe / ZF Transmission	(62)
			 3151 067 032	KZI4,5	Fuller-Getriebe / Fuller Transmission	(24)
19.320 U,UL 902,918			 1878 000 967 ▽	380 10 380GTZ	Lose Kupplungsscheibe / Loose clutch disc	(41)
			 3151 000 395	KZIS-4		
			 1882 280 213	380 GF2/380	In 1888 enthalten / Contained in 1888	(31)
			 1859 212 000	380 GF2/380	In 1888 enthalten / Contained in 1888	(31)
			 1878 000 964 △	380 10 380GTZ	In 1888 enthalten / Contained in 1888	(31)
19.331 U 923		D2866LUL	 1882 342 134	420 GF420X		
			 1878 002 706	420 10 420GTZ		
			 3151 000 395	KZIS-4		
19.361		D2566KFZ	 1882 346 131 #	420 GF420XN	Nebenantriebs-ID / PTO ID: 130	(50)
			 1861 876 134 #	420 10 420GVZ	Nebenantriebs-ID / PTO ID: 130	(50)
19.361		D2866	 1800 125 501 #  1882 342 134  1861 911 232  3151 067 032	420 10 GF420X 420WGVZ KZI4,5		





































20 ...						
20.192 D,DHR		D2555	 1882 209 335 #	350 GF350		
			 1878 001 144	350 10 350WGTZ		
			1878 001 147 #	350 10 350WGTZ		
			 3151 000 958	KZIS-4		
20.240			 1882 302 131	380 GF380		
			 1878 001 152	380 10 380WGTZ		
			 3151 000 395	KZIS-4		
			 3482 124 534 HD	430 GMF430		
			 1882 301 239 HD ●	420 GF420		
			 1878 003 657 HD	420 10 420WGTZ		
			 3151 000 395 HD	KZIS-4	ZF-Getriebe / ZF Transmission	(62)
			 3151 067 032 HD	KZI4,5	Fuller-Getriebe / Fuller Transmission	(24)
20.280			 3482 124 534	430 GMF430		
			1882 301 239 ●	420 GF420		
			 1878 003 657	420 10 420WGTZ		
			 3151 000 395	KZIS-4	ZF-Getriebe / ZF Transmission	(62)
			 3151 067 032	KZI4,5	Fuller-Getriebe / Fuller Transmission	(24)
20.281 20.321		D2866	 1800 125 501 #	420 10 GF420X		
			 1882 342 134	420WGVZ		
			 1861 911 232	KZI4,5		
			 3151 067 032			
			 1888 015 346	380 GF2/380	Je nach Kundenwunsch mit unterschiedlicher Kupplung / Equipped with different clutch according to customer requirement enthält eine Kupplungsscheibe / This part number includes one clutch disc	(35) (67)
			 1861 748 132 ▽	380 6 380GSZ	Lose Kupplungsscheibe / Loose clutch disc	(41)
			 3151 000 395	KZIS-4		
			 1882 280 112	380 GF2/380	In 1888 enthalten / Contained in 1888	(31)
			 1859 212 001	380 GF2/380	In 1888 enthalten / Contained in 1888	(31)
			 1861 749 132 △	380 10 380WGSZ	In 1888 enthalten / Contained in 1888	(31)
20.320		D2530MF	 3482 124 534	430 GMF430		
			1882 301 239 ●	420 GF420		
			 1878 003 657	420 10 420WGTZ		
			 3151 000 395	KZIS-4	ZF-Getriebe / ZF Transmission	(62)
			3151 067 032	KZI4,5	Fuller-Getriebe / Fuller Transmission	(24)

		CODE				
--	--	------	--	---	---	---

MAN































20 ...						
20.331				1800 125 501 #  1882 342 134  1861 911 232  3151 067 032	420 10 GF420X 420WGVZ KZI4,5	
		D2866		1888 015 346	380 GF2/380	Je nach Kundenwunsch mit unterschiedlicher Kupplung / Equipped with different clutch according to customer requirement enthält eine Kupplungsscheibe / This part number includes one clutch disc (35) (67)
				1861 748 132 ▽	380 6 380GSZ	Lose Kupplungsscheibe / Loose clutch disc (41)
				3151 000 395	KZIS-4	
				1882 280 112	380 GF2/380	In 1888 enthalten / Contained in 1888 (31)
				1859 212 001	380 GF2/380	In 1888 enthalten / Contained in 1888 (31)
				1861 749 132 ▲	380 10 380WGSZ	In 1888 enthalten / Contained in 1888 (31)











22 ...						
22.186 H				1882 110 532 #	350 GF350	
				3151 000 395	KZIS-4	
22.192		D2156MYN		1882 110 532 #	350 GF350	
				1878 005 367	350 10 350WGTZ	
				3151 000 395	KZIS-4	
		D2565M		3482 002 234 HD	350 GMF350X	
				1882 209 335 #	350 GF350	
				1878 001 144	350 10 350WGTZ	
				1878 001 147 #	350 10 350WGTZ	
				3151 000 958	KZIS-4	
22.220 522 22.240 522	01.81 - 12.88	D2556MF		1882 302 131	380 GF380	Je nach Kundenwunsch mit unterschiedlicher Kupplung / Equipped with different clutch according to customer requirement (35)
				1878 001 152	380 10 380WGTZ	
				3482 124 534	430 GMF430	Je nach Kundenwunsch mit unterschiedlicher Kupplung / Equipped with different clutch according to customer requirement (35)
				1882 301 239 ●	420 GF420	Je nach Kundenwunsch mit unterschiedlicher Kupplung / Equipped with different clutch according to customer requirement (35)
				1878 003 657	420 10 420WGTZ	
				3151 000 395	KZIS-4	
22.230				3151 000 395	KZIS-4	
22.242 22.292 22.302 22.332 22.362 22.372 22.422	07.90 -	D2866		1882 017 131	420 GF420XN	Nebenantriebs-ID / PTO ID: 130E (50)
	07.90 -			1878 086 941	420 10 420WGTZ	Nebenantriebs-ID / PTO ID: 130E (50)
22.256 DH 22.304 DF				3482 124 541	430 GMF430	
				1882 330 032 ●#	420 GF420	
				1878 634 039 ▲	420 10 420WGTZ	
				3151 000 395	KZIS-4	























22 ...						
22.262	07.90-	D2865		1882 017 131	420 GF420XN	Nebenantriebs-ID / PTO ID: 130E (50)
22.272	07.90-			1878 086 941	420 10 420WGTZ	Nebenantriebs-ID / PTO ID: 130E (50)
22.322	07.90-			3482 124 534	430 GMF430	
22.280				1882 301 239 ●	420 GF420	
				1878 003 657	420 10 420WGTZ	
				3151 000 395	KZIS-4	ZF-Getriebe / ZF Transmission (62)
				3151 067 032	KZI4,5	Fuller-Getriebe / Fuller Transmission (24)
22.281 506	01.80 - 12.88	D2866		1800 125 501 #	420 10 GF420X 420WGVZ KZI4,5	
22.291 506	01.80 - 12.88			1882 342 134		
22.321 506	01.80 - 12.88			1861 911 232		
22.331 506	01.80 - 12.88			3151 067 032		
22.361 506	01.80 - 12.88			1888 015 346	380 GF2/380	enthält eine Kupplungsscheibe / This part number includes one clutch disc (67)
				1861 748 132 ▽	380 6 380GSZ	Lose Kupplungsscheibe / Loose clutch disc (41)
				3151 000 395	KZIS-4	
				1882 280 112	380 GF2/380	In 1888 enthalten / Contained in 1888 (31)
				1859 212 001	380 GF2/380	In 1888 enthalten / Contained in 1888 (31)
				1861 749 132 △	380 10 380WGSZ	In 1888 enthalten / Contained in 1888 (31)
22.320		D2530MF		3482 124 534	430 GMF430	
				1882 301 239 ●	420 GF420	
				1878 003 657	420 10 420WGTZ	
				3151 000 395	KZIS-4	ZF-Getriebe / ZF Transmission (62)
				3151 067 032	KZI4,5	Fuller-Getriebe / Fuller Transmission (24)
22.320 UNL 904				1878 000 967 ▽	380 10 380GTZ	Lose Kupplungsscheibe / Loose clutch disc (41)
				3151 000 395	KZIS-4	
				1882 280 213	380 GF2/380	In 1888 enthalten / Contained in 1888 (31)
				1859 212 000	380 GF2/380	In 1888 enthalten / Contained in 1888 (31)
				1878 000 964 △	380 10 380GTZ	In 1888 enthalten / Contained in 1888 (31)
22.361 930		D2866		1800 125 501 #	420 10 GF420X 420WGVZ KZI4,5	
				1882 342 134		
				1861 911 232		
				3151 067 032		
22.403	01.97 -	D2866, 2867		3400 122 201	430 10 MFZ430	
22.463	01.97 -			3482 083 032	430WGTZ	
				1878 004 832		
				3151 000 034	KZISZ-5	
				3189 600 020		Getr. / GBox: ZF Ecosplit-3

		CODE				
--	--	------	--	---	---	---

MAN



































24 ...						
24.220 522	01.81 - 12.88	D2556MF		1882 302 131	380 GF380	Je nach Kundenwunsch mit unterschiedlicher Kupplung / Equipped with different clutch according to customer requirement (35)
24.240 522	01.81 - 12.88			1878 001 152	380 10 380WGTZ	
				3482 124 534	430 GMF430	Je nach Kundenwunsch mit unterschiedlicher Kupplung / Equipped with different clutch according to customer requirement (35)
				1882 301 239 ●	420 GF420	Je nach Kundenwunsch mit unterschiedlicher Kupplung / Equipped with different clutch according to customer requirement (35)
				1878 003 657	420 10 420WGTZ	
				3151 000 395	KZIS-4	
24.242 24.292 24.362	07.90 - 07.90 - 07.90 -	D2866		1882 017 131	420 GF420XN	Nebenantriebs-ID / PTO ID: 130E (50)
				1878 086 941	420 10 420WGTZ	Nebenantriebs-ID / PTO ID: 130E (50)
				3151 204 001	KZI-6	mit Schmierrohranschluss / with lubrication pipe connection Nebenantriebs-ID / PTO ID: 130E (91) Nebenantriebs-ID / PTO ID: 130E (50)
24.262	07.90 -	D2865		1882 017 131	420 GF420XN	Nebenantriebs-ID / PTO ID: 130E (50)
				1878 086 941	420 10 420WGTZ	Nebenantriebs-ID / PTO ID: 130E (50)
				3151 204 001	KZI-6	mit Schmierrohranschluss / with lubrication pipe connection Nebenantriebs-ID / PTO ID: 130E (91) Nebenantriebs-ID / PTO ID: 130E (50)
24.291 506	01.80 - 12.88	D2866		1800 125 501 #	420 10 GF420X	
24.331 506	01.80 - 12.88			1882 342 134	420WGVZ	
24.361 506	01.80 - 12.88			1861 911 232	KZI4,5	
				1888 015 346	380 GF2/380	Je nach Kundenwunsch mit unterschiedlicher Kupplung / Equipped with different clutch according to customer requirement (35) enthält eine Kupplungsscheibe / This part number includes one clutch disc (67)
				1861 748 132 ▽	380 6 380GSZ	Lose Kupplungsscheibe / Loose clutch disc (41)
				3151 000 395	KZIS-4	
				1882 280 112	380 GF2/380	In 1888 enthalten / Contained in 1888 (31)
				1859 212 001	380 GF2/380	In 1888 enthalten / Contained in 1888 (31)
				1861 749 132 △	380 10 380WGSZ	In 1888 enthalten / Contained in 1888 (31)
25 ...						
25.220 522	01.81 - 12.88	D2556MF		1882 302 131	380 GF380	Je nach Kundenwunsch mit unterschiedlicher Kupplung / Equipped with different clutch according to customer requirement (35)
25.240 522	01.81 - 12.88			1878 001 152	380 10 380WGTZ	
				3482 124 534	430 GMF430	Je nach Kundenwunsch mit unterschiedlicher Kupplung / Equipped with different clutch according to customer requirement (35)
				1882 301 239 ●	420 GF420	Je nach Kundenwunsch mit unterschiedlicher Kupplung / Equipped with different clutch according to customer requirement (35)
				1878 003 657	420 10 420WGTZ	
				3151 000 395	KZIS-4	
25.242 25.292 25.332 25.362	07.90 - 07.90 - 07.90 - 07.90 -	D2866		1882 017 131	420 GF420XN	Nebenantriebs-ID / PTO ID: 130E (50)
25.262	07.90 -			1878 086 941	420 10 420WGTZ	Nebenantriebs-ID / PTO ID: 130E (50)
		D2865		1882 017 131	420 GF420XN	Nebenantriebs-ID / PTO ID: 130E (50)
				1878 086 941	420 10 420WGTZ	Nebenantriebs-ID / PTO ID: 130E (50)

25 ...							
25.291 506	01.80 - 12.88	D2866		1800 125 501 #  1882 342 134  1861 911 232  3151 067 032	420 10 GF420X 420WGVZ KZI4,5		
25.331 506	01.80 - 12.88			1888 015 346	380 GF2/380	Je nach Kundenwunsch mit unterschiedlicher Kupplung / Equipped with different clutch according to customer requirement enthält eine Kupplungsscheibe / This part number includes one clutch disc	(35) (67)
25.361 506	01.80 - 12.88			1861 748 132 ▽	380 6 380GSZ	Lose Kupplungsscheibe / Loose clutch disc	(41)
				3151 000 395	KZIS-4		
				1882 280 112	380 GF2/380	In 1888 enthalten / Contained in 1888	(31)
				1859 212 001	380 GF2/380	In 1888 enthalten / Contained in 1888	(31)
				1861 749 132 △	380 10 380WGSZ	In 1888 enthalten / Contained in 1888	(31)

26 ...							
26.220 522	01.81 - 12.88	D2556MF		1882 302 131	380 GF380	Je nach Kundenwunsch mit unterschiedlicher Kupplung / Equipped with different clutch according to customer requirement	(35)
26.240 522	01.81 - 12.88			1878 001 152	380 10 380WGTZ		
				3482 124 534	430 GMF430	Je nach Kundenwunsch mit unterschiedlicher Kupplung / Equipped with different clutch according to customer requirement	(35)
				1882 301 239 ●	420 GF420	Je nach Kundenwunsch mit unterschiedlicher Kupplung / Equipped with different clutch according to customer requirement	(35)
				1878 003 657	420 10 420WGTZ		
				3151 000 395	KZIS-4		
26.232				1882 302 131	380 GF380		
				1878 001 152	380 10 380WGTZ		
				3151 000 395	KZIS-4		
26.240		D2566MF		1878 002 955	420 10 420GTZ	Nebenantriebs-ID / PTO ID: 110	(50)
				3482 124 534 HD	430 GMF430		
				1882 301 239 HD ●	420 GF420		
				1878 003 657 HD	420 10 420WGTZ		
				3151 000 395 HD	KZIS-4	ZF-Getriebe / ZF Transmission	(62)
				3151 067 032 HD	KZI4,5	Fuller-Getriebe / Fuller Transmission	(24)
26.256		D2538M, MF		1882 302 131	380 GF380		
				1878 001 152	380 10 380WGTZ		
				3151 000 395	KZIS-4		
				1882 301 239 ●	420 GF420		
				3482 124 534	430 GMF430		
				1878 003 657	420 10 420WGTZ		
				3151 000 395	KZIS-4	ZF-Getriebe / ZF Transmission	(62)
				3151 067 032	KZI4,5	Fuller-Getriebe / Fuller Transmission	(24)



































		CODE		 Parameter		
--	--	------	--	---	---	---

MAN

26 ...						
26.256 H 26.304 DFL			 3482 124 541	430 GMF430		
			 1882 330 032 ● #	420 GF420		
			 1878 634 039 ▲	420 10 420WGTZ		
			 3151 000 395	KZIS-4		
26.280 26.304			 3482 124 534	430 GMF430		
			 1882 301 239 ●	420 GF420		
			 1878 003 657	420 10 420WGTZ		
			 3151 000 395	KZIS-4	ZF-Getriebe / ZF Transmission	(62)
26.281 26.321		D2566MKF	 1882 346 131 #	420 GF420XN	Nebenantriebs-ID / PTO ID: 130	(50)
			 1861 876 134 #	420 10 420GVZ	Nebenantriebs-ID / PTO ID: 130	(50)
26.281 507 26.321 507	01.80 - 09.94	D2866MK	 1800 125 501 #	420 10 GF420X		
			 1882 342 134	420WGVZ		
	 1861 911 232	KZI4,5				
	 3151 067 032					
	 1888 015 346	380 GF2/380	Je nach Kundenwunsch mit unterschiedlicher Kupplung / Equipped with different clutch according to customer requirement enthält eine Kupplungsscheibe / This part number includes one clutch disc	(35) (67)		
	 1861 748 132 ▽	380 6 380GSZ	Lose Kupplungsscheibe / Loose clutch disc	(41)		
	 3151 000 395	KZIS-4				
	 1882 280 112	380 GF2/380	In 1888 enthalten / Contained in 1888	(31)		
 1859 212 001	380 GF2/380	In 1888 enthalten / Contained in 1888	(31)			
 1861 749 132 △	380 10 380WGSZ	In 1888 enthalten / Contained in 1888	(31)			
26.291 506,509 26.331 506	01.80 - 12.88	D2866	 1800 125 501 #	420 10 GF420X		
			 1882 342 134	420WGVZ		
	 1861 911 232	KZI4,5				
	 3151 067 032					
	 1888 015 346	380 GF2/380	Je nach Kundenwunsch mit unterschiedlicher Kupplung / Equipped with different clutch according to customer requirement enthält eine Kupplungsscheibe / This part number includes one clutch disc	(35) (67)		
	 1861 748 132 ▽	380 6 380GSZ	Lose Kupplungsscheibe / Loose clutch disc	(41)		
	 3151 000 395	KZIS-4				
	 1882 280 112	380 GF2/380	In 1888 enthalten / Contained in 1888	(31)		
 1859 212 001	380 GF2/380	In 1888 enthalten / Contained in 1888	(31)			
 1861 749 132 △	380 10 380WGSZ	In 1888 enthalten / Contained in 1888	(31)			
26.320		D2538MT, D2530MF	 3482 124 534	430 GMF430		
			 1882 301 239 ●	420 GF420		
			 1878 003 657	420 10 420WGTZ		
			 3151 000 395	KZIS-4	ZF-Getriebe / ZF Transmission	(62)
			 3151 067 032	KZI4,5	Fuller-Getriebe / Fuller Transmission	(24)





























		CODE				
--	--	------	--	---	---	---

MAN





































26 ...							
26.361 506	01.80 - 12.88	D2866		1882 342 134	420 GF420X	Je nach Kundenwunsch mit unterschiedlicher Kupplung / Equipped with different clutch according to customer requirement	(35)
				1861 911 232	420 10 420WGVZ		
				3151 067 032	KZ14,5		
				1888 015 346	380 GF2/380	Je nach Kundenwunsch mit unterschiedlicher Kupplung / Equipped with different clutch according to customer requirement enthält eine Kupplungsscheibe / This part number includes one clutch disc	(35) (67)
				1861 748 132 ▽	380 6 380GSZ	Lose Kupplungsscheibe / Loose clutch disc	(41)
				3151 000 395	KZIS-4		
				1882 280 112	380 GF2/380	In 1888 enthalten / Contained in 1888	(31)
				1859 212 001	380 GF2/380	In 1888 enthalten / Contained in 1888	(31)
				1861 749 132 △	380 10 380WGSZ	In 1888 enthalten / Contained in 1888	(31)
26.365 547	02.83 - 06.90	D2840MF		1800 125 501 #  1882 342 134  1861 911 232  3151 067 032	420 10 GF420X 420WGVZ KZ14,5		
				1888 015 346	380 GF2/380	Je nach Kundenwunsch mit unterschiedlicher Kupplung / Equipped with different clutch according to customer requirement enthält eine Kupplungsscheibe / This part number includes one clutch disc	(35) (67)
				1861 748 132 ▽	380 6 380GSZ	Lose Kupplungsscheibe / Loose clutch disc	(41)
				3151 000 395	KZIS-4		
				1882 280 112	380 GF2/380	In 1888 enthalten / Contained in 1888	(31)
				1859 212 001	380 GF2/380	In 1888 enthalten / Contained in 1888	(31)
				1861 749 132 △	380 10 380WGSZ	In 1888 enthalten / Contained in 1888	(31)
27 ...							
27.343	01.94 -	D2865LF09		3400 122 301  3482 083 032  1878 080 034  3151 000 034	430 10 MFZ430 430WGTZ KZISZ-5		
				3189 600 020		Getr. / GBox: ZF Ecosplit-3	
28 ...							
28.272 28.322 28.342 28.402	01.90 - 01.88 - 01.88 -	D2865LF		1882 017 131	420 GF420XN	Nebenantriebs-ID / PTO ID: 130E	(50)
				1878 086 941	420 10 420WGTZ	Nebenantriebs-ID / PTO ID: 130E	(50)
				1882 017 131	420 GF420XN	Nebenantriebs-ID / PTO ID: 130E	(50)
28.292 28.302 28.332 28.372 28.422	01.86 - 01.90 - 01.86 - 01.90 - 01.90 -	D2866LF		1878 086 941	420 10 420WGTZ	Nebenantriebs-ID / PTO ID: 130E	(50)
				1882 017 131	420 GF420XN	Nebenantriebs-ID / PTO ID: 130E	(50)
				1878 086 941	420 10 420WGTZ	Nebenantriebs-ID / PTO ID: 130E	(50)
				1882 017 131	420 GF420XN	Nebenantriebs-ID / PTO ID: 130E	(50)
30 ...							
30.232				1882 302 131	380 GF380		
				1878 001 152	380 10 380WGTZ		
				3151 000 395	KZIS-4		

		CODE				
--	--	------	--	---	---	---

MAN

30 ...								
30.240		D2538M	 1882 302 131	380 GF380				
			 1878 001 152	380 10 380WGTZ				
			 3151 000 395	KZIS-4				
		D2566MF			 1878 002 955	420 10 420GTZ	Nebenantriebs-ID / PTO ID: 110	(50)
					 3482 124 534 HD	430 GMF430		
					 1882 301 239 HD ●	420 GF420		
					 1878 003 657 HD	420 10 420WGTZ		
					 3151 000 395 HD	KZIS-4	ZF-Getriebe / ZF Transmission	(62)
					 3151 067 032 HD	KZI4,5	Fuller-Getriebe / Fuller Transmission	(24)
		30.256		D2538M	 1882 302 131	380 GF380		
 1878 001 152	380 10 380WGTZ							
 3151 000 395	KZIS-4							
					 3482 124 534	430 GMF430		
					 1882 301 239 ●	420 GF420		
					 1878 003 657	420 10 420WGTZ		
					 3151 000 395	KZIS-4	ZF-Getriebe / ZF Transmission	(62)
					 3151 067 032	KZI4,5	Fuller-Getriebe / Fuller Transmission	(24)
30.256 H			 3482 124 541	430 GMF430				
			 1882 330 032 ●#	420 GF420				
			 1878 634 039 ▲	420 10 420WGTZ				
			 3151 000 395	KZIS-4				
30.262 30.272 30.322	01.89 - 01.92 - 01.90 -	D2865LF	 1882 017 131	420 GF420XN	Nebenantriebs-ID / PTO ID: 130E	(50)		
			 1878 086 941	420 10 420WGTZ	Nebenantriebs-ID / PTO ID: 130E	(50)		
30.280			 3482 124 534	430 GMF430				
			 1882 301 239 ●	420 GF420				
			 1878 003 657	420 10 420WGTZ				
			 3151 000 395	KZIS-4	ZF-Getriebe / ZF Transmission	(62)		
			 3151 067 032	KZI4,5	Fuller-Getriebe / Fuller Transmission	(24)		
		D2566MF	 1878 002 955	420 10 420GTZ	Nebenantriebs-ID / PTO ID: 110	(50)		













MAN



















30 ...						
30.281 512 30.321 512		D2566	 1888 015 346	380 GF2/380	->07.1983 enthält eine Kupplungsscheibe / This part number includes one clutch disc	(67)
			 1861 748 132 ▽	380 6 380GSZ	->07.1983 Lose Kupplungsscheibe / Loose clutch disc	(41)
			 3151 000 395	KZIS-4	->07.1983	
			 1882 280 112	380 GF2/380	->07.1983 In 1888 enthalten / Contained in 1888	(31)
			 1859 212 001	380 GF2/380	->07.1983 In 1888 enthalten / Contained in 1888	(31)
			 1861 749 132 △	380 10 380WGSZ	->07.1983 In 1888 enthalten / Contained in 1888	(31)
			 1800 125 501 #  1882 342 134  1861 911 232  3151 067 032	420 10 GF420X 420WGVZ KZI4,5	08.1983->	
			 1882 346 131 #	420 GF420XN	Nebenantriebs-ID / PTO ID: 130/1	(50)
			 1861 876 134 #	420 10 420GVZ	Nebenantriebs-ID / PTO ID: 130/1	(50)
30.291 512,513 30.331 512,513		D2566	 1888 015 346	380 GF2/380	->07.1983 512 enthält eine Kupplungsscheibe / This part number includes one clutch disc	(67)
			 1861 748 132 ▽	380 6 380GSZ	->07.1983 512 Lose Kupplungsscheibe / Loose clutch disc	(41)
			 3151 000 395	KZIS-4	->07.1983 512	
			 1882 280 112	380 GF2/380	->07.1983 512 In 1888 enthalten / Contained in 1888	(31)
			 1859 212 001	380 GF2/380	->07.1983 512 In 1888 enthalten / Contained in 1888	(31)
			 1861 749 132 △	380 10 380WGSZ	->07.1983 512 In 1888 enthalten / Contained in 1888	(31)
			 1800 125 501 #  1882 342 134  1861 911 232  3151 067 032	420 10 GF420X 420WGVZ KZI4,5	08.1983->	
			 1882 346 131 #	420 GF420XN	Nebenantriebs-ID / PTO ID: 130/1	(50)
			 1861 876 134 #	420 10 420GVZ	Nebenantriebs-ID / PTO ID: 130/1	(50)
30.292 30.302 30.332 30.372 30.422	01.87 - 01.90 - 01.87 - 01.90 - 01.90 -	D2866LF	 1882 017 131	420 GF420XN	Nebenantriebs-ID / PTO ID: 130E	(50)
			 1878 086 941	420 10 420WGTZ	Nebenantriebs-ID / PTO ID: 130E	(50)
30.304			 3482 124 534	430 GMF430		
			 1882 301 239 ●	420 GF420		
			 1878 003 657	420 10 420WGTZ		
			 3151 000 395	KZIS-4	ZF-Getriebe / ZF Transmission	(62)
30.320		D2538MT, D2530MF	 3482 124 534	430 GMF430		
			 1882 301 239 ●	420 GF420		
			 1878 003 657	420 10 420WGTZ		
			 3151 000 395	KZIS-4	ZF-Getriebe / ZF Transmission	(62)
			 3151 067 032	KZI4,5	Fuller-Getriebe / Fuller Transmission	(24)
30.361 512,513		D2866	 1800 125 501 #	420 10		







		CODE				
--	--	------	--	---	---	---

MAN

30 ...						
30.362	01.87-	D2866KF, LXF		1882 017 131	420 GF420XN	Nebenantriebs-ID / PTO ID: 130E (50)
				1878 086 941	420 10 420WGTZ	Nebenantriebs-ID / PTO ID: 130E (50)





















31 ...						
31.262 31.272 31.322	01.89- 01.90-	D2865LF		1882 017 131	420 GF420XN	Nebenantriebs-ID / PTO ID: 130E (50)
				1878 086 941	420 10 420WGTZ	Nebenantriebs-ID / PTO ID: 130E (50)
31.292 31.302 31.332 31.372 31.422	01.87- 01.90- 01.87- 01.90- 01.90-	D2866LF		1882 017 131	420 GF420XN	Nebenantriebs-ID / PTO ID: 130E (50)
				1878 086 941	420 10 420WGTZ	Nebenantriebs-ID / PTO ID: 130E (50)
				1882 017 131	420 GF420XN	Nebenantriebs-ID / PTO ID: 130E (50)
				1878 086 941	420 10 420WGTZ	Nebenantriebs-ID / PTO ID: 130E (50)
31.342	01.94-	D2865		1882 017 131	420 GF420XN	Nebenantriebs-ID / PTO ID: 130E (50)
				1878 086 941	420 10 420WGTZ	Nebenantriebs-ID / PTO ID: 130E (50)
31.362	01.87-	D2866KF, LXF		1882 017 131	420 GF420XN	Nebenantriebs-ID / PTO ID: 130E (50)
				1878 086 941	420 10 420WGTZ	Nebenantriebs-ID / PTO ID: 130E (50)
31.402	01.94-	D2866		1882 017 131	420 GF420XN	Nebenantriebs-ID / PTO ID: 130E (50)
				1878 086 941	420 10 420WGTZ	Nebenantriebs-ID / PTO ID: 130E (50)









32 ...						
32.232		D2556MF		1882 302 131	380 GF380	
				1878 001 152	380 10 380WGTZ	
				3151 000 395	KZIS-4	
32.240		D2556MF		1882 302 131	380 GF380	
				1878 001 152	380 10 380WGTZ	
				3151 000 395	KZIS-4	
		D2566MF		1878 002 955	420 10 420GTZ	Nebenantriebs-ID / PTO ID: 110 (50)
				3482 124 534 HD	430 GMF430	
				1882 301 239 HD ●	420 GF420	
				1878 003 657 HD	420 10 420WGTZ	
				3151 000 395 HD	KZIS-4	ZF-Getriebe / ZF Transmission (62)
				3151 067 032 HD	KZI4,5	Fuller-Getriebe / Fuller Transmission (24)
32.256		D2538M		1882 302 131	380 GF380	
				1878 001 152	380 10 380WGTZ	
				3151 000 395	KZIS-4	
32.262 32.272 32.322	01.87- 01.88-	D2865LF		1882 017 131	420 GF420XN	Nebenantriebs-ID / PTO ID: 130E (50)
				1878 086 941	420 10 420WGTZ	Nebenantriebs-ID / PTO ID: 130E (50)
32.280		D2566MF		1878 002 955	420 10 420GTZ	Nebenantriebs-ID / PTO ID: 110 (50)

32 ...						
32.280		D2530MF		3482 124 534	430 GMF430	
				1882 301 239 ●	420 GF420	
				1878 003 657	420 10 420WGTZ	
				3151 000 395	KZIS-4	ZF-Getriebe / ZF Transmission (62)
				3151 067 032	KZI4,5	Fuller-Getriebe / Fuller Transmission (24)
32.281 507	01.80 - 09.94	D2866MK		1800 125 501 #	420 10 GF420X	
32.321 507	01.80 - 09.94			1882 342 134	420WGVZ	
				1861 911 232	KZI4,5	
				3151 067 032		
				1888 015 346	380 GF2/380	Je nach Kundenwunsch mit unterschiedlicher Kupplung / Equipped with different clutch according to customer requirement enthält eine Kupplungsscheibe / This part number includes one clutch disc (35) (67)
				1861 748 132 ▽	380 6 380GSZ	Lose Kupplungsscheibe / Loose clutch disc (41)
				3151 000 395	KZIS-4	
				1882 280 112	380 GF2/380	In 1888 enthalten / Contained in 1888 (31)
		1859 212 001	380 GF2/380	In 1888 enthalten / Contained in 1888 (31)		
		1861 749 132 △	380 10 380WGSZ	In 1888 enthalten / Contained in 1888 (31)		
32.291 512	08.83 -	D2866		1800 125 501 #	420 10 GF420X	
32.331 512	08.83 -			1882 342 134	420WGVZ	
32.361 512				1861 911 232	KZI4,5	
				3151 067 032		
32.291 512	- 07.83	D2866		1888 015 346	380 GF2/380	enthält eine Kupplungsscheibe / This part number includes one clutch disc (67)
32.331 512	- 07.83			1861 748 132 ▽	380 6 380GSZ	Lose Kupplungsscheibe / Loose clutch disc (41)
				3151 000 395	KZIS-4	
				1882 280 112	380 GF2/380	In 1888 enthalten / Contained in 1888 (31)
				1859 212 001	380 GF2/380	In 1888 enthalten / Contained in 1888 (31)
				1861 749 132 △	380 10 380WGSZ	In 1888 enthalten / Contained in 1888 (31)
32.291 512		D2866		1882 346 131 #	420 GF420XN	Nebenantriebs-ID / PTO ID: 130/1 (50)
32.331 512				1861 876 134 #	420 10 420GVZ	Nebenantriebs-ID / PTO ID: 130/1 (50)
32.292	01.85 -	D2866LF		1882 017 131	420 GF420XN	Nebenantriebs-ID / PTO ID: 130E (50)
32.332	01.85 -			1878 086 941	420 10	Nebenantriebs-ID / PTO ID: 130E (50)
32.372	01.88 -				420WGTZ	
32.422	01.88 -					
32.320		D2538MT, D2530MF		3482 124 534	430 GMF430	
				1882 301 239 ●	420 GF420	
				1878 003 657	420 10 420WGTZ	
				3151 000 395	KZIS-4	ZF-Getriebe / ZF Transmission (62)
				3151 067 032	KZI4,5	Fuller-Getriebe / Fuller Transmission (24)











































		CODE				
--	--	------	--	---	---	---

MAN

32 ...						
32.320 DFA		D2530MF	 1888 015 523 #	380 GF2/380	enthält eine Kupplungsscheibe / This part number includes one clutch disc	(67)
			 1878 000 967 ▽	380 10 380GTZ	Lose Kupplungsscheibe / Loose clutch disc	(41)
			 3151 000 395	KZIS-4		
			 1882 280 213	380 GF2/380	In 1888 enthalten / Contained in 1888	(31)
			 1859 212 001	380 GF2/380	In 1888 enthalten / Contained in 1888	(31)
			 1878 000 964 △	380 10 380GTZ	In 1888 enthalten / Contained in 1888	(31)
32.342	01.94 -	D2865	 1882 017 131	420 GF420XN	Nebenantriebs-ID / PTO ID: 130E	(50)
			 1878 086 941	420 10 420WGTZ	Nebenantriebs-ID / PTO ID: 130E	(50)
32.365 547	02.83 - 06.90	D2840MF	 1800 125 501 #	420 10 GF420X 420WGVZ KZI4,5	Je nach Kundenwunsch mit unterschiedlicher Kupplung / Equipped with different clutch according to customer requirement enthält eine Kupplungsscheibe / This part number includes one clutch disc	(35) (67)
			 1882 342 134			
			 1861 911 232			
			 3151 067 032			
			 1888 015 346	380 GF2/380		
			 1861 748 132 ▽	380 6 380GSZ	Lose Kupplungsscheibe / Loose clutch disc	(41)
 3151 000 395	KZIS-4					
 1882 280 112	380 GF2/380	In 1888 enthalten / Contained in 1888	(31)			
 1859 212 001	380 GF2/380	In 1888 enthalten / Contained in 1888	(31)			
 1861 749 132 △	380 10 380WGSZ	In 1888 enthalten / Contained in 1888	(31)			
32.462	01.85 -	D2840LF	 1882 017 131	420 GF420XN	Nebenantriebs-ID / PTO ID: 130E	(50)
			 1878 086 941	420 10 420WGTZ	Nebenantriebs-ID / PTO ID: 130E	(50)













































33 ...						
33.240 427			 1882 302 131	380 GF380		
			 1878 001 152	380 10 380WGTZ		
			 3151 000 395	KZIS-4		
33.240 33.280		D2566MF	 1878 002 955	420 10 420GTZ	Nebenantriebs-ID / PTO ID: 110	(50)
33.280 33.320		D2530MF	 3482 124 534	430 GMF430		
			 1882 301 239 ●	420 GF420		
			 1878 003 657	420 10 420WGTZ		
			 3151 000 395	KZIS-4	ZF-Getriebe / ZF Transmission	(62)
			 3151 067 032	KZI4,5	Fuller-Getriebe / Fuller Transmission	(24)

MAN





33 ...						
33.281		D2566MKF	 1800 125 501 #  1882 342 134  1861 911 232  3151 067 032	420 10 GF420X 420WGVZ KZI4,5		
			 1888 015 346	380 GF2/380	Je nach Kundenwunsch mit unterschiedlicher Kupplung / Equipped with different clutch according to customer requirement enthält eine Kupplungsscheibe / This part number includes one clutch disc	(35) (67)
			 1861 748 132 ▽	380 6 380GSZ	Lose Kupplungsscheibe / Loose clutch disc	(41)
			 3151 000 395	KZIS-4		
			 1882 280 112	380 GF2/380	In 1888 enthalten / Contained in 1888	(31)
			 1859 212 001	380 GF2/380	In 1888 enthalten / Contained in 1888	(31)
			 1861 749 132 △	380 10 380WGSZ	In 1888 enthalten / Contained in 1888	(31)
33.291 512 33.321 512 33.331 512		D2866	 1888 015 346	380 GF2/380	-> 07.1983 enthält eine Kupplungsscheibe / This part number includes one clutch disc	(67)
			 1861 748 132 ▽	380 6 380GSZ	-> 07.1983 Lose Kupplungsscheibe / Loose clutch disc	(41)
			 3151 000 395	KZIS-4	-> 07.1983	
			 1882 280 112	380 GF2/380	-> 07.1983 In 1888 enthalten / Contained in 1888	(31)
			 1859 212 001	380 GF2/380	-> 07.1983 In 1888 enthalten / Contained in 1888	(31)
			 1861 749 132 △	380 10 380WGSZ	-> 07.1983 In 1888 enthalten / Contained in 1888	(31)
			 1800 125 501 #  1882 342 134  1861 911 232  3151 067 032	420 10 GF420X 420WGVZ KZI4,5	08.1983->	
			 1882 346 131 #	420 GF420XN	Nebenantriebs-ID / PTO ID: 130/1	(50)
	 1861 876 134 #	420 10 420GVZ	Nebenantriebs-ID / PTO ID: 130/1	(50)		
33.361 512,513			 1800 125 501 #  1882 342 134  1861 911 232  3151 067 032	420 10 GF420X 420WGVZ KZI4,5		
34 ...						
34.291 512 34.331 512	- 07.83	D2866	 1888 015 346	380 GF2/380	enthält eine Kupplungsscheibe / This part number includes one clutch disc	(67)
	- 07.83		 1861 748 132 ▽	380 6 380GSZ	Lose Kupplungsscheibe / Loose clutch disc	(41)
			 3151 000 395	KZIS-4		
			 1882 280 112	380 GF2/380	In 1888 enthalten / Contained in 1888	(31)
			 1859 212 001	380 GF2/380	In 1888 enthalten / Contained in 1888	(31)
			 1861 749 132 △	380 10 380WGSZ	In 1888 enthalten / Contained in 1888	(31)
34.291 512 34.331 512 34.361 512		D2866	 1800 125 501 #  1882 342 134  1861 911 232  3151 067 032	420 10 GF420X 420WGVZ KZI4,5	08.1983->	
			 1882 346 131 #	420 GF420XN	Nebenantriebs-ID / PTO ID: 130/1	(50)
			 1861 876 134 #	420 10 420GVZ	Nebenantriebs-ID / PTO ID: 130/1	(50)
34.361 512		D2866	 1800 125 501 #  1882 342 134  1861 911 232  3151 067 032	420 10 GF420X 420WGVZ KZI4,5		









		CODE				
--	--	------	--	---	---	---



MAN



35 ...						
35.332 35.372		D2866LF	 1882 017 131	420 GF420XN	Nebenantriebs-ID / PTO ID: 130E	(50)
			 1878 086 941	420 10 420WGTZ	Nebenantriebs-ID / PTO ID: 130E	(50)
			 3151 204 001	KZI-6	mit Schmierrohranschluss / with lubrication pipe connection Nebenantriebs-ID / PTO ID: 130E	(91) (50)
35.362		D2866KF	 1882 017 131	420 GF420XN	Nebenantriebs-ID / PTO ID: 130E	(50)
			 1878 086 941	420 10 420WGTZ	Nebenantriebs-ID / PTO ID: 130E	(50)
			 3151 204 001	KZI-6	mit Schmierrohranschluss / with lubrication pipe connection Nebenantriebs-ID / PTO ID: 130E	(91) (50)
36 ...						
36.291 513 36.331 513 36.361 513			 1800 125 501 #	420 10		
			 1882 342 134	GF420X		
			 1861 911 232	420WGVZ		
			 3151 067 032	KZI4,5		
36.291 513 36.331 513 36.361 513			 1882 342 134	420 GF420X		
			 1861 911 232	420 10 420WGVZ		
			 3151 067 032	KZI4,5		
38 ...						
38.262	01.85 -		 3400 127 601	400 10	Nabenprofil / Hub Profile: 2"-10N	(48)
			 3482 078 133	MFZ400		
			 1862 364 031	400WGVZ		
			 3151 000 034	KZISZ-5		
			 3189 600 020		Getr. / GBox: ZF Ecosplit-3	
38.462	01.85 -	D2840LF	 1882 017 131	420 GF420XN	Nebenantriebs-ID / PTO ID: 130E	(50)
			 1878 086 941	420 10 420WGTZ	Nebenantriebs-ID / PTO ID: 130E	(50)
38.462	01.85 -	D2840LF	 3400 122 201	430 10		
			 3482 083 032	MFZ430		
			 1878 004 832	430WGTZ		
			 3151 000 034	KZISZ-5		
			 3189 600 020		Getr. / GBox: ZF Ecosplit-3	
40 ...						
40.242	01.85 -	D2865LF02, D2866F	 3400 700 310	400 10	Nabenprofil / Hub Profile: 1 3/4"-10N	(48)
			 3482 078 133	MFZ400		
			 1862 364 031	400WGVZ		
			 3151 000 034	KZISZ-5		
			 3189 600 020		Getr. / GBox: ZF Ecosplit-3	
40.262 40.292	01.85 - 01.85 -		 3400 127 601	400 10	Nabenprofil / Hub Profile: 2"-10N	(48)
			 3482 078 133	MFZ400		
			 1862 364 031	400WGVZ		
			 3151 000 034	KZISZ-5		
			 3189 600 020		Getr. / GBox: ZF Ecosplit-3	
40.332	01.85 -	D2866LF	 3400 122 201	430 10		
			 3482 083 032	MFZ430		
			 1878 004 832	430WGTZ		
			 3151 000 034	KZISZ-5		
			 3189 600 020		Getr. / GBox: ZF Ecosplit-3	
40.362	01.85 -	D2866KF, KU, LXF	 3400 122 201	430 10		
			 3482 083 032	MFZ430		
			 1878 004 832	430WGTZ		
			 3151 000 034	KZISZ-5		
			 3189 600 020		Getr. / GBox: ZF Ecosplit-3	

MAN







40 ...						
40.400 UNL 904			 1878 000 967 ▽	380 10 380GTZ	Lose Kupplungsscheibe / Loose clutch disc	(41)
			 3151 000 395	KZIS-4		
			 1882 280 213	380 GF2/380	In 1888 enthalten / Contained in 1888	(31)
			 1859 212 000	380 GF2/380	In 1888 enthalten / Contained in 1888	(31)
			 1878 000 964 △	380 10 380GTZ	In 1888 enthalten / Contained in 1888	(31)

41 ...						
41.242	01.85 -	D2865LF02, D2866F	 3400 127 601	400 10 MFZ400 400WGVZ KZISZ-5	Nabenprofil / Hub Profile: 2"-10N	(48)
			 3400 700 310	400 10 MFZ400 400WGVZ KZISZ-5	Nabenprofil / Hub Profile: 1 3/4"-10N	(48)
			 3189 600 020		Getr. / GBox: ZF Ecosplit-3	
41.291 513			 1882 342 134	420 GF420X		
			 1861 911 232	420 10 420WGVZ		
			 3151 067 032	KZI4,5		
41.331 513 41.361 513			 1800 125 501 #	420 10 GF420X 420WGVZ KZI4,5		
41.462 41.502	01.85 -	D2840	 1882 017 131	420 GF420XN	Nebenantriebs-ID / PTO ID: 130E	(50)
	01.85 -		 1878 086 941	420 10 420WGTZ	Nebenantriebs-ID / PTO ID: 130E	(50)

47 ...						
47.292	01.89 -	D2866KF, D2866LF	 1882 017 131	420 GF420XN	Nebenantriebs-ID / PTO ID: 130E	(50)
47.332	01.89 -		 1878 086 941	420 10 420WGTZ	Nebenantriebs-ID / PTO ID: 130E	(50)
47.362	01.89 -					



























48 ...						
48.291 513 48.331 513 48.361 513			 1800 125 501 #	420 10 GF420X 420WGVZ KZI4,5		
48.372 48.402 48.422	01.89 -	D2866LF	 1882 017 131	420 GF420XN	Nebenantriebs-ID / PTO ID: 130E	(50)
	01.89 -		 1878 086 941	420 10 420WGTZ	Nebenantriebs-ID / PTO ID: 130E	(50)
	01.89 -					

MAZ



MAZ						
4370		DeutzBF4M101 3FC	 3482 125 512	362 MF362	Getr. / GBox: ZF S5-42	
			 1878 079 331	362 10 362WGTZ	Getr. / GBox: ZF S5-42	
			 3151 000 958	KZIS-4	Getr. / GBox: ZF S5-42	
			 3151 068 101	KZI-3	Getr. / GBox: ZF S5-42	
		Minski	 3482 125 512	362 MF362	Getr. / GBox: Smolensk	
			 1878 079 331	362 10 362WGTZ	Getr. / GBox: Smolensk	
			 3151 000 079	KZI-3	Getr. / GBox: Smolensk	

		CODE				
--	--	------	--	---	---	---



MAZ

MAZ						
4570		MMZ245.9	 3482 125 512	362 MF362	Getr. / GBox: Smolensk CAAZ-433420	
			 1878 079 306	362 10 362WGTZ	Getr. / GBox: Smolensk CAAZ-433420	
			 3151 202 001	KZI-4,5	Getr. / GBox: Smolensk CAAZ-433420	
5336		DeutzBF6M101 3FC	 3482 000 463	395 MF395	Getr. / GBox: ZF 9S 109 Getr. / GBox: ZF 9S - 75	
			 1862 506 131	395 10 395WGTZ	Getr. / GBox: ZF 9S 109 Getr. / GBox: ZF 9S - 75	
			 3151 000 419	KZIS-4	Getr. / GBox: ZF 9S 109 Getr. / GBox: ZF 9S - 75	
5337		DeutzBF4M101 3FC	 3482 000 463	395 MF395	Getr. / GBox: ZF 6S-850	
			 1862 506 131	395 10 395WGTZ	Getr. / GBox: ZF 6S-850	
			 3151 000 419	KZIS-4	Getr. / GBox: ZF 6S-850	
5516		DeutzBF6M101 3FC	 3482 000 463	395 MF395	Getr. / GBox: ZF 9S 109 Getr. / GBox: ZF 16S 109	
			 1862 506 131	395 10 395WGTZ	Getr. / GBox: ZF 9S 109 Getr. / GBox: ZF 16S 109	
			 3151 000 419	KZIS-4	Getr. / GBox: ZF 9S 109 Getr. / GBox: ZF 16S 109	
		DeutzBF6M101 5C	 3482 083 032	430 MFZ430	Getr. / GBox: ZF 16 S 221	
			 1878 004 832	430 10 430WGTZ	Getr. / GBox: ZF 16 S 221	
			 3151 000 034	KZISZ-5	Getr. / GBox: ZF 16 S 221	
5551		DeutzBF6M101 3EC	 3482 083 118	430 MFZ430	Getr. / GBox: ZF 9S 109	
			 1878 080 031	430 10 430WGTZ	Getr. / GBox: ZF 9S 109	
			 3151 000 157	KZISZ-5	Getr. / GBox: ZF 9S 109	
		DeutzBF6M101 3FC	 3482 000 463	395 MF395	Getr. / GBox: ZF 9S 109 Getr. / GBox: ZF 9S - 75	
			 1862 506 131	395 10 395WGTZ	Getr. / GBox: ZF 9S 109 Getr. / GBox: ZF 9S - 75	
			 3151 000 419	KZIS-4	Getr. / GBox: ZF 9S 109 Getr. / GBox: ZF 9S - 75	
6303		DeutzBF6M101 3FC	 3482 000 463	395 MF395	Getr. / GBox: ZF 9S 109 Getr. / GBox: ZF 16S 109	
			 1862 506 131	395 10 395WGTZ	Getr. / GBox: ZF 9S 109 Getr. / GBox: ZF 16S 109	
			 3151 000 419	KZIS-4	Getr. / GBox: ZF 9S 109 Getr. / GBox: ZF 16S 109	
631733		DeutzBF6M101 3FC	 3482 000 463	395 MF395	Getr. / GBox: ZF 9S 109	
			 1862 506 131	395 10 395WGTZ	Getr. / GBox: ZF 9S 109	
			 3151 202 001	KZI-4,5	Getr. / GBox: ZF 9S 109	

MAZ Baltija



MAZ Baltija		DeutzBF6M101 3FC	 3482 000 463	395 MF395	Getr. / GBox: ZF 9S-109	
			 1862 506 131	395 10 395WGTZ	Getr. / GBox: ZF 9S-109	
			 3151 000 958	KZIS-4	Getr. / GBox: ZF 9S-109	

Truck









631208 / 643008		YAMZ7511	 3482 083 032	430 MFZ430	Getr. / GBox: Shaanxi 9JS 180 A	
			 1878 004 832	430 10 430WGTZ	Getr. / GBox: Shaanxi 9JS 180 A	
			 3151 000 034	KZISZ-5	Getr. / GBox: Shaanxi 9JS 180 A	

		CODE				
--	--	------	--	---	---	---







MAZ













Truck							
544005 / 534005		YAMZ238DE		3482 083 118	430 MFZ430	Getr. / GBox: Shaanxi 9JS 150 F	
				1878 004 832	430 10 430WGTZ	Getr. / GBox: Shaanxi 9JS 150 F	
				3151 000 034	KZISZ-5	Getr. / GBox: Shaanxi 9JS 150 F	









MAZ-MAN

F 2000							
19.410	10.98-	D2876LF06, D2866LF25, D2866LF31		3400 127 401	430 10 MFZ430 430WGTZ KZISZ-5		
26.410	10.98-			3482 000 361	430 10 MFZ430 430WGTZ KZISZ-5	Getr. / GBox: AS-Tronic für Ausrückgabel mit Nocken / for release fork with cams	(70)
26.410	10.98-			1878 004 832			
26.460	10.98-			3151 000 034			
44.410	10.98-			3400 700 403	430 10 MFZ430 430WGTZ KZISZ-5	Getr. / GBox: AS-Tronic für Ausrückgabel mit Rollen / for release fork with rollers	(71)
			3482 000 361	430 10 MFZ430 430WGTZ KZISZ-5	Getr. / GBox: ZF AS Tronic Rollenausführung / roller version	(58)	
			1878 004 832				
				3151 000 493			
				3189 600 004		Getr. / GBox: ZF Ecosplit-3	
				3189 600 020			

MERCEDES-BENZ







100 Kasten / Box (631) 02.88 - 04.96							
D (631.332, 631.342), 53 kW D (631.332, 631.342), 55 kW	02.88 - 05.92	OM616.963		3000 424 002	228 23 M228 228LPB KZIS-0		
	12.90 - 02.96			3082 191 032	228 23 M228 228LPB KZIS-0	-> 10.1991 Hüllenlänge [mm] / Sleeve Length [mm]: 980 Länge [mm] / Length [mm]: 1450	(29) (45)
				1862 375 031			
				3151 198 031			
				3074 600 205			
				6283 600 113		Chass. 099541->	
				6284 600 111		01.1991->	















100 Pritsche / Flatbed (631) 02.88 - 02.96							
D (631.340), 53 kW	02.88 - 05.92	OM616.963		3000 424 002	228 23 M228 228LPB KZIS-0		
				3082 191 032	228 23 M228 228LPB KZIS-0	Hüllenlänge [mm] / Sleeve Length [mm]: 980 Länge [mm] / Length [mm]: 1450	(29) (45)
				1862 375 031			
				3151 198 031			
				3074 600 205		01.1991->	
				6284 600 111			
D (631.340), 55 kW	12.90 - 02.96	OM616.963		3000 424 002	228 23 M228 228LPB KZIS-0		
				3082 191 032	228 23 M228 228LPB KZIS-0	Hüllenlänge [mm] / Sleeve Length [mm]: 980 Länge [mm] / Length [mm]: 1450	(29) (45)
				1862 375 031			
				3151 198 031			
				3074 600 205		01.1991->	
				6284 600 111			







CITAN Kasten (415) 11.12 -							
112 (415.603)	06.13 -	M200.711		3182 654 169		Immer erneuern / Renew everytime	(30)
				6284 600 666 <small>LHD</small>			
108 CDI (415.601, 415.603) 109 CDI (415.601, 415.603, 415.605)	11.12 - 11.12 -	OM607.951		3000 951 128 	215 26 M215 215VTPB		
				3082 600 568	215 26 M215 215VTPB	Durchmesser Druckleitungsanschluss [mm] / Pressure hose connector diameter [mm]: 12,2	(14)
				1878 007 204			
				3182 654 204		Durchmesser Druckleitungsanschluss [mm] / Pressure hose connector diameter [mm]: 12,2 Immer erneuern / Renew everytime	(30)
				6284 600 694 <small>LHD</small>			

		CODE				
--	--	------	--	---	---	---

MERCEDES-BENZ















































CITAN Kasten (415)		11.12 -				
111 CDI (415.603, 415.605)	06.13-	OM607.951	 3000 951 128   3082 600 568  1878 007 204	215 26 M215 215VTPB		
			 3182 654 169		Immer erneuern / Renew everytime	(30)
			 6284 600 666 			

MB / MBO					
MB 500 (684.040)	M384.906	 3482 046 031 #	280 MF280		
		 1861 919 134	280 10 280GTZ		
		 3151 000 020	KZI-3		
MB 700 (684.043) MBO 700 (684.047/48) MBO 800 / 38 (684.448)	M384.907	 3482 008 038	310 MF310		
		 1861 303 248	310 10 310GSB		
		 3151 000 020	KZI-3		
MB 800 T (397.243)	M384.900	 3482 008 038	310 MF310		
		 1878 026 431	310 10 310WTB		
		 3151 000 020	KZI-3		
MB 800 T/35 (371.043)	M380.940, M380.942, M380.943	 3482 008 038	310 MF310		
		 1878 026 431	310 10 310WTB		
		 3151 000 020	KZI-3	Chass. KAL 34/98->	
MB 800 / 32 (684.093) MB 800 / 32ATL (684.083) MB 800 / 38 (684.088) MB 800 / 38 (684.091/098/444) MBO 800 / 38 (684.449) MB 800 / 38ATL (684.081)	M384.907, M384.908	 3482 008 038	310 MF310		
		 1878 026 431	310 10 310WTB		
		 3151 000 020	KZI-3		

SPRINTER 2-t Kasten / Box (901, 902) 01.95 - 05.06						
214 NGT	04.00 - 05.06	M111.984	 3000 990 218 	240 26	->Chass. A920787 ->Chass. R636764 Nabenprofil / Hub Profile: 26,5x29-26N für Schwungradtiefe [mm] / for flywheel depth [mm]: 8	(48) (84)
			 3000 990 252 	240 26	Nabenprofil / Hub Profile: 26,5x29-26N für Schwungradtiefe [mm] / for flywheel depth [mm]: 12 Nur zusammen verbauen / Only install together	(48) (84) (53)
			 3182 654 192 	HHAS-1	Immer erneuern / Renew everytime	(30)
			 3182 997 802	HHAS-1	Schaltgetriebe sequentiell / Sequential Manual Transmission mit Sensor / with sensor Füllmedium: Mineralöl / Fill Medium: Mineral Oil Immer erneuern / Renew everytime	(59) (92) (26) (30)



































MERCEDES-BENZ

SPRINTER 2-t Kasten / Box (901, 902) 01.95 - 05.06

214	02.95 - 05.06	M111.979	 3000 826 901  3082 268 031  1878 994 001  3151 248 031	240 26 M240 240TB KZIS-0					
			 1863 869 010	35	Kugellager / Ball Bearing	(38)			
			M111.984	 3000 990 218  	240 26	->Chass. A920787 ->Chass. R636764 Nabenprofil / Hub Profile: 26,5x29-26N für Schwungradtiefe [mm] / for flywheel depth [mm]: 8	(48) (84)		
				 3000 990 252  	240 26	Nabenprofil / Hub Profile: 26,5x29-26N für Schwungradtiefe [mm] / for flywheel depth [mm]: 12 Nur zusammen verbauen / Only install together	(48) (84) (53)		
				 3182 654 192 	HHAS-1	Immer erneuern / Renew everytime	(30)		
		M111.979, M111.984	 3182 997 802	HHAS-1	Schaltgetriebe sequentiell / Sequential Manual Transmission mit Sensor / with sensor Füllmedium: Mineralöl / Fill Medium: Mineral Oil Immer erneuern / Renew everytime	(59) (92) (26) (30)			
			 6283 600 115						
			 6284 600 573						
			208 CDI 211 CDI 213 CDI 216 CDI	04.00 - 05.06 04.00 - 05.06 04.00 - 05.06 04.00 - 05.06	OM611.981/987, OM612.981	 2290 601 011  	240 26	ZMS Modul XTend plus CSC Montageart: nicht vormontiert / Mounting Type: not pre-mounted Beinhaltet ZMS, Kupplungsdruckplatte, Kupplungsscheibe und CSC / Contains twin-mass flywheel, clutch cover assembly, clutch disc and CSC enthält Schwungradbefestigungsschrauben / includes bolt for flywheel mounting	(46) (11) (66)
						 3000 990 218  	240 26	->Chass. A920787 ->Chass. R636764 Nabenprofil / Hub Profile: 26,5x29-26N für Schwungradtiefe [mm] / for flywheel depth [mm]: 8	(48) (84)
 3000 990 252  	240 26	Nabenprofil / Hub Profile: 26,5x29-26N für Schwungradtiefe [mm] / for flywheel depth [mm]: 12 Nur zusammen verbauen / Only install together				(48) (84) (53)			
 3182 997 802	HHAS-1	Schaltgetriebe sequentiell / Sequential Manual Transmission mit Sensor / with sensor Füllmedium: Mineralöl / Fill Medium: Mineral Oil Immer erneuern / Renew everytime				(59) (92) (26) (30)			
 1863 869 012	28	Nadellager / Needle Bearing				(49)			
OM612.981, OM611.981, OM611.987	 6284 600 573								
208 D, 58 kW 208 D, 60 kW	02.95 - 04.00 10.96 - 04.00	OM601.943			 2290 601 007  2294 000 767  3082 267 233  1864 503 231  3151 248 031	228 26 M228X 228B KZIS-0	ZMS Modul Montageart: nicht vormontiert / Mounting Type: not pre-mounted Beinhaltet ZMS, Kupplungsdruckplatte, Kupplungsscheibe und Ausrücker / Contains twin-mass flywheel, clutch cover assembly, clutch disc and releaser enthält Schwungradbefestigungsschrauben / includes bolt for flywheel mounting	(46) (10) (66)	
					 1863 869 010	35	Kugellager / Ball Bearing	(38)	
					 6283 600 115				
210 D 212 D	01.97 - 04.00 02.95 - 04.00	OM602LA			 3000 951 785  3082 269 031  1878 600 501  3151 248 031	250 26 M250 250CD KZIS-0			
			 3000 725 001 ●  3082 269 031  1864 504 031  3151 248 031	250 26 M250 250B KZIS-0					
			 2294 000 525	250	enthält Schwungradbefestigungsschrauben / includes bolt for flywheel mounting	(66)			
		OM602.980	 1863 869 010	35	Kugellager / Ball Bearing	(38)			
		 6283 600 115							



















		CODE				
--	--	------	--	---	---	---

MERCEDES-BENZ























SPRINTER 2-t Pritsche / Flatbed (901, 902) 01.95 - 05.06						
214 NGT	04.00 - 05.06	M111.984		3000 990 218 	240 26	->Chass. A920787 ->Chass. R636764 Nabenprofil / Hub Profile: 26,5x29-26N für Schwungradtiefe [mm] / for flywheel depth [mm]: 8 (48)
				3000 990 252 	240 26	Nabenprofil / Hub Profile: 26,5x29-26N für Schwungradtiefe [mm] / for flywheel depth [mm]: 12 (84) Nur zusammen verbauen / Only install together (53)
				3182 654 192 	HHAS-1	Immer erneuern / Renew everytime (30)
				3182 997 802	HHAS-1	Schaltgetriebe sequentiell / Sequential Manual Transmission mit Sensor / with sensor (92) Füllmedium: Mineralöl / Fill Medium: Mineral Oil (26) Immer erneuern / Renew everytime (30)
214	02.95 - 05.06	M111.979		3000 826 901  3082 268 031  1878 994 001  3151 248 031	240 26 M240 240TB KZIS-0	
				1863 869 010	35	Kugellager / Ball Bearing (38)
				6283 600 115		
				6284 600 573		
		M111.984		3000 990 218 	240 26	->Chass. A920787 ->Chass. R636764 Nabenprofil / Hub Profile: 26,5x29-26N für Schwungradtiefe [mm] / for flywheel depth [mm]: 8 (48)
				3000 990 252 	240 26	Nabenprofil / Hub Profile: 26,5x29-26N für Schwungradtiefe [mm] / for flywheel depth [mm]: 12 (84) Nur zusammen verbauen / Only install together (53)
				3182 654 192 	HHAS-1	Immer erneuern / Renew everytime (30)
				3182 997 802	HHAS-1	Schaltgetriebe sequentiell / Sequential Manual Transmission mit Sensor / with sensor (92) Füllmedium: Mineralöl / Fill Medium: Mineral Oil (26) Immer erneuern / Renew everytime (30)
208 CDI 211 CDI 213 CDI 216 CDI	04.00 - 05.06	OM611.981/987, OM612.981		2290 601 011 	240 26	ZMS Modul XTend plus CSC Montageart: nicht vormontiert / Mounting Type: not pre-mounted (46) Beinhaltet ZMS, Kupplungsdruckplatte, Kupplungsscheibe und CSC / Contains twin-mass flywheel, clutch cover assembly, clutch disc and CSC enthält Schwungradbefestigungsschrauben / includes bolt for flywheel mounting (66)
				3000 990 218 	240 26	->Chass. A920787 ->Chass. R636764 Nabenprofil / Hub Profile: 26,5x29-26N für Schwungradtiefe [mm] / for flywheel depth [mm]: 8 (48)
				3000 990 252 	240 26	Nabenprofil / Hub Profile: 26,5x29-26N für Schwungradtiefe [mm] / for flywheel depth [mm]: 12 (84) Nur zusammen verbauen / Only install together (53)
		OM612.981, OM611.981, OM611.987		3182 997 802	HHAS-1	Schaltgetriebe sequentiell / Sequential Manual Transmission mit Sensor / with sensor (92) Füllmedium: Mineralöl / Fill Medium: Mineral Oil (26) Immer erneuern / Renew everytime (30)
				1863 869 012	28	Nadellager / Needle Bearing (49)
				6284 600 573		
			208 D, 58 kW	01.95 - 04.00	OM601.943	
	2294 000 767	240				enthält Schwungradbefestigungsschrauben / includes bolt for flywheel mounting (66)
	1863 869 010	35				Kugellager / Ball Bearing (38)
	6283 600 115					02.1995->

MERCEDES-BENZ

SPRINTER 2-t Pritsche / Flatbed (901, 902) 01.95 - 05.06

208 D, 60 kW	09.96 - 04.00	OM601.943	 2290 601 007  2294 000 767  3082 267 233  1864 503 231  3151 248 031	228 26 M228X 228B KZIS-0	ZMS Modul Montageart: nicht vormontiert / Mounting Type: not pre-mounted Beinhaltet ZMS, Kupplungsdruckplatte, Kupplungsscheibe und Ausrücker / Contains twin-mass flywheel, clutch cover assembly, clutch disc and releaser enthält Schwungradbefestigungsschrauben / includes bolt for flywheel mounting	(46) (10) (66)			
			 1863 869 010				35	Kugellager / Ball Bearing	(38)
			 6283 600 115						
210 D 212 D	01.97 - 04.00 02.95 - 04.00	OM602LA	 3000 951 785  3082 269 031  1878 600 501  3151 248 031	250 26 M250 250CD KZIS-0					
			 3000 725 001 ●  3082 269 031  1864 504 031  3151 248 031				250 26 M250 250B KZIS-0		
			 2294 000 525						
		OM602.980	 1863 869 010	35	Kugellager / Ball Bearing	(38)			
		 6283 600 115							











SPRINTER 3-t Kasten / Box (903) 01.95 - 05.06

314 NGT (903.661) 314 314 4x4	04.00 - 05.06 02.95 - 05.06 08.02 - 05.06	M111.979	 3000 826 901  3082 268 031  1878 994 001  3151 248 031	240 26 M240 240TB KZIS-0																	
			 1863 869 010				35	Kugellager / Ball Bearing	(38)												
		M111.984	 3000 990 218 	240 26	->Chass. A920787 ->Chass. R636764 Nabenprofil / Hub Profile: 26,5x29-26N für Schwungradtiefe [mm] / for flywheel depth [mm]: 8	(48) (84)															
			 3000 990 252 				240 26	Nabenprofil / Hub Profile: 26,5x29-26N für Schwungradtiefe [mm] / for flywheel depth [mm]: 12 Nur zusammen verbauen / Only install together	(48) (84) (53)												
			 3182 654 192 							HHAS-1	Immer erneuern / Renew everytime	(30)									
			 3182 997 802										HHAS-1	Schaltgetriebe sequentiell / Sequential Manual Transmission mit Sensor / with sensor Füllmedium: Mineralöl / Fill Medium: Mineral Oil Immer erneuern / Renew everytime	(59) (92) (26) (30)						
			M111.979, M111.984													 6283 600 115					
		 6284 600 573																			
		308 CDI 311 CDI 311 CDI 4x4 313 CDI 313 CDI 4x4 316 CDI 316 CDI 4x4	04.00 - 05.06 04.00 - 05.06 08.02 - 05.06 04.00 - 05.06 08.02 - 05.06 04.00 - 05.06 08.02 - 05.06	OM611.981/987, OM612.981	 2290 601 011 	240 26	ZMS Modul XTend plus CSC Montageart: nicht vormontiert / Mounting Type: not pre-mounted Beinhaltet ZMS, Kupplungsdruckplatte, Kupplungsscheibe und CSC / Contains twin-mass flywheel, clutch cover assembly, clutch disc and CSC enthält Schwungradbefestigungsschrauben / includes bolt for flywheel mounting	(46) (11) (66)													
					 3000 990 218 				240 26	->Chass. A920787 ->Chass. R636764 Nabenprofil / Hub Profile: 26,5x29-26N für Schwungradtiefe [mm] / for flywheel depth [mm]: 8	(48) (84)										
 3000 990 252 	240 26				Nabenprofil / Hub Profile: 26,5x29-26N für Schwungradtiefe [mm] / for flywheel depth [mm]: 12 Nur zusammen verbauen / Only install together							(48) (84) (53)									
 3182 997 802													HHAS-1	Schaltgetriebe sequentiell / Sequential Manual Transmission mit Sensor / with sensor Füllmedium: Mineralöl / Fill Medium: Mineral Oil Immer erneuern / Renew everytime	(59) (92) (26) (30)						
 1863 869 012																28	Nadellager / Needle Bearing	(49)			
OM612.981, OM611.981, OM611.987																			 6284 600 573		













		CODE				
--	--	------	--	---	---	---

MERCEDES-BENZ





























SPRINTER 3-t Kasten / Box (903) 01.95 - 05.06

308 D 2.3, 58 kW 308 D 2.3, 60 kW	02.95 - 04.00 02.95 - 04.00	OM601.943		2290 601 007 ⊕ 2294 000 767 ⊕ 3082 267 233 ⊕ 1864 503 231 ⊕ 3151 248 031	228 26 M228X 228B KZIS-0	ZMS Modul Montageart: nicht vormontiert / Mounting Type: not pre-mounted Beinhaltet ZMS, Kupplungsdruckplatte, Kupplungsscheibe und Ausrücker / Contains twin-mass flywheel, clutch cover assembly, clutch disc and releaser enthält Schwungradbefestigungsschrauben / includes bolt for flywheel mounting Kugellager / Ball Bearing	(46)
				1863 869 010	35		(38)
				6283 600 115			
				3000 951 785 ⊕ 3082 269 031 ⊕ 1878 600 501 ⊕ 3151 248 031	250 26 M250 250CD KZIS-0		
310 D 2.9 312 D 2.9	02.95 - 04.00 02.95 - 04.00	OM602LA		3000 725 001 ● ⊕ 3082 269 031 ⊕ 1864 504 031 ⊕ 3151 248 031	250 26 M250 250B KZIS-0		
				2294 000 525	250	enthält Schwungradbefestigungsschrauben / includes bolt for flywheel mounting	(66)
				1863 869 010	35	Kugellager / Ball Bearing	(38)
				6283 600 115			
312 D 2.9 4x4	05.97 - 08.02	OM602.980		2294 000 525	250	enthält Schwungradbefestigungsschrauben / includes bolt for flywheel mounting	(66)
				6283 600 115			

SPRINTER 3-t Pritsche / Flatbed (903) 01.95 - 05.06













































314 NGT (903.611, 903.612)	04.00 - 05.06	M111.984		6283 600 115			
				6284 600 573			
314 314 4x4	02.95 - 05.06 08.02 - 05.06	M111.979		3000 826 901 ⊕ 3082 268 031 ⊕ 1878 994 001 ⊕ 3151 248 031	240 26 M240 240TB KZIS-0		
				1863 869 010	35	Kugellager / Ball Bearing	(38)
				3000 990 218 	240 26	->Chass. A920787 ->Chass. R636764 Nabenprofil / Hub Profile: 26,5x29-26N für Schwungradtiefe [mm] / for flywheel depth [mm]: 8	(48) (84)
			3000 990 252 	240 26	Nabenprofil / Hub Profile: 26,5x29-26N für Schwungradtiefe [mm] / for flywheel depth [mm]: 12 Nur zusammen verbauen / Only install together	(48) (84) (53)	
			3182 654 192 	HHAS-1	Immer erneuern / Renew everytime	(30)	
			3182 997 802	HHAS-1	Schaltgetriebe sequentiell / Sequential Manual Transmission mit Sensor / with sensor Füllmedium: Mineralöl / Fill Medium: Mineral Oil Immer erneuern / Renew everytime	(59) (92) (26) (30)	
			6283 600 115				
			6284 600 573				

MERCEDES-BENZ

SPRINTER 3-t Pritsche / Flatbed (903) 01.95 - 05.06						
308 CDI 311 CDI 311 CDI 4x4 313 CDI 313 CDI 4x4 316 CDI 316 CDI 4x4	04.00 - 05.06	OM611.981/987, OM612.981 OM612.981, OM611.981, OM611.987		2290 601 011 	240 26	ZMS Modul XTend plus CSC Montageart: nicht vormontiert / Mounting Type: not pre-mounted (46) Beinhaltet ZMS, Kupplungsdruckplatte, Kupplungsscheibe und CSC / Contains twin-mass flywheel, clutch cover assembly, clutch disc and CSC (11) enthält Schwungradbefestigungsschrauben / includes bolt for flyweel mounting (66)
	04.00 - 05.06			3000 990 218 	240 26	->Chass. A920787 ->Chass. R636764 Nabenprofil / Hub Profile: 26,5x29-26N für Schwungradtiefe [mm] / for flywheel depth [mm]: 8 (48)
	08.02 - 05.06			3000 990 252 	240 26	Nabenprofil / Hub Profile: 26,5x29-26N für Schwungradtiefe [mm] / for flywheel depth [mm]: 12 (48) Nur zusammen verbauen / Only install together (53)
	04.00 - 05.06			3182 654 192 	HHAS-1	Immer erneuern / Renew everytime (30)
	08.02 - 05.06			3182 997 802	HHAS-1	Schaltgetriebe sequentiell / Sequential Manual Transmission (59) mit Sensor / with sensor (92) Füllmedium: Mineralöl / Fill Medium: Mineral Oil (26) Immer erneuern / Renew everytime (30)
				1863 869 012	28	Nadellager / Needle Bearing (49)
				6284 600 573		
308 D 2.3, 58 kW 308 D 2.3, 60 kW	02.95 - 04.00	OM601.943		2290 601 007  2294 000 767  3082 267 233  1864 503 231  3151 248 031	228 26 M228X 228B KZIS-0	ZMS Modul Montageart: nicht vormontiert / Mounting Type: not pre-mounted (46) Beinhaltet ZMS, Kupplungsdruckplatte, Kupplungsscheibe und Ausrücker / Contains twin-mass flywheel, clutch cover assembly, clutch disc and releaser (10) enthält Schwungradbefestigungsschrauben / includes bolt for flyweel mounting (66)
	11.96 - 04.00			1863 869 010	35	Kugellager / Ball Bearing (38)
				6283 600 115		
310 D 2.9 312 D 2.9	01.97 - 04.00	OM602LA		3000 951 785  3082 269 031  1878 600 501  3151 248 031	250 26 M250 250CD KZIS-0	
	02.95 - 04.00			3000 725 001 ●  3082 269 031  1864 504 031  3151 248 031	250 26 M250 250B KZIS-0	
				2294 000 525	250	enthält Schwungradbefestigungsschrauben / includes bolt for flyweel mounting (66)
			OM602.980	1863 869 010	35	Kugellager / Ball Bearing (38)
				6283 600 115		

		CODE				
--	--	------	--	---	---	---











MERCEDES-BENZ

SPRINTER 4-t Kasten / Box (904) 02.96 - 05.06						
414 414 4x4	02.96 - 05.06 05.97 - 05.06	M111.979	 3000 826 901	240 26		
			 3082 268 031	M240		
			 1878 994 001	240TB		
			 3151 248 031	KZIS-0		
			 3000 951 785	250 26	für / for: SA 504097/03	(69)
	 3082 269 031	M250	für / for: SA 504096/03	(69)		
	 1878 600 501	250CD	für Motoren ohne Zweimassenschwungrad / for engines without dual-mass flywheel	(81)		
	 3151 248 031	KZIS-0				
	 1863 869 010	35	Kugellager / Ball Bearing	(38)		
	 6283 600 115					
 6284 600 573						
408 CDI 411 CDI 411 CDI 4x4 413 CDI 413 CDI 4x4 416 CDI 416 CDI 4x4	04.00 - 05.06 04.00 - 05.06 04.00 - 05.06 04.00 - 05.06 04.00 - 05.06 04.00 - 05.06	OM611.981/987, OM612.981	 2290 601 011 	240 26	->Chass. A920787 ->Chass. R636764 Nabenprofil / Hub Profile: 26,5x29-26N für Schwungradtiefe [mm] / for flywheel depth [mm]: 8	(48) (84)
			 3000 990 252 	240 26	Nabenprofil / Hub Profile: 26,5x29-26N für Schwungradtiefe [mm] / for flywheel depth [mm]: 12	(48) (84)
			 3182 654 192 	HHAS-1	Nur zusammen verbauen / Only install together	(53)
			 3182 997 802	HHAS-1	Immer erneuern / Renew everytime	(30)
			 3182 997 802	HHAS-1	Schaltgetriebe sequentiell / Sequential Manual Transmission mit Sensor / with sensor Füllmedium: Mineralöl / Fill Medium: Mineral Oil Immer erneuern / Renew everytime	(59) (92) (26) (30)
		 3000 990 218 	240 26	->Chass. A920787 ->Chass. R636764 Nabenprofil / Hub Profile: 26,5x29-26N für Schwungradtiefe [mm] / for flywheel depth [mm]: 8	(48) (84)	
		 3000 990 252 	240 26	Nabenprofil / Hub Profile: 26,5x29-26N für Schwungradtiefe [mm] / for flywheel depth [mm]: 12	(48) (84)	
		 3182 997 802	HHAS-1	Nur zusammen verbauen / Only install together	(53)	
		 3182 997 802	HHAS-1	Schaltgetriebe sequentiell / Sequential Manual Transmission mit Sensor / with sensor Füllmedium: Mineralöl / Fill Medium: Mineral Oil Immer erneuern / Renew everytime	(59) (92) (26) (30)	
		 3182 654 192 	HHAS-1	Immer erneuern / Renew everytime	(30)	
 1863 869 012	28	Nadellager / Needle Bearing	(49)			
 6284 600 573						
408 D	02.96 - 05.06	OM601.943	 2290 601 007	228 26	ZMS Modul Montageart: nicht vormontiert / Mounting Type: not pre-mounted Beinhaltet ZMS, Kupplungsdruckplatte, Kupplungsscheibe und Ausrücker / Contains twin-mass flywheel, clutch cover assembly, clutch disc and releaser enthält Schwungradbefestigungsschrauben / includes bolt for flywheel mounting	(46) (10) (66)
			 2294 000 767	M228X		
			 3082 267 233	228B		
			 1864 503 231	KZIS-0		
			 3151 248 031			
			 3000 726 001	228 26		
			 3082 267 233	M228X		
 1864 503 231	228B					
 3151 248 031	KZIS-0					
 3000 951 785	250 26	für / for: SA 504097/03	(69)			
 3082 269 031	M250	für / for: SA 504096/03	(69)			
 1878 600 501	250CD					
 3151 248 031	KZIS-0					
 1863 869 010	35	Kugellager / Ball Bearing	(38)			
 6283 600 115						













		CODE				
--	--	------	--	---	---	---

MERCEDES-BENZ

SPRINTER 4-t Kasten / Box (904) 02.96 - 05.06

410 D 410 D 4x4 412 D, 85 kW 412 D 4x4, 85 kW	02.96 - 05.06	OM602LA		3000 951 785 ⊗ 3082 269 031 ⊗ 1878 600 501 ⊙ 3151 248 031	250 26 M250 250CD KZIS-0		
	05.97 - 05.06			3000 725 001 ● ⊗ 3082 269 031 ⊗ 1864 504 031 ⊙ 3151 248 031	250 26 M250 250B KZIS-0		
	02.96 - 05.06			2294 000 525	250	enthält Schwungradbefestigungsschrauben / includes bolt for flywheel mounting	(66)
	05.97 - 05.06		OM602.980		1863 869 010	35	Kugellager / Ball Bearing
				6283 600 115			
412 D, 90 kW 412 D 4x4, 90 kW	02.96 - 05.06	OM602LA		3000 951 785 ⊗ 3082 269 031 ⊗ 1878 600 501 ⊙ 3151 248 031	250 26 M250 250CD KZIS-0		
	05.97 - 05.06			3000 725 001 ● ⊗ 3082 269 031 ⊗ 1864 504 031 ⊙ 3151 248 031	250 26 M250 250B KZIS-0		
				2294 000 525	250	enthält Schwungradbefestigungsschrauben / includes bolt for flywheel mounting	(66)
			OM602.980		1863 869 010	35	Kugellager / Ball Bearing
				6283 600 115			































SPRINTER 4-t Pritsche / Flatbed (904) 02.96 - 05.06

414 414 4x4	02.96 - 05.06	M111.979		3000 826 901 ⊗ 3082 268 031 ⊗ 1878 994 001 ⊙ 3151 248 031	240 26 M240 240TB KZIS-0		
	05.97 - 05.06			3000 951 785 ⊗ 3082 269 031 ⊗ 1878 600 501 ⊙ 3151 248 031	250 26 M250 250CD KZIS-0	für / for: SA 504097/03 für / for: SA 504096/03 für Motoren ohne Zweimassenschwungrad / for engines without dual-mass flywheel	(69) (69) (81)
				1863 869 010	35	Kugellager / Ball Bearing	(38)
			M111.984		3000 990 218 	240 26	->Chass. A920787 ->Chass. R636764 Nabenprofil / Hub Profile: 26,5x29-26N für Schwungradtiefe [mm] / for flywheel depth [mm]: 8
				3000 990 252 	240 26	Nabenprofil / Hub Profile: 26,5x29-26N für Schwungradtiefe [mm] / for flywheel depth [mm]: 12 Nur zusammen verbauen / Only install together	(48) (84) (53)
				3182 654 192 	HHAS-1	Immer erneuern / Renew everytime	(30)
				3182 997 802	HHAS-1	Schaltgetriebe sequentiell / Sequential Manual Transmission mit Sensor / with sensor Füllmedium: Mineralöl / Fill Medium: Mineral Oil Immer erneuern / Renew everytime	(59) (92) (26) (30)
		M111.979, M111.984		6283 600 115			
				6284 600 573			









		CODE				
--	--	------	--	---	---	---

MERCEDES-BENZ

SPRINTER 4-t Pritsche / Flatbed (904) 02.96 - 05.06













408 CDI 411 CDI 411 CDI 4x4 413 CDI 413 CDI 4x4 416 CDI 416 CDI 4x4	04.00 - 05.06	OM611.981/987, OM612.981		2290 601 011 	240 26	ZMS Modul XTend plus CSC Montageart: nicht vormontiert / Mounting Type: not pre-mounted Beinhaltet ZMS, Kupplungsdruckplatte, Kupplungsscheibe und CSC / Contains twin-mass flywheel, clutch cover assembly, clutch disc and CSC enthält Schwungradbefestigungsschrauben / includes bolt for flywheel mounting	(46) (11) (66)
	04.00 - 05.06			3000 990 218 	240 26	->Chass. A920787 ->Chass. R636764 Nabenprofil / Hub Profile: 26,5x29-26N für Schwungradtiefe [mm] / for flywheel depth [mm]: 8	(48) (84)
	04.00 - 05.06			3000 990 252 	240 26	Nabenprofil / Hub Profile: 26,5x29-26N für Schwungradtiefe [mm] / for flywheel depth [mm]: 12 Nur zusammen verbauen / Only install together	(48) (84) (53)
	04.00 - 05.06			3182 654 192 	HHAS-1	Immer erneuern / Renew everytime	(30)
	04.00 - 05.06			3182 997 802	HHAS-1	Schaltgetriebe sequentiell / Sequential Manual Transmission mit Sensor / with sensor Füllmedium: Mineralöl / Fill Medium: Mineral Oil Immer erneuern / Renew everytime	(59) (92) (26) (30)
	04.00 - 05.06			1863 869 012	28	Nadellager / Needle Bearing	(49)
	04.00 - 05.06			OM612.981, OM611.981, OM611.987	6284 600 573		
408 D	02.96 - 05.06	OM601.943		3000 951 785  3082 269 031  1878 600 501  3151 248 031	250 26 M250 250CD KZIS-0	für / for: SA 504097/03 für / for: SA 504096/03 für Motoren mit Zweimassenschwungrad / for engines with dual-mass flywheel	(69) (69) (80)
				2294 000 767	240	enthält Schwungradbefestigungsschrauben / includes bolt for flywheel mounting	(66)
				6283 600 115			
				3000 951 785  3082 269 031  1878 600 501  3151 248 031	250 26 M250 250CD KZIS-0		
410 D 410 D 4x4 412 D, 85 kW 412 D 4x4, 85 kW 412 D, 90 kW 412 D 4x4, 90 kW	02.96 - 05.06	OM602LA		3000 725 001 	250 26 M250 250B KZIS-0		
	05.97 - 05.06			 3082 269 031  1864 504 031  3151 248 031	250		
	02.96 - 05.06			2294 000 525	250	enthält Schwungradbefestigungsschrauben / includes bolt for flywheel mounting	(66)
	05.97 - 05.06			1863 869 010	35	Kugellager / Ball Bearing	(38)
	05.97 - 05.06			OM602.980	6283 600 115		































SPRINTER Kipper / Dumptruck (905) 04.01 -

616 CDI (905.612, 905.622, 905.623)	04.01 -	OM612.981		3000 990 252 	240 26	Nabenprofil / Hub Profile: 26,5x29-26N für Schwungradtiefe [mm] / for flywheel depth [mm]: 12 Nur zusammen verbauen / Only install together	(48) (84) (53)
				2290 601 011 	240 26	ZMS Modul XTend plus CSC Montageart: nicht vormontiert / Mounting Type: not pre-mounted Beinhaltet ZMS, Kupplungsdruckplatte, Kupplungsscheibe und CSC / Contains twin-mass flywheel, clutch cover assembly, clutch disc and CSC enthält Schwungradbefestigungsschrauben / includes bolt for flywheel mounting	(46) (11) (66)
				3000 990 218 	240 26	->Chass. R 636764 Nabenprofil / Hub Profile: 26,5x29-26N für Schwungradtiefe [mm] / for flywheel depth [mm]: 8	(48) (84)
				3182 654 192 	HHAS-1	Immer erneuern / Renew everytime	(30)
				1863 869 012	28	Nadellager / Needle Bearing	(49)

		CODE				
--	--	------	--	---	---	---

MERCEDES-BENZ













SPRINTER 5t Pritsche / Flatbed (905) 04.01 - 05.06							
616 CDI (905.612, 905.613, 905.622, 905.623)	04.01 - 05.06	OM612.981		3000 990 252  	240 26	Nabenprofil / Hub Profile: 26,5x29-26N für Schwungradtiefe [mm] / for flywheel depth [mm]: 12 Nur zusammen verbauen / Only install together	(48) (84) (53)
				2290 601 011  	240 26	ZMS Modul XTend plus CSC Montageart: nicht vormontiert / Mounting Type: not pre-mounted Beinhaltet ZMS, Kupplungsdruckplatte, Kupplungsscheibe und CSC / Contains twin-mass flywheel, clutch cover assembly, clutch disc and CSC enthält Schwungradbefestigungsschrauben / includes bolt for flywheel mounting	(46) (11) (66)
				3000 990 218  	240 26	->Chass. R 636764 Nabenprofil / Hub Profile: 26,5x29-26N für Schwungradtiefe [mm] / for flywheel depth [mm]: 8	(48) (84)
				3182 654 192 	HHAS-1	Immer erneuern / Renew everytime	(30)
				1863 869 012	28	Nadellager / Needle Bearing	(49)

SPRINTER 3-t Kasten / Box (906) 06.06 -							
216 (906.613)	09.08 -	M271.951		3000 990 144 	240 26		
				6284 605 004			
209 CDI (906.611, 906.613) 211 CDI (906.611, 906.613) 215 CDI (906.611, 906.613)	06.06 - 12.09	OM646.984, OM646.990, OM646.989, OM646.985		3000 990 144 	240 26		
				6284 605 004			
				2290 601 018  	240 26	ZMS Modul XTend plus CSC Montageart: nicht vormontiert / Mounting Type: not pre-mounted Beinhaltet ZMS, Kupplungsdruckplatte, Kupplungsscheibe und CSC / Contains twin-mass flywheel, clutch cover assembly, clutch disc and CSC enthält Schwungradbefestigungsschrauben / includes bolt for flywheel mounting	(46) (11) (66)
				6284 605 004			
210 CDI (906.611, 906.613)	03.09 -	OM651.955		3000 950 932  	240 26	XTend Nabenprofil / Hub Profile: 26,60x28,89-26N	(48)
				6284 605 004 			
			2294 000 994 	240	enthält Schwungradbefestigungsschrauben / includes bolt for flywheel mounting	(66)	
			2290 601 081 	240 26	ZMS Modul XTend plus CSC Montageart: nicht vormontiert / Mounting Type: not pre-mounted Beinhaltet ZMS, Kupplungsdruckplatte, Kupplungsscheibe und CSC / Contains twin-mass flywheel, clutch cover assembly, clutch disc and CSC enthält Schwungradbefestigungsschrauben / includes bolt for flywheel mounting	(46) (11) (66)	
213 CDI (906.611, 906.613)	06.06 -	OM651.956, OM651.955		3000 990 287  	240		
				2294 000 994 	240	enthält Schwungradbefestigungsschrauben / includes bolt for flywheel mounting	(66)
213 CDI (906.611, 906.613)	06.06 - 12.09	OM646.986		3000 990 144 	240 26		
				6284 605 004			
				2290 601 018  	240 26	ZMS Modul XTend plus CSC Montageart: nicht vormontiert / Mounting Type: not pre-mounted Beinhaltet ZMS, Kupplungsdruckplatte, Kupplungsscheibe und CSC / Contains twin-mass flywheel, clutch cover assembly, clutch disc and CSC enthält Schwungradbefestigungsschrauben / includes bolt for flywheel mounting	(46) (11) (66)
				6284 605 004			





















		CODE				
--	--	------	--	---	---	---

MERCEDES-BENZ





SPRINTER 3-t Kasten / Box (906) 06.06 -

218 CDI (906.611, 906.613) 219 CDI / BlueTEC (906.611, 906.613)	03.09- 06.06 - 12.09 03.09-	OM651.957 OM651 OM642.896, OM642.992		3000 990 287 	240			
				2294 000 994 	240			enthält Schwungradbefestigungsschrauben / includes bolt for flyweel mounting (66)
				6284 605 004 				
				2290 601 081 	240 26	ZMS Modul XTend plus CSC Montageart: nicht vormontiert / Mounting Type: not pre-mounted (46) Beinhaltet ZMS, Kupplungsdruckplatte, Kupplungsscheibe und CSC / Contains twin-mass flywheel, clutch cover assembly, clutch disc and CSC (11) enthält Schwungradbefestigungsschrauben / includes bolt for flyweel mounting (66)		
				3000 990 195 	260 26			
				3000 951 824 3182 654 192	HHAS-1			
				6284 605 004				

SPRINTER 3-t Pritsche / Flatbed (906) 06.06 -

216 (906.113, 906.213)	09.08 - 05.16	M271.951		3000 990 144 	240 26			
				3000 951 188 3182 654 192	HHAS-1			
				6284 605 004				
209 CDI (906.111, 906.113, 906.211, 906.213)	06.06 - 12.09	OM646.984, OM646.990, OM646.989, OM646.986, OM646.985		2290 601 018 	240 26	ZMS Modul XTend plus CSC Montageart: nicht vormontiert / Mounting Type: not pre-mounted (46) enthält Schwungradbefestigungsschrauben / includes bolt for flyweel mounting (66) Beinhaltet ZMS, Kupplungsdruckplatte, Kupplungsscheibe und CSC / Contains twin-mass flywheel, clutch cover assembly, clutch disc and CSC (11)		
211 CDI (906.111, 906.113, 906.211, 906.213)	06.06 - 12.09			3000 951 188 2294 000 835 3182 654 192	HHAS-1			
213 CDI (906.111, 906.113, 906.211, 906.213)	06.06 - 12.09			6284 605 004				
215 CDI (906.111, 906.113, 906.211, 906.213)	06.06 - 12.09							
210 CDI (906.111, 906.113, 906.211, 906.213)	03.09 - 05.16	OM651.956, OM651.957, OM651.955		3000 990 287 	240			
213 CDI (906.111, 906.113, 906.211, 906.213)	03.09 - 05.16			2294 000 994 	240			enthält Schwungradbefestigungsschrauben / includes bolt for flyweel mounting (66)
216 CDI (906.111, 906.113, 906.211, 906.213)	03.09 -			6284 605 004 				
		OM651		2290 601 081 	240 26	ZMS Modul XTend plus CSC Montageart: nicht vormontiert / Mounting Type: not pre-mounted (46) Beinhaltet ZMS, Kupplungsdruckplatte, Kupplungsscheibe und CSC / Contains twin-mass flywheel, clutch cover assembly, clutch disc and CSC (11) enthält Schwungradbefestigungsschrauben / includes bolt for flyweel mounting (66)		
218 CDI (906.111, 906.113, 906.211, 906.213)	06.06 - 12.09	OM642.993, OM642.896, OM642.992		3000 990 195 	260 26			
219 CDI / BlueTEC (906.111, 906.113, 906.211, 906.213)	03.09 - 05.16			3000 951 824 3182 654 192	HHAS-1			
				6284 605 004				





























SPRINTER 3,5-t Kasten / Box (906) 06.06 -

316 (906.635, 906.633)	09.08 -	M271.951		3000 990 144 	240 26			
				3000 951 188 3182 654 192	HHAS-1			
				6284 605 004				
316 NGT (906.633, 906.635)	09.08 -	M271.951		3000 990 144 	240 26			
316 LGT (906.633, 906.635)	09.08 -			3000 951 188 3182 654 192	HHAS-1			









		CODE				
--	--	------	--	---	---	---

MERCEDES-BENZ

SPRINTER 3,5-t Kasten / Box (906) 06.06 -

309 CDI (906.631, 906.633, 906.635, 906.637)	06.06 - 12.09	OM646		3000 990 144 	240 26		
	03.09 -			 3000 951 188  3182 654 192	HHAS-1		
310 CDI (906.631, 906.633, 906.635, 906.637)	06.06 - 12.09			2290 601 018 	240 26	ZMS Modul XTend plus CSC	
				 3000 951 188  2294 000 835  3182 654 192	HHAS-1	Montageart: nicht vormontiert / Mounting Type: not pre-mounted (46) Beinhaltet ZMS, Kupplungsdruckplatte, Kupplungsscheibe und CSC / Contains twin-mass flywheel, clutch cover assembly, clutch disc and CSC (11) enthält Schwungradbefestigungsschrauben / includes bolt for flywheel mounting (66)	
311 CDI (906.631, 906.633, 906.635, 906.637)	06.06 - 12.09						
311 CDI 4x4 (906.631, 906.633, 906.635, 906.637)	02.08 - 12.09						
313 CDI (906.631, 906.633, 906.635, 906.637)	06.06 -						
315 CDI (906.631, 906.633, 906.635, 906.637)	06.06 - 12.09			6284 605 004 			
315 CDI 4x4 (906.631, 906.633, 906.635, 906.637)	02.08 - 12.09	OM651		3000 990 287 	240		
	03.09 -			2290 601 081 	240 26	ZMS Modul XTend plus CSC	
	03.09 -				2294 000 994 	240	enthält Schwungradbefestigungsschrauben / includes bolt for flywheel mounting (66)
					6284 605 004 		
313 CDI (906.631, 906.633, 906.635, 906.637)	05.09 -	OM651.956, OM651.955		3000 990 287 	240		
				2290 601 081 	240 26	ZMS Modul XTend plus CSC	
313 CDI 4x4 (906.631, 906.633, 906.635, 906.637)	05.09 -	OM651.956, OM651.955		3000 990 287 	240		
				2290 601 081 	240 26	ZMS Modul XTend plus CSC	
318 CDI (906.631, 906.633, 906.635, 906.637)	06.06 - 12.09	OM642.993, OM642.896, OM642.992, OM642.898		3000 990 195 	260 26		
	02.08 - 12.09			 3000 951 824  3182 654 192	HHAS-1		
318 CDI 4x4 (906.631, 906.633, 906.635, 906.637)	02.08 - 12.09						
319 CDI / BlueTEC (906.631, 906.633, 906.635, 906.637)	03.09 -						
319 CDI / BlueTEC 4x4 (906.631, 906.633, 906.635, 906.637)	03.09 -						





















SPRINTER 3,5-t Pritsche / Flatbed (906) 06.06 -

316 (906.133, 906.135, 906.233, 906.235)	09.08 -	M271.951		3000 990 144 	240 26		
	09.08 -			 3000 951 188  3182 654 192	HHAS-1		
316 NGT (906.133, 906.135, 906.233, 906.235)	09.08 -						
316 NGT (906.133, 906.135, 906.233, 906.235)	09.08 -	M271.951		3000 990 144 	240 26		
	09.08 -			 3000 951 188  3182 654 192	HHAS-1		
316 LGT (906.133, 906.135, 906.233, 906.235)	09.08 -						

		CODE				
--	--	------	--	---	---	---

MERCEDES-BENZ

SPRINTER 3,5-t Pritsche / Flatbed (906) 06.06 -

















309 CDI (906.131, 906.133, 906.135, 906.231, 906.233...)	06.06 - 12.09	OM646		3000 990 144 	240 26		
	03.09 - 05.16			3000 951 188 3182 654 192	HHAS-1		
310 CDI (906.131, 906.133, 906.135, 906.231, 906.233...)	06.06 - 12.09			2290 601 018 	240 26	ZMS Modul XTend plus CSC	
				3000 951 188 2294 000 835 3182 654 192	HHAS-1	Montageart: nicht vormontiert / Mounting Type: not pre-mounted Beinhaltet ZMS, Kupplungsdruckplatte, Kupplungsscheibe und CSC / Contains twin-mass flywheel, clutch cover assembly, clutch disc and CSC	(46) (11)
311 CDI (906.131, 906.133, 906.135, 906.231, 906.233...)	02.08 - 12.09					enthält Schwungradbefestigungsschrauben / includes bolt for flywheel mounting	(66)
313 CDI 4x4 (906.131, 906.133, 906.135, 906.231...)	06.06 - 05.16						
315 CDI (906.131, 906.133, 906.135, 906.231...)	06.06 - 12.09	OM651		3000 990 287 	240		
315 CDI 4x4 (906.131, 906.133, 906.135, 906.231...)	02.08 - 12.09			2290 601 081 	240 26	ZMS Modul XTend plus CSC	(46)
316 CDI (906.131, 906.133, 906.135, 906.231...)	03.09 -					Montageart: nicht vormontiert / Mounting Type: not pre-mounted Beinhaltet ZMS, Kupplungsdruckplatte, Kupplungsscheibe und CSC / Contains twin-mass flywheel, clutch cover assembly, clutch disc and CSC	(11)
316 CDI 4x4 (906.131, 906.133, 906.135, 906.231...)	03.09 -					enthält Schwungradbefestigungsschrauben / includes bolt for flywheel mounting	(66)
				2294 000 994 	240	enthält Schwungradbefestigungsschrauben / includes bolt for flywheel mounting	(66)
				6284 605 004 			
313 CDI (906.131, 906.133, 906.135, 906.231, 906.233...)	06.06 - 05.16	OM651.956, OM651.955		3000 990 287 	240		
				2290 601 081 	240 26	ZMS Modul XTend plus CSC	(46)
						Montageart: nicht vormontiert / Mounting Type: not pre-mounted Beinhaltet ZMS, Kupplungsdruckplatte, Kupplungsscheibe und CSC / Contains twin-mass flywheel, clutch cover assembly, clutch disc and CSC	(11)
						enthält Schwungradbefestigungsschrauben / includes bolt for flywheel mounting	(66)
313 CDI (906.131, 906.133, 906.135, 906.231, 906.233...)	06.06 - 05.16	OM646		3000 990 144 	240 26		
				3000 951 188 3182 654 192	HHAS-1		
				2290 601 018 	240 26	ZMS Modul XTend plus CSC	(46)
				3000 951 188 2294 000 835 3182 654 192	HHAS-1	Montageart: nicht vormontiert / Mounting Type: not pre-mounted Beinhaltet ZMS, Kupplungsdruckplatte, Kupplungsscheibe und CSC / Contains twin-mass flywheel, clutch cover assembly, clutch disc and CSC	(11)
						enthält Schwungradbefestigungsschrauben / includes bolt for flywheel mounting	(66)
				6284 605 004			
		OM651		3000 990 287 	240		
				2290 601 081 	240 26	ZMS Modul XTend plus CSC	(46)
						Montageart: nicht vormontiert / Mounting Type: not pre-mounted Beinhaltet ZMS, Kupplungsdruckplatte, Kupplungsscheibe und CSC / Contains twin-mass flywheel, clutch cover assembly, clutch disc and CSC	(11)
						enthält Schwungradbefestigungsschrauben / includes bolt for flywheel mounting	(66)
				2294 000 994	240	enthält Schwungradbefestigungsschrauben / includes bolt for flywheel mounting	(66)
				6284 605 004			
318 CDI (906.131, 906.133, 906.135, 906.231, 906.233...)	06.06 - 12.09	OM642.993, OM642.896, OM642.992, OM642.898		3000 990 195 	260 26		
318 CDI 4x4 (906.131, 906.133, 906.135, 906.231...)	02.08 - 12.09			3000 951 824 3182 654 192	HHAS-1		
319 CDI / BlueTEC (906.131, 906.133, 906.135, 906.231...)	03.09 -						
319 CDI / BlueTEC 4x4 (906.131, 906.133, 906.135...)	05.11 -	OM642.896, OM642.992, OM642.898		3000 951 824 	260 26	XTend	(48)
						Nabenprofil / Hub Profile: 26x29-26N	

















SPRINTER 4,6-t Kasten / Box (906) 06.06 -

411 CDI (906.653, 906.655, 906.657)	06.09 - 12.09	OM646.990, OM646.989, OM646.985		2290 601 018 	240 26	ZMS Modul XTend plus CSC	(46)
415 CDI (906.653, 906.655, 906.657)	06.09 - 12.09			3000 951 188 2294 000 835 3182 654 192	HHAS-1	Montageart: nicht vormontiert / Mounting Type: not pre-mounted Beinhaltet ZMS, Kupplungsdruckplatte, Kupplungsscheibe und CSC / Contains twin-mass flywheel, clutch cover assembly, clutch disc and CSC	(11)

		CODE				
--	--	------	--	---	---	---

MERCEDES-BENZ















SPRINTER 4,6-t Kasten / Box (906) 06.06 -							
413 CDI (906.653, 906.655, 906.657) 416 CDI (906.653, 906.655, 906.657)	06.06 - 05.16	OM646		3000 990 144  3000 951 188 3182 654 192	240 26 HHAS-1		
	03.09 -			2290 601 018  3000 951 188 2294 000 835 3182 654 192	240 26 HHAS-1	ZMS Modul XTend plus CSC Montageart: nicht vormontiert / Mounting Type: not pre-mounted (46) Beinhaltet ZMS, Kupplungsdruckplatte, Kupplungsscheibe und CSC / Contains twin-mass flywheel, clutch cover assembly, clutch disc and CSC (11) enthält Schwungradbefestigungsschrauben / includes bolt for flyweel mounting (66)	
				6284 605 004 			
			OM651		3000 990 287  2290 601 081 	240 240 26	ZMS Modul XTend plus CSC Montageart: nicht vormontiert / Mounting Type: not pre-mounted (46) Beinhaltet ZMS, Kupplungsdruckplatte, Kupplungsscheibe und CSC / Contains twin-mass flywheel, clutch cover assembly, clutch disc and CSC (11) enthält Schwungradbefestigungsschrauben / includes bolt for flyweel mounting (66)
				2294 000 994 	240	enthält Schwungradbefestigungsschrauben / includes bolt for flyweel mounting (66)	
				6284 605 004 			
419 CDI (906.653, 906.655, 906.657)	03.09 -	OM642.992		3000 990 195  3000 951 824 3182 654 192	260 26 HHAS-1		
				6284 605 004			

SPRINTER 4,6-t Pritsche / Flatbed (906) 06.06 -							
411 CDI (906.153, 906.155, 906.253, 906.255)	06.09 - 12.09	OM646.985		2290 601 018  3000 951 188 2294 000 835 3182 654 192	240 26 HHAS-1	ZMS Modul XTend plus CSC Montageart: nicht vormontiert / Mounting Type: not pre-mounted (46) Beinhaltet ZMS, Kupplungsdruckplatte, Kupplungsscheibe und CSC / Contains twin-mass flywheel, clutch cover assembly, clutch disc and CSC (11) enthält Schwungradbefestigungsschrauben / includes bolt for flyweel mounting (66)	
					6284 605 004 		
413 CDI (906.153, 906.155, 906.253, 906.255) 416 CDI (906.153, 906.155, 906.253, 906.255)	06.06 - 05.16	OM646		3000 990 144  3000 951 188 3182 654 192	240 26 HHAS-1		
	03.09 -			2290 601 018  3000 951 188 2294 000 835 3182 654 192	240 26 HHAS-1	ZMS Modul XTend plus CSC Montageart: nicht vormontiert / Mounting Type: not pre-mounted (46) Beinhaltet ZMS, Kupplungsdruckplatte, Kupplungsscheibe und CSC / Contains twin-mass flywheel, clutch cover assembly, clutch disc and CSC (11) enthält Schwungradbefestigungsschrauben / includes bolt for flyweel mounting (66)	
				6284 605 004 			
			OM651		3000 990 287  2290 601 081 	240 240 26	ZMS Modul XTend plus CSC Montageart: nicht vormontiert / Mounting Type: not pre-mounted (46) Beinhaltet ZMS, Kupplungsdruckplatte, Kupplungsscheibe und CSC / Contains twin-mass flywheel, clutch cover assembly, clutch disc and CSC (11) enthält Schwungradbefestigungsschrauben / includes bolt for flyweel mounting (66)
				2294 000 994 	240	enthält Schwungradbefestigungsschrauben / includes bolt for flyweel mounting (66)	
				6284 605 004 			



















		CODE				
--	--	------	--	---	---	---

MERCEDES-BENZ

SPRINTER 4,6-t Pritsche / Flatbed (906) 06.06 -

415 CDI (906.153, 906.155, 906.253, 906.255)	06.06 - 12.09	OM646		3000 990 144  3000 951 188 3182 654 192	240 26 HHAS-1		
				2290 601 018  3000 951 188 2294 000 835 3182 654 192	240 26 HHAS-1	ZMS Modul XTend plus CSC Montageart: nicht vormontiert / Mounting Type: not pre-mounted (46) Beinhaltet ZMS, Kupplungsdruckplatte, Kupplungsscheibe und CSC / Contains twin-mass flywheel, clutch cover assembly, clutch disc and CSC (11) enthält Schwungradbefestigungsschrauben / includes bolt for flywheel mounting (66)	
				6284 605 004			
				OM651		3000 990 287  2290 601 081 	240 240 26
				2294 000 994 	240	enthält Schwungradbefestigungsschrauben / includes bolt for flywheel mounting (66)	
				6284 605 004			
418 CDI (906.153, 906.155, 906.253, 906.255) 419 CDI (906.153, 906.155, 906.253, 906.255)	06.06 - 12.09 03.09 -	OM642.993, OM642.896, OM642.992, OM642.898		3000 990 195  3000 951 824 3182 654 192	260 26 HHAS-1		
				6284 605 004			



SPRINTER 5-t Kasten / Box (906) 06.06 -

509 CDI (906.653, 906.655, 906.657) 510 CDI (906.653, 906.655, 906.657) 511 CDI (906.653, 906.655, 906.657) 513 CDI (906.653, 906.655, 906.657) 515 CDI (906.653, 906.655, 906.657) 516 CDI (906.653, 906.655, 906.657)	06.06 - 12.09 03.09 - 05.16 06.06 - 12.09 06.06 - 06.06 - 12.09 03.09 -	OM646		3000 990 144  3000 951 188 3182 654 192	240 26 HHAS-1		
				2290 601 018  3000 951 188 2294 000 835 3182 654 192	240 26 HHAS-1	ZMS Modul XTend plus CSC Montageart: nicht vormontiert / Mounting Type: not pre-mounted (46) Beinhaltet ZMS, Kupplungsdruckplatte, Kupplungsscheibe und CSC / Contains twin-mass flywheel, clutch cover assembly, clutch disc and CSC (11) enthält Schwungradbefestigungsschrauben / includes bolt for flywheel mounting (66)	
				6284 605 004 			
				OM651		3000 990 287  2290 601 081 	240 240 26
				2294 000 994 	240	enthält Schwungradbefestigungsschrauben / includes bolt for flywheel mounting (66)	
				6284 605 004 			
511 CDI 4x4 (906.653, 906.655, 906.657) 515 CDI 4x4 (906.653, 906.655, 906.657)	06.06 - 12.09 06.06 - 12.09	OM646.990, OM646.989, OM646.985		2290 601 018  3000 951 188 2294 000 835 3182 654 192	240 26 HHAS-1	ZMS Modul XTend plus CSC Montageart: nicht vormontiert / Mounting Type: not pre-mounted (46) Beinhaltet ZMS, Kupplungsdruckplatte, Kupplungsscheibe und CSC / Contains twin-mass flywheel, clutch cover assembly, clutch disc and CSC (11) enthält Schwungradbefestigungsschrauben / includes bolt for flywheel mounting (66)	
513 CDI (906.653, 906.655, 906.657) 513 CDI 4x4 (906.653, 906.655, 906.657) 516 CDI 4x4 (906.653, 906.655, 906.657)	06.06 - 06.06 - 06.06 -	OM651.956, OM651.957, OM651.955		3000 990 287  2290 601 081 	240 240 26	ZMS Modul XTend plus CSC Montageart: nicht vormontiert / Mounting Type: not pre-mounted (46) Beinhaltet ZMS, Kupplungsdruckplatte, Kupplungsscheibe und CSC / Contains twin-mass flywheel, clutch cover assembly, clutch disc and CSC (11) enthält Schwungradbefestigungsschrauben / includes bolt for flywheel mounting (66)	























		CODE				
--	--	------	--	---	---	---

MERCEDES-BENZ



SPRINTER 5-t Kasten / Box (906) 06.06 -

518 CDI (906.653, 906.655, 906.657)	06.06 - 12.09	OM642.993, OM642.896, OM642.992, OM642.898		3000 990 195  3000 951 824 3182 654 192	260 26 HHAS-1		
519 CDI / BlueTEC (906.653, 906.655, 906.657)	03.09 -			6284 605 004			

























SPRINTER 5-t Pritsche / Flatbed (906) 06.06 -

516 (906.153, 906.155, 906.253, 906.255)	09.08 -	M271.951		3000 990 144  3000 951 188 3182 654 192	240 26 HHAS-1		
516 NGT (906.153, 906.155, 906.253, 906.255)	09.08 -			6284 605 004			
509 CDI (906.153, 906.155, 906.253, 906.255)	06.06 - 12.09	OM646		3000 990 144  3000 951 188 3182 654 192	240 26 HHAS-1		
510 CDI (906.153, 906.155, 906.253, 906.255)	03.09 -			2290 601 018  3000 951 188 2294 000 835 3182 654 192	240 26 HHAS-1	ZMS Modul XTend plus CSC Montageart: nicht vormontiert / Mounting Type: not pre-mounted	(46)
511 CDI (906.153, 906.155, 906.253, 906.255)	06.06 - 12.09					Beinhaltet ZMS, Kupplungsdruckplatte, Kupplungsscheibe und CSC / Contains twin-mass flywheel, clutch cover assembly, clutch disc and CSC	(11)
513 CDI (906.155, 906.253, 906.255)	06.06 - 05.16					enthält Schwungradbefestigungsschrauben / includes bolt for flywheel mounting	(66)
513 CDI 4x4 (906.155, 906.253, 906.255)	05.11 - 05.16			6284 605 004 			
513 CDI (906.155, 906.253, 906.255)	06.06 - 05.16	OM651		3000 990 287  2290 601 081 	240 240 26	ZMS Modul XTend plus CSC Montageart: nicht vormontiert / Mounting Type: not pre-mounted	(46)
515 CDI (906.153, 906.155, 906.253, 906.255)	06.06 - 12.09					Beinhaltet ZMS, Kupplungsdruckplatte, Kupplungsscheibe und CSC / Contains twin-mass flywheel, clutch cover assembly, clutch disc and CSC	(11)
516 CDI (906.153, 906.155, 906.253, 906.255)	03.09 -					enthält Schwungradbefestigungsschrauben / includes bolt for flywheel mounting	(66)
516 CDI 4x4 (906.153, 906.155, 906.255)	05.11 -			2294 000 994 	240	enthält Schwungradbefestigungsschrauben / includes bolt for flywheel mounting	(66)
				6284 605 004 			
511 CDI 4x4 (906.155, 906.253, 906.255)	06.06 - 12.09	OM646.990, OM646.989, OM646.985		2290 601 018  3000 951 188 2294 000 835 3182 654 192	240 26 HHAS-1	ZMS Modul XTend plus CSC Montageart: nicht vormontiert / Mounting Type: not pre-mounted	(46)
515 CDI 4x4 (906.153, 906.155, 906.253, 906.255)	06.06 - 12.09					Beinhaltet ZMS, Kupplungsdruckplatte, Kupplungsscheibe und CSC / Contains twin-mass flywheel, clutch cover assembly, clutch disc and CSC	(11)
						enthält Schwungradbefestigungsschrauben / includes bolt for flywheel mounting	(66)
518 CDI (906.153, 906.155, 906.253, 906.255)	06.06 - 12.09	OM642.993, OM642.896, OM642.992, OM642.898		3000 990 195  3000 951 824 3182 654 192	260 26 HHAS-1		
519 CDI / BlueTEC (906.153, 906.155, 906.253, 906.255)	03.09 -			6284 605 004			
518 CDI 4x4 (906.153, 906.155, 906.253, 906.255)	06.06 - 12.09	OM642.993, OM642.896, OM642.898, OM642.992		3000 951 824 	260 26	XTend Nabenprofil / Hub Profile: 26x29-26N	(48)
519 CDI / BlueTEC 4x4 (906.153, 906.155, 906.253, 906.255)	03.09 -						

























T2/L Kasten / Box 01.68 - 12.88











L 405 D	01.72 - 12.80	OM636, OM621		1881 059 208	200 KS200	->Chass. 082858	
				1861 123 236	200 10 200PE	->Chass. 082858	
				3082 121 031	228 M228	Chass. 082859-> Nur verbauen, wenn Fahrzeug mit M-Kupplung ausgerüstet ist / Only install if the vehicle is equipped with an M-type clutch	(52)

MERCEDES-BENZ

T2/L Kasten / Box		01.68 - 12.88					
L 406 DG (309.111, 309.112, 309.113, 309.114, 309.115...)	01.68 - 12.74	OM615, 616, 621	 3082 121 031	228 M228	->Chass. 145736 LHD ->Chass. 148036 RHD Nur verbauen, wenn Fahrzeug mit M-Kupplung ausgerüstet ist / Only install if the vehicle is equipped with an M-type clutch	(52)	
			 3082 121 031	228 M228	Chass. 145737 LHD - Chass. 182065 LHD Chass. 148037 RHD - Chass. 182065 RHD 309.100-103/111-116/124-126		
			 1878 634 052	228 10 228GSB	Chass. 145737 LHD - Chass. 182065 LHD Chass. 148037 RHD - Chass. 182065 RHD 309.102-103		
			 3082 121 031	228 M228	Chass. 182066 - Chass. 556499 309.100-103/111-116/124-126		
			 1878 634 052	228 10 228GSB	Chass. 182066 - Chass. 556499 309.102-103		
			 3151 000 206	KZIS-1	Chass. 182066 - Chass. 556499 309.100-103/111-116/124-126		
			 3082 121 031	228 M228	Chass. 556500-> 309.100-103/111-116/124-126		
			 3151 000 206	KZIS-1	Chass. 556500-> 309.100-103/111-116/124-126		
L 407 D (309.111, 309.112, 309.113, 309.114, 309.115...), 48 kW L 407 D (309.111, 309.112, 309.113, 309.114, 309.115...), 53 kW	01.75 - 12.88	OM615, 616, 621	 3082 121 031	228 M228	->Chass. 145736 LHD ->Chass. 148036 RHD 309.100-103/111-116/124-126 Nur verbauen, wenn Fahrzeug mit M-Kupplung ausgerüstet ist / Only install if the vehicle is equipped with an M-type clutch	(52)	
	01.75 - 12.88		 3082 121 031	228 M228	Chass. 145737 LHD - Chass. 182065 LHD Chass. 148037 RHD - Chass. 182065 RHD 309.100-103/111-116/124-126		
			 1878 634 052	228 10 228GSB	Chass. 145737 LHD - Chass. 182065 LHD Chass. 148037 RHD - Chass. 182065 RHD 309.102-103		
			 3082 121 031	228 M228	Chass. 182066 - Chass. 556499 309.100-103/111-116/124-126		
			 1878 634 052	228 10 228GSB	Chass. 182066 - Chass. 556499 309.102-103		
			 3151 000 206	KZIS-1	Chass. 182066 - Chass. 556499 309.100-103/111-116/124-126		
			 3082 121 031	228 M228	Chass. 556500-> 309.100-103/111-116/124-126		
			 3151 000 206	KZIS-1	Chass. 556500-> 309.100-103/111-116/124-126		
			OM615, 616	 3082 121 031	228 M228		
				 1878 634 052	228 10 228GSB		
L 408 G (309.012, 309.013, 309.014, 309.015, 309.016...), 55 kW L 408 G (309.012, 309.013, 309.014, 309.015, 309.016...), 63 kW L 408 G (309.012, 309.013, 309.014, 309.015, 309.016...), 55 kW L 408 G (309.012, 309.013, 309.014, 309.015, 309.016...), 63 kW L 409 (309.011, 309.012, 309.013, 309.014, 309.015...) L 410 (309.011, 309.012, 309.013, 309.014, 309.015...)	01.68 - 12.72	M115, 121	 1878 634 052	228 10 228GSB	->Chass. 145736		
	01.68 - 12.72		 3082 121 031	228 M228	->Chass. 145736 Nur verbauen, wenn Fahrzeug mit M-Kupplung ausgerüstet ist / Only install if the vehicle is equipped with an M-type clutch	(52)	
	08.72 - 12.74		 3082 121 031	228 M228			
	08.72 - 12.74		 1878 634 052	228 10 228GSB	->Chass. 556499		
	08.72 - 12.74		 3151 000 206	KZIS-1	Chass. 184087->		
	01.75 - 08.82		 1863 869 010	35	Kugellager / Ball Bearing	(38)	
08.82 - 12.88							

MERCEDES-BENZ











T2/L Kasten / Box		01.68 - 12.88			
L 408 DG (309.311, 309.312, 309.313, 309.314, 309.315...)	01.70 - 12.74	OM314	 1882 205 234	250 HBX250	
			1882 600 122	250 HBX250	
			 1861 291 136	250 10 250GTZ	
			1878 634 082	250 10 250GTZ	
			 3151 095 043	KZI-3	->Chass. 145736 LHD ->Chass. 148036 RHD
			 3151 033 031	KZI-3	Chass. 145737 LHD - Mot. 678174 LHD Chass. 148037 RHD - Mot. 678174 RHD
			 1800 125 201  1882 205 234  1861 291 136  3151 044 031	250 10 HBX250 250GTZ KZI-3	Mot. 678175->
L 508 DG (309.411, 309.412, 309.413, 309.414, 309.415...), 60 kW L 508 DG (309.411, 309.412, 309.413, 309.414, 309.415...), 63 kW	01.70 - 12.88	OM314	 1800 125 201  1882 205 234  1861 291 136  3151 044 031	250 10 HBX250 250GTZ KZI-3	Mot. 678175->
	01.70 - 12.88		 1882 205 234	250 HBX250	->Chass. 145736 LHD ->Chass. 148036 RHD
			1882 600 122	250 HBX250	->Chass. 145736 LHD ->Chass. 148036 RHD
			 1878 634 082	250 10 250GTZ	->Chass. 145736 LHD ->Chass. 148036 RHD
			1861 291 136	250 10 250GTZ	->Chass. 145736 LHD ->Chass. 148036 RHD
			 3151 095 043	KZI-3	->Chass. 145736 LHD ->Chass. 148036 RHD
L 608 D (310.311, 310.312, 310.313, 310.314, 310.315...)	01.70 - 12.88	OM314.948, OM314.967	 1800 125 201  1882 205 234  1861 291 136  3151 044 031	250 10 HBX250 250GTZ KZI-3	Mot. 410748-> 310.300-305/311-316/324-329/340-345/400-405 /411-416/424-429/440-445
			 3151 095 043	KZI-3	->Chass. 145736 LHD ->Chass. 148036 RHD 310.300-305/311-316/324-329/340-345/400-405 /411-416/424-429/440-445
			 3151 033 031	KZI-3	Chass. 145737 - Mot. 410747 310.340-345/400-405/411-416/424-429/440-445 /300-305/311-316/324-329
L 613 D (310.510, 313.424, 313.427, 313.429)	04.77 - 12.88	OM353.963, OM353.966	 1882 317 131 #	280 HVB280	
			 1861 632 032	280 10 280W2GSZ	->Chass. 346882
			1861 919 134	280 10 280GTZ	Chass. 346883->
			 3151 044 031	KZI-3	

T2/L Kipper / Dumptruck		01.68 - 12.88				
LK 408 G (309.040, 309.041) LK 408 G, LK 409 (309.040, 309.041, 309.044) LK 408 G, LK 409 (309.041, 309.044)	01.68 - 12.74	M115, 121	 1878 634 052	228 10 228GSB	->Chass. 145736	
	01.75 - 08.82		 3082 121 031	228 M228	->Chass. 145736 Nur verbauen, wenn Fahrzeug mit M-Kupplung ausgerüstet ist / Only install if the vehicle is equipped with an M-type clutch	(52)
			 3082 121 031	228 M228		
			 1878 634 052	228 10 228GSB	->Chass. 556499	
			 3151 000 206	KZIS-1	Chass. 184087->	
			 1863 869 010	35	Kugellager / Ball Bearing	(38)
LKO 508 DG (309.440, 309.441, 309.442, 309.444, 309.445)	09.72 - 06.88	OM314	 1800 125 201  1882 205 234  1861 291 136  3151 044 031	250 10 HBX250 250GTZ KZI-3	Mot. 678175-> 309.440-445	
			 3151 095 043	KZI-3	->Chass. 145736 LHD ->Chass. 148036 RHD 309.440-445	
			3151 033 031	KZI-3	Chass. 145737 LHD - Mot. 678174 LHD	













		CODE				
--	--	------	--	---	---	---

MERCEDES-BENZ



T2/L Kipper / Dumptruck 01.68 - 12.88

L 608 D (310.340, 310.341, 310.342, 310.344, 310.345...)	02.84 - 12.88	OM314.961, OM314.948, OM314.946, OM314.963	 1800 125 201  1882 205 234  1861 291 136  3151 044 031	250 10 HBX250 250GTZ KZI-3	Mot. 410748-> 310.300-305/311-316/324-329/340-345/400-405 /411-416/424-429/440-445	
			 3151 095 043	KZI-3	->Chass. 145736 LHD ->Chass. 148036 RHD 310.300-305/311-316/324-329/340-345/400-405 /411-416/424-429/440-445	
			 3151 033 031	KZI-3	Chass. 145737 - Mot. 410747 310.340-345/400-405/411-416/424-429/440-445 /300-305/311-316/324-329	
LK 911 (328.029) LS 911 (328.024, 328.026, 328.044)	01.72 - 07.83 01.72 - 07.83	OM352.911	 1861 919 134	280 10 280GTZ		
			 3151 095 043	KZI-3		
			 1882 201 132 HD	295 GF295		
			 1861 279 133 HD	295 10 295GTZ		
			 3151 095 043 HD	KZI-3		

























T2/L Kommunalfahrzeug 06.72 - 08.82

LF 408 G (309.050, 309.051, 309.052, 309.053, 309.054...), 55 kW LF 408 G (309.050, 309.051, 309.052, 309.053, 309.054...), 63 kW LF 409 G (309.050, 309.051, 309.052, 309.053, 309.054...)	08.72 - 12.74	M115, 121	 1878 634 052	228 10 228GSB	->Chass. 145736		
			 3082 121 031	228 M228	->Chass. 145736 Nur verbauen, wenn Fahrzeug mit M-Kupplung ausgerüstet ist / Only install if the vehicle is equipped with an M-type clutch	(52)	
			 3082 121 031	228 M228			
	01.75 - 08.82			 1878 634 052	228 10 228GSB	->Chass. 556499	
				 3151 000 206	KZIS-1	Chass. 184087->	
				 1863 869 010	35	Kugellager / Ball Bearing	(38)
LKO 508 DG (309.430, 309.431, 309.432, 309.433, 309.435)	06.72 - 02.77	OM314	 1882 205 234	250 HBX250	309.430-433/435		
			 1882 600 122	250 HBX250	309.430-433/435		
			 1861 291 136	250 10 250GTZ	309.430-433/435		
			 1878 634 082	250 10 250GTZ	309.430-433/435		
			 3151 095 043	KZI-3	->Chass. 145736 LHD ->Chass. 148036 RHD 309.430-433/435		
			 3151 033 031	KZI-3	Chass. 145737 LHD-> Chass. 148036 RHD-> 309.430-433/435		

T2/L Pritsche / Flatbed 01.68 - 12.88



























L 405 D	01.72 - 12.80	OM636, OM621	 1881 059 208	200 KS200	->Chass. 082858	
			 1861 123 236	200 10 200PE	->Chass. 082858	
			 3082 121 031	228 M228	Chass. 082859-> Nur verbauen, wenn Fahrzeug mit M-Kupplung ausgerüstet ist / Only install if the vehicle is equipped with an M-type clutch	(52)

MERCEDES-BENZ



T2/L Pritsche / Flatbed		01.68 - 12.88				
L 406 DG (309.100, 309.101, 309.102, 309.103)	01.68 - 12.74	OM615, 616, 621		3082 121 031	228 M228	->Chass. 145736 LHD ->Chass. 148036 RHD Nur verbauen, wenn Fahrzeug mit M-Kupplung ausgerüstet ist / Only install if the vehicle is equipped with an M-type clutch (52)
				3082 121 031	228 M228	Chass. 145737 LHD - Chass. 182065 LHD Chass. 148037 RHD - Chass. 182065 RHD 309.100-103/111-116/124-126
				1878 634 052	228 10 228GSB	Chass. 145737 LHD - Chass. 182065 LHD Chass. 148037 RHD - Chass. 182065 RHD 309.102-103
				3082 121 031	228 M228	Chass. 182066 - Chass. 556499 309.100-103/111-116/124-126
				1878 634 052	228 10 228GSB	Chass. 182066 - Chass. 556499 309.102-103
				3151 000 206	KZIS-1	Chass. 182066 - Chass. 556499 309.100-103/111-116/124-126
				3082 121 031	228 M228	Chass. 556500-> 309.100-103/111-116/124-126
				3151 000 206	KZIS-1	Chass. 556500-> 309.100-103/111-116/124-126
L 407 D (309.100, 309.101, 309.102, 309.103), 48 kW L 407 D (309.100, 309.101, 309.102, 309.103), 53 kW	01.75 - 12.88 01.75 - 12.88	OM615, 616, 621		3082 121 031	228 M228	->Chass. 145736 LHD ->Chass. 148036 RHD 309.100-103/111-116/124-126 Nur verbauen, wenn Fahrzeug mit M-Kupplung ausgerüstet ist / Only install if the vehicle is equipped with an M-type clutch (52)
				3082 121 031	228 M228	Chass. 145737 LHD - Chass. 182065 LHD Chass. 148037 RHD - Chass. 182065 RHD 309.100-103/111-116/124-126
				1878 634 052	228 10 228GSB	Chass. 145737 LHD - Chass. 182065 LHD Chass. 148037 RHD - Chass. 182065 RHD 309.102-103
				3082 121 031	228 M228	Chass. 182066 - Chass. 556499 309.100-103/111-116/124-126
				1878 634 052	228 10 228GSB	Chass. 182066 - Chass. 556499 309.102-103
				3151 000 206	KZIS-1	Chass. 182066 - Chass. 556499 309.100-103/111-116/124-126
				3082 121 031	228 M228	Chass. 556500-> 309.100-103/111-116/124-126
				3151 000 206	KZIS-1	Chass. 556500-> 309.100-103/111-116/124-126
				3082 121 031	228 M228	
				1878 634 052	228 10 228GSB	
L 408 G (309.000, 309.001, 309.002, 309.003, 309.011), 55 kW L 408 G (309.000, 309.001, 309.002, 309.003, 309.011), 63 kW L 409 (309.000, 309.001, 309.002, 309.003) L 410 (309.000, 309.002)	08.72 - 12.74 08.72 - 12.74 01.75 - 08.82 08.82 - 12.88	M115, 121		3082 121 031	228 M228	->Chass. 145736 Nur verbauen, wenn Fahrzeug mit M-Kupplung ausgerüstet ist / Only install if the vehicle is equipped with an M-type clutch (52)
				1878 634 052	228 10 228GSB	->Chass. 145736
				3082 121 031	228 M228	
				1878 634 052	228 10 228GSB	->Chass. 556499
				3151 000 206	KZIS-1	Chass. 184087->
				1863 869 010	35	Kugellager / Ball Bearing (38)

		CODE				
--	--	------	--	---	---	---

MERCEDES-BENZ

T2/L Pritsche / Flatbed		01.68 - 12.88			
L 408 DG (309.300, 309.301, 309.302, 309.303)	01.70 - 12.74	OM314	 1882 205 234	250 HBX250	
			1882 600 122	250 HBX250	
			 1861 291 136	250 10 250GTZ	
			1878 634 082	250 10 250GTZ	
			 3151 095 043	KZI-3	->Chass. 145736 LHD ->Chass. 148036 RHD
			 3151 033 031	KZI-3	Chass. 145737 LHD - Mot. 678174 LHD Chass. 148037 RHD - Mot. 678174 RHD
			 1800 125 201  1882 205 234  1861 291 136  3151 044 031	250 10 HBX250 250GTZ KZI-3	Mot. 678175->
L 508 DG (309.400, 309.401, 309.402, 309.403, 309.404...), 60 kW L 508 DG (309.400, 309.401, 309.402, 309.403, 309.404...), 63 kW	01.70 - 12.88	OM314	 1800 125 201  1882 205 234  1861 291 136  3151 044 031	250 10 HBX250 250GTZ KZI-3	Mot. 678175->
	01.70 - 12.88		 1882 205 234	250 HBX250	->Chass. 145736 LHD ->Chass. 148036 RHD
			1882 600 122	250 HBX250	->Chass. 145736 LHD ->Chass. 148036 RHD
			 1878 634 082	250 10 250GTZ	->Chass. 145736 LHD ->Chass. 148036 RHD
			1861 291 136	250 10 250GTZ	->Chass. 145736 LHD ->Chass. 148036 RHD
			 3151 095 043	KZI-3	->Chass. 145736 LHD ->Chass. 148036 RHD
L 608 D (310.300, 310.301, 310.302, 310.303, 310.304...)	01.70 - 12.88	OM314.948, OM314.967	 1800 125 201  1882 205 234  1861 291 136  3151 044 031	250 10 HBX250 250GTZ KZI-3	Mot. 410748-> 310.300-305/311-316/324-329/340-345/400-405 /411-416/424-429/440-445
			 3151 095 043	KZI-3	->Chass. 145736 LHD ->Chass. 148036 RHD 310.300-305/311-316/324-329/340-345/400-405 /411-416/424-429/440-445
			 3151 033 031	KZI-3	Chass. 145737 - Mot. 410747 310.340-345/400-405/411-416/424-429/440-445 /300-305/311-316/324-329
L 613 D (313.402, 313.404)	04.77 - 12.88	OM353.963, OM353.966	 1882 317 131 #	280 HVB280	
			 1861 632 032	280 10 280W2GSZ	->Chass. 346882
			1861 919 134	280 10 280GTZ	Chass. 346883->
			 3151 044 031	KZI-3	
L 911 (328.001, 328.002, 328.003, 328.005, 328.020...)	01.72 - 07.83	OM352.911, OM352.906	 1861 919 134	280 10 280GTZ	->Chass. 012769
			 3151 095 043	KZI-3	































T2/L Sattelschlepper		01.72 - 07.83			
L 911 (328.020, 328.022)	01.72 - 07.83	OM352.911	 1861 919 134	280 10 280GTZ	
			 3151 095 043	KZI-3	
			 1882 201 132 HD	295 GF295	
			 1861 279 133 HD	295 10 295GTZ	
			 3151 095 043 HD	KZI-3	

T2/LN1 Kasten / Box		04.86 - 12.94			
507 D (667.361, 667.362)	04.86 - 04.89	OM616	 3082 121 031	228 M228	667.301-302/341-342/361-362
			 3151 000 206	KZIS-1	667.301-302/341-342/361-362
			 3000 297 002	228 10	Chass. 962133-> 667.301-302/341-342/361-362



		CODE				
--	--	------	--	---	---	---

MERCEDES-BENZ

T2/LN1 Kasten / Box 04.86 - 12.94

508 D (667.361, 667.362)	03.89 - 12.94	OM601	 3082 121 031	228 M228	667.301-302/341-342/361-362	
			 1861 936 142	228 10 228VTB	Chass. 962133-> 667.301-302/341-342/361-362	
			 3151 000 206	KZIS-1	667.301-302/341-342/361-362	
			 1863 869 010	35	667.301-302/341-342/361-362 Kugellager / Ball Bearing	(38)
510 (667.061, 667.062), 70 kW 510 (667.061, 667.062), 77 kW	04.86 - 12.94	OM102	 3082 121 031	228 M228	667.001-002/061-062	
	04.86 - 12.94		 3151 000 206	KZIS-1	667.001-002/061-062	
609 D (668.061, 668.062, 668.063), 63 kW 609 D (668.061, 668.062, 668.063), 66 kW	04.86 - 12.94	OM364	 3400 125 201	280 10 MFZ280 280GTZ KZIZ-3		
	04.86 - 12.94		 3400 127 301 #	280 10 MFZ280 280GTZ KZIZ-3	für / for: SA33611-01	(69)
609 D (668.061, 668.062, 668.063), 77 kW	06.94 - 12.94	OM354.902	 3400 127 301 #	280 10 MFZ280 280GTZ KZIZ-3		
709 D (669.061, 669.062, 669.063), 63 kW 709 D (669.061, 669.062, 669.063), 66 kW 809 D (670.061, 670.062, 670.063), 63 kW 809 D (670.061, 670.062, 670.063), 66 kW	04.86 - 12.94	OM364	 3400 125 201	280 10 MFZ280 280GTZ KZIZ-3		
	04.86 - 12.94		 3400 127 301 #	280 10 MFZ280 280GTZ KZIZ-3	für / for: SA33611-01	(69)
	04.86 - 12.94		 3400 125 201	280 10 MFZ280 280GTZ KZIZ-3	Sonderausführung / Special design	(60)
	04.86 - 12.94		 3400 127 301 #	280 10 MFZ280 280GTZ KZIZ-3	Sonderausführung / Special design	(60)
711 D (669.361, 669.362, 669.363), 77 kW 711 D (669.361, 669.362, 669.363), 85 kW 714 D (669.361, 669.362, 669.363)	04.86 - 12.94	OM364A	 3400 124 501	310 10 MFZ310 310GSB KZIZ-3		
	04.86 - 12.94		 1862 299 032	310 10 310WGSZ	Sonderausführung / Special design Kupplungsscheibe mit Vordämpfer / clutch disc with predamper	(60) (39)
	06.94 - 12.94		 3400 124 501	310 10 MFZ310 310GSB KZIZ-3	670.302-303/341-342/362-363	
811 D (670.362, 670.363), 77 kW 811 D (670.362, 670.363), 85 kW 814 D (670.364, 670.365, 670.366), 100 kW 814 D (670.364, 670.365, 670.366), 103 kW	04.86 - 12.94	OM364A	 3400 124 501	310 10 MFZ310 310GSB KZIZ-3		
	04.86 - 12.94		 1861 303 248	310 10 310GSB		
	04.86 - 12.94		 3151 170 131	KZIZ-3		
	06.94 - 12.94		 1863 869 010	35	Kugellager / Ball Bearing	(38)
814 DA 4x4 (670.464, 670.465), 100 kW 814 DA 4x4 (670.464, 670.465), 103 kW	11.87 - 12.94	OM364LA	 3482 055 132	310 MFZ310		
	11.87 - 12.94		 1861 303 248	310 10 310GSB		
			 3151 170 131	KZIZ-3		
			 1863 869 010	35	Kugellager / Ball Bearing	(38)
			 3482 055 132	310 MFZ310		
814 DA 4x4 (670.464, 670.465), 103 kW	11.87 - 12.94	OM364LA	 1861 303 248	310 10 310GSB		
	11.87 - 12.94		 1862 299 032	310 10 310WGSZ	Kupplungsscheibe mit Vordämpfer / clutch disc with predamper	(39)
			 3151 170 131	KZIZ-3		
			 1863 869 010	35	Kugellager / Ball Bearing	(38)
			 3482 055 132	310 MFZ310		









T2/LN1 Kipper / Dumptruck 04.86 - 12.94

507 DK (667.341, 667.342)	04.86 - 04.89	OM616	 3082 121 031	228 M228	667.301-302/341-342/361-362	
			 3151 000 206	KZIS-1	667.301-302/341-342/361-362	
			 3000 297 002	228 10 M228 228VTB KZIS-1	Chass. 962133-> 667.301-302/341-342/361-362	











		CODE				
--	--	------	--	---	---	---

MERCEDES-BENZ

T2/LN1 Kipper / Dumptruck 04.86 - 12.94





508 D (667.301, 667.302, 667.341, 667.342)	03.89 - 12.94	OM601	 3082 121 031	228 M228	667.301-302/341-342/361-362	
			 1861 936 142	228 10 228VTB	Chass. 962133-> 667.301-302/341-342/361-362	
			 3151 000 206	KZIS-1	667.301-302/341-342/361-362	
			 1863 869 010	35	667.301-302/341-342/361-362 Kugellager / Ball Bearing	(38)
609 DK (668.041, 668.042), 63 kW 609 DK (668.041, 668.042), 66 kW	04.86 - 12.94	OM364	 3400 125 201	280 10 MFZ280 280GTZ KZIS-3		
	04.86 - 12.94		 3400 127 301 #	280 10 MFZ280 280GTZ KZIS-3	für / for: SA33611-01	(69)
709 DK (669.041, 669.042), 63 kW 709 DK (669.041, 669.042), 66 kW	04.86 - 12.94	OM364	 3400 125 201	280 10 MFZ280 280GTZ KZIS-3		
	04.86 - 12.94		 3400 127 301 #	280 10 MFZ280 280GTZ KZIS-3	für / for: SA33611-01 Sonderausführung / Special design	(69) (60)
809 DK (670.041, 670.042), 63 kW 809 DK (670.041, 670.042), 66 kW	04.86 - 12.94					
811 DK (670.341, 670.342), 77 kW 811 DK (670.341, 670.342), 85 kW	04.86 - 12.94	OM364A	 3400 124 501	310 10 MFZ310 310GSB KZIS-3	670.302-303/341-342/362-363	



T2/LN1 Pritsche / Flatbed 04.86 - 12.94









507 D (667.301, 667.302, 667.341, 667.342)	04.86 - 04.89	OM616	 3082 121 031	228 M228	667.301-302/341-342/361-362	
			 3151 000 206	KZIS-1	667.301-302/341-342/361-362	
			 3000 297 002	228 10 M228 228VTB KZIS-1	Chass. 962133-> 667.301-302/341-342/361-362	
510 (667.001, 667.002), 70 kW 510 (667.001, 667.002), 77 kW	04.86 - 12.94	OM102	 3082 121 031	228 M228	667.001-002/061-062	
	04.86 - 12.94		 3151 000 206	KZIS-1	667.001-002/061-062	
609 D (668.001, 668.002, 668.003), 63 kW 609 D (668.001, 668.002, 668.003), 66 kW	04.86 - 12.94	OM364	 3400 125 201	280 10 MFZ280 280GTZ KZIS-3		
	04.86 - 12.94		 3400 127 301 #	280 10 MFZ280 280GTZ KZIS-3	für / for: SA33611-01	(69)
609 D (668.001, 668.002, 668.003), 77 kW	06.94 - 12.94	OM354.902	 3400 127 301 #	280 10 MFZ280 280GTZ KZIS-3		
709 D (669.001, 669.002, 669.003, 669.041, 669.000) 709 D (669.000, 669.001, 669.002, 669.003, 669.041), 63 kW 709 D (669.000, 669.001, 669.002, 669.003, 669.041), 66 kW 809 D (670.001, 670.002, 670.003), 63 kW 809 D (670.001, 670.002, 670.003), 66 kW	04.86 - 12.94	OM364	 3400 125 201	280 10 MFZ280 280GTZ KZIS-3		
	04.86 - 12.94		 3400 127 301 #	280 10 MFZ280 280GTZ KZIS-3	für / for: SA33611-01 Sonderausführung / Special design	(69) (60)
	04.86 - 12.94		 1863 869 010	35	Kugellager / Ball Bearing	(38)

		CODE				
--	--	------	--	---	---	---

MERCEDES-BENZ











T2/LN1 Pritsche / Flatbed 04.86 - 12.94						
711 D (669.301, 669.302, 669.303), 77 kW	04.86 - 12.94	OM364A		3400 124 501 ⊗ 3482 055 132 ⊗ 1861 303 248 ⊙ 3151 170 131	310 10 MFZ310 310GSB KZIZ-3	
711 D (669.301, 669.302, 669.303), 85 kW	04.86 - 12.94					
714 D (669.301, 669.302, 669.303)	06.94 - 12.94			1862 299 032	310 10 310WGSZ	Sonderausführung / Special design Kupplungsscheibe mit Vordämpfer / clutch disc with predamper (60) (39)
814 D (670.312, 670.313), 100 kW	11.87 - 12.94			1863 869 010	35	Kugellager / Ball Bearing (38)
814 DA 4x4 (670.411, 670.412), 100 kW	11.87 - 12.94					
814 D (670.312, 670.313), 103 kW	11.87 - 12.94					
814 DA 4x4 (670.411, 670.412), 103 kW	11.87 - 12.94					
811 D (670.302, 670.303), 77 kW	04.86 - 12.94	OM364A		3400 124 501 ⊗ 3482 055 132 ⊗ 1861 303 248 ⊙ 3151 170 131	310 10 MFZ310 310GSB KZIZ-3	670.302-303/341-342/362-363
811 D (670.302, 670.303), 85 kW	04.86 - 12.94					













T2/LN1 Triebkopf 04.86 - 12.94						
809 DT (670.199), 63 kW	04.86 - 12.94	OM364		3400 125 201 ⊗ 3482 054 131 ⊗ 1861 919 134 ⊙ 3151 170 131	280 10 MFZ280 280GTZ KZIZ-3	
809 DT (670.199), 66 kW	04.86 - 12.94					
				3400 127 301 # ⊗ 3482 054 131 ⊗ 1878 074 641 ⊙ 3151 170 131	280 10 MFZ280 280GTZ KZIZ-3	für / for: SA33611-01 Sonderausführung / Special design (69) (60)

VARIO Kasten / Box 09.96 -						
512 D (667.351, 667.352, 667.353)	09.96 - 12.10	OM602DELA		3000 725 001 ⊗ 3082 269 031 ⊗ 1864 504 031 ⊙ 3151 248 031	250 26 M250 250B KZIS-0	667.321-323/351-353
				3000 951 785 ● ⊗ 3082 269 031 ⊗ 1878 600 501 ⊙ 3151 248 031	250 26 M250 250CD KZIS-0	667.321-323/351-353
		OM602.984		2294 000 525	250	enthält Schwungradbefestigungsschrauben / includes bolt for flywheel mounting (66)
612 D (668.351, 668.352, 668.353)	09.96 - 12.10	OM602DELA		3000 725 001 ⊗ 3082 269 031 ⊗ 1864 504 031 ⊙ 3151 248 031	250 26 M250 250B KZIS-0	668.321-323/331-332/351-353
				3000 951 785 ● ⊗ 3082 269 031 ⊗ 1878 600 501 ⊙ 3151 248 031	250 26 M250 250CD KZIS-0	668.321-323/331-332/351-353
		OM602.985, OM602.984		2294 000 525	250	enthält Schwungradbefestigungsschrauben / includes bolt for flywheel mounting (66)
613 D, 614 D (668.351, 668.352, 668.353), 95 kW	09.96 - 12.13	OM904LA		3400 127 701 ◐ ⊗ 3482 000 462 ⊗ 1878 052 842	362 18 MF362 362WGTV	668.321-323/331-332/351-353
613 D, 614 D (668.351, 668.352, 668.353), 100 kW	09.96 - 12.11			3400 700 484 HD ●	362 18	668.321-323/331-332/351-353
615 D, 616 D (668.351, 668.352, 668.353), 112 kW	09.98 -			⊗ 3482 000 462 ⊗ 1878 006 757	MF362 362WGTV	
615 D, 616 D (668.351, 668.352, 668.353), 115 kW	09.98 -			3151 000 396	KZIS-4	668.321-323/331-332/351-353

		CODE				
--	--	------	--	---	---	---

MERCEDES-BENZ









VARIO Kasten / Box		09.96 -				
812 D (670.351, 670.352, 670.353)	09.96 - 12.10	OM602LADE		3000 725 001 ⊗ 3082 269 031 ⊗ 1864 504 031 ⊙ 3151 248 031	250 26 M250 250B KZIS-0	
813 D, 814 D (670.351, 670.352, 670.353), 95 kW	09.96 - 12.13			3000 951 785 ● ⊗ 3082 269 031 ⊗ 1878 600 501 ⊙ 3151 248 031	250 26 M250 250CD KZIS-0	
813 D, 814 D (670.351, 670.352, 670.353), 100 kW	09.96 - 12.13			2294 000 525	250	enthält Schwungradbefestigungsschrauben / includes bolt for flywheel mounting (66)
815 D, 816 D (670.351, 670.352, 670.353), 112 kW	09.96 - 12.10		OM904LA		3400 127 701 ☉ ⊗ 3482 000 462 ⊗ 1878 052 842	362 18 MF362 362WG TB
815 D, 816 D (670.351, 670.352, 670.353), 115 kW	09.96 - 12.13			3400 700 484 HD ● ☉ ⊗ 3482 000 462 ⊗ 1878 006 757	362 18 MF362 362WG TB	
				3151 000 396	KZIS-4	
				3000 951 785 ⊗ 3082 269 031 ⊗ 1878 600 501 ⊙ 3151 248 031	250 26 M250 250CD KZIS-0	
813 DA, 814 DA 4x4 (669.599, 670.451, 670.452, 670.453), 95 kW	09.96 - 12.13	OM602LADE		2294 000 525	250	enthält Schwungradbefestigungsschrauben / includes bolt for flywheel mounting (66)
813 DA, 814 DA 4x4 (669.599, 670.451, 670.452, 670.453), 100 kW	09.96 -		OM904LA		3400 127 701 ☉ ⊗ 3482 000 462 ⊗ 1878 052 842	362 18 MF362 362WG TB
815 DA, 816 DA 4x4 (669.599, 670.451, 670.452, 670.453), 112 kW	09.96 - 12.10			3400 700 484 HD ● ☉ ⊗ 3482 000 462 ⊗ 1878 006 757	362 18 MF362 362WG TB	
815 DA, 816 DA 4x4 (669.599, 670.451, 670.452, 670.453), 115 kW	09.96 - 12.13			3151 000 396	KZIS-4	

VARIO Kipper / Dumptruck		09.96 -					
612 D (668.331, 668.332)	09.96 - 12.10	OM602DELA		3000 725 001 ⊗ 3082 269 031 ⊗ 1864 504 031 ⊙ 3151 248 031	250 26 M250 250B KZIS-0	668.321-323/331-332/351-353	
				3000 951 785 ● ⊗ 3082 269 031 ⊗ 1878 600 501 ⊙ 3151 248 031	250 26 M250 250CD KZIS-0	668.321-323/331-332/351-353	
		OM602.985, OM602.984		2294 000 525	250	enthält Schwungradbefestigungsschrauben / includes bolt for flywheel mounting (66)	
613 D, 614 D (668.331, 668.332), 95 kW	09.96 - 12.13	OM904LA		3400 127 701 ☉ ⊗ 3482 000 462 ⊗ 1878 052 842	362 18 MF362 362WG TB	668.321-323/331-332/351-353	
613 D, 614 D (668.331, 668.332), 100 kW	09.96 - 11.12			3400 700 484 HD ● ☉ ⊗ 3482 000 462 ⊗ 1878 006 757	362 18 MF362 362WG TB	668.321-323/331-332/351-353	
615 D, 616 D (668.331, 668.332), 112 kW	09.98 -			3151 000 396	KZIS-4	668.321-323/331-332/351-353	
615 D, 616 D (668.331, 668.332), 115 kW	09.98 -			3000 725 001 ⊗ 3082 269 031 ⊗ 1864 504 031 ⊙ 3151 248 031	250 26 M250 250B KZIS-0		
812 D (670.331, 670.332)	09.96 - 12.10	OM602LADE		3000 951 785 ● ⊗ 3082 269 031 ⊗ 1878 600 501 ⊙ 3151 248 031	250 26 M250 250CD KZIS-0		
813 D, 814 D (670.331, 670.332), 95 kW	09.96 - 12.13			2294 000 525	250	enthält Schwungradbefestigungsschrauben / includes bolt for flywheel mounting (66)	
813 D, 814 D (670.331, 670.332), 100 kW	09.96 - 12.13		OM904LA		3400 127 701 ☉ ⊗ 3482 000 462 ⊗ 1878 052 842	362 18 MF362 362WG TB	
815 D, 816 D (670.331, 670.332), 112 kW	09.96 -				3400 700 484 HD ● ☉ ⊗ 3482 000 462 ⊗ 1878 006 757	362 18 MF362 362WG TB	
815 D, 816 D (670.331, 670.332), 115 kW	09.96 - 12.13		3151 000 396	KZIS-4			





























		CODE				
--	--	------	--	---	---	---

MERCEDES-BENZ

VARIO Kipper / Dumptruck 09.96 -

















813 DA, 814 DA 4x4 (670.431, 670.432), 95 kW	09.96 - 12.13	OM904LA		3400 127 701   3482 000 462  1878 052 842	362 18 MF362 362WGTB		
813 DA, 814 DA 4x4 (670.431, 670.432), 100 kW	09.96 - 12.13			3400 700 484 HD 	362 18		
815 DA, 816 DA 4x4 (670.431, 670.432), 112 kW	09.96 - 12.10			 3482 000 462  1878 006 757	MF362 362WGTB		
815 DA, 816 DA 4x4 (670.431, 670.432), 115 kW	09.96 - 12.13			3151 000 396	KZIS-4		







VARIO Pritsche / Flatbed 09.96 -

512 D (667.321, 667.322, 667.323)	09.96 - 12.10	OM602LADE		3000 725 001  3082 269 031  1864 504 031  3151 248 031	250 26 M250 250B KZIS-0		
612 D (668.321, 668.322, 668.323)	09.96 - 12.10						
812 D (670.321, 670.322, 670.323, 670.324)	09.96 - 12.10			3000 951 785   3082 269 031  1878 600 501  3151 248 031	250 26 M250 250CD KZIS-0		
813 D, 814 D (670.321, 670.322, 670.323, 670.324), 95 kW	09.96 - 12.13			2294 000 525	250	enthält Schwungradbefestigungsschrauben / includes bolt for flywheel mounting	(66)
813 D, 814 D (670.321, 670.322, 670.323, 670.324), 100 kW	09.96 - 12.13	OM904LA		3400 127 701   3482 000 462  1878 052 842	362 18 MF362 362WGTB		
815 D, 816 D (670.321, 670.322, 670.323, 670.324), 112 kW	09.96 - 12.10						
815 D, 816 D (670.321, 670.322, 670.323, 670.324), 115 kW	09.96 - 12.13			3400 700 484 HD   3482 000 462  1878 006 757	362 18 MF362 362WGTB		
				3151 000 396	KZIS-4		
613 D, 614 D (668.321, 668.322, 668.323), 95 kW	09.96 -	OM904LA		3400 127 701   3482 000 462  1878 052 842	362 18 MF362 362WGTB	668.321-323/331-332/351-353	
613 D, 614 D (668.321, 668.322, 668.323), 100 kW	09.96 - 12.11						
615 D, 616 D (668.321, 668.322, 668.323), 112 kW	09.98 -						
615 D, 616 D (668.321, 668.322, 668.323), 115 kW	09.98 -			3151 000 396	KZIS-4	668.321-323/331-332/351-353	
618 D (668.321, 668.322, 668.323)	09.06 -						
815 D (670.324, 670.323, 670.321)	09.96 - 12.13						
818 D (670.321, 670.322, 670.323, 670.324)	09.06 -						
818 DA 4x4	09.06 -						
813 DA, 814 DA 4x4 (670.421, 670.422, 670.423), 95 kW	09.96 - 12.13	OM904LA		3400 127 701   3482 000 462  1878 052 842	362 18 MF362 362WGTB		
813 DA, 814 DA 4x4 (670.421, 670.422, 670.423), 100 kW	09.96 - 12.13						
815 DA, 816 DA 4x4 (670.421, 670.422, 670.423), 112 kW	09.96 - 12.10						
815 DA, 816 DA 4x4 (670.421, 670.422, 670.423), 115 kW	09.96 - 12.13			3151 000 396	KZIS-4		

		CODE				
--	--	------	--	---	---	---

























MERCEDES-BENZ









VARIO Triebkopf		09.96 -					
810 DT (670.398)	09.96 - 12.10	OM602LADE	 3000 725 001  3082 269 031  1864 504 031  3151 248 031	250 26 M250 250B KZIS-0			
814 DT (670.398)	09.96 -		 3000 951 785 ●  3082 269 031  1878 600 501  3151 248 031	250 26 M250 250CD KZIS-0			
816 DT (670.398)	09.96 -		 2294 000 525	250	enthält Schwungradbefestigungsschrauben / includes bolt for flywheel mounting	(66)	
		OM904LA	 3400 127 701 ●  3482 000 462  1878 052 842	362 18 MF362 362WGTB			
			 3400 700 484 HD ●  3482 000 462  1878 006 757	362 18 MF362 362WGTB			
			 3151 000 396	362 18 KZIS-4			

VIANO (W639)		09.03 -				
CDI 2.0, 80 kW	09.03 -	OM646DE22LA	 3000 970 079 ●	240 26	XTend -> Chass. 152223 -> 05.2005 Getr. / GBox: 716.652 (SG-S370) 639.811/813/815 Torsionsgefederte Kupplungsscheibe / torsion damper clutch disc	(61)
			 3000 970 079 ●	240 26	XTend Chass. 152224-> 05.2005-> 639.811/813/815 Torsionsgefederte Kupplungsscheibe / torsion damper clutch disc	(61)
			 3000 951 112 ●	240 26	XTend -> Chass. 152223 -> 05.2005 Getr. / GBox: 716.652 (SG-S370) 639.811/813/815 Nabenprofil / Hub Profile: 26,6x28,9-26N	(48)
			3000 951 112 ●	240 26	XTend Chass. 152224-> 05.2005-> 639.811/813/815 Nabenprofil / Hub Profile: 26,6x28,9-26N	(48)
			 2294 000 834	240	639.811/813/815 enthält Schwungradbefestigungsschrauben / includes bolt for flywheel mounting	(66)
			 3182 654 192 (M)	HHAS-1	Getr. / GBox: 716.652 (SG-S370) Getr. / GBox: 716.680 (TSG-360) 639.811/813/815 Immer erneuern / Renew everytime	(30)
			3182 654 216	HHAS-1	Getr. Nr. / GBox No.: ->011 088 -> 10.2003 Getr. / GBox: 716.637 (SG-S250) 639.811/813/815 Immer erneuern / Renew everytime	(30)
			3182 654 192 (M)	HHAS-1	Getr. Nr. / GBox No.: 011 089-> 10.2003-> Getr. / GBox: 716.637 (SG-S250) 639.811/813/815 Immer erneuern / Renew everytime	(30)
	OM646.982	 6284 605 008				

		CODE				
--	--	------	--	---	---	---

MERCEDES-BENZ































VIANO (W639)		09.03 -					
CDI 2.0 4-matic CDI 2.0, 85 kW CDI 2.2, 110 kW	07.05- 08.05- 09.03-	OM646DE22LA		3000 970 079 	240 26	XTend 639.811/813/815 Torsionsgefederte Kupplungsscheibe / torsion damper clutch disc	(61)
				3000 951 112 	240 26	XTend 639.811/813/815 Nabenprofil / Hub Profile: 26,6x28,9-26N	(48)
				2294 000 834	240	639.811/813/815 enthält Schwungradbefestigungsschrauben / includes bolt for flywheel mounting	(66)
				3182 654 192 	HHAS-1	639.811/813/815 Immer erneuern / Renew everytime	(30)
		OM646.980, OM646.982		6284 605 008			
CDI 2.0, 100 kW CDI 2.2, 120 kW	07.10- 07.10-	OM651.940		3000 990 287 	240		
				6284 605 008 			
		OM651		2290 601 081 	240 26	ZMS Modul XTend plus CSC Montageart: nicht vormontiert / Mounting Type: not pre-mounted Beinhaltet ZMS, Kupplungsdruckplatte, Kupplungsscheibe und CSC / Contains twin-mass flywheel, clutch cover assembly, clutch disc and CSC enthält Schwungradbefestigungsschrauben / includes bolt for flywheel mounting	(46) (11) (66)
				2294 000 994 	240	639.811/813/815 enthält Schwungradbefestigungsschrauben / includes bolt for flywheel mounting	(66)
CDI 2.2 4-matic	07.05-	OM646DE22LA		3000 951 112 	240 26	XTend 639.811/813/815 Nabenprofil / Hub Profile: 26,6x28,9-26N	(48)
				3000 970 079 	240 26	XTend 639.811/813/815 Torsionsgefederte Kupplungsscheibe / torsion damper clutch disc	(61)
				2294 000 834	240	639.811/813/815 enthält Schwungradbefestigungsschrauben / includes bolt for flywheel mounting	(66)
				3182 654 192 	HHAS-1	Getr. / GBox: 716.652 (SG-S370) Getr. / GBox: 716.680 (TSG-360) 639.811/813/815 Immer erneuern / Renew everytime	(30)
				3182 654 216	HHAS-1	Getr. Nr. / GBox No.: ->011 088 ->10.2003 Getr. / GBox: 716.637 (SG-S250) 639.811/813/815 Immer erneuern / Renew everytime	(30)
				3182 654 192 	HHAS-1	Getr. Nr. / GBox No.: 011 089->10.2003-> Getr. / GBox: 716.637 (SG-S250) 639.811/813/815 Immer erneuern / Renew everytime	(30)
		OM646.982		6284 605 008			

VITO Kasten / Box (638)		03.97 - 07.03					
113 2.0 (638.014, 638.094)	03.97 - 07.03	M111.948		3000 726 001 3082 267 233 1864 503 231 3151 248 031	228 26	638.014 M228X 228B KZIS-0	
				1878 634 050 ●	228 26	638.014	
				1863 869 010	35	->Mot. 003396 638.014 Kugellager / Ball Bearing	(38)
				6283 600 539		638.014	
		M111.950		3000 951 784 	240 26	XTend 638.094 Nabenprofil / Hub Profile: 26,5x28,7-26N	(48)
				3182 654 203	HHAS-1	638.094 Immer erneuern / Renew everytime	(30)
		M111.948, M111.950		1863 869 012	28	638.014/094 für Motoren mit Zweimassenschwungrad / for engines with dual-mass flywheel Nadellager / Needle Bearing	(80) (49)
				6284 600 573		638.014/094	

















		CODE				
--	--	------	--	---	---	---

MERCEDES-BENZ

VITO Kasten / Box (638) 03.97 - 07.03

108 CDI 2.2 (638.094) 110 CDI 2.2 (638.094) 112 CDI 2.2 (638.094)	03.99-07.03	OM611A (60KWCDI), OM611.980, OM611LA(75 KWCDI)	 3000 951 784  240 26	XTend Nabenprofil / Hub Profile: 26,5x28,7-26N (48)
			 2294 001 744	240 enthält Schwungradbefestigungsschrauben / includes bolt for flyweel mounting (66)
			 3182 654 203	HHAS-1 Immer erneuern / Renew everytime (30)
			 6284 600 573	
114 2.3 (638.034, 638.094)	03.97-07.03	M111.978	 3000 846 501	240 26 638.034
			 3082 268 031	M240
			 1864 464 031	240D
			 3151 248 031	KZIS-0
		 1863 869 010	35 ->Mot. 002723 638.034 Kugellager / Ball Bearing (38)	
		 6283 600 539	638.034	
		M111.980	 3000 951 784  240 26	XTend 638.094 Nabenprofil / Hub Profile: 26,5x28,7-26N (48)
			 3182 654 203	HHAS-1 638.094 Immer erneuern / Renew everytime (30)
M111.978, M111.980	 1863 869 012	28 638.034/094 für Motoren mit Zweimassenschwungrad / for engines with dual-mass flywheel Nadellager / Needle Bearing (80)		
	 6284 600 573	638.034/094 (49)		
108 D 2.3 (638.064)	03.97-07.03	OM601.942	 3000 951 205	228 26 Torsionsgefederte Kupplungsscheibe / torsion damper clutch disc (61)
			 3082 267 233	M228X
			 1878 005 187	228VTB
			 3151 248 031	KZIS-0
 1863 869 010	35 Kugellager / Ball Bearing (38)			
 6283 600 539				
 6284 600 573				
110 D 2.3 (638.074)	03.97-07.03	OM601.970	 3000 846 501	240 26
			 3082 268 031	M240
			 1864 464 031	240D
			 3151 248 031	KZIS-0
 1863 869 010	35 Kugellager / Ball Bearing (38)			
 6283 600 539				
 6284 600 573				























VITO Kasten / Box (639) 09.03 -

109 CDI, 65 kW 109 CDI, 70 kW	09.03- 08.06-	OM646.980, OM646.983, OM646.981	 3000 970 079  240 26	XTend Torsionsgefederte Kupplungsscheibe / torsion damper clutch disc (61)
			 2294 000 834 	240 enthält Schwungradbefestigungsschrauben / includes bolt for flyweel mounting (66)
			 3182 654 192 	HHAS-1 Immer erneuern / Renew everytime (30)
			 6284 605 008 	
110 CDI 113 CDI 113 CDI 4x4	09.10- 09.10- 09.10-	OM651.940	 3000 990 287 	240
			 2294 000 994 	240 enthält Schwungradbefestigungsschrauben / includes bolt for flyweel mounting (66)
			 6284 605 008 	
		OM651	 2290 601 081 	240 26 ZMS Modul XTend plus CSC Montageart: nicht vormontiert / Mounting Type: not pre-mounted (46) Beinhaltet ZMS, Kupplungsdruckplatte, Kupplungsscheibe und CSC / Contains twin-mass flywheel, clutch cover assembly, clutch disc and CSC (11) enthält Schwungradbefestigungsschrauben / includes bolt for flyweel mounting (66)





		CODE				
--	--	------	--	---	---	---

MERCEDES-BENZ





VITO Kasten / Box (639) 09.03 -

111 CDI, 80 kW	09.03-	OM646.982		3000 970 079 	240 26	XTend Torsionsgefederte Kupplungsscheibe / torsion damper clutch disc	(61)
				3182 654 192 	HHAS-1	Immer erneuern / Renew everytime	(30)
				2294 000 834 	240	enthält Schwungradbefestigungsschrauben / includes bolt for flywheel mounting	(66)
				6284 605 008 			
		OM646DE22LA		3000 951 112 	240 26	XTend -> Chass. 152223 -> 05.2005 Getr. / GBox: 716.652 (SG-S370) 639.601/603/605 Nabenprofil / Hub Profile: 26,6x28,9-26N	(48)
				3000 951 112 	240 26	XTend Chass. 152224-> 05.2005-> 639.601/603/605 Nabenprofil / Hub Profile: 26,6x28,9-26N	(48)
111 CDI 4x4 111 CDI, 85 kW 115 CDI 115 CDI 4x4	09.07 - 09.07 - 09.03 - 07.06 -	OM646.980, OM646.982		3000 970 079 	240 26	XTend Torsionsgefederte Kupplungsscheibe / torsion damper clutch disc	(61)
				3182 654 192 	HHAS-1	Immer erneuern / Renew everytime	(30)
				2294 000 834 	240	enthält Schwungradbefestigungsschrauben / includes bolt for flywheel mounting	(66)
				6284 605 008 			
		OM646DE22LA		3000 951 112 	240 26	XTend 639.601/603/605 Nabenprofil / Hub Profile: 26,6x28,9-26N	(48)





VITO Kasten (W447) 10.14 -

109 CDI (447.601, 447.603, 447.605)	10.14 -	OM622.951		3000 950 932 	240 26	XTend Nabenprofil / Hub Profile: 26,60x28,89-26N	(48)
111 CDI (447.601, 447.603, 447.605)	10.14 -						
114 CDI (447.601, 447.603, 447.605)	10.14 -	OM651.950		3182 654 192 	HHAS-1	Immer erneuern / Renew everytime	(30)
114 CDI 4x4 (447.601, 447.603, 447.605)	07.15 -						
116 CDI (447.601, 447.603, 447.605)	10.14 -						
116 CDI 4x4 (447.601, 447.603, 447.605)	07.15 -						
119 CDI / BlueTEC (447.601, 447.603, 447.605)	10.14 -						
119 CDI / BlueTEC 4x4 (447.601, 447.603, 447.605)	07.15 -						

VITO Mixto (W447) 10.14 -











109 CDI (447.701, 447.703, 447.705)	10.14 -	OM622.951		3000 950 932 	240 26	XTend Nabenprofil / Hub Profile: 26,60x28,89-26N	(48)
111 CDI (447.701, 447.703, 447.705)	10.14 -						
114 CDI (447.701, 447.703, 447.705)	10.14 -	OM651.950		3182 654 192 	HHAS-1	Immer erneuern / Renew everytime	(30)
114 CDI 4x4 (447.701, 447.703, 447.705)	07.15 -						
116 CDI (447.701, 447.703, 447.705)	10.14 -						
116 CDI 4x4 (447.701, 447.703, 447.705)	07.15 -						
119 BlueTEC (447.701, 447.703, 447.705)	10.14 -						
119 BlueTEC 4x4 (447.701, 447.703, 447.705)	12.14 -						

MERCEDES-BENZ

ACTROS 1824 - 1863		04.96 -					
1824 L 963.004 963.003	07.11-	OM936	 3400 700 639 	395 18	Euro 6 / Euro 6		(18)
1824 LS 963.406 963.404 963.403	07.11-		 3400 700 546 	395 18	XTend Getr. / GBox: Powershift Nabenprofil / Hub Profile: 36x40-18N Euro 6 / Euro 6 Nur zusammen verbauen / Only install together		(48) (18) (53)
1827 L 963.003/004	07.11-						
1827 LS 963.403 963.406	07.11-		 6482 000 219	PHIS-5/34	Getr. / GBox: Powershift Euro 6 / Euro 6 Immer erneuern / Renew everytime		(18) (30)
1830 L 963.004 963.003	07.11-						
1830 LS 963.406 963.403	07.11-						



























		CODE				
--	--	------	--	---	---	---

MERCEDES-BENZ

































ACTROS 1824 - 1863		04.96 -				
1831 AK 952.072/073	04.97 - 10.02	OM541		3400 122 801 ⊕ ⊗ 3483 030 032 ⊗ 1878 007 072	430 18 MFZ430 430WGTZ	für Fahrzeuge mit Einscheibenkupplung / for vehicles with single disc clutch (72)
1831 AK 932.072/073	04.03-					
1831 K 952.002/003	04.97 - 10.02			3400 700 446 ⊕ ⊗ 3483 000 258 ⊗ 1878 007 072	430 18 MFZ430 430WGTZ	für / for: SA 504682-22/24 für Fahrzeuge mit Einscheibenkupplung / for vehicles with single disc clutch (72)
1831 K 932.002/003	04.03-			3400 700 416 ⊕ ⊗ 3483 000 139 ⊗ 1878 007 072	430 18 GMFZ430N 430WGTZ	für Nebenantrieb / for PTO für Fahrzeuge mit Einscheibenkupplung / for vehicles with single disc clutch (82)
1831 S, 1831 LS 954.002/003 954.032/033 954.042 954.062 954.053	04.96 - 10.02			3488 000 102 ⊕	400 GMFZ2/ 400N	für Nebenantrieb / for PTO für Fahrzeuge mit Zweis Scheibenkupplung / for vehicles with double disc clutch enthält eine Kupplungsscheibe / This part number includes one clutch disc (82)
1831, 1831 L 950.031 950.038 950.044 950.008 950.034 950.037 950.046 950.036 950.057 950.005/006 950.003 950.035 950.004 950.032 950.047 950.056 950.007 950.033	04.96 - 10.02					(67)
1832 AK 932.073 932.072	04.03-			1878 002 024 ▽	400 18 400WGTZ	für Nebenantrieb / for PTO für Fahrzeuge mit Zweis Scheibenkupplung / for vehicles with double disc clutch Lose Kupplungsscheibe / Loose clutch disc (41)
1832 K 932.002/003	04.03-			3400 121 501 (M) ⊕ ⊗ 3488 023 031 ⊗ 1878 002 024	400 18 MFZ2/400X 400WGTZ	Nabenprofil / Hub Profile: 45x50-18N für Fahrzeuge mit Zweis Scheibenkupplung / for vehicles with double disc clutch (48)
1832, L, LL 930.003 930.007 930.057 930.008 930.031 930.047 930.044 930.035 930.005/006 930.033/034 930.037/038 930.056 930.032 930.004 930.036 930.046	04.03-			3400 700 355 (H) ⊕ ⊗ 3488 000 158 ⊗ 1878 002 019	400 18 MFZ2/400X 400WGTZ	Getr. / GBox: Powershift für Fahrzeuge mit Zweis Scheibenkupplung / for vehicles with double disc clutch (77)
1832, LS, LLS 934.042 934.053 934.031-033 934.062	04.03-			1863 869 028		
1835 AK 952.073	04.97 - 10.02			6284 605 065		Füllmedium: Mineralöl / Fill Medium: Mineral Oil (26)
1835 AK 932.073 932.072	04.03-			6284 605 064		Füllmedium: Bremsflüssigkeit / Fill Medium: Brake Fluid (25)
1835 K 952.003	04.97 - 10.02			3189 600 058		für Nebenantrieb / for PTO (82)
1835 K 932.003 932.002	04.03-			3189 600 057		
1835 S, 1835 LS 954.003 954.042 954.033 954.053 954.062 954.032 954.002	04.96 - 10.02					
1835, 1835 L 950.003 950.033 950.035 950.038 950.044 950.004 950.032 950.037 950.006 950.046/047 950.056 950.005 950.007 950.034 950.036 950.031 950.057 950.008	04.96 - 10.02					
1836 A 930.083	10.02-					
1836 AK 932.073 932.072	04.03-					
1836 K 932.003 932.002	04.03-					
1836 LS, LLS 934.031 934.033 934.062 934.032 934.042 934.053	04.03-					
1836, L, LL 930.047 930.056 930.044 930.037 930.034/035 930.004 930.003 930.005 930.008 930.038 930.007 930.036 930.057 930.006 930.031-033 930.046	04.03-					
1840 AK 952.073	04.97 - 10.02					
1840 AK 932.073 932.072	04.03-					
1840 K 952.003	04.97 - 10.02					
1840 K 932.003 932.002	04.03-					
1840 S, 1840 LS 954.042 954.062 954.032/033 954.002/003 954.053	04.96 - 10.02					
1840, 1840 L 950.035-037 950.047 950.004 950.056 950.006 950.032 950.034 950.031 950.057 950.044 950.046 950.007	04.96 - 10.02					
1841 AK 932.072/073	04.03-					
1841 K 932.003 932.002	04.03-					

		CODE				
--	--	------	--	---	---	---

MERCEDES-BENZ















ACTROS 1824 - 1863		04.96 -					
1841 LS, LLS 934.033 934.053 934.031/032 934.062 1841, L, LL 930.006/007 930.031/032 930.044 930.008 930.047 930.056 930.034/035 930.003 930.038 930.036 930.046 930.057 930.037 930.005 930.033 930.004 1843 AK 952.073 1843 K 952.003 1843 S, 1843 LS 954.032 954.053 954.062 954.003 954.042 954.002 954.033 1843, 1843 L 950.006 950.056 950.036 950.004 950.032 950.034 950.047 950.057 950.035 950.044 950.046 1844 AK 932.072/073 1844 K 932.003 932.002 1844 LS, LLS 934.053 934.062 934.031 934.033 934.032 934.042 1844, L, LL 930.032/033 930.037 930.047 930.008 930.034 930.036 930.038 930.006 930.046 930.057 930.003 930.005 930.044 930.056 930.004 930.007 930.031 930.035 1846 AK 952.073 1846 AK 932.072/073 1846 K 932.003 932.002 1846 LS, LLS 934.033 934.032 934.031 934.053 934.062 934.042 1846 S, 1846 LS 954.002 954.053 954.042 954.003 954.033 954.032 954.062 1846, L, LL 930.003 930.006 930.047 930.056 930.032 930.035/036 930.038 930.005 930.033/034 930.037 930.057 930.007 930.044 930.031 930.004 930.008 930.046 1848 AK 932.073 932.072 932.083 1848 K 932.003 932.002 1848, L, LL 930.036 930.033 930.037 930.047 930.046 930.004-008 930.032 930.038 930.044 930.034/035 930.031 930.003 1848, LS, LLS 934.033 934.042 934.053 934.032	04.03-	OM541		3400 122 801 ⊕  3483 030 032  1878 007 072	430 18 MFZ430 430WGTZ	für Fahrzeuge mit Einscheibenkupplung / for vehicles with single disc clutch (72)	
	04.03-			3400 700 446 ⊕  3483 000 258  1878 007 072	430 18 MFZ430 430WGTZ	für / for: SA 504682-22/24 für Fahrzeuge mit Einscheibenkupplung / for vehicles with single disc clutch (69) (72)	
	04.97 - 10.02			3400 700 416 ⊕  3483 000 139  1878 007 072	430 18 GMFZ430N 430WGTZ	für Nebenantrieb / for PTO für Fahrzeuge mit Einscheibenkupplung / for vehicles with single disc clutch (82) (72)	
	04.97 - 10.02			3488 000 102 ⊕	400 GMFZ2/ 400N	für Nebenantrieb / for PTO für Fahrzeuge mit Zweis Scheibenkupplung / for vehicles with double disc clutch enthält eine Kupplungsscheibe / This part number includes one clutch disc (82) (77)	
	04.96 - 10.02			1878 002 024 ▽	400 18 400WGTZ	für Nebenantrieb / for PTO für Fahrzeuge mit Zweis Scheibenkupplung / for vehicles with double disc clutch Lose Kupplungsscheibe / Loose clutch disc (82) (77)	
	04.03-			3400 121 501 ⊕  3488 023 031  1878 002 024	400 18 MFZ2/400X 400WGTZ	Nabenprofil / Hub Profile: 45x50-18N für Fahrzeuge mit Zweis Scheibenkupplung / for vehicles with double disc clutch (48) (77)	
	04.03-			3400 700 355 ⊕  3488 000 158  1878 002 019	400 18 MFZ2/400X 400WGTZ	Getr. / GBox: Powershift für Fahrzeuge mit Zweis Scheibenkupplung / for vehicles with double disc clutch (77)	
	04.03-			1863 869 028			
	04.03-			6284 605 065		Füllmedium: Mineralöl / Fill Medium: Mineral Oil (26)	
	04.03-			6284 605 064		Füllmedium: Bremsflüssigkeit / Fill Medium: Brake Fluid (25)	
	04.97 - 10.03			3189 600 058 3189 600 057		für Nebenantrieb / for PTO (82)	
	04.03-						
	04.03-						
	04.03-						
	10.98-						
	04.03-						
	04.03-						
	04.03-						
	07.11-		OM936		3400 700 532 ⊕  3400 700 530 ⊕	430 18 XTend	Nabenprofil / Hub Profile: 45x50-18N Euro 6 / Euro 6 Nur zusammen verbauen / Only install together (48) (18) (53)
	07.11-				3400 710 070 ⊕	430 18 XTend	Getr. / GBox: Powershift Nabenprofil / Hub Profile: 45x50-18N Euro 6 / Euro 6 Nur zusammen verbauen / Only install together (48) (18) (53)
07.11-		6482 000 218		PHIS-6/38	Getr. / GBox: Powershift Euro 6 / Euro 6 Immer erneuern / Renew everytime (18) (30)		
07.11-							

MERCEDES-BENZ

ACTROS 1824 - 1863		04.96 -					
1833 L 963.004/005 963.003 1833 LS 963.406 963.405 963.403/404 1836 L 963.004 963.003 1836 LS 963.405 963.404 963.403 963.406 1840 L 963.004 963.003 963.005 1840 LS 963.403 963.405/406 963.404 1842 L 963.003 963.005 963.004 1842 LS 963.404 963.406 963.403 1843 L 963.003 963.005 963.004 1843 LS 963.403-406	07.11-	OM470		3400 700 533 	430 18	XTend Nabenprofil / Hub Profile: 45x50-18N Euro 6 / Euro 6 Nur zusammen verbauen / Only install together	(48) (18) (53)
	07.11-			3400 700 531 	430 18	XTend Getr. / GBox: Powershift Nabenprofil / Hub Profile: 45x50-18N Euro 6 / Euro 6 Nur zusammen verbauen / Only install together	(48) (18) (53)
	07.11-			3400 710 071 	430 18	Getr. / GBox: Powershift Nabenprofil / Hub Profile: 45x50-18N Euro 6 / Euro 6 mit automatischer Nachstellung / with automatic adjustment Nur zusammen verbauen / Only install together	(48) (18) (95) (53)
	07.11-			3400 700 542 	430 18	XTend Getr. / GBox: Powershift Nabenprofil / Hub Profile: 45x50-18N Euro 6 / Euro 6 Nur zusammen verbauen / Only install together	(48) (18) (53)
	07.11-			3400 710 074 	430 18	Getr. / GBox: Powershift Nabenprofil / Hub Profile: 45x50-18N Euro 6 / Euro 6 mit automatischer Nachstellung / with automatic adjustment Nur zusammen verbauen / Only install together	(48) (18) (95) (53)
	07.11-			6482 000 218	PHIS-6/38	Getr. / GBox: Powershift Euro 6 / Euro 6 Immer erneuern / Renew everytime	(18) (30)
	07.11-			3400 700 545 		XTend Euro 6 / Euro 6	(18)
	07.11-			3400 700 541 	430 18	XTend Getr. / GBox: Powershift Nabenprofil / Hub Profile: 45x50-18N Euro 6 / Euro 6 Nur zusammen verbauen / Only install together	(48) (18) (53)
	07.11-			3400 710 072 	430 18	Getr. / GBox: Powershift Nabenprofil / Hub Profile: 45x50-18N Euro 6 / Euro 6 mit automatischer Nachstellung / with automatic adjustment Nur zusammen verbauen / Only install together	(48) (18) (95) (53)
	07.11-			3400 700 543 	430 18	XTend Getr. / GBox: Powershift Nabenprofil / Hub Profile: 45x50-18N Euro 6 / Euro 6 Nur zusammen verbauen / Only install together	(48) (18) (53)
				3400 710 075 	430 18	Getr. / GBox: Powershift Nabenprofil / Hub Profile: 45x50-18N Euro 6 / Euro 6 mit automatischer Nachstellung / with automatic adjustment Nur zusammen verbauen / Only install together	(48) (18) (95) (53)
				6482 000 218	PHIS-6/38	Getr. / GBox: Powershift Euro 6 / Euro 6 Immer erneuern / Renew everytime	(18) (30)
1845 L 963.005 963.004 963.003 1845 LS 963.405 963.403/404 963.406 1848 L 963.004 963.003 963.005 1848 LS 963.403 963.406 963.405 963.404	07.11-	OM470		3400 700 545 		XTend Euro 6 / Euro 6	(18)
	07.11-			3400 700 541 	430 18	XTend Getr. / GBox: Powershift Nabenprofil / Hub Profile: 45x50-18N Euro 6 / Euro 6 Nur zusammen verbauen / Only install together	(48) (18) (53)
	07.11-			3400 710 072 	430 18	Getr. / GBox: Powershift Nabenprofil / Hub Profile: 45x50-18N Euro 6 / Euro 6 mit automatischer Nachstellung / with automatic adjustment Nur zusammen verbauen / Only install together	(48) (18) (95) (53)
	07.11-			3400 700 543 	430 18	XTend Getr. / GBox: Powershift Nabenprofil / Hub Profile: 45x50-18N Euro 6 / Euro 6 Nur zusammen verbauen / Only install together	(48) (18) (53)
	07.11-			3400 710 075 	430 18	Getr. / GBox: Powershift Nabenprofil / Hub Profile: 45x50-18N Euro 6 / Euro 6 mit automatischer Nachstellung / with automatic adjustment Nur zusammen verbauen / Only install together	(48) (18) (95) (53)
	07.11-			6482 000 218	PHIS-6/38	Getr. / GBox: Powershift Euro 6 / Euro 6 Immer erneuern / Renew everytime	(18) (30)















		CODE				
--	--	------	--	---	---	---

MERCEDES-BENZ

ACTROS 1824 - 1863		04.96 -				
1848 AK 952.073	04.97 - 10.02	OM542	 3400 700 415 ⊕ ⊗ 3483 030 032 ⊗ 1878 002 732	430 18 MFZ430 430WGTZ	für Fahrzeuge mit Einscheibenkupplung / for vehicles with single disc clutch	(72)
1848 AK 932.073	04.03 -		 3400 121 501 ⊕ ⊗ ⊗ 3488 023 031 ⊗ 1878 002 024	400 18 MFZ2/400X 400WGTZ	Nabenprofil / Hub Profile: 45x50-18N für Fahrzeuge mit Zweis Scheibenkupplung / for vehicles with double disc clutch	(48) (77)
1848 K 952.003	04.97 - 10.02		 3400 700 355 ⊕ ⊗ ⊗ 3488 000 158 ⊗ 1878 002 019	400 18 MFZ2/400X 400WGTZ	Getr. / GBox: Powershift für Fahrzeuge mit Zweis Scheibenkupplung / for vehicles with double disc clutch	(77)
1848 K 932.002/003	04.03 -		 3488 000 102 ⊕	400 GMFZ2/ 400N	für Nebenantrieb / for PTO für Fahrzeuge mit Zweis Scheibenkupplung / for vehicles with double disc clutch enthält eine Kupplungsscheibe / This part number includes one clutch disc	(82) (77) (67)
1848 S, 1848 LS 954.033 954.003 954.032 954.002	04.96 - 10.02		 1878 002 024 ▽	400 18 400WGTZ	für Nebenantrieb / for PTO für Fahrzeuge mit Zweis Scheibenkupplung / for vehicles with double disc clutch Lose Kupplungsscheibe / Loose clutch disc	(82) (77) (41)
1848 S, LS 934.033 934.032	04.03 -		 1863 869 028		Füllmedium: Mineralöl / Fill Medium: Mineral Oil	(26)
1848, 1848 L 950.034 950.032 950.004 950.006 950.036	04.96 - 10.02		 6284 605 065 6284 605 064		Füllmedium: Bremsflüssigkeit / Fill Medium: Brake Fluid	(25)
1848, L, LL 930.004 930.036 930.032 930.034	04.03 -		 3189 600 058 3189 600 057		für Nebenantrieb / for PTO	(82)
1850 AK 952.073	10.97 -					
1850 AK, 1851 AK 932.073	04.03 -					
1850, 1851 K 932.003	04.03 -					
1850, 1851 LS, LLS 934.033 934.032	04.03 -					
1850, 1851, L, LL 930.034 930.004 930.032 930.036	04.03 -					
1853 S, 1853 LS 954.032/033 954.002/003	04.96 - 10.02					
1853, 1853 L 950.006 950.032 950.034 950.036 950.004	04.96 - 10.02					
1854 LS 934.032/033	04.03 -					
1854, L 930.034 930.036 930.032 930.004	04.03 -					
1851 L 963.004 963.003	07.11 -	OM471	 3400 700 534 ⊕ ⊗	430 18	XTend Nabenprofil / Hub Profile: 45x50-18N Euro 6 / Euro 6 max. übertragbares Motormoment [Nm] / max. transmittable engine torque [Nm]: 2600 Nur zusammen verbauen / Only install together	(48) (18) (87) (53)
1851 LS 963.406 963.403/404	07.11 -		 3400 700 529 ⊕ ⊗	430 18	XTend Getr. / GBox: Powershift Nabenprofil / Hub Profile: 45x50-18N Euro 6 / Euro 6 Nur zusammen verbauen / Only install together	(48) (18) (53)
1852 L 963.003	01.14 -		 3400 710 073 ⊗	430 18	Getr. / GBox: Powershift Nabenprofil / Hub Profile: 45x50-18N Euro 6 / Euro 6 mit automatischer Nachstellung / with automatic adjustment Nur zusammen verbauen / Only install together	(48) (18) (95) (53)
1852 LS	01.14 -		 3400 700 544 ⊕ ⊗	430 18	XTend Getr. / GBox: Powershift Nabenprofil / Hub Profile: 45x50-18N Euro 6 / Euro 6 Nur zusammen verbauen / Only install together	(48) (18) (53)
			 3400 710 076 ⊕ ⊗	430 18	Getr. / GBox: Powershift Nabenprofil / Hub Profile: 45x50-18N Euro 6 / Euro 6 mit automatischer Nachstellung / with automatic adjustment Nur zusammen verbauen / Only install together	(48) (18) (95) (53)
			 6482 000 218	PHIS-6/38	Getr. / GBox: Powershift Euro 6 / Euro 6 Immer erneuern / Renew everytime	(18) (30)











		CODE				
--	--	------	--	---	---	---

MERCEDES-BENZ





















ACTROS 1824 - 1863		04.96 -				
1857 L 950.034 1857 LS 954.032/033 1858 LS 934.032 1858, L 930.034 1860 L, LL 930.034 1860 LS 934.033 934.032 1861 LS 934.032	04.97 - 10.02	OM542		3400 700 468 ⊕ ⊗ 3483 000 422 ⊗ 1878 006 101	430 18 MFZ430 430WGTZ	für Fahrzeuge mit Einscheibenkupplung / for vehicles with single disc clutch (72)
	04.97 - 10.02			3400 121 501 ⊕⊗ ⊗ 3488 023 031 ⊗ 1878 002 024	400 18 MFZ2/400X 400WGTZ	Nabenprofil / Hub Profile: 45x50-18N für Fahrzeuge mit Zweischeibenkupplung / for vehicles with double disc clutch (48) (77)
	10.02 -			3400 700 355 ⊕⊗ ⊗ 3488 000 158 ⊗ 1878 002 019	400 18 MFZ2/400X 400WGTZ	Getr. / GBox: Powershift für Fahrzeuge mit Zweischeibenkupplung / for vehicles with double disc clutch (77)
	04.03 -			3488 000 102 ⊕	400 GMFZ2/ 400N	für Nebenantrieb / for PTO für Fahrzeuge mit Zweischeibenkupplung / for vehicles with double disc clutch enthält eine Kupplungsscheibe / This part number includes one clutch disc (82) (77)
	05.05 -			1878 002 024 ▽	400 18 400WGTZ	für Nebenantrieb / for PTO für Fahrzeuge mit Zweischeibenkupplung / for vehicles with double disc clutch Lose Kupplungsscheibe / Loose clutch disc (82) (77) (41)
	06.08 -			1863 869 028		Füllmedium: Mineralöl / Fill Medium: Mineral Oil (26)
	05.05 -			6284 605 065 6284 605 064		Füllmedium: Bremsflüssigkeit / Fill Medium: Brake Fluid (25)
				3189 600 058 3189 600 057		für Nebenantrieb / for PTO (82)
1858 L 963.003 1858 LS 963.403 1863 L 963.003 1863 LS 963.403	01.14 -	OM473		3400 700 609 ⊕ ⊗ 3488 000 366 ⊗ 1878 007 185 ⊕ 3151 001 083	400 18 MFZ2/400X 400WGTZ KZISZ-5	Euro 6 / Euro 6 (18)
	01.14 -			3400 700 535 ⊕	400 MF2/400E	XTend Getr. / GBox: Powershift Euro 6 / Euro 6 Nur zusammen verbauen / Only install together (18) (53)
	01.14 -			6482 000 218	PHIS-6/38	Getr. / GBox: Powershift Euro 6 / Euro 6 Immer erneuern / Renew everytime (18) (30)
ACTROS 2024 - 2055		04.96 -				
2024 L 963.002 2024 LS 963.402 2027 L 963.002 2027 LS 963.402 2030 L 963.002 2030 LS 963.402	07.11 -	OM936		3400 700 639 ⊕	395 18	Euro 6 / Euro 6 (18)
	07.11 -			3400 700 546 ⊕	395 18	XTend Getr. / GBox: Powershift Nabenprofil / Hub Profile: 36x40-18N Euro 6 / Euro 6 Nur zusammen verbauen / Only install together (48) (18) (53)
	07.11 -			6482 000 219	PHIS-5/34	Getr. / GBox: Powershift Euro 6 / Euro 6 Immer erneuern / Renew everytime (18) (30)
	07.11 -					
	07.11 -					

		CODE				
--	--	------	--	---	---	---

MERCEDES-BENZ























ACTROS 2024 - 2055		04.96 -				
2031 950.016 950.013/014	04.97 - 10.02	OM541	 3400 122 801 ⊕ ⊗ 3483 030 032 ⊗ 1878 007 072	430 18 MFZ430 430WGTZ	für Fahrzeuge mit Einscheibenkupplung / for vehicles with single disc clutch	(72)
2031 A 950.083	04.97 - 10.02		 3400 700 446 ⊕ ⊗ 3483 000 258 ⊗ 1878 007 072	430 18 MFZ430 430WGTZ	für / for: SA 504682-22/24 für Fahrzeuge mit Einscheibenkupplung / for vehicles with single disc clutch	(69) (72)
2031 AK 952.083	09.96 - 10.02		 3400 700 416 ⊕ ⊗ 3483 000 139 ⊗ 1878 007 072	430 18 GMFZ430N 430WGTZ	für Nebenantrieb / for PTO für Fahrzeuge mit Einscheibenkupplung / for vehicles with single disc clutch	(82) (72)
2031 AS 954.082	04.96 - 10.02		 3488 000 102 ⊕	400 GMFZ2/ 400N	für Nebenantrieb / for PTO für Fahrzeuge mit Zweis Scheibenkupplung / for vehicles with double disc clutch enthält eine Kupplungsscheibe / This part number includes one clutch disc	(82) (77) (67)
2031 K 952.013	04.97 - 10.02		 1878 002 024 ▽	400 18 400WGTZ	für Nebenantrieb / for PTO für Fahrzeuge mit Zweis Scheibenkupplung / for vehicles with double disc clutch Lose Kupplungsscheibe / Loose clutch disc	(82) (77) (41)
2031 S 954.012	04.96 - 10.02		 3400 121 501 (M) ⊕ ⊗ 3488 023 031 ⊗ 1878 002 024	400 18 MFZ2/400X 400WGTZ	Nabenprofil / Hub Profile: 45x50-18N für Fahrzeuge mit Zweis Scheibenkupplung / for vehicles with double disc clutch	(48) (77)
2032 930.014 930.016 930.013	04.03 -		 3400 700 355 (H) ⊕ ⊗ 3488 000 158 ⊗ 1878 002 019	400 18 MFZ2/400X 400WGTZ	Getr. / GBox: Powershift für Fahrzeuge mit Zweis Scheibenkupplung / for vehicles with double disc clutch	(77)
2032 A, AE 930.083	04.03 -		 1863 869 028			
2032 AK 932.083	04.03 -		 6284 605 065		Füllmedium: Mineralöl / Fill Medium: Mineral Oil	(26)
2032 AS 934.082	04.03 -		 6284 605 064		Füllmedium: Bremsflüssigkeit / Fill Medium: Brake Fluid	(25)
2032 K 932.013	04.03 -		 3189 600 058		für Nebenantrieb / for PTO	(82)
2032 S 934.012/013	04.03 -		3189 600 057			
2035 A 950.083	04.97 - 10.02					
2035 S 954.012	04.96 - 10.02					
2036 930.013/014 930.016	04.03 -					
2036 A, AE 930.083	04.03 -					
2036 AK 932.083	04.03 -					
2036 AS 934.083 934.082	04.03 -					
2036 K 932.013	04.03 -					
2036 S 934.012/013	04.03 -					
2040 950.014	09.96 - 10.02					
2040 930.014 930.016 930.013	10.02 -					
2040 AK 952.083	09.96 - 10.02					
2040 AS 954.082	04.96 - 10.02					
2040 S 954.012	04.96 - 10.02					
2041 930.014 930.013	04.03 -					
2041 AK 932.083	04.03 -					
2041 AS 934.082	04.03 -					
2041 K 932.013	04.03 -					
2041 S 934.012/013	04.03 -					
2043 AS 954.082	04.96 - 10.02					
2044 930.014 930.013	04.03 -					
2044 AS 934.082	04.03 -					
2044 AK 932.083	04.03 -					
2044 K 932.013	04.03 -					
2044 S 934.013 934.012	04.03 -					

MERCEDES-BENZ

ACTROS 2024 - 2055		04.96 -						
2046 930.014 930.013 2046 AK 932.083 2046 AS 954.082 2046 AS 934.082 2046 K 932.013 2046 S 934.013 934.012 2048 AK 932.083 2048 AS 934.082 2048 K 932.013	04.03-	OM541	 3400 122 801 ⊕ ⊕ 3483 030 032 ⊕ 1878 007 072	430 18 MFZ430 430WGTZ	für Fahrzeuge mit Einscheibenkupplung / for vehicles with single disc clutch	(72)		
	04.03-		 3400 700 446 ⊕ ⊕ 3483 000 258 ⊕ 1878 007 072	430 18 MFZ430 430WGTZ	für / for: SA 504682-22/24 für Fahrzeuge mit Einscheibenkupplung / for vehicles with single disc clutch	(69) (72)		
	10.96-		 3400 700 416 ⊕ ⊕ 3483 000 139 ⊕ 1878 007 072	430 18 GMFZ430N 430WGTZ	für Nebenantrieb / for PTO für Fahrzeuge mit Einscheibenkupplung / for vehicles with single disc clutch	(82) (72)		
	04.03-		 3488 000 102 ⊕	400 GMFZ2/ 400N	für Nebenantrieb / for PTO für Fahrzeuge mit Zweischeibenkupplung / for vehicles with double disc clutch enthält eine Kupplungsscheibe / This part number includes one clutch disc	(82) (77) (67)		
	04.03-		 1878 002 024 ▽	400 18 400WGTZ	für Nebenantrieb / for PTO für Fahrzeuge mit Zweischeibenkupplung / for vehicles with double disc clutch Lose Kupplungsscheibe / Loose clutch disc	(82) (77) (41)		
	04.03-		 3400 121 501 (M) ⊕ ⊕ 3488 023 031 ⊕ 1878 002 024	400 18 MFZ2/400X 400WGTZ	Nabenprofil / Hub Profile: 45x50-18N für Fahrzeuge mit Zweischeibenkupplung / for vehicles with double disc clutch	(48) (77)		
	04.03-		 3400 700 355 (H) ⊕ ⊕ 3488 000 158 ⊕ 1878 002 019	400 18 MFZ2/400X 400WGTZ	Getr. / GBox: Powershift für Fahrzeuge mit Zweischeibenkupplung / for vehicles with double disc clutch	(77)		
	04.03-		 1863 869 028					
	04.03-		 6284 605 065		Füllmedium: Mineralöl / Fill Medium: Mineral Oil	(26)		
	04.03-		 6284 605 064		Füllmedium: Bremsflüssigkeit / Fill Medium: Brake Fluid	(25)		
	04.03-		 3189 600 058 3189 600 057		für Nebenantrieb / for PTO	(82)		
	2032 L 963.002 2032 LS 963.402 2035 L 963.002 2035 LS 963.402		07.11-	OM936	 3400 700 532 (M) ⊕	430 18	XTend Nabenprofil / Hub Profile: 45x50-18N Euro 6 / Euro 6 Nur zusammen verbauen / Only install together	(48) (18) (53)
			07.11-		 3400 700 530 ⊕	430 18	XTend Getr. / GBox: Powershift Nabenprofil / Hub Profile: 45x50-18N Euro 6 / Euro 6 Nur zusammen verbauen / Only install together	(48) (18) (53)
			07.11-		 3400 710 070 ⊕	430 18	Getr. / GBox: Powershift Nabenprofil / Hub Profile: 45x50-18N Euro 6 / Euro 6 mit automatischer Nachstellung / with automatic adjustment Nur zusammen verbauen / Only install together	(48) (18) (95) (53)
07.11-		 6482 000 218	PHIS-6/38		Getr. / GBox: Powershift Euro 6 / Euro 6 Immer erneuern / Renew everytime	(18) (30)		
07.11-		 3400 700 533 (M) ⊕	430 18		XTend Nabenprofil / Hub Profile: 45x50-18N Euro 6 / Euro 6 Nur zusammen verbauen / Only install together	(48) (18) (53)		
2033 L 963.002 2033 LS 963.402 2036 L 963.002 2036 LS 963.402 2040 L 963.002 2040 LS 963.402 2043 L 963.002 2043 LS 963.402	07.11-	OM470	 3400 700 531 ⊕	430 18	XTend Getr. / GBox: Powershift Nabenprofil / Hub Profile: 45x50-18N Euro 6 / Euro 6 Nur zusammen verbauen / Only install together	(48) (18) (53)		
	07.11-		 3400 710 071 ⊕	430 18	Getr. / GBox: Powershift Nabenprofil / Hub Profile: 45x50-18N Euro 6 / Euro 6 mit automatischer Nachstellung / with automatic adjustment Nur zusammen verbauen / Only install together	(48) (18) (95) (53)		
	07.11-		 3400 700 542 ⊕	430 18	XTend Getr. / GBox: Powershift Nabenprofil / Hub Profile: 45x50-18N Euro 6 / Euro 6 Nur zusammen verbauen / Only install together	(48) (18) (53)		
	07.11-		 3400 710 074 ⊕	430 18	Getr. / GBox: Powershift Nabenprofil / Hub Profile: 45x50-18N Euro 6 / Euro 6 mit automatischer Nachstellung / with automatic adjustment Nur zusammen verbauen / Only install together	(48) (18) (95) (53)		
	07.11-		 6482 000 218	PHIS-6/38	Getr. / GBox: Powershift Euro 6 / Euro 6 Immer erneuern / Renew everytime	(18)		
	07.11-							
	07.11-							
	07.11-							

MERCEDES-BENZ

































ACTROS 2024 - 2055 04.96 -

2042 L 963.002 2042 LS 963.402	07.11-	OM471		3400 700 533 	430 18	XTend Nabenprofil / Hub Profile: 45x50-18N Euro 6 / Euro 6 Nur zusammen verbauen / Only install together	(48) (18) (53)
	07.11-			3400 700 531 	430 18	XTend Getr. / GBox: Powershift Nabenprofil / Hub Profile: 45x50-18N Euro 6 / Euro 6 Nur zusammen verbauen / Only install together	(48) (18) (53)
				3400 710 071 	430 18	Getr. / GBox: Powershift Nabenprofil / Hub Profile: 45x50-18N Euro 6 / Euro 6 mit automatischer Nachstellung / with automatic adjustment Nur zusammen verbauen / Only install together	(48) (18) (95) (53)
				3400 700 542 	430 18	XTend Getr. / GBox: Powershift Nabenprofil / Hub Profile: 45x50-18N Euro 6 / Euro 6 Nur zusammen verbauen / Only install together	(48) (18) (53)
				3400 710 074 	430 18	Getr. / GBox: Powershift Nabenprofil / Hub Profile: 45x50-18N Euro 6 / Euro 6 mit automatischer Nachstellung / with automatic adjustment Nur zusammen verbauen / Only install together	(48) (18) (95) (53)
				6482 000 218	PHIS-6/38	Getr. / GBox: Powershift Euro 6 / Euro 6 Immer erneuern / Renew everytime	(18) (30)
2045 L 963.002 2045 LS 963.402 2048 L 963.002 2048 LS 963.402	07.11-	OM471		3400 700 545 		XTend Euro 6 / Euro 6	(18)
	07.11-			3400 700 541 	430 18	XTend Getr. / GBox: Powershift Nabenprofil / Hub Profile: 45x50-18N Euro 6 / Euro 6 Nur zusammen verbauen / Only install together	(48) (18) (53)
				3400 710 072 	430 18	Getr. / GBox: Powershift Nabenprofil / Hub Profile: 45x50-18N Euro 6 / Euro 6 mit automatischer Nachstellung / with automatic adjustment Nur zusammen verbauen / Only install together	(48) (18) (95) (53)
				3400 700 543 	430 18	XTend Getr. / GBox: Powershift Nabenprofil / Hub Profile: 45x50-18N Euro 6 / Euro 6 Nur zusammen verbauen / Only install together	(48) (18) (53)
				3400 710 075 	430 18	Getr. / GBox: Powershift Nabenprofil / Hub Profile: 45x50-18N Euro 6 / Euro 6 mit automatischer Nachstellung / with automatic adjustment Nur zusammen verbauen / Only install together	(48) (18) (95) (53)
				6482 000 218	PHIS-6/38	Getr. / GBox: Powershift Euro 6 / Euro 6 Immer erneuern / Renew everytime	(18) (30)

		CODE				
--	--	------	--	---	---	---

MERCEDES-BENZ

ACTROS 2024 - 2055 04.96 -



























2048 AS 954.082 2048 AS 934.082 2050 AS 954.082 2050 S 934.013 934.012 2051 AS 934.082 2053 S 954.012 2054 S 934.012	04.96 - 10.02	OM542		3400 700 415 ⊕  3483 030 032  1878 002 732	430 18 MFZ430 430WGTZ	für Fahrzeuge mit Einscheibenkupplung / for vehicles with single disc clutch (72)	
	04.03 -			3400 121 501 ⊕  3488 023 031  1878 002 024	400 18 MFZ2/400X 400WGTZ	Nabenprofil / Hub Profile: 45x50-18N für Fahrzeuge mit Zweischeibenkupplung / for vehicles with double disc clutch (48) (77)	
	10.96 -			3400 700 355 ⊕  3488 000 158  1878 002 019	400 18 MFZ2/400X 400WGTZ	Getr. / GBox: Powershift für Fahrzeuge mit Zweischeibenkupplung / for vehicles with double disc clutch (77)	
	04.03 -			3488 000 102 ⊕	400 GMFZ2/ 400N	für Nebenantrieb / for PTO für Fahrzeuge mit Zweischeibenkupplung / for vehicles with double disc clutch enthält eine Kupplungsscheibe / This part number includes one clutch disc (82) (77)	
	04.96 - 10.02			1878 002 024 ▽	400 18 400WGTZ	für Nebenantrieb / for PTO für Fahrzeuge mit Zweischeibenkupplung / for vehicles with double disc clutch Lose Kupplungsscheibe / Loose clutch disc (82) (77) (41)	
	04.03 -			1863 869 028			
				6284 605 065			Füllmedium: Mineralöl / Fill Medium: Mineral Oil (26)
				6284 605 064			Füllmedium: Bremsflüssigkeit / Fill Medium: Brake Fluid (25)
				3189 600 058			für Nebenantrieb / for PTO (82)
				3189 600 057			
2051 L 963.002 2051 LS 963.402	07.11 -	OM471		3400 700 534 ⊕  	430 18	XTend Nabenprofil / Hub Profile: 45x50-18N Euro 6 / Euro 6 max. übertragbares Motormoment [Nm] / max. transmittable engine torque [Nm]: 2600 Nur zusammen verbauen / Only install together (48) (18) (87) (53)	
	07.11 -			3400 700 529 ⊕  	430 18	XTend Getr. / GBox: Powershift Nabenprofil / Hub Profile: 45x50-18N Euro 6 / Euro 6 Nur zusammen verbauen / Only install together (48) (18) (53)	
				3400 710 073 ⊕  	430 18	Getr. / GBox: Powershift Nabenprofil / Hub Profile: 45x50-18N Euro 6 / Euro 6 mit automatischer Nachstellung / with automatic adjustment Nur zusammen verbauen / Only install together (48) (18) (95) (53)	
				3400 700 544 ⊕  	430 18	XTend Getr. / GBox: Powershift Nabenprofil / Hub Profile: 45x50-18N Euro 6 / Euro 6 Nur zusammen verbauen / Only install together (48) (18) (53)	
				3400 710 076 ⊕  	430 18	Getr. / GBox: Powershift Nabenprofil / Hub Profile: 45x50-18N Euro 6 / Euro 6 mit automatischer Nachstellung / with automatic adjustment Nur zusammen verbauen / Only install together (48) (18) (95) (53)	
				6482 000 218	PHIS-6/38	Getr. / GBox: Powershift Euro 6 / Euro 6 Immer erneuern / Renew everytime (18) (30)	

ACTROS 2427 - 2460





















2427 LS 963.427 2430 LS 963.427	07.11 -	OM936		3400 700 639 ⊕ 	395 18	Euro 6 / Euro 6 (18)
	07.11 -			3400 700 546 ⊕  	395 18	XTend Getr. / GBox: Powershift Nabenprofil / Hub Profile: 36x40-18N Euro 6 / Euro 6 Nur zusammen verbauen / Only install together (48) (18) (53)
				6482 000 219	PHIS-5/34	Getr. / GBox: Powershift Euro 6 / Euro 6 Immer erneuern / Renew everytime (18) (30)

		CODE				
--	--	------	--	---	---	---

MERCEDES-BENZ















ACTROS 2427 - 2460								
2432 LS 934.235 2436 LS 934.235 2441 LS 934.235 2444 LS 934.235 2446 LS 934.235 2448 LS 934.235	06.08-	OM541		3400 122 801 ⊕  3483 030 032  1878 007 072	430 18 MFZ430 430WGTZ	für Fahrzeuge mit Einscheibenkupplung / for vehicles with single disc clutch (72)		
	06.08-			3400 700 446 ⊕  3483 000 258  1878 007 072	430 18 MFZ430 430WGTZ	für / for: SA 504682-22/24 für Fahrzeuge mit Einscheibenkupplung / for vehicles with single disc clutch (69) (72)		
	06.08-			3400 700 416 ⊕  3483 000 139  1878 007 072	430 18 GMFZ430N 430WGTZ	für Nebenantrieb / for PTO für Fahrzeuge mit Einscheibenkupplung / for vehicles with single disc clutch (82) (72)		
	06.08-			3488 000 102 ⊕	400 GMFZ2/ 400N	für Nebenantrieb / for PTO für Fahrzeuge mit Zweis Scheibenkupplung / for vehicles with double disc clutch enthält eine Kupplungsscheibe / This part number includes one clutch disc (82) (77)		
	06.08-			1878 002 024 ▽	400 18 400WGTZ	für Nebenantrieb / for PTO für Fahrzeuge mit Zweis Scheibenkupplung / for vehicles with double disc clutch Lose Kupplungsscheibe / Loose clutch disc (82) (77)		
	06.08-			3400 121 501 (M) ⊕  3488 023 031  1878 002 024	400 18 MFZ2/400X 400WGTZ	Nabenprofil / Hub Profile: 45x50-18N für Fahrzeuge mit Zweis Scheibenkupplung / for vehicles with double disc clutch (48) (77)		
	06.08-			3400 700 355 (H) ⊕  3488 000 158  1878 002 019	400 18 MFZ2/400X 400WGTZ	Getr. / GBox: Powershift für Fahrzeuge mit Zweis Scheibenkupplung / for vehicles with double disc clutch (77)		
				1863 869 028				
				6284 605 065			Füllmedium: Mineralöl / Fill Medium: Mineral Oil (26)	
				6284 605 064			Füllmedium: Bremsflüssigkeit / Fill Medium: Brake Fluid (25)	
				3189 600 057				
				3189 600 058			für Nebenantrieb / for PTO (82)	
	2432 LS 963.427 2435 LS 963.427		07.11-	OM936		3400 700 532 (M) ⊕	430 18	XTend Nabenprofil / Hub Profile: 45x50-18N Euro 6 / Euro 6 Nur zusammen verbauen / Only install together (48) (18) (53)
			07.11-			3400 700 530 ⊕	430 18	XTend Getr. / GBox: Powershift Nabenprofil / Hub Profile: 45x50-18N Euro 6 / Euro 6 Nur zusammen verbauen / Only install together (48) (18) (53)
			3400 710 070 ⊕		430 18	Getr. / GBox: Powershift Nabenprofil / Hub Profile: 45x50-18N Euro 6 / Euro 6 mit automatischer Nachstellung / with automatic adjustment Nur zusammen verbauen / Only install together (48) (18) (95) (53)		
			6482 000 218		PHIS-6/38	Getr. / GBox: Powershift Euro 6 / Euro 6 Immer erneuern / Renew everytime (18) (30)		
2433 LS 963.427 2436 LS 963.427 2440 LS 963.427 2443 LS 963.427	07.11-	OM470		3400 700 533 (M) ⊕	430 18	XTend Nabenprofil / Hub Profile: 45x50-18N Euro 6 / Euro 6 Nur zusammen verbauen / Only install together (48) (18) (53)		
	07.11-			3400 700 531 ⊕	430 18	XTend Getr. / GBox: Powershift Nabenprofil / Hub Profile: 45x50-18N Euro 6 / Euro 6 Nur zusammen verbauen / Only install together (48) (18) (53)		
	07.11-			3400 710 071 ⊕	430 18	Getr. / GBox: Powershift Nabenprofil / Hub Profile: 45x50-18N Euro 6 / Euro 6 mit automatischer Nachstellung / with automatic adjustment Nur zusammen verbauen / Only install together (48) (18) (95) (53)		
	07.11-			3400 700 542 ⊕	430 18	XTend Getr. / GBox: Powershift Nabenprofil / Hub Profile: 45x50-18N Euro 6 / Euro 6 Nur zusammen verbauen / Only install together (48) (18) (53)		
				3400 710 074 ⊕	430 18	Getr. / GBox: Powershift Nabenprofil / Hub Profile: 45x50-18N Euro 6 / Euro 6 mit automatischer Nachstellung / with automatic adjustment Nur zusammen verbauen / Only install together (48) (18) (95) (53)		
				6482 000 218	PHIS-6/38	Getr. / GBox: Powershift Euro 6 / Euro 6 Immer erneuern / Renew everytime (18)		

MERCEDES-BENZ

ACTROS 2427 - 2460							
2442 LS 963.427	07.11-	OM471		3400 700 533 	430 18	XTend Nabenprofil / Hub Profile: 45x50-18N Euro 6 / Euro 6 Nur zusammen verbauen / Only install together	(48) (18) (53)
				3400 700 531 	430 18	XTend Getr. / GBox: Powershift Nabenprofil / Hub Profile: 45x50-18N Euro 6 / Euro 6 Nur zusammen verbauen / Only install together	(48) (18) (53)
				3400 710 071 	430 18	Getr. / GBox: Powershift Nabenprofil / Hub Profile: 45x50-18N Euro 6 / Euro 6 mit automatischer Nachstellung / with automatic adjustment Nur zusammen verbauen / Only install together	(48) (18) (95) (53)
				3400 700 542 	430 18	XTend Getr. / GBox: Powershift Nabenprofil / Hub Profile: 45x50-18N Euro 6 / Euro 6 Nur zusammen verbauen / Only install together	(48) (18) (53)
				3400 710 074 	430 18	Getr. / GBox: Powershift Nabenprofil / Hub Profile: 45x50-18N Euro 6 / Euro 6 mit automatischer Nachstellung / with automatic adjustment Nur zusammen verbauen / Only install together	(48) (18) (95) (53)
				6482 000 218	PHIS-6/38	Getr. / GBox: Powershift Euro 6 / Euro 6 Immer erneuern / Renew everytime	(18) (30)
2445 LS 963.427 2448 LS 963.427	07.11-	OM471		3400 700 545 		XTend Euro 6 / Euro 6	(18)
				3400 700 541 	430 18	XTend Getr. / GBox: Powershift Nabenprofil / Hub Profile: 45x50-18N Euro 6 / Euro 6 Nur zusammen verbauen / Only install together	(48) (18) (53)
				3400 710 072 	430 18	Getr. / GBox: Powershift Nabenprofil / Hub Profile: 45x50-18N Euro 6 / Euro 6 mit automatischer Nachstellung / with automatic adjustment Nur zusammen verbauen / Only install together	(48) (18) (95) (53)
			3400 700 543 	430 18	XTend Getr. / GBox: Powershift Nabenprofil / Hub Profile: 45x50-18N Euro 6 / Euro 6 Nur zusammen verbauen / Only install together	(48) (18) (53)	
			3400 710 075 	430 18	Getr. / GBox: Powershift Nabenprofil / Hub Profile: 45x50-18N Euro 6 / Euro 6 mit automatischer Nachstellung / with automatic adjustment Nur zusammen verbauen / Only install together	(48) (18) (95) (53)	
			6482 000 218	PHIS-6/38	Getr. / GBox: Powershift Euro 6 / Euro 6 Immer erneuern / Renew everytime	(18) (30)	

















		CODE				
--	--	------	--	---	---	---

MERCEDES-BENZ

ACTROS 2427 - 2460								
2451 LS 2451 LS 934.235 2455 LS 2455 LS 934.235	06.08-	OM542		3400 700 415 ⊕ ⊕ 3483 030 032 ⊕ 1878 002 732	430 18 MFZ430 430WGTZ	für Fahrzeuge mit Einscheibenkupplung / for vehicles with single disc clutch (72)		
	06.08-			3400 121 501 ⊕ ⊕ 3488 023 031 ⊕ 1878 002 024	400 18 MFZ2/400X 400WGTZ	Nabenprofil / Hub Profile: 45x50-18N für Fahrzeuge mit Zweis Scheibenkupplung / for vehicles with double disc clutch (48) (77)		
	06.08-			3400 700 355 ⊕ ⊕ 3488 000 158 ⊕ 1878 002 019	400 18 MFZ2/400X 400WGTZ	Getr. / GBox: Powershift für Fahrzeuge mit Zweis Scheibenkupplung / for vehicles with double disc clutch (77)		
	06.08-			3488 000 102 ⊕	400 GMFZ2/ 400N	für Nebenantrieb / for PTO für Fahrzeuge mit Zweis Scheibenkupplung / for vehicles with double disc clutch enthält eine Kupplungsscheibe / This part number includes one clutch disc (82) (77) (67)		
				1878 002 024 ▽	400 18 400WGTZ	für Nebenantrieb / for PTO für Fahrzeuge mit Zweis Scheibenkupplung / for vehicles with double disc clutch Lose Kupplungsscheibe / Loose clutch disc (82) (77) (41)		
				1863 869 028				
				6284 605 065 6284 605 064			Füllmedium: Mineralöl / Fill Medium: Mineral Oil (26)	Füllmedium: Bremsflüssigkeit / Fill Medium: Brake Fluid (25)
				3189 600 057 3189 600 058				für Nebenantrieb / for PTO (82)
	2451 LS 963.427		07.11-	OM471		3400 700 534 ⊕	430 18	XTend Nabenprofil / Hub Profile: 45x50-18N Euro 6 / Euro 6 max. übertragbares Motormoment [Nm] / max. transmittable engine torque [Nm]: 2600 Nur zusammen verbauen / Only install together (48) (18) (87) (53)
						3400 700 529 ⊕	430 18	XTend Getr. / GBox: Powershift Nabenprofil / Hub Profile: 45x50-18N Euro 6 / Euro 6 Nur zusammen verbauen / Only install together (48) (18) (53)
		3400 710 073 ⊕			430 18	Getr. / GBox: Powershift Nabenprofil / Hub Profile: 45x50-18N Euro 6 / Euro 6 mit automatischer Nachstellung / with automatic adjustment Nur zusammen verbauen / Only install together (48) (18) (95) (53)		
		3400 700 544 ⊕			430 18	XTend Getr. / GBox: Powershift Nabenprofil / Hub Profile: 45x50-18N Euro 6 / Euro 6 Nur zusammen verbauen / Only install together (48) (18) (53)		
		3400 710 076 ⊕			430 18	Getr. / GBox: Powershift Nabenprofil / Hub Profile: 45x50-18N Euro 6 / Euro 6 mit automatischer Nachstellung / with automatic adjustment Nur zusammen verbauen / Only install together (48) (18) (95) (53)		
		6482 000 218			PHIS-6/38	Getr. / GBox: Powershift Euro 6 / Euro 6 Immer erneuern / Renew everytime (18) (30)		

		CODE				
--	--	------	--	---	---	---

MERCEDES-BENZ

ACTROS 2427 - 2460							
2460 LS 2460 LS 934.235	06.08-	OM542		3400 700 468 ⊕  3483 000 422  1878 006 101	430 18 MFZ430 430WGTZ	für Fahrzeuge mit Einscheibenkupplung / for vehicles with single disc clutch (72)	
	06.08-			3400 121 501 ⊕  3488 023 031  1878 002 024	400 18 MFZ2/400X 400WGTZ	Nabenprofil / Hub Profile: 45x50-18N für Fahrzeuge mit Zweis Scheibenkupplung / for vehicles with double disc clutch (48) (77)	
				3400 700 355 ⊕  3488 000 158  1878 002 019	400 18 MFZ2/400X 400WGTZ	Getr. / GBox: Powershift für Fahrzeuge mit Zweis Scheibenkupplung / for vehicles with double disc clutch (77)	
				3488 000 102 ⊕	400 GMFZ2/ 400N	für Nebenantrieb / for PTO für Fahrzeuge mit Zweis Scheibenkupplung / for vehicles with double disc clutch enthält eine Kupplungsscheibe / This part number includes one clutch disc (82) (77)	
				1878 002 024 ▽	400 18 400WGTZ	für Nebenantrieb / for PTO für Fahrzeuge mit Zweis Scheibenkupplung / for vehicles with double disc clutch Lose Kupplungsscheibe / Loose clutch disc (82) (77)	
				1863 869 028			
				6284 605 065 6284 605 064			Füllmedium: Mineralöl / Fill Medium: Mineral Oil (26)
				3189 600 057 3189 600 058			Füllmedium: Bremsflüssigkeit / Fill Medium: Brake Fluid (25)
							für Nebenantrieb / for PTO (82)
	ACTROS 2527 - 2560 06.96 -						
2527 L 963.020/021 2527 LS 963.423 2527 LS 963.420 2530 L 963.020/021 2530 LS 963.423 2530 LS 963.420	07.11-	OM936		3400 700 639 ⊕	395 18	Euro 6 / Euro 6 (18)	
	07.11-			3400 700 546 ⊕	395 18	XTend Getr. / GBox: Powershift Nabenprofil / Hub Profile: 36x40-18N Euro 6 / Euro 6 Nur zusammen verbauen / Only install together (48) (18) (53)	
	07.11-			6482 000 219	PHIS-5/34	Getr. / GBox: Powershift Euro 6 / Euro 6 Immer erneuern / Renew everytime (18) (30)	
	07.11-						
	07.11-						

















		CODE				
--	--	------	--	--	--	--

MERCEDES-BENZ

ACTROS 2527 - 2560		06.96 -				
2531 930.224 930.113 930.215 930.214 930.226 930.114 930.213 930.225		OM541	3400 122 801 ⊕ ⊕ 3483 030 032 ⊕ 1878 007 072	430 18 MFZ430 430WGTZ	für Fahrzeuge mit Einscheibenkupplung / for vehicles with single disc clutch	(72)
2531 930.204 930.202 930.205 930.208 930.203			3400 700 446 ⊕ ⊕ 3483 000 258 ⊕ 1878 007 072	430 18 MFZ430 430WGTZ	für / for: SA 504682-22/24 für Fahrzeuge mit Einscheibenkupplung / for vehicles with single disc clutch	(69) (72)
2531 LS 954.223	09.96 - 10.02		3400 700 416 ⊕ ⊕ 3483 000 139 ⊕ 1878 007 072	430 18 GMFZ430N 430WGTZ	für Nebenantrieb / for PTO für Fahrzeuge mit Einscheibenkupplung / for vehicles with single disc clutch	(82) (72)
2531, 2531 L 950.225 950.203-205 950.226 950.114 950.208 950.224	09.96 - 10.02		3488 000 102 ⊕	400 GMFZ2/ 400N	für Nebenantrieb / for PTO für Fahrzeuge mit Zweiseibenkupplung / for vehicles with double disc clutch enthält eine Kupplungsscheibe / This part number includes one clutch disc	(82) (77) (67)
2531, 2531 L 950.203/204 950.224 950.226 950.225 950.114 950.205 950.208	09.96 - 10.02		1878 002 024 ▽	400 18 400WGTZ	für Nebenantrieb / for PTO für Fahrzeuge mit Zweiseibenkupplung / for vehicles with double disc clutch Lose Kupplungsscheibe / Loose clutch disc	(82) (77) (41)
2532 L 930.206 930.201	01.03 -		3400 121 501 ⊕ ⊕ 3488 023 031 ⊕ 1878 002 024	400 18 MFZ2/400X 400WGTZ	Nabenprofil / Hub Profile: 45x50-18N für Fahrzeuge mit Zweiseibenkupplung / for vehicles with double disc clutch	(48) (77)
2532 LS 934.233 934.223	04.03 -		3400 700 355 ⊕ ⊕ 3488 000 158 ⊕ 1878 002 019	400 18 MFZ2/400X 400WGTZ	Getr. / GBox: Powershift für Fahrzeuge mit Zweiseibenkupplung / for vehicles with double disc clutch	(77)
2532, L, LL 930.214/215 930.223 930.113 930.206 930.224 930.203 930.225/226 930.208 930.218 930.213 930.201 930.114 930.202 930.204/205	04.03 -		1863 869 028			
2532 L, LL 930.201 930.206 930.225 930.204 930.214 930.213 930.202 930.223 930.113 930.203 930.114 930.205 930.208 930.215 930.224 930.226 930.218	04.03 -		6284 605 065		Füllmedium: Mineralöl / Fill Medium: Mineral Oil	(26)
2532 LS 950.224 950.214 950.218 950.203/204 950.213 950.205 950.223 950.225/226 950.208	09.96 - 10.02		6284 605 064		Füllmedium: Bremsflüssigkeit / Fill Medium: Brake Fluid	(25)
2532 L 950.225 950.214 950.203-205 950.226 950.208 950.218 950.223/224 950.213	09.96 - 10.02		3189 600 058		für Nebenantrieb / for PTO	(82)
2532 LS 954.223 954.233	09.96 - 10.02		3189 600 057			
2532, L, LL 930.114 930.218 930.225/226 930.204 930.214 930.201 930.208 930.224 930.223 930.202 930.213 930.206 930.113 930.205 930.215 930.203	04.03 -					
2532, L, LL 930.208 930.113 930.203 930.225 930.114 930.205 930.223 930.204 930.206 930.213 930.226 930.215 930.218 930.224 930.214 930.201/202	04.03 -					
2540 LS 954.223 954.233	09.96 - 10.02					
2540, 2540 L 950.114 950.218 950.203-205 950.213 950.208 950.214 950.113	09.96 - 10.02					
2541 L 930.201 930.206	01.03 -					
2541 LS 934.233 934.223	04.03 -					
2541 LS 934.233 934.223	06.08 -					
2541, L, LL 930.201 930.224 930.114 930.213 930.225 930.206 930.208 930.205 930.214/215 930.204 930.113 930.202 930.218 930.226 930.223 930.203	04.03 -					
2541, L, LL 930.225 930.204 930.214 930.205 930.218 930.201 930.223/224 930.113 930.208 930.213 930.206 930.203 930.114 930.202 930.215 930.226	04.03 -					
2543 LS 954.223 954.233	09.96 - 10.02					
2543, 2543 L 950.204 950.203 950.205 950.208 950.114 950.213 950.113 950.214	09.96 - 10.02					
2544 L 930.201 930.206	01.03 -					
2544 LS 934.223 934.233	04.03 -					















		CODE				
--	--	------	--	---	---	---

MERCEDES-BENZ

ACTROS 2527 - 2560		06.96 -					
2544 LS 934.233 934.223	04.03-	OM541	 3400 122 801 ⊕ ⊗ 3483 030 032 ⊗ 1878 007 072	430 18 MFZ430 430WGTZ	für Fahrzeuge mit Einscheibenkupplung / for vehicles with single disc clutch	(72)	
2544 LS	06.08-		 3400 700 446 ⊕ ⊗ 3483 000 258 ⊗ 1878 007 072	430 18 MFZ430 430WGTZ	für / for: SA 504682-22/24 für Fahrzeuge mit Einscheibenkupplung / for vehicles with single disc clutch	(69) (72)	
2544, L, LL 930.213 930.204/205 930.214 930.218 930.202 930.215 930.201 930.206 930.114 930.203 930.208 930.113	04.03-		 3400 700 416 ⊕ ⊗ 3483 000 139 ⊗ 1878 007 072	430 18 GMFZ430N 430WGTZ	für Nebenantrieb / for PTO für Fahrzeuge mit Einscheibenkupplung / for vehicles with single disc clutch	(82) (72)	
2544, L, LL 930.213 930.218 930.204 930.206 930.113 930.201 930.203 930.208 930.214 930.114 930.205 930.215 930.202	04.03-		 3488 000 102 ⊕	400 GMFZ2/ 400N	für Nebenantrieb / for PTO für Fahrzeuge mit Zweis Scheibenkupplung / for vehicles with double disc clutch enthält eine Kupplungsscheibe / This part number includes one clutch disc	(82) (77) (67)	
2546 L 930.201 930.206	01.03-		 1878 002 024 ▽	400 18 400WGTZ	für Nebenantrieb / for PTO für Fahrzeuge mit Zweis Scheibenkupplung / for vehicles with double disc clutch Lose Kupplungsscheibe / Loose clutch disc	(82) (77) (41)	
2546 LS 954.223	10.97-		 3400 121 501 ⊕ ⊗ 3488 023 031 ⊗ 1878 002 024	400 18 MFZ2/400X 400WGTZ	Nabenprofil / Hub Profile: 45x50-18N für Fahrzeuge mit Zweis Scheibenkupplung / for vehicles with double disc clutch	(48) (77)	
2546 LS 934.223 934.223	04.03-		 3400 700 355 ⊕ ⊗ 3488 000 158 ⊗ 1878 002 019	400 18 MFZ2/400X 400WGTZ	Getr. / GBox: Powershift für Fahrzeuge mit Zweis Scheibenkupplung / for vehicles with double disc clutch	(77)	
2546, L, LL 930.218 930.213 930.215 930.214 930.206 930.201 930.223/224 930.113 930.204 930.202 930.205 930.225 930.208 930.226 930.203 930.114	04.03-		 1863 869 028				
2546 L 930.203 930.205 930.208 930.223 930.202 930.213/214 930.218 930.113 930.204 930.224 930.201 930.215 930.114 930.206 930.225/226	04.03-		 6284 605 065		Füllmedium: Mineralöl / Fill Medium: Mineral Oil	(26)	
2546 LS 934.223 934.223	04.03-		 6284 605 064		Füllmedium: Bremsflüssigkeit / Fill Medium: Brake Fluid	(25)	
2548 LS 934.223 934.223	04.03-		 3189 600 058		für Nebenantrieb / for PTO	(82)	
2548, L, LL 930.203 930.218 930.113 930.214 930.114 930.206 930.202 930.204 930.213 930.215 930.201 930.205 930.208	04.03-		 3189 600 057				
2548, L, LL 930.201 930.205 930.208 930.202 930.113 930.218 930.203 930.114 930.214 930.204 930.206 930.215 930.213	04.03-						
2532 L 963.020/021	07.11-		OM936	 3400 700 532 ⊕ ⊗ 3488 023 031 ⊗ 1878 002 024	430 18	XTend Nabenprofil / Hub Profile: 45x50-18N Euro 6 / Euro 6 Nur zusammen verbauen / Only install together	(48) (18) (53)
2532 LS 963.423	07.11-			 3400 700 530 ⊕ ⊗ 3488 023 031 ⊗ 1878 002 024	430 18	XTend Getr. / GBox: Powershift Nabenprofil / Hub Profile: 45x50-18N Euro 6 / Euro 6 Nur zusammen verbauen / Only install together	(48) (18) (53)
2532 LS 963.420	07.11-	 3400 710 070 ⊕ ⊗ 3488 023 031 ⊗ 1878 002 024		430 18	Getr. / GBox: Powershift Nabenprofil / Hub Profile: 45x50-18N Euro 6 / Euro 6 mit automatischer Nachstellung / with automatic adjustment Nur zusammen verbauen / Only install together	(48) (18) (95) (53)	
2535 L 963.020/021	07.11-	 6482 000 218		PHIS-6/38	Getr. / GBox: Powershift Euro 6 / Euro 6 Immer erneuern / Renew everytime	(18) (30)	
2535 LS 963.423	07.11-						
2535 LS 963.420	07.11-						























		CODE				
--	--	------	--	---	---	---

MERCEDES-BENZ

ACTROS 2527 - 2560		06.96 -					
2533 L 963.020/021	07.11-	OM470	 3400 700 533  430 18	XTend Nabenprofil / Hub Profile: 45x50-18N Euro 6 / Euro 6 Nur zusammen verbauen / Only install together	(48) (18) (53)		
2533 LS 963.423	07.11-		 3400 700 531  430 18	XTend Getr. / GBox: Powershift Nabenprofil / Hub Profile: 45x50-18N Euro 6 / Euro 6 Nur zusammen verbauen / Only install together	(48) (18) (53)		
2533 LS 963.420	07.11-		3400 710 071  430 18	Getr. / GBox: Powershift Nabenprofil / Hub Profile: 45x50-18N Euro 6 / Euro 6 mit automatischer Nachstellung / with automatic adjustment Nur zusammen verbauen / Only install together	(48) (18) (95) (53)		
2536 L 963.020/021	07.11-			3400 700 542  430 18	XTend Getr. / GBox: Powershift Nabenprofil / Hub Profile: 45x50-18N Euro 6 / Euro 6 Nur zusammen verbauen / Only install together	(48) (18) (53)	
2536 LS 963.423	07.11-		3400 710 074  430 18	Getr. / GBox: Powershift Nabenprofil / Hub Profile: 45x50-18N Euro 6 / Euro 6 mit automatischer Nachstellung / with automatic adjustment Nur zusammen verbauen / Only install together	(48) (18) (95) (53)		
2540 L 963.020/021	07.11-			6482 000 218	PHIS-6/38 Getr. / GBox: Powershift Euro 6 / Euro 6 Immer erneuern / Renew everytime	(18) (30)	
2540 LS 963.423	07.11-		OM471	 3400 700 533  430 18	XTend Nabenprofil / Hub Profile: 45x50-18N Euro 6 / Euro 6 Nur zusammen verbauen / Only install together	(48) (18) (53)	
2540 LS 963.420	07.11-			 3400 700 531  430 18	XTend Getr. / GBox: Powershift Nabenprofil / Hub Profile: 45x50-18N Euro 6 / Euro 6 Nur zusammen verbauen / Only install together	(48) (18) (53)	
2542 L 963.021 963.020	07.11-			3400 710 071  430 18	Getr. / GBox: Powershift Nabenprofil / Hub Profile: 45x50-18N Euro 6 / Euro 6 mit automatischer Nachstellung / with automatic adjustment Nur zusammen verbauen / Only install together	(48) (18) (95) (53)	
2542 L 963.423	07.11-				3400 700 542  430 18	XTend Getr. / GBox: Powershift Nabenprofil / Hub Profile: 45x50-18N Euro 6 / Euro 6 Nur zusammen verbauen / Only install together	(48) (18) (53)
2543 L 963.021 963.020	07.11-	3400 710 074  430 18		Getr. / GBox: Powershift Nabenprofil / Hub Profile: 45x50-18N Euro 6 / Euro 6 mit automatischer Nachstellung / with automatic adjustment Nur zusammen verbauen / Only install together	(48) (18) (95) (53)		
2543 LS 963.423	07.11-			6482 000 218	PHIS-6/38 Getr. / GBox: Powershift Euro 6 / Euro 6 Immer erneuern / Renew everytime	(18) (30)	
2543 LS 963.420	07.11-						
2546	01.12-						

























		CODE				
--	--	------	--	---	---	---

MERCEDES-BENZ

ACTROS 2527 - 2560		06.96 -					
2545 L 963.020/021 2548 L 963.020/021	07.11-	OM470	 3400 700 545 			XTend Euro 6 / Euro 6	(18)
	07.11-		 3400 700 541 	430 18		XTend Getr. / GBox: Powershift Nabenprofil / Hub Profile: 45x50-18N Euro 6 / Euro 6 Nur zusammen verbauen / Only install together	(48) (18) (53)
			 3400 710 072 	430 18		Getr. / GBox: Powershift Nabenprofil / Hub Profile: 45x50-18N Euro 6 / Euro 6 mit automatischer Nachstellung / with automatic adjustment Nur zusammen verbauen / Only install together	(48) (18) (95) (53)
			 3400 700 543 	430 18		XTend Getr. / GBox: Powershift Nabenprofil / Hub Profile: 45x50-18N Euro 6 / Euro 6 Nur zusammen verbauen / Only install together	(48) (18) (53)
			 3400 710 075 	430 18		Getr. / GBox: Powershift Nabenprofil / Hub Profile: 45x50-18N Euro 6 / Euro 6 mit automatischer Nachstellung / with automatic adjustment Nur zusammen verbauen / Only install together	(48) (18) (95) (53)
			 6482 000 218	PHIS-6/38		Getr. / GBox: Powershift Euro 6 / Euro 6 Immer erneuern / Renew everytime	(18) (30)
2545 LS 963.423 2545 LS 963.420 2548 LS 963.423 2548 LS 963.420	07.11-	OM471	 3400 700 545 			XTend Euro 6 / Euro 6	(18)
	07.11-		 3400 700 541 	430 18		XTend Getr. / GBox: Powershift Nabenprofil / Hub Profile: 45x50-18N Euro 6 / Euro 6 Nur zusammen verbauen / Only install together	(48) (18) (53)
	07.11-		 3400 710 072 	430 18		Getr. / GBox: Powershift Nabenprofil / Hub Profile: 45x50-18N Euro 6 / Euro 6 mit automatischer Nachstellung / with automatic adjustment Nur zusammen verbauen / Only install together	(48) (18) (95) (53)
	07.11-		 3400 700 543 	430 18		XTend Getr. / GBox: Powershift Nabenprofil / Hub Profile: 45x50-18N Euro 6 / Euro 6 Nur zusammen verbauen / Only install together	(48) (18) (53)
			 3400 710 075 	430 18		Getr. / GBox: Powershift Nabenprofil / Hub Profile: 45x50-18N Euro 6 / Euro 6 mit automatischer Nachstellung / with automatic adjustment Nur zusammen verbauen / Only install together	(48) (18) (95) (53)
			 6482 000 218	PHIS-6/38		Getr. / GBox: Powershift Euro 6 / Euro 6 Immer erneuern / Renew everytime	(18) (30)



















		CODE				
--	--	------	--	---	---	---

MERCEDES-BENZ

ACTROS 2527 - 2560		06.96 -					
2548 L 930.202 930.204/205 930.203 2548 LS 954.223 954.233 2548, 2548 L 950.204 950.113 950.205 950.114 950.203 2550 LS 934.233 2550, LS 934.223 2551 LS 934.233 934.223 2551, L, LL 930.202 930.205 930.201 930.206 930.203/204 930.113/114 2551, L, LL 930.204 930.201-203 930.206 930.113/114 930.205 2553 L 930.203 930.202 930.205 930.204 2553 LS 954.223 954.233 2553, 2553 L 950.113 950.203 950.114 950.205 950.204 2554 LS 934.223 934.233 2554, L 930.113 2555 LS 934.233 934.223 2555, L, LL 930.113/114 930.206 930.202 930.201 930.203 930.205 930.204 2555, L, LL 930.205 930.113 930.203/204 930.114 930.201/202 930.206	04.03-	OM542		3400 700 415 ⊕  3483 030 032  1878 002 732	430 18 MFZ430 430WGTZ	für Fahrzeuge mit Einscheibenkupplung / for vehicles with single disc clutch (72)	
			09.96-10.02		3400 121 501 ⊕  3488 023 031  1878 002 024	400 18 MFZ2/400X 400WGTZ	Nabenprofil / Hub Profile: 45x50-18N für Fahrzeuge mit Zweis Scheibenkupplung / for vehicles with double disc clutch (48) (77)
			04.03-		3400 700 355 ⊕  3488 000 158  1878 002 019	400 18 MFZ2/400X 400WGTZ	Getr. / GBox: Powershift für Fahrzeuge mit Zweis Scheibenkupplung / for vehicles with double disc clutch (77)
			04.03-		3488 000 102 ⊕	400 GMFZ2/ 400N	für Nebenantrieb / for PTO für Fahrzeuge mit Zweis Scheibenkupplung / for vehicles with double disc clutch enthält eine Kupplungsscheibe / This part number includes one clutch disc (82) (77) (67)
			04.03-		1878 002 024 ▽	400 18 400WGTZ	für Nebenantrieb / for PTO für Fahrzeuge mit Zweis Scheibenkupplung / for vehicles with double disc clutch Lose Kupplungsscheibe / Loose clutch disc (82) (77) (41)
			04.03-		1863 869 028		
			09.96-10.02		6284 605 065 6284 605 064		Füllmedium: Mineralöl / Fill Medium: Mineral Oil (26) Füllmedium: Bremsflüssigkeit / Fill Medium: Brake Fluid (25)
			09.96-10.02		3189 600 058 3189 600 057		für Nebenantrieb / for PTO (82)
			04.03-				
			04.03-				
			09.05-				
			04.03-				
			04.03-				
	2551 L 963.020/021 2551 LS 963.423 2551 LS 963.420		07.11-	OM471		3400 700 534 ⊕ 	430 18
07.11-			3400 700 529 ⊕ 		430 18	XTend Getr. / GBox: Powershift Nabenprofil / Hub Profile: 45x50-18N Euro 6 / Euro 6 Nur zusammen verbauen / Only install together (48) (18) (53)	
07.11-			3400 710 073 ⊕ 		430 18	Getr. / GBox: Powershift Nabenprofil / Hub Profile: 45x50-18N Euro 6 / Euro 6 mit automatischer Nachstellung / with automatic adjustment Nur zusammen verbauen / Only install together (48) (18) (95) (53)	
			3400 700 544 ⊕ 		430 18	XTend Getr. / GBox: Powershift Nabenprofil / Hub Profile: 45x50-18N Euro 6 / Euro 6 Nur zusammen verbauen / Only install together (48) (18) (53)	
			3400 710 076 ⊕ 		430 18	Getr. / GBox: Powershift Nabenprofil / Hub Profile: 45x50-18N Euro 6 / Euro 6 mit automatischer Nachstellung / with automatic adjustment Nur zusammen verbauen / Only install together (48) (18) (95) (53)	
			6482 000 218		PHIS-6/38	Getr. / GBox: Powershift Euro 6 / Euro 6 Immer erneuern / Renew everytime (18) (30)	









		CODE				
--	--	------	--	---	---	---

MERCEDES-BENZ

ACTROS 2527 - 2560		06.96 -					
2557 L 950.203 2558, L 930.203 2560, L, LL 930.205 930.201 930.203/204 930.202 2560, L, LL 930.201 930.203 930.202 930.204/205	09.96 - 10.02	OM542	 3400 700 468 ⊕ ⊗ 3483 000 422 ⊗ 1878 006 101	430 18 MFZ430 430WGTZ	für Fahrzeuge mit Einscheibenkupplung / for vehicles with single disc clutch	(72)	
	04.03 -		 3400 121 501 ⊕⊗ ⊗ 3488 023 031 ⊗ 1878 002 024	400 18 MFZ2/400X 400WGTZ	Nabenprofil / Hub Profile: 45x50-18N für Fahrzeuge mit Zweis Scheibenkupplung / for vehicles with double disc clutch	(48) (77)	
	04.03 -		 3400 700 355 ⊕⊗ ⊗ 3488 000 158 ⊗ 1878 002 019	400 18 MFZ2/400X 400WGTZ	Getr. / GBox: Powershift für Fahrzeuge mit Zweis Scheibenkupplung / for vehicles with double disc clutch	(77)	
	04.03 -		 3488 000 102 ⊕	400 GMFZ2/ 400N	für Nebenantrieb / for PTO für Fahrzeuge mit Zweis Scheibenkupplung / for vehicles with double disc clutch enthält eine Kupplungsscheibe / This part number includes one clutch disc	(82) (77) (67)	
			 1878 002 024 ▽	400 18 400WGTZ	für Nebenantrieb / for PTO für Fahrzeuge mit Zweis Scheibenkupplung / for vehicles with double disc clutch Lose Kupplungsscheibe / Loose clutch disc	(82) (77) (41)	
			 1863 869 028				
			 6284 605 064			Füllmedium: Bremsflüssigkeit / Fill Medium: Brake Fluid	(25)
			6284 605 065			Füllmedium: Mineralöl / Fill Medium: Mineral Oil	(26)
			 3189 600 057				
			3189 600 058			für Nebenantrieb / for PTO	(82)
ACTROS 2627 - 2665		04.96 -					
2627 L 963.024 2627 L 963.025 2627 LS 963.424 2627 LS 963.425 2630 L 963.024 2630 L 963.025 2630 LS 963.424 2630 LS 963.425	07.11 -	OM936	 3400 700 639 ⊕	395 18	Euro 6 / Euro 6	(18)	
	07.11 -		 3400 700 546 ⊕	395 18	XTend Getr. / GBox: Powershift Nabenprofil / Hub Profile: 36x40-18N Euro 6 / Euro 6 Nur zusammen verbauen / Only install together	(48) (18) (53)	
	07.11 -		 6482 000 219	PHIS-5/34	Getr. / GBox: Powershift Euro 6 / Euro 6 Immer erneuern / Renew everytime	(18) (30)	
	07.11 -						
	07.11 -						
	07.11 -						
	07.11 -						
	07.11 -						
	07.11 -						
	07.11 -						
2631 932.241 2657 K, 2657 LK 952.141 952.241 952.243 2657 L 950.243 2657 S, 2657 LS 954.241 2658 K, LK 932.141 932.241 2658 L 930.242/243 2658 LS 934.241 2660 L, LL 930.242/243 2660 LK 932.141 932.241 2660 S, LS 934.241	04.97 - 10.02	OM542	 3400 700 468 ⊕ ⊗ 3483 000 422 ⊗ 1878 006 101	430 18 MFZ430 430WGTZ	für Fahrzeuge mit Einscheibenkupplung / for vehicles with single disc clutch	(72)	
	04.97 - 10.02		 3400 121 501 ⊕⊗ ⊗ 3488 023 031 ⊗ 1878 002 024	400 18 MFZ2/400X 400WGTZ	Nabenprofil / Hub Profile: 45x50-18N für Fahrzeuge mit Zweis Scheibenkupplung / for vehicles with double disc clutch	(48) (77)	
	04.97 - 10.02		 3400 700 355 ⊕⊗ ⊗ 3488 000 158 ⊗ 1878 002 019	400 18 MFZ2/400X 400WGTZ	Getr. / GBox: Powershift für Fahrzeuge mit Zweis Scheibenkupplung / for vehicles with double disc clutch	(77)	
	04.03 -		 3488 000 102 ⊕	400 GMFZ2/ 400N	für Nebenantrieb / for PTO für Fahrzeuge mit Zweis Scheibenkupplung / for vehicles with double disc clutch enthält eine Kupplungsscheibe / This part number includes one clutch disc	(82) (77) (67)	
	04.03 -		 1878 002 024 ▽	400 18 400WGTZ	für Nebenantrieb / for PTO für Fahrzeuge mit Zweis Scheibenkupplung / for vehicles with double disc clutch Lose Kupplungsscheibe / Loose clutch disc	(82) (77) (41)	
	04.03 -		 1863 869 028				
	06.08 -		 6284 605 064			Füllmedium: Bremsflüssigkeit / Fill Medium: Brake Fluid	(25)
	06.08 -		6284 605 065			Füllmedium: Mineralöl / Fill Medium: Mineral Oil	(26)
	06.08 -		 3189 600 057				
	06.08 -		3189 600 058			für Nebenantrieb / for PTO	(82)











		CODE				
--	--	------	--	---	---	---

MERCEDES-BENZ

ACTROS 2627 - 2665		04.96 -				
2631 B 953.141	04.97 - 10.02	OM541		3400 122 801 ⊕ ⊗ 3483 030 032 ⊗ 1878 007 072	430 18 MFZ430 430WGTZ	für Fahrzeuge mit Einscheibenkupplung / for vehicles with single disc clutch (72)
2631 B 933.141	04.03 -					
2631 K 952.143 952.142 952.141	04.97 - 10.02			3400 700 446 ⊕ ⊗ 3483 000 258 ⊗ 1878 007 072	430 18 MFZ430 430WGTZ	für / for: SA 504682-22/24 für Fahrzeuge mit Einscheibenkupplung / for vehicles with single disc clutch (72)
2631 K, LK 932.143 932.142 932.241 932.141	04.03 -			3400 700 416 ⊕ ⊗ 3483 000 139 ⊗ 1878 007 072	430 18 GMFZ430N 430WGTZ	für Nebenantrieb / for PTO für Fahrzeuge mit Einscheibenkupplung / for vehicles with single disc clutch (82)
2631, 2631 L 950.145 950.244 950.143 950.243 950.142 950.242	04.96 - 10.02			3488 000 102 ⊕	400 GMFZ2/ 400N	für Nebenantrieb / for PTO für Fahrzeuge mit Zweis Scheibenkupplung / for vehicles with double disc clutch enthält eine Kupplungsscheibe / This part number includes one clutch disc (82)
2631 L 930.242-244	04.03 -					(67)
2631 LS 934.241	10.02 -			1878 002 024 ▽	400 18 400WGTZ	für Nebenantrieb / for PTO für Fahrzeuge mit Zweis Scheibenkupplung / for vehicles with double disc clutch Lose Kupplungsscheibe / Loose clutch disc (41)
2631 LS 934.251	10.09 -					
2632 B 933.141	04.03 -			3400 121 501 (M) ⊕ ⊗ 3488 023 031 ⊗ 1878 002 024	400 18 MFZ2/400X 400WGTZ	Nabenprofil / Hub Profile: 45x50-18N für Fahrzeuge mit Zweis Scheibenkupplung / for vehicles with double disc clutch (48)
2632 K, LK 932.145 932.141 932.143 932.142 932.241	04.03 -					(77)
2632, L, LL 930.242 930.142 930.145 930.244 930.243 930.143	04.03 -			3400 700 355 (H) ⊕ ⊗ 3488 000 158 ⊗ 1878 002 019	400 18 MFZ2/400X 400WGTZ	Getr. / GBox: Powershift für Fahrzeuge mit Zweis Scheibenkupplung / for vehicles with double disc clutch (77)
2632 LS 934.251	10.09 -			1863 869 028		
2632 LS 934.241	04.03 -			6284 605 064		Füllmedium: Bremsflüssigkeit / Fill Medium: Brake Fluid (25)
2635 B 933.141	04.03 -					
2635 B 953.141	04.97 - 10.02					
2635 K, 2635 LK 952.141 952.143 952.241	04.97 - 10.02					
2635 K, LK 932.241 932.142 932.141 932.143	04.03 -					
2635, 2635 L 950.143 950.142 950.244 950.243	04.96 - 10.02					
2635 L 930.242-244	04.03 -					
2635 LS 934.241	10.02 -					
2635 LS 934.251	10.09 -					
2636 B 933.141	04.03 -					
2636 K, LK 932.145 932.141 932.143 932.241 932.142	04.03 -					
2636, L, LL 930.143 930.244 930.242 930.142 930.243	04.03 -					
2636 LS 934.241	04.03 -					
2636 LS 934.251	10.09 -					
2640 B 953.141	04.97 - 10.02					
2640 B 933.141	04.03 -					
2640 K, 2640 LK 952.241 952.143 952.243 952.141	04.97 - 10.02					
2640 K, LK 932.241 932.141 932.143 932.142	04.03 -					
2640, 2640 L 950.242 950.244 950.243 950.143	04.96 - 10.02					
2640 L 930.243 930.242 930.244	04.03 -					
2640 LS 934.241	10.02 -					
2640 LS 934.251	10.09 -					
2640 S, 2640 LS 954.141 954.241	09.96 - 10.02					

















		CODE				
--	--	------	--	---	---	---

MERCEDES-BENZ























ACTROS 2627 - 2665		04.96 -				
2641 B 933.141	04.03-	OM541		3400 122 801 ⊕ ⊗ 3483 030 032 ⊗ 1878 007 072	430 18 MFZ430 430WGTZ	für Fahrzeuge mit Einscheibenkupplung / for vehicles with single disc clutch (72)
2641 K, LK 932.141 932.143 932.145 932.241 932.142	04.03-			3400 700 446 ⊕ ⊗ 3483 000 258 ⊗ 1878 007 072	430 18 MFZ430 430WGTZ	für / for: SA 504682-22/24 für Fahrzeuge mit Einscheibenkupplung / for vehicles with single disc clutch (69) (72)
2641, L, LL 930.242 930.244 930.143 930.243	04.03-			3400 700 416 ⊕ ⊗ 3483 000 139 ⊗ 1878 007 072	430 18 GMFZ430N 430WGTZ	für Nebenantrieb / for PTO für Fahrzeuge mit Einscheibenkupplung / for vehicles with single disc clutch (82) (72)
2641 LS 934.251	10.09-			3488 000 102 ⊕	400 GMFZ2/ 400N	für Nebenantrieb / for PTO für Fahrzeuge mit Zweis Scheibenkupplung / for vehicles with double disc clutch (82) (77)
2641 S, LS 934.141 934.241	04.03-					enthält eine Kupplungsscheibe / This part number includes one clutch disc (67)
2643 B 953.141	04.97 - 10.02			1878 002 024 ▽	400 18 400WGTZ	für Nebenantrieb / for PTO für Fahrzeuge mit Zweis Scheibenkupplung / for vehicles with double disc clutch (82) (77)
2643 B 933.141	04.03-					Lose Kupplungsscheibe / Loose clutch disc (41)
2643 K, 2643 LK 952.143 952.141 952.243 952.241	04.97 - 10.02			3400 121 501 (M) ⊕ ⊗ 3488 023 031 ⊗ 1878 002 024	400 18 MFZ2/400X 400WGTZ	Nabenprofil / Hub Profile: 45x50-18N für Fahrzeuge mit Zweis Scheibenkupplung / for vehicles with double disc clutch (48) (77)
2643 K, LK 932.142 932.141 932.143 932.241	04.03-			3400 700 355 (H) ⊕ ⊗ 3488 000 158 ⊗ 1878 002 019	400 18 MFZ2/400X 400WGTZ	Getr. / GBox: Powershift für Fahrzeuge mit Zweis Scheibenkupplung / for vehicles with double disc clutch (77)
2643, 2643 L 950.242/243 950.143 950.244	04.96 - 10.02					
2643 L 930.244 930.242/243	04.03-			1863 869 028		
2643 LS 934.251	10.09-					
2643 S, 2643 LS 954.241 954.141	04.97 - 10.02			6284 605 064		Füllmedium: Bremsflüssigkeit / Fill Medium: Brake Fluid (25)
2644 B 933.141	04.03-			6284 605 065		Füllmedium: Mineralöl / Fill Medium: Mineral Oil (26)
2644 K, LK 932.141 932.145 932.142/143 932.241	04.03-			3189 600 057		
2644 S, LS 934.241 934.141	04.03-			3189 600 058		für Nebenantrieb / for PTO (82)
2644, L, LL 930.142/143 930.242 930.244 930.243	04.03-					
2646 B 953.141	10.97-					
2646 B 933.141	04.03-					
2646 K, LK 932.141/142 932.145 932.241 932.143	04.03-					
2646, L, LL 930.244 930.142 930.242 930.143 930.145 930.243	04.03-					
2646 LS 934.251	10.09-					
2646 S, 2646 LS 954.241 954.141	10.97-					
2646 S, LS 934.141 934.241	04.03-					
2648 B 933.141	04.03-					
2648 K, 2648 LK 952.141 952.143 952.241	10.97-					
2648 K, LK 932.241 932.143 932.141/142 932.145	04.03-					
2648, L, LL 930.244 930.243 930.143 930.142 930.242	04.03-					
2648 LS 934.251	10.09-					
2648 S, 2648 LS 954.141 954.241	10.97-					
2648 S, LS 934.241 934.141	04.03-					
2653 950.143 950.243 954.141	01.96-					

		CODE				
--	--	------	--	---	---	---

MERCEDES-BENZ









ACTROS 2627 - 2665		04.96 -					
2632 L 963.024	07.11-	OM936	 3400 700 532  430 18	XTend Nabenprofil / Hub Profile: 45x50-18N Euro 6 / Euro 6 Nur zusammen verbauen / Only install together	(48) (18) (53)		
2632 L 963.025	07.11-						
2632 LS 963.424	07.11-		 3400 700 530  430 18	XTend Getr. / GBox: Powershift Nabenprofil / Hub Profile: 45x50-18N Euro 6 / Euro 6 Nur zusammen verbauen / Only install together	(48) (18) (53)		
2632 LS 963.425	07.11-						
2635 L 963.024	07.11-		 3400 710 070  430 18	Getr. / GBox: Powershift Nabenprofil / Hub Profile: 45x50-18N Euro 6 / Euro 6 mit automatischer Nachstellung / with automatic adjustment Nur zusammen verbauen / Only install together	(48) (18) (95) (53)		
2635 L 963.025	07.11-						
2635 LS 963.424	07.11-						
2635 LS 963.425	07.11-		 6482 000 218	PHIS-6/38 Getr. / GBox: Powershift Euro 6 / Euro 6 Immer erneuern / Renew everytime	(18) (30)		
2633 L 963.024	07.11-	OM470	 3400 700 533  430 18	XTend Nabenprofil / Hub Profile: 45x50-18N Euro 6 / Euro 6 Nur zusammen verbauen / Only install together	(48) (18) (53)		
2633 L 963.025	07.11-						
2633 LS 963.424	07.11-		 3400 700 531  430 18	XTend Getr. / GBox: Powershift Nabenprofil / Hub Profile: 45x50-18N Euro 6 / Euro 6 Nur zusammen verbauen / Only install together	(48) (18) (53)		
2633 LS 963.425	07.11-						
2636 L 963.024	07.11-		3400 710 071  430 18	Getr. / GBox: Powershift Nabenprofil / Hub Profile: 45x50-18N Euro 6 / Euro 6 mit automatischer Nachstellung / with automatic adjustment Nur zusammen verbauen / Only install together	(48) (18) (95) (53)		
2636 L 963.025	07.11-						
2636 LS 963.424	07.11-						
2636 LS 963.425	07.11-		 3400 700 542  430 18	XTend Getr. / GBox: Powershift Nabenprofil / Hub Profile: 45x50-18N Euro 6 / Euro 6 Nur zusammen verbauen / Only install together	(48) (18) (53)		
2640 L 963.024	07.11-						
2640 L 963.025	07.11-						
2640 LS 963.424	07.11-		 3400 710 074  430 18	Getr. / GBox: Powershift Nabenprofil / Hub Profile: 45x50-18N Euro 6 / Euro 6 mit automatischer Nachstellung / with automatic adjustment Nur zusammen verbauen / Only install together	(48) (18) (95) (53)		
2640 LS 963.425	07.11-						
2643 L 963.024	07.11-		 6482 000 218	PHIS-6/38 Getr. / GBox: Powershift Euro 6 / Euro 6 Immer erneuern / Renew everytime	(18) (30)		
2643 L 963.025	07.11-						
2643 LS 963.424	07.11-						
2643 LS 963.425	07.11-						

MERCEDES-BENZ

ACTROS 2627 - 2665		04.96 -					
2642 L 963.024 2642 L 963.025 2642 LS 963.424 2642 LS 963.425 2646	07.11-	OM471		3400 700 533 	430 18	XTend Nabenprofil / Hub Profile: 45x50-18N Euro 6 / Euro 6 Nur zusammen verbauen / Only install together	(48) (18) (53)
	07.11-			3400 700 531 	430 18	XTend Getr. / GBox: Powershift Nabenprofil / Hub Profile: 45x50-18N Euro 6 / Euro 6 Nur zusammen verbauen / Only install together	(48) (18) (53)
	07.11-			3400 710 071 	430 18	Getr. / GBox: Powershift Nabenprofil / Hub Profile: 45x50-18N Euro 6 / Euro 6 mit automatischer Nachstellung / with automatic adjustment Nur zusammen verbauen / Only install together	(48) (18) (95) (53)
	01.12-			3400 700 542 	430 18	XTend Getr. / GBox: Powershift Nabenprofil / Hub Profile: 45x50-18N Euro 6 / Euro 6 Nur zusammen verbauen / Only install together	(48) (18) (53)
				3400 710 074 	430 18	Getr. / GBox: Powershift Nabenprofil / Hub Profile: 45x50-18N Euro 6 / Euro 6 mit automatischer Nachstellung / with automatic adjustment Nur zusammen verbauen / Only install together	(48) (18) (95) (53)
				6482 000 218	PHIS-6/38	Getr. / GBox: Powershift Euro 6 / Euro 6 Immer erneuern / Renew everytime	(18) (30)
	2645 L 963.024 2645 L 963.025 2645 LS 963.424 2645 LS 963.425 2648 L 963.024 2648 L 963.025 2648 LS 963.424 2648 LS 963.425		07.11-	OM471		3400 700 545 	
07.11-			3400 700 541 		430 18	XTend Getr. / GBox: Powershift Nabenprofil / Hub Profile: 45x50-18N Euro 6 / Euro 6 Nur zusammen verbauen / Only install together	(48) (18) (53)
07.11-			3400 710 072 		430 18	Getr. / GBox: Powershift Nabenprofil / Hub Profile: 45x50-18N Euro 6 / Euro 6 mit automatischer Nachstellung / with automatic adjustment Nur zusammen verbauen / Only install together	(48) (18) (95) (53)
07.11-			3400 700 543 		430 18	XTend Getr. / GBox: Powershift Nabenprofil / Hub Profile: 45x50-18N Euro 6 / Euro 6 Nur zusammen verbauen / Only install together	(48) (18) (53)
07.11-			3400 710 075 		430 18	Getr. / GBox: Powershift Nabenprofil / Hub Profile: 45x50-18N Euro 6 / Euro 6 mit automatischer Nachstellung / with automatic adjustment Nur zusammen verbauen / Only install together	(48) (18) (95) (53)
			6482 000 218		PHIS-6/38	Getr. / GBox: Powershift Euro 6 / Euro 6 Immer erneuern / Renew everytime	(18) (30)



































		CODE				
--	--	------	--	---	---	---

MERCEDES-BENZ

ACTROS 2627 - 2665		04.96 -				
2648 K, 2648 LK 952.241 952.243 952.141 952.143	04.97 - 10.02	OM542		3400 700 415 ⊕ ⊗ 3483 030 032 ⊗ 1878 002 732	430 18 MFZ430 430WGTZ	für Fahrzeuge mit Einscheibenkupplung / for vehicles with single disc clutch (72)
2648 K, LK 932.143 932.141 932.241	04.03 -			3400 121 501 ⊕ ⊗ ⊗ 3488 023 031 ⊗ 1878 002 024	400 18 MFZ2/400X 400WGTZ	Nabenprofil / Hub Profile: 45x50-18N für Fahrzeuge mit Zweis Scheibenkupplung / for vehicles with double disc clutch (48) (77)
2648 L 930.242-244	04.03 -					
2648 LS 934.241	10.02 -			3400 700 355 ⊕ ⊗ ⊗ 3488 000 158 ⊗ 1878 002 019	400 18 MFZ2/400X 400WGTZ	Getr. / GBox: Powershift für Fahrzeuge mit Zweis Scheibenkupplung / for vehicles with double disc clutch (77)
2648 S, 2648 LS 954.241 954.141	09.96 - 10.02			3488 000 102 ⊕	400 GMFZ2/ 400N	für Nebenantrieb / for PTO für Fahrzeuge mit Zweis Scheibenkupplung / for vehicles with double disc clutch enthält eine Kupplungsscheibe / This part number includes one clutch disc (82) (77)
2648, 2648 L 950.243 950.143 950.244 950.242	04.96 - 10.02					
2650 K, 2651 K, LK 932.141 932.145 932.143 932.241	04.03 -					
2650 S, 2650 LS 954.141 954.241	10.97 -			1878 002 024 ▽	400 18 400WGTZ	für Nebenantrieb / for PTO für Fahrzeuge mit Zweis Scheibenkupplung / for vehicles with double disc clutch Lose Kupplungsscheibe / Loose clutch disc (82) (77)
2650 S, LS 934.141 934.223 934.233 934.241	04.03 -			1863 869 028		
2650, L, 2651, L, LL 930.243 930.242 930.244 930.142/143	04.03 -			6284 605 064		Füllmedium: Bremsflüssigkeit / Fill Medium: Brake Fluid (25)
2651 L 930.244 930.243	04.03 -			6284 605 065		Füllmedium: Mineralöl / Fill Medium: Mineral Oil (26)
2651 LS 934.251	10.09 -			3189 600 057		
2651 S, LS 934.241 934.141	04.03 -			3189 600 058		für Nebenantrieb / for PTO (82)
2653 K, 2653 LK 952.143 952.241 952.243 952.141	04.97 - 10.02					
2653 K, LK 932.143 932.141 932.241	04.03 -					
2653, 2653 L 950.143 950.243	04.96 - 10.02					
2654, L, 2655, L, LL 930.243 930.242 930.244 930.143 930.142	04.03 -					
2653 L 930.242 930.244 930.243	04.03 -					
2653 LS 934.251	10.09 -					
2653 S, 2653 LS 954.141 954.241	09.96 - 10.02					
2654 K, LK, 2655 K, LK 932.141 932.145 932.143 932.241	04.03 -					
2654 S, LS 934.233 934.141 934.241 934.223	04.03 -					
2655 LS 934.251	10.09 -					
2655 S, LS 934.141 934.241	04.03 -					











		CODE				
--	--	------	--	---	---	---

MERCEDES-BENZ











ACTROS 2627 - 2665		04.96 -					
2651 L 963.024 2651 L 963.025 2651 LS 963.424 2651 LS 963.425	07.11-	OM471	 3400 700 534   430 18	XTend Nabenprofil / Hub Profile: 45x50-18N Euro 6 / Euro 6 max. übertragbares Motormoment [Nm] / max. transmittable engine torque [Nm]: 2600 Nur zusammen verbauen / Only install together	(48) (18) (87) (53)		
	07.11-		 3400 700 529   430 18	XTend Getr. / GBox: Powershift Nabenprofil / Hub Profile: 45x50-18N Euro 6 / Euro 6 Nur zusammen verbauen / Only install together	(48) (18) (53)		
	07.11-		 3400 710 073  430 18	Getr. / GBox: Powershift Nabenprofil / Hub Profile: 45x50-18N Euro 6 / Euro 6 mit automatischer Nachstellung / with automatic adjustment Nur zusammen verbauen / Only install together	(48) (18) (95) (53)		
	07.11-		 3400 700 544   430 18	XTend Getr. / GBox: Powershift Nabenprofil / Hub Profile: 45x50-18N Euro 6 / Euro 6 Nur zusammen verbauen / Only install together	(48) (18) (53)		
			 3400 710 076   430 18	Getr. / GBox: Powershift Nabenprofil / Hub Profile: 45x50-18N Euro 6 / Euro 6 mit automatischer Nachstellung / with automatic adjustment Nur zusammen verbauen / Only install together	(48) (18) (95) (53)		
			 6482 000 218	PHIS-6/38 Getr. / GBox: Powershift Euro 6 / Euro 6 Immer erneuern / Renew everytime	(18) (30)		
	2665 LS 934.241 2665 LS		04.03-	OM542	 3400 121 501   400 18	Nabenprofil / Hub Profile: 45x50-18N	(48)
10.02-		 3488 023 031	MFZ2/400X		für Fahrzeuge mit Zweis Scheibenkupplung / for vehicles with double disc clutch	(77)	
		 1878 002 024	400WGTZ				
		 3400 700 355   400 18	MFZ2/400X		Getr. / GBox: Powershift	(77)	
		 3488 000 158	400WGTZ		für Fahrzeuge mit Zweis Scheibenkupplung / for vehicles with double disc clutch	(77)	
		 1878 002 019					
		 3488 000 102  400	GMFZ2/ 400N		für Nebenantrieb / for PTO für Fahrzeuge mit Zweis Scheibenkupplung / for vehicles with double disc clutch enthält eine Kupplungsscheibe / This part number includes one clutch disc	(82) (77) (67)	
		 1878 002 024  400 18	400WGTZ		für Nebenantrieb / for PTO für Fahrzeuge mit Zweis Scheibenkupplung / for vehicles with double disc clutch Lose Kupplungsscheibe / Loose clutch disc	(82) (77) (41)	
	 1863 869 028						
	 6284 605 065		Füllmedium: Mineralöl / Fill Medium: Mineral Oil	(26)			
	 6284 605 064		Füllmedium: Bremsflüssigkeit / Fill Medium: Brake Fluid	(25)			
	 3189 600 057						
	 3189 600 058		für Nebenantrieb / for PTO	(82)			

		CODE				
--	--	------	--	---	---	---

MERCEDES-BENZ



















ACTROS 3231 - 3339		06.96 -				
3231 932.307 932.305 932.304		OM541	 3400 122 801 ⊕ ⊗ 3483 030 032 ⊗ 1878 007 072	430 18 MFZ430 430WGTZ	für Fahrzeuge mit Einscheibenkupplung / for vehicles with single disc clutch	(72)
3231 B 953.304	04.97 - 10.02		 3400 700 446 ⊕ ⊗ 3483 000 258 ⊗ 1878 007 072	430 18 MFZ430 430WGTZ	für / for: SA 504682-22/24 für Fahrzeuge mit Einscheibenkupplung / for vehicles with single disc clutch	(69) (72)
3331 B 933.161-163	04.03-		 3400 700 416 ⊕ ⊗ 3483 000 139 ⊗ 1878 007 072	430 18 GMFZ430N 430WGTZ	für Nebenantrieb / for PTO für Fahrzeuge mit Einscheibenkupplung / for vehicles with single disc clutch	(82) (72)
3231 K 952.304	04.97 - 10.02		 3488 000 102 ⊕	400 GMFZ2/ 400N	für Nebenantrieb / for PTO für Fahrzeuge mit Zweis Scheibenkupplung / for vehicles with double disc clutch	(82) (77)
3331 K 932.163 932.162 932.161	04.03-				enthält eine Kupplungsscheibe / This part number includes one clutch disc	(67)
3231 K, 3232 K 932.304/305 932.307	04.03-		 1878 002 024 ▽	400 18 400WGTZ	für Nebenantrieb / for PTO für Fahrzeuge mit Zweis Scheibenkupplung / for vehicles with double disc clutch	(82) (77)
3232 B 933.304 933.307 933.305	04.03-				Lose Kupplungsscheibe / Loose clutch disc	(41)
3235 953.305	04.97 - 10.02		 3400 121 501 (M) ⊕ ⊗ 3488 023 031 ⊗ 1878 002 024	400 18 MFZ2/400X 400WGTZ	Nabenprofil / Hub Profile: 45x50-18N für Fahrzeuge mit Zweis Scheibenkupplung / for vehicles with double disc clutch	(48) (77)
3335 A 930.183 930.182	04.03-		 3400 700 355 (H) ⊕ ⊗ 3488 000 158 ⊗ 1878 002 019	400 18 MFZ2/400X 400WGTZ	Getr. / GBox: Powershift für Fahrzeuge mit Zweis Scheibenkupplung / for vehicles with double disc clutch	(77)
3235 B 953.304/305	04.97 - 10.02					
3235 B 933.304/305	04.03-		 1863 869 028			
3335 B 933.163 933.161/162	04.03-		 6284 605 064		Füllmedium: Bremsflüssigkeit / Fill Medium: Brake Fluid	(25)
3235 K 952.305 952.307 952.304	04.97 - 10.02		6284 605 065		Füllmedium: Mineralöl / Fill Medium: Mineral Oil	(26)
3335 K 932.161-163	04.03-		 3189 600 057			
3235 K 932.304 932.307 932.305	04.03-		3189 600 058		für Nebenantrieb / for PTO	(82)
3236 B 933.304/305 933.307	04.03-					
3236 K 932.305 932.304 932.307	04.03-					
3236 L 930.182/183	04.03-					
3339 A 932.182/183	04.03-					
3339 AK 933.162/163 933.161	04.03-					
3339 B 932.163 932.161/162	04.03-					
3339 K 953.305 950.306	04.97 - 10.02					
3240 930.306	04.03-					
3240 B 953.304/305	04.97 - 10.02					
3240 B 933.305 933.304	04.03-					
3240 K 952.304/305	04.97 - 10.02					
3240 K 932.305 932.307 932.304	04.03-					
3241 930.306	04.03-					
3241 B 933.305 933.307 933.304	04.03-					
3241 K 932.304 932.307 932.305	04.03-					
3241 L 930.306	06.08-					
3243 930.306	10.02-					
3243 950.306 953.305	04.97 - 10.02					
3243 B 953.305 953.304	04.97 - 10.02					
3243 B 933.305 933.304	04.03-					

MERCEDES-BENZ

ACTROS 3231 - 3339		06.96 -				
3243 K 952.305 952.304	04.97 - 10.02	OM541	 3400 122 801 ⊕ ⊗ 3483 030 032 ⊗ 1878 007 072	430 18 MFZ430 430WGTZ	für Fahrzeuge mit Einscheibenkupplung / for vehicles with single disc clutch	(72)
3243 K 932.305 932.307 932.304	04.03 -		 3400 700 446 ⊕ ⊗ 3483 000 258 ⊗ 1878 007 072	430 18 MFZ430 430WGTZ	für / for: SA 504682-22/24 für Fahrzeuge mit Einscheibenkupplung / for vehicles with single disc clutch	(69) (72)
3244 930.306	04.03 -					
3244 B 933.304 933.307 933.305	04.03 -		 3400 700 416 ⊕ ⊗ 3483 000 139 ⊗ 1878 007 072	430 18 GMFZ430N 430WGTZ	für Nebenantrieb / for PTO für Fahrzeuge mit Einscheibenkupplung / for vehicles with single disc clutch	(82) (72)
3244 K 932.304/305 932.307	04.03 -		 3488 000 102 ⊕	400 GMFZ2/ 400N	für Nebenantrieb / for PTO für Fahrzeuge mit Zweis Scheibenkupplung / for vehicles with double disc clutch enthält eine Kupplungsscheibe / This part number includes one clutch disc	(82) (77) (67)
3246 930.306	04.03 -					
3246 B 953.304/305	10.97 -					
3246 B 933.305 933.307 933.304	04.03 -		 1878 002 024 ▽	400 18 400WGTZ	für Nebenantrieb / for PTO für Fahrzeuge mit Zweis Scheibenkupplung / for vehicles with double disc clutch Lose Kupplungsscheibe / Loose clutch disc	(82) (77) (41)
3246 K 952.304/305	10.97 -					
3246 K 932.304 932.307 932.305	04.03 -		 3400 121 501 (M) ⊕ ⊗ 3488 023 031 ⊗ 1878 002 024	400 18 MFZ2/400X 400WGTZ	Nabenprofil / Hub Profile: 45x50-18N für Fahrzeuge mit Zweis Scheibenkupplung / for vehicles with double disc clutch	(48) (77)
3248, L 930.306	04.03 -		 3400 700 355 (H) ⊕ ⊗ 3488 000 158 ⊗ 1878 002 019	400 18 MFZ2/400X 400WGTZ	Getr. / GBox: Powershift für Fahrzeuge mit Zweis Scheibenkupplung / for vehicles with double disc clutch	(77)
3248 B 933.307 933.305 933.304	04.03 -		 1863 869 028			
3248 K 932.307 932.304/305	04.03 -		 6284 605 064		Füllmedium: Bremsflüssigkeit / Fill Medium: Brake Fluid	(25)
3331 950.163 950.162	04.97 - 10.02		6284 605 065		Füllmedium: Mineralöl / Fill Medium: Mineral Oil	(26)
3331 932.163 930.162 932.183 930.182 932.161 932.182 932.162 930.163 930.183	04.03 -		 3189 600 057 3189 600 058		für Nebenantrieb / for PTO	(82)
3331, 3332 930.162/163	04.03 -					
3331 A 950.183 950.182	04.97 - 10.02					
3331 A, 3332 A 930.183 930.182	04.03 -					
3331 AK 952.183 952.182	04.97 - 10.02					
3331 AK, 3332 AK 932.182/183	04.03 -					
3331 AS 954.182	04.97 - 10.02					
3331 B 953.163 953.162 953.161	04.97 - 10.02					
3331 K 952.162/163 952.161	04.97 - 10.02					
3331 S 954.161	04.97 - 10.02					
3331 S, 3332 S 934.161	04.03 -					
3332 AK 932.183 932.182	04.03 -					
3332 AS 934.182	04.03 -					
3332 B 933.162 933.161 933.163	04.03 -					
3332 B 933.307 933.304 933.306 933.305	01.03 -					
3332 K 932.161-163	04.03 -					
3335 950.162	04.97 - 10.02					
3335 AK 952.182/183	10.97 - 10.03					
3335 B 953.163 953.161/162	04.97 - 10.02					
3335 K 952.163 952.162 952.161	04.97 - 10.02					
3335 S 954.161	04.97 - 10.02					
3336 930.162/163	04.03 -					













		CODE				
--	--	------	--	---	---	---

MERCEDES-BENZ

ACTROS 3231 - 3339		06.96 -						
3336 A 930.183 930.182 3336 AK 932.182/183 3336 AS 934.182 3336 B 933.162 933.161 933.163 3336 B 933.307 933.306 933.304 933.305 3336 K 932.305 932.307 932.304 3336 K 932.161-163 3336 S 954.161 3336 S 934.161	04.03-	OM541	 3400 122 801 ⊕ ⊗ 3483 030 032 ⊗ 1878 007 072	430 18 MFZ430 430WGTZ	für Fahrzeuge mit Einscheibenkupplung / for vehicles with single disc clutch	(72)		
	04.03-		 3400 700 446 ⊕ ⊗ 3483 000 258 ⊗ 1878 007 072	430 18 MFZ430 430WGTZ	für / for: SA 504682-22/24 für Fahrzeuge mit Einscheibenkupplung / for vehicles with single disc clutch	(69) (72)		
	04.03-		 3400 700 416 ⊕ ⊗ 3483 000 139 ⊗ 1878 007 072	430 18 GMFZ430N 430WGTZ	für Nebenantrieb / for PTO für Fahrzeuge mit Einscheibenkupplung / for vehicles with single disc clutch	(82) (72)		
	01.03-		 3488 000 102 ⊕	400 GMFZ2/ 400N	für Nebenantrieb / for PTO für Fahrzeuge mit Zweis Scheibenkupplung / for vehicles with double disc clutch enthält eine Kupplungsscheibe / This part number includes one clutch disc	(82) (77) (67)		
	04.03-		 1878 002 024 ▽	400 18 400WGTZ	für Nebenantrieb / for PTO für Fahrzeuge mit Zweis Scheibenkupplung / for vehicles with double disc clutch Lose Kupplungsscheibe / Loose clutch disc	(82) (77) (41)		
	10.97-		 3400 121 501 ⊕ ⊗ 3488 023 031 ⊗ 1878 002 024	400 18 MFZ2/400X 400WGTZ	Nabenprofil / Hub Profile: 45x50-18N für Fahrzeuge mit Zweis Scheibenkupplung / for vehicles with double disc clutch	(48) (77)		
	04.03-		 3400 700 355 ⊕ ⊗ 3488 000 158 ⊗ 1878 002 019	400 18 MFZ2/400X 400WGTZ	Getr. / GBox: Powershift für Fahrzeuge mit Zweis Scheibenkupplung / for vehicles with double disc clutch	(77)		
				 1863 869 028				
				 6284 605 064		Füllmedium: Bremsflüssigkeit / Fill Medium: Brake Fluid	(25)	
				6284 605 065		Füllmedium: Mineralöl / Fill Medium: Mineral Oil	(26)	
				 3189 600 057				
				3189 600 058		für Nebenantrieb / for PTO	(82)	
	3250 930.163 930.162 3255 L 930.162		04.03-	OM542	 3400 700 415 ⊕ ⊗ 3483 030 032 ⊗ 1878 002 732	430 18 MFZ430 430WGTZ	für Fahrzeuge mit Einscheibenkupplung / for vehicles with single disc clutch	(72)
			02.09-		 3400 121 501 ⊕ ⊗ 3488 023 031 ⊗ 1878 002 024	400 18 MFZ2/400X 400WGTZ	Nabenprofil / Hub Profile: 45x50-18N für Fahrzeuge mit Zweis Scheibenkupplung / for vehicles with double disc clutch	(48) (77)
					 3400 700 355 ⊕ ⊗ 3488 000 158 ⊗ 1878 002 019	400 18 MFZ2/400X 400WGTZ	Getr. / GBox: Powershift für Fahrzeuge mit Zweis Scheibenkupplung / for vehicles with double disc clutch	(77)
		 3488 000 102 ⊕	400 GMFZ2/ 400N		für Nebenantrieb / for PTO für Fahrzeuge mit Zweis Scheibenkupplung / for vehicles with double disc clutch enthält eine Kupplungsscheibe / This part number includes one clutch disc	(82) (77) (67)		
		 1878 002 024 ▽	400 18 400WGTZ		für Nebenantrieb / for PTO für Fahrzeuge mit Zweis Scheibenkupplung / for vehicles with double disc clutch Lose Kupplungsscheibe / Loose clutch disc	(82) (77) (41)		
		 1863 869 028						
		 6284 605 065			Füllmedium: Mineralöl / Fill Medium: Mineral Oil	(26)		
		 6284 605 064			Füllmedium: Bremsflüssigkeit / Fill Medium: Brake Fluid	(25)		
		 3189 600 057						
		3189 600 058			für Nebenantrieb / for PTO	(82)		











		CODE		 Parameter		
--	--	------	--	---	---	---

MERCEDES-BENZ

ACTROS 3231 - 3339		06.96 -					
3260 L 930.162	02.09-	OM542	 3400 700 468 ⊕ ⊕ 3483 000 422 ⊕ 1878 006 101	430 18 MFZ430 430WGTZ	für Fahrzeuge mit Einscheibenkupplung / for vehicles with single disc clutch	(72)	
			 3400 121 501 ⊕ ⊕ 3488 023 031 ⊕ 1878 002 024	400 18 MFZ2/400X 400WGTZ	Nabenprofil / Hub Profile: 45x50-18N für Fahrzeuge mit Zweischeibenkupplung / for vehicles with double disc clutch	(48) (77)	
			 3400 700 355 ⊕ ⊕ 3488 000 158 ⊕ 1878 002 019	400 18 MFZ2/400X 400WGTZ	Getr. / GBox: Powershift für Fahrzeuge mit Zweischeibenkupplung / for vehicles with double disc clutch	(77)	
			 3488 000 102 ⊕	400 GMFZ2/ 400N	für Nebenantrieb / for PTO für Fahrzeuge mit Zweischeibenkupplung / for vehicles with double disc clutch enthält eine Kupplungsscheibe / This part number includes one clutch disc	(82) (77) (67)	
			 1878 002 024 ▽	400 18 400WGTZ	für Nebenantrieb / for PTO für Fahrzeuge mit Zweischeibenkupplung / for vehicles with double disc clutch Lose Kupplungsscheibe / Loose clutch disc	(82) (77) (41)	
			 1863 869 028				
			 6284 605 065 6284 605 064		Füllmedium: Mineralöl / Fill Medium: Mineral Oil	(26) (25)	
			 3189 600 057 3189 600 058		für Nebenantrieb / for PTO	(82)	
			3333 L 963.026 3333 LS 963.426 3336 L 963.026 3336 LS 963.426	07.11-	OM470	 3400 700 533 ⊕	430 18
07.11-	 3400 700 531 ⊕	430 18		XTend Getr. / GBox: Powershift Nabenprofil / Hub Profile: 45x50-18N Euro 6 / Euro 6 Nur zusammen verbauen / Only install together		(48) (18) (53)	
07.11-	3400 710 071 ⊕	430 18		Getr. / GBox: Powershift Nabenprofil / Hub Profile: 45x50-18N Euro 6 / Euro 6 mit automatischer Nachstellung / with automatic adjustment Nur zusammen verbauen / Only install together		(48) (18) (95) (53)	
07.11-	 3400 700 542 ⊕	430 18		XTend Getr. / GBox: Powershift Nabenprofil / Hub Profile: 45x50-18N Euro 6 / Euro 6 Nur zusammen verbauen / Only install together		(48) (18) (53)	
	 3400 710 074 ⊕	430 18		Getr. / GBox: Powershift Nabenprofil / Hub Profile: 45x50-18N Euro 6 / Euro 6 mit automatischer Nachstellung / with automatic adjustment Nur zusammen verbauen / Only install together		(48) (18) (95) (53)	
	 6482 000 218	PHIS-6/38		Getr. / GBox: Powershift Euro 6 / Euro 6 Immer erneuern / Renew everytime		(18) (30)	















		CODE				
--	--	------	--	---	---	---

MERCEDES-BENZ

ACTROS 3340 - 3550		06.96 -				
3340 950.163	04.97 - 10.02	OM541		3400 122 801 ⊕ ⊗ 3483 030 032 ⊗ 1878 007 072	430 18 MFZ430 430WGTZ	für Fahrzeuge mit Einscheibenkupplung / for vehicles with single disc clutch (72)
3340 A 950.182/183	04.97 - 10.02			3400 700 446 ⊕ ⊗ 3483 000 258 ⊗ 1878 007 072	430 18 MFZ430 430WGTZ	für / for: SA 504682-22/24 für Fahrzeuge mit Einscheibenkupplung / for vehicles with single disc clutch (69) (72)
3340 AK 952.182/183	04.97 - 10.02			3400 700 416 ⊕ ⊗ 3483 000 139 ⊗ 1878 007 072	430 18 GMFZ430N 430WGTZ	für Nebenantrieb / for PTO für Fahrzeuge mit Einscheibenkupplung / for vehicles with single disc clutch (82) (72)
3340 AS 954.182	04.97 - 10.02			3488 000 102 ⊕	400 GMFZ2/ 400N	für Nebenantrieb / for PTO für Fahrzeuge mit Zweis Scheibenkupplung / for vehicles with double disc clutch enthält eine Kupplungsscheibe / This part number includes one clutch disc (82) (77)
3340 B 953.162/163 953.161	04.97 - 10.02			1878 002 024 ▽	400 18 400WGTZ	für Nebenantrieb / for PTO für Fahrzeuge mit Zweis Scheibenkupplung / for vehicles with double disc clutch Lose Kupplungsscheibe / Loose clutch disc (82) (77)
3340 B 953.305	04.97 - 10.02					
3340 K 952.163 952.161/162	04.97 - 10.02					
3340 S 954.161	04.03 -			3400 121 501 (M) ⊕ ⊗ 3488 023 031 ⊗ 1878 002 024	400 18 MFZ2/400X 400WGTZ	Nabenprofil / Hub Profile: 45x50-18N für Fahrzeuge mit Zweis Scheibenkupplung / for vehicles with double disc clutch (48) (77)
3341 930.163 930.162	04.03 -			3400 700 355 (H) ⊕ ⊗ 3488 000 158 ⊗ 1878 002 019	400 18 MFZ2/400X 400WGTZ	Getr. / GBox: Powershift für Fahrzeuge mit Zweis Scheibenkupplung / for vehicles with double disc clutch (77)
3341 A 930.183 930.182	04.03 -					
3341 AK 932.182/183	04.03 -					
3341 AS 934.182	04.03 -					
3341 B 933.163 933.161/162	04.03 -			1863 869 028		
3341 B 933.304 933.306 933.305 /307	01.03 -			6284 605 064		Füllmedium: Bremsflüssigkeit / Fill Medium: Brake Fluid (25)
3341 K 932.161 932.163 932.162	01.03 -			6284 605 065		Füllmedium: Mineralöl / Fill Medium: Mineral Oil (26)
3341 S 954.161	04.03 -			3189 600 057		
3341 S 934.161	04.03 -			3189 600 058		für Nebenantrieb / for PTO (82)
3343 950.162/163	10.97 -					
3343 AK 952.183 952.182	04.03 -					
3343 AK 932.182/183	04.97 - 10.02					
3343 AS 954.182	04.97 - 10.02					
3343 B 953.305	04.03 -					
3343 B 933.162/163 933.161	04.03 -					
3343 K 952.161 952.163	04.97 - 10.02					
3343 K 932.162 932.161 932.163	04.97 - 10.02					
3343 S 954.161	04.03 -					
3344 930.162/163	04.03 -					
3344 A 930.182/183	04.03 -					
3344 AK 932.182/183	04.03 -					
3344 AS 934.182/183	04.03 -					
3344 B 933.163 933.161/162	04.03 -					
3344 B 933.307 933.306 933.304 933.305	01.03 -					
3344 K 932.162/163 932.161	04.03 -					
3344 S 934.161	04.03 -					
3346 950.163	04.97 - 10.02					
3346 930.163 930.162	04.03 -					























		CODE				
--	--	------	--	---	---	---

MERCEDES-BENZ

ACTROS 3340 - 3550		06.96 -					
3346 A 930.183 930.182 3346 AK 952.183 952.182 3346 AK 932.182/183 3346 AS 954.182 3346 AS 934.182 3346 B 933.162/163 933.161 3346 B 933.306 933.304 933.305 933.307 3346 K 952.163 952.161 3346 K 932.162 932.161 932.163 3346 S 954.161 3346 S 934.161 3348 930.163 930.162 3348 AK 932.183 932.182 3348 AS 934.182 3348 B 933.161 933.163 933.162 3348 K 932.161-163 3348 S 934.161	04.03-	OM541	 3400 122 801 ⊕ ⊗ 3483 030 032 ⊗ 1878 007 072	430 18 MFZ430 430WGTZ	für Fahrzeuge mit Einscheibenkupplung / for vehicles with single disc clutch (72)		
	10.97-		 3400 700 446 ⊕ ⊗ 3483 000 258 ⊗ 1878 007 072	430 18 MFZ430 430WGTZ	für / for: SA 504682-22/24 für Fahrzeuge mit Einscheibenkupplung / for vehicles with single disc clutch (69) (72)		
	04.03-		 3400 700 416 ⊕ ⊗ 3483 000 139 ⊗ 1878 007 072	430 18 GMFZ430N 430WGTZ	für Nebenantrieb / for PTO für Fahrzeuge mit Einscheibenkupplung / for vehicles with single disc clutch (82) (72)		
	10.97-		 3488 000 102 ⊕	400 GMFZ2/ 400N	für Nebenantrieb / for PTO für Fahrzeuge mit Zweischeibenkupplung / for vehicles with double disc clutch (82) enthält eine Kupplungsscheibe / This part number includes one clutch disc (77) (67)		
	04.03-		 1878 002 024 ▽	400 18 400WGTZ	für Nebenantrieb / for PTO für Fahrzeuge mit Zweischeibenkupplung / for vehicles with double disc clutch (82) Lose Kupplungsscheibe / Loose clutch disc (77) (41)		
	04.03-		 3400 121 501 ⊕ ⊗ 3488 023 031 ⊗ 1878 002 024	400 18 MFZ2/400X 400WGTZ	Nabenprofil / Hub Profile: 45x50-18N für Fahrzeuge mit Zweischeibenkupplung / for vehicles with double disc clutch (48) (77)		
	10.97-		 3400 700 355 ⊕ ⊗ 3488 000 158 ⊗ 1878 002 019	400 18 MFZ2/400X 400WGTZ	Getr. / GBox: Powershift für Fahrzeuge mit Zweischeibenkupplung / for vehicles with double disc clutch (77)		
	04.03-		 1863 869 028				
	04.03-		 6284 605 064		Füllmedium: Bremsflüssigkeit / Fill Medium: Brake Fluid (25)		
	04.03-		6284 605 065		Füllmedium: Mineralöl / Fill Medium: Mineral Oil (26)		
	04.03-		 3189 600 057				
	04.03-		3189 600 058		für Nebenantrieb / for PTO (82)		
	04.03-						
	04.03-						
	04.03-						
	3340 L 963.026 3340 LS 963.426 3343 L 963.026 3343 LS 963.426		07.11-	OM470	 3400 700 533 ⊕ ⊗ 3488 000 158 ⊗ 1878 002 019	430 18	XTend Nabenprofil / Hub Profile: 45x50-18N Euro 6 / Euro 6 Nur zusammen verbauen / Only install together (48) (18) (53)
			07.11-		 3400 700 531 ⊕ ⊗ 3488 000 158 ⊗ 1878 002 019	430 18	XTend Getr. / GBox: Powershift Nabenprofil / Hub Profile: 45x50-18N Euro 6 / Euro 6 Nur zusammen verbauen / Only install together (48) (18) (53)
07.11-		3400 710 071 ⊕ ⊗ 3488 000 158 ⊗ 1878 002 019	430 18		Getr. / GBox: Powershift Nabenprofil / Hub Profile: 45x50-18N Euro 6 / Euro 6 mit automatischer Nachstellung / with automatic adjustment Nur zusammen verbauen / Only install together (48) (18) (95) (53)		
07.11-		 3400 700 542 ⊕ ⊗ 3488 000 158 ⊗ 1878 002 019	430 18		XTend Getr. / GBox: Powershift Nabenprofil / Hub Profile: 45x50-18N Euro 6 / Euro 6 Nur zusammen verbauen / Only install together (48) (18) (53)		
07.11-		 3400 710 074 ⊕ ⊗ 3488 000 158 ⊗ 1878 002 019	430 18		Getr. / GBox: Powershift Nabenprofil / Hub Profile: 45x50-18N Euro 6 / Euro 6 mit automatischer Nachstellung / with automatic adjustment Nur zusammen verbauen / Only install together (48) (18) (95) (53)		
07.11-		 6482 000 218	PHIS-6/38		Getr. / GBox: Powershift Euro 6 / Euro 6 Immer erneuern / Renew everytime (18) (30)		
07.11-							











		CODE				
--	--	------	--	---	---	---

MERCEDES-BENZ

ACTROS 3340 - 3550		06.96 -						
3342 L 963.026 3342 LS 963.426	07.11-	OM471		3400 700 533 	430 18	XTend Nabenprofil / Hub Profile: 45x50-18N Euro 6 / Euro 6 Nur zusammen verbauen / Only install together	(48) (18) (53)	
	07.11-			3400 700 531 	430 18	XTend Getr. / GBox: Powershift Nabenprofil / Hub Profile: 45x50-18N Euro 6 / Euro 6 Nur zusammen verbauen / Only install together	(48) (18) (53)	
				3400 710 071 	430 18	Getr. / GBox: Powershift Nabenprofil / Hub Profile: 45x50-18N Euro 6 / Euro 6 mit automatischer Nachstellung / with automatic adjustment Nur zusammen verbauen / Only install together	(48) (18) (95) (53)	
					3400 700 542 	430 18	XTend Getr. / GBox: Powershift Nabenprofil / Hub Profile: 45x50-18N Euro 6 / Euro 6 Nur zusammen verbauen / Only install together	(48) (18) (53)
					3400 710 074 	430 18	Getr. / GBox: Powershift Nabenprofil / Hub Profile: 45x50-18N Euro 6 / Euro 6 mit automatischer Nachstellung / with automatic adjustment Nur zusammen verbauen / Only install together	(48) (18) (95) (53)
					6482 000 218	PHIS-6/38	Getr. / GBox: Powershift Euro 6 / Euro 6 Immer erneuern / Renew everytime	(18) (30)
3345 L 963.026 3345 LS 963.426 3348 L 963.026 3348 LS 963.426	07.11-	OM471		3400 700 545 		XTend Euro 6 / Euro 6	(18)	
	07.11-			3400 700 541 	430 18	XTend Getr. / GBox: Powershift Nabenprofil / Hub Profile: 45x50-18N Euro 6 / Euro 6 Nur zusammen verbauen / Only install together	(48) (18) (53)	
	07.11-			3400 710 072 	430 18	Getr. / GBox: Powershift Nabenprofil / Hub Profile: 45x50-18N Euro 6 / Euro 6 mit automatischer Nachstellung / with automatic adjustment Nur zusammen verbauen / Only install together	(48) (18) (95) (53)	
	07.11-			3400 700 543 	430 18	XTend Getr. / GBox: Powershift Nabenprofil / Hub Profile: 45x50-18N Euro 6 / Euro 6 Nur zusammen verbauen / Only install together	(48) (18) (53)	
				3400 710 075 	430 18	Getr. / GBox: Powershift Nabenprofil / Hub Profile: 45x50-18N Euro 6 / Euro 6 mit automatischer Nachstellung / with automatic adjustment Nur zusammen verbauen / Only install together	(48) (18) (95) (53)	
					6482 000 218	PHIS-6/38	Getr. / GBox: Powershift Euro 6 / Euro 6 Immer erneuern / Renew everytime	(18) (30)













































		CODE		 Parameter		
--	--	------	--	---	---	---

MERCEDES-BENZ

ACTROS 3340 - 3550		06.96 -					
3348 950.163 950.162	04.97 - 10.02	OM542		3400 700 415 ⊕ ⊗ 3483 030 032 ⊗ 1878 002 732	430 18 MFZ430 430WGTZ	für Fahrzeuge mit Einscheibenkupplung / for vehicles with single disc clutch	(72)
3348 930.163 930.162	04.03 -			3400 121 501 ⊕ ⊗ ⊗ 3488 023 031 ⊗ 1878 002 024	400 18 MFZ2/400X 400WGTZ	Nabenprofil / Hub Profile: 45x50-18N für Fahrzeuge mit Zweis Scheibenkupplung / for vehicles with double disc clutch	(48) (77)
3348 AK 952.182	04.97 - 10.02			3400 700 355 ⊕ ⊗ ⊗ 3488 000 158 ⊗ 1878 002 019	400 18 MFZ2/400X 400WGTZ	Getr. / GBox: Powershift für Fahrzeuge mit Zweis Scheibenkupplung / for vehicles with double disc clutch	(77)
3348 AS 954.182	04.97 - 10.02			3488 000 102 ⊕	400 GMFZ2/ 400N	für Nebenantrieb / for PTO für Fahrzeuge mit Zweis Scheibenkupplung / for vehicles with double disc clutch enthält eine Kupplungsscheibe / This part number includes one clutch disc	(82) (77)
3348 AK 932.183 932.182	04.03 -			1878 002 024 ▽	400 18 400WGTZ	für Nebenantrieb / for PTO für Fahrzeuge mit Zweis Scheibenkupplung / for vehicles with double disc clutch Lose Kupplungsscheibe / Loose clutch disc	(82) (77)
3348 K 952.161 952.163	04.97 - 10.02			1863 869 028			
3348 K 932.163 932.161	04.03 -			6284 605 064		Füllmedium: Bremsflüssigkeit / Fill Medium: Brake Fluid	(25)
3348 S 954.161	04.97 - 10.02			6284 605 065		Füllmedium: Mineralöl / Fill Medium: Mineral Oil	(26)
3348 S 934.161	04.03 -			3189 600 057			
3350, 3351 930.162/163	04.03 -			3189 600 058		für Nebenantrieb / for PTO	(82)
3350 AK 952.182	10.97 -						
3350 AS 954.182	10.97 -						
3350 K 952.161 952.163	10.97 -						
3350 S 954.161	10.97 -						
3350 S 934.251	06.09 -						
3350 S 934.161	06.09 -						
3351 A 930.183 930.182	06.08 -						
3351 AK 932.182/183	04.03 -						
3351 S 934.161	04.03 -						
3351 AS 934.182	04.03 -						
3351 K 932.163 932.161	04.03 -						
3353 950.162/163	04.97 - 10.02						
3353 AS 954.182	04.97 - 10.02						
3353 S 954.161	04.97 - 10.02						
3354, 3355 930.162/163	04.03 -						
3355 A 930.182/183	04.03 -						
3355 AS 934.182	04.03 -						
3355 S 934.161	04.03 -						
3355 AK 932.183	04.03 -						

















		CODE				
--	--	------	--	---	---	---

MERCEDES-BENZ

ACTROS 3340 - 3550		06.96 -					
3351 L 963.026 3351 LS 963.426	07.11-	OM471	 3400 700 534   430 18	XTend Nabenprofil / Hub Profile: 45x50-18N Euro 6 / Euro 6 max. übertragbares Motormoment [Nm] / max. transmittable engine torque [Nm]: 2600 Nur zusammen verbauen / Only install together	(48) (18) (87) (53)		
	07.11-		 3400 700 529   430 18	XTend Getr. / GBox: Powershift Nabenprofil / Hub Profile: 45x50-18N Euro 6 / Euro 6 Nur zusammen verbauen / Only install together	(48) (18) (53)		
			 3400 710 073  430 18	Getr. / GBox: Powershift Nabenprofil / Hub Profile: 45x50-18N Euro 6 / Euro 6 mit automatischer Nachstellung / with automatic adjustment Nur zusammen verbauen / Only install together	(48) (18) (95) (53)		
			 3400 700 544   430 18	XTend Getr. / GBox: Powershift Nabenprofil / Hub Profile: 45x50-18N Euro 6 / Euro 6 Nur zusammen verbauen / Only install together	(48) (18) (53)		
			 3400 710 076   430 18	Getr. / GBox: Powershift Nabenprofil / Hub Profile: 45x50-18N Euro 6 / Euro 6 mit automatischer Nachstellung / with automatic adjustment Nur zusammen verbauen / Only install together	(48) (18) (95) (53)		
			 6482 000 218	PHIS-6/38 Getr. / GBox: Powershift Euro 6 / Euro 6 Immer erneuern / Renew everytime	(18) (30)		
3357 950.162 3357 S 954.161 3358 930.162 3358 K 3360 930.162 3360 A 930.183 930.182 3360 AK 932.183	04.97-10.02	OM542	 3400 700 468   430 18	für Fahrzeuge mit Einscheibenkupplung / for vehicles with single disc clutch	(72)		
	04.97-10.02		 3483 000 422	MFZ430			
			 1878 006 101	430WGTZ			
	04.03-		 3400 121 501   400 18	Nabenprofil / Hub Profile: 45x50-18N	(48)		
			 3488 023 031	MFZ2/400X	für Fahrzeuge mit Zweisheibenkupplung / for vehicles with double disc clutch	(77)	
	04.03-		 1878 002 024	400WGTZ			
			 3400 700 355   400 18	Getr. / GBox: Powershift	(77)		
	04.03-		 3488 000 158	MFZ2/400X	für Fahrzeuge mit Zweisheibenkupplung / for vehicles with double disc clutch	(77)	
			 1878 002 019	400WGTZ			
	04.03-		 3488 000 102   400	für Nebenantrieb / for PTO	(82)		
04.03-	 GMFZ2/400N	für Fahrzeuge mit Zweisheibenkupplung / for vehicles with double disc clutch	(77)				
	 1878 002 024  400 18	enthält eine Kupplungsscheibe / This part number includes one clutch disc	(67)				
	 1878 002 024  400 18	für Nebenantrieb / for PTO	(82)				
	 1878 002 024  400 18	für Fahrzeuge mit Zweisheibenkupplung / for vehicles with double disc clutch	(77)				
	 1863 869 028	Lose Kupplungsscheibe / Loose clutch disc	(41)				
	 6284 605 064	Füllmedium: Bremsflüssigkeit / Fill Medium: Brake Fluid	(25)				
	 6284 605 065	Füllmedium: Mineralöl / Fill Medium: Mineral Oil	(26)				
	 3189 600 057						
	 3189 600 058	für Nebenantrieb / for PTO	(82)				











		CODE		 Parameter		
--	--	------	--	---	---	---

MERCEDES-BENZ

ACTROS 3340 - 3550		06.96 -							
3365 A 930.182	04.03-	OM542		3400 121 501  	400 18 MFZ2/400X 400WGTZ	Nabenprofil / Hub Profile: 45x50-18N für Fahrzeuge mit Zweischeibenkupplung / for vehicles with double disc clutch	(48) (77)		
				3488 023 031 1878 002 024					
				3400 700 355  	400 18 MFZ2/400X 400WGTZ	Getr. / GBox: Powershift für Fahrzeuge mit Zweischeibenkupplung / for vehicles with double disc clutch	(77)		
				3488 000 158 1878 002 019					
				3488 000 102 	400 GMFZ2/ 400N	für Nebenantrieb / for PTO für Fahrzeuge mit Zweischeibenkupplung / for vehicles with double disc clutch enthält eine Kupplungsscheibe / This part number includes one clutch disc	(82) (77) (67)		
				1878 002 024 	400 18 400WGTZ	für Nebenantrieb / for PTO für Fahrzeuge mit Zweischeibenkupplung / for vehicles with double disc clutch Lose Kupplungsscheibe / Loose clutch disc	(82) (77) (41)		
				1863 869 028					
				6284 605 065		Füllmedium: Mineralöl / Fill Medium: Mineral Oil	(26)		
				6284 605 064		Füllmedium: Bremsflüssigkeit / Fill Medium: Brake Fluid	(25)		
				3189 600 057 3189 600 058		für Nebenantrieb / for PTO	(82)		



















		CODE				
--	--	------	--	---	---	---

MERCEDES-BENZ

ACTROS 4036 - 4844		06.96 -				
4140 932.317 932.314/315 932.325 932.336		OM541		3400 122 801 ⊕ ⊗ 3483 030 032 ⊗ 1878 007 072	430 18 MFZ430 430WGTZ	für Fahrzeuge mit Einscheibenkupplung / for vehicles with single disc clutch (72)
4140 AK 932.336	04.03-			3400 700 446 ⊕ ⊗ 3483 000 258 ⊗ 1878 007 072	430 18 MFZ430 430WGTZ	für / for: SA 504682-22/24 für Fahrzeuge mit Einscheibenkupplung / for vehicles with single disc clutch (69) (72)
4140 AK 952.336	04.97-10.02			3400 700 416 ⊕ ⊗ 3483 000 139 ⊗ 1878 007 072	430 18 GMFZ430N 430WGTZ	für Nebenantrieb / for PTO für Fahrzeuge mit Einscheibenkupplung / for vehicles with single disc clutch (82) (72)
4140 B 953.314 953.317	04.97-10.02			3488 000 102 ⊕	400 GMFZ2/ 400N	für Nebenantrieb / for PTO für Fahrzeuge mit Zweis Scheibenkupplung / for vehicles with double disc clutch enthält eine Kupplungsscheibe / This part number includes one clutch disc (82) (77)
4140 K 933.317 933.314	04.03-					
4140 K 952.317 952.314/315	04.97-10.02					enthält eine Kupplungsscheibe / This part number includes one clutch disc (67)
4140 K 952.325	04.97-10.02			1878 002 024 ▽	400 18 400WGTZ	für Nebenantrieb / for PTO für Fahrzeuge mit Zweis Scheibenkupplung / for vehicles with double disc clutch Lose Kupplungsscheibe / Loose clutch disc (82) (77)
4140 K 932.325	04.03-					
4140 K 932.325	04.03-					
4140 K 932.315 932.314 932.317		-12.03		3400 121 501 (M) ⊕ ⊗ 3488 023 031 ⊗ 1878 002 024	400 18 MFZ2/400X 400WGTZ	Nabenprofil / Hub Profile: 45x50-18N für Fahrzeuge mit Zweis Scheibenkupplung / for vehicles with double disc clutch (48) (77)
4140 K 952.336	04.03-			3400 700 355 (H) ⊕ ⊗ 3488 000 158 ⊗ 1878 002 019	400 18 MFZ2/400X 400WGTZ	Getr. / GBox: Powershift für Fahrzeuge mit Zweis Scheibenkupplung / for vehicles with double disc clutch (77)
4141 930.319	06.08-			1863 869 028		
4141 AK 932.336	04.03-			6284 605 064		Füllmedium: Bremsflüssigkeit / Fill Medium: Brake Fluid (25)
4141 B 933.317 933.314 933.319	04.03-			6284 605 065		Füllmedium: Mineralöl / Fill Medium: Mineral Oil (26)
4141 B 932.336	06.08-					
4141 K 933.317 932.317 932.314	04.03-			3189 600 057		
4141 K 932.325	04.03-			3189 600 058		für Nebenantrieb / for PTO (82)
4141 L 930.319	01.03-					
4143 AK 952.336	04.97-10.02					
4143 AK 932.336	04.03-					
4143 B 933.314 933.317	04.03-					
4143 K 952.317 952.314/315	04.97-10.02					
4143 K 952.325	04.97-10.02					
4143 K 932.325	04.03-					
4144 AK 932.336	04.03-					
4144 B 933.314 933.319 933.317	04.03-					
4144 B 932.317 932.314/315	06.08-					
4144 K 932.317 932.314/315	04.03-					
4144 K 932.325	04.03-					
4144 K 932.315 932.317 932.314	04.03-					
4146 AK 932.336	04.03-					
4146 AK 952.336	10.97-					
4146 B 933.319 933.314 933.317	04.03-					
4146 B 952.315 952.317 952.314	06.08-					
4146 K 932.315 932.314 932.317	10.97-					
4146 K 932.325	04.03-					
4148 AK 932.336	04.03-					



























		CODE				
--	--	------	--	---	---	---

MERCEDES-BENZ

ACTROS 4036 - 4844		06.96 -						
4148 B 933.314 933.319 933.317 4148 B 06.08- 4148 K 04.03- 932.314/315 932.317	04.03-	OM541	 3400 122 801 ⊕ ⊗ 3483 030 032 ⊗ 1878 007 072	430 18 MFZ430 430WGTZ	für Fahrzeuge mit Einscheibenkupplung / for vehicles with single disc clutch	(72)		
	06.08-		 3400 700 446 ⊕ ⊗ 3483 000 258 ⊗ 1878 007 072	430 18 MFZ430 430WGTZ	für / for: SA 504682-22/24 für Fahrzeuge mit Einscheibenkupplung / for vehicles with single disc clutch	(69) (72)		
	04.03-		 3400 700 416 ⊕ ⊗ 3483 000 139 ⊗ 1878 007 072	430 18 GMFZ430N 430WGTZ	für Nebenantrieb / for PTO für Fahrzeuge mit Einscheibenkupplung / for vehicles with single disc clutch	(82) (72)		
			 3488 000 102 ⊕	400 GMFZ2/ 400N	für Nebenantrieb / for PTO für Fahrzeuge mit Zweis Scheibenkupplung / for vehicles with double disc clutch enthält eine Kupplungsscheibe / This part number includes one clutch disc	(82) (77) (67)		
			 1878 002 024 ▽	400 18 400WGTZ	für Nebenantrieb / for PTO für Fahrzeuge mit Zweis Scheibenkupplung / for vehicles with double disc clutch Lose Kupplungsscheibe / Loose clutch disc	(82) (77) (41)		
			 3400 121 501 ⊕ ⊗ 3488 023 031 ⊗ 1878 002 024	400 18 MFZ2/400X 400WGTZ	Nabenprofil / Hub Profile: 45x50-18N für Fahrzeuge mit Zweis Scheibenkupplung / for vehicles with double disc clutch	(48) (77)		
			 3400 700 355 ⊕ ⊗ 3488 000 158 ⊗ 1878 002 019	400 18 MFZ2/400X 400WGTZ	Getr. / GBox: Powershift für Fahrzeuge mit Zweis Scheibenkupplung / for vehicles with double disc clutch	(77)		
			 1863 869 028					
			 6284 605 064		Füllmedium: Bremsflüssigkeit / Fill Medium: Brake Fluid	(25)		
			6284 605 065		Füllmedium: Mineralöl / Fill Medium: Mineral Oil	(26)		
			 3189 600 057					
			3189 600 058		für Nebenantrieb / for PTO	(82)		
	4148 AK 952.336 4148 AK 932.336 4148 K 952.314/315 4148 K 952.325 4148 K 932.314/315 4148 K 932.325 4150 AK 932.336 4150 K 932.314/315 4150 K 932.325 4151 AK 932.336 4151 K 932.315 932.314 4151 K 932.325 4155 AK 932.336 4155 K 932.314/315		04.97 - 10.02	OM542	 3400 700 415 ⊕ ⊗ 3483 030 032 ⊗ 1878 002 732	430 18 MFZ430 430WGTZ	für Fahrzeuge mit Einscheibenkupplung / for vehicles with single disc clutch	(72)
			04.03-		 3400 121 501 ⊕ ⊗ 3488 023 031 ⊗ 1878 002 024	400 18 MFZ2/400X 400WGTZ	Nabenprofil / Hub Profile: 45x50-18N für Fahrzeuge mit Zweis Scheibenkupplung / for vehicles with double disc clutch	(48) (77)
04.97 - 10.02		 3400 700 355 ⊕ ⊗ 3488 000 158 ⊗ 1878 002 019	400 18 MFZ2/400X 400WGTZ		Getr. / GBox: Powershift für Fahrzeuge mit Zweis Scheibenkupplung / for vehicles with double disc clutch	(77)		
04.03-		 3488 000 102 ⊕	400 GMFZ2/ 400N		für Nebenantrieb / for PTO für Fahrzeuge mit Zweis Scheibenkupplung / for vehicles with double disc clutch enthält eine Kupplungsscheibe / This part number includes one clutch disc	(82) (77) (67)		
04.03-		 1878 002 024 ▽	400 18 400WGTZ		für Nebenantrieb / for PTO für Fahrzeuge mit Zweis Scheibenkupplung / for vehicles with double disc clutch Lose Kupplungsscheibe / Loose clutch disc	(82) (77) (41)		
04.03-		 1863 869 028						
04.03-		 6284 605 064			Füllmedium: Bremsflüssigkeit / Fill Medium: Brake Fluid	(25)		
05.05-		6284 605 065			Füllmedium: Mineralöl / Fill Medium: Mineral Oil	(26)		
04.03-		 3189 600 057						
04.03-		3189 600 058			für Nebenantrieb / for PTO	(82)		
04.03-								
04.03-								
04.03-								
04.03-								



















		CODE		 Parameter		
--	--	------	--	---	---	---

MERCEDES-BENZ







ACTROS 4036 - 4844		06.96 -					
4152 LS 963.426	01.14-	OM471	 3400 700 534  430 18	XTend Nabenprofil / Hub Profile: 45x50-18N Euro 6 / Euro 6 max. übertragbares Motormoment [Nm] / max. transmittable engine torque [Nm]: 2600 Nur zusammen verbauen / Only install together	(48) (18) (87) (53)		
			 3400 700 529  430 18	XTend Getr. / GBox: Powershift Nabenprofil / Hub Profile: 45x50-18N Euro 6 / Euro 6 Nur zusammen verbauen / Only install together	(48) (18) (53)		
			 3400 710 073  430 18	Getr. / GBox: Powershift Nabenprofil / Hub Profile: 45x50-18N Euro 6 / Euro 6 mit automatischer Nachstellung / with automatic adjustment Nur zusammen verbauen / Only install together	(48) (18) (95) (53)		
			 3400 700 544  430 18	XTend Getr. / GBox: Powershift Nabenprofil / Hub Profile: 45x50-18N Euro 6 / Euro 6 Nur zusammen verbauen / Only install together	(48) (18) (53)		
			 3400 710 076  430 18	Getr. / GBox: Powershift Nabenprofil / Hub Profile: 45x50-18N Euro 6 / Euro 6 mit automatischer Nachstellung / with automatic adjustment Nur zusammen verbauen / Only install together	(48) (18) (95) (53)		
			 6482 000 218	PHIS-6/38	Getr. / GBox: Powershift Euro 6 / Euro 6 Immer erneuern / Renew everytime	(18) (30)	
4160 AK 932.336 4160 K 932.315 932.314 4160 S	04.03-	OM542	 3400 700 468  430 18	für Fahrzeuge mit Einscheibenkupplung / for vehicles with single disc clutch	(72)		
	04.03-		 3400 121 501  400 18	Nabenprofil / Hub Profile: 45x50-18N für Fahrzeuge mit Zweisheibenkupplung / for vehicles with double disc clutch	(48) (77)		
	10.02-		 3400 700 355  400 18	Getr. / GBox: Powershift für Fahrzeuge mit Zweisheibenkupplung / for vehicles with double disc clutch	(77)		
			 3488 000 102  400	für Nebenantrieb / for PTO für Fahrzeuge mit Zweisheibenkupplung / for vehicles with double disc clutch enthält eine Kupplungsscheibe / This part number includes one clutch disc	(82) (77) (67)		
			 1878 002 024  400 18	für Nebenantrieb / for PTO für Fahrzeuge mit Zweisheibenkupplung / for vehicles with double disc clutch Lose Kupplungsscheibe / Loose clutch disc	(82) (77) (41)		
			 1863 869 028				
			 6284 605 065	Füllmedium: Mineralöl / Fill Medium: Mineral Oil	(26)		
			 6284 605 064	Füllmedium: Bremsflüssigkeit / Fill Medium: Brake Fluid	(25)		
			 3189 600 057				
			 3189 600 058	für Nebenantrieb / for PTO	(82)		

		CODE				
--	--	------	--	---	---	---









MERCEDES-BENZ

ACTROS 4036 - 4844		06.96 -							
4165 AK 932.336 4165 S	04.03-	OM542		3400 121 501    3488 023 031  1878 002 024	400 18 MFZ2/400X 400WGTZ	Nabenprofil / Hub Profile: 45x50-18N für Fahrzeuge mit Zweischeibenkupplung / for vehicles with double disc clutch	(48) (77)		
	08.08-			3400 700 355    3488 000 158  1878 002 019	400 18 MFZ2/400X 400WGTZ	Getr. / GBox: Powershift für Fahrzeuge mit Zweischeibenkupplung / for vehicles with double disc clutch	(77)		
				3488 000 102 	400 GMFZ2/ 400N	für Nebenantrieb / for PTO für Fahrzeuge mit Zweischeibenkupplung / for vehicles with double disc clutch enthält eine Kupplungsscheibe / This part number includes one clutch disc	(82) (77) (67)		
				1878 002 024 	400 18 400WGTZ	für Nebenantrieb / for PTO für Fahrzeuge mit Zweischeibenkupplung / for vehicles with double disc clutch Lose Kupplungsscheibe / Loose clutch disc	(82) (77) (41)		
				1863 869 028					
				6284 605 065			Füllmedium: Mineralöl / Fill Medium: Mineral Oil	(26)	
				6284 605 064			Füllmedium: Bremsflüssigkeit / Fill Medium: Brake Fluid	(25)	
				3189 600 057					
				3189 600 058			für Nebenantrieb / for PTO	(82)	











MERCEDES-BENZ

ANTOS		07.12 -			
1824 L 963.003/004	07.12-	OM936	 3400 700 532  430 18	XTend Nabenprofil / Hub Profile: 45x50-18N Euro 6 / Euro 6 Nur zusammen verbauen / Only install together	(48) (18) (53)
1824 LS 963.403-406	07.12-				
1827 L 963.003/004	07.12-		 3400 700 530  430 18	XTend Getr. / GBox: Powershift Nabenprofil / Hub Profile: 45x50-18N Euro 6 / Euro 6 Nur zusammen verbauen / Only install together	(48) (18) (53)
1827 LS 963.403-406	07.12-				
1830 L 963.003/004	07.12-		 3400 710 070  430 18	Getr. / GBox: Powershift Nabenprofil / Hub Profile: 45x50-18N Euro 6 / Euro 6 mit automatischer Nachstellung / with automatic adjustment Nur zusammen verbauen / Only install together	(48) (18) (95) (53)
1830 LS 963.406 963.405 963.404 963.403	07.12-				
1832 L 963.004 963.003	07.12-				
1832 LS 963.403 963.406 963.405 963.404	07.12-		 6482 000 218	PHIS-6/38 Getr. / GBox: Powershift Euro 6 / Euro 6 Immer erneuern / Renew everytime	(18) (30)
1835 L 963.004 963.003	07.12-				
1835 LS 963.405/406 963.404 963.403	07.12-				
2024 L 963.002	07.12-				
2024 LS 963.402	07.12-				
2027 L 963.002	07.12-				
2027 LS 963.402	07.12-				
2030 L 963.002	07.12-				
2030 LS 963.402	07.12-				
2032 L 963.002	07.12-				
2032 LS 963.402	07.12-				
2035 L 963.002	07.12-				
2035 LS 963.402	07.12-				
2427 LS 963.427	07.12-				
2430 LS 963.427	07.12-				
2432 LS 963.427	07.12-				
2435 LS 963.427	07.12-				
2527 L 963.020/021	07.12-				
2527 LS 963.423 963.420	07.12-				
2527 LS 963.423	07.12-				
2530 L 963.020/021	07.12-				
2530 LS 963.420 963.423	07.12-				
2530 LS 963.423	07.12-				
2532 L 963.020/021	07.12-				
2532 LS 963.423 963.420	07.12-				
2532 LS 963.423	07.12-				
2535 L 963.020/021	07.12-				
2535 LS 963.420 963.423	07.12-				
2535 LS 963.423	07.12-				





















MERCEDES-BENZ

ANTOS		07.12 -					
2627 L 963.025	07.12-	OM936	 3400 700 532  	430 18	XTend Nabenprofil / Hub Profile: 45x50-18N Euro 6 / Euro 6 Nur zusammen verbauen / Only install together	(48) (18) (53)	
2627 L 963.024	07.12-		 3400 700 530  	430 18	XTend Getr. / GBox: Powershift Nabenprofil / Hub Profile: 45x50-18N Euro 6 / Euro 6 Nur zusammen verbauen / Only install together	(48) (18) (53)	
2627 LS 963.424	07.12-		 3400 710 070 	430 18	Getr. / GBox: Powershift Nabenprofil / Hub Profile: 45x50-18N Euro 6 / Euro 6 mit automatischer Nachstellung / with automatic adjustment Nur zusammen verbauen / Only install together	(48) (18) (95) (53)	
2630 L 963.024	07.12-		 6482 000 218	PHIS-6/38	Getr. / GBox: Powershift Euro 6 / Euro 6 Immer erneuern / Renew everytime	(18) (30)	
2630 L 963.024	07.12-						
2630 LS 963.424	07.12-						
2632 L 963.025	07.12-						
2632 L 963.024	07.12-						
2632 LS 963.425	07.12-						
2632 LS 963.424	07.12-						
2635 L 963.025	07.12-						
2635 L 963.024	07.12-						
2635 LS 963.425	07.12-						
2635 LS 963.424	07.12-						

MERCEDES-BENZ



































ANTOS		07.12 -			
1833 L 963.003 963.005 963.004	07.12-	OM470	 3400 700 533  430 18	XTend Nabenprofil / Hub Profile: 45x50-18N Euro 6 / Euro 6 Nur zusammen verbauen / Only install together	(48) (18) (53)
1833 LS 963.403-406	07.12-		 3400 700 531  430 18	XTend Getr. / GBox: Powershift Nabenprofil / Hub Profile: 45x50-18N Euro 6 / Euro 6 Nur zusammen verbauen / Only install together	(48) (18) (53)
1836 L 963.003-005	07.12-		3400 710 071  430 18	Getr. / GBox: Powershift Nabenprofil / Hub Profile: 45x50-18N Euro 6 / Euro 6 mit automatischer Nachstellung / with automatic adjustment Nur zusammen verbauen / Only install together	(48) (18) (95) (53)
1836 LS 963.403 963.406 963.404/405	07.12-				
1840 L 963.003-005	07.12-				
1840 LS 963.406 963.403-405	07.12-				
2033 L 963.002	07.12-				
2033 LS 963.402	07.12-		 3400 700 542  430 18	XTend Getr. / GBox: Powershift Nabenprofil / Hub Profile: 45x50-18N Euro 6 / Euro 6 Nur zusammen verbauen / Only install together	(48) (18) (53)
2036 L 963.002	07.12-				
2036 LS 963.402	07.12-		 3400 710 074  430 18	Getr. / GBox: Powershift Nabenprofil / Hub Profile: 45x50-18N Euro 6 / Euro 6 mit automatischer Nachstellung / with automatic adjustment Nur zusammen verbauen / Only install together	(48) (18) (95) (53)
2040 L 963.002	07.12-				
2040 LS 963.402	07.12-				
2433 LS 963.427	07.12-		 6482 000 218	PHIS-6/38 Getr. / GBox: Powershift Euro 6 / Euro 6 Immer erneuern / Renew everytime	(18) (30)
2436 LS 963.427	07.12-				
2440 LS 963.427	07.12-				
2533 L 963.020/021	07.12-				
2533 LS 963.423	07.12-				
2533 LS 963.420 963.423	07.12-				
2536 L 963.020/021	07.12-				
2536 LS 963.420 963.423	07.12-				
2540 L 963.020/021	07.12-				
2540 LS 963.423 963.420	07.12-				
2540 LS 963.423	07.12-				
2633 L 963.025	07.12-				
2633 L 963.024	07.12-				
2633 LS 963.425	07.12-				
2633 LS 963.424	07.12-				
2636 L 963.025	07.12-				
2636 L 963.024	07.12-				
2636 LS 963.425	07.12-				
2636 LS 963.424	07.12-				
2640 L 963.025	07.12-				
2640 L 963.024	07.12-				

MERCEDES-BENZ

























ANTOS		07.12 -					
2640 LS 963.425	07.12-	OM470	 3400 700 533  430 18	XTend Nabenprofil / Hub Profile: 45x50-18N Euro 6 / Euro 6 Nur zusammen verbauen / Only install together	(48) (18) (53)		
2640 LS 963.424	07.12-		 3400 700 531  430 18	XTend Getr. / GBox: Powershift Nabenprofil / Hub Profile: 45x50-18N Euro 6 / Euro 6 Nur zusammen verbauen / Only install together	(48) (18) (53)		
2642 L 963.025	07.12-						
3333 L 963.026	07.12-		3400 710 071  430 18	Getr. / GBox: Powershift Nabenprofil / Hub Profile: 45x50-18N Euro 6 / Euro 6 mit automatischer Nachstellung / with automatic adjustment Nur zusammen verbauen / Only install together	(48) (18) (95) (53)		
3333 LS 963.426	07.12-						
3336 L 963.026	07.12-						
3336 LS 963.426	07.12-		 3400 700 542  430 18	XTend Getr. / GBox: Powershift Nabenprofil / Hub Profile: 45x50-18N Euro 6 / Euro 6 Nur zusammen verbauen / Only install together	(48) (18) (53)		
3340 L 963.026	07.12-						
3340 LS 963.426	07.12-		 3400 710 074  430 18	Getr. / GBox: Powershift Nabenprofil / Hub Profile: 45x50-18N Euro 6 / Euro 6 mit automatischer Nachstellung / with automatic adjustment Nur zusammen verbauen / Only install together	(48) (18) (95) (53)		
			 6482 000 218	PHIS-6/38 Getr. / GBox: Powershift Euro 6 / Euro 6 Immer erneuern / Renew everytime	(18) (30)		
1842 L 963.005 963.004 963.003	07.12-	OM471	 3400 700 533  430 18	XTend Nabenprofil / Hub Profile: 45x50-18N Euro 6 / Euro 6 Nur zusammen verbauen / Only install together	(48) (18) (53)		
1842 LS 963.403 963.405 963.404 963.406	07.12-		 3400 700 531  430 18	XTend Getr. / GBox: Powershift Nabenprofil / Hub Profile: 45x50-18N Euro 6 / Euro 6 Nur zusammen verbauen / Only install together	(48) (18) (53)		
2042 L 963.002	07.12-						
2042 LS 963.402	07.12-		3400 710 071  430 18	Getr. / GBox: Powershift Nabenprofil / Hub Profile: 45x50-18N Euro 6 / Euro 6 mit automatischer Nachstellung / with automatic adjustment Nur zusammen verbauen / Only install together	(48) (18) (95) (53)		
2442 LS 963.427	07.12-						
2542 L 963.021 963.020	07.12-						
2542 LS 963.420 963.423	07.12-		 3400 700 542  430 18	XTend Getr. / GBox: Powershift Nabenprofil / Hub Profile: 45x50-18N Euro 6 / Euro 6 Nur zusammen verbauen / Only install together	(48) (18) (53)		
2542 LS 963.423	07.12-						
2642 L 963.024	07.12-						
2642 LS 963.425	07.12-		 3400 710 074  430 18	Getr. / GBox: Powershift Nabenprofil / Hub Profile: 45x50-18N Euro 6 / Euro 6 mit automatischer Nachstellung / with automatic adjustment Nur zusammen verbauen / Only install together	(48) (18) (95) (53)		
2642 LS 963.424	07.12-						
3342 L 963.026	07.12-						
3342 LS 963.426	07.12-		 6482 000 218	PHIS-6/38 Getr. / GBox: Powershift Euro 6 / Euro 6 Immer erneuern / Renew everytime	(18) (30)		

		CODE				
--	--	------	--	---	---	---

MERCEDES-BENZ











ANTOS		07.12 -				
1843 L 963.005 963.003/004	07.12-	OM470	 3400 700 545 		XTend Euro 6 / Euro 6	(18)
1843 LS 963.406 963.403 963.405 963.404	07.12-		 3400 700 541 	430 18	XTend Getr. / GBox: Powershift Nabenprofil / Hub Profile: 45x50-18N Euro 6 / Euro 6 Nur zusammen verbauen / Only install together	(48) (18) (53)
2043 L 963.002	07.12-		 3400 710 072 	430 18	Getr. / GBox: Powershift Nabenprofil / Hub Profile: 45x50-18N Euro 6 / Euro 6 mit automatischer Nachstellung / with automatic adjustment Nur zusammen verbauen / Only install together	(48) (18) (95) (53)
2043 LS 963.402	07.12-		 3400 700 543 	430 18	XTend Getr. / GBox: Powershift Nabenprofil / Hub Profile: 45x50-18N Euro 6 / Euro 6 Nur zusammen verbauen / Only install together	(48) (18) (53)
2443 LS 963.427	07.12-		 3400 710 075 	430 18	Getr. / GBox: Powershift Nabenprofil / Hub Profile: 45x50-18N Euro 6 / Euro 6 mit automatischer Nachstellung / with automatic adjustment Nur zusammen verbauen / Only install together	(48) (18) (95) (53)
2543 L 963.020/021	07.12-		 6482 000 218	PHIS-6/38	Getr. / GBox: Powershift Euro 6 / Euro 6 Immer erneuern / Renew everytime	(18) (30)
2543 LS 963.423 963.420	07.12-		 3400 700 545 		XTend Euro 6 / Euro 6	(18)
2543 LS 963.423	07.12-		 3400 700 541 	430 18	XTend Getr. / GBox: Powershift Nabenprofil / Hub Profile: 45x50-18N Euro 6 / Euro 6 Nur zusammen verbauen / Only install together	(48) (18) (53)
2643 L 963.024	07.12-		 3400 710 072 	430 18	Getr. / GBox: Powershift Nabenprofil / Hub Profile: 45x50-18N Euro 6 / Euro 6 mit automatischer Nachstellung / with automatic adjustment Nur zusammen verbauen / Only install together	(48) (18) (95) (53)
2643 LS 963.424	07.12-		 3400 700 543 	430 18	XTend Getr. / GBox: Powershift Nabenprofil / Hub Profile: 45x50-18N Euro 6 / Euro 6 Nur zusammen verbauen / Only install together	(48) (18) (53)
3343 L 963.026	07.12-		 3400 710 075 	430 18	Getr. / GBox: Powershift Nabenprofil / Hub Profile: 45x50-18N Euro 6 / Euro 6 mit automatischer Nachstellung / with automatic adjustment Nur zusammen verbauen / Only install together	(48) (18) (95) (53)
3343 LS 963.426	07.12-		 6482 000 218	PHIS-6/38	Getr. / GBox: Powershift Euro 6 / Euro 6 Immer erneuern / Renew everytime	(18) (30)
1845 L 963.005 963.004 963.003	07.12-	OM471	 3400 700 545 		XTend Euro 6 / Euro 6	(18)
1845 LS 963.403/404 963.406 963.405	07.12-		 3400 700 541 	430 18	XTend Getr. / GBox: Powershift Nabenprofil / Hub Profile: 45x50-18N Euro 6 / Euro 6 Nur zusammen verbauen / Only install together	(48) (18) (53)
1848 L 963.003-005	07.12-		 3400 710 072 	430 18	Getr. / GBox: Powershift Nabenprofil / Hub Profile: 45x50-18N Euro 6 / Euro 6 mit automatischer Nachstellung / with automatic adjustment Nur zusammen verbauen / Only install together	(48) (18) (95) (53)
1848 LS 963.405 963.404 963.403 963.406	07.12-		 3400 700 543 	430 18	XTend Getr. / GBox: Powershift Nabenprofil / Hub Profile: 45x50-18N Euro 6 / Euro 6 Nur zusammen verbauen / Only install together	(48) (18) (53)
2045 L 963.002	07.12-		 3400 710 075 	430 18	Getr. / GBox: Powershift Nabenprofil / Hub Profile: 45x50-18N Euro 6 / Euro 6 mit automatischer Nachstellung / with automatic adjustment Nur zusammen verbauen / Only install together	(48) (18) (95) (53)
2045 LS 963.402	07.12-		 3400 700 543 	430 18	XTend Getr. / GBox: Powershift Nabenprofil / Hub Profile: 45x50-18N Euro 6 / Euro 6 Nur zusammen verbauen / Only install together	(48) (18) (53)
2048 L 963.002	07.12-		3400 710 075	430 18	Getr. / GBox: Powershift Nabenprofil / Hub Profile: 45x50-18N Euro 6 / Euro 6 mit automatischer Nachstellung / with automatic adjustment Nur zusammen verbauen / Only install together	(48) (18) (95) (53)
2048 LS 963.402	07.12-		6482 000 218	PHIS-6/38	Getr. / GBox: Powershift Euro 6 / Euro 6 Immer erneuern / Renew everytime	(18) (30)
2445 LS 963.427	07.12-					
2448 LS 963.427	07.12-					
2545 L 963.020/021	07.12-					
2545 LS 963.423 963.420	07.12-					
2548 L 963.020/021	07.12-					
2548 LS 963.420 963.423	07.12-					
2643 L 963.025	07.12-					
2643 LS 963.425	07.12-					
2645 L 963.025	07.12-					

MERCEDES-BENZ





ANTOS		07.12 -							
1851 L 963.004 963.003 963.005 1851 LS 963.403/404 963.406 963.405 2051 L 963.002 2051 LS 963.402 2451 LS 963.427 2551 L 963.020/021 2551 LS 963.423 963.420 2551 LS 963.423 2651 L 963.025 2651 L 963.024 2651 LS 963.425 2651 LS 963.424 3351 L 963.026 3351 LS 963.426	07.12-	OM471		3400 700 534 	430 18	XTend Nabenprofil / Hub Profile: 45x50-18N Euro 6 / Euro 6 max. übertragbares Motormoment [Nm] / max. transmittable engine torque [Nm]: 2600 Nur zusammen verbauen / Only install together	(48) (18) (87)		
	07.12-			3400 700 529 	430 18	XTend Getr. / GBox: Powershift Nabenprofil / Hub Profile: 45x50-18N Euro 6 / Euro 6 Nur zusammen verbauen / Only install together	(48) (18) (53)		
	07.12-			3400 710 073 	430 18	Getr. / GBox: Powershift Nabenprofil / Hub Profile: 45x50-18N Euro 6 / Euro 6 mit automatischer Nachstellung / with automatic adjustment Nur zusammen verbauen / Only install together	(48) (18) (95) (53)		
	07.12-			3400 700 544 	430 18	XTend Getr. / GBox: Powershift Nabenprofil / Hub Profile: 45x50-18N Euro 6 / Euro 6 Nur zusammen verbauen / Only install together	(48) (18) (53)		
	07.12-			3400 710 076 	430 18	Getr. / GBox: Powershift Nabenprofil / Hub Profile: 45x50-18N Euro 6 / Euro 6 mit automatischer Nachstellung / with automatic adjustment Nur zusammen verbauen / Only install together	(48) (18) (95) (53)		
	07.12-			6482 000 218	PHIS-6/38	Getr. / GBox: Powershift Euro 6 / Euro 6 Immer erneuern / Renew everytime	(18) (30)		
	07.12-			3400 700 639 	395 18	Euro 6 / Euro 6	(18)		
	07.12-			3400 700 546 	395 18	XTend Getr. / GBox: Powershift Nabenprofil / Hub Profile: 36x40-18N Euro 6 / Euro 6 Nur zusammen verbauen / Only install together	(48) (18) (53)		
	07.12-			6482 000 219	PHIS-5/34	Getr. / GBox: Powershift Euro 6 / Euro 6 Immer erneuern / Renew everytime	(18) (30)		
	2642 L		07.12-	OM471		3400 700 533 	430 18	XTend Nabenprofil / Hub Profile: 45x50-18N Euro 6 / Euro 6 Nur zusammen verbauen / Only install together	(48) (18) (53)
						3400 700 532 	430 18	XTend Getr. / GBox: Powershift Nabenprofil / Hub Profile: 45x50-18N Euro 6 / Euro 6 Nur zusammen verbauen / Only install together	(48) (18) (53)
						3400 700 542 	430 18	XTend Getr. / GBox: Powershift Nabenprofil / Hub Profile: 45x50-18N Euro 6 / Euro 6 Nur zusammen verbauen / Only install together	(48) (18) (53)
			3400 710 074 		430 18	Getr. / GBox: Powershift Nabenprofil / Hub Profile: 45x50-18N Euro 6 / Euro 6 mit automatischer Nachstellung / with automatic adjustment Nur zusammen verbauen / Only install together	(48) (18) (95) (53)		
			6482 000 218		PHIS-6/38	Getr. / GBox: Powershift Euro 6 / Euro 6 Immer erneuern / Renew everytime	(18) (30)		

		CODE				
--	--	------	--	---	---	---





MERCEDES-BENZ

ANTOS		07.12 -					
2645 L 963.024	07.12-	OM471	 3400 700 545 			XTend Euro 6 / Euro 6	(18)
2645 L 963.425	07.12-		 3400 700 541 	430	18	XTend Getr. / GBox: Powershift Nabenprofil / Hub Profile: 45x50-18N Euro 6 / Euro 6 Nur zusammen verbauen / Only install together	(48) (18) (53)
2645 LS 963.424	07.12-		 3400 710 072 	430	18	Getr. / GBox: Powershift Nabenprofil / Hub Profile: 45x50-18N Euro 6 / Euro 6 mit automatischer Nachstellung / with automatic adjustment Nur zusammen verbauen / Only install together	(48) (18) (95) (53)
2648 L 963.025	07.12-						
2648 L 963.024	07.12-		 3400 700 543 	430	18	XTend Getr. / GBox: Powershift Nabenprofil / Hub Profile: 45x50-18N Euro 6 / Euro 6 Nur zusammen verbauen / Only install together	(48) (18) (53)
2648 LS 963.425	07.12-						
2648 LS 963.424	07.12-		 3400 710 075 	430	18	Getr. / GBox: Powershift Nabenprofil / Hub Profile: 45x50-18N Euro 6 / Euro 6 mit automatischer Nachstellung / with automatic adjustment Nur zusammen verbauen / Only install together	(48) (18) (95) (53)
3345 L 963.026	07.12-						
3345 LS 963.426	07.12-						
3348 L 963.026	07.12-		 6482 000 218			PHIS-6/38	Getr. / GBox: Powershift Euro 6 / Euro 6 Immer erneuern / Renew everytime
3348 LS 963.426	07.12-						







MERCEDES-BENZ

AROCS	01.13 -					
1824 964.000	01.13-	OM936	 3400 700 639 	395 18	Euro 6 / Euro 6	(18)
1824 A 964.007	01.13-		 3400 700 546 	395 18	XTend Getr. / GBox: Powershift Nabenprofil / Hub Profile: 36x40-18N Euro 6 / Euro 6 Nur zusammen verbauen / Only install together	(48) (18) (53)
1824 AK 964.207	01.13-					
1824 K 964.200	01.13-		 6482 000 219	PHIS-5/34	Getr. / GBox: Powershift Euro 6 / Euro 6 Immer erneuern / Renew everytime	(18) (30)
1824 LS 964.403	01.13-					
1827 964.000	01.13-					
1827 A 964.007	01.13-					
1827 AK 964.207	01.13-					
1827 K 964.200	01.13-					
1827 LS 964.403	01.13-					
1830 964.000	01.13-					
1830 A 964.007	01.13-					
1830 AK 964.207	01.13-					
1830 K 964.200	01.13-					
1830 S, 1830 LS 964.403	01.13-					
2024 964.001	01.13-					
2024 K 964.201	01.13-					
2024 S, 2424 LS 964.401/402	01.13-					
2027 964.001	01.13-					
2027 K 964.201	01.13-					
2027 S, 2027 LS 964.402 964.401	01.13-					
2030 964.001	01.13-					
2030 K 964.201	01.13-					
2030 S, 2030 LS 964.401/402	01.13-					
2527 L 964.020	01.13-					
2527 L 964.022	01.13-					
2527 LS 964.420	01.13-					
2530 L 964.020	01.13-					
2530 L 964.022	01.13-					
2530 LS 964.420	01.13-					
2627 B, 2627 LB 964.314 964.324	01.13-					
2627 K, 2627 LK 964.214 964.224	01.13-					
2627 L 964.025	01.13-					
2627 L 964.022	01.13-					
2627 LS 964.425	01.13-					
2627 LS 964.422	01.13-					







MERCEDES-BENZ

AROCS		01.13 -					
2627 S, 2627 LS 964.424 964.414	01.13-	OM936		3400 700 639 	395 18	Euro 6 / Euro 6	(18)
2627, 2627 L 964.014 964.024	01.13-			3400 700 546 	395 18	XTend Getr. / GBox: Powershift Nabenprofil / Hub Profile: 36x40-18N Euro 6 / Euro 6 Nur zusammen verbauen / Only install together	(48) (18) (53)
2630 B, 2630 LB 964.324 964.314	01.13-						
2630 K, 2630 LK 964.214 964.224	01.13-			6482 000 219	PHIS-5/34	Getr. / GBox: Powershift Euro 6 / Euro 6 Immer erneuern / Renew everytime	(18) (30)
2630 L 964.025	01.13-						
2630 L 964.022	01.13-						
2630 LS 964.425	01.13-						
2630 LS 964.422	01.13-						
2630 S, 2630 LS 964.414 964.424	01.13-						
2630, 2630 L 964.024 964.014	01.13-						
3227 B, 3227 LB 964.338 964.330	01.13-						
3227 K, 3227 LK 964.238	01.13-						
3227 L 964.041	01.13-						
3227 LB 964.341	01.13-						
3227 LK 964.241	01.13-						
3227, 3227 L 964.030 964.038	01.13-						
3230 B, 3230 LB 964.338 964.330	01.13-						
3230 K, 3230 LK 964.230 964.238	01.13-						
3230 L 964.041	01.13-						
3230 LB 964.341	01.13-						
3230 LK 964.241	01.13-						
3230, 3230 L 964.030 964.038	01.13-						









MERCEDES-BENZ

AROCS		01.13 -					
1832 964.000	01.13-	OM936		3400 700 532 	430 18	XTend Nabenprofil / Hub Profile: 45x50-18N Euro 6 / Euro 6	(48) (18)
1832 A 964.007	01.13-					Nur zusammen verbauen / Only install together	(53)
1832 AK 964.207	01.13-			3400 700 530 	430 18	XTend Getr. / GBox: Powershift Nabenprofil / Hub Profile: 45x50-18N Euro 6 / Euro 6	(48) (18)
1832 K 964.200	01.13-					Nur zusammen verbauen / Only install together	(53)
1832 S, 1832 LS 964.403	01.13-			3400 710 070 	430 18	Getr. / GBox: Powershift Nabenprofil / Hub Profile: 45x50-18N Euro 6 / Euro 6	(48) (18)
1835 964.000	01.13-					mit automatischer Nachstellung / with automatic adjustment	(95)
1835 A 964.007	01.13-					Nur zusammen verbauen / Only install together	(53)
1835 AK 964.207	01.13-			6482 000 218	PHIS-6/38	Getr. / GBox: Powershift Euro 6 / Euro 6	(18)
1835 K 964.200	01.13-					Immer erneuern / Renew everytime	(30)
1835 S, 1835 LS 964.403	01.13-						
2032 964.001	01.13-						
2032 K 964.201	01.13-						
2032 S, 2032 LS 964.402 964.401	01.13-						
2035 964.001	01.13-						
2035 K 964.201	01.13-						
2035 S, 2035 LS 964.401/402	01.13-						
2532 L 964.020	01.13-						
2532 L 964.022	01.13-						
2532 LS 964.420	01.13-						
2535 L 964.020	01.13-						
2535 L 964.022	01.13-						
2535 LS 964.420	01.13-						
2632 B, 2632 LB 964.324 964.314	01.13-						
2632 K, 2632 LK 964.214 964.224	01.13-						
2632 L 964.025	01.13-						
2632 L 964.022	01.13-						
2632 LS 964.425	01.13-						
2632 LS 964.422	01.13-						
2632 S, 2632 LS 964.414 964.424	01.13-						
2632, 2632 L 964.014 964.024	01.13-						
2635 B, 2635 LB 964.314 964.324	01.13-						
2635 K, 2635 LK 964.214 964.224	01.13-						
2635 L 964.025	01.13-						
2635 L 964.022	01.13-						
2635 LS 964.425	01.13-						
2635 LS 964.422	01.13-						

MERCEDES-BENZ











AROCS		01.13 -					
2635 S, 2635 LS 964.424 964.414	01.13-	OM936	 3400 700 532 	430 18	XTend Nabenprofil / Hub Profile: 45x50-18N Euro 6 / Euro 6 Nur zusammen verbauen / Only install together	(48) (18) (53)	
2635, 2635 L 964.014 964.024	01.13-						
3232 B, 3232 LB 964.338 964.330	01.13-		 3400 700 530 	430 18	XTend Getr. / GBox: Powershift Nabenprofil / Hub Profile: 45x50-18N Euro 6 / Euro 6 Nur zusammen verbauen / Only install together	(48) (18) (53)	
3232 K, 3232 LK 964.230 964.238	01.13-						
3232 L 964.041	01.13-		 3400 710 070 	430 18	Getr. / GBox: Powershift Nabenprofil / Hub Profile: 45x50-18N Euro 6 / Euro 6 mit automatischer Nachstellung / with automatic adjustment Nur zusammen verbauen / Only install together	(48) (18) (95) (53)	
3232 LB 964.341	01.13-						
3232 LK 964.241	01.13-						
3232, 3232 L 964.038 964.030	01.13-		 6482 000 218	PHIS-6/38	Getr. / GBox: Powershift Euro 6 / Euro 6 Immer erneuern / Renew everytime	(18) (30)	
3235 B, 3235 LB 964.338 964.330	01.13-						
3235 K, 3235 LK 964.230 964.238	01.13-						
3235 L 964.041	01.13-						
3235 LB 964.341	01.13-						
3235 LK 964.241	01.13-						
3235, 3235 L 964.038 964.030	01.13-						

MERCEDES-BENZ











AROCS		01.13 -					
1833 964.000	01.13-	OM470		3400 700 533 	430 18	XTend Nabenprofil / Hub Profile: 45x50-18N Euro 6 / Euro 6 Nur zusammen verbauen / Only install together	(48) (18) (53)
1833 A 964.007	01.13-						
1833 AK 964.207	01.13-			3400 700 531 	430 18	XTend Getr. / GBox: Powershift Nabenprofil / Hub Profile: 45x50-18N Euro 6 / Euro 6 Nur zusammen verbauen / Only install together	(48) (18) (53)
1833 AS 964.407	01.13-						
1833 K 964.200	01.13-			3400 710 071 	430 18	Getr. / GBox: Powershift Nabenprofil / Hub Profile: 45x50-18N Euro 6 / Euro 6 mit automatischer Nachstellung / with automatic adjustment Nur zusammen verbauen / Only install together	(48) (18) (95) (53)
1833 LS 964.403	01.13-						
1836 964.000	01.13-						
1836 A 964.007	01.13-			3400 700 542 	430 18	XTend Getr. / GBox: Powershift Nabenprofil / Hub Profile: 45x50-18N Euro 6 / Euro 6 Nur zusammen verbauen / Only install together	(48) (18) (53)
1836 AK 964.207	01.13-						
1836 AS 964.407	01.13-						
1836 K 964.200	01.13-			3400 710 074 	430 18	Getr. / GBox: Powershift Nabenprofil / Hub Profile: 45x50-18N Euro 6 / Euro 6 mit automatischer Nachstellung / with automatic adjustment Nur zusammen verbauen / Only install together	(48) (18) (95) (53)
1836 S, 1836 LS 964.403	01.13-						
1840 964.000	01.13-			6482 000 218	PHIS-6/38	Getr. / GBox: Powershift Euro 6 / Euro 6 Immer erneuern / Renew everytime	(18) (30)
1840 A 964.007	01.13-						
1840 AK 964.207	01.13-						
1840 AS 964.407	01.13-						
1840 K 964.200	01.13-						
1840 LS 964.403	01.13-						
2033 964.001	01.13-						
2033 A 964.008	01.13-						
2033 AK 964.208	01.13-						
2033 AS 964.408	01.13-						
2033 K 964.201	01.13-						
2033 S, 2033 LS 964.402 964.401	01.13-						
2036 964.001	01.13-						
2036 A 964.008	01.13-						
2036 AK 964.208	01.13-						
2036 AS 964.408	01.13-						
2036 K 964.201	01.13-						
2036 S, 2036 LS 964.402 964.401	01.13-						
2040 964.001	01.13-						
2040 A 964.008	01.13-						
2040 AK 964.208	01.13-						
2040 AS 964.408	01.13-						
2040 K 964.201	01.13-						
2040 S, 2040 LS 964.401/402	01.13-						

		CODE				
--	--	------	--	---	---	---

MERCEDES-BENZ











AROCS		01.13 -					
2533 L 964.020	01.13-	OM470		3400 700 533 	430 18	XTend Nabenprofil / Hub Profile: 45x50-18N Euro 6 / Euro 6 Nur zusammen verbauen / Only install together	(48) (18) (53)
2533 L 964.022	01.13-						
2533 LS 964.423	01.13-			3400 700 531 	430 18	XTend Getr. / GBox: Powershift Nabenprofil / Hub Profile: 45x50-18N Euro 6 / Euro 6 Nur zusammen verbauen / Only install together	(48) (18) (53)
2533 LS 964.420	01.13-						
2533 LS 964.422	01.13-			3400 710 071 	430 18	Getr. / GBox: Powershift Nabenprofil / Hub Profile: 45x50-18N Euro 6 / Euro 6 mit automatischer Nachstellung / with automatic adjustment Nur zusammen verbauen / Only install together	(48) (18) (95) (53)
2536 L 964.020	01.13-						
2536 L 964.022	01.13-						
2536 LS 964.420	01.13-			3400 700 542 	430 18	XTend Getr. / GBox: Powershift Nabenprofil / Hub Profile: 45x50-18N Euro 6 / Euro 6 Nur zusammen verbauen / Only install together	(48) (18) (53)
2536 LS 964.423	01.13-						
2536 LS 964.422	01.13-			3400 710 074 	430 18	Getr. / GBox: Powershift Nabenprofil / Hub Profile: 45x50-18N Euro 6 / Euro 6 mit automatischer Nachstellung / with automatic adjustment Nur zusammen verbauen / Only install together	(48) (18) (95) (53)
2540 L 964.020	01.13-						
2540 L 964.022	01.13-						
2540 LS 964.420	01.13-			6482 000 218	PHIS-6/38	Getr. / GBox: Powershift Euro 6 / Euro 6 Immer erneuern / Renew everytime	(18) (30)
2540 LS 964.423	01.13-						
2540 LS 964.422	01.13-						
2633 B, 2633 LB 964.324 964.314	01.13-						
2633 K, 2633 LK 964.224 964.214	01.13-						
2633 L 964.025	01.13-						
2633 L 964.022	01.13-						
2633 LS 964.425	01.13-						
2633 LS 964.422	01.13-						
2633 S, 2633 LS 964.414 964.424	01.13-						
2633, 2633 L 964.024 964.014	01.13-						
2636 B, 2636 LB 964.324 964.314	01.13-						
2636 K, 2636 LK 964.214 964.224	01.13-						
2636 L 964.025	01.13-						
2636 L 964.022	01.13-						
2636 LS 964.425	01.13-						
2636 LS 964.422	01.13-						
2636 S, 2636 LS 964.424 964.414	01.13-						
2636, 2636 L 964.014 964.024	01.13-						
2640 B, 2640 LB 964.324 964.314	01.13-						
2640 K, 2640 LK 964.214 964.224	01.13-						
2640 L 964.025	01.13-						
2640 L 964.022	01.13-						
2640 LS 964.425	01.13-						

MERCEDES-BENZ











AROCS		01.13 -					
2640 LS 964.422	01.13-	OM470		3400 700 533 	430 18	XTend Nabenprofil / Hub Profile: 45x50-18N Euro 6 / Euro 6 Nur zusammen verbauen / Only install together	(48) (18) (53)
2640 S, 2640 LS 964.414 964.424	01.13-						
2640, 2640 L 964.024 964.014	01.13-			3400 700 531 	430 18	XTend Getr. / GBox: Powershift Nabenprofil / Hub Profile: 45x50-18N Euro 6 / Euro 6 Nur zusammen verbauen / Only install together	(48) (18) (53)
3233 B, 3233 LB 964.330 964.338	01.13-						
3233 K, 3233 LK 964.238 964.230	01.13-			3400 710 071 	430 18	Getr. / GBox: Powershift Nabenprofil / Hub Profile: 45x50-18N Euro 6 / Euro 6 mit automatischer Nachstellung / with automatic adjustment Nur zusammen verbauen / Only install together	(48) (18) (95) (53)
3233 L 964.041	01.13-						
3233 LB 964.341	01.13-						
3233 LK 964.241	01.13-			3400 700 542 	430 18	XTend Getr. / GBox: Powershift Nabenprofil / Hub Profile: 45x50-18N Euro 6 / Euro 6 Nur zusammen verbauen / Only install together	(48) (18) (53)
3233, 3233 L 964.030 964.038	01.13-						
3236 B, 3236 LB 964.330 964.338	01.13-						
3236 K, 3236 LK 964.238 964.230	01.13-			3400 710 074 	430 18	Getr. / GBox: Powershift Nabenprofil / Hub Profile: 45x50-18N Euro 6 / Euro 6 mit automatischer Nachstellung / with automatic adjustment Nur zusammen verbauen / Only install together	(48) (18) (95) (53)
3236 L 964.041	01.13-						
3236 LB 964.341	01.13-						
3236 LK 964.241	01.13-			6482 000 218	PHIS-6/38	Getr. / GBox: Powershift Euro 6 / Euro 6 Immer erneuern / Renew everytime	(18) (30)
3236, 3236 L 964.038 964.030	01.13-						
3240 B, 3240 LB 964.338 964.330	01.13-						
3240 K, 3240 LK 964.238 964.230	01.13-						
3240 L 964.041	01.13-						
3240 LB 964.341	01.13-						
3240 LK 964.241	01.13-						
3240, 3240 L 964.038 964.030	01.13-						
3333 A 964.018	01.13-						
3333 AK 964.218	01.13-						
3333 AS 964.418	01.13-						
3333 B, 3333 LB 964.326 964.316	01.13-						
3333 K, 3333 LK 964.226 964.216	01.13-						
3333 S, 3333 LS 964.426 964.416	01.13-						
3333, 3333 L 964.016 964.026	01.13-						
3336 A 964.018	01.13-						
3336 AK 964.218	01.13-						
3336 AS 964.418	01.13-						
3336 B, 3336 LB 964.316 964.326	01.13-						
3336 K, 3336 LK 964.226 964.216	01.13-						
3336 S, 3336 LS 964.416 964.426	01.13-						
3336, 3336 L 964.026 964.016	01.13-						
3340 A 964.018	01.13-						

		CODE				
--	--	------	--	---	---	---











MERCEDES-BENZ

AROCS		01.13 -					
3340 AK 964.218	01.13-	OM470		3400 700 533 	430 18	XTend Nabenprofil / Hub Profile: 45x50-18N Euro 6 / Euro 6 Nur zusammen verbauen / Only install together	(48) (18) (53)
3340 AS 964.418	01.13-						
3340 B, 3340 LB 964.326 964.316	01.13-			3400 700 531 	430 18	XTend Getr. / GBox: Powershift Nabenprofil / Hub Profile: 45x50-18N Euro 6 / Euro 6 Nur zusammen verbauen / Only install together	(48) (18) (53)
3340 K, 3340 LK 964.226 964.216	01.13-						
3340 S, 3340 LS 964.426 964.416	01.13-			3400 710 071 	430 18	Getr. / GBox: Powershift Nabenprofil / Hub Profile: 45x50-18N Euro 6 / Euro 6 mit automatischer Nachstellung / with automatic adjustment Nur zusammen verbauen / Only install together	(48) (18) (95) (53)
3340, 3340 L 964.026 964.016	01.13-						
4133 964.031	01.13-						
4133 AK 964.232	01.13-			3400 700 542 	430 18	XTend Getr. / GBox: Powershift Nabenprofil / Hub Profile: 45x50-18N Euro 6 / Euro 6 Nur zusammen verbauen / Only install together	(48) (18) (53)
4133 AK 964.233	01.13-						
4133 B 964.331	01.13-						
4133 K 964.231	01.13-			3400 710 074 	430 18	Getr. / GBox: Powershift Nabenprofil / Hub Profile: 45x50-18N Euro 6 / Euro 6 mit automatischer Nachstellung / with automatic adjustment Nur zusammen verbauen / Only install together	(48) (18) (95) (53)
4136 964.031	01.13-						
4136 AK 964.232	01.13-			6482 000 218	PHIS-6/38	Getr. / GBox: Powershift Euro 6 / Euro 6 Immer erneuern / Renew everytime	(18) (30)
4136 AK 964.233	01.13-						
4136 B 964.331	01.13-						
4136 K 964.231	01.13-						
4140 964.031	01.13-						
4140 AK 964.232	01.13-						
4140 AK 964.233	01.13-						
4140 B 964.331	01.13-						
4140 K 964.231	01.13-						

MERCEDES-BENZ











AROCS		01.13 -					
1842 964.000	01.13-	OM471		3400 700 533 	430 18	XTend Nabenprofil / Hub Profile: 45x50-18N Euro 6 / Euro 6 Nur zusammen verbauen / Only install together	(48) (18) (53)
1842 A 964.007	01.13-			3400 700 531 	430 18	XTend Getr. / GBox: Powershift Nabenprofil / Hub Profile: 45x50-18N Euro 6 / Euro 6 Nur zusammen verbauen / Only install together	(48) (18) (53)
1842 AK 964.207	01.13-						
1842 AS 964.407	01.13-						
1842 K 964.200	01.13-			3400 710 071 	430 18	Getr. / GBox: Powershift Nabenprofil / Hub Profile: 45x50-18N Euro 6 / Euro 6 mit automatischer Nachstellung / with automatic adjustment Nur zusammen verbauen / Only install together	(48) (18) (95) (53)
1842 LS 964.403	01.13-						
2042 964.001	01.13-						
2042 A 964.008	01.13-			3400 700 542 	430 18	XTend Getr. / GBox: Powershift Nabenprofil / Hub Profile: 45x50-18N Euro 6 / Euro 6 Nur zusammen verbauen / Only install together	(48) (18) (53)
2042 AK 964.208	01.13-						
2042 AS 964.408	01.13-			3400 710 074 	430 18	Getr. / GBox: Powershift Nabenprofil / Hub Profile: 45x50-18N Euro 6 / Euro 6 mit automatischer Nachstellung / with automatic adjustment Nur zusammen verbauen / Only install together	(48) (18) (95) (53)
2042 K 964.201	01.13-						
2042 S, 2042 LS 964.402 964.401	01.13-						
2542 L 964.020	01.13-			6482 000 218	PHIS-6/38	Getr. / GBox: Powershift Euro 6 / Euro 6 Immer erneuern / Renew everytime	(18) (30)
2542 LS 964.423	01.13-						
2542 LS 964.420	01.13-						
2642 B, 2642 LB 964.314 964.324	01.13-						
2642 K, 2642 LK 964.214 964.224	01.13-						
2642 L 964.025	01.13-						
2642 L 964.022	01.13-						
2642 LS 964.425	01.13-						
2642 LS 964.422	01.13-						
2642 S, 2642 LS 964.414 964.424	01.13-						
2642, 2642 L 964.024 964.014	01.13-						
3242 B, 3242 LB 964.338 964.330	01.13-						
3242 K, 3242 LK 964.230 964.238	01.13-						
3242 L 964.041	01.13-						
3242 LB 964.341	01.13-						
3242 LK 964.241	01.13-						
3242, 3242 L 964.038 964.030	01.13-						
3342 A 964.018	01.13-						
3342 AK 964.218	01.13-						
3342 AS 964.418	01.13-						
3342 B, 3342 LB 964.326 964.316	01.13-						
3342 K, 3342 LK 964.226 964.216	01.13-						
3342 S, 3342 LS 964.426 964.416	01.13-						
4142 964.031	01.13-						

MERCEDES-BENZ

AROCS		01.13 -					
4142 AK 964.232	01.13-	OM471	 3400 700 533  	430 18	XTend Nabenprofil / Hub Profile: 45x50-18N Euro 6 / Euro 6 Nur zusammen verbauen / Only install together	(48) (18) (53)	
4142 AK 964.233	01.13-		 3400 700 531  	430 18	XTend Getr. / GBox: Powershift Nabenprofil / Hub Profile: 45x50-18N Euro 6 / Euro 6 Nur zusammen verbauen / Only install together	(48) (18) (53)	
4142 B 964.331	01.13-		3400 710 071 	430 18	Getr. / GBox: Powershift Nabenprofil / Hub Profile: 45x50-18N Euro 6 / Euro 6 mit automatischer Nachstellung / with automatic adjustment Nur zusammen verbauen / Only install together	(48) (18) (95) (53)	
4142 K 964.231	01.13-						
4145 AK 964.232	01.13-		3400 700 542  	430 18	XTend Getr. / GBox: Powershift Nabenprofil / Hub Profile: 45x50-18N Euro 6 / Euro 6 Nur zusammen verbauen / Only install together	(48) (18) (53)	
4145 AK 964.233	01.13-						
4148 AK 964.232	01.13-						
4148 AK 964.232	01.13-						
4148 AK 964.233	01.13-						
		3400 710 074  	430 18	Getr. / GBox: Powershift Nabenprofil / Hub Profile: 45x50-18N Euro 6 / Euro 6 mit automatischer Nachstellung / with automatic adjustment Nur zusammen verbauen / Only install together	(48) (18) (95) (53)		
		6482 000 218	PHIS-6/38	Getr. / GBox: Powershift Euro 6 / Euro 6 Immer erneuern / Renew everytime	(18) (30)		











		CODE				
--	--	------	--	---	---	---

MERCEDES-BENZ

AROCS		01.13 -					
1843 964.000	01.13-	OM470	 3400 700 545 		XTend Euro 6 / Euro 6		(18)
1843 A 964.007	01.13-		 3400 700 541 	430 18	XTend Getr. / GBox: Powershift Nabenprofil / Hub Profile: 45x50-18N Euro 6 / Euro 6		(48) (18)
1843 AK 964.207	01.13-				Nur zusammen verbauen / Only install together		(53)
1843 AS 964.407	01.13-		 3400 710 072 	430 18	Getr. / GBox: Powershift Nabenprofil / Hub Profile: 45x50-18N Euro 6 / Euro 6		(48) (18)
1843 K 964.200	01.13-				mit automatischer Nachstellung / with automatic adjustment		(95)
1843 LS 964.403	01.13-				Nur zusammen verbauen / Only install together		(53)
2043 964.001	01.13-		 3400 700 543 	430 18	XTend Getr. / GBox: Powershift Nabenprofil / Hub Profile: 45x50-18N Euro 6 / Euro 6		(48) (18)
2043 A 964.008	01.13-				Nur zusammen verbauen / Only install together		(53)
2043 AK 964.208	01.13-		 3400 710 075 	430 18	Getr. / GBox: Powershift Nabenprofil / Hub Profile: 45x50-18N Euro 6 / Euro 6		(48) (18)
2043 AS 964.408	01.13-				mit automatischer Nachstellung / with automatic adjustment		(95)
2043 K 964.201	01.13-				Nur zusammen verbauen / Only install together		(53)
2043 S, 2043 LS 964.401/402	01.13-		 6482 000 218	PHIS-6/38	Getr. / GBox: Powershift Euro 6 / Euro 6		(18) (30)
2543 L 964.020	01.13-				Immer erneuern / Renew everytime		
2543 L 964.022	01.13-						
2543 LS 964.420	01.13-						
2543 LS 964.423	01.13-						
2543 LS 964.422	01.13-						
2643 B, 2643 LB 964.314 964.324	01.13-						
2643 K, 2643 LK 964.224 964.214	01.13-						
2643 L 964.025	01.13-						
2643 L 964.022	01.13-						
2643 LS 964.425	01.13-						
2643 LS 964.422	01.13-						
2643 S, 2643 LS 964.414 964.424	01.13-						
2643, 2643 L 964.024 964.014	01.13-						
3243 B, 3243 LB 964.330 964.338	01.13-						
3243 K, 3243 LK 964.230 964.238	01.13-						
3243 L 964.041	01.13-						
3243 LB 964.341	01.13-						
3243 LK 964.241	01.13-						
3243, 3243 L 964.030 964.038	01.13-						
3343 A 964.018	01.13-						
3343 AK 964.218	01.13-						
3343 AS 964.418	01.13-						
3343 B, 3343 LB 964.316 964.326	01.13-						
3343 K, 3343 LK 964.226 964.216	01.13-						











		CODE				
--	--	------	--	---	---	---

MERCEDES-BENZ

AROCS		01.13 -					
3343 S, 3343 LS 964.426 964.416	01.13-	OM470	 3400 700 545 			XTend Euro 6 / Euro 6	(18)
3343, 3343 L 964.016 964.026	01.13-		 3400 700 541 	430	18	XTend Getr. / GBox: Powershift Nabenprofil / Hub Profile: 45x50-18N Euro 6 / Euro 6 Nur zusammen verbauen / Only install together	(48) (18) (53)
4143 964.031	01.13-						
4143 AK 964.232	01.13-		 3400 710 072 	430	18	Getr. / GBox: Powershift Nabenprofil / Hub Profile: 45x50-18N Euro 6 / Euro 6 mit automatischer Nachstellung / with automatic adjustment Nur zusammen verbauen / Only install together	(48) (18) (95) (53)
4143 B 964.233	01.13-						
4143 K 964.331	01.13-						
4143 K 964.231	01.13-		 3400 700 543 	430	18	XTend Getr. / GBox: Powershift Nabenprofil / Hub Profile: 45x50-18N Euro 6 / Euro 6 Nur zusammen verbauen / Only install together	(48) (18) (53)
			 3400 710 075 	430	18	Getr. / GBox: Powershift Nabenprofil / Hub Profile: 45x50-18N Euro 6 / Euro 6 mit automatischer Nachstellung / with automatic adjustment Nur zusammen verbauen / Only install together	(48) (18) (95) (53)
			 6482 000 218			PHIS-6/38 Getr. / GBox: Powershift Euro 6 / Euro 6 Immer erneuern / Renew everytime	(18) (30)













		CODE				
--	--	------	--	---	---	---

MERCEDES-BENZ











AROCS		01.13 -					
1845 964.000	01.13-	OM471	 3400 700 545 			XTend Euro 6 / Euro 6	(18)
1845 A 964.007	01.13-		 3400 700 541 	430	18	XTend Getr. / GBox: Powershift Nabenprofil / Hub Profile: 45x50-18N Euro 6 / Euro 6 Nur zusammen verbauen / Only install together	(48) (18) (53)
1845 AK 964.207	01.13-						
1845 AS 964.407	01.13-		 3400 710 072 	430	18	Getr. / GBox: Powershift Nabenprofil / Hub Profile: 45x50-18N Euro 6 / Euro 6 mit automatischer Nachstellung / with automatic adjustment Nur zusammen verbauen / Only install together	(48) (18) (95) (53)
1845 K 964.200	01.13-						
1845 LS 964.403	01.13-						
1848 964.000	01.13-		 3400 700 543 	430	18	XTend Getr. / GBox: Powershift Nabenprofil / Hub Profile: 45x50-18N Euro 6 / Euro 6 Nur zusammen verbauen / Only install together	(48) (18) (53)
1848 A 964.007	01.13-						
1848 AK 964.207	01.13-						
1848 AS 964.407	01.13-		 3400 710 075 	430	18	Getr. / GBox: Powershift Nabenprofil / Hub Profile: 45x50-18N Euro 6 / Euro 6 mit automatischer Nachstellung / with automatic adjustment Nur zusammen verbauen / Only install together	(48) (18) (95) (53)
1848 K 964.200	01.13-						
1848 LS 964.403	01.13-						
2045 964.001	01.13-		 6482 000 218			PHIS-6/38 Getr. / GBox: Powershift Euro 6 / Euro 6 Immer erneuern / Renew everytime	(18) (30)
2045 A 964.008	01.13-						
2045 AK 964.208	01.13-						
2045 AS 964.408	01.13-						
2045 K 964.201	01.13-						
2045 S, 2045 LS 964.402 964.401	01.13-						
2048 964.001	01.13-						
2048 A 964.008	01.13-						
2048 AK 964.208	01.13-						
2048 AS 964.408	01.13-						
2048 K 964.201	01.13-						
2048 S, 2048 LS 964.401/402	01.13-						
2545 L 964.020	01.13-						
2545 LS 964.420	01.13-						
2545 LS 964.423	01.13-						
2548 L 964.020	01.13-						
2548 LS 964.423	01.13-						
2548 LS 964.420	01.13-						
2645 B, 2645 LB 964.324 964.314	01.13-						
2645 K, 2645 LK 964.224 964.214	01.13-						
2645 L 964.025	01.13-						
2645 L 964.022	01.13-						
2645 LS 964.425	01.13-						
2645 LS 964.422	01.13-						

		CODE				
--	--	------	--	---	---	---











MERCEDES-BENZ

AROCS		01.13 -				
2645 S, 2645 LS 964.414 964.424	01.13-	OM471	 3400 700 545 		XTend Euro 6 / Euro 6	(18)
2645, 2645 L 964.024 964.014	01.13-		 3400 700 541 	430 18	XTend Getr. / GBox: Powershift Nabenprofil / Hub Profile: 45x50-18N Euro 6 / Euro 6 Nur zusammen verbauen / Only install together	(48) (18) (53)
2648 B, 2648 LB 964.314 964.324	01.13-					
2648 K, 2648 LK 964.214 964.224	01.13-		 3400 710 072 	430 18	Getr. / GBox: Powershift Nabenprofil / Hub Profile: 45x50-18N Euro 6 / Euro 6 mit automatischer Nachstellung / with automatic adjustment Nur zusammen verbauen / Only install together	(48) (18) (95) (53)
2648 L 964.025	01.13-					
2648 L 964.022	01.13-					
2648 LS 964.425	01.13-		 3400 700 543  	430 18	XTend Getr. / GBox: Powershift Nabenprofil / Hub Profile: 45x50-18N Euro 6 / Euro 6 Nur zusammen verbauen / Only install together	(48) (18) (53)
2648 LS 964.422	01.13-					
2648 S, 2648 LS 964.424 964.414	01.13-					
2648, 2648 L 964.024 964.014	01.13-		 3400 710 075  	430 18	Getr. / GBox: Powershift Nabenprofil / Hub Profile: 45x50-18N Euro 6 / Euro 6 mit automatischer Nachstellung / with automatic adjustment Nur zusammen verbauen / Only install together	(48) (18) (95) (53)
3245 B, 3245 LB 964.330 964.338	01.13-					
3245 K, 3245 LK 964.230 964.238	01.13-		 6482 000 218	PHIS-6/38	Getr. / GBox: Powershift Euro 6 / Euro 6 Immer erneuern / Renew everytime	(18) (30)
3245 L 964.041	01.13-					
3245 LB 964.341	01.13-					
3245 LK 964.241	01.13-					
3245, 3245 L 964.030 964.038	01.13-					
3248 B, 3248 LB 964.338 964.330	01.13-					
3248 K, 3248 LK 964.238 964.230	01.13-					
3248 L 964.041	01.13-					
3248 LB 964.341	01.13-					
3248 LK 964.241	01.13-					
3248, 3248 L 964.030 964.038	01.13-					
3345 A 964.018	01.13-					
3345 AK 964.218	01.13-					
3345 AS 964.418	01.13-					
3345, 3345 L 964.016 964.026	01.13-					
3345B, 3345 LB 964.326 964.316	01.13-					
3345K, 3345 LK 964.216 964.226	01.13-					
3345S, 3345 LS 964.416 964.426	01.13-					
3348 A 964.018	01.13-					
3348 AK 964.218	01.13-					
3348 AS 964.418	01.13-					
3348 B, 3348 LB 964.326 964.316	01.13-					
3348 K, 3348 LK 964.216 964.226	01.13-					
3348 S, 3348 LS 964.426 964.416	01.13-					
3348, 3348 L 964.016 964.026	01.13-					

MERCEDES-BENZ





























AROCS		01.13 -					
4145 964.031	01.13-	OM471	 3400 700 545 			XTend Euro 6 / Euro 6	(18)
4145 B 964.331	01.13-		 3400 700 541 	430	18	XTend Getr. / GBox: Powershift Nabenprofil / Hub Profile: 45x50-18N Euro 6 / Euro 6 Nur zusammen verbauen / Only install together	(48) (18) (53)
4145 K 964.231	01.13-						
4148 964.031	01.13-		 3400 710 072 	430	18	Getr. / GBox: Powershift Nabenprofil / Hub Profile: 45x50-18N Euro 6 / Euro 6	(48) (18)
4148 B 964.331	01.13-					mit automatischer Nachstellung / with automatic adjustment	(95)
4148 K 964.231	01.13-					Nur zusammen verbauen / Only install together	(53)
			 3400 700 543 	430	18	XTend Getr. / GBox: Powershift Nabenprofil / Hub Profile: 45x50-18N Euro 6 / Euro 6 Nur zusammen verbauen / Only install together	(48) (18) (53)
			 3400 710 075 	430	18	Getr. / GBox: Powershift Nabenprofil / Hub Profile: 45x50-18N Euro 6 / Euro 6 mit automatischer Nachstellung / with automatic adjustment Nur zusammen verbauen / Only install together	(48) (18) (95) (53)
			 6482 000 218		PHIS-6/38	Getr. / GBox: Powershift Euro 6 / Euro 6 Immer erneuern / Renew everytime	(18) (30)

MERCEDES-BENZ

AROCS		01.13 -					
1851 964.000	01.13-	OM471		3400 700 534 	430 18	XTend Nabenprofil / Hub Profile: 45x50-18N Euro 6 / Euro 6	(48) (18)
1851 A 964.007	01.13-					max. übertragbares Motormoment [Nm] / max. transmittable engine torque [Nm]: 2600 Nur zusammen verbauen / Only install together	(87) (53)
1851 AK 964.207	01.13-			3400 700 529 	430 18	XTend Getr. / GBox: Powershift Nabenprofil / Hub Profile: 45x50-18N Euro 6 / Euro 6	(48) (18) (53)
1851 AS 964.407	01.13-					Nur zusammen verbauen / Only install together	
1851 K 964.200	01.13-			3400 710 073 	430 18	Getr. / GBox: Powershift Nabenprofil / Hub Profile: 45x50-18N Euro 6 / Euro 6	(48) (18) (95)
1851 LS 964.403	01.13-					mit automatischer Nachstellung / with automatic adjustment Nur zusammen verbauen / Only install together	(53)
2051 964.001	01.13-			3400 700 544 	430 18	XTend Getr. / GBox: Powershift Nabenprofil / Hub Profile: 45x50-18N Euro 6 / Euro 6	(48) (18) (53)
2051 A 964.008	01.13-					Nur zusammen verbauen / Only install together	
2051 AK 964.208	01.13-			3400 710 076 	430 18	Getr. / GBox: Powershift Nabenprofil / Hub Profile: 45x50-18N Euro 6 / Euro 6	(48) (18) (95)
2051 AS 964.408	01.13-					mit automatischer Nachstellung / with automatic adjustment Nur zusammen verbauen / Only install together	(53)
2051 K 964.201	01.13-			6482 000 218	PHIS-6/38	Getr. / GBox: Powershift Euro 6 / Euro 6 Immer erneuern / Renew everytime	(18) (30)
2051 S, 2051 LS 964.401/402	01.13-						
2551 L 964.020	01.13-						
2551 L 964.022	01.13-						
2551 LS 964.420	01.13-						
2551 LS 964.423	01.13-						
2551 LS 964.422	01.13-						
2552 L 964.020	01.14-						
2651 B, 2651 LB 964.324 964.314	01.13-						
2651 K, 2651 LK 964.214 964.224	01.13-						
2651 L 964.025	01.13-						
2651 L 964.022	01.13-						
2651 LS 964.425	01.13-						
2651 LS 964.422	01.13-						
2651 S, 2651 LS 964.424 964.414	01.13-						
2651, 2651 L 964.024 964.014	01.13-						
3251 B, 3251 LB 964.338 964.330	01.13-						
3251 K, 3251 LK 964.238 964.230	01.13-						
3251 L 964.041	01.13-						
3251 LB 964.341	01.13-						
3251 LK 964.241	01.13-						
3251, 3251 L 964.038 964.030	01.13-						
3351 A 964.018	01.13-						
3351 AK 964.218	01.13-						
3351 AS 964.418	01.13-						
3351 B, 3351 LB 964.326 964.316	01.13-						









































		CODE				
--	--	------	--	---	---	---

MERCEDES-BENZ

AROCS		01.13 -						
3351 K, 3351 LK 964.216 964.226 3351 S, 3351 LS 964.426 964.416 3351, 3351 L 964.016 964.026 4151 964.031 4151 AK 964.232 4151 AK 964.233 4151 B 964.331 4151 K 964.231	01.13-	OM471		3400 700 534 	430 18	XTend Nabenprofil / Hub Profile: 45x50-18N Euro 6 / Euro 6 max. übertragbares Motormoment [Nm] / max. transmittable engine torque [Nm]: 2600 Nur zusammen verbauen / Only install together	(48) (18) (87) (53)	
	01.13-			3400 700 529 	430 18	XTend Getr. / GBox: Powershift Nabenprofil / Hub Profile: 45x50-18N Euro 6 / Euro 6 Nur zusammen verbauen / Only install together	(48) (18) (53)	
	01.13-			3400 710 073 	430 18	Getr. / GBox: Powershift Nabenprofil / Hub Profile: 45x50-18N Euro 6 / Euro 6 mit automatischer Nachstellung / with automatic adjustment Nur zusammen verbauen / Only install together	(48) (18) (95) (53)	
	01.13-			3400 700 544 	430 18	XTend Getr. / GBox: Powershift Nabenprofil / Hub Profile: 45x50-18N Euro 6 / Euro 6 Nur zusammen verbauen / Only install together	(48) (18) (53)	
	01.13-			3400 710 076 	430 18	Getr. / GBox: Powershift Nabenprofil / Hub Profile: 45x50-18N Euro 6 / Euro 6 mit automatischer Nachstellung / with automatic adjustment Nur zusammen verbauen / Only install together	(48) (18) (95) (53)	
					6482 000 218	PHIS-6/38	Getr. / GBox: Powershift Euro 6 / Euro 6 Immer erneuern / Renew everytime	(18) (30)
					3400 700 609 	400 18 MFZ2/400X 400WGTZ KZISZ-5	Euro 6 / Euro 6	(18)
2558 L 964.020 2563 L 964.020	01.14-	OM473		3400 700 535 	400 MF2/400E	XTend Getr. / GBox: Powershift Euro 6 / Euro 6 Nur zusammen verbauen / Only install together	(18) (53)	
	01.14-			6482 000 218	PHIS-6/38	Getr. / GBox: Powershift Euro 6 / Euro 6 Immer erneuern / Renew everytime	(18) (30)	
					3400 700 533 	430 18	XTend Nabenprofil / Hub Profile: 45x50-18N Euro 6 / Euro 6 Nur zusammen verbauen / Only install together	(48) (18) (53)
3342, 3342 L 964.026 964.016	01.13-	OM471		3400 700 531 	430 18	XTend Getr. / GBox: Powershift Nabenprofil / Hub Profile: 45x50-18N Euro 6 / Euro 6 Nur zusammen verbauen / Only install together	(48) (18) (53)	
				3400 710 071 	430 18	Getr. / GBox: Powershift Nabenprofil / Hub Profile: 45x50-18N Euro 6 / Euro 6 mit automatischer Nachstellung / with automatic adjustment Nur zusammen verbauen / Only install together	(48) (18) (95) (53)	
				3400 700 542 	430 18	XTend Getr. / GBox: Powershift Nabenprofil / Hub Profile: 45x50-18N Euro 6 / Euro 6 Nur zusammen verbauen / Only install together	(48) (18) (53)	
				3400 710 074 	430 18	Getr. / GBox: Powershift Nabenprofil / Hub Profile: 45x50-18N Euro 6 / Euro 6 mit automatischer Nachstellung / with automatic adjustment Nur zusammen verbauen / Only install together	(48) (18) (95) (53)	
				6482 000 218	PHIS-6/38	Getr. / GBox: Powershift Euro 6 / Euro 6 Immer erneuern / Renew everytime	(18) (30)	
						3400 700 533 	430 18	XTend Nabenprofil / Hub Profile: 45x50-18N Euro 6 / Euro 6 Nur zusammen verbauen / Only install together



































































		CODE				
--	--	------	--	---	---	---

MERCEDES-BENZ

ATEGO 712 - 717								
712 970.001 970.017 970.003 970.005 970.013 970.012 970.011 970.002 970.015 712, 713 970.005 970.013 970.001 970.017 970.002/003 970.011/012 970.015 714 K 972.011 714, 714 L 970.213 970.003 970.005 970.012 970.017 970.015 970.002 970.011 970.203 970.001 970.215 970.013 970.205 970.217 715, 715 L, 716, 716 L 970.003 970.001/002 970.203 970.205 970.015 970.005 970.017 715,715 L 970.017 970.205 970.002/003 970.203 970.005 970.001 717 K 972.011 717, 717 L 970.217 970.013 970.011 970.213 970.015 970.017 970.012 970.215	01.98 - 10.04	OM904		3400 127 701   3482 000 462  1878 052 842	362 18 MF362 362WG7B			
		10.04 -			3400 700 484 HD   3482 000 462  1878 006 757	362 18 MF362 362WG7B		
		01.98 - 10.04			3400 710 005  3482 000 462  1878 052 842  3182 998 501	362 18 MF362 362WG7B HHIS-3	ohne Sensor / without sensor Füllmedium: Bremsflüssigkeit / Fill Medium: Brake Fluid	(105) (25)
		01.98 - 10.04			3400 710 008  3482 000 462  1878 052 842  3182 600 101	362 18 MF362 362WG7B HHIS-3	mit Sensor / with sensor Füllmedium: Bremsflüssigkeit / Fill Medium: Brake Fluid	(92) (25)
		01.98 - 10.04	OM906		3400 121 201   3482 000 464  1878 023 931	395 18 MF395 395GTZ		
		01.98 - 10.04			3400 710 009  3482 000 464  1878 023 931  3182 600 101	395 18 MF395 395GTZ HHIS-3	mit Sensor / with sensor Füllmedium: Bremsflüssigkeit / Fill Medium: Brake Fluid	(92) (25)
		01.98 - 10.04			3400 710 006  3482 000 464  1878 023 931  3182 998 501	395 18 MF395 395GTZ HHIS-3	ohne Sensor / without sensor Füllmedium: Bremsflüssigkeit / Fill Medium: Brake Fluid	(105) (25)
					3400 710 016  3482 000 464  1878 023 931  3182 600 141	395 18 MF395 395GTZ	ohne Sensor / without sensor Füllmedium: Mineralöl / Fill Medium: Mineral Oil	(105) (26)
			OM904, OM906		3182 600 101	HHIS-3	mit Sensor / with sensor Füllmedium: Bremsflüssigkeit / Fill Medium: Brake Fluid Immer erneuern / Renew everytime	(92) (25) (30)
					3182 998 501	HHIS-3	ohne Sensor / without sensor Füllmedium: Bremsflüssigkeit / Fill Medium: Brake Fluid Immer erneuern / Renew everytime	(105) (25) (30)
				3182 600 141		ohne Sensor / without sensor Füllmedium: Mineralöl / Fill Medium: Mineral Oil Immer erneuern / Renew everytime	(105) (26) (30)	
				3151 000 396 	KZIS-4	Getr. / GBox: G6-60, 715.050		
716 K 967.201 716, 716 L 967.021 967.001 716, 716 L 967.020 967.000 718 K 967.201 718, 718 L 967.021 967.001 721 K 967.201 721, 721 L 967.001 967.021 723 K 967.201 723, 723 L 967.001 967.021	04.13 -	OM934		3400 700 638 	362 18 PHIS-5/34	Euro 6 / Euro 6	(18)	
		04.13 -			6482 000 219 	PHIS-5/34	Euro 6 / Euro 6 Immer erneuern / Renew everytime	(18) (30)
		04.13 -						
		04.13 -						
		04.13 -						
		04.13 -						
		04.13 -						









		CODE				
--	--	------	--	---	---	---

MERCEDES-BENZ

ATEGO 812 - 830								
823, 823 L 970.222 970.227 970.023 970.025 970.027 970.021/022 970.221 970.225 970.223 823, 823 L, 824, 824 L 970.221 970.223 970.222 970.023 970.025 970.225 970.227 970.021/022 970.027 824 K 972.012 972.011 972.021/022 824, 824 L 970.023 970.021 970.027 970.025 970.022	01.98 - 10.04	OM904		3400 127 701   3482 000 462  1878 052 842	362 18 MF362 362WG7B			
	10.04 -			3400 700 484 HD   3482 000 462  1878 006 757	362 18 MF362 362WG7B			
	10.04 -			3400 710 005  3482 000 462  1878 052 842  3182 998 501	362 18 MF362 362WG7B HHIS-3	ohne Sensor / without sensor Füllmedium: Bremsflüssigkeit / Fill Medium: Brake Fluid	(105) (25)	
	10.04 -			3400 710 008  3482 000 462  1878 052 842  3182 600 101	362 18 MF362 362WG7B HHIS-3	mit Sensor / with sensor Füllmedium: Bremsflüssigkeit / Fill Medium: Brake Fluid	(92) (25)	
					3400 700 397  3482 000 463  1878 004 232	395 18 MF395 395WG7Z	für / for: SA 504672/22	(69)
			OM906		3400 121 201   3482 000 464  1878 023 931	395 18 MF395 395GTZ		
					3400 121 301 HD   3482 000 463  1878 023 831	395 18 MF395 395GTZ	für Fahrzeuge mit Kupplungskraftverstärker / for vehicles with clutch booster	(73)
					3400 710 006  3482 000 464  1878 023 931  3182 998 501	395 18 MF395 395GTZ HHIS-3	ohne Sensor / without sensor Füllmedium: Bremsflüssigkeit / Fill Medium: Brake Fluid	(105) (25)
					3400 710 007 HD  3482 000 463  1878 023 831  3182 998 501	395 18 MF395 395GTZ HHIS-3	für Fahrzeuge mit Kupplungskraftverstärker / for vehicles with clutch booster ohne Sensor / without sensor Füllmedium: Bremsflüssigkeit / Fill Medium: Brake Fluid	(73) (105) (25)
					3400 710 009  3482 000 464  1878 023 931  3182 600 101	395 18 MF395 395GTZ HHIS-3	mit Sensor / with sensor Füllmedium: Bremsflüssigkeit / Fill Medium: Brake Fluid	(92) (25)
					3400 710 010 HD  3482 000 463  1878 023 831  3182 600 101	395 18 MF395 395GTZ HHIS-3	für Fahrzeuge mit Kupplungskraftverstärker / for vehicles with clutch booster mit Sensor / with sensor Füllmedium: Bremsflüssigkeit / Fill Medium: Brake Fluid	(73) (92) (25)
					3400 710 012  3482 000 464  1878 023 931  3182 600 172	395 18 MF395 395GTZ	für / for: SA 504673/26 Kabellänge [mm] / Cable Length [mm]: 220 mit Sensor / with sensor Füllmedium: Mineralöl / Fill Medium: Mineral Oil	(69) (36) (92) (26)
					3400 710 013 HD  3482 000 463  1878 023 831  3182 600 172	395 18 MF395 395GTZ	für / for: SA 504673/26 Kabellänge [mm] / Cable Length [mm]: 220 für Fahrzeuge mit Kupplungskraftverstärker / for vehicles with clutch booster mit Sensor / with sensor Füllmedium: Mineralöl / Fill Medium: Mineral Oil	(69) (36) (73) (92) (26)
					3400 710 015  3482 000 464  1878 023 931  3182 600 166	395 18 MF395 395GTZ	mit Sensor / with sensor Füllmedium: Mineralöl / Fill Medium: Mineral Oil	(92) (26)
					3400 710 014 HD  3482 000 463  1878 023 831  3182 600 166	395 18 MF395 395GTZ	für Fahrzeuge mit Kupplungskraftverstärker / for vehicles with clutch booster mit Sensor / with sensor Füllmedium: Mineralöl / Fill Medium: Mineral Oil	(73) (92) (26)
					3400 710 016  3482 000 464  1878 023 931  3182 600 141	395 18 MF395 395GTZ	ohne Sensor / without sensor Füllmedium: Mineralöl / Fill Medium: Mineral Oil	(105) (26)
					3400 710 017 HD  3482 000 463  1878 023 831  3182 600 141	395 18 MF395 395GTZ	für Fahrzeuge mit Kupplungskraftverstärker / for vehicles with clutch booster ohne Sensor / without sensor Füllmedium: Mineralöl / Fill Medium: Mineral Oil	(73) (105) (26)





























































MERCEDES-BENZ

ATEGO 812 - 830

816 K 967.202	04.13-	OM934		3400 700 638 	362 18	Euro 6 / Euro 6	(18)
816 K 967.201	04.13-			6482 000 219 	PHIS-5/34	Euro 6 / Euro 6 Immer erneuern / Renew everytime	(18) (30)
816, 816 L 967.002 967.022	04.13-						
816, 816 L 967.001 967.021	04.13-						
816, 816 L 970.027	10.04-						
818 K 967.202	04.13-						
818 K 967.201	04.13-						
818, 818 L 967.022 967.002	04.13-						
818, 818 L 967.021 967.001	04.13-						
821 K 967.201	04.13-						
821 K 967.202	04.13-						
821, 821 L 967.001 967.021	04.13-						
821, 821 L 967.002 967.022	04.13-						
823 K 967.202	04.13-						
823 K 967.201	04.13-						
823, 823 L 967.022 967.002	04.13-						
823, 823 L 967.021 967.001	04.13-						
824 K 967.202	04.13-	OM936		3400 700 639 	395 18	Euro 6 / Euro 6	(18)
824, 824 L 967.022 967.002	04.13-			3400 700 546 	395 18	XTend Getr. / GBox: Powershift Nabenprofil / Hub Profile: 36x40-18N Euro 6 / Euro 6 Nur zusammen verbauen / Only install together	(48) (18) (53)
				6482 000 219	PHIS-5/34	Getr. / GBox: Powershift Euro 6 / Euro 6 Immer erneuern / Renew everytime	(18) (30)

		CODE				
--	--	------	--	---	---	---





































MERCEDES-BENZ

ATEGO 812 - 830								
826, 826 L 970.025 970.027 970.023 970.022 970.021 829, 829 L 970.022 970.025 970.023 970.021 970.027	10.04-	OM904		3400 127 701   3482 000 462  1878 052 842	362 18 MF362 362WGTB			
	10.04-			3400 700 484 HD   3482 000 462  1878 006 757	362 18 MF362 362WGTB			
				3400 710 005  3482 000 462  1878 052 842  3182 998 501	362 18 MF362 362WGTB HHIS-3	ohne Sensor / without sensor Füllmedium: Bremsflüssigkeit / Fill Medium: Brake Fluid	(105) (25)	
				3400 710 008  3482 000 462  1878 052 842  3182 600 101	362 18 MF362 362WGTB HHIS-3	mit Sensor / with sensor Füllmedium: Bremsflüssigkeit / Fill Medium: Brake Fluid	(92) (25)	
				3400 700 397  3482 000 463  1878 004 232	395 18 MF395 395WGTZ	für / for: SA 504672/22	(69)	
		OM906		3400 121 201   3482 000 464  1878 023 931	395 18 MF395 395GTZ			
				3400 121 301 HD   3482 000 463  1878 023 831	395 18 MF395 395GTZ	für Fahrzeuge mit Kupplungskraftverstärker / for vehicles with clutch booster	(73)	
				3400 710 006  3482 000 464  1878 023 931  3182 998 501	395 18 MF395 395GTZ HHIS-3	ohne Sensor / without sensor Füllmedium: Bremsflüssigkeit / Fill Medium: Brake Fluid	(105) (25)	
				3400 710 007 HD  3482 000 463  1878 023 831  3182 998 501	395 18 MF395 395GTZ HHIS-3	für Fahrzeuge mit Kupplungskraftverstärker / for vehicles with clutch booster ohne Sensor / without sensor Füllmedium: Bremsflüssigkeit / Fill Medium: Brake Fluid	(73) (105) (25)	
				3400 710 009  3482 000 464  1878 023 931  3182 600 101	395 18 MF395 395GTZ HHIS-3	mit Sensor / with sensor Füllmedium: Bremsflüssigkeit / Fill Medium: Brake Fluid	(92) (25)	
				3400 710 010 HD  3482 000 463  1878 023 831  3182 600 101	395 18 MF395 395GTZ HHIS-3	für Fahrzeuge mit Kupplungskraftverstärker / for vehicles with clutch booster mit Sensor / with sensor Füllmedium: Bremsflüssigkeit / Fill Medium: Brake Fluid	(73) (92) (25)	
				3400 710 015  3482 000 464  1878 023 931  3182 600 166	395 18 MF395 395GTZ	mit Sensor / with sensor Füllmedium: Mineralöl / Fill Medium: Mineral Oil	(92) (26)	
				3400 710 014 HD  3482 000 463  1878 023 831  3182 600 166	395 18 MF395 395GTZ	für Fahrzeuge mit Kupplungskraftverstärker / for vehicles with clutch booster mit Sensor / with sensor Füllmedium: Mineralöl / Fill Medium: Mineral Oil	(73) (92) (26)	
				3400 710 016  3482 000 464  1878 023 931  3182 600 141	395 18 MF395 395GTZ	ohne Sensor / without sensor Füllmedium: Mineralöl / Fill Medium: Mineral Oil	(105) (26)	
				3400 710 017 HD  3482 000 463  1878 023 831  3182 600 141	395 18 MF395 395GTZ	für Fahrzeuge mit Kupplungskraftverstärker / for vehicles with clutch booster ohne Sensor / without sensor Füllmedium: Mineralöl / Fill Medium: Mineral Oil	(73) (105) (26)	
			OM904, 906		3182 998 501	HHIS-3	ohne Sensor / without sensor Füllmedium: Bremsflüssigkeit / Fill Medium: Brake Fluid Immer erneuern / Renew everytime	(105) (25) (30)
					3182 600 166		mit Sensor / with sensor Füllmedium: Mineralöl / Fill Medium: Mineral Oil Immer erneuern / Renew everytime	(92) (26) (30)
				3182 600 141		ohne Sensor / without sensor Füllmedium: Mineralöl / Fill Medium: Mineral Oil Immer erneuern / Renew everytime	(105) (26) (30)	
				3182 600 101	HHIS-3	mit Sensor / with sensor Füllmedium: Bremsflüssigkeit / Fill Medium: Brake Fluid Immer erneuern / Renew everytime	(92) (25) (30)	
				3151 000 396	KZIS-4			

		CODE				
--	--	------	--	---	---	---





















MERCEDES-BENZ

ATEGO 914 - 930









914 K 972.042 972.022 914, 914 L 970.237 970.035 970.031 970.033 970.032 970.235 970.233 970.037	01.98 - 10.04	OM904		3400 127 701   3482 000 462  1878 052 842	362 18 MF362 362WG7B			
	01.98 - 10.04			3400 700 484 HD   3482 000 462  1878 006 757	362 18 MF362 362WG7B			
				3400 710 005  3482 000 462  1878 052 842  3182 998 501	362 18 MF362 362WG7B HHIS-3	ohne Sensor / without sensor Füllmedium: Bremsflüssigkeit / Fill Medium: Brake Fluid	(105) (25)	
				3400 710 008  3482 000 462  1878 052 842  3182 600 101	362 18 MF362 362WG7B HHIS-3	mit Sensor / with sensor Füllmedium: Bremsflüssigkeit / Fill Medium: Brake Fluid	(92) (25)	
			OM906		3400 121 201   3482 000 464  1878 023 931	395 18 MF395 395GTZ		
				3400 710 009  3482 000 464  1878 023 931  3182 600 101	395 18 MF395 395GTZ HHIS-3	mit Sensor / with sensor Füllmedium: Bremsflüssigkeit / Fill Medium: Brake Fluid	(92) (25)	
				3400 710 006  3482 000 464  1878 023 931  3182 998 501	395 18 MF395 395GTZ HHIS-3	ohne Sensor / without sensor Füllmedium: Bremsflüssigkeit / Fill Medium: Brake Fluid	(105) (25)	
				3400 710 016  3482 000 464  1878 023 931  3182 600 141	395 18 MF395 395GTZ	ohne Sensor / without sensor Füllmedium: Mineralöl / Fill Medium: Mineral Oil	(105) (26)	
			OM904, OM906		3182 600 101	HHIS-3	mit Sensor / with sensor Füllmedium: Bremsflüssigkeit / Fill Medium: Brake Fluid Immer erneuern / Renew everytime	(92) (25) (30)
				3182 998 501	HHIS-3	ohne Sensor / without sensor Füllmedium: Bremsflüssigkeit / Fill Medium: Brake Fluid Immer erneuern / Renew everytime	(105) (25) (30)	
				3182 600 141		ohne Sensor / without sensor Füllmedium: Mineralöl / Fill Medium: Mineral Oil Immer erneuern / Renew everytime	(105) (26) (30)	
				3151 000 396 	KZIS-4	Getr. / GBox: G6-60, 715.050		

		CODE				
--	--	------	--	---	---	---

MERCEDES-BENZ















ATEGO 914 - 930							
915 AF 976.332-333 915 K 972.031 972.022 915, 915 L, 916, 916 L 970.033 970.037 970.031 970.233 970.032 970.035 970.237 970.235 916 K 972.031/032 916, 916 L 970.033 970.037 970.031/032 970.035 917 AF 976.332 976.334 976.333 917 K 972.031 972.022 972.032 917 KO 975.031 917, 917 L 970.235 970.035 970.237 970.032 970.031 970.033 970.233 970.037 918 AF 976.332-334 918 K 972.032 972.031 918, 918 L 970.233 970.031 970.235 970.237 970.033 970.037 970.032 970.035 922 AF 976.333/334 976.332 922 K 972.022 972.031/032 922, 922 L 970.235 970.032 970.035 970.033 970.233 970.237 970.037 970.031 923 K 972.022 972.031 923, 923 L 970.035 970.031 970.235 970.237 970.032 970.233 970.033 970.037 923, 923 L, 924, 924 L 970.031 970.233 970.235 970.032 970.037 970.033 970.035 970.237 924 K 972.031/032 924, 924 L 970.031 970.037 970.032/033 970.035 925 AF 976.333 976.332 976.334 926 AF 976.333 976.332 976.334 926, 926 L 970.032 970.035 970.033 970.031 970.037 929, 929 L 970.032 970.037 970.033 970.035 970.031	10.04 -	OM904		3400 127 701  3482 000 462 1878 052 842	362 18 MF362 362WGTB		
		10.04 -			3400 700 484 HD  3482 000 462 1878 006 757	362 18 MF362 362WGTB	
		10.04 -			3400 710 005 3482 000 462 1878 052 842 3182 998 501	362 18 MF362 362WGTB HHIS-3	ohne Sensor / without sensor Füllmedium: Bremsflüssigkeit / Fill Medium: Brake Fluid (105) (25)
		01.98 - 10.04			3400 710 008 3482 000 462 1878 052 842 3182 600 101	362 18 MF362 362WGTB HHIS-3	mit Sensor / with sensor Füllmedium: Bremsflüssigkeit / Fill Medium: Brake Fluid (92) (25)
		01.98 - 10.04			3400 700 397 3482 000 463 1878 004 232	395 18 MF395 395WGTZ	für / for: SA 504672/22 (69)
		01.98 - 10.04	OM906		3400 121 201  3482 000 464 1878 023 931	395 18 MF395 395GTZ	
		10.04 -			3400 121 301 HD  3482 000 463 1878 023 831	395 18 MF395 395GTZ	für Fahrzeuge mit Kupplungskraftverstärker / for vehicles with clutch booster (73)
		10.04 -			3400 710 006 3482 000 464 1878 023 931 3182 998 501	395 18 MF395 395GTZ HHIS-3	ohne Sensor / without sensor Füllmedium: Bremsflüssigkeit / Fill Medium: Brake Fluid (105) (25)
		10.04 -			3400 710 007 HD 3482 000 463 1878 023 831 3182 998 501	395 18 MF395 395GTZ HHIS-3	für Fahrzeuge mit Kupplungskraftverstärker / for vehicles with clutch booster ohne Sensor / without sensor Füllmedium: Bremsflüssigkeit / Fill Medium: Brake Fluid (73) (105) (25)
		01.98 - 10.04			3400 710 009 3482 000 464 1878 023 931 3182 600 101	395 18 MF395 395GTZ HHIS-3	mit Sensor / with sensor Füllmedium: Bremsflüssigkeit / Fill Medium: Brake Fluid (92) (25)
		01.98 - 10.04			3400 710 010 HD 3482 000 463 1878 023 831 3182 600 101	395 18 MF395 395GTZ HHIS-3	für Fahrzeuge mit Kupplungskraftverstärker / for vehicles with clutch booster mit Sensor / with sensor Füllmedium: Bremsflüssigkeit / Fill Medium: Brake Fluid (73) (92) (25)
		10.04 -			3400 710 015 3482 000 464 1878 023 931 3182 600 166	395 18 MF395 395GTZ	mit Sensor / with sensor Füllmedium: Mineralöl / Fill Medium: Mineral Oil (92) (26)
		10.04 -			3400 710 014 HD 3482 000 463 1878 023 831 3182 600 166	395 18 MF395 395GTZ	für Fahrzeuge mit Kupplungskraftverstärker / for vehicles with clutch booster mit Sensor / with sensor Füllmedium: Mineralöl / Fill Medium: Mineral Oil (73) (92) (26)
		01.98 - 10.04			3400 710 016 3482 000 464 1878 023 931 3182 600 141	395 18 MF395 395GTZ	ohne Sensor / without sensor Füllmedium: Mineralöl / Fill Medium: Mineral Oil (105) (26)
		10.04 -			3400 710 017 HD 3482 000 463 1878 023 831 3182 600 141	395 18 MF395 395GTZ	für Fahrzeuge mit Kupplungskraftverstärker / for vehicles with clutch booster ohne Sensor / without sensor Füllmedium: Mineralöl / Fill Medium: Mineral Oil (73) (105) (26)
	10.04 -	OM904, 906		3182 998 501	HHIS-3	ohne Sensor / without sensor Füllmedium: Bremsflüssigkeit / Fill Medium: Brake Fluid Immer erneuern / Renew everytime (105) (25)	
				3182 600 166		mit Sensor / with sensor Füllmedium: Mineralöl / Fill Medium: Mineral Oil Immer erneuern / Renew everytime (92) (26) (30)	
				3182 600 141		ohne Sensor / without sensor Füllmedium: Mineralöl / Fill Medium: Mineral Oil Immer erneuern / Renew everytime (105) (26) (30)	
				3182 600 101	HHIS-3	mit Sensor / with sensor Füllmedium: Bremsflüssigkeit / Fill Medium: Brake Fluid Immer erneuern / Renew everytime (92) (25) (30)	
				3151 000 396	KZIS-4		

MERCEDES-BENZ









ATEGO 914 - 930							
916 K 967.203	04.13-	OM934		3400 700 638 	362 18	Euro 6 / Euro 6	(18)
916, 916 L 967.023 967.003	04.13-			6482 000 219 	PHIS-5/34	Euro 6 / Euro 6 Immer erneuern / Renew everytime	(18) (30)
918 AF 967.633	04.13-						
918 F 967.603	04.13-						
918 K 967.203	04.13-						
918, 918 L 967.003 967.023	04.13-						
921 K 967.203	04.13-						
921, 921 L 967.023 967.003	04.13-						
923 AF 967.633	04.13-						
923 F 967.603	04.13-						
923 K 967.203	04.13-						
923, 923 L 967.003 967.023	04.13-						
924 K 967.203	04.13-	OM936		3400 700 639 	395 18	Euro 6 / Euro 6	(18)
924, 924 L 967.023 967.003	04.13-			3400 700 546 	395 18	XTend Getr. / GBox: Powershift Nabenprofil / Hub Profile: 36x40-18N Euro 6 / Euro 6	(48) (18)
927 AF 967.633	04.13-					Nur zusammen verbauen / Only install together	(53)
927 F 967.603	04.13-			6482 000 219	PHIS-5/34	Getr. / GBox: Powershift Euro 6 / Euro 6 Immer erneuern / Renew everytime	(18) (30)

		CODE				
--	--	------	--	---	---	---

MERCEDES-BENZ

ATEGO 1014 - 1118						
1014 K 972.041	01.98-10.04	OM904		3400 127 701 3482 000 462 1878 052 842	362 18 MF362 362WGTB	
1014, 1014 L 970.047 970.043 970.045 970.247 970.243 970.245 970.041/042	01.98-10.04			3400 700 484 HD 3482 000 462 1878 006 757	362 18 MF362 362WGTB	
1015 K 972.042	10.04-			3400 710 005 3482 000 462 1878 052 842 3182 998 501	362 18 MF362 362WGTB HHIS-3	ohne Sensor / without sensor Füllmedium: Bremsflüssigkeit / Fill Medium: Brake Fluid (105) (25)
1015 K, 1016 K 972.041/042	10.04-			3400 710 008 3482 000 462 1878 052 842 3182 600 101	362 18 MF362 362WGTB HHIS-3	mit Sensor / with sensor Füllmedium: Bremsflüssigkeit / Fill Medium: Brake Fluid (92) (25)
1015, 1015 L 970.245 970.043 970.243 970.247 970.042 970.045 970.047 970.041	10.04-			3400 700 397 3482 000 463 1878 004 232	395 18 MF395 395WGTZ	für / for: SA 504672/22 (69)
1016, 1016 L 970.043 970.045 970.042 970.047 970.041	10.04-			3400 121 201 3482 000 464 1878 023 931	395 18 MF395 395GTZ	
1016, 1016 L 970.045 970.245 970.047 970.243 970.247 970.041-043	10.04-			3400 121 301 HD 3482 000 463 1878 023 831	395 18 MF395 395GTZ	für Fahrzeuge mit Kupplungskraftverstärker / for vehicles with clutch booster (73)
1017 A 970.342	01.98-10.04	OM906		3400 710 006 3482 000 464 1878 023 931 3182 998 501	395 18 MF395 395GTZ HHIS-3	ohne Sensor / without sensor Füllmedium: Bremsflüssigkeit / Fill Medium: Brake Fluid (105) (25)
1017 AK 972.342	10.04-			3400 710 007 HD 3482 000 463 1878 023 831 3182 998 501	395 18 MF395 395GTZ HHIS-3	für Fahrzeuge mit Kupplungskraftverstärker / for vehicles with clutch booster (73) ohne Sensor / without sensor (105) Füllmedium: Bremsflüssigkeit / Fill Medium: Brake Fluid (25)
1017 AK 972.342	01.98-10.04			3400 710 009 3482 000 464 1878 023 931 3182 600 101	395 18 MF395 395GTZ HHIS-3	mit Sensor / with sensor Füllmedium: Bremsflüssigkeit / Fill Medium: Brake Fluid (92) (25)
1017 K 972.041/042	01.98-10.04			3400 710 010 HD 3482 000 463 1878 023 831 3182 600 101	395 18 MF395 395GTZ HHIS-3	für Fahrzeuge mit Kupplungskraftverstärker / for vehicles with clutch booster (73) mit Sensor / with sensor (92) Füllmedium: Bremsflüssigkeit / Fill Medium: Brake Fluid (25)
1017 K, 1018 K 972.042 972.041	10.04-			3400 710 015 3482 000 464 1878 023 931 3182 600 166	395 18 MF395 395GTZ	mit Sensor / with sensor Füllmedium: Mineralöl / Fill Medium: Mineral Oil (92) (26)
1017 KO, 1018 KO 975.041	01.98-10.04			3400 710 014 HD 3482 000 463 1878 023 831 3182 600 166	395 18 MF395 395GTZ	für Fahrzeuge mit Kupplungskraftverstärker / for vehicles with clutch booster (73) mit Sensor / with sensor (92) Füllmedium: Mineralöl / Fill Medium: Mineral Oil (26)
1017, 1017 L 970.041 970.243 970.247 970.245 970.042/043 970.045 970.047	01.98-10.04			3400 710 016 3482 000 464 1878 023 931 3182 600 141	395 18 MF395 395GTZ	ohne Sensor / without sensor Füllmedium: Mineralöl / Fill Medium: Mineral Oil (105) (26)
1018 A 970.342	10.04-			3400 710 017 HD 3482 000 463 1878 023 831 3182 600 141	395 18 MF395 395GTZ	für Fahrzeuge mit Kupplungskraftverstärker / for vehicles with clutch booster (73) ohne Sensor / without sensor (105) Füllmedium: Mineralöl / Fill Medium: Mineral Oil (26)
1018 AK 972.342	10.04-			3182 998 501	HHIS-3	ohne Sensor / without sensor Füllmedium: Bremsflüssigkeit / Fill Medium: Brake Fluid (105) (25)
1018, 1018 L 970.245 970.047 970.243 970.043 970.045 970.247 970.042 970.041	10.04-			3182 600 166		mit Sensor / with sensor Füllmedium: Mineralöl / Fill Medium: Mineral Oil (92) Immer erneuern / Renew everytime (30)
1022 A 970.342	10.04-			3182 600 141		ohne Sensor / without sensor Füllmedium: Mineralöl / Fill Medium: Mineral Oil (105) (26)
1022 AK 972.342	10.04-			3182 600 101	HHIS-3	mit Sensor / with sensor Füllmedium: Bremsflüssigkeit / Fill Medium: Brake Fluid (92) (25)
1022 K 972.042 972.041	10.04-			3151 000 396	KZIS-4	Immer erneuern / Renew everytime (30)
1022 KO 975.041	10.04-	OM904, 906				
1022, 1022 L 970.043 970.245 970.243 970.041 970.247 970.045 970.047 970.042	10.04-					
1023 A, 1024 A 970.342	10.04-					
1023 AK 972.342	01.98-10.04					
1023 K 972.041/042	01.98-10.04					
1023, 1023 L 970.245 970.243 970.247 970.045 970.043 970.047 970.041/042	01.98-10.04	OM904, 906				
1023, 1023 L, 1024, 1024 L 970.042 970.243 970.247 970.041 970.043 970.045 970.047 970.245	10.04-					
1024 AK 972.342	10.04-					
1024 K 972.041/042	10.04-					
1024, 1024 L 970.043 970.047 970.042 970.041 970.045	10.04-					
1026, 1026 L 970.041 970.043 970.045 970.042 970.047	10.04-					
1029, 1029 L 970.045 970.043 970.042 970.041 970.047	10.04-					
1118 AF	01.11-					



MERCEDES-BENZ

ATEGO 1014 - 1118						
1016 K 967.204	04.13-	OM934		3400 700 638 	362 18	Euro 6 / Euro 6 (18)
1016, 1016 L 967.004 967.024	04.13-			6482 000 219 	PHIS-5/34	Euro 6 / Euro 6 Immer erneuern / Renew everytime (18) (30)
1018 A 967.034	04.13-					
1018 AK 967.234	04.13-					
1018 K 967.204	04.13-					
1018 KO 967.504	04.13-					
1018, 1018 L 967.024 967.004	04.13-					
1021 A 967.034	04.13-					
1021 AK 967.234	04.13-					
1021 K 967.204	04.13-					
1021 KO 967.504	04.13-					
1021, 1021 L 967.024 967.004	04.13-					
1023 A 967.034	04.13-					
1023 AK 967.234	04.13-					
1023 K 967.204	04.13-					
1023 KO 967.504	04.13-					
1023, 1023 L 967.024 967.004	04.13-					
1024 A 967.034	04.13-	OM936		3400 700 639 	395 18	Euro 6 / Euro 6 (18)
1024 AK 967.234	04.13-			3400 700 546 	395 18	XTend Getr. / GBox: Powershift Nabenprofil / Hub Profile: 36x40-18N Euro 6 / Euro 6 (48) Nur zusammen verbauen / Only install together (18) (53)
1024 K 967.204	04.13-					
1024, 1024 L 967.004 967.024	04.13-			6482 000 219	PHIS-5/34	Getr. / GBox: Powershift Euro 6 / Euro 6 (18) Immer erneuern / Renew everytime (30)

		CODE				
--	--	------	--	---	---	---





























































MERCEDES-BENZ

ATEGO 1214 - 1229

1214 K 972.052	01.98-10.04	OM904		3400 127 701  3482 000 462 1878 052 842	362 18 MF362 362WGTB		
1214, 1214 L 970.287 970.058 970.083 970.087 970.257/258 970.085 970.088 970.253 970.283 970.053 970.057 970.055 970.255 970.285	01.98-10.04			3400 700 484 HD   3482 000 462 1878 006 757	362 18 MF362 362WGTB		
1215 K 972.052	01.98-10.04			3400 710 005 3482 000 462 1878 052 842 3182 998 501	362 18 MF362 362WGTB HHIS-3	ohne Sensor / without sensor Füllmedium: Bremsflüssigkeit / Fill Medium: Brake Fluid	(105) (25)
1215, 1215 L 375.101 970.255 970.055 970.253 375.102 970.057/058 970.257/258 970.053	01.98-10.04			3400 710 008 3482 000 462 1878 052 842 3182 600 101	362 18 MF362 362WGTB HHIS-3	mit Sensor / with sensor Füllmedium: Bremsflüssigkeit / Fill Medium: Brake Fluid	(92) (25)
1215, 1215 L, 1216, 1216 L 970.255 970.257 970.055 970.253 970.283 970.057 970.285 970.053 970.087 970.287 970.058 970.083 970.085 970.088 970.258 970.288	10.04-			3400 700 397 3482 000 463 1878 004 232	395 18 MF395 395WGTZ	für / for: SA 504672/22	(69)
1216 K 972.052	10.04-			3400 121 201  3482 000 464 1878 023 931	395 18 MF395 395GTZ		
1216, 1216 L 970.053 970.055 970.058 970.087 970.057 970.085 970.083	10.04-	OM906		3400 121 301 HD  3482 000 463 1878 023 831	395 18 MF395 395GTZ	für Fahrzeuge mit Kupplungskraftverstärker / for vehicles with clutch booster	(73)
1217 K 972.052/053	01.98-10.04			3400 710 006 3482 000 464 1878 023 931 3182 998 501	395 18 MF395 395GTZ HHIS-3	ohne Sensor / without sensor Füllmedium: Bremsflüssigkeit / Fill Medium: Brake Fluid	(105) (25)
1217 KO 975.052	01.98-10.04			3400 710 006 3482 000 464 1878 023 931 3182 998 501	395 18 MF395 395GTZ HHIS-3	ohne Sensor / without sensor Füllmedium: Bremsflüssigkeit / Fill Medium: Brake Fluid	(105) (25)
1217, 1217 L 970.087 970.287 970.057 970.055 970.058 970.083 970.253 970.059 970.257 970.088 970.085 970.258 970.285 970.288 970.053 970.050 970.255 970.283	01.98-10.04			3400 710 007 HD 3482 000 463 1878 023 831 3182 998 501	395 18 MF395 395GTZ HHIS-3	für Fahrzeuge mit Kupplungskraftverstärker / for vehicles with clutch booster ohne Sensor / without sensor Füllmedium: Bremsflüssigkeit / Fill Medium: Brake Fluid	(73) (105) (25)
1218 K 972.052/053	10.04-			3400 710 009 3482 000 464 1878 023 931 3182 600 101	395 18 MF395 395GTZ HHIS-3	mit Sensor / with sensor Füllmedium: Bremsflüssigkeit / Fill Medium: Brake Fluid	(92) (25)
1218, 1218 L 970.253 970.050 970.083 970.257 970.287 970.057-059 970.085 970.285 970.053 970.055 970.288 970.087 970.258 970.283 970.088 970.255	10.04-			3400 710 010 HD 3482 000 463 1878 023 831 3182 600 101	395 18 MF395 395GTZ HHIS-3	für Fahrzeuge mit Kupplungskraftverstärker / for vehicles with clutch booster mit Sensor / with sensor Füllmedium: Bremsflüssigkeit / Fill Medium: Brake Fluid	(73) (92) (25)
1222 AF 976.354 976.353	10.04-			3400 710 015 3482 000 464 1878 023 931 3182 600 166	395 18 MF395 395GTZ	mit Sensor / with sensor Füllmedium: Mineralöl / Fill Medium: Mineral Oil	(92) (26)
1222 F 976.054 976.053	10.04-			3400 710 014 HD 3482 000 463 1878 023 831 3182 600 166	395 18 MF395 395GTZ	für Fahrzeuge mit Kupplungskraftverstärker / for vehicles with clutch booster mit Sensor / with sensor Füllmedium: Mineralöl / Fill Medium: Mineral Oil	(73) (92) (26)
1222 K 972.053 972.052	10.04-			3400 710 016 3482 000 464 1878 023 931 3182 600 141	395 18 MF395 395GTZ	ohne Sensor / without sensor Füllmedium: Mineralöl / Fill Medium: Mineral Oil	(105) (26)
1222, 1222 L 970.050 970.057/058 970.085 970.255 970.283 970.088 970.253 970.053 970.257 970.083 970.258 970.288 970.055 970.087 970.287 970.285	10.04-			3400 710 017 HD 3482 000 463 1878 023 831 3182 600 141	395 18 MF395 395GTZ	für Fahrzeuge mit Kupplungskraftverstärker / for vehicles with clutch booster ohne Sensor / without sensor Füllmedium: Mineralöl / Fill Medium: Mineral Oil	(73) (105) (26)
1223 K 972.052/053	01.98-09.04			3182 998 501	HHIS-3	ohne Sensor / without sensor Füllmedium: Bremsflüssigkeit / Fill Medium: Brake Fluid	(105) (25)
1223, 1223 L 970.287 970.055 970.059 970.085 970.258 970.285 970.088 970.255 970.050 970.058 970.057 970.083 970.087 970.253 970.257 970.283 970.288 970.053	01.98-10.04			3182 600 166		mit Sensor / with sensor Füllmedium: Mineralöl / Fill Medium: Mineral Oil Immer erneuern / Renew everytime	(92) (26) (30)
1223, 1223 L, 1224, 1224 L 970.053 970.059 970.057 970.255 970.257 970.283 970.087 970.258 970.253 970.055 970.083 970.085 970.088 970.050 970.058 970.285 970.287/288	10.04-			3182 600 141		ohne Sensor / without sensor Füllmedium: Mineralöl / Fill Medium: Mineral Oil Immer erneuern / Renew everytime	(105) (26) (30)
1224 K 972.053 972.052	10.04-	OM904, 906		3182 600 101	HHIS-3	mit Sensor / with sensor Füllmedium: Bremsflüssigkeit / Fill Medium: Brake Fluid Immer erneuern / Renew everytime	(92) (25) (30)
1224, 1224 L 970.087 970.059 970.085 970.055 970.058 970.050 970.053 970.057 970.083	10.04-			3151 000 396	KZIS-4		
1225 AF 976.354 976.353	01.98-10.04						
1225 F 976.053/054	01.98-10.04						
1225 F 976.054	10.04-						
1226 AF 976.354 976.353	10.04-						
1226 F 976.053/054	10.04-						















		CODE				
--	--	------	--	---	---	---

MERCEDES-BENZ













































ATEGO 1214 - 1229								
1226, 1226 L 970.057 970.055 970.050 970.085 970.087 970.058/059 970.083 970.053 1226, 1226 L 970.253 970.255 970.050 970.258 970.053 970.058/059 970.055 970.257 970.057 1229, 1229 L 970.059 970.053 970.087 970.085 970.055 970.058 970.050 970.057 970.083	10.04 - 12.14	OM904		3400 127 701   3482 000 462  1878 052 842	362 18 MF362 362WGTB			
	10.04 -			3400 700 484 HD   3482 000 462  1878 006 757	362 18 MF362 362WGTB			
	10.04 -				3400 710 005  3482 000 462  1878 052 842  3182 998 501	362 18 MF362 362WGTB HHIS-3	ohne Sensor / without sensor Füllmedium: Bremsflüssigkeit / Fill Medium: Brake Fluid	(105) (25)
					3400 710 008  3482 000 462  1878 052 842  3182 600 101	362 18 MF362 362WGTB HHIS-3	mit Sensor / with sensor Füllmedium: Bremsflüssigkeit / Fill Medium: Brake Fluid	(92) (25)
					3400 700 397  3482 000 463  1878 004 232	395 18 MF395 395WGTZ	für / for: SA 504672/22	(69)
			OM906		3400 121 201   3482 000 464  1878 023 931	395 18 MF395 395GTZ		
					3400 121 301 HD   3482 000 463  1878 023 831	395 18 MF395 395GTZ	für Fahrzeuge mit Kupplungskraftverstärker / for vehicles with clutch booster	(73)
					3400 710 006  3482 000 464  1878 023 931  3182 998 501	395 18 MF395 395GTZ HHIS-3	ohne Sensor / without sensor Füllmedium: Bremsflüssigkeit / Fill Medium: Brake Fluid	(105) (25)
					3400 710 007 HD  3482 000 463  1878 023 831  3182 998 501	395 18 MF395 395GTZ HHIS-3	für Fahrzeuge mit Kupplungskraftverstärker / for vehicles with clutch booster ohne Sensor / without sensor Füllmedium: Bremsflüssigkeit / Fill Medium: Brake Fluid	(73) (105) (25)
					3400 710 009  3482 000 464  1878 023 931  3182 600 101	395 18 MF395 395GTZ HHIS-3	mit Sensor / with sensor Füllmedium: Bremsflüssigkeit / Fill Medium: Brake Fluid	(92) (25)
					3400 710 010 HD  3482 000 463  1878 023 831  3182 600 101	395 18 MF395 395GTZ HHIS-3	für Fahrzeuge mit Kupplungskraftverstärker / for vehicles with clutch booster mit Sensor / with sensor Füllmedium: Bremsflüssigkeit / Fill Medium: Brake Fluid	(73) (92) (25)
					3400 710 015  3482 000 464  1878 023 931  3182 600 166	395 18 MF395 395GTZ	mit Sensor / with sensor Füllmedium: Mineralöl / Fill Medium: Mineral Oil	(92) (26)
					3400 710 014 HD  3482 000 463  1878 023 831  3182 600 166	395 18 MF395 395GTZ	für Fahrzeuge mit Kupplungskraftverstärker / for vehicles with clutch booster mit Sensor / with sensor Füllmedium: Mineralöl / Fill Medium: Mineral Oil	(73) (92) (26)
					3400 710 016  3482 000 464  1878 023 931  3182 600 141	395 18 MF395 395GTZ	ohne Sensor / without sensor Füllmedium: Mineralöl / Fill Medium: Mineral Oil	(105) (26)
					3400 710 017 HD  3482 000 463  1878 023 831  3182 600 141	395 18 MF395 395GTZ	für Fahrzeuge mit Kupplungskraftverstärker / for vehicles with clutch booster ohne Sensor / without sensor Füllmedium: Mineralöl / Fill Medium: Mineral Oil	(73) (105) (26)
			OM904, 906		3182 998 501	HHIS-3	ohne Sensor / without sensor Füllmedium: Bremsflüssigkeit / Fill Medium: Brake Fluid Immer erneuern / Renew everytime	(105) (25) (30)
					3182 600 166		mit Sensor / with sensor Füllmedium: Mineralöl / Fill Medium: Mineral Oil Immer erneuern / Renew everytime	(92) (26) (30)
					3182 600 141		ohne Sensor / without sensor Füllmedium: Mineralöl / Fill Medium: Mineral Oil Immer erneuern / Renew everytime	(105) (26) (30)
					3182 600 101	HHIS-3	mit Sensor / with sensor Füllmedium: Bremsflüssigkeit / Fill Medium: Brake Fluid Immer erneuern / Renew everytime	(92) (25) (30)
					3151 000 396	KZIS-4		

		CODE				
--	--	------	--	---	---	---

MERCEDES-BENZ





















































































ATEGO 1214 - 1229						
1216 K 967.205	04.13-	OM934		3400 700 638 	362 18	Euro 6 / Euro 6 (18)
1216, 1216 L 967.025 967.028 967.005 967.008	04.13-			6482 000 219 	PHIS-5/34	Euro 6 / Euro 6 Immer erneuern / Renew everytime (18) (30)
1216, 1216 L 967.005 967.028 967.008 967.025	04.13-					
1218 K 967.205	04.13-					
1218, 1218 L 967.008 967.025 967.005 967.028	04.13-					
1218, 1218 L 967.025 967.028 967.008 967.005	04.13-					
1221 K 967.205	04.13-					
1221, 1221 L 967.005 967.008 967.025 967.028	04.13-					
1221, 1221 L 967.008 967.025 967.028 967.005	04.13-					
1223 AF 967.635	04.13-					
1223 F 967.605	04.13-					
1223 K 967.205	04.13-					
1223, 1223 L 967.005 967.025 967.008 967.028	04.13-					
1224 K 967.205	04.13-	OM936		3400 700 639 	395 18	Euro 6 / Euro 6 (18)
1224, 1224 L 967.028 967.008 967.005 967.025	04.13-			3400 700 546 	395 18	XTend Getr. / GBox: Powershift Nabenprofil / Hub Profile: 36x40-18N Euro 6 / Euro 6 Nur zusammen verbauen / Only install together (48) (18) (53)
1224, 1224 L 967.028 967.025 967.008 967.005	04.13-					
1227 AF 967.635	04.13-			6482 000 219	PHIS-5/34	Getr. / GBox: Powershift Euro 6 / Euro 6 Immer erneuern / Renew everytime (18) (30)
1227 F 967.605	04.13-					
1227 K 967.205	04.13-					
1227, 1227 L 967.005 967.008 967.025 967.028	04.13-					
1227, 1227 L 967.008 967.025 967.005 967.028	04.13-					
1230 AF 967.635	04.13-					
1230 F 967.605	04.13-					
1230 K 967.205	04.13-					
1230, 1230 L 967.008 967.028 967.005 967.025	04.13-					
1230, 1230 L 967.005 967.028 967.008 967.025	04.13-					
1228, 1228 L 970.058 970.057 970.257/258 970.050 970.053 970.055 970.059 970.253 970.255	01.98 - 10.04 10.04 -	OM906		3400 121 301 	395 18	
1228, 1228 L, 1229, 1229 L 970.059 970.058 970.255 970.258 970.253 970.257 970.057 970.050 970.055 970.053				3482 000 463 1878 023 831	MF395 395GTZ	ohne Sensor / without sensor Füllmedium: Bremsflüssigkeit / Fill Medium: Brake Fluid (105) (25)
				3400 710 007 3482 000 463 1878 023 831 3182 998 501	MF395 395GTZ HHIS-3	
				3400 710 010 3482 000 463 1878 023 831 3182 600 101	MF395 395GTZ HHIS-3	mit Sensor / with sensor Füllmedium: Bremsflüssigkeit / Fill Medium: Brake Fluid (92) (25)
				3151 000 396	KZIS-4	

MERCEDES-BENZ

ATEGO 1315 - 1419							
1315 958.026	10.04-	OM904		3400 127 701  ⊗ 3482 000 462 ⊗ 1878 052 842	362 18 MF362 362WGTB		
1317 A 970.362/363	01.98-10.04			3400 700 484 HD  ⊗ 3482 000 462 ⊗ 1878 006 757	362 18 MF362 362WGTB		
1317 AK 972.362	01.98-10.04			3400 710 005  ⊗ 3482 000 462 ⊗ 1878 052 842 ⚡ 3182 998 501	362 18 MF362 362WGTB HHIS-3	ohne Sensor / without sensor Füllmedium: Bremsflüssigkeit / Fill Medium: Brake Fluid	(105) (25)
1317 K 972.062	01.98-10.04			3400 710 008  ⊗ 3482 000 462 ⊗ 1878 052 842 ⚡ 3182 600 101	362 18 MF362 362WGTB HHIS-3	mit Sensor / with sensor Füllmedium: Bremsflüssigkeit / Fill Medium: Brake Fluid	(92) (25)
1317 KO, 1317 LKO, 1318 KO, 1318 LKO 975.062 975.262	01.98-10.04			3400 700 397  ⊗ 3482 000 463 ⊗ 1878 004 232	395 18 MF395 395WGTZ	für / for: SA 504672/22	(69)
1317, 1317 L 970.267/268 970.063 970.068 970.065 970.067 970.265 970.060 970.263	01.98-10.04			3400 121 201  ⊗ 3482 000 464 ⊗ 1878 023 931	395 18 MF395 395GTZ		
1318 12.11-	10.04-			3400 121 301 HD  ⊗ 3482 000 463 ⊗ 1878 023 831	395 18 MF395 395GTZ	für Fahrzeuge mit Kupplungskraftverstärker / for vehicles with clutch booster	(73)
1318 A 970.363 970.362	10.04-			3400 710 006  ⊗ 3482 000 464 ⊗ 1878 023 931 ⚡ 3182 998 501	395 18 MF395 395GTZ HHIS-3	ohne Sensor / without sensor Füllmedium: Bremsflüssigkeit / Fill Medium: Brake Fluid	(105) (25)
1318 AK 972.362	10.04-			3400 710 007 HD  ⊗ 3482 000 463 ⊗ 1878 023 831 ⚡ 3182 998 501	395 18 MF395 395GTZ HHIS-3	für Fahrzeuge mit Kupplungskraftverstärker / for vehicles with clutch booster ohne Sensor / without sensor Füllmedium: Bremsflüssigkeit / Fill Medium: Brake Fluid	(73) (105) (25)
1318 K 972.062	10.04-			3400 710 009  ⊗ 3482 000 464 ⊗ 1878 023 931 ⚡ 3182 600 101	395 18 MF395 395GTZ HHIS-3	mit Sensor / with sensor Füllmedium: Bremsflüssigkeit / Fill Medium: Brake Fluid	(92) (25)
1318 LKO 975.262	10.04-		3400 710 010 HD  ⊗ 3482 000 463 ⊗ 1878 023 831 ⚡ 3182 600 101	395 18 MF395 395GTZ HHIS-3	für Fahrzeuge mit Kupplungskraftverstärker / for vehicles with clutch booster mit Sensor / with sensor Füllmedium: Bremsflüssigkeit / Fill Medium: Brake Fluid	(73) (92) (25)	
1318, 1318 L 970.265 970.060 970.063 970.267 970.067 970.263 970.268 970.065 970.068	10.04-		3400 710 015  ⊗ 3482 000 464 ⊗ 1878 023 931 ⚡ 3182 600 166	395 18 MF395 395GTZ	mit Sensor / with sensor Füllmedium: Mineralöl / Fill Medium: Mineral Oil	(92) (26)	
1322 A 970.362/363	10.04-		3400 710 014 HD  ⊗ 3482 000 463 ⊗ 1878 023 831 ⚡ 3182 600 166	395 18 MF395 395GTZ	für Fahrzeuge mit Kupplungskraftverstärker / for vehicles with clutch booster mit Sensor / with sensor Füllmedium: Mineralöl / Fill Medium: Mineral Oil	(73) (92) (26)	
1322 AF 976.364	10.04-		3400 710 016  ⊗ 3482 000 464 ⊗ 1878 023 931 ⚡ 3182 600 141	395 18 MF395 395GTZ	ohne Sensor / without sensor Füllmedium: Mineralöl / Fill Medium: Mineral Oil	(105) (26)	
1322 AK 972.362	10.04-		3400 710 017 HD  ⊗ 3482 000 463 ⊗ 1878 023 831 ⚡ 3182 600 141	395 18 MF395 395GTZ	für Fahrzeuge mit Kupplungskraftverstärker / for vehicles with clutch booster ohne Sensor / without sensor Füllmedium: Mineralöl / Fill Medium: Mineral Oil	(73) (105) (26)	
1322 F 976.063 976.065 976.064	10.04-		3182 998 501	HHIS-3	ohne Sensor / without sensor Füllmedium: Bremsflüssigkeit / Fill Medium: Brake Fluid Immer erneuern / Renew everytime	(105) (25) (30)	
1322 K 972.062	10.04-		3182 600 166		mit Sensor / with sensor Füllmedium: Mineralöl / Fill Medium: Mineral Oil Immer erneuern / Renew everytime	(92) (26) (30)	
1322 LKO 975.262	10.04-		3182 600 141		ohne Sensor / without sensor Füllmedium: Mineralöl / Fill Medium: Mineral Oil Immer erneuern / Renew everytime	(105) (26) (30)	
1322 LS 974.263 974.262	10.04-		3182 600 101	HHIS-3	mit Sensor / with sensor Füllmedium: Bremsflüssigkeit / Fill Medium: Brake Fluid Immer erneuern / Renew everytime	(92) (25) (30)	
1322, 1322 L 970.265 970.059 970.067 970.263 970.267/268 970.065 970.060 970.063 970.068	10.04-		3151 000 396	KZIS-4		(30)	
1323 A, 1324 A 970.363 970.362	10.04-	OM904, 906					
1323 AK 972.362	01.98-09.04						
1323 K 972.062	01.98-09.04						
1323 KO, 1323 LKO 975.262 975.062	01.98-10.04						
1323, 1323 L 970.068 970.267 970.065 970.263 970.067 970.268 970.063 970.265	01.98-10.04						
1323, 1323 L, 1324, 1324 L 970.265 970.263 970.067 970.267 970.065 970.268 970.063 970.068	10.04-						
1324 AK 972.362 972.372	10.04-						
1324 K 972.062	10.04-						
1324 LKO 975.262	10.04-						
1324, 1324 L 970.063 970.068 970.067 970.065	10.04-						
1325 AF 976.363/364	01.98-10.04						
1325 F 976.063 976.065 976.064	01.98-10.04						
1326 AF 976.364	10.04-						
1326 F 976.065 976.063/064	10.04-						

		CODE				
--	--	------	--	---	---	---

MERCEDES-BENZ

ATEGO 1315 - 1419								
1326 LS 974.262/263 1326, 1326 L 970.067 970.063 970.068 970.065 1326, 1326 L 970.263 970.267 970.063 970.068 970.067 970.265 970.065 970.268 1329 AF 976.364 1329, 1329 L 970.063 970.067/068 970.065 1418 958.032 958.030 958.034 958.036 1418 K 958.032 958.030 958.034 1419 958.036 958.030 958.034 958.032	10.04-	OM904		3400 127 701   3482 000 462  1878 052 842	362 18 MF362 362WGTB			
	10.04-			3400 700 484 HD   3482 000 462  1878 006 757	362 18 MF362 362WGTB			
	10.04-			3400 710 005   3482 000 462  1878 052 842  3182 998 501	362 18 MF362 362WGTB HHIS-3	ohne Sensor / without sensor Füllmedium: Bremsflüssigkeit / Fill Medium: Brake Fluid	(105) (25)	
	10.04-			3400 710 008   3482 000 462  1878 052 842  3182 600 101	362 18 MF362 362WGTB HHIS-3	mit Sensor / with sensor Füllmedium: Bremsflüssigkeit / Fill Medium: Brake Fluid	(92) (25)	
	01.11-			3400 700 397   3482 000 463  1878 004 232	395 18 MF395 395WGTZ	für / for: SA 504672/22	(69)	
	10.04-		OM906		3400 121 201   3482 000 464  1878 023 931	395 18 MF395 395GTZ		
	10.04-				3400 121 301 HD   3482 000 463  1878 023 831	395 18 MF395 395GTZ	für Fahrzeuge mit Kupplungskraftverstärker / for vehicles with clutch booster	(73)
	10.04-				3400 710 006   3482 000 464  1878 023 931  3182 998 501	395 18 MF395 395GTZ HHIS-3	ohne Sensor / without sensor Füllmedium: Bremsflüssigkeit / Fill Medium: Brake Fluid	(105) (25)
	10.04-				3400 710 007 HD   3482 000 463  1878 023 831  3182 998 501	395 18 MF395 395GTZ HHIS-3	für Fahrzeuge mit Kupplungskraftverstärker / for vehicles with clutch booster ohne Sensor / without sensor Füllmedium: Bremsflüssigkeit / Fill Medium: Brake Fluid	(73) (105) (25)
	10.04-				3400 710 009   3482 000 464  1878 023 931  3182 600 101	395 18 MF395 395GTZ HHIS-3	mit Sensor / with sensor Füllmedium: Bremsflüssigkeit / Fill Medium: Brake Fluid	(92) (25)
	10.04-			3400 710 010 HD   3482 000 463  1878 023 831  3182 600 101	395 18 MF395 395GTZ HHIS-3	für Fahrzeuge mit Kupplungskraftverstärker / for vehicles with clutch booster mit Sensor / with sensor Füllmedium: Bremsflüssigkeit / Fill Medium: Brake Fluid	(73) (92) (25)	
	10.04-			3400 710 015   3482 000 464  1878 023 931  3182 600 166	395 18 MF395 395GTZ	mit Sensor / with sensor Füllmedium: Mineralöl / Fill Medium: Mineral Oil	(92) (26)	
	10.04-			3400 710 014 HD   3482 000 463  1878 023 831  3182 600 166	395 18 MF395 395GTZ	für Fahrzeuge mit Kupplungskraftverstärker / for vehicles with clutch booster mit Sensor / with sensor Füllmedium: Mineralöl / Fill Medium: Mineral Oil	(73) (92) (26)	
	10.04-			3400 710 016   3482 000 464  1878 023 931  3182 600 141	395 18 MF395 395GTZ	ohne Sensor / without sensor Füllmedium: Mineralöl / Fill Medium: Mineral Oil	(105) (26)	
	10.04-			3400 710 017 HD   3482 000 463  1878 023 831  3182 600 141	395 18 MF395 395GTZ	für Fahrzeuge mit Kupplungskraftverstärker / for vehicles with clutch booster ohne Sensor / without sensor Füllmedium: Mineralöl / Fill Medium: Mineral Oil	(73) (105) (26)	
	10.04-	OM904, 906		3182 998 501   3182 600 166	HHIS-3	ohne Sensor / without sensor Füllmedium: Bremsflüssigkeit / Fill Medium: Brake Fluid Immer erneuern / Renew everytime	(105) (25) (30)	
	10.04-			3182 600 141   3182 600 101	HHIS-3	ohne Sensor / without sensor Füllmedium: Mineralöl / Fill Medium: Mineral Oil Immer erneuern / Renew everytime	(105) (26) (30)	
	10.04-			3182 600 166   3182 600 101	HHIS-3	mit Sensor / with sensor Füllmedium: Mineralöl / Fill Medium: Mineral Oil Immer erneuern / Renew everytime	(92) (26) (30)	
	10.04-			3182 600 101   3182 600 101	HHIS-3	mit Sensor / with sensor Füllmedium: Bremsflüssigkeit / Fill Medium: Brake Fluid Immer erneuern / Renew everytime	(92) (25) (30)	
	10.04-			3151 000 396   3151 000 396	KZIS-4		(30)	



CODE



SACHS

Parameter

i

































































MERCEDES-BENZ

ATEGO 1315 - 1419

1318 A 967.036	04.13-	OM934		3400 700 638	362 18	Euro 6 / Euro 6	(18)
1318 AK 967.236	04.13-			6482 000 219	PHIS-5/34	Euro 6 / Euro 6 Immer erneuern / Renew everytime	(18) (30)
1318 K 967.206	04.13-						
1318 LKO 967.526	04.13-						
1318, 1318 L 967.006 967.026	04.13-						
1321 A 967.036	04.13-						
1321 AK 967.236	04.13-						
1321 K 967.206	04.13-						
1321 LKO 967.526	04.13-						
1321 LS 967.426	04.13-						
1321, 1321 L 967.006 967.026	04.13-						
1323 A 967.036	04.13-						
1323 AF 967.636	04.13-						
1323 AK 967.236	04.13-						
1323 F 967.606	04.13-						
1323 K 967.206	04.13-						
1323 LKO 967.526	04.13-						
1323 LS 967.426	04.13-						
1323, 1323 L 967.026 967.006	04.13-						

































		CODE				
--	--	------	--	---	---	---

MERCEDES-BENZ

ATEGO 1315 - 1419							
1323 LS 974.262/263 1323 LS, 1324 LS 974.263 974.262	01.98 - 10.04	OM904	 3400 127 701   3482 000 462  1878 052 842	362 18 MF362 362WGTB			
	10.04 -		 3400 700 484 HD   3482 000 462  1878 006 757	362 18 MF362 362WGTB			
			 3400 710 005  3482 000 462  1878 052 842  3182 998 501	362 18 MF362 362WGTB HHIS-3	ohne Sensor / without sensor Füllmedium: Bremsflüssigkeit / Fill Medium: Brake Fluid	(105) (25)	
			 3400 710 008  3482 000 462  1878 052 842  3182 600 101	362 18 MF362 362WGTB HHIS-3	mit Sensor / with sensor Füllmedium: Bremsflüssigkeit / Fill Medium: Brake Fluid	(92) (25)	
			 3400 700 397  3482 000 463  1878 004 232	395 18 MF395 395WGTZ	für / for: SA 504672/22	(69)	
		OM906	 3400 121 201   3482 000 464  1878 023 931	395 18 MF395 395GTZ			
			 3400 121 301 HD   3482 000 463  1878 023 831	395 18 MF395 395GTZ	für Fahrzeuge mit Kupplungskraftverstärker / for vehicles with clutch booster	(73)	
			 3400 710 006  3482 000 464  1878 023 931  3182 998 501	395 18 MF395 395GTZ HHIS-3	ohne Sensor / without sensor Füllmedium: Bremsflüssigkeit / Fill Medium: Brake Fluid	(105) (25)	
			 3400 710 007 HD  3482 000 463  1878 023 831  3182 998 501	395 18 MF395 395GTZ HHIS-3	für Fahrzeuge mit Kupplungskraftverstärker / for vehicles with clutch booster ohne Sensor / without sensor Füllmedium: Bremsflüssigkeit / Fill Medium: Brake Fluid	(73) (105) (25)	
			 3400 710 009  3482 000 464  1878 023 931  3182 600 101	395 18 MF395 395GTZ HHIS-3	mit Sensor / with sensor Füllmedium: Bremsflüssigkeit / Fill Medium: Brake Fluid	(92) (25)	
			 3400 710 010 HD  3482 000 463  1878 023 831  3182 600 101	395 18 MF395 395GTZ HHIS-3	für Fahrzeuge mit Kupplungskraftverstärker / for vehicles with clutch booster mit Sensor / with sensor Füllmedium: Bremsflüssigkeit / Fill Medium: Brake Fluid	(73) (92) (25)	
			 3400 710 015  3482 000 464  1878 023 931  3182 600 166	395 18 MF395 395GTZ	mit Sensor / with sensor Füllmedium: Mineralöl / Fill Medium: Mineral Oil	(92) (26)	
			 3400 710 014 HD  3482 000 463  1878 023 831  3182 600 166	395 18 MF395 395GTZ	für Fahrzeuge mit Kupplungskraftverstärker / for vehicles with clutch booster mit Sensor / with sensor Füllmedium: Mineralöl / Fill Medium: Mineral Oil	(73) (92) (26)	
			 3400 710 016  3482 000 464  1878 023 931  3182 600 141	395 18 MF395 395GTZ	ohne Sensor / without sensor Füllmedium: Mineralöl / Fill Medium: Mineral Oil	(105) (26)	
			 3400 710 017 HD  3482 000 463  1878 023 831  3182 600 141	395 18 MF395 395GTZ	für Fahrzeuge mit Kupplungskraftverstärker / for vehicles with clutch booster ohne Sensor / without sensor Füllmedium: Mineralöl / Fill Medium: Mineral Oil	(73) (105) (26)	
			OM904, 906	 3182 998 501	HHIS-3	ohne Sensor / without sensor Füllmedium: Bremsflüssigkeit / Fill Medium: Brake Fluid Immer erneuern / Renew everytime	(105) (25) (30)
				3182 600 166		mit Sensor / with sensor Füllmedium: Mineralöl / Fill Medium: Mineral Oil Immer erneuern / Renew everytime	(92) (26) (30)
				3182 600 141		ohne Sensor / without sensor Füllmedium: Mineralöl / Fill Medium: Mineral Oil Immer erneuern / Renew everytime	(105) (26) (30)
		3182 600 101		HHIS-3	mit Sensor / with sensor Füllmedium: Bremsflüssigkeit / Fill Medium: Brake Fluid Immer erneuern / Renew everytime	(92) (25) (30)	
			 3151 000 396	KZIS-4			
		OM906.915, OM902.916, OM906.910	 1863 869 040		nur als Ersatz für angegebene OE-Nr. / only for the listed OE-Numbers	(100)	









		CODE				
--	--	------	--	---	---	---

MERCEDES-BENZ

ATEGO 1315 - 1419						
1324 A 967.036	04.13-	OM936		3400 700 639 	395 18	Euro 6 / Euro 6 (18)
1324 AK 967.236	04.13-			3400 700 546 	395 18	XTend Getr. / GBox: Powershift Nabenprofil / Hub Profile: 36x40-18N Euro 6 / Euro 6 Nur zusammen verbauen / Only install together (48) (18) (53)
1324 K 967.206	04.13-			6482 000 219	PHIS-5/34	Getr. / GBox: Powershift Euro 6 / Euro 6 Immer erneuern / Renew everytime (18) (30)
1324 LKO 967.526	04.13-					
1324 LS 967.426	04.13-					
1324, 1324 L 967.006 967.026	04.13-					
1327 AF 967.636	04.13-					
1327 AK 967.236	04.13-					
1327 F 967.606	04.13-					
1327 K 967.206	04.13-					
1327 LS 967.426	04.13-					
1327, 1327 L 967.006 967.026	04.13-					
1330 AF 967.636	04.13-					
1330 AK 967.236	04.13-					
1330 F 967.606	04.13-					
1330 K 967.206	04.13-					
1330 LS 967.426	04.13-					
1330, 1330 L 967.026 967.006	04.13-					
1328 AF 976.364 976.363	01.98-10.04	OM906		3400 121 301 	395 18 MF395 395GTZ	
1328 F 976.065 976.063/064	01.98-10.04			3400 710 007   	395 18 MF395 395GTZ HHIS-3	ohne Sensor / without sensor Füllmedium: Bremsflüssigkeit / Fill Medium: Brake Fluid (105) (25)
1328, 1328 L 970.267 970.063 970.263 970.268 970.067/068 970.065 970.265	01.98-10.04			3400 710 010   	395 18 MF395 395GTZ HHIS-3	mit Sensor / with sensor Füllmedium: Bremsflüssigkeit / Fill Medium: Brake Fluid (92) (25)
1328, 1328 L, 1329, 1329 L 970.265 970.065 970.263 970.268 970.067 970.063 970.068 970.267	10.04-			3182 998 501 		
1329 F 976.063 976.065 976.064	10.04-			3151 000 396	KZIS-4	
1328 LS 974.263 974.262	01.98-10.04	OM906		3400 121 301 	395 18 MF395 395GTZ	
1328 LS, 1329 LS 974.262/263	10.04-			3400 710 007   	395 18 MF395 395GTZ HHIS-3	ohne Sensor / without sensor Füllmedium: Bremsflüssigkeit / Fill Medium: Brake Fluid (105) (25)
				3400 710 010   	395 18 MF395 395GTZ HHIS-3	mit Sensor / with sensor Füllmedium: Bremsflüssigkeit / Fill Medium: Brake Fluid (92) (25)
				3182 998 501 		
				3151 000 396	KZIS-4	
		OM906.911, OM902.918, OM906.916		1863 869 040		nur als Ersatz für angegebene OE-Nr. / only for the listed OE-Numbers (100)





























































		CODE				
--	--	------	--	---	---	---

MERCEDES-BENZ

ATEGO 1517 - 1729							
1517 A 970.373	01.98-10.04	OM904		3400 127 701 3482 000 462 1878 052 842	362 18 MF362 362WGTB		
1517 AK 972.372	01.98-10.04			3400 700 484 HD	362 18		
1517 K 972.072	01.98-10.04			3482 000 462 1878 006 757	MF362 362WGTB		
1517, 1517 L 375.121/122 970.078 970.273 970.077 970.073 970.075 970.275 970.278 970.277	01.98-10.04			3400 710 005 3482 000 462 1878 052 842 3182 998 501	362 18 MF362 362WGTB HHIS-3	ohne Sensor / without sensor Füllmedium: Bremsflüssigkeit / Fill Medium: Brake Fluid	(105) (25)
1518 A 970.373	10.04-			3400 710 008 3482 000 462 1878 052 842 3182 600 101	362 18 MF362 362WGTB HHIS-3	mit Sensor / with sensor Füllmedium: Bremsflüssigkeit / Fill Medium: Brake Fluid	(92) (25)
1518 AK 972.372	10.04-			3400 700 397 3482 000 463 1878 004 232	395 18 MF395 395WGTZ	für / for: SA 504672/22	(69)
1518 K 972.072	10.04-			3400 121 201 3482 000 464 1878 023 931	395 18 MF395 395GTZ		
1518, 1518 L 970.273 970.277 970.078 958.054 970.075 958.052 958.056 970.073 970.077 970.275 958.050 970.278	10.04-			3400 121 301 HD	395 18 MF395 395GTZ	für Fahrzeuge mit Kupplungskraftverstärker / for vehicles with clutch booster	(73)
1522 A 970.372/373	10.04-			3400 710 006 3482 000 464 1878 023 931 3182 998 501	395 18 MF395 395GTZ HHIS-3	ohne Sensor / without sensor Füllmedium: Bremsflüssigkeit / Fill Medium: Brake Fluid	(105) (25)
1522 AF 976.373/374	10.04-			3400 710 007 HD 3482 000 463 1878 023 831 3182 998 501	395 18 MF395 395GTZ HHIS-3	für Fahrzeuge mit Kupplungskraftverstärker / for vehicles with clutch booster ohne Sensor / without sensor Füllmedium: Bremsflüssigkeit / Fill Medium: Brake Fluid	(73) (105) (25)
1522 AK 972.372	10.04-		3400 710 009 3482 000 464 1878 023 931 3182 600 101	395 18 MF395 395GTZ HHIS-3	mit Sensor / with sensor Füllmedium: Bremsflüssigkeit / Fill Medium: Brake Fluid	(92) (25)	
1522 F 976.075 976.077	10.04-		3400 710 010 HD 3482 000 463 1878 023 831 3182 600 101	395 18 MF395 395GTZ HHIS-3	für Fahrzeuge mit Kupplungskraftverstärker / for vehicles with clutch booster mit Sensor / with sensor Füllmedium: Bremsflüssigkeit / Fill Medium: Brake Fluid	(73) (92) (25)	
1522 K 972.072	10.04-		3400 710 015 3482 000 464 1878 023 931 3182 600 166	395 18 MF395 395GTZ	mit Sensor / with sensor Füllmedium: Mineralöl / Fill Medium: Mineral Oil	(92) (26)	
1522, 1522 L 970.073 970.277 970.075 970.077/078 970.275 970.273 970.278	10.04-		3400 710 014 HD 3482 000 463 1878 023 831 3182 600 166	395 18 MF395 395GTZ	für Fahrzeuge mit Kupplungskraftverstärker / for vehicles with clutch booster mit Sensor / with sensor Füllmedium: Mineralöl / Fill Medium: Mineral Oil	(73) (92) (26)	
1523 A 970.373	01.98-10.04		3400 710 016 3482 000 464 1878 023 931 3182 600 141	395 18 MF395 395GTZ	ohne Sensor / without sensor Füllmedium: Mineralöl / Fill Medium: Mineral Oil	(105) (26)	
1523 A, 1524 A 970.372/373	10.04-		3400 710 017 HD 3482 000 463 1878 023 831 3182 600 141	395 18 MF395 395GTZ	für Fahrzeuge mit Kupplungskraftverstärker / for vehicles with clutch booster ohne Sensor / without sensor Füllmedium: Mineralöl / Fill Medium: Mineral Oil	(73) (105) (26)	
1523 AK 972.372	01.98-10.04		3182 998 501	HHIS-3	ohne Sensor / without sensor Füllmedium: Bremsflüssigkeit / Fill Medium: Brake Fluid	(105) (25)	
1523 K 972.072	10.04-		3182 600 166		Immer erneuern / Renew everytime mit Sensor / with sensor Füllmedium: Mineralöl / Fill Medium: Mineral Oil	(30) (92) (26)	
1523 K, 1524 K 972.072	10.04-		3182 600 141		Immer erneuern / Renew everytime ohne Sensor / without sensor Füllmedium: Mineralöl / Fill Medium: Mineral Oil	(30) (105) (26)	
1523 KO 975.072	01.98-10.04		3182 600 101	HHIS-3	mit Sensor / with sensor Füllmedium: Bremsflüssigkeit / Fill Medium: Brake Fluid	(92) (25)	
1523, 1523 L 970.077 970.277 970.275 970.078 970.273 970.075 970.073 970.278	01.98-10.04		3151 000 396	KZIS-4	Immer erneuern / Renew everytime	(30)	
1523, 1523 L, 1524, 1524 L 970.073 970.075 970.078 970.275 970.277 970.077 970.273 970.278	10.04-						
1524 AK 972.362 972.372	10.04-						
1524, 1524 L 970.077/078 970.075 970.073	10.04-						
1525 AF 976.373/374	01.98-10.04						
1526 AF 976.374 976.373	10.04-						
1526 AK 972.372	10.04-						
1526 K 972.072	10.04-						
1526, 1526 L 970.275 970.078 970.273 970.278 970.073 970.075 970.077 970.277	10.04-						
1526, 1526 L 970.073 970.075 970.077/078	10.04-						
1528 AK 972.372	01.98-09.04						
1528 K 972.072	01.98-09.04						
1529 AF 976.373/374	10.04-						















		CODE				
--	--	------	--	---	---	---

MERCEDES-BENZ

ATEGO 1517 - 1729								
1529 F 976.077 976.075 1529, 1529 L 970.075 970.077 970.073 970.078 1618 1618 K 1622 1622 K 1624 1624 K 1629 1718 958.074 958.076 958.070 958.072 1718 K 958.072 958.070 958.076 958.074 1719 958.074 958.070 958.076 958.072 1722 958.072 958.076 958.070 958.074 1725 958.070 958.072 958.074 958.076 1725 A 958.078 1725 K 958.074 958.070 958.072 1725 S 958.077 1728 1728 S 958.077	10.04-	OM904		3400 127 701   3482 000 462  1878 052 842	362 18 MF362 362WGTB			
	10.04-			3400 700 484 HD   3482 000 462  1878 006 757	362 18 MF362 362WGTB			
	10.04-			3400 710 005  3482 000 462  1878 052 842  3182 998 501	362 18 MF362 362WGTB HHIS-3	ohne Sensor / without sensor Füllmedium: Bremsflüssigkeit / Fill Medium: Brake Fluid	(105) (25)	
	10.04-			3400 710 008  3482 000 462  1878 052 842  3182 600 101	362 18 MF362 362WGTB HHIS-3	mit Sensor / with sensor Füllmedium: Bremsflüssigkeit / Fill Medium: Brake Fluid	(92) (25)	
	10.04-			3400 700 397  3482 000 463  1878 004 232	395 18 MF395 395WGTZ	für / for: SA 504672/22	(69)	
	10.04-		OM906		3400 121 201   3482 000 464  1878 023 931	395 18 MF395 395GTZ		
	10.04-			3400 121 301 HD   3482 000 463  1878 023 831	395 18 MF395 395GTZ	für Fahrzeuge mit Kupplungskraftverstärker / for vehicles with clutch booster	(73)	
	10.06-			3400 710 006  3482 000 464  1878 023 931  3182 998 501	395 18 MF395 395GTZ HHIS-3	ohne Sensor / without sensor Füllmedium: Bremsflüssigkeit / Fill Medium: Brake Fluid	(105) (25)	
	01.11-			3400 710 007 HD  3482 000 463  1878 023 831  3182 998 501	395 18 MF395 395GTZ HHIS-3	für Fahrzeuge mit Kupplungskraftverstärker / for vehicles with clutch booster ohne Sensor / without sensor Füllmedium: Bremsflüssigkeit / Fill Medium: Brake Fluid	(73) (105) (25)	
	01.07-			3400 710 009  3482 000 464  1878 023 931  3182 600 101	395 18 MF395 395GTZ HHIS-3	mit Sensor / with sensor Füllmedium: Bremsflüssigkeit / Fill Medium: Brake Fluid	(92) (25)	
	06.07-			3400 710 010 HD  3482 000 463  1878 023 831  3182 600 101	395 18 MF395 395GTZ HHIS-3	für Fahrzeuge mit Kupplungskraftverstärker / for vehicles with clutch booster mit Sensor / with sensor Füllmedium: Bremsflüssigkeit / Fill Medium: Brake Fluid	(73) (92) (25)	
	01.07-			3400 710 015  3482 000 464  1878 023 931  3182 600 166	395 18 MF395 395GTZ	mit Sensor / with sensor Füllmedium: Mineralöl / Fill Medium: Mineral Oil	(92) (26)	
				3400 710 014 HD  3482 000 463  1878 023 831  3182 600 166	395 18 MF395 395GTZ	für Fahrzeuge mit Kupplungskraftverstärker / for vehicles with clutch booster mit Sensor / with sensor Füllmedium: Mineralöl / Fill Medium: Mineral Oil	(73) (92) (26)	
				3400 710 016  3482 000 464  1878 023 931  3182 600 141	395 18 MF395 395GTZ	ohne Sensor / without sensor Füllmedium: Mineralöl / Fill Medium: Mineral Oil	(105) (26)	
				3400 710 017 HD  3482 000 463  1878 023 831  3182 600 141	395 18 MF395 395GTZ	für Fahrzeuge mit Kupplungskraftverstärker / for vehicles with clutch booster ohne Sensor / without sensor Füllmedium: Mineralöl / Fill Medium: Mineral Oil	(73) (105) (26)	
		OM904, 906			3182 998 501	HHIS-3	ohne Sensor / without sensor Füllmedium: Bremsflüssigkeit / Fill Medium: Brake Fluid Immer erneuern / Renew everytime	(105) (25) (30)
				3182 600 166			mit Sensor / with sensor Füllmedium: Mineralöl / Fill Medium: Mineral Oil Immer erneuern / Renew everytime	(92) (26) (30)
				3182 600 141			ohne Sensor / without sensor Füllmedium: Mineralöl / Fill Medium: Mineral Oil Immer erneuern / Renew everytime	(105) (26) (30)
				3182 600 101			mit Sensor / with sensor Füllmedium: Bremsflüssigkeit / Fill Medium: Brake Fluid Immer erneuern / Renew everytime	(92) (25) (30)
				3151 000 396		KZIS-4		











		CODE				
--	--	------	--	---	---	---













MERCEDES-BENZ

ATEGO 1517 - 1729						
1518 A 967.037	04.13-	OM934		3400 700 638 	362 18	Euro 6 / Euro 6 (18)
1518 K 967.207	04.13-			6482 000 219 	PHIS-5/34	Euro 6 / Euro 6 Immer erneuern / Renew everytime (18) (30)
1518, 1518 L 967.007 967.027	04.13-					
1521 A 967.037	04.13-					
1521 AK 967.237	04.13-					
1521 K 967.207	04.13-					
1521, 1521 L 967.007 967.027	04.13-					
1523 A 967.037	04.13-					
1523 AK 967.237	04.13-					
1523 K 967.207	04.13-					
1523, 1523 L 967.007 967.027	04.13-					
1524 A 967.037	04.13-	OM936		3400 700 639 	395 18	Euro 6 / Euro 6 (18)
1524 AK 967.237	04.13-			3400 700 546 	395 18	XTend Getr. / GBox: Powershift Nabenprofil / Hub Profile: 36x40-18N Euro 6 / Euro 6 (48) (18) Nur zusammen verbauen / Only install together (53)
1524 K 967.207	04.13-					
1524, 1524 L 967.027 967.007	04.13-			6482 000 219	PHIS-5/34	Getr. / GBox: Powershift Euro 6 / Euro 6 (18) Immer erneuern / Renew everytime (30)
1527 AF 967.637	04.13-					
1527 AK 967.237	04.13-					
1527 F 967.607	04.13-					
1527 K 967.207	04.13-					
1527, 1527 L 967.007 967.027	04.13-					
1530 AF 967.637	04.13-					
1530 AK 967.237	04.13-					
1530 F 967.607	04.13-					
1530 K 967.207	04.13-					
1530, 1530 L 967.007 967.027	04.13-					
1528 AF 976.373/374	01.98 - 10.04	OM906		3400 121 301 	395 18	
1528 F 976.075 976.077	01.98 - 10.04			3482 000 463 1878 023 831	MF395 395GTZ	
1528, 1528 L 970.077 970.275 970.078 970.273 970.073 970.277 970.075 970.278	01.98 - 10.04			3400 710 007 3482 000 463 1878 023 831 3182 998 501	395 18 MF395 395GTZ HHIS-3	ohne Sensor / without sensor (105) Füllmedium: Bremsflüssigkeit / Fill Medium: Brake Fluid (25)
1528, 1528 L, 1529, 1529 L 970.075 970.278 970.078 970.077 970.073 970.273 970.277 970.275	10.04 -			3400 710 010 3482 000 463 1878 023 831 3182 600 101	395 18 MF395 395GTZ HHIS-3	mit Sensor / with sensor (92) Füllmedium: Bremsflüssigkeit / Fill Medium: Brake Fluid (25)
1529 AK 972.372	10.04 -			3151 000 396	KZIS-4	
1529 K 972.072	10.04 -					

		CODE				
--	--	------	--	---	---	---









































MERCEDES-BENZ

ATEGO 1517 - 1729							
1728 1728 S 958.077	01.07-	OM906LA		3400 121 301 ◐ ⊗ 3482 000 463 ⊗ 1878 023 831	395 18 MF395 395GTZ		
	01.07-			3400 710 007 ⊗ 3482 000 463 ⊗ 1878 023 831 ⚡ 3182 998 501	395 18 MF395 395GTZ HHIS-3	ohne Sensor / without sensor Füllmedium: Bremsflüssigkeit / Fill Medium: Brake Fluid	(105) (25)
				3400 710 010 ⊗ 3482 000 463 ⊗ 1878 023 831 ⚡ 3182 600 101	395 18 MF395 395GTZ HHIS-3	mit Sensor / with sensor Füllmedium: Bremsflüssigkeit / Fill Medium: Brake Fluid	(92) (25)
				3400 700 414 ⊕ ⊗ 3483 030 031 ⊗ 1878 002 732	430 18 MFZ430 430WGTZ	für / for: SA504682-09	(69)
				3483 030 031 ⊕	430 MFZ430	für / for: SA504682-09	(69)
				1878 002 731	430 18 430GTZ	für / for: SA504682-09	(69)
				3400 700 617 ⊕ ⊗ 3483 000 258 ⊗ 1878 002 731	430 18 MFZ430 430GTZ	für / for: SA504657-30	(69)
				3483 000 139 ⊕	430 GMFZ430N	für / for: SA504682-10 für Nebenantrieb / for PTO nicht in Verbindung mit Austausch-Kupplungsscheibe / not in connection with replacement clutch disc	(69) (82) (99)
				1878 002 732	430 18 430WGTZ	für / for: SA504682-10 für Nebenantrieb / for PTO	(69) (82)
				OM906		3151 000 396	KZIS-4

ATEGO 1823 - 1929									
1823 AK 952.563 952.562 1823 K 952.502/503 1823 LS 954.532 1823, 1823 L 950.502 950.506-508 950.546 950.501 950.532 950.535 950.538/539 950.537 950.544 950.531 950.533 950.504 950.503 950.509 950.536 950.505 950.534 950.547	04.98-10.04	OM906LA		3400 121 201 ◐ ⊗ 3482 000 464 ⊗ 1878 023 931	395 18 MF395 395GTZ				
	04.98-10.04			3400 121 301 HD ◐ ⊗ 3482 000 463 ⊗ 1878 023 831	395 18 MF395 395GTZ	für Fahrzeuge mit Kupplungskraftverstärker / for vehicles with clutch booster	(73)		
	04.98-10.04			3400 710 006 ⊗ 3482 000 464 ⊗ 1878 023 931 ⚡ 3182 998 501	395 18 MF395 395GTZ HHIS-3	ohne Sensor / without sensor Füllmedium: Bremsflüssigkeit / Fill Medium: Brake Fluid	(105) (25)		
	01.98-10.04			3400 710 007 HD ⊗ 3482 000 463 ⊗ 1878 023 831 ⚡ 3182 998 501	395 18 MF395 395GTZ HHIS-3	für Fahrzeuge mit Kupplungskraftverstärker / for vehicles with clutch booster ohne Sensor / without sensor Füllmedium: Bremsflüssigkeit / Fill Medium: Brake Fluid	(73) (105) (25)		
				3400 710 009 ⊗ 3482 000 464 ⊗ 1878 023 931 ⚡ 3182 600 101	395 18 MF395 395GTZ HHIS-3	mit Sensor / with sensor Füllmedium: Bremsflüssigkeit / Fill Medium: Brake Fluid	(92) (25)		
				3400 710 010 HD ⊗ 3482 000 463 ⊗ 1878 023 831 ⚡ 3182 600 101	395 18 MF395 395GTZ HHIS-3	für Fahrzeuge mit Kupplungskraftverstärker / for vehicles with clutch booster mit Sensor / with sensor Füllmedium: Bremsflüssigkeit / Fill Medium: Brake Fluid	(73) (92) (25)		
				3400 700 414 ⊕ ⊗ 3483 030 031 ⊗ 1878 002 732	430 18 MFZ430 430WGTZ	für / for: SA504682-09	(69)		
				3483 030 031 ⊕	430 MFZ430	für / for: SA504682-09	(69)		
				1878 002 731	430 18 430GTZ	für / for: SA504682-09	(69)		
				3400 700 617 ⊕ ⊗ 3483 000 258 ⊗ 1878 002 731	430 18 MFZ430 430GTZ	für / for: SA504657-30	(69)		
				3483 000 139 ⊕	430 GMFZ430N	für / for: SA504682-10 für Nebenantrieb / for PTO nicht in Verbindung mit Austausch-Kupplungsscheibe / not in connection with replacement clutch disc	(69) (82) (99)		
				1878 002 732	430 18 430WGTZ	für / for: SA504682-10 für Nebenantrieb / for PTO	(69) (82)		
				OM906		3151 000 396	KZIS-4	für OE-Nummer / for OE number 001 250 99 15 für OE-Nummer / for OE number 002 250 00 15	(83) (83)









































































		CODE				
--	--	------	--	---	---	---

MERCEDES-BENZ

ATEGO 1823 - 1929									
1828 A 950.562/563 1828 AK 952.562/563 1828 K 952.502/503 1828 LS 954.532	04.98 - 10.04	OM906LA		3400 121 301 ☹  3482 000 463  1878 023 831	395 18 MF395 395GTZ				
	04.98 - 10.04			3400 710 007  3482 000 463  1878 023 831  3182 998 501	395 18 MF395 395GTZ HHIS-3	ohne Sensor / without sensor Füllmedium: Bremsflüssigkeit / Fill Medium: Brake Fluid	(105) (25)		
	04.98 - 10.04			3400 710 010  3482 000 463  1878 023 831  3182 600 101	395 18 MF395 395GTZ HHIS-3	mit Sensor / with sensor Füllmedium: Bremsflüssigkeit / Fill Medium: Brake Fluid	(92) (25)		
	04.98 - 10.04			3400 700 414 ⊕  3483 030 031  1878 002 732	430 18 MFZ430 430WGTZ	für / for: SA504682-09	(69)		
				3483 030 031 ⊕ MFZ430	430	für / for: SA504682-09	(69)		
				1878 002 731	430 18 430GTZ	für / for: SA504682-09	(69)		
				3400 700 617 ⊕  3483 000 258  1878 002 731	430 18 MFZ430 430GTZ	für / for: SA504657-30	(69)		
				3483 000 139 ⊕ GMFZ430N	430	für / for: SA504682-10 für Nebenantrieb / for PTO nicht in Verbindung mit Austausch-Kupplungsscheibe / not in connection with replacement clutch disc	(69) (82) (99)		
				1878 002 732	430 18 430WGTZ	für / for: SA504682-10 für Nebenantrieb / for PTO	(69) (82)		
				OM906		3151 000 396	KZIS-4	für OE-Nummer / for OE number 001 250 99 15 für OE-Nummer / for OE number 002 250 00 15	(83) (83)
1828, 1828 L 950.503 950.538 950.544 950.501 950.507 950.536 950.546 950.531 950.547 950.535 950.506 950.508 950.505 950.534 950.504 950.532/533 950.537 950.502 1923 L 970.667 970.665 970.663 1928 L 970.663 970.665 970.667	04.98 - 10.04	OM906LA		3400 121 301 ☹  3482 000 463  1878 023 831	395 18 MF395 395GTZ				
	04.98 - 10.04			3400 710 007  3482 000 463  1878 023 831  3182 998 501	395 18 MF395 395GTZ HHIS-3	ohne Sensor / without sensor Füllmedium: Bremsflüssigkeit / Fill Medium: Brake Fluid	(105) (25)		
	04.98 - 10.04			3400 710 010  3482 000 463  1878 023 831  3182 600 101	395 18 MF395 395GTZ HHIS-3	mit Sensor / with sensor Füllmedium: Bremsflüssigkeit / Fill Medium: Brake Fluid	(92) (25)		
				3483 030 031 ⊕ MFZ430	430	für / for: SA504682-09	(69)		
				1878 002 731	430 18 430GTZ	für / for: SA504682-09	(69)		
				3400 700 617 ⊕  3483 000 258  1878 002 731	430 18 MFZ430 430GTZ	für / for: SA504657-30	(69)		
				3483 000 139 ⊕ GMFZ430N	430	für / for: SA504682-10 für Nebenantrieb / for PTO nicht in Verbindung mit Austausch-Kupplungsscheibe / not in connection with replacement clutch disc	(69) (82) (99)		
				1878 002 732	430 18 430WGTZ	für / for: SA504682-10 für Nebenantrieb / for PTO	(69) (82)		
				OM906		3151 000 396	KZIS-4	für OE-Nummer / for OE number 001 250 99 15 für OE-Nummer / for OE number 002 250 00 15	(83) (83)











		CODE				
--	--	------	--	---	---	---

MERCEDES-BENZ

ATEGO 1823 - 1929									
1924 L 970.665 970.667 970.663 1924 L 970.667 970.665 970.663 1926 L 970.665 970.663 970.667 1929 L 970.663 970.665 970.667 1929 L 970.667 970.665 970.663	10.04-	OM904		3400 127 701   3482 000 462  1878 052 842	362 18 MF362 362WGTB				
	10.04-			3400 700 484 HD   3482 000 462  1878 006 757	362 18 MF362 362WGTB				
	10.04-			3400 710 005   3482 000 462  1878 052 842  3182 998 501	362 18 MF362 362WGTB HHIS-3	ohne Sensor / without sensor Füllmedium: Bremsflüssigkeit / Fill Medium: Brake Fluid	(105) (25)		
	10.04-			3400 710 008   3482 000 462  1878 052 842  3182 600 101	362 18 MF362 362WGTB HHIS-3	mit Sensor / with sensor Füllmedium: Bremsflüssigkeit / Fill Medium: Brake Fluid	(92) (25)		
	10.04-			3400 700 397   3482 000 463  1878 004 232	395 18 MF395 395WGTZ	für / for: SA 504672/22	(69)		
				OM906		3400 121 201   3482 000 464  1878 023 931	395 18 MF395 395GTZ		
						3400 121 301 HD   3482 000 463  1878 023 831	395 18 MF395 395GTZ	für Fahrzeuge mit Kupplungskraftverstärker / for vehicles with clutch booster	(73)
					3400 710 006   3482 000 464  1878 023 931  3182 998 501	395 18 MF395 395GTZ HHIS-3	ohne Sensor / without sensor Füllmedium: Bremsflüssigkeit / Fill Medium: Brake Fluid	(105) (25)	
					3400 710 007 HD   3482 000 463  1878 023 831  3182 998 501	395 18 MF395 395GTZ HHIS-3	für Fahrzeuge mit Kupplungskraftverstärker / for vehicles with clutch booster ohne Sensor / without sensor Füllmedium: Bremsflüssigkeit / Fill Medium: Brake Fluid	(73) (105) (25)	
					3400 710 009   3482 000 464  1878 023 931  3182 600 101	395 18 MF395 395GTZ HHIS-3	mit Sensor / with sensor Füllmedium: Bremsflüssigkeit / Fill Medium: Brake Fluid	(92) (25)	
					3400 710 010 HD   3482 000 463  1878 023 831  3182 600 101	395 18 MF395 395GTZ HHIS-3	für Fahrzeuge mit Kupplungskraftverstärker / for vehicles with clutch booster mit Sensor / with sensor Füllmedium: Bremsflüssigkeit / Fill Medium: Brake Fluid	(73) (92) (25)	
					3400 710 015   3482 000 464  1878 023 931  3182 600 166	395 18 MF395 395GTZ	mit Sensor / with sensor Füllmedium: Mineralöl / Fill Medium: Mineral Oil	(92) (26)	
					3400 710 014 HD   3482 000 463  1878 023 831  3182 600 166	395 18 MF395 395GTZ	für Fahrzeuge mit Kupplungskraftverstärker / for vehicles with clutch booster mit Sensor / with sensor Füllmedium: Mineralöl / Fill Medium: Mineral Oil	(73) (92) (26)	
					3400 710 016   3482 000 464  1878 023 931  3182 600 141	395 18 MF395 395GTZ	ohne Sensor / without sensor Füllmedium: Mineralöl / Fill Medium: Mineral Oil	(105) (26)	
					3400 710 017 HD   3482 000 463  1878 023 831  3182 600 141	395 18 MF395 395GTZ	für Fahrzeuge mit Kupplungskraftverstärker / for vehicles with clutch booster ohne Sensor / without sensor Füllmedium: Mineralöl / Fill Medium: Mineral Oil	(73) (105) (26)	
			OM904, 906			3182 998 501	HHIS-3	ohne Sensor / without sensor Füllmedium: Bremsflüssigkeit / Fill Medium: Brake Fluid Immer erneuern / Renew everytime	(105) (25) (30)
					3182 600 166		mit Sensor / with sensor Füllmedium: Mineralöl / Fill Medium: Mineral Oil Immer erneuern / Renew everytime	(92) (26) (30)	
					3182 600 141		ohne Sensor / without sensor Füllmedium: Mineralöl / Fill Medium: Mineral Oil Immer erneuern / Renew everytime	(105) (26) (30)	
				3182 600 101	HHIS-3	mit Sensor / with sensor Füllmedium: Bremsflüssigkeit / Fill Medium: Brake Fluid Immer erneuern / Renew everytime	(92) (25) (30)		
				3151 000 396		KZIS-4			

















































































		CODE				
--	--	------	--	---	---	---

MERCEDES-BENZ

ATEGO 2223 - 2530							
2223 L 970.675 970.677 970.673	04.98 - 10.04	OM906LA		3400 121 301 ◉ ⊗ 3482 000 463 ⊗ 1878 023 831	395 18 MF395 395GTZ		
2228 L 970.675 970.677 970.673	04.98 - 10.04			3400 710 007 ⊗ 3482 000 463 ⊗ 1878 023 831 ⚡ 3182 998 501	395 18 MF395 395GTZ HHIS-3	ohne Sensor / without sensor Füllmedium: Bremsflüssigkeit / Fill Medium: Brake Fluid	(105) (25)
2528 L 950.624/625 950.602 950.605 950.626 950.603 950.613/614 950.604 950.623	04.98 - 10.04			3400 710 010 ⊗ 3482 000 463 ⊗ 1878 023 831 ⚡ 3182 600 101	395 18 MF395 395GTZ HHIS-3	mit Sensor / with sensor Füllmedium: Bremsflüssigkeit / Fill Medium: Brake Fluid	(92) (25)
2523 L 950.624	04.98 - 10.04			3400 700 414 ⊕ ⊗ 3483 030 031 ⊗ 1878 002 732	430 18 MFZ430 430WGTZ	für / for: SA504682-09	(69)
2528 L 950.625 950.604 950.603 950.605 950.624 950.626 950.614 950.613 950.602 950.623	04.98 - 10.04			3483 030 031 ⊕	430 MFZ430	für / for: SA504682-09	(69)
				1878 002 731	430 18 430GTZ	für / for: SA504682-09	(69)
				3400 700 617 ⊕ ⊗ 3483 000 258 ⊗ 1878 002 731	430 18 MFZ430 430GTZ	für / for: SA504657-30	(69)
				3483 000 139 ⊕	430 GMFZ430N	für / for: SA504682-10 für Nebenantrieb / for PTO nicht in Verbindung mit Austausch-Kupplungsscheibe / not in connection with replacement clutch disc	(69) (82) (99)
				1878 002 732	430 18 430WGTZ	für / for: SA504682-10 für Nebenantrieb / for PTO	(69) (82)
			OM906		3151 000 396	KZIS-4	für OE-Nummer / for OE number 001 250 99 15 für OE-Nummer / for OE number 002 250 00 15





























































		CODE				
--	--	------	--	---	---	---

MERCEDES-BENZ

ATEGO 2223 - 2530							
2224 L 970.673 970.675 970.677 2226 L 970.677 970.675 970.673 2226 L 970.673 970.675 970.677 2229 L 970.677 970.675 970.673 2229 L 970.673 970.675 970.677 2422 958.092 958.094 958.090 958.096 2425 958.090 958.092 958.094 958.096 2428 958.090 958.096 958.092 958.094 2428 958.090 958.094 958.096 958.092 2529 L 970.677 970.673 970.675	10.04-	OM904		3400 127 701   3482 000 462  1878 052 842	362 18 MF362 362WGTB		
	10.04-			3400 700 484 HD   3482 000 462  1878 006 757	362 18 MF362 362WGTB		
	10.04-			3400 710 005   3482 000 462  1878 052 842  3182 998 501	362 18 MF362 362WGTB HHIS-3	ohne Sensor / without sensor Füllmedium: Bremsflüssigkeit / Fill Medium: Brake Fluid	(105) (25)
	10.04-			3400 710 008   3482 000 462  1878 052 842  3182 600 101	362 18 MF362 362WGTB HHIS-3	mit Sensor / with sensor Füllmedium: Bremsflüssigkeit / Fill Medium: Brake Fluid	(92) (25)
	10.04-			3400 700 397   3482 000 463  1878 004 232	395 18 MF395 395WGTZ	für / for: SA 504672/22	(69)
	10.04-		OM906		3400 121 201   3482 000 464  1878 023 931	395 18 MF395 395GTZ	
				3400 121 301 HD   3482 000 463  1878 023 831	395 18 MF395 395GTZ	für Fahrzeuge mit Kupplungskraftverstärker / for vehicles with clutch booster	(73)
				3400 710 006   3482 000 464  1878 023 931  3182 998 501	395 18 MF395 395GTZ HHIS-3	ohne Sensor / without sensor Füllmedium: Bremsflüssigkeit / Fill Medium: Brake Fluid	(105) (25)
				3400 710 007 HD   3482 000 463  1878 023 831  3182 998 501	395 18 MF395 395GTZ HHIS-3	für Fahrzeuge mit Kupplungskraftverstärker / for vehicles with clutch booster ohne Sensor / without sensor Füllmedium: Bremsflüssigkeit / Fill Medium: Brake Fluid	(73) (105) (25)
				3400 710 009   3482 000 464  1878 023 931  3182 600 101	395 18 MF395 395GTZ HHIS-3	mit Sensor / with sensor Füllmedium: Bremsflüssigkeit / Fill Medium: Brake Fluid	(92) (25)
				3400 710 010 HD   3482 000 463  1878 023 831  3182 600 101	395 18 MF395 395GTZ HHIS-3	für Fahrzeuge mit Kupplungskraftverstärker / for vehicles with clutch booster mit Sensor / with sensor Füllmedium: Bremsflüssigkeit / Fill Medium: Brake Fluid	(73) (92) (25)
				3400 710 012   3482 000 464  1878 023 931  3182 600 172	395 18 MF395 395GTZ	für / for: SA 504673/26 Kabellänge [mm] / Cable Length [mm]: 220 mit Sensor / with sensor Füllmedium: Mineralöl / Fill Medium: Mineral Oil	(69) (36) (92) (26)
				3400 710 013 HD   3482 000 463  1878 023 831  3182 600 172	395 18 MF395 395GTZ	für / for: SA 504673/26 Kabellänge [mm] / Cable Length [mm]: 220 für Fahrzeuge mit Kupplungskraftverstärker / for vehicles with clutch booster mit Sensor / with sensor Füllmedium: Mineralöl / Fill Medium: Mineral Oil	(69) (36) (73) (92) (26)
				3400 710 015   3482 000 464  1878 023 931  3182 600 166	395 18 MF395 395GTZ	mit Sensor / with sensor Füllmedium: Mineralöl / Fill Medium: Mineral Oil	(92) (26)
				3400 710 014 HD   3482 000 463  1878 023 831  3182 600 166	395 18 MF395 395GTZ	für Fahrzeuge mit Kupplungskraftverstärker / for vehicles with clutch booster mit Sensor / with sensor Füllmedium: Mineralöl / Fill Medium: Mineral Oil	(73) (92) (26)
		3400 710 016   3482 000 464  1878 023 931  3182 600 141	395 18 MF395 395GTZ	ohne Sensor / without sensor Füllmedium: Mineralöl / Fill Medium: Mineral Oil	(105) (26)		
		3400 710 017 HD   3482 000 463  1878 023 831  3182 600 141	395 18 MF395 395GTZ	für Fahrzeuge mit Kupplungskraftverstärker / for vehicles with clutch booster ohne Sensor / without sensor Füllmedium: Mineralöl / Fill Medium: Mineral Oil	(73) (105) (26)		























MERCEDES-BENZ

























ATEGO 2223 - 2530

2224 L 970.673 970.677 970.675	10.04-	OM904	 3400 127 701   3482 000 462  1878 052 842	362 18 MF362 362WGTB			
			 3400 700 484 HD   3482 000 462  1878 006 757	362 18 MF362 362WGTB			
			 3400 710 005  3482 000 462  1878 052 842  3182 998 501	362 18 MF362 362WGTB HHIS-3	ohne Sensor / without sensor Füllmedium: Bremsflüssigkeit / Fill Medium: Brake Fluid	(105) (25)	
			 3400 710 008  3482 000 462  1878 052 842  3182 600 101	362 18 MF362 362WGTB HHIS-3	mit Sensor / with sensor Füllmedium: Bremsflüssigkeit / Fill Medium: Brake Fluid	(92) (25)	
			 3400 700 397  3482 000 463  1878 004 232	395 18 MF395 395WGTZ	für / for: SA 504672/22	(69)	
		OM906	 3400 121 201   3482 000 464  1878 023 931	395 18 MF395 395GTZ			
			 3400 121 301 HD   3482 000 463  1878 023 831	395 18 MF395 395GTZ	für Fahrzeuge mit Kupplungskraftverstärker / for vehicles with clutch booster	(73)	
			 3400 710 006  3482 000 464  1878 023 931  3182 998 501	395 18 MF395 395GTZ HHIS-3	ohne Sensor / without sensor Füllmedium: Bremsflüssigkeit / Fill Medium: Brake Fluid	(105) (25)	
			 3400 710 007 HD  3482 000 463  1878 023 831  3182 998 501	395 18 MF395 395GTZ HHIS-3	für Fahrzeuge mit Kupplungskraftverstärker / for vehicles with clutch booster ohne Sensor / without sensor Füllmedium: Bremsflüssigkeit / Fill Medium: Brake Fluid	(73) (105) (25)	
			 3400 710 009  3482 000 464  1878 023 931  3182 600 101	395 18 MF395 395GTZ HHIS-3	mit Sensor / with sensor Füllmedium: Bremsflüssigkeit / Fill Medium: Brake Fluid	(92) (25)	
			 3400 710 010 HD  3482 000 463  1878 023 831  3182 600 101	395 18 MF395 395GTZ HHIS-3	für Fahrzeuge mit Kupplungskraftverstärker / for vehicles with clutch booster mit Sensor / with sensor Füllmedium: Bremsflüssigkeit / Fill Medium: Brake Fluid	(73) (92) (25)	
			 3400 710 015  3482 000 464  1878 023 931  3182 600 166	395 18 MF395 395GTZ	mit Sensor / with sensor Füllmedium: Mineralöl / Fill Medium: Mineral Oil	(92) (26)	
			 3400 710 014 HD  3482 000 463  1878 023 831  3182 600 166	395 18 MF395 395GTZ	für Fahrzeuge mit Kupplungskraftverstärker / for vehicles with clutch booster mit Sensor / with sensor Füllmedium: Mineralöl / Fill Medium: Mineral Oil	(73) (92) (26)	
			 3400 710 016  3482 000 464  1878 023 931  3182 600 141	395 18 MF395 395GTZ	ohne Sensor / without sensor Füllmedium: Mineralöl / Fill Medium: Mineral Oil	(105) (26)	
			 3400 710 017 HD  3482 000 463  1878 023 831  3182 600 141	395 18 MF395 395GTZ	für Fahrzeuge mit Kupplungskraftverstärker / for vehicles with clutch booster ohne Sensor / without sensor Füllmedium: Mineralöl / Fill Medium: Mineral Oil	(73) (105) (26)	
			OM904, 906	 3182 998 501	HHIS-3	ohne Sensor / without sensor Füllmedium: Bremsflüssigkeit / Fill Medium: Brake Fluid Immer erneuern / Renew everytime	(105) (25) (30)
				3182 600 166		mit Sensor / with sensor Füllmedium: Mineralöl / Fill Medium: Mineral Oil Immer erneuern / Renew everytime	(92) (26) (30)
				3182 600 141		ohne Sensor / without sensor Füllmedium: Mineralöl / Fill Medium: Mineral Oil Immer erneuern / Renew everytime	(105) (26) (30)
		3182 600 101		HHIS-3	mit Sensor / with sensor Füllmedium: Bremsflüssigkeit / Fill Medium: Brake Fluid Immer erneuern / Renew everytime	(92) (25) (30)	
		 3151 000 396		KZIS-4			

		CODE				
--	--	------	--	---	---	---











































MERCEDES-BENZ

ATEGO 2628 -								
2628 950.643 950.642 2628 B 953.643 953.641 2628 K 952.642 952.641 952.643	04.98 - 10.04	OM906LA		3400 121 301 ◐  3482 000 463  1878 023 831	395 18 MF395 395GTZ			
	04.98 - 10.04			3400 710 007  3482 000 463  1878 023 831  3182 998 501	395 18 MF395 395GTZ HHIS-3	ohne Sensor / without sensor Füllmedium: Bremsflüssigkeit / Fill Medium: Brake Fluid	(105) (25)	
	04.98 - 10.04			3400 710 010  3482 000 463  1878 023 831  3182 600 101	395 18 MF395 395GTZ HHIS-3	mit Sensor / with sensor Füllmedium: Bremsflüssigkeit / Fill Medium: Brake Fluid	(92) (25)	
					3483 030 031 ⊕	430 MFZ430	für / for: SA504682-09	(69)
					1878 002 731	430 18 430GTZ	für / for: SA504682-09	(69)
					3400 700 617 ⊕  3483 000 258  1878 002 731	430 18 MFZ430 430GTZ	für / for: SA504657-30	(69)
					3483 000 139 ⊕	430 GMFZ430N	für / for: SA504682-10 für Nebenantrieb / for PTO nicht in Verbindung mit Austausch-Kupplungsscheibe / not in connection with replacement clutch disc	(69) (82) (99)
					1878 002 732	430 18 430WGTZ	für / for: SA504682-10 für Nebenantrieb / for PTO	(69) (82)
			OM906		3151 000 396	KZIS-4	für OE-Nummer / for OE number 001 250 99 15 für OE-Nummer / for OE number 002 250 00 15	(83) (83)
			OM926		3400 700 446 ⊕  3483 000 258  1878 007 072	430 18 MFZ430 430WGTZ		

AXOR 1823 - 2044								
01.02 -								
1823 375.301 1823 K 375.303	01.02 - 10.04	OM906.920		3400 121 201 ◐  3482 000 464  1878 023 931	395 18 MF395 395GTZ	für / for: SA531129-01	(69)	
	01.02 - 10.04			3400 121 301 ◐  3482 000 463  1878 023 831	395 18 MF395 395GTZ	für / for: SA531129-02	(69)	
				3400 710 006  3482 000 464  1878 023 931  3182 998 501	395 18 MF395 395GTZ HHIS-3	ohne Sensor / without sensor Füllmedium: Bremsflüssigkeit / Fill Medium: Brake Fluid	(105) (25)	
				3400 710 007  3482 000 463  1878 023 831  3182 998 501	395 18 MF395 395GTZ HHIS-3	ohne Sensor / without sensor Füllmedium: Bremsflüssigkeit / Fill Medium: Brake Fluid	(105) (25)	
				3400 710 009  3482 000 464  1878 023 931  3182 600 101	395 18 MF395 395GTZ HHIS-3	mit Sensor / with sensor Füllmedium: Bremsflüssigkeit / Fill Medium: Brake Fluid	(92) (25)	
				3400 710 010  3482 000 463  1878 023 831  3182 600 101	395 18 MF395 395GTZ HHIS-3	mit Sensor / with sensor Füllmedium: Bremsflüssigkeit / Fill Medium: Brake Fluid	(92) (25)	
					3182 998 501	HHIS-3	für / for: SA504673-06/10 für / for: SA504673-07/22 ohne Sensor / without sensor Füllmedium: Bremsflüssigkeit / Fill Medium: Brake Fluid Immer erneuern / Renew everytime	(69) (69) (105) (25) (30)
					3182 600 101	HHIS-3	für / for: SA504673-08/11 mit Sensor / with sensor Füllmedium: Bremsflüssigkeit / Fill Medium: Brake Fluid Immer erneuern / Renew everytime	(69) (92) (25) (30)

















































































		CODE					
--	--	------	--	--	---	---	---

MERCEDES-BENZ















AXOR 1823 - 2044		01.02 -						
1823, 1823 L, 1824, 1824 L, LL 950.507 950.509 950.547 950.539 950.531 950.538 950.503 950.533 950.506 950.534 950.504 950.508 950.537 950.501 950.505 950.532 950.536 950.502 950.535 950.544 950.546 1823 AK, 1824 AK 952.563 952.562 1823 LS, 1824 LS 954.532 1823 K, 1823 KL, 1824 K 952.502/503 1826, 1826 L, LL 950.531 950.539 950.508 950.532 950.538 950.506 950.535 950.537 950.533 950.546/547 950.536 950.501 950.505 950.507 950.509 950.503/504 950.534 950.502 950.544 1826 AK 952.562/563 1826 K 952.502/503 1826 LS 954.532 1828, 1828 L, 1829, 1829 L, LL 950.505 950.533 950.547 950.509 950.537 950.502/503 950.508 950.544 950.501 950.506 950.532 950.538/539 950.534/535 950.504 950.507 950.536 950.531 950.546 1828 A, 1829 A 950.563 950.562 1828 AK, 1829 AK 374.557 952.563 952.562 1828 K, 1828 KL, 1829 K 952.503 374.554 952.502 1829 LS 954.532 1833, 1833 L, LL 950.501 950.508 950.547 950.534 950.538/539 950.502 950.505 950.535 950.533 950.546 950.531 950.536 950.504 950.503 950.509 950.506/507 950.532 950.537 950.544 1833 A 950.562/563 1833 AK 952.563 952.562 1833 K 952.503 952.502 1833 LS 954.532	10.04-	OM906LA		3400 121 201   3482 000 464  1878 023 931	395 18 MF395 395GTZ	max. übertragbares Motormoment [Nm] / max. transmittable engine torque [Nm]: 810	(87)	
					3400 121 301   3482 000 463  1878 023 831	395 18 MF395 395GTZ	max. übertragbares Motormoment [Nm] / max. transmittable engine torque [Nm]: 900	(87)
		10.04-			3400 710 009   3482 000 464  1878 023 931  3182 600 101	395 18 MF395 395GTZ HHIS-3	mit Sensor / with sensor max. übertragbares Motormoment [Nm] / max. transmittable engine torque [Nm]: 810 Füllmedium: Bremsflüssigkeit / Fill Medium: Brake Fluid	(92) (87)
		10.04-			3400 710 006   3482 000 464  1878 023 931  3182 998 501	395 18 MF395 395GTZ HHIS-3	ohne Sensor / without sensor max. übertragbares Motormoment [Nm] / max. transmittable engine torque [Nm]: 810 Füllmedium: Bremsflüssigkeit / Fill Medium: Brake Fluid	(105) (87)
		10.04-			3400 710 010   3482 000 463  1878 023 831  3182 600 101	395 18 MF395 395GTZ HHIS-3	mit Sensor / with sensor max. übertragbares Motormoment [Nm] / max. transmittable engine torque [Nm]: 900 Füllmedium: Bremsflüssigkeit / Fill Medium: Brake Fluid	(92) (87)
		10.04-			3400 710 007   3482 000 463  1878 023 831  3182 998 501	395 18 MF395 395GTZ HHIS-3	ohne Sensor / without sensor max. übertragbares Motormoment [Nm] / max. transmittable engine torque [Nm]: 900 Füllmedium: Bremsflüssigkeit / Fill Medium: Brake Fluid	(105) (87)
		10.04-			3400 710 012   3482 000 464  1878 023 931  3182 600 172	395 18 MF395 395GTZ	für / for: SA504673/30 Kabellänge [mm] / Cable Length [mm]: 220 mit Sensor / with sensor max. übertragbares Motormoment [Nm] / max. transmittable engine torque [Nm]: 810 Füllmedium: Mineralöl / Fill Medium: Mineral Oil	(69) (36) (92) (87)
		10.04-			3400 710 013   3482 000 463  1878 023 831  3182 600 172	395 18 MF395 395GTZ	für / for: SA504673/30 Kabellänge [mm] / Cable Length [mm]: 220 mit Sensor / with sensor max. übertragbares Motormoment [Nm] / max. transmittable engine torque [Nm]: 900 Füllmedium: Mineralöl / Fill Medium: Mineral Oil	(69) (36) (92) (87)
		10.04-			3400 710 015   3482 000 464  1878 023 931  3182 600 166	395 18 MF395 395GTZ	mit Sensor / with sensor max. übertragbares Motormoment [Nm] / max. transmittable engine torque [Nm]: 810 Füllmedium: Mineralöl / Fill Medium: Mineral Oil	(92) (87)
		10.04-			3400 710 014   3482 000 463  1878 023 831  3182 600 166	395 18 MF395 395GTZ	mit Sensor / with sensor max. übertragbares Motormoment [Nm] / max. transmittable engine torque [Nm]: 900 Füllmedium: Mineralöl / Fill Medium: Mineral Oil	(92) (87)
		10.04-			3400 710 016   3482 000 464  1878 023 931  3182 600 141	395 18 MF395 395GTZ	ohne Sensor / without sensor max. übertragbares Motormoment [Nm] / max. transmittable engine torque [Nm]: 810 Füllmedium: Mineralöl / Fill Medium: Mineral Oil	(105) (87)
		10.04-			3400 710 017   3482 000 463  1878 023 831  3182 600 141	395 18 MF395 395GTZ	ohne Sensor / without sensor max. übertragbares Motormoment [Nm] / max. transmittable engine torque [Nm]: 900 Füllmedium: Mineralöl / Fill Medium: Mineral Oil	(105) (87)
					3400 700 414 HD   3483 030 031  1878 002 732	430 18 MFZ430 430WGTZ		
					3483 000 139 	430 GMFZ430N	für Nebenantrieb / for PTO nicht in Verbindung mit Austausch-Kupplungsscheibe / not in connection with replacement clutch disc	(82) (99)
					1878 002 731	430 18 430GTZ	für Nebenantrieb / for PTO	(82)
			OM926LA		3400 700 446    3483 000 258  1878 007 072	430 18 MFZ430 430WGTZ		

		CODE				
--	--	------	--	---	---	---

MERCEDES-BENZ





























































AXOR 1823 - 2044		01.02 -						
1824 A 1828 LS 954.532 1933 958.207 1933 S 958.207 958.203	10.04-	OM904		3400 127 701   3482 000 462  1878 052 842	362 18 MF362 362WGTB			
	10.04-			3400 700 484 HD   3482 000 462  1878 006 757	362 18 MF362 362WGTB			
	10.04-		01.11-		3400 710 005   3482 000 462  1878 052 842  3182 998 501	362 18 MF362 362WGTB HHIS-3	ohne Sensor / without sensor Füllmedium: Bremsflüssigkeit / Fill Medium: Brake Fluid	(105) (25)
					3400 710 008   3482 000 462  1878 052 842  3182 600 101	362 18 MF362 362WGTB HHIS-3	mit Sensor / with sensor Füllmedium: Bremsflüssigkeit / Fill Medium: Brake Fluid	(92) (25)
					3400 700 397   3482 000 463  1878 004 232	395 18 MF395 395WGTZ	für / for: SA 504672/22	(69)
			OM906		3400 121 201   3482 000 464  1878 023 931	395 18 MF395 395GTZ		
					3400 121 301 HD   3482 000 463  1878 023 831	395 18 MF395 395GTZ	für Fahrzeuge mit Kupplungskraftverstärker / for vehicles with clutch booster	(73)
					3400 710 006   3482 000 464  1878 023 931  3182 998 501	395 18 MF395 395GTZ HHIS-3	ohne Sensor / without sensor Füllmedium: Bremsflüssigkeit / Fill Medium: Brake Fluid	(105) (25)
					3400 710 007 HD   3482 000 463  1878 023 831  3182 998 501	395 18 MF395 395GTZ HHIS-3	für Fahrzeuge mit Kupplungskraftverstärker / for vehicles with clutch booster ohne Sensor / without sensor Füllmedium: Bremsflüssigkeit / Fill Medium: Brake Fluid	(73) (105) (25)
					3400 710 009   3482 000 464  1878 023 931  3182 600 101	395 18 MF395 395GTZ HHIS-3	mit Sensor / with sensor Füllmedium: Bremsflüssigkeit / Fill Medium: Brake Fluid	(92) (25)
					3400 710 010 HD   3482 000 463  1878 023 831  3182 600 101	395 18 MF395 395GTZ HHIS-3	für Fahrzeuge mit Kupplungskraftverstärker / for vehicles with clutch booster mit Sensor / with sensor Füllmedium: Bremsflüssigkeit / Fill Medium: Brake Fluid	(73) (92) (25)
					3400 710 012   3482 000 464  1878 023 931  3182 600 172	395 18 MF395 395GTZ	für / for: SA 504673/26 Kabellänge [mm] / Cable Length [mm]: 220 mit Sensor / with sensor Füllmedium: Mineralöl / Fill Medium: Mineral Oil	(69) (36) (92) (26)
					3400 710 013 HD   3482 000 463  1878 023 831  3182 600 172	395 18 MF395 395GTZ	für / for: SA 504673/26 Kabellänge [mm] / Cable Length [mm]: 220 für Fahrzeuge mit Kupplungskraftverstärker / for vehicles with clutch booster mit Sensor / with sensor Füllmedium: Mineralöl / Fill Medium: Mineral Oil	(69) (36) (73) (92) (26)
					3400 710 015   3482 000 464  1878 023 931  3182 600 166	395 18 MF395 395GTZ	mit Sensor / with sensor Füllmedium: Mineralöl / Fill Medium: Mineral Oil	(92) (26)
					3400 710 014 HD   3482 000 463  1878 023 831  3182 600 166	395 18 MF395 395GTZ	für Fahrzeuge mit Kupplungskraftverstärker / for vehicles with clutch booster mit Sensor / with sensor Füllmedium: Mineralöl / Fill Medium: Mineral Oil	(73) (92) (26)
					3400 710 016   3482 000 464  1878 023 931  3182 600 141	395 18 MF395 395GTZ	ohne Sensor / without sensor Füllmedium: Mineralöl / Fill Medium: Mineral Oil	(105) (26)
					3400 710 017 HD   3482 000 463  1878 023 831  3182 600 141	395 18 MF395 395GTZ	für Fahrzeuge mit Kupplungskraftverstärker / for vehicles with clutch booster ohne Sensor / without sensor Füllmedium: Mineralöl / Fill Medium: Mineral Oil	(73) (105) (26)

MERCEDES-BENZ

AXOR 1823 - 2044		01.02 -					
1835 LS 944.032 375.408 944.033	01.02 - 10.04	OM457.980, OM457.948, OM457.910, OM457.918, OM457.937, OM457.917	 3400 122 801 ⊕ ⊗ 3483 030 032 ⊗ 1878 007 072	430 18 MFZ430 430WGTZ	für / for: SA 531129-04/05	(69)	
1836 LS, LLS 944.032/033	10.04 -		 3400 700 446 ⊕ ⊗ 3483 000 258 ⊗ 1878 007 072	430 18 MFZ430 430WGTZ	für / for: SA 504682-24	(69)	
1840 LS 944.033 375.408 944.032	01.02 - 10.04		 1863 869 028				
1843 LS 944.033 944.032 375.408	01.02 - 10.04		 3189 600 058		für / for: SA 5046831/03 Nebenantriebs-ID / PTO ID: NMV	(69) (50)	
1843 LS, LLS 944.033 944.032	10.04 -		3189 600 059				
1835 LS 944.032/033	01.11 -						
2035 S, 2036 S, LS 958.433 958.431	01.11 -						
1840 LS, LLS 374.651 944.032/033	10.04 -	OM457.980, OM457.955, OM457.948, OM457.910, OM457.918, OM457.937, OM457.917	 3400 122 801 ⊕ ⊗ 3483 030 032 ⊗ 1878 007 072	430 18 MFZ430 430WGTZ	für / for: SA 531129-04/05	(69)	
2040 S, 2041 S, 2041 S, 2041 LS 958.431 958.433	01.11 -		 3400 700 446 ⊕ ⊗ 3483 000 258 ⊗ 1878 007 072	430 18 MFZ430 430WGTZ	für / for: SA 504682-24	(69)	
2044 S 958.431 958.433	01.11 -		 3483 000 461 ⊕	430 MFZ430	für / for: SA 591014/07	(69)	
			 1878 007 072	430 18 430WGTZ	für / for: SA 591014/07	(69)	
			 1863 869 028				
			 3189 600 059				
			 3189 600 058		für / for: SA 5046831/03 Nebenantriebs-ID / PTO ID: NMV	(69) (50)	
AXOR 2436 - 2544		01.02 -					
2436 LS, 2536 LS 944.235	10.04 -	OM457.980, OM457.981, OM457.948, OM457.918, OM457.937	 3400 122 801 ⊕ ⊗ 3483 030 032 ⊗ 1878 007 072	430 18 MFZ430 430WGTZ	für / for: SA 531129-04/05	(69)	
2440 LS, 2540 LS 944.235	10.04 -		 3400 700 446 ⊕ ⊗ 3483 000 258 ⊗ 1878 007 072	430 18 MFZ430 430WGTZ	für / for: SA 504682-24	(69)	
2443 LS, 2543 LS 944.235	10.04 -		 1863 869 028				
2535 LS 944.233	01.02 - 10.04		 3189 600 058		für / for: SA 5046831/03 Nebenantriebs-ID / PTO ID: NMV	(69) (50)	
2535 S, 2535 LS 958.461	10.04 -		3189 600 059				
2536	01.12 -						
2540 LS 944.233	01.02 - 10.04						
2543 LS 944.233	01.02 - 10.04						
2544 S, 2544 LS	10.04 -						























































		CODE				
--	--	------	--	---	---	---

MERCEDES-BENZ

AXOR 2436 - 2544		01.02 -					
2523 375.321 2523 375.322 2523 K 375.323 2528 375.322 375.321 2528 K, 2528 KL 375.323	01.02 - 10.04	OM906.921, OM906.920		3400 121 201 ◐  3482 000 464  1878 023 931	395 18 MF395 395GTZ	für / for: SA531129-01	(69)
	01.11 -			3400 121 301 ◐  3482 000 463  1878 023 831	395 18 MF395 395GTZ	für / for: SA531129-02	(69)
	01.02 - 10.04			3400 710 006  3482 000 464  1878 023 931  3182 998 501	395 18 MF395 395GTZ HHIS-3	ohne Sensor / without sensor Füllmedium: Bremsflüssigkeit / Fill Medium: Brake Fluid	(105) (25)
	01.02 - 10.04			3400 710 007  3482 000 463  1878 023 831  3182 998 501	395 18 MF395 395GTZ HHIS-3	ohne Sensor / without sensor Füllmedium: Bremsflüssigkeit / Fill Medium: Brake Fluid	(105) (25)
	01.11 -			3400 710 009  3482 000 464  1878 023 931  3182 600 101	395 18 MF395 395GTZ HHIS-3	mit Sensor / with sensor Füllmedium: Bremsflüssigkeit / Fill Medium: Brake Fluid	(92) (25)
				3400 710 010  3482 000 463  1878 023 831  3182 600 101	395 18 MF395 395GTZ HHIS-3	mit Sensor / with sensor Füllmedium: Bremsflüssigkeit / Fill Medium: Brake Fluid	(92) (25)
				3182 998 501	HHIS-3	für / for: SA504673-06/10 für / for: SA504673-07/22 ohne Sensor / without sensor Füllmedium: Bremsflüssigkeit / Fill Medium: Brake Fluid Immer erneuern / Renew everytime	(69) (69) (105) (25) (30)
				3182 600 101	HHIS-3	für / for: SA504673-08/11 mit Sensor / with sensor Füllmedium: Bremsflüssigkeit / Fill Medium: Brake Fluid Immer erneuern / Renew everytime	(69) (92) (25) (30)
2528 950.626 950.623-625 2528 L, 2529 L 950.607 950.602/603 950.606 950.613/614 950.601 950.605 950.604 950.608 2528 L, 2529 L 950.607 950.604 950.602/603 950.605 950.608 950.613 950.601 950.606 950.614 2533 950.625/626 950.623/624 2533, 2533 L 950.614 950.601 958.252 950.608 958.254/255 958.250 950.604 950.606 950.602/603 950.605 950.607 950.613 2533, 2533 L 958.250 958.255 950.607 950.613 950.601 950.603 950.614 958.252 958.254 950.606 950.605 950.608 950.602 950.604	01.04 -	OM906LA		3400 121 301 ◐  3482 000 463  1878 023 831	395 18 MF395 395GTZ		
	10.04 -			3400 710 007  3482 000 463  1878 023 831  3182 998 501	395 18 MF395 395GTZ HHIS-3	ohne Sensor / without sensor Füllmedium: Bremsflüssigkeit / Fill Medium: Brake Fluid	(105) (25)
	10.04 -			3400 710 010  3482 000 463  1878 023 831  3182 600 101	395 18 MF395 395GTZ HHIS-3	mit Sensor / with sensor Füllmedium: Bremsflüssigkeit / Fill Medium: Brake Fluid	(92) (25)
	01.04 -			3400 700 414 ⊕  3483 030 031  1878 002 732	430 18 MFZ430 430WGTZ	für / for: SA504682-09	(69)
	10.04 -			3483 030 031 ⊕  1878 002 731	430 18 MFZ430 430GTZ	für / for: SA504682-09	(69)
				1878 002 731	430GTZ	für / for: SA504682-09	(69)
				3400 700 617 ⊕  3483 000 258  1878 002 731	430 18 MFZ430 430GTZ	für / for: SA504657-30	(69)
				3483 000 139 ⊕  1878 002 732	430 18 GMFZ430N	für / for: SA504682-10 für Nebenantrieb / for PTO nicht in Verbindung mit Austausch-Kupplungsscheibe / not in connection with replacement clutch disc	(69) (82) (99)
				1878 002 732	430 18 430WGTZ	für / for: SA504682-10 für Nebenantrieb / for PTO	(69) (82)
				3151 000 396	KZIS-4	für OE-Nummer / for OE number 001 250 99 15 für OE-Nummer / for OE number 002 250 00 15	(83) (83)
2535 L, 2536 L, 2536 LL 940.205 940.204 940.203 2540 L, LL 940.203-205 2540 S, 2541 S, LS 958.461 2543 L, LL 940.205 940.204 940.203 2543 S, 2543 LS 944.233	10.04 -	OM457.980, OM457.948, OM457.918, OM457.937		3400 122 801 ⊕  3483 030 032  1878 007 072	430 18 MFZ430 430WGTZ	für / for: SA 531129-04/05	(69)
	10.04 -			3400 700 446 ⊕  3483 000 258  1878 007 072	430 18 MFZ430 430WGTZ	für / for: SA 504682-24	(69)
	10.04 -			3400 121 501 ⊕  3488 023 031  1878 002 024	400 18 MFZ2/400X 400WGTZ	für / for: SA 504682 13 Nabenprofil / Hub Profile: 45x50-18N für Fahrzeuge mit Zweis Scheibenkupplung / for vehicles with double disc clutch	(69) (48) (77)
	10.04 -			1863 869 028			
				3189 600 059			
				3189 600 058		für / for: SA 5046831/03	(69)

















































































		CODE				
--	--	------	--	---	---	---

MERCEDES-BENZ

AXOR 2623 - 2831		09.01 -					
2623 L 375.351 2628 B 375.374 2628 K 375.373 2628 L 375.351	01.02 - 10.04	OM906.921, OM906.920		3400 121 201 ◐  3482 000 464  1878 023 931	395 18 MF395 395GTZ	für / for: SA531129-01	(69)
	01.02 - 10.04			3400 121 301 ◐  3482 000 463  1878 023 831	395 18 MF395 395GTZ	für / for: SA531129-02	(69)
	01.02 - 10.04			3400 710 006  3482 000 464  1878 023 931  3182 998 501	395 18 MF395 395GTZ HHIS-3	ohne Sensor / without sensor Füllmedium: Bremsflüssigkeit / Fill Medium: Brake Fluid	(105) (25)
	01.02 - 10.04			3400 710 007  3482 000 463  1878 023 831  3182 998 501	395 18 MF395 395GTZ HHIS-3	ohne Sensor / without sensor Füllmedium: Bremsflüssigkeit / Fill Medium: Brake Fluid	(105) (25)
				3400 710 009  3482 000 464  1878 023 931  3182 600 101	395 18 MF395 395GTZ HHIS-3	mit Sensor / with sensor Füllmedium: Bremsflüssigkeit / Fill Medium: Brake Fluid	(92) (25)
				3400 710 010  3482 000 463  1878 023 831  3182 600 101	395 18 MF395 395GTZ HHIS-3	mit Sensor / with sensor Füllmedium: Bremsflüssigkeit / Fill Medium: Brake Fluid	(92) (25)
				3182 998 501	HHIS-3	für / for: SA504673-06/10 für / for: SA504673-07/22 ohne Sensor / without sensor Füllmedium: Bremsflüssigkeit / Fill Medium: Brake Fluid Immer erneuern / Renew everytime	(69) (69) (105) (25) (30)
				3182 600 101	HHIS-3	für / for: SA504673-08/11 mit Sensor / with sensor Füllmedium: Bremsflüssigkeit / Fill Medium: Brake Fluid Immer erneuern / Renew everytime	(69) (92) (25) (30)
2628, 2629 950.643 950.642 2633 950.642/643	10.04 -	OM906LA		3400 121 301 ◐  3482 000 463  1878 023 831	395 18 MF395 395GTZ		
	10.04 -			3400 710 007  3482 000 463  1878 023 831  3182 998 501	395 18 MF395 395GTZ HHIS-3	ohne Sensor / without sensor Füllmedium: Bremsflüssigkeit / Fill Medium: Brake Fluid	(105) (25)
				3400 710 010  3482 000 463  1878 023 831  3182 600 101	395 18 MF395 395GTZ HHIS-3	mit Sensor / with sensor Füllmedium: Bremsflüssigkeit / Fill Medium: Brake Fluid	(92) (25)
				3483 030 031 ⊕	430 MFZ430	für / for: SA504682-09	(69)
				1878 002 731	430 18 430GTZ	für / for: SA504682-09	(69)
				3400 700 617 ⊕  3483 000 258  1878 002 731	430 18 MFZ430 430GTZ	für / for: SA504657-30	(69)
				3483 000 139 ⊕	430 GMFZ430N	für / for: SA504682-10 für Nebenantrieb / for PTO nicht in Verbindung mit Austausch-Kupplungsscheibe / not in connection with replacement clutch disc	(69) (82) (99)
				1878 002 732	430 18 430WGTZ	für / for: SA504682-10 für Nebenantrieb / for PTO	(69) (82)
2628 B, 2629 B 953.641 953.643	10.04 -	OM906		3400 121 201 ◐  3482 000 464  1878 023 931	395 18 MF395 395GTZ		
		OM906LA		3400 121 301 ◐  3482 000 463  1878 023 831	395 18 MF395 395GTZ		
				3400 700 414 HD ⊕  3483 030 031  1878 002 732	430 18 MFZ430 430WGTZ		
		OM926		3400 700 446 ⊕  3483 000 258  1878 007 072	430 18 MFZ430 430WGTZ		

		CODE				
--	--	------	--	---	---	---

MERCEDES-BENZ

AXOR 2623 - 2831		09.01 -					
2628 K, 2629 K 952.643 374.584 952.641/642 2633 B 953.641 953.643 2633 K 952.642 952.641 952.643 2828 K 958.264 2831 958.260 958.264 2831 B	10.04-	OM904		3400 127 701   3482 000 462  1878 052 842	362 18 MF362 362WGTB		
	10.04-			3400 700 484 HD   3482 000 462  1878 006 757	362 18 MF362 362WGTB		
	10.04-			3400 710 005   3482 000 462  1878 052 842  3182 998 501	362 18 MF362 362WGTB HHIS-3	ohne Sensor / without sensor Füllmedium: Bremsflüssigkeit / Fill Medium: Brake Fluid	(105) (25)
	10.04-			3400 710 008   3482 000 462  1878 052 842  3182 600 101	362 18 MF362 362WGTB HHIS-3	mit Sensor / with sensor Füllmedium: Bremsflüssigkeit / Fill Medium: Brake Fluid	(92) (25)
	01.11-			3400 700 397   3482 000 463  1878 004 232	395 18 MF395 395WGTZ	für / for: SA 504672/22	(69)
	01.12-			3400 121 201   3482 000 464  1878 023 931	395 18 MF395 395GTZ		
				3400 121 301 HD   3482 000 463  1878 023 831	395 18 MF395 395GTZ	für Fahrzeuge mit Kupplungskraftverstärker / for vehicles with clutch booster	(73)
				3400 710 006   3482 000 464  1878 023 931  3182 998 501	395 18 MF395 395GTZ HHIS-3	ohne Sensor / without sensor Füllmedium: Bremsflüssigkeit / Fill Medium: Brake Fluid	(105) (25)
				3400 710 007 HD   3482 000 463  1878 023 831  3182 998 501	395 18 MF395 395GTZ HHIS-3	für Fahrzeuge mit Kupplungskraftverstärker / for vehicles with clutch booster ohne Sensor / without sensor Füllmedium: Bremsflüssigkeit / Fill Medium: Brake Fluid	(73) (105) (25)
				3400 710 009   3482 000 464  1878 023 931  3182 600 101	395 18 MF395 395GTZ HHIS-3	mit Sensor / with sensor Füllmedium: Bremsflüssigkeit / Fill Medium: Brake Fluid	(92) (25)
			3400 710 010 HD   3482 000 463  1878 023 831  3182 600 101	395 18 MF395 395GTZ HHIS-3	für Fahrzeuge mit Kupplungskraftverstärker / for vehicles with clutch booster mit Sensor / with sensor Füllmedium: Bremsflüssigkeit / Fill Medium: Brake Fluid	(73) (92) (25)	
			3400 710 012   3482 000 464  1878 023 931  3182 600 172	395 18 MF395 395GTZ	für / for: SA 504673/26 Kabellänge [mm] / Cable Length [mm]: 220 mit Sensor / with sensor Füllmedium: Mineralöl / Fill Medium: Mineral Oil	(69) (36) (92) (26)	
			3400 710 013 HD   3482 000 463  1878 023 831  3182 600 172	395 18 MF395 395GTZ	für / for: SA 504673/26 Kabellänge [mm] / Cable Length [mm]: 220 für Fahrzeuge mit Kupplungskraftverstärker / for vehicles with clutch booster mit Sensor / with sensor Füllmedium: Mineralöl / Fill Medium: Mineral Oil	(69) (36) (73) (92) (26)	
			3400 710 015   3482 000 464  1878 023 931  3182 600 166	395 18 MF395 395GTZ	mit Sensor / with sensor Füllmedium: Mineralöl / Fill Medium: Mineral Oil	(92) (26)	
			3400 710 014 HD   3482 000 463  1878 023 831  3182 600 166	395 18 MF395 395GTZ	für Fahrzeuge mit Kupplungskraftverstärker / for vehicles with clutch booster mit Sensor / with sensor Füllmedium: Mineralöl / Fill Medium: Mineral Oil	(73) (92) (26)	
			3400 710 016   3482 000 464  1878 023 931  3182 600 141	395 18 MF395 395GTZ	ohne Sensor / without sensor Füllmedium: Mineralöl / Fill Medium: Mineral Oil	(105) (26)	
			3400 710 017 HD   3482 000 463  1878 023 831  3182 600 141	395 18 MF395 395GTZ	für Fahrzeuge mit Kupplungskraftverstärker / for vehicles with clutch booster ohne Sensor / without sensor Füllmedium: Mineralöl / Fill Medium: Mineral Oil	(73) (105) (26)	















MERCEDES-BENZ

AXOR 2623 - 2831		09.01 -						
2635 B 943.142/143 943.141 2636 2640 2643 2644 S, LS 958.451 2644 S, LS 2826 2831 K	10.05-	OM457.980, OM457.981, OM457.948, OM457.918, OM457.956, OM457.957, OM457.937		3400 122 801 ⊕ 3483 030 032 1878 007 072	430 18 MFZ430 430WGTZ	für / for: SA 531129-04/05	(69)	
	10.04-			3400 700 446 ⊕ 3483 000 258 1878 007 072	430 18 MFZ430 430WGTZ	für / for: SA 504682-24	(69)	
	10.04-			1863 869 028				
	01.11-			3189 600 058			für / for: SA 5046831/03 Nebenantriebs-ID / PTO ID: NMV	(69) (50)
	12.11-			3189 600 059				
2636 B 943.143 943.142 2636 B 943.141 2636 K 942.143 942.141/142 2636 K 942.141 2640 B 943.143 943.142 943.141 2640 K 942.141-143 2643 B 943.141 943.143 943.142 2643 K 942.141 942.143 942.142 2643 K 942.141 2640 S, 2641 S, LS 958.451	10.04-	OM457.980, OM457.981, OM457.948, OM457.956, OM457.957, OM457LA, OM457.937		3400 122 801 ⊕ 3483 030 032 1878 007 072	430 18 MFZ430 430WGTZ			
	01.01-			3400 121 501 ⊕ 3488 023 031 1878 002 024	400 18 MFZ2/400X 400WGTZ	Nabenprofil / Hub Profile: 45x50-18N für Fahrzeuge mit Zweischeibenkupplung / for vehicles with double disc clutch	(48) (77)	
	10.04-			1863 869 028				
	01.01-			3189 600 058			für / for: SA 5046831/03 Nebenantriebs-ID / PTO ID: NMV	(69) (50)
	10.04-			3189 600 059				
	10.04-							
	10.04-							
	10.04-							
	10.04-							
	01.01-							
2640 S, 2641 S, LS 958.451	10.04-	OM457.918		3400 700 355 ⊕ 3488 000 158 1878 002 019	400 18 MFZ2/400X 400WGTZ			
				3189 600 059			für / for: SA 5046831/03 Nebenantriebs-ID / PTO ID: NMV	(69) (50)

AXOR 3028 - 4144		09.01 -						
3028 B 375.374 3028 K 375.373 3228 3228 C 375.381	01.11-	OM906.921		3400 121 201 ⊖ 3482 000 464 1878 023 931	395 18 MF395 395GTZ	für / for: SA531129-01	(69)	
	01.11-			3400 121 301 ⊖ 3482 000 463 1878 023 831	395 18 MF395 395GTZ	für / for: SA531129-02	(69)	
	01.11-			3400 710 006 3482 000 464 1878 023 931 3182 998 501	395 18 MF395 395GTZ HHIS-3	ohne Sensor / without sensor Füllmedium: Bremsflüssigkeit / Fill Medium: Brake Fluid	(105) (25)	
	01.02-10.04			3400 710 007 3482 000 463 1878 023 831 3182 998 501	395 18 MF395 395GTZ HHIS-3	ohne Sensor / without sensor Füllmedium: Bremsflüssigkeit / Fill Medium: Brake Fluid	(105) (25)	
				3400 710 009 3482 000 464 1878 023 931 3182 600 101	395 18 MF395 395GTZ HHIS-3	mit Sensor / with sensor Füllmedium: Bremsflüssigkeit / Fill Medium: Brake Fluid	(92) (25)	
				3400 710 010 3482 000 463 1878 023 831 3182 600 101	395 18 MF395 395GTZ HHIS-3	mit Sensor / with sensor Füllmedium: Bremsflüssigkeit / Fill Medium: Brake Fluid	(92) (25)	
				3182 998 501	HHIS-3		für / for: SA504673-06/10 für / for: SA504673-07/22 ohne Sensor / without sensor Füllmedium: Bremsflüssigkeit / Fill Medium: Brake Fluid Immer erneuern / Renew everytime	(69) (69) (105) (25)
				3182 600 101	HHIS-3		für / for: SA504673-08/11 mit Sensor / with sensor Füllmedium: Bremsflüssigkeit / Fill Medium: Brake Fluid Immer erneuern / Renew everytime	(69) (92) (25)
								(30)

		CODE				
--	--	-------------	--	---	---	---

MERCEDES-BENZ

AXOR 3028 - 4144		09.01 -					
3131 3131 K	01.11- 01.11-	OM457.962, OM457.948, OM457.910,	 3400 122 801 ⊕ ⊗ 3483 030 032 ⊙ 1878 007 072	430 18 MFZ430 430WGTZ	für / for: SA 531129-04/05		(69)
3235 940.365 3335 B 943.162/163 3335 K 942.165 374.695 942.163 942.167 942.162	10.04- 10.04-10.05 06.09- 09.08-	OM457.918, OM457.956, OM457.957, OM457.937, OM457.917	 3400 700 446 ⊕ ⊗ 3483 000 258 ⊙ 1878 007 072	430 18 MFZ430 430WGTZ	für / for: SA 504682-24		(69)
3340 B 943.163 943.162 3343 K 958.478 958.471 942.167 958.472 3343 S 958.478 958.471/472 3344 3344 K 3344 S 3535 K 4141 K 4144 4144 K 4143 K	10.04-10.05 10.11- 10.11- 10.04- 10.04- 10.04- 06.09- 01.11- 01.06-12.11 10.04- 01.11-		 1863 869 028				
			 3189 600 058		für / for: SA 5046831/03 Nebenantriebs-ID / PTO ID: NMV		(69) (50)
			3189 600 059				
3236 B 943.304/305 3236 K 942.304/305 942.307 3240 940.365 3240 B 943.304/305 3240 K 942.305 942.304 942.307 3243 940.365 3243 B 943.304/305 3243 K 942.304 942.307 942.305 4135 B 943.314 943.317 4135 K 942.314/315 942.317 4140 B 943.314 943.317 4140 K 942.315 942.314 942.317 4143 B 943.317 943.314 4143 K 942.314/315 942.317	10.04- 10.04- 03.05- 10.04- 10.04- 10.04- 10.04- 10.04- 10.05- 06.09- 01.11- 06.09- 06.09- 01.11- 06.09-	OM457.980, OM457.981, OM457.948, OM457.956, OM457.957, OM457.937	 3400 122 801 ⊕ ⊗ 3483 030 032 ⊙ 1878 007 072	430 18 MFZ430 430WGTZ			
			 3400 121 501 ⊕ ⊗ 3488 023 031 ⊙ 1878 002 024	400 18 MFZ2/400X 400WGTZ	Nabenprofil / Hub Profile: 45x50-18N für Fahrzeuge mit Zweischeibenkupplung / for vehicles with double disc clutch		(48) (77)
			 1863 869 028				
			 3189 600 058		für / for: SA 5046831/03 Nebenantriebs-ID / PTO ID: NMV		(69) (50)
			3189 600 059				
3335 940.163 3340, 3341 958.471 958.478 940.163 958.472 3343 B 943.163 943.162 3340 K, 3341 K 958.471 942.162 958.478 958.472 942.165 942.161 942.163 942.167 3343 940.163	10.04- 10.04- 10.04- 10.04- 10.04-	OM457.910, OM457.918, OM457.956, OM457.957, OM457.937, OM457.917	 3400 122 801 ⊕ ⊗ 3483 030 032 ⊙ 1878 007 072	430 18 MFZ430 430WGTZ			
			 3400 121 501 ⊕ ⊗ 3488 023 031 ⊙ 1878 002 024	400 18 MFZ2/400X 400WGTZ	für / for: SA 504682-13 für / for: SA 591014-04 Nabenprofil / Hub Profile: 45x50-18N für Fahrzeuge mit Zweischeibenkupplung / for vehicles with double disc clutch		(69) (69) (48) (77)
			 1863 869 028				
			 3189 600 058		für / for: SA 5046831/03 Nebenantriebs-ID / PTO ID: NMV		(69) (50)
			3189 600 059				















































































MERCEDES-BENZ

AXOR 3028 - 4144		09.01 -				
3340 S, 3341 S 958.472 958.478 958.471 944.161	06.09-	OM457.962, OM457.910, OM457.918, OM457.956, OM457.957, OM457.917		3400 700 355 ⊕ ⊗ 3488 000 158 ⊗ 1878 002 019	400 18 MFZ2/400X 400WGTZ	
3344 K 958.478 958.471 942.162 958.472	01.11-			3189 600 059		
4140 958.478 958.471/472	01.11-			3189 600 058		für / for: SA 5046831/03 Nebenantriebs-ID / PTO ID: NMV
4144 958.472 958.471 958.478	01.11-					(69) (50)

ECONIC		01.98 -				
1823 L, 1823 LL 957.542/543 957.540/541	03.98-	OM906.951, OM906.941, M902.900, OM926.934, OM902.927, OM902.933, OM926LAG, OM906.952, M902.903, OM906.940, OM926.924, OM906.924		3400 700 615 ⊕ ⊗ 3483 030 031 ⊗ 1878 002 731	430 18 MFZ430 430GTZ	
1824 L, 1824 LL 957.540 957.542/543 957.541 957.545	10.06-			3400 700 617 ⊕ ⊗ 3483 000 258 ⊗ 1878 002 731	430 18 MFZ430 430GTZ	für / for: SA504657-30
1828 L, 1828 LL 957.540/541 957.543 957.542	03.98-			6284 605 064		->Chass. V207092 Füllmedium: Bremsflüssigkeit / Fill Medium: Brake Fluid
1828 L, 1828 LL 957.543 957.545 957.540 957.542 957.541	10.06-			6284 605 065		Chass. V207093-> Füllmedium: Mineralöl / Fill Medium: Mineral Oil
1828 LLS 957.582	10.00-			3189 600 058		Nebenantriebs-ID / PTO ID: NMV
1829 L, 1829 LL 957.542 957.545 957.540 957.543 957.541	10.06-			3189 600 058		(25)
1833 L, 1833 LL 957.540/541 957.543 957.542 957.545	10.06-			3189 600 059		(26) (50)
2628 LL 957.656 957.662 957.661 957.657 957.654 957.660 957.653 957.664 957.663 957.666	03.98-					
2628 LL 957.681/682	01.98-					
2628 NGT 957.660						
2629 L, 2629 LL 957.657 957.660 957.654 957.656 957.663 957.661/662 957.653 957.664	10.01-					
2629 L, 2629 LL 957.682 957.681	10.01-					
2633 L, 2633 LL 957.657 957.661/662 957.654 957.663/664 957.656 957.660 957.653	10.07-					
2633 LL 957.681/682	10.07-					
3233 L, 3233 LL 957.382	10.07-					













		CODE				
--	--	------	--	---	---	---











MERCEDES-BENZ

ECONIC		01.98 -						
1828 L 957.543 1829 LS 957.582 1828 LS 957.582 1833 LS 957.582 2624 L 957.660 957.664 2628 L 957.653 957.661 957.657 957.654 957.660 957.662 957.656 957.663/664 2628 L 957.657 957.663 957.661 957.653/654 957.662 957.656 957.664 2628 L 957.681/682 2633 L 957.682 957.681	10.00-	OM904		3400 127 701   3482 000 462  1878 052 842	362 18 MF362 362WGTB			
	10.07-			3400 700 484 HD   3482 000 462  1878 006 757	362 18 MF362 362WGTB			
	10.04-			3400 710 005   3482 000 462  1878 052 842  3182 998 501	362 18 MF362 362WGTB HHIS-3	ohne Sensor / without sensor Füllmedium: Bremsflüssigkeit / Fill Medium: Brake Fluid	(105) (25)	
	10.07-			3400 710 008   3482 000 462  1878 052 842  3182 600 101	362 18 MF362 362WGTB HHIS-3	mit Sensor / with sensor Füllmedium: Bremsflüssigkeit / Fill Medium: Brake Fluid	(92) (25)	
	03.98-			3400 700 397   3482 000 463  1878 004 232	395 18 MF395 395WGTZ	für / for: SA 504672/22	(69)	
	10.00-		OM906		3400 121 201   3482 000 464  1878 023 931	395 18 MF395 395GTZ		
	10.00-				3400 710 006   3482 000 464  1878 023 931  3182 998 501	395 18 MF395 395GTZ HHIS-3	ohne Sensor / without sensor Füllmedium: Bremsflüssigkeit / Fill Medium: Brake Fluid	(105) (25)
	10.01-				3400 710 007 HD   3482 000 463  1878 023 831  3182 998 501	395 18 MF395 395GTZ HHIS-3	für Fahrzeuge mit Kupplungskraftverstärker / for vehicles with clutch booster ohne Sensor / without sensor Füllmedium: Bremsflüssigkeit / Fill Medium: Brake Fluid	(73) (105) (25)
	10.01-				3400 710 009   3482 000 464  1878 023 931  3182 600 101	395 18 MF395 395GTZ HHIS-3	mit Sensor / with sensor Füllmedium: Bremsflüssigkeit / Fill Medium: Brake Fluid	(92) (25)
	10.01-			3400 710 010 HD   3482 000 463  1878 023 831  3182 600 101	395 18 MF395 395GTZ HHIS-3	für Fahrzeuge mit Kupplungskraftverstärker / for vehicles with clutch booster mit Sensor / with sensor Füllmedium: Bremsflüssigkeit / Fill Medium: Brake Fluid	(73) (92) (25)	
	10.01-			3400 710 012   3482 000 464  1878 023 931  3182 600 172	395 18 MF395 395GTZ	für / for: SA 504673/26 Kabellänge [mm] / Cable Length [mm]: 220 mit Sensor / with sensor Füllmedium: Mineralöl / Fill Medium: Mineral Oil	(69) (36) (92) (26)	
	10.01-			3400 710 013 HD   3482 000 463  1878 023 831  3182 600 172	395 18 MF395 395GTZ	für / for: SA 504673/26 Kabellänge [mm] / Cable Length [mm]: 220 für Fahrzeuge mit Kupplungskraftverstärker / for vehicles with clutch booster mit Sensor / with sensor Füllmedium: Mineralöl / Fill Medium: Mineral Oil	(69) (36) (73) (92) (26)	
	10.01-			3400 710 015   3482 000 464  1878 023 931  3182 600 166	395 18 MF395 395GTZ	mit Sensor / with sensor Füllmedium: Mineralöl / Fill Medium: Mineral Oil	(92) (26)	
	10.01-			3400 710 014 HD   3482 000 463  1878 023 831  3182 600 166	395 18 MF395 395GTZ	für Fahrzeuge mit Kupplungskraftverstärker / for vehicles with clutch booster mit Sensor / with sensor Füllmedium: Mineralöl / Fill Medium: Mineral Oil	(73) (92) (26)	
	10.01-			3400 710 016   3482 000 464  1878 023 931  3182 600 141	395 18 MF395 395GTZ	ohne Sensor / without sensor Füllmedium: Mineralöl / Fill Medium: Mineral Oil	(105) (26)	
	10.01-		3400 710 017 HD   3482 000 463  1878 023 831  3182 600 141	395 18 MF395 395GTZ	für Fahrzeuge mit Kupplungskraftverstärker / for vehicles with clutch booster ohne Sensor / without sensor Füllmedium: Mineralöl / Fill Medium: Mineral Oil	(73) (105) (26)		

		CODE				
--	--	------	--	---	---	---



























MERCEDES-BENZ

ECONIC 2		04.13 -						
1830 LL 956.005 956.008 956.001 956.004 956.003 2630 LL 956.063/064 2630 LL 956.033 956.053 956.035/036 956.031 956.034	04.13-	OM936		3400 700 533 	430 18	XTend Nabenprofil / Hub Profile: 45x50-18N Euro 6 / Euro 6 Nur zusammen verbauen / Only install together	(48) (18) (53)	
	04.13-			3400 700 531 	430 18	XTend Getr. / GBox: Powershift Nabenprofil / Hub Profile: 45x50-18N Euro 6 / Euro 6 Nur zusammen verbauen / Only install together	(48) (18) (53)	
	04.13-			3400 710 071 	430 18	Getr. / GBox: Powershift Nabenprofil / Hub Profile: 45x50-18N Euro 6 / Euro 6 mit automatischer Nachstellung / with automatic adjustment Nur zusammen verbauen / Only install together	(48) (18) (95) (53)	
					6482 000 218	PHIS-6/38	Getr. / GBox: Powershift Euro 6 / Euro 6 Immer erneuern / Renew everytime	(18) (30)
1835 LL 956.008 956.001 956.004/005 956.003 2635 LL 956.031 956.035/036 956.033 956.053 956.034 2635 LL 956.063/064	04.13-	OM936		3400 700 532 	430 18	XTend Nabenprofil / Hub Profile: 45x50-18N Euro 6 / Euro 6 Nur zusammen verbauen / Only install together	(48) (18) (53)	
	04.13-			3400 700 530 	430 18	XTend Getr. / GBox: Powershift Nabenprofil / Hub Profile: 45x50-18N Euro 6 / Euro 6 Nur zusammen verbauen / Only install together	(48) (18) (53)	
	04.13-				3400 710 070 	430 18	Getr. / GBox: Powershift Nabenprofil / Hub Profile: 45x50-18N Euro 6 / Euro 6 mit automatischer Nachstellung / with automatic adjustment Nur zusammen verbauen / Only install together	(48) (18) (95) (53)
					6482 000 218	PHIS-6/38	Getr. / GBox: Powershift Euro 6 / Euro 6 Immer erneuern / Renew everytime	(18) (30)

Unimog 20-100							
U 20 405.050	09.06-	OM900.915		3400 127 701 	362 18		
				3400 710 008	362 18	mit Sensor / with sensor Füllmedium: Bremsflüssigkeit / Fill Medium: Brake Fluid	(92) (25)
U 40 421.123 421.122 U 45 421.123 421.122	01.66 - 04.71	OM621.931, OM615.911		1882 231 131 #	250		
	01.66 - 04.71			1861 840 133 #	250 10	Nur bei Altteil-Rückgabe lieferbar (Reparatur; Werk Bielefeld) / Please return old unit for repair (plant Bielefeld)	(51)
				1863 840 001	GR-3	ohne Anlauffring / without thrust ring	(102)
				1888 893 001 #	225 24	für / for: SA35334 01 für / for: SA35452 01 für Fahrzeuge mit Zweischeibenkupplung / for vehicles with double disc clutch enthält eine Kupplungsscheibe / This part number includes one clutch disc	(69) (69) (77) (67)
				1878 634 076 ▽	240 10	für / for: SA35334 01 für / for: SA35452 01 für Fahrzeuge mit Zweischeibenkupplung / for vehicles with double disc clutch Lose Kupplungsscheibe / Loose clutch disc	(69) (69) (77) (41)
				1862 718 002 ▽#	240 10	für / for: SA35334 01 für / for: SA35452 01 für Fahrzeuge mit Zweischeibenkupplung / for vehicles with double disc clutch Nur bei Altteil-Rückgabe lieferbar (Reparatur; Werk Bielefeld) / Please return old unit for repair (plant Bielefeld) Lose Kupplungsscheibe / Loose clutch disc	(69) (69) (77) (51) (41)
				1863 869 010	35	Kugellager / Ball Bearing	(38)























		CODE				
--	--	------	--	---	---	---

MERCEDES-BENZ

Unimog 20-100						
U 52 421.122-163 U 60,T 421.122-163			 1882 231 131 #	250 G250		
			 1861 840 133 #	250 10 250TPZ	Nur bei Altteil-Rückgabe lieferbar (Reparatur; Werk Bielefeld) / Please return old unit for repair (plant Bielefeld)	(51)
			 1863 840 001	GR-3	ohne Anlauffring / without thrust ring	(102)
			 1888 893 001 #	225 24 DOT240	Chass. 002949 - Chass. 166589 enthält eine Kupplungsscheibe / This part number includes one clutch disc	(67)
			 1878 634 076 ▽	240 10 240CC	Chass. 002949 - Chass. 166589 Lose Kupplungsscheibe / Loose clutch disc	(41)
			 1862 718 002 ▽#	240 10 240CC	Chass. 002949 - Chass. 166589 Lose Kupplungsscheibe / Loose clutch disc Nur bei Altteil-Rückgabe lieferbar (Reparatur; Werk Bielefeld) / Please return old unit for repair (plant Bielefeld)	(41) (51)
			 1863 837 003	GR-4	Chass. 002949 - Chass. 166589 ohne Anlauffring / without thrust ring	(102)
			U 54 403.120/121	04.66 - 03.72	OM314.916	 1888 877 101 #
 1882 229 131 #	280 G280	-> Chass. 088736				
 1861 518 031 #	280 10 280BDC	-> Chass. 088736 Anzahl der Beläge / Number of pads: 6				(3)
 1861 611 131 ●#	280 10 280B/Z	-> Chass. 088736				
 1863 840 001	GR-3	-> Chass. 088736 ohne Anlauffring / without thrust ring				(102)
 3482 008 032	310 MF310	Chass. 088737->				
 1861 384 334 #	310 10 310GSZ	Chass. 088737->				
 1863 840 001	GR-3	Chass. 088737-> ohne Anlauffring / without thrust ring				(102)
U 55,T 421.130/131			 1882 231 131 #	250 G250		
			 1861 840 133 #	250 10 250TPZ	Nur bei Altteil-Rückgabe lieferbar (Reparatur; Werk Bielefeld) / Please return old unit for repair (plant Bielefeld)	(51)
			 1863 840 001	GR-3	ohne Anlauffring / without thrust ring	(102)
U 65 T, U 70 T 406.130/131	01.62 - 01.88	OM352.919	 1888 877 101 #	280 DOT280	Chass. 009059 - Chass. 088736 406.130 enthält zwei Kupplungsscheiben / This part number includes both clutch discs	(68)
			 1882 229 131 #	280 G280	-> Chass. 088736	
			 1861 518 031 #	280 10 280BDC	-> Chass. 088736 Anzahl der Beläge / Number of pads: 6	(3)
			 1861 611 131 ●#	280 10 280B/Z	-> Chass. 088736	
			 1863 840 001	GR-3	-> Chass. 088736 ohne Anlauffring / without thrust ring	(102)
			 3482 008 032	310 MF310	Chass. 088737->	
			 1861 384 334 #	310 10 310GSZ	Chass. 088737->	
			 1863 840 001	GR-3	Chass. 088737-> ohne Anlauffring / without thrust ring	(102)

		CODE				
--	--	------	--	---	---	---

MERCEDES-BENZ

Unimog 20-100							
U 65, U 70 406.120/121 U 65, U 70 406.121 406.120	01.62-01.88	OM352.919, OM312.954		1888 877 101 #	280 DOT280	Chass. 009059 - Chass. 088736 für Fahrzeuge mit Zweis Scheibenkupplung / for vehicles with double disc clutch enthält zwei Kupplungsscheiben / This part number includes both clutch discs (77)	
	01.62-01.88			1882 229 131 #	280 G280	->Chass. 088736 (68)	
					1861 518 031 #	280 10 280BDC	->Chass. 088736 Anzahl der Beläge / Number of pads: 6 (3)
					1861 611 131 ●#	280 10 280B/Z	->Chass. 088736
					1863 840 001	GR-3	->Chass. 088736 ohne Anlauftring / without thrust ring (102)
					3482 008 032	310 MF310	Chass. 088737->
					1861 384 334 #	310 10 310GSZ	Chass. 088737->
					1863 840 001	GR-3	Chass. 088737-> ohne Anlauftring / without thrust ring (102)
					1888 877 102 #	280 24 DOT280	Chass. 088737-> für Fahrzeuge mit Zweis Scheibenkupplung / for vehicles with double disc clutch enthält eine Kupplungsscheibe / This part number includes one clutch disc (77)
					1861 966 141 ▽#	280 10 280GSPD CE/ CERAM	Chass. 088737-> für Fahrzeuge mit Zweis Scheibenkupplung / for vehicles with double disc clutch Lose Kupplungsscheibe / Loose clutch disc (77)
					1863 837 003	GR-4	Chass. 088737-> für Fahrzeuge mit Zweis Scheibenkupplung / for vehicles with double disc clutch ohne Anlauftring / without thrust ring (77)
	U 66, U 72 403.123 403.122	03.69-01.88	OM314.917		1882 229 131 #	280 G280	->Chass. 088736
				1861 518 031 #	280 10 280BDC	->Chass. 088736 Anzahl der Beläge / Number of pads: 6 (3)	
				1861 611 131 ●#	280 10 280B/Z	->Chass. 088736	
				1863 840 001	GR-3	->Chass. 088736 ohne Anlauftring / without thrust ring (102)	
				3482 008 032	310 MF310	Chass. 088737->	
				1861 384 334 #	310 10 310GSZ	Chass. 088737->	
				1863 840 001	GR-3	Chass. 088737-> ohne Anlauftring / without thrust ring (102)	
				1888 877 101 #	280 DOT280	Chass. 000760 - Chass. 088736 enthält zwei Kupplungsscheiben / This part number includes both clutch discs (68)	
				1888 877 102 #	280 24 DOT280	Chass. 088737-> enthält eine Kupplungsscheibe / This part number includes one clutch disc (67)	
				1861 966 141 ▽#	280 10 280GSPD CE/ CERAM	Chass. 088737-> Lose Kupplungsscheibe / Loose clutch disc (41)	
				1863 837 003	GR-4	Chass. 088737-> ohne Anlauftring / without thrust ring (102)	



CODE



SACHS

Parameter























MERCEDES-BENZ

Unimog 20-100

U 72 ,U 80 413.110/111	01.69-01.77	OM314.917	1882 229 131 #	280 G280	->Chass. 088736	
			1861 518 031 #	280 10 280BDC	->Chass. 088736 Anzahl der Beläge / Number of pads: 6	(3)
			1861 611 131 ●#	280 10 280B/Z	->Chass. 088736	
			1863 840 001	GR-3	->Chass. 088736 ohne Anlauftring / without thrust ring	(102)
			3482 008 032	310 MF310	Chass. 088737->	
			1861 384 334 #	310 10 310GSZ	Chass. 088737->	
			1863 840 001	GR-3	Chass. 088737-> ohne Anlauftring / without thrust ring	(102)
			1888 877 101 #	280 DOT280	->Chass. 088736 enthält zwei Kupplungsscheiben / This part number includes both clutch discs	(68)
U 80 T, U 90 T 416.133 416.130 406.133	05.66-	OM352.903, OM352.984	1882 229 131 #	280 G280	->Chass. 088736	
			1861 518 031 #	280 10 280BDC	->Chass. 088736 Anzahl der Beläge / Number of pads: 6	(3)
			1861 611 131 ●#	280 10 280B/Z	->Chass. 088736	
			1863 840 001	GR-3	->Chass. 088736 ohne Anlauftring / without thrust ring	(102)
			3482 008 032	310 MF310	Chass. 088737->	
			1861 384 334 #	310 10 310GSZ	Chass. 088737->	
			1863 840 001	GR-3	Chass. 088737-> ohne Anlauftring / without thrust ring	(102)







		CODE				
--	--	------	--	---	---	---





















MERCEDES-BENZ

Unimog 20-100									
U 80, U 84, U 90 416.125 406.121 416.122 416.124 416.123 416.127 416.126	05.69-01.88	OM352.903, OM353.902		1888 877 101 #	280 DOT280	Chass. 009059 - Chass. 088736 406.121 für Fahrzeuge mit Zweischeibenkupplung / for vehicles with double disc clutch enthält zwei Kupplungsscheiben / This part number includes both clutch discs (77) (68)			
				1882 229 131 #	280 G280	->Chass. 088736 406.121/122-125			
				1861 518 031 #	280 10 280BDC	->Chass. 088736 406.121/122-125 Anzahl der Beläge / Number of pads: 6 (3)			
				1861 611 131 ●#	280 10 280B/Z	->Chass. 088736 406.121/122-125			
				1863 840 001	GR-3	->Chass. 088736 406.121/122-125 ohne Anlauffring / without thrust ring (102)			
				3482 008 032	310 MF310	Chass. 088737-> 406.121/122-125			
				1861 384 334 #	310 10 310GSZ	Chass. 088737-> 406.121/122-125			
				1863 840 001	GR-3	Chass. 088737-> 406.121/122-125 ohne Anlauffring / without thrust ring (102)			
				1888 877 102 #	280 24 DOT280	Chass. 088737-> 406.121 für Fahrzeuge mit Zweischeibenkupplung / for vehicles with double disc clutch enthält eine Kupplungsscheibe / This part number includes one clutch disc (77) (67)			
				1861 966 141 ▽#	280 10 280GSPD CE/ CERAM	Chass. 088737-> 406.121 für Fahrzeuge mit Zweischeibenkupplung / for vehicles with double disc clutch Lose Kupplungsscheibe / Loose clutch disc (77) (41)			
				1863 837 003	GR-4	Chass. 088737-> 406.121 für Fahrzeuge mit Zweischeibenkupplung / for vehicles with double disc clutch ohne Anlauffring / without thrust ring (77) (102)			
				1882 229 131 #	280 G280	->Chass. 003772 406.126-127			
				1861 518 031 #	280 10 280BDC	->Chass. 003772 406.126-127 Anzahl der Beläge / Number of pads: 6 (3)			
				1861 611 131 ●#	280 10 280B/Z	->Chass. 003772 406.126-127			
				1863 840 001	GR-3	->Chass. 003772 406.126-127 ohne Anlauffring / without thrust ring (102)			
				1882 282 331	310 GFX310	Chass. 003773 - Chass. 088736 406.126-127 Nur bei Altteil-Rückgabe lieferbar (Reparatur; Werk Bielefeld) / Please return old unit for repair (plant Bielefeld) (51)			
				1861 384 334 #	310 10 310GSZ	Chass. 003773 - Chass. 088736 406.126-127			
				1863 840 001	GR-3	Chass. 003773 - Chass. 088736 406.126-127 ohne Anlauffring / without thrust ring (102)			
			U 84 406.143 406.142 406.145				1882 282 331	310 GFX310	Chass. 003773 - Chass. 088736 Nur bei Altteil-Rückgabe lieferbar (Reparatur; Werk Bielefeld) / Please return old unit for repair (plant Bielefeld) (51)
							1861 384 334 #	310 10 310GSZ	Chass. 003773 - Chass. 088736
	1863 840 001	GR-3				Chass. 003773 - Chass. 088736 ohne Anlauffring / without thrust ring (102)			

		CODE				
--	--	------	--	---	---	---





























MERCEDES-BENZ

Unimog 20-100						
U 84 (406)				1888 067 042 #	330 22 DUT330/ 310	enthält eine Kupplungsscheibe / This part number includes one clutch disc enthält Druckplattenbefestigungsschrauben / includes bolt for pressure plate mounting (67)
				1861 741 042 ▽#	327 20 327GSDC	Anzahl der Beläge / Number of pads: 8 Lose Kupplungsscheibe / Loose clutch disc (3) (41)
				1863 837 002	GR-4	mit Anlauftring / with thrust ring (88)
				1863 855 000	GR-8	mit Anlauftring / with thrust ring (88)
U 90 408.101	07.96-	OM602		3082 269 031	250 M250	408.101
				3182 002 132	HHIS-3	408.101 Immer erneuern / Renew everytime (30)
U 94 403.120-123				1888 877 101 #	280 DOT280	Chass. 000760 - Chass. 088736 enthält zwei Kupplungsscheiben / This part number includes both clutch discs (68)

Unimog 100-500						
411	01.52-			1881 089 009 ▲	225 K225	
				1862 088 131 #	225 10 225B/Z	Nur bei Altteil-Rückgabe lieferbar (Reparatur; Werk Bielefeld) / Please return old unit for repair (plant Bielefeld) (51)
				1859 600 001	GR.I/ZL	
				1805 042 000		
S	01.54-			1862 088 131 #	225 10 225B/Z	Nur bei Altteil-Rückgabe lieferbar (Reparatur; Werk Bielefeld) / Please return old unit for repair (plant Bielefeld) (51)
				3151 021 001	KTI-1	
				3130 010 100		
U 100,L,T 416.122-163 U 110,L,T 416.122-163 U 125 416.122-163				3482 008 032	310 MF310	Chass. 088737->
				1861 384 334 #	310 10 310GSZ	Chass. 088737->
				1863 840 001	GR-3	Chass. 088737-> ohne Anlauftring / without thrust ring (102)
U 100,L,T 416.140-163 416.114-117 416.134/135 416.130-135 416.160 416.122-125				1882 229 131 #	280 G280	->Chass. 088736 416.122-125/130-135/160
				1861 611 131 ●#	280 10 280B/Z	->Chass. 088736 416.122-125/130-135/160
				1861 518 031 #	280 10 280BDC	->Chass. 088736 416.122-125/130-135/160 Anzahl der Beläge / Number of pads: 6 (3)
				1863 840 001	GR-3	ohne Anlauftring / without thrust ring (102)
				1882 282 331	310 GFX310	->Chass. 088736 416.114-117/140-163 Nur bei Altteil-Rückgabe lieferbar (Reparatur; Werk Bielefeld) / Please return old unit for repair (plant Bielefeld) (51)
				1861 384 334 #	310 10 310GSZ	->Chass. 088736 416.114-117/140-163
				1863 840 001	GR-3	->Chass. 088736 416.122-125/130-135/160/114-117/140-163 ohne Anlauftring / without thrust ring (102)
				1888 877 101 #	280 DOT280	Chass. 000562 - Chass. 088736 416.114-117/134-135/140-163 enthält zwei Kupplungsscheiben / This part number includes both clutch discs (68)
				1888 877 102 #	280 24 DOT280	Chass. 088737 - Chass. 166589 416.114-117/134-135/140-163 enthält eine Kupplungsscheibe / This part number includes one clutch disc (67)
				1888 877 103 #	280 24 DOT280	Chass. 166590-> 416.114-117/134-135/140-163 enthält eine Kupplungsscheibe / This part number includes one clutch disc (67)
				1861 966 141 ▽#	280 10 280GSPD CE/ CERAM	Chass. 088737-> 416.114-117/134-135/140-163 Lose Kupplungsscheibe / Loose clutch disc (41)





















		CODE				
--	--	------	--	---	---	---

MERCEDES-BENZ

Unimog 100-500						
U 100L 408.215	11.92-	OM602	 3082 157 031	240 M240	408.215	
			 1862 538 031	242 10 242VTZC	408.215 Anzahl der Beläge / Number of pads: 4 Nur bei Altteil-Rückgabe lieferbar (Reparatur; Werk Bielefeld) / Please return old unit for repair (plant Bielefeld)	(3) (51)
			 3151 069 032 ▲	KZIS-1	408.215	
U 100L 408.216	07.96-	OM602LA	 3082 269 031	250 M250	408.216	
			 3151 069 032 ▲	KZIS-1	408.216	
U 110,L,T 416.140/141			 1882 231 131 #	250 G250		
			 1861 840 133 #	250 10 250TPZ	Nur bei Altteil-Rückgabe lieferbar (Reparatur; Werk Bielefeld) / Please return old unit for repair (plant Bielefeld)	(51)
			 1863 840 001	GR-3	ohne Anlauftring / without thrust ring	(102)
U 110,L,T 416.122-125 416.140-163 416.130-135 416.134/135 416.114-117 416.160			 1882 229 131 #	280 G280	->Chass. 088736 416.122-125/130-135/160	
			 1861 518 031 #	280 10 280BDC	->Chass. 088736 416.122-125/130-135/160 Anzahl der Beläge / Number of pads: 6	(3)
			 1861 611 131 ●#	280 10 280B/Z	->Chass. 088736 416.122-125/130-135/160	
			 1863 840 001	GR-3	->Chass. 088736 416.114-117/140-163 ohne Anlauftring / without thrust ring	(102)
			 1882 282 331	310 GFX310	->Chass. 088736 416.114-117/140-163 Nur bei Altteil-Rückgabe lieferbar (Reparatur; Werk Bielefeld) / Please return old unit for repair (plant Bielefeld)	(51)
			 1861 384 334 #	310 10 310GSZ	->Chass. 088736 416.114-117/140-163	
			 1863 840 001	GR-3	->Chass. 088736 416.122-125/130-135/160/114-117/140-163 ohne Anlauftring / without thrust ring	(102)
			 1888 877 102 #	280 24 DOT280	Chass. 088737 - Chass. 166589 416.114-117/134-135/140-163 enthält eine Kupplungsscheibe / This part number includes one clutch disc	(67)
			 1888 877 103 #	280 24 DOT280	Chass. 166590-> 416.114-117/134-135/140-163 enthält eine Kupplungsscheibe / This part number includes one clutch disc	(67)
			 1861 966 141 ▽#	280 10 280GSPD CE/ CERAM	416.114-117/134-135/140-163 Lose Kupplungsscheibe / Loose clutch disc	(41)
			 1888 067 042 #	330 22 DUT330/ 310	enthält eine Kupplungsscheibe / This part number includes one clutch disc enthält Druckplattenbefestigungsschrauben / includes bolt for pressure plate mounting	(67) (65)
			 1861 741 042 ▽#	327 20 327GSDC	Anzahl der Beläge / Number of pads: 8 Lose Kupplungsscheibe / Loose clutch disc	(3) (41)
			 1863 837 002	GR-4	mit Anlauftring / with thrust ring	(88)
			 1863 855 000	GR-8	mit Anlauftring / with thrust ring	(88)
U 110,U 110L 418.100 418.115	02.92-	OM364.958, OM364.955	 3482 012 211	330 GMF330		
			 1878 634 071	330 10 330TB		
			 3182 002 131	HHIS-3	Immer erneuern / Renew everytime	(30)
			 1888 998 201 #	330 24 DUT330	für Fahrzeuge mit Niederdruck-Bremsanlage / for vehicles with low-pressure brakesystem enthält eine Kupplungsscheibe / This part number includes one clutch disc	(74) (67)
			 1888 067 031 #	330 24 DUT330	Chass. 183541-> enthält eine Kupplungsscheibe / This part number includes one clutch disc	(67)
			 1878 634 071 ▽	330 10	Chass. 183541->	





























		CODE				
--	--	------	--	---	---	---

MERCEDES-BENZ

Unimog 100-500						
U 120 U 125 (425) U 150 (425)				1888 067 042 #	330 22 DUT330/ 310	enthält eine Kupplungsscheibe / This part number includes one clutch disc enthält Druckplattenbefestigungsschrauben / includes bolt for pressure plate mounting (67)
				1861 741 042 ▽#	327 20 327GSDC	Anzahl der Beläge / Number of pads: 8 Lose Kupplungsscheibe / Loose clutch disc (3) (41)
				1863 837 002	GR-4	mit Anlauftring / with thrust ring (88)
				1863 855 000	GR-8	mit Anlauftring / with thrust ring (88)
U 125 416.140-163 416.114-117 416.134/135				1882 282 331	310 GFX310	-> Chass. 088736 416.114-117/140-163 Nur bei Alteil-Rückgabe lieferbar (Reparatur; Werk Bielefeld) / Please return old unit for repair (plant Bielefeld) (51)
				1861 384 334 #	310 10 310GSZ	-> Chass. 088736 416.114-117/140-163
				1863 840 001	GR-3	-> Chass. 088736 416.114-117/140-163 ohne Anlauftring / without thrust ring (102)
				1888 877 101 #	280 DOT280	Chass. 000562 - Chass. 088736 416.114-117/134-135/140-163 enthält zwei Kupplungsscheiben / This part number includes both clutch discs (68)
				1888 877 102 #	280 24 DOT280	Chass. 088737 - Chass. 166589 416.114-117/134-135/140-163 enthält eine Kupplungsscheibe / This part number includes one clutch disc (67)
				1888 877 103 #	280 24 DOT280	Chass. 166590-> 416.114-117/134-135/140-163 enthält eine Kupplungsscheibe / This part number includes one clutch disc (67)
				1861 966 141 ▽#	280 10 280GSPD CE/ CERAM	416.114-117/134-135/140-163 Lose Kupplungsscheibe / Loose clutch disc (41)
U 130,U 140 418.102 U 140T 418.000	07.92 -	OM364.985, OM364.982		3482 012 211	330 GMF330	für Fahrzeuge mit Einscheibenkupplung / for vehicles with single disc clutch (72)
	07.92 -			1878 634 071	330 10 330TB	für Fahrzeuge mit Einscheibenkupplung / for vehicles with single disc clutch (72)
				3182 002 131	HHIS-3	für Fahrzeuge mit Einscheibenkupplung / for vehicles with single disc clutch Immer erneuern / Renew everytime (30)
				1888 998 201 #	330 24 DUT330	-> Chass. 183540 für Fahrzeuge mit Niederdruck-Bremsanlage / for vehicles with low-pressure brakesystem enthält eine Kupplungsscheibe / This part number includes one clutch disc (74) (67)
				3182 002 131	HHIS-3	Immer erneuern / Renew everytime (30)
				1888 067 031 #	330 24 DUT330	enthält eine Kupplungsscheibe / This part number includes one clutch disc Sonderausführung / Special design (67) (60)
				1888 998 201 #	330 24 DUT330	für Fahrzeuge mit Niederdruck-Bremsanlage / for vehicles with low-pressure brakesystem enthält eine Kupplungsscheibe / This part number includes one clutch disc Sonderausführung / Special design (74) (67) (60)
				1878 634 071 ▽	330 10 330TB	Lose Kupplungsscheibe / Loose clutch disc Sonderausführung / Special design (41) (60)
				3182 003 131	HHIS-3	Sonderausführung / Special design Immer erneuern / Renew everytime (60) (30)































		CODE				
--	--	------	--	---	---	---

MERCEDES-BENZ

Unimog 100-500						
U 140L 418.117 418.237 418.217	07.92-	OM364.985		3482 012 211	330 GMF330	418.117 für Fahrzeuge mit Einscheibenkupplung / for vehicles with single disc clutch (72)
				1878 634 071	330 10 330TB	418.117 für Fahrzeuge mit Einscheibenkupplung / for vehicles with single disc clutch (72)
				3182 002 131	HHIS-3	418.117 für Fahrzeuge mit Einscheibenkupplung / for vehicles with single disc clutch Immer erneuern / Renew everytime (30)
				1888 998 201 #	330 24 DUT330	->Chass. 183540 418.117 für Fahrzeuge mit Niederdruck-Bremsanlage / for vehicles with low-pressure brakesystem enthält eine Kupplungsscheibe / This part number includes one clutch disc (74) (67)
				3182 002 131	HHIS-3	418.117 Immer erneuern / Renew everytime (30)
				1888 067 031 #	330 24 DUT330	418.117 enthält eine Kupplungsscheibe / This part number includes one clutch disc Sonderausführung / Special design (67) (60)
				1888 998 201 #	330 24 DUT330	418.117 für Fahrzeuge mit Niederdruck-Bremsanlage / for vehicles with low-pressure brakesystem enthält eine Kupplungsscheibe / This part number includes one clutch disc Sonderausführung / Special design (74) (67) (60)
				1878 634 071 ▽	330 10 330TB	418.117 Lose Kupplungsscheibe / Loose clutch disc Sonderausführung / Special design (41) (60)
				3182 003 131	HHIS-3	418.117 Sonderausführung / Special design Immer erneuern / Renew everytime (60) (30)
U 216 405.090 U 218 405.090	05.13-	OM934		3400 700 621  3482 000 463  1878 007 732	395 18 MF395 395WGTZ	405.090
	05.13-			3182 600 101	HHIS-3	405.090 mit Sensor / with sensor Füllmedium: Bremsflüssigkeit / Fill Medium: Brake Fluid Immer erneuern / Renew everytime (92) (25) (30)
				1863 869 044	55	405.090
U 300 405.101 405.100 U 300 405.120/121	03.00-	OM904.927, OM904.928		3482 000 462	362 MF362	für Fahrzeuge mit Einscheibenkupplung / for vehicles with single disc clutch (72)
	03.00-			1878 600 560	360 18 360CBC	für Fahrzeuge mit Einscheibenkupplung / for vehicles with single disc clutch Anzahl der Beläge / Number of pads: 9 (3) (72)
				3182 600 101	HHIS-3	für Fahrzeuge mit Einscheibenkupplung / for vehicles with single disc clutch mit Sensor / with sensor Füllmedium: Bremsflüssigkeit / Fill Medium: Brake Fluid Immer erneuern / Renew everytime (92) (25) (30)
				3400 127 701 ●  3482 000 462  1878 052 842	362 18 MF362 362WGTB	für Fahrzeuge mit Einscheibenkupplung / for vehicles with single disc clutch (72)
				1878 001 939 HD●	362 18 362WGTB	für Fahrzeuge mit Einscheibenkupplung / for vehicles with single disc clutch (72)
				3400 710 008 ●  3482 000 462  1878 052 842  3182 600 101	362 18 MF362 362WGTB HHIS-3	für Fahrzeuge mit Einscheibenkupplung / for vehicles with single disc clutch mit Sensor / with sensor Füllmedium: Bremsflüssigkeit / Fill Medium: Brake Fluid (92) (25)
				1888 916 001 #	350 24 DUT350	für Fahrzeuge mit Zweisheibenkupplung / for vehicles with double disc clutch enthält eine Kupplungsscheibe / This part number includes one clutch disc (77) (67)
				1878 992 401 #	350 20 350GSDC	für Fahrzeuge mit Zweisheibenkupplung / for vehicles with double disc clutch Anzahl der Beläge / Number of pads: 8 (77) (3)
				1863 837 002	GR-4	für Fahrzeuge mit Zweisheibenkupplung / for vehicles with double disc clutch mit Anlauffring / with thrust ring (77) (88)
				1863 855 000	GR-8	für Fahrzeuge mit Zweisheibenkupplung / for vehicles with double disc clutch mit Anlauffring / with thrust ring (77) (88)



















		CODE				
--	--	------	--	---	---	---











MERCEDES-BENZ

Unimog 100-500						
U 318 405.104	05.13-	OM934	 3400 700 621  3482 000 463  1878 007 732	395 18 MF395 395WGTZ	405.104	
			 3182 600 101	HHIS-3	405.104 mit Sensor / with sensor Füllmedium: Bremsflüssigkeit / Fill Medium: Brake Fluid Immer erneuern / Renew everytime	(92) (25) (30)
			 1863 869 044	55	405.104	
U 400 405.102/103	03.00-	OM904.928	 3482 000 462	362 MF362		
			 1878 600 560	360 18 360CBC	Anzahl der Beläge / Number of pads: 9	(3)
			 3182 600 101	HHIS-3	mit Sensor / with sensor Füllmedium: Bremsflüssigkeit / Fill Medium: Brake Fluid Immer erneuern / Renew everytime	(92) (25) (30)
			 3400 127 701 ●	 362 18 MF362 362WGTB		
			 3400 700 484 HD ●	 362 18 MF362 362WGTB		
			 3482 000 462  1878 052 842	MF362 362WGTB		
			 3400 710 008 ●	 362 18 MF362 362WGTB HHIS-3	mit Sensor / with sensor Füllmedium: Bremsflüssigkeit / Fill Medium: Brake Fluid	(92) (25)
			 1888 916 001 #	350 24 DUT350	für Fahrzeuge mit Zweis Scheibenkupplung / for vehicles with double disc clutch enthält eine Kupplungsscheibe / This part number includes one clutch disc	(77) (67)
			 1878 992 401 #	350 20 350GSDC	für Fahrzeuge mit Zweis Scheibenkupplung / for vehicles with double disc clutch Anzahl der Beläge / Number of pads: 8	(77) (3)
			 1863 837 002	GR-4	für Fahrzeuge mit Zweis Scheibenkupplung / for vehicles with double disc clutch mit Anlauftring / with thrust ring	(77) (88)
			 1863 855 000	GR-8	für Fahrzeuge mit Zweis Scheibenkupplung / for vehicles with double disc clutch mit Anlauftring / with thrust ring	(77) (88)
U 400 405.122/123 U 500, UGN NA 405.230 405.201 405.221 405.200 405.210 U 500, UGN NA 405.221 405.201 405.220 405.210 405.230	03.00-	OM906.935, OM906.967, OM906.955	 3482 000 463	395 MF395		
	10.00-		 1878 600 560	360 18 360CBC	Anzahl der Beläge / Number of pads: 9	(3)
	10.00-		 1878 052 842 ●	362 18 362WGTB		
			 1878 001 939 HD ●	362 18 362WGTB		
			 3182 600 101	HHIS-3	mit Sensor / with sensor Füllmedium: Bremsflüssigkeit / Fill Medium: Brake Fluid Immer erneuern / Renew everytime	(92) (25) (30)
			 1888 916 001 #	350 24 DUT350	für Fahrzeuge mit Zweis Scheibenkupplung / for vehicles with double disc clutch enthält eine Kupplungsscheibe / This part number includes one clutch disc	(77) (67)
			 1878 992 401 #	350 20 350GSDC	für Fahrzeuge mit Zweis Scheibenkupplung / for vehicles with double disc clutch Anzahl der Beläge / Number of pads: 8	(77) (3)
			 1863 837 002	GR-4	für Fahrzeuge mit Zweis Scheibenkupplung / for vehicles with double disc clutch mit Anlauftring / with thrust ring	(77) (88)
			 1863 855 000	GR-8	für Fahrzeuge mit Zweis Scheibenkupplung / for vehicles with double disc clutch mit Anlauftring / with thrust ring	(77) (88)
			 3151 000 396	KZIS-4	für OE-Nummer / for OE number 001 250 99 15 für OE-Nummer / for OE number 002 250 00 15	(83) (83)

		CODE				
--	--	------	--	---	---	---



















MERCEDES-BENZ

Unimog 100-500						
U 423 405.105 U 423 L 405.125	05.13-	OM934	 3400 700 621  3482 000 463  1878 007 732	395 18 MF395 395WGTZ	405.105	
	05.13-		 3182 600 101	HHIS-3	405.105 mit Sensor / with sensor Füllmedium: Bremsflüssigkeit / Fill Medium: Brake Fluid Immer erneuern / Renew everytime	(92) (25) (30)
			 1863 869 044	55	405.105	
U 427, U 427 L 405.110 405.125 U 430, U 430 L 405.125 405.110	05.13-	OM934/936	 3482 000 463	395 MF395	405.110/125	
	05.13-		 3182 600 101	HHIS-3	405.110/125 mit Sensor / with sensor Füllmedium: Bremsflüssigkeit / Fill Medium: Brake Fluid Immer erneuern / Renew everytime	(92) (25) (30)
			 1863 869 044	55	405.110/125	
U S 404 404.115 404.113/114	01.55- 12.76	M180.953, M180.952	 1862 088 131 #	225 10 225B/Z	Nur bei Altteil-Rückgabe lieferbar (Reparatur; Werk Bielefeld) / Please return old unit for repair (plant Bielefeld)	(51)
			 3151 021 001	KTI-1		
			 1863 869 010	35	Kugellager / Ball Bearing	(38)
U S 404 404.117	01.68-	OM615.911	 1882 231 131 #	250 G250		
			 1861 840 133 #	250 10 250TPZ	Nur bei Altteil-Rückgabe lieferbar (Reparatur; Werk Bielefeld) / Please return old unit for repair (plant Bielefeld)	(51)
			 1863 840 001	GR-3	ohne Anlaufing / without thrust ring	(102)
			 1863 869 010	35	Kugellager / Ball Bearing	(38)
UX 100H,UX 100M 409.100	09.96-	OM602.981, OM602.989	 3000 951 785  3082 269 031  1878 600 501  3151 248 031	250 26 M250 250CD KZIS-0		

Unimog 500-900						
U 52, U 60, U 600,U 600L 421.128 421.162 421.140 421.129 421.163 421.141 U 60T, U 600T 421.133 421.132	01.77- 05.88	OM616.911, OM616.931, OM616.915, OM616.932	 1882 231 131 #	250 G250		
	01.77- 05.88		 1861 840 133 #	250 10 250TPZ	Nur bei Altteil-Rückgabe lieferbar (Reparatur; Werk Bielefeld) / Please return old unit for repair (plant Bielefeld)	(51)
			 1863 840 001	GR-3	ohne Anlaufing / without thrust ring	(102)
			 1888 893 001 #	225 24 DOT240	Chass. 002949 - Chass. 166589 enthält eine Kupplungsscheibe / This part number includes one clutch disc	(67)
			 1878 634 076 ▽	240 10 240CC	Chass. 002949 - Chass. 166589 Lose Kupplungsscheibe / Loose clutch disc	(41)
				 1862 718 002 ▽#	240 10 240CC	Chass. 002949 - Chass. 166589 Lose Kupplungsscheibe / Loose clutch disc Nur bei Altteil-Rückgabe lieferbar (Reparatur; Werk Bielefeld) / Please return old unit for repair (plant Bielefeld)
			 1863 837 003	GR-4	Chass. 002949 - Chass. 166589 ohne Anlaufing / without thrust ring	(102)
			 1863 869 010	35	Kugellager / Ball Bearing	(38)
U 527, U 527 L 405.222 405.202 U 530, U 530 L 405.222 405.202	05.13-	OM936	 3482 000 463	395 MF395	405.202/222	
	05.13-		 3182 600 101	HHIS-3	405.202/222 mit Sensor / with sensor Füllmedium: Bremsflüssigkeit / Fill Medium: Brake Fluid Immer erneuern / Renew everytime	(92) (25) (30)
			 1863 869 044	55	405.202/222	









MERCEDES-BENZ

Unimog 500-900

U 600 407.200	05.88-	OM616.942, OM616.943	 1882 231 131 #	250 G250		
			 1861 840 133 #	250 10 250TPZ	Nur bei Altteil-Rückgabe lieferbar (Reparatur; Werk Bielefeld) / Please return old unit for repair (plant Bielefeld)	(51)
			 1863 840 001	GR-3	-> Chass. 166588 ohne Anlauftring / without thrust ring	(102)
			 1863 837 002	GR-4	Chass. 166589-> mit Anlauftring / with thrust ring	(88)
			 1888 893 001 #	225 24 DOT240	Chass. 002949 - Chass. 166589 enthält eine Kupplungsscheibe / This part number includes one clutch disc	(67)
			 1862 718 002 ▽#	240 10 240CC	Chass. 002949 - Chass. 166589 Lose Kupplungsscheibe / Loose clutch disc Nur bei Altteil-Rückgabe lieferbar (Reparatur; Werk Bielefeld) / Please return old unit for repair (plant Bielefeld)	(41) (51)
			1878 634 076 ▽	240 10 240CC	Chass. 002949 - Chass. 166589 Lose Kupplungsscheibe / Loose clutch disc	(41)
			 1863 837 003	GR-4	Chass. 002949 - Chass. 166589 ohne Anlauftring / without thrust ring	(102)
			 1863 869 010	35	Kugellager / Ball Bearing	(38)
			U 600 407.100	05.88-	OM616.942, OM616.943	 1882 231 131 #
 1861 840 133 #	250 10 250TPZ	für Fahrzeuge mit Einscheibenkupplung / for vehicles with single disc clutch Nur bei Altteil-Rückgabe lieferbar (Reparatur; Werk Bielefeld) / Please return old unit for repair (plant Bielefeld)				(72) (51)
 1863 840 001	GR-3	für Fahrzeuge mit Einscheibenkupplung / for vehicles with single disc clutch ohne Anlauftring / without thrust ring				(72) (102)
 1888 893 001 #	225 24 DOT240	-> Chass. 166588 enthält eine Kupplungsscheibe / This part number includes one clutch disc Sonderausführung / Special design				(67) (60)
 1862 718 002 ▽#	240 10 240CC	-> Chass. 166588 Lose Kupplungsscheibe / Loose clutch disc Nur bei Altteil-Rückgabe lieferbar (Reparatur; Werk Bielefeld) / Please return old unit for repair (plant Bielefeld) Sonderausführung / Special design				(41) (51) (60)
1878 634 076 ▽	240 10 240CC	-> Chass. 166588 Lose Kupplungsscheibe / Loose clutch disc Sonderausführung / Special design				(41) (60)
 1863 837 003	GR-4	-> Chass. 166588 Sonderausführung / Special design ohne Anlauftring / without thrust ring				(60) (102)
 1888 600 101 #	240 24 DOT240	Chass. 166590-> enthält eine Kupplungsscheibe / This part number includes one clutch disc				(67)
 1878 634 076	240 10 240CC	Chass. 166590->				
1862 718 002 #	240 10 240CC	Chass. 166590-> Nur bei Altteil-Rückgabe lieferbar (Reparatur; Werk Bielefeld) / Please return old unit for repair (plant Bielefeld)				(51)
 1863 837 002	GR-4	Chass. 166590-> mit Anlauftring / with thrust ring				(88)
 1863 855 000	GR-8	Chass. 166590-> mit Anlauftring / with thrust ring				(88)
 1863 869 010	35	Kugellager / Ball Bearing				(38)





















		CODE		 Parameter		
--	--	------	--	---	---	---

MERCEDES-BENZ

Unimog 500-900						
U 650,U 650L 407.211 407.210	05.88-	OM616.942, OM616.943	 1882 231 131 #	250 G250	für Fahrzeuge mit Einscheibenkupplung / for vehicles with single disc clutch	(72)
			 1861 840 133 #	250 10 250TPZ	für Fahrzeuge mit Einscheibenkupplung / for vehicles with single disc clutch Nur bei Altteil-Rückgabe lieferbar (Reparatur; Werk Bielefeld) / Please return old unit for repair (plant Bielefeld)	(72) (51)
			 1863 840 001	GR-3	-> Chass. 166588 für Fahrzeuge mit Einscheibenkupplung / for vehicles with single disc clutch ohne Anlauftring / without thrust ring	(72) (102)
			 1863 837 002	GR-4	Chass. 166589-> für Fahrzeuge mit Einscheibenkupplung / for vehicles with single disc clutch mit Anlauftring / with thrust ring	(72) (88)
			 1888 893 001 #	225 24 DOT240	-> Chass. 166588 enthält eine Kupplungsscheibe / This part number includes one clutch disc Sonderausführung / Special design	(67) (60)
			 1862 718 002 ▽#	240 10 240CC	-> Chass. 166588 Lose Kupplungsscheibe / Loose clutch disc Nur bei Altteil-Rückgabe lieferbar (Reparatur; Werk Bielefeld) / Please return old unit for repair (plant Bielefeld) Sonderausführung / Special design	(41) (51) (60)
			1878 634 076 ▽	240 10 240CC	-> Chass. 166588 Lose Kupplungsscheibe / Loose clutch disc Sonderausführung / Special design	(41) (60)
			 1863 837 003	GR-4	-> Chass. 166588 Sonderausführung / Special design ohne Anlauftring / without thrust ring	(60) (102)
			 1863 869 010	35	Kugellager / Ball Bearing	(38)

		CODE		 Parameter		
--	--	------	--	---	---	---























MERCEDES-BENZ

Unimog 500-900						
U 650,U 650L 407.111 407.110	05.88-	OM616.942, OM616.943		1882 231 131 #	250 G250	für Fahrzeuge mit Einscheibenkupplung / for vehicles with single disc clutch (72)
				1861 840 133 #	250 10 250TPZ	für Fahrzeuge mit Einscheibenkupplung / for vehicles with single disc clutch (72) Nur bei Altteil-Rückgabe lieferbar (Reparatur; Werk Bielefeld) / Please return old unit for repair (plant Bielefeld) (51)
				1863 840 001	GR-3	-> Chass. 166588 für Fahrzeuge mit Einscheibenkupplung / for vehicles with single disc clutch ohne Anlauftring / without thrust ring (72) (102)
				1863 837 002	GR-4	Chass. 166589-> für Fahrzeuge mit Einscheibenkupplung / for vehicles with single disc clutch mit Anlauftring / with thrust ring (72) (88)
				1888 893 001 #	225 24 DOT240	-> Chass. 166588 enthält eine Kupplungsscheibe / This part number includes one clutch disc Sonderausführung / Special design (67) (60)
				1862 718 002 ▽#	240 10 240CC	-> Chass. 166588 Lose Kupplungsscheibe / Loose clutch disc Nur bei Altteil-Rückgabe lieferbar (Reparatur; Werk Bielefeld) / Please return old unit for repair (plant Bielefeld) Sonderausführung / Special design (41) (51) (60)
				1878 634 076 ▽	240 10 240CC	-> Chass. 166588 Lose Kupplungsscheibe / Loose clutch disc Sonderausführung / Special design (41) (60)
				1863 837 003	GR-4	-> Chass. 166588 Sonderausführung / Special design ohne Anlauftring / without thrust ring (60) (102)
				1888 600 101 #	240 24 DOT240	Chass. 166590-> enthält eine Kupplungsscheibe / This part number includes one clutch disc (67)
				1878 634 076	240 10 240CC	Chass. 166590->
				1862 718 002 #	240 10 240CC	Chass. 166590-> Nur bei Altteil-Rückgabe lieferbar (Reparatur; Werk Bielefeld) / Please return old unit for repair (plant Bielefeld) (51)
				1863 837 002	GR-4	Chass. 166590-> mit Anlauftring / with thrust ring (88)
				1863 855 000	GR-8	Chass. 166590-> mit Anlauftring / with thrust ring (88)
				1863 869 010	35	Kugellager / Ball Bearing (38)
			U 800 416.114-117 416.140-163 416.135 416.134			
	1888 877 102 #	280 24 DOT280				Chass. 088737 - Chass. 166589 enthält eine Kupplungsscheibe / This part number includes one clutch disc (67)
	1888 877 103 #	280 24 DOT280				Chass. 166590-> enthält eine Kupplungsscheibe / This part number includes one clutch disc (67)
	1861 966 141 ▽#	280 10 280GSPD CE/ CERAM				Lose Kupplungsscheibe / Loose clutch disc (41)
U 800,L 403.120-123				1888 877 101 #	280 DOT280	Chass. 000760 - Chass. 088736 enthält zwei Kupplungsscheiben / This part number includes both clutch discs (68)
				1888 877 102 #	280 24 DOT280	Chass. 088737-> enthält eine Kupplungsscheibe / This part number includes one clutch disc (67)
				1861 966 141 ▽#	280 10 280GSPD CE/ CERAM	Chass. 088737-> Lose Kupplungsscheibe / Loose clutch disc (41)
				1863 837 003	GR-4	Chass. 088737-> ohne Anlauftring / without thrust ring (102)





















		CODE				
--	--	------	--	---	---	---

MERCEDES-BENZ

Unimog 500-900

























U 800 417.200 403.122	01.77 - 03.90	OM314.917		1882 229 131 #	280 G280	-> Chass. 088736 403.122	
				1861 518 031 #	280 10 280BDC	-> Chass. 088736 403.122 Anzahl der Beläge / Number of pads: 6	(3)
				1861 611 131 ●#	280 10 280B/Z	-> Chass. 088736 403.122	
				1863 840 001	GR-3	-> Chass. 088736 403.122 ohne Anlauffring / without thrust ring	(102)
				3482 008 032	310 MF310	Chass. 088737-> 403.122	
				1861 384 334 #	310 10 310GSZ	Chass. 088737-> 403.122	
				1863 840 001	GR-3	Chass. 088737-> 403.122 ohne Anlauffring / without thrust ring	(102)
				1888 893 001 #	225 24 DOT240	403.122 für Fahrzeuge mit Zweischeibenkupplung / for vehicles with double disc clutch enthält eine Kupplungsscheibe / This part number includes one clutch disc	(77) (67)
				1862 718 002 ▽#	240 10 240CC	403.122 für Fahrzeuge mit Zweischeibenkupplung / for vehicles with double disc clutch Lose Kupplungsscheibe / Loose clutch disc Nur bei Altteil-Rückgabe lieferbar (Reparatur; Werk Bielefeld) / Please return old unit for repair (plant Bielefeld)	(77) (41) (51)
				1878 634 076 ▽	240 10 240CC	403.122 für Fahrzeuge mit Zweischeibenkupplung / for vehicles with double disc clutch Lose Kupplungsscheibe / Loose clutch disc	(77) (41)
				1863 837 003	GR-4	403.122 für Fahrzeuge mit Zweischeibenkupplung / for vehicles with double disc clutch ohne Anlauffring / without thrust ring	(77) (102)
				3482 008 032	310 MF310	417.200	
				1861 384 334 #	310 10 310GSZ	417.200	
				1863 840 001	GR-3	-> Chass. 166589 417.200 ohne Anlauffring / without thrust ring	(102)
				1863 837 002	GR-4	Chass. 166590-> 417.200 mit Anlauffring / with thrust ring	(88)
U 800L 413.111 413.110	01.77 - 03.90	OM314.917		1882 229 131 #	280 G280	-> Chass. 088736	
				1861 518 031 #	280 10 280BDC	-> Chass. 088736 Anzahl der Beläge / Number of pads: 6	(3)
				1861 611 131 ●#	280 10 280B/Z	-> Chass. 088736	
				1863 840 001	GR-3	-> Chass. 088736 ohne Anlauffring / without thrust ring	(102)
				3482 008 032	310 MF310	Chass. 088737->	
				1861 384 334 #	310 10 310GSZ	Chass. 088737->	
				1863 840 001	GR-3	Chass. 088737-> ohne Anlauffring / without thrust ring	(102)
				1888 877 101 #	280 DOT280	-> Chass. 088736 für Fahrzeuge mit Zweischeibenkupplung / for vehicles with double disc clutch enthält zwei Kupplungsscheiben / This part number includes both clutch discs	(77) (68)
	1888 877 102 #	280 24 DOT280	Chass. 088737-> für Fahrzeuge mit Zweischeibenkupplung / for vehicles with double disc clutch enthält eine Kupplungsscheibe / This part number includes one clutch disc	(77) (67)			

MERCEDES-BENZ

Unimog 500-900						
U 800 417.100	05.88 - 03.90	OM314.917	 3482 008 032	310 MF310		
			 1861 384 334 #	310 10 310GSZ		
			 1863 840 001	GR-3	-> Chass. 166589 ohne Anlauftring / without thrust ring	(102)
			 1863 837 002	GR-4	Chass. 166590-> mit Anlauftring / with thrust ring	(88)
			 1888 877 102 #	280 24 DOT280	-> Chass. 166589 enthält eine Kupplungsscheibe / This part number includes one clutch disc	(67)
			 1888 877 103 #	280 24 DOT280	Chass. 166590-> enthält eine Kupplungsscheibe / This part number includes one clutch disc	(67)
			 1861 966 141 ▽#	280 10 280GSPD CE/ CERAM	Lose Kupplungsscheibe / Loose clutch disc	(41)
U 900			 1888 067 042 #	330 22 DUT330/ 310	enthält eine Kupplungsscheibe / This part number includes one clutch disc	(67)
			 1861 741 042 ▽#	327 20 327GSDC	enthält Druckplattenbefestigungsschrauben / includes bolt for pressure plate mounting	(65)
			 1863 837 002	GR-4	Anzahl der Beläge / Number of pads: 8 Lose Kupplungsscheibe / Loose clutch disc	(3) (41)
			1863 855 000	GR-8	mit Anlauftring / with thrust ring	(88)
U 900 416.140-163 416.134 416.114-135			 1888 877 101 #	280 DOT280	Chass. 000562 - Chass. 088736 enthält zwei Kupplungsscheiben / This part number includes both clutch discs	(68)
			 1888 877 102 #	280 24 DOT280	Chass. 088737 - Chass. 166589 enthält eine Kupplungsscheibe / This part number includes one clutch disc	(67)
			 1888 877 103 #	280 24 DOT280	Chass. 166590-> enthält eine Kupplungsscheibe / This part number includes one clutch disc	(67)
			 1861 966 141 ▽#	280 10 280GSPD CE/ CERAM		
U 900 406.145			 1882 282 331	310 GFX310	Chass. 003773 - Chass. 088736 Nur bei Alteil-Rückgabe lieferbar (Reparatur; Werk Bielefeld) / Please return old unit for repair (plant Bielefeld)	(51)
			 1861 384 334 #	310 10 310GSZ	Chass. 003773 - Chass. 088736	
			 1863 840 001	GR-3	Chass. 003773 - Chass. 088736 ohne Anlauftring / without thrust ring	(102)
U 900 406.120			 1888 893 001 #	225 24 DOT240	enthält eine Kupplungsscheibe / This part number includes one clutch disc	(67)
			 1862 718 002 ▽#	240 10 240CC	Lose Kupplungsscheibe / Loose clutch disc Nur bei Alteil-Rückgabe lieferbar (Reparatur; Werk Bielefeld) / Please return old unit for repair (plant Bielefeld)	(41) (51)
			1878 634 076 ▽	240 10 240CC	Lose Kupplungsscheibe / Loose clutch disc	(41)
			 1863 837 003	GR-4	ohne Anlauftring / without thrust ring	(102)

		CODE		 Parameter		
--	--	------	--	---	---	---

MERCEDES-BENZ

Unimog 500-900						
U 900 406.120 417.201 417.101 406.121	01.77 -	OM353.902	 1882 229 131 #	280 G280	->Chass. 088736 406.120-121	
			 1861 518 031 #	280 10 280BDC	->Chass. 088736 406.120-121 Anzahl der Beläge / Number of pads: 6	(3)
			 1861 611 131 ●#	280 10 280B/Z	->Chass. 088736 406.120-121	
			 1863 840 001	GR-3	->Chass. 088736 406.120-121 ohne Anlauftring / without thrust ring	(102)
			 3482 008 032	310 MF310	Chass. 088737-> 406.120-121	
			 1861 384 334 #	310 10 310GSZ	Chass. 088737-> 406.120-121	
			 1863 840 001	GR-3	Chass. 088737-> 406.120-121 ohne Anlauftring / without thrust ring	(102)
			 1888 877 101 #	280 DOT280	Chass. 009059 - Chass. 088736 406.120-121 enthält zwei Kupplungsscheiben / This part number includes both clutch discs	(68)
			 1888 877 102 #	280 24 DOT280	Chass. 088737-> 406.120-121 enthält eine Kupplungsscheibe / This part number includes one clutch disc	(67)
			 1861 966 141 ▽#	280 10 280GSPD CE/ CERAM	Chass. 088737-> 406.120-121 Lose Kupplungsscheibe / Loose clutch disc	(41)
			 1863 837 003	GR-4	Chass. 088737-> 406.120-121 ohne Anlauftring / without thrust ring	(102)
			 3482 008 032	310 MF310	417.101/201	
			 1861 384 334 #	310 10 310GSZ	417.101/201	
			 1863 840 001	GR-3	->Chass. 166588 417.101/201 ohne Anlauftring / without thrust ring	(102)
			 1863 837 002	GR-4	Chass. 166589-> 417.101/201 mit Anlauftring / with thrust ring	(88)
U 900 417.101 U 900 417.106	05.88 -	OM353.902, OM366.939, OM356.912	 3482 008 032	310 MF310		
	11.88 -		 1861 384 334 #	310 10 310GSZ		
			 1863 840 001	GR-3	ohne Anlauftring / without thrust ring	(102)
			 1888 877 102 #	280 24 DOT280	->Chass. 166589 enthält eine Kupplungsscheibe / This part number includes one clutch disc	(67)
			 1888 877 103 #	280 24 DOT280	Chass. 166590-> enthält eine Kupplungsscheibe / This part number includes one clutch disc	(67)
		 1861 966 141 ▽#	280 10 280GSPD CE/ CERAM	Lose Kupplungsscheibe / Loose clutch disc	(41)	
U 900 406.143 406.142	01.77 - 01.88	OM353.940	 1882 282 331	310 GFX310	Nur bei Altteil-Rückgabe lieferbar (Reparatur; Werk Bielefeld) / Please return old unit for repair (plant Bielefeld)	(51)
			 1861 384 334 #	310 10 310GSZ		
			 1863 840 001	GR-3	ohne Anlauftring / without thrust ring	(102)



CODE



SACHS

Parameter













MERCEDES-BENZ

Unimog 1000-1350

U 100, U 110, U 1100L 416.116 416.141 416.160 416.115 416.140 416.117	01.77 - 05.88	OM353.940, OM353.901, OM353.980	1882 231 131 #	250 G250	416.140-141	
			1861 840 133 #	250 10 250TPZ	416.140-141 Nur bei Altteil-Rückgabe lieferbar (Reparatur; Werk Bielefeld) / Please return old unit for repair (plant Bielefeld)	(51)
			1863 840 001	GR-3	416.140-141 ohne Anlauftring / without thrust ring	(102)
			1882 282 331	310 GFX310	-> Chass. 088736 für Fahrzeuge mit Einscheibenkupplung / for vehicles with single disc clutch Nur bei Altteil-Rückgabe lieferbar (Reparatur; Werk Bielefeld) / Please return old unit for repair (plant Bielefeld)	(72) (51)
			1861 384 334 #	310 10 310GSZ	-> Chass. 088736 für Fahrzeuge mit Einscheibenkupplung / for vehicles with single disc clutch	(72)
			1863 840 001	GR-3	-> Chass. 088736 für Fahrzeuge mit Einscheibenkupplung / for vehicles with single disc clutch ohne Anlauftring / without thrust ring	(72) (102)
			3482 008 032	310 MF310	Chass. 088737-> für Fahrzeuge mit Einscheibenkupplung / for vehicles with single disc clutch	(72)
			1861 384 334 #	310 10 310GSZ	Chass. 088737-> für Fahrzeuge mit Einscheibenkupplung / for vehicles with single disc clutch	(72)
			1863 840 001	GR-3	Chass. 088737-> für Fahrzeuge mit Einscheibenkupplung / for vehicles with single disc clutch ohne Anlauftring / without thrust ring	(72) (102)
			1888 877 101 #	280 DOT280	Chass. 000562 - Chass. 088736 enthält zwei Kupplungsscheiben / This part number includes both clutch discs	(68)
			1888 877 102 #	280 24 DOT280	Chass. 088737 - Chass. 166589 enthält eine Kupplungsscheibe / This part number includes one clutch disc	(67)
			1888 877 103 #	280 24 DOT280	Chass. 166590-> enthält eine Kupplungsscheibe / This part number includes one clutch disc	(67)
			1861 966 141 ▽#	280 10 280GSPD CE/ CERAM	Lose Kupplungsscheibe / Loose clutch disc	(41)



























		CODE		 Parameter		
--	--	------	--	---	---	---

MERCEDES-BENZ

Unimog 1000-1350						
U 100, U 110T, U 1100T 416.134 417.000 416.135	01.77-	OM353.940, OM353.901, OM353.980		3482 008 032	310 MF310	417.000 für Fahrzeuge mit Einscheibenkupplung / for vehicles with single disc clutch (72)
				1861 384 334 #	310 10 310GSZ	417.000 für Fahrzeuge mit Einscheibenkupplung / for vehicles with single disc clutch (72)
				1863 840 001	GR-3	-> Chass. 166589 417.000 für Fahrzeuge mit Einscheibenkupplung / for vehicles with single disc clutch ohne Anlauftring / without thrust ring (72) (102)
				1863 837 002	GR-4	Chass. 166590-> 417.000 für Fahrzeuge mit Einscheibenkupplung / for vehicles with single disc clutch mit Anlauftring / with thrust ring (72) (88)
				1888 877 102 #	280 24 DOT280	-> Chass. 166589 417.000 enthält eine Kupplungsscheibe / This part number includes one clutch disc (67)
				1888 877 103 #	280 24 DOT280	Chass. 166590-> 417.000 enthält eine Kupplungsscheibe / This part number includes one clutch disc (67)
				1861 966 141 ▽#	280 10 280GSPD CE/ CERAM	417.000 Lose Kupplungsscheibe / Loose clutch disc (41)
				1882 229 131 #	280 G280	-> Chass. 088736 416.134-135 für Fahrzeuge mit Einscheibenkupplung / for vehicles with single disc clutch (72)
				1861 518 031 #	280 10 280BDC	-> Chass. 088736 416.134-135 für Fahrzeuge mit Einscheibenkupplung / for vehicles with single disc clutch Anzahl der Beläge / Number of pads: 6 (72) (3)
				1861 611 131 ●#	280 10 280B/Z	-> Chass. 088736 416.134-135 für Fahrzeuge mit Einscheibenkupplung / for vehicles with single disc clutch (72)
				1863 840 001	GR-3	-> Chass. 088736 416.134-135 für Fahrzeuge mit Einscheibenkupplung / for vehicles with single disc clutch ohne Anlauftring / without thrust ring (72) (102)
				3482 008 032	310 MF310	Chass. 088737-> 416.134-135 für Fahrzeuge mit Einscheibenkupplung / for vehicles with single disc clutch (72)
				1861 384 334 #	310 10 310GSZ	Chass. 088737-> 416.134-135 für Fahrzeuge mit Einscheibenkupplung / for vehicles with single disc clutch (72)
				1863 840 001	GR-3	Chass. 088737-> 416.134-135 für Fahrzeuge mit Einscheibenkupplung / for vehicles with single disc clutch ohne Anlauftring / without thrust ring (72) (102)
				1888 877 101 #	280 DOT280	Chass. 000562 - Chass. 088736 416.134-135 enthält zwei Kupplungsscheiben / This part number includes both clutch discs (68)
				1888 877 102 #	280 24 DOT280	Chass. 088737 - Chass. 166589 416.134-135 enthält eine Kupplungsscheibe / This part number includes one clutch disc (67)
				1888 877 103 #	280 24 DOT280	Chass. 166590-> 416.134-135 enthält eine Kupplungsscheibe / This part number includes one clutch disc (67)
				1861 966 141 ▽#	280 10 280GSPD CE/ CERAM	416.134-135 Lose Kupplungsscheibe / Loose clutch disc (41)

























		CODE				
--	--	------	--	---	---	---

MERCEDES-BENZ





























Unimog 1000-1350						
U 1000 424.121	01.77 - 05.88	OM353.962	 3482 008 032	310 MF310		
			 1861 603 034 #	310 20 310GSZ		
			 3151 051 031	KZI-4		
			 1888 067 042 #	330 22 DUT330/ 310	enthält eine Kupplungsscheibe / This part number includes one clutch disc enthält Druckplattenbefestigungsschrauben / includes bolt for pressure plate mounting	(67) (65)
			 1861 741 042 ▽#	327 20 327GSDC	Anzahl der Beläge / Number of pads: 8 Lose Kupplungsscheibe / Loose clutch disc	(3) (41)
			 1863 837 002	GR-4	mit Anlaufring / with thrust ring	(88)
			 1863 855 000	GR-8	mit Anlaufring / with thrust ring	(88)
			 1888 893 001 #	225 24 DOT240	enthält eine Kupplungsscheibe / This part number includes one clutch disc	(67)
			 1878 634 076 ▽	240 10 240CC	Lose Kupplungsscheibe / Loose clutch disc	(41)
			 1862 718 002 ▽#	240 10 240CC	Lose Kupplungsscheibe / Loose clutch disc Nur bei Altteil-Rückgabe lieferbar (Reparatur; Werk Bielefeld) / Please return old unit for repair (plant Bielefeld)	(41) (51)
			 1863 837 003	GR-4	ohne Anlaufring / without thrust ring	(102)
			U 1000 427.100	01.88 -	OM356.914, OM366.915	 3482 008 038
 1861 603 034 #	310 20 310GSZ					
 3151 051 031	KZI-4	->Chass. 173809				
 3182 002 131	HHIS-3	Chass. 173810-> Immer erneuern / Renew everytime				(30)
 1888 067 031 #	330 24 DUT330	enthält eine Kupplungsscheibe / This part number includes one clutch disc Sonderausführung / Special design				(67) (60)
 1888 998 201 #	330 24 DUT330	für Fahrzeuge mit Niederdruck-Bremsanlage / for vehicles with low-pressure brakesystem enthält eine Kupplungsscheibe / This part number includes one clutch disc Sonderausführung / Special design				(74) (67) (60)
 1861 741 042 ▽#	327 20 327GSDC	Anzahl der Beläge / Number of pads: 8 Lose Kupplungsscheibe / Loose clutch disc Sonderausführung / Special design				(3) (41) (60)
 1863 837 002	GR-4	mit Anlaufring / with thrust ring				(88)
 1863 855 000	GR-8	mit Anlaufring / with thrust ring				(88)
U 1000T 424.131	01.77 - 12.82	OM353.940, OM353.980				 3482 008 032
			 1861 603 034 #	310 20 310GSZ		
			 3151 051 031	KZI-4		
			 1888 067 042 #	330 22 DUT330/ 310	enthält eine Kupplungsscheibe / This part number includes one clutch disc enthält Druckplattenbefestigungsschrauben / includes bolt for pressure plate mounting	(67) (65)
			 1861 741 042 ▽#	327 20 327GSDC	Anzahl der Beläge / Number of pads: 8 Lose Kupplungsscheibe / Loose clutch disc	(3) (41)
			 1863 837 002	GR-4	mit Anlaufring / with thrust ring	(88)
			 1863 855 000	GR-8	mit Anlaufring / with thrust ring	(88)

		CODE				
--	--	------	--	---	---	---

MERCEDES-BENZ





























Unimog 1000-1350						
U 1150,U 1150L 417.220 417.211 417.210 U 1150,U 1150L 417.110/111 417.116 417.115 417.120 U 1150L 417.212	05.88-	OM353.940, OM353.907		3482 008 032	310 MF310	für Fahrzeuge mit Einscheibenkupplung / for vehicles with single disc clutch (72)
	05.88-			1861 384 334 #	310 10 310GSZ	für Fahrzeuge mit Einscheibenkupplung / for vehicles with single disc clutch (72)
	05.88-			1863 840 001	GR-3	-> Chass. 166589 für Fahrzeuge mit Einscheibenkupplung / for vehicles with single disc clutch ohne Anlauftring / without thrust ring (72) (102)
				1863 837 002	GR-4	Chass. 166590-> für Fahrzeuge mit Einscheibenkupplung / for vehicles with single disc clutch mit Anlauftring / with thrust ring (72) (88)
				1888 877 102 #	280 24 DOT280	-> Chass. 166589 enthält eine Kupplungsscheibe / This part number includes one clutch disc (67)
				1888 877 103 #	280 24 DOT280	Chass. 166590-> enthält eine Kupplungsscheibe / This part number includes one clutch disc (67)
				1861 966 141 ▽#	280 10 280GSPD CE/ CERAM	Lose Kupplungsscheibe / Loose clutch disc (41)
	U 1200 427.101 U 1200T 427.000 U 1250,U 1250L 427.110/111 U 1250L 427.111		01.88-	OM356.950, OM356.954, OM366.955, OM366.949		3482 012 237
01.88-			1861 667 034		330 20 330GSB	
01.88-			3151 051 031		KZI-4	-> Chass. 173809
05.88-			3182 002 131		HHIS-3	Chass. 173810-> Immer erneuern / Renew everytime (30)
			3800 710 002 #  1888 067 031  1861 741 042  3182 003 131		330 20 DUT330 327GSDC HHIS-3	Sonderausführung / Special design (60)
			1888 998 201 #		330 24 DUT330	für Fahrzeuge mit Niederdruck-Bremsanlage / for vehicles with low-pressure brakesystem enthält eine Kupplungsscheibe / This part number includes one clutch disc (74) enthält eine Kupplungsscheibe / This part number includes one clutch disc (67) Sonderausführung / Special design (60)
			1861 741 042 ▽#		327 20 327GSDC	Anzahl der Beläge / Number of pads: 8 (3) Lose Kupplungsscheibe / Loose clutch disc (41) Sonderausführung / Special design (60)
			3182 003 131		HHIS-3	Sonderausführung / Special design (60) Immer erneuern / Renew everytime (30)
U 1200 424.122 U 1200T 424.132 U 1250 424.127 424.126		02.82 - 05.88	OM353.973, OM353.995			3482 012 237
	01.83 - 05.88			1861 667 034	330 20 330GSB	
	12.84 - 05.88			3151 051 031	KZI-4	
				1888 067 042 #	330 22 DUT330/ 310	enthält eine Kupplungsscheibe / This part number includes one clutch disc (67) enthält Druckplattenbefestigungsschrauben / includes bolt for pressure plate mounting (65)
				1861 741 042 ▽#	327 20 327GSDC	Anzahl der Beläge / Number of pads: 8 (3) Lose Kupplungsscheibe / Loose clutch disc (41)
				1863 837 002	GR-4	mit Anlauftring / with thrust ring (88)
				1863 855 000	GR-8	mit Anlauftring / with thrust ring (88)

MERCEDES-BENZ

Unimog 1000-1350							
U 125, U 1100L 416.114 416.163 416.162	01.77 - 01.88	OM353.907		1882 282 331	310 GFX310	-> Chass. 088736 für Fahrzeuge mit Einscheibenkupplung / for vehicles with single disc clutch Nur bei Altteil-Rückgabe lieferbar (Reparatur; Werk Bielefeld) / Please return old unit for repair (plant Bielefeld)	(72) (51)
				1861 384 334 #	310 10 310GSZ	-> Chass. 088736 für Fahrzeuge mit Einscheibenkupplung / for vehicles with single disc clutch	(72)
				1863 840 001	GR-3	-> Chass. 088736 für Fahrzeuge mit Einscheibenkupplung / for vehicles with single disc clutch ohne Anlaufring / without thrust ring	(72) (102)
				3482 008 032	310 MF310	Chass. 088737-> für Fahrzeuge mit Einscheibenkupplung / for vehicles with single disc clutch	(72)
				1861 384 334 #	310 10 310GSZ	Chass. 088737-> für Fahrzeuge mit Einscheibenkupplung / for vehicles with single disc clutch	(72)
				1863 840 001	GR-3	Chass. 088737-> für Fahrzeuge mit Einscheibenkupplung / for vehicles with single disc clutch ohne Anlaufring / without thrust ring	(72) (102)
				1888 877 101 #	280 DOT280	Chass. 000562 - Chass. 088736 enthält zwei Kupplungsscheiben / This part number includes both clutch discs	(68)
				1888 877 102 #	280 24 DOT280	Chass. 088737 - Chass. 166589 enthält eine Kupplungsscheibe / This part number includes one clutch disc	(67)
				1888 877 103 #	280 24 DOT280	Chass. 166590-> enthält eine Kupplungsscheibe / This part number includes one clutch disc	(67)
				1861 966 141 ▽#	280 10 280GSPD CE/ CERAM	Lose Kupplungsscheibe / Loose clutch disc	(41)
U 1300 425.121	01.77 - 12.84	OM353.973, OM353.995		3482 012 211	330 GMF330	-> Chass. 001570	
				1861 594 034 #	330 20 330GSZ	-> Chass. 001570	
				3151 051 031	KZI-4	-> Chass. 001570	
				3482 012 237	330 GMF330	Chass. 001571->	
				1861 667 034	330 20 330GSB	Chass. 001571->	
				3151 051 031	KZI-4	Chass. 001571->	
				1888 893 001 #	225 24 DOT240	enthält eine Kupplungsscheibe / This part number includes one clutch disc	(67)
				1862 718 002 ▽#	240 10 240CC	Lose Kupplungsscheibe / Loose clutch disc Nur bei Altteil-Rückgabe lieferbar (Reparatur; Werk Bielefeld) / Please return old unit for repair (plant Bielefeld)	(41) (51)
				1878 634 076 ▽	240 10 240CC	Lose Kupplungsscheibe / Loose clutch disc	(41)
				1863 837 003	GR-4	ohne Anlaufring / without thrust ring	(102)
				1888 067 042 #	330 22 DUT330/ 310	enthält eine Kupplungsscheibe / This part number includes one clutch disc enthält Druckplattenbefestigungsschrauben / includes bolt for pressure plate mounting	(67) (65)
				1861 741 042 ▽#	327 20 327GSDC	Anzahl der Beläge / Number of pads: 8 Lose Kupplungsscheibe / Loose clutch disc	(3) (41)
				1863 837 002	GR-4	mit Anlaufring / with thrust ring	(88)
	1863 855 000	GR-8	mit Anlaufring / with thrust ring	(88)			
U 1300 L 436.326 436.325	01.77 - 05.88	OM382.917		3482 002 234	350 GMF350X		
				1861 956 133	350 20 350GTD		
				1861 713 133 ●#	350 20 350GSZ		
				3151 051 031	KZI-4		













		CODE		 Parameter		
--	--	------	--	---	---	---

MERCEDES-BENZ









Unimog 1000-1350						
U 1300,L 435.141 435.110 435.120/121 435.117 435.113 435.131 U 1300,L 425.120 425.141 425.131 425.121 425.110			 3482 012 237	330 GMF330		
			 1861 667 034	330 20 330GSB		
			 3151 051 031	KZI-4		
U 1300,U 1300L 425.121 435.117 435.115 436.321 436.320	01.77 - 05.88	OM353.973, OM353.961	 3482 012 211	330 GMF330	->Chass. 001570 425.121	
			 1861 594 034 #	330 20 330GSZ	->Chass. 001570 425.121	
			 3151 051 031	KZI-4	->Chass. 001570 425.121	
			 3482 012 237	330 GMF330	Chass. 001571-> 425.121	
			 1861 667 034	330 20 330GSB	Chass. 001571-> 425.121	
			 3151 051 031	KZI-4	Chass. 001571-> 425.121	
			 1888 893 001 #	225 24 DOT240	425.121 enthält eine Kupplungsscheibe / This part number includes one clutch disc	(67)
			 1862 718 002 ▽#	240 10 240CC	425.121 Lose Kupplungsscheibe / Loose clutch disc Nur bei Altteil-Rückgabe lieferbar (Reparatur; Werk Bielefeld) / Please return old unit for repair (plant Bielefeld)	(41) (51)
			1878 634 076 ▽	240 10 240CC	425.121 Lose Kupplungsscheibe / Loose clutch disc	(41)
			 1863 837 003	GR-4	425.121 ohne Anlauftring / without thrust ring	(102)
			 1888 067 042 #	330 22 DUT330/ 310	425.121 enthält eine Kupplungsscheibe / This part number includes one clutch disc enthält Druckplattenbefestigungsschrauben / includes bolt for pressure plate mounting	(67) (65)
			 1861 741 042 ▽#	327 20 327GSDC	425.121 Anzahl der Beläge / Number of pads: 8 Lose Kupplungsscheibe / Loose clutch disc	(3) (41)
			 1863 837 002	GR-4	425.121 mit Anlauftring / with thrust ring	(88)
			 1863 855 000	GR-8	425.121 mit Anlauftring / with thrust ring	(88)
			 3482 012 211	330 GMF330	->Chass. 002154 435.115/117	
			 1861 594 034 #	330 20 330GSZ	->Chass. 002154 435.117	
			 3482 012 237	330 GMF330	Chass. 002155-> 435.117	
			 1861 667 034	330 20 330GSB	Chass. 002155-> 435.117	
			 3151 051 031	KZI-4	435.117	
			 1888 067 042 #	330 22 DUT330/ 310	435.117 enthält eine Kupplungsscheibe / This part number includes one clutch disc enthält Druckplattenbefestigungsschrauben / includes bolt for pressure plate mounting	(67) (65)
			 1861 741 042 ▽#	327 20 327GSDC	435.117 Anzahl der Beläge / Number of pads: 8 Lose Kupplungsscheibe / Loose clutch disc	(3) (41)
			 1863 837 002	GR-4	435.117 mit Anlauftring / with thrust ring	(88)
 1863 855 000	GR-8	435.117 mit Anlauftring / with thrust ring	(88)			
 3482 012 237	330 GMF330	436.320-321				
 1861 667 034	330 20 330GSB	436.320-321				
 3151 051 031	KZI-4	436.320-321				

MERCEDES-BENZ

Unimog 1000-1350





























U 1350L 437.110	05.88-	OM366.955	 3482 012 237	330 GMF330		
			 1861 667 034	330 20 330GSB		
			 3151 051 031	KZI-4	->Chass. 173809	
			 3182 002 131	HHIS-3	Chass. 173810-> Immer erneuern / Renew everytime	(30)
			 3800 710 002 #  1888 067 031  1861 741 042  3182 003 131	330 20 DUT330 327GSDC HHIS-3	Sonderausführung / Special design	(60)
			 1861 594 034 ●▽#	330 20 330GSZ	Lose Kupplungsscheibe / Loose clutch disc Sonderausführung / Special design	(41) (60)
			 1888 998 902 ●#	350 24 DUT350/ 330	enthält eine Kupplungsscheibe / This part number includes one clutch disc Sonderausführung / Special design	(67) (60)
			 1862 962 002 ▽#	350 20 350GSDC	Lose Kupplungsscheibe / Loose clutch disc Sonderausführung / Special design	(41) (60)
			 3182 003 131	HHIS-3	Sonderausführung / Special design Immer erneuern / Renew everytime	(60) (30)

Unimog 1400-1750

U 1400 437.110 U 1450 437.110 U 1600,L 437.110			 1888 067 031 #	330 24 DUT330	enthält eine Kupplungsscheibe / This part number includes one clutch disc Sonderausführung / Special design	(67) (60)
			 1861 741 042 ●▽#	327 20 327GSDC	Anzahl der Beläge / Number of pads: 8 Lose Kupplungsscheibe / Loose clutch disc Sonderausführung / Special design	(3) (41) (60)
			 1861 594 034 ▽#	330 20 330GSZ	Lose Kupplungsscheibe / Loose clutch disc Sonderausführung / Special design	(41) (60)
			 1888 998 902 ●#	350 24 DUT350/ 330	enthält eine Kupplungsscheibe / This part number includes one clutch disc Sonderausführung / Special design	(67) (60)
			 1862 962 002 ▽#	350 20 350GSDC	Lose Kupplungsscheibe / Loose clutch disc Sonderausführung / Special design	(41) (60)
			 3482 012 237	330 GMF330		
U 1400 424.132 424.126/127 424.122 U 1450 424.126 424.122 424.127 424.132 U 1500 435.110 435.113 435.131 435.121 435.117 435.120 435.141 U 1700,U 1700L 425.131 425.110 425.141 425.121 425.120			 1861 667 034	330 20 330GSB		
			 3151 051 031	KZI-4		































		CODE				
--	--	------	--	---	---	---

MERCEDES-BENZ































Unimog 1400-1750							
U 1400 427.102 U 1450,U 1450L 427.112 427.111	01.88-	OM357.912, OM366.948, OM366.955, OM366.956, OM366.947		3482 012 237	330 GMF330		
	01.88-			1861 667 034	330 20 330GSB		
				3151 051 031	KZI-4	-> Chass. 173809	
				3182 002 131	HHIS-3	Chass. 173810-> Immer erneuern / Renew everytime	(30)
				3482 106 133	350 GMF350X		
				1861 956 133	350 20 350GTD		
				1861 713 133 ●#	350 20 350GSZ		
				3182 002 131	HHIS-3	Immer erneuern / Renew everytime	(30)
				3800 710 002 #  1888 067 031  1861 741 042  3182 003 131	330 20 DUT330 327GSDC HHIS-3	Sonderausführung / Special design	(60)
				1888 998 201 #	330 24 DUT330	für Fahrzeuge mit Niederdruck-Bremsanlage / for vehicles with low-pressure brakesystem enthält eine Kupplungsscheibe / This part number includes one clutch disc Sonderausführung / Special design	(74) (67) (60)
				1861 594 034 ▽#	330 20 330GSZ	Lose Kupplungsscheibe / Loose clutch disc Sonderausführung / Special design	(41) (60)
				1861 741 042 ●▽#	327 20 327GSDC	Anzahl der Beläge / Number of pads: 8 Lose Kupplungsscheibe / Loose clutch disc Sonderausführung / Special design	(3) (41) (60)
				3182 003 131	HHIS-3	Sonderausführung / Special design Immer erneuern / Renew everytime	(60) (30)
				3800 710 003 ●#  1888 998 902  1862 962 002  3182 003 131	350 20 DUT350/330 350GSDC HHIS-3	Sonderausführung / Special design	(60)
U 1500 425.141 U 1500T 425.131 U 1550 424.126 U 1550 L 424.127	01.77 - 05.88	OM353.958, OM353.995, OM353.961		3482 012 237	330 GMF330	für Fahrzeuge mit Einscheibenkupplung / for vehicles with single disc clutch	(72)
	01.77 - 05.88			1861 667 034	330 20 330GSB	für Fahrzeuge mit Einscheibenkupplung / for vehicles with single disc clutch	(72)
	01.86 - 05.88			3151 051 031	KZI-4	für Fahrzeuge mit Einscheibenkupplung / for vehicles with single disc clutch	(72)
	02.86 - 05.88			1888 067 042 #	330 22 DUT330/ 310	enthält eine Kupplungsscheibe / This part number includes one clutch disc enthält Druckplattenbefestigungsschrauben / includes bolt for pressure plate mounting	(67) (65)
				1861 741 042 ▽#	327 20 327GSDC	Anzahl der Beläge / Number of pads: 8 Lose Kupplungsscheibe / Loose clutch disc	(3) (41)
				1863 837 002	GR-4	mit Anlauftring / with thrust ring	(88)
U 1550L 437.000-160 U 1550L/37 437.120 437.125				1863 855 000	GR-8	mit Anlauftring / with thrust ring	(88)
				1888 998 902 #	350 24 DUT350/ 330	enthält eine Kupplungsscheibe / This part number includes one clutch disc	(67)
				1862 962 002 ▽#	350 20 350GSDC	Lose Kupplungsscheibe / Loose clutch disc	(41)

		CODE				
--	--	------	--	---	---	---

MERCEDES-BENZ































Unimog 1400-1750						
U 1550L 437.120 437.111 U 1550L 437.111	05.88-	OM356.956, OM366.955, OM366.956		3482 002 234	350 GMF350X	->Chass. 173809
	05.88-			3482 106 133	350 GMF350X	Chass. 173810->
				1861 956 133	350 20 350GTD	
				1861 713 133 ●#	350 20 350GSZ	
				3151 051 031	KZI-4	->Chass. 173809
				3182 002 131	HHIS-3	Chass. 173810-> Immer erneuern / Renew everytime (30)
				1888 998 902 #	350 24 DUT350/ 330	enthält eine Kupplungsscheibe / This part number includes one clutch disc Sonderausführung / Special design (67)
				1862 962 002 ▽#	350 20 350GSDC	Lose Kupplungsscheibe / Loose clutch disc Sonderausführung / Special design (41) (60)
				1863 855 000	GR-8	->Chass. 186921 Sonderausführung / Special design mit Anlauftring / with thrust ring (60) (88)
				1863 837 002	GR-4	->Chass. 186921 Sonderausführung / Special design mit Anlauftring / with thrust ring (60) (88)
				3800 710 003 #  1888 998 902  1862 962 002  3182 003 131	350 20 DUT350/330 350GSDC HHIS-3	Chass. 186922->
			U 1550L 437.125 437.123 437.141 437.120	01.92-	OM356.955, OM356.956	
	3482 106 031	360 GMF350X				Chass. 173810-> 437.120/125
	1862 286 031 #	360 20 360GSDC				437.125/120
	3151 051 031	KZI-4				->Chass. 173809 437.120/125
	3182 002 131	HHIS-3				Chass. 173810-> 437.120/125 Immer erneuern / Renew everytime (30)
	1888 998 902 #	350 24 DUT350/ 330				437.120/125/123 enthält eine Kupplungsscheibe / This part number includes one clutch disc Sonderausführung / Special design (67)
	1862 962 002 ▽#	350 20 350GSDC				437.120/125/123 Lose Kupplungsscheibe / Loose clutch disc Sonderausführung / Special design (41) (60)
	1863 837 002	GR-4				->Chass. 186921 437.120/125/123 Sonderausführung / Special design mit Anlauftring / with thrust ring (60) (88)
	1863 855 000	GR-8				->Chass. 186921 437.120/125/123 Sonderausführung / Special design mit Anlauftring / with thrust ring (60) (88)
	3800 710 003 #  1888 998 902  1862 962 002  3182 003 131	350 20 DUT350/330 350GSDC HHIS-3				Chass. 186922-> 437.120/125/123 Sonderausführung / Special design (60)
	3482 106 133	350 GMF350X				437.123/141
	1861 956 133	350 20 350GTD				437.123/141
	1861 713 133 ●#	350 20 350GSZ				437.123/141
	3182 002 131	HHIS-3				437.123/141 Immer erneuern / Renew everytime (30)

MERCEDES-BENZ





































Unimog 1400-1750						
U 1550L 437.111 437.123 437.120	01.92-	OM366.963	 3482 002 234	350 GMF350X	->Chass. 173809 437.111/120	
			 3482 106 133	350 GMF350X	Chass. 173810-> 437.111/120	
			 1861 956 133	350 20 350GTD	437.111/120	
			 1861 713 133 ●#	350 20 350GSZ	437.111/120	
			 3151 051 031	KZI-4	->Chass. 173809 437.111/120	
			 3182 002 131	HHIS-3	Chass. 173810-> 437.111/120 Immer erneuern / Renew everytime	(30)
			 1888 998 902 #	350 24 DUT350/ 330	437.111/120 enthält eine Kupplungsscheibe / This part number includes one clutch disc Sonderausführung / Special design	(67) (60)
			 1862 962 002 ▽#	350 20 350GSDC	437.111/120 Lose Kupplungsscheibe / Loose clutch disc Sonderausführung / Special design	(41) (60)
			 1863 855 000	GR-8	->Chass. 186921 437.111/120 Sonderausführung / Special design mit Anlaufing / with thrust ring	(60) (88)
			 1863 837 002	GR-4	->Chass. 186921 437.111/120 Sonderausführung / Special design mit Anlaufing / with thrust ring	(60) (88)
			 3800 710 003 #  1888 998 902  1862 962 002  3182 003 131	350 20 DUT350/330 350GSDC HHIS-3	Chass. 186922-> 437.111/120	
			 3482 106 133	350 GMF350X	437.123	
			 1861 956 133	350 20 350GTD	437.123	
			 1861 713 133 ●#	350 20 350GSZ	437.123	
			 3182 002 131	HHIS-3	437.123 Immer erneuern / Renew everytime	(30)
			 3800 710 003 #  1888 998 902  1862 962 002  3182 003 131	350 20 DUT350/330 350GSDC HHIS-3	437.123	
			U 1550L 437.125 437.116 U 1550L 437.125 437.116	05.88-	OM356.980, OM357.924, OM366.984, OM356.997, OM357.945	 3482 002 239 #
05.88-	 3482 106 031	360 GMF350X		Chass. 173810->		
	 1862 286 031 #	360 20 360GSDC				
	 3151 051 031	KZI-4		->Chass. 173809		
	 3182 002 131	HHIS-3		Chass. 173810-> Immer erneuern / Renew everytime		(30)
	 3800 710 003 #  1888 998 902  1862 962 002  3182 003 131	350 20 DUT350/330 350GSDC HHIS-3		Sonderausführung / Special design		(60)

		CODE		 Parameter		
--	--	------	--	---	---	---

MERCEDES-BENZ



























Unimog 1400-1750						
U 1600 427.105	01.88-	OM356.956, OM366.949	 3482 002 234	350 GMF350X	->Chass. 173809	
			 3482 106 133	350 GMF350X	Chass. 173810->	
			 1861 956 133	350 20 350GTD		
			 1861 713 133 ●#	350 20 350GSZ		
			 3151 051 031	KZI-4	->Chass. 173809	
			 3182 002 131	HHIS-3	Chass. 173810-> Immer erneuern / Renew everytime	(30)
			 3800 710 002 #  1888 067 031  1861 741 042  3182 003 131	330 20 DUT330 327GSDC HHIS-3	Sonderausführung / Special design	(60)
			 1888 998 201 #	330 24 DUT330	für Fahrzeuge mit Niederdruck-Bremsanlage / for vehicles with low-pressure brakesystem enthält eine Kupplungsscheibe / This part number includes one clutch disc Sonderausführung / Special design	(74) (67) (60)
			 1861 741 042 ▽#	327 20 327GSDC	Anzahl der Beläge / Number of pads: 8 Lose Kupplungsscheibe / Loose clutch disc Sonderausführung / Special design	(3) (41) (60)
			 3182 003 131	HHIS-3	Sonderausführung / Special design Immer erneuern / Renew everytime	(60) (30)
			 3800 710 003 ●#  1888 998 902  1862 962 002  3182 003 131	350 20 DUT350/330 350GSDC HHIS-3	Sonderausführung / Special design	(60)
			U 1600 427.107 U 1600 427.107	09.89- 05.91-	OM356.980, OM357.924, OM366.984, OM356.997, OM357.945	 3482 002 239 #
 3482 106 031	360 GMF350X	Chass. 173810->				
 1862 286 031 #	360 20 360GSDC					
 3182 002 131	HHIS-3	Chass. 173810-> Immer erneuern / Renew everytime				(30)
 3151 051 031	KZI-4	->Chass. 173809				
 1878 992 401 ▽#	350 20 350GSDC	Anzahl der Beläge / Number of pads: 8 Lose Kupplungsscheibe / Loose clutch disc Sonderausführung / Special design				(3) (41) (60)
 1888 998 902 #	350 24 DUT350/ 330	enthält eine Kupplungsscheibe / This part number includes one clutch disc Sonderausführung / Special design				(67) (60)
 1862 962 002 ▽#	350 20 350GSDC	Lose Kupplungsscheibe / Loose clutch disc Sonderausführung / Special design				(41) (60)
 1863 837 002	GR-4	->Chass. 186921 Sonderausführung / Special design mit Anlauftring / with thrust ring				(60) (88)
 1863 855 000	GR-8	->Chass. 186921 Sonderausführung / Special design mit Anlauftring / with thrust ring				(60) (88)
 3800 710 003 #  1888 998 902  1862 962 002  3182 003 131	350 20 DUT350/330 350GSDC HHIS-3	Chass. 186922-> Sonderausführung / Special design				(60)

MERCEDES-BENZ

Unimog 1400-1750						
U 1650,U 1650L 427.115/116	01.88-	OM356.956, OM366.948, OM366.949	 3482 002 234	350 GMF350X	->Chass. 173809	
			 3482 106 133	350 GMF350X	Chass. 173810->	
			 1861 956 133	350 20 350GTD		
			 1861 713 133 ●#	350 20 350GSZ		
			 3151 051 031	KZI-4	->Chass. 173809	
			 3182 002 131	HHIS-3	Chass. 173810-> Immer erneuern / Renew everytime	(30)
			 3482 012 237	330 GMF330	Sonderausführung / Special design	(60)
			 1861 667 034	330 20 330GSB	Sonderausführung / Special design	(60)
			 3182 002 131	HHIS-3	Sonderausführung / Special design Immer erneuern / Renew everytime	(60) (30)
			 3800 710 002 #  1888 067 031  1861 741 042  3182 003 131	330 20 DUT330 327GSDC HHIS-3	Sonderausführung / Special design	(60)
			 1888 998 201 #	330 24 DUT330	für Fahrzeuge mit Niederdruck-Bremsanlage / for vehicles with low-pressure brakesystem enthält eine Kupplungsscheibe / This part number includes one clutch disc Sonderausführung / Special design	(74) (67) (60)
			 1861 741 042 ▽#	327 20 327GSDC	Anzahl der Beläge / Number of pads: 8 Lose Kupplungsscheibe / Loose clutch disc Sonderausführung / Special design	(3) (41) (60)
			 3182 003 131	HHIS-3	Sonderausführung / Special design Immer erneuern / Renew everytime	(60) (30)
			 3800 710 003 ●#  1888 998 902  1862 962 002  3182 003 131	350 20 DUT350/330 350GSDC HHIS-3	Sonderausführung / Special design	(60)
			U 1650,U 1650L 427.118 427.117 U 1650,U 1650L 427.118 427.117 U 1700T 437.000 U 1750,U 1750L 437.112/113 U 1750,U 1750L 437.131 437.130	09.89-	OM356.980, OM357.924, OM366.984, OM356.957, OM366.963, OM356.997, OM357.945, OM356.981	 3482 002 234
05.91-	 3482 106 133	350 GMF350X		Chass. 173810->		
09.88-	 1861 956 133	350 20 350GTD				
09.88-	 1861 713 133 ●#	350 20 350GSZ				
09.88-	 3151 051 031	KZI-4		->Chass. 173809		
	 3182 002 131	HHIS-3		Chass. 173810-> Immer erneuern / Renew everytime		(30)
	 1888 998 902 #	350 24 DUT350/ 330		enthält eine Kupplungsscheibe / This part number includes one clutch disc		(67)
	 1862 962 002 ▽#	350 20 350GSDC		Lose Kupplungsscheibe / Loose clutch disc		(41)
	 1888 998 902 #	350 24 DUT350/ 330		enthält eine Kupplungsscheibe / This part number includes one clutch disc Sonderausführung / Special design		(67) (60)
	 1862 962 002 ▽#	350 20 350GSDC		Lose Kupplungsscheibe / Loose clutch disc Sonderausführung / Special design		(41) (60)
	 1863 837 002	GR-4		->Chass. 186921 Sonderausführung / Special design mit Anlauftring / with thrust ring		(60) (88)
	 1863 855 000	GR-8		->Chass. 186921 Sonderausführung / Special design mit Anlauftring / with thrust ring		(60) (88)
	 3800 710 003 #  1888 998 902  1862 962 002  3182 003 131	350 20 DUT350/330 350GSDC HHIS-3		Chass. 186922-> Sonderausführung / Special design		(60)





























MERCEDES-BENZ

Unimog 1400-1750

U 1700, U 1700 L 436.342/343 437.100 436.340/341	09.88-	OM382.950, OM356.957, OM366.963	 3482 002 234	350 GMF350X	436.340-341-342-343				
			 1861 956 133	350 20 350GTD	436.340-341-342-343				
			 1861 713 133 ●#	350 20 350GSZ	436.340-341-342-343				
			 3151 051 031	KZI-4	436.340-341-342-343				
			 3482 002 234	350 GMF350X	->Chass. 173809 437.100				
			 3482 106 133	350 GMF350X	Chass. 173810-> 437.100				
			 1861 956 133	350 20 350GTD	437.100				
			 1861 713 133 ●#	350 20 350GSZ	437.100				
			 3151 051 031	KZI-4	->Chass. 173809 437.100				
			 3182 002 131	HHIS-3	Chass. 173810-> 437.100 Immer erneuern / Renew everytime	(30)			
			 1888 998 902 #	350 24 DUT350/ 330	437.100/110 enthält eine Kupplungsscheibe / This part number includes one clutch disc	(67)			
			 1862 962 002 ▽#	350 20 350GSDC	437.100/110 Lose Kupplungsscheibe / Loose clutch disc	(41)			
			 1888 998 902 #	350 24 DUT350/ 330	437.100 enthält eine Kupplungsscheibe / This part number includes one clutch disc Sonderausführung / Special design	(67) (60)			
			 1862 962 002 ▽#	350 20 350GSDC	437.100 Lose Kupplungsscheibe / Loose clutch disc Sonderausführung / Special design	(41) (60)			
			 1863 837 002	GR-4	->Chass. 186921 437.100 Sonderausführung / Special design mit Anlauftring / with thrust ring	(60) (88)			
			 1863 855 000	GR-8	->Chass. 186921 437.100 Sonderausführung / Special design mit Anlauftring / with thrust ring	(60) (88)			
			 3800 710 003 #  1888 998 902  1862 962 002  3182 003 131	350 20 DUT350/330 350GSDC HHIS-3	Chass. 186922-> 437.100 Sonderausführung / Special design	(60)			
			U 1700,U 1700L 435.111 435.131 435.110 435.120 435.141 435.117 435.113 435.115 435.121			 3482 012 237	330 GMF330	435.110/113/117/120-121/131/141	
						 1861 667 034	330 20 330GSB	435.110/113/117/120-121/131/141	
 3151 051 031	KZI-4	435.110/113/117/120-121/131/141							
 1888 067 042 #	330 22 DUT330/ 310	435.110-111/113/115 enthält eine Kupplungsscheibe / This part number includes one clutch disc enthält Druckplattenbefestigungsschrauben / includes bolt for pressure plate mounting				(67) (65)			
 1861 741 042 #	327 20 327GSDC	435.110-111/113/115 Anzahl der Beläge / Number of pads: 8 Lose Kupplungsscheibe / Loose clutch disc				(3) (41)			
 1863 837 002	GR-4	435.110-111/113/115 mit Anlauftring / with thrust ring				(88)			
 1863 855 000	GR-8	435.110-111/113/115 mit Anlauftring / with thrust ring				(88)			



















		CODE				
--	--	------	--	---	---	---













MERCEDES-BENZ

Unimog 1400-1750						
U 1700,U 1700L 435.111 435.110	05.78 - 09.88	OM353.959	 3482 012 211	330 GMF330	->Chass. 002154 435.111	
			 3482 012 237	330 GMF330	Chass. 002155-> 435.111	
			 1861 594 034 #	330 20 330GSZ	->Chass. 002154 435.111	
			 1861 667 034	330 20 330GSB	Chass. 002155-> 435.111	
			 3151 051 031	KZI-4	435.111	
			 3482 012 237	330 GMF330	435.110	
			 1861 667 034	330 20 330GSB	435.110	
			 3151 051 031	KZI-4	435.110	
			 1888 067 042 #	330 22 DUT330/ 310	enthält eine Kupplungsscheibe / This part number includes one clutch disc enthält Druckplattenbefestigungsschrauben / includes bolt for pressure plate mounting	(67) (65)
			 1861 741 042 #	327 20 327GSDC	Anzahl der Beläge / Number of pads: 8 Lose Kupplungsscheibe / Loose clutch disc	(3) (41)
			 1863 837 002	GR-4	mit Anlauffring / with thrust ring	(88)
 1863 855 000	GR-8	mit Anlauffring / with thrust ring	(88)			
U 1700L 435.113	05.78 - 09.88	OM353.959	 3482 012 237	330 GMF330		
			 1861 667 034	330 20 330GSB		
			 3151 051 031	KZI-4		
			 1888 067 042 #	330 22 DUT330/ 310	enthält eine Kupplungsscheibe / This part number includes one clutch disc enthält Druckplattenbefestigungsschrauben / includes bolt for pressure plate mounting	(67) (65)
			 1861 741 042 #	327 20 327GSDC	Anzahl der Beläge / Number of pads: 8 Lose Kupplungsscheibe / Loose clutch disc	(3) (41)
			 1863 837 002	GR-4	mit Anlauffring / with thrust ring	(88)
			 1863 855 000	GR-8	mit Anlauffring / with thrust ring	(88)
Unimog 1800-2050						
U 1800 437.102 U 1800T 437.002 U 1850,L 437.115 437.114 U 1850,U 1850L 437.133 437.115 437.114	04.92 -	OM356.998	 3482 106 031	360 GMF350X		
			 1862 286 031 #	360 20 360GSDC		
	04.92 -		 3151 051 031	KZI-4	->Chass. 173809	
			 3182 002 131	HHIS-3	Chass. 173810-> Immer erneuern / Renew everytime	(30)
			 1888 998 902 #	350 24 DUT350/ 330	enthält eine Kupplungsscheibe / This part number includes one clutch disc	(67)
			 1862 962 002 ▽#	350 20 350GSDC	Lose Kupplungsscheibe / Loose clutch disc	(41)
			 3800 710 003 #	350 20 DUT350/330	Je nach Kundenwunsch mit unterschiedlicher Kupplung / Equipped with different clutch according to customer requirement	(35)
			 1888 998 902	350GSDC	Sonderausführung / Special design	(60)
U 1800,T 437.000-160			 1888 998 902 #	350 24 DUT350/ 330	enthält eine Kupplungsscheibe / This part number includes one clutch disc	(67)
			 1862 962 002 ▽#	350 20 350GSDC	Lose Kupplungsscheibe / Loose clutch disc	(41)

		CODE				
--	--	------	--	---	---	---



























MERCEDES-BENZ

Unimog 1800-2050						
U 1800,T 437.002				3482 002 234	350 GMF350X	->Chass. 173809
				3482 106 133	350 GMF350X	Chass. 173810->
				1861 956 133	350 20 350GTD	
				1861 713 133 ●#	350 20 350GSZ	
				3151 051 031	KZI-4	->Chass. 173809
				3182 002 131	HHIS-3	Chass. 173810-> Immer erneuern / Renew everytime (30)
U 1800,T 437.102				3482 106 031	360 GMF350X	
				1862 286 031 #	360 20 360GSDC	
				3151 051 031	KZI-4	->Chass. 173809
				3182 002 131	HHIS-3	Chass. 173810-> Immer erneuern / Renew everytime (30)
				1878 992 401 ▽#	350 20 350GSDC	Anzahl der Beläge / Number of pads: 8 (3) Lose Kupplungsscheibe / Loose clutch disc (41) Sonderausführung / Special design (60)
				3182 003 131	HHIS-3	Sonderausführung / Special design (60) Immer erneuern / Renew everytime (30)
				3800 710 003 # ⊗ 1888 998 902 ⊗ 1862 962 002 🔧 3182 003 131	350 20 DUT350/330 350GSDC HHIS-3	Je nach Kundenwunsch mit unterschiedlicher Kupplung / Equipped with different clutch according to customer requirement (35) Sonderausführung / Special design (60)
U 1850 L/38 437.133				3482 106 031	360 GMF350X	
				1862 286 031 #	360 20 360GSDC	
				3151 051 031	KZI-4	->Chass. 173809
				3182 002 131	HHIS-3	Chass. 173810-> Immer erneuern / Renew everytime (30)
				3800 710 003 # ⊗ 1888 998 902 ⊗ 1862 962 002 🔧 3182 003 131	350 20 DUT350/330 350GSDC HHIS-3	Je nach Kundenwunsch mit unterschiedlicher Kupplung / Equipped with different clutch according to customer requirement (35) Sonderausführung / Special design (60)

Unimog 2100-2450						
U 2100 437.105	09.89-	OM356.980, OM366.984, OM356.997, OM357.945		3482 002 239 #	360 GMF350X	->Chass. 173809
U 2100T 437.002	09.89-			3482 106 031	360 GMF350X	Chass. 173810->
U 2150,U 2150L 437.118 437.117 437.136	09.89-			1862 286 031 #	360 20 360GSDC	
U 2400 437.105	05.91-			3151 051 031	KZI-4	->Chass. 173809
U 2450,U 2450L 437.117/118 437.136	05.91-			3182 002 131	HHIS-3	Chass. 173810-> Immer erneuern / Renew everytime (30)
				1888 998 902 #	350 24 DUT350/ 330	enthält eine Kupplungsscheibe / This part number includes one clutch disc (67)
				1862 962 002 ▽#	350 20 350GSDC	Lose Kupplungsscheibe / Loose clutch disc (41)
				1878 992 401 ▽#	350 20 350GSDC	Anzahl der Beläge / Number of pads: 8 (3) Lose Kupplungsscheibe / Loose clutch disc (41) Sonderausführung / Special design (60)
				1888 998 902 #	350 24 DUT350/ 330	enthält eine Kupplungsscheibe / This part number includes one clutch disc (67) Sonderausführung / Special design (60)
				1862 962 002 ▽#	350 20 350GSDC	Lose Kupplungsscheibe / Loose clutch disc (41) Sonderausführung / Special design (60)
				1863 837 002	GR-4	->Chass. 186921 Sonderausführung / Special design mit Anlauftring / with thrust ring (60) (88)
				1863 855 000	GR-8	->Chass. 186921 Sonderausführung / Special design mit Anlauftring / with thrust ring (60) (88)
				3800 710 003 #	350 20	Chass. 186922->

		CODE				
--	--	------	--	---	---	---



















MERCEDES-BENZ

Unimog 2100-2450						
U 2150 437.135	09.89-	OM366.984, OM356.997	 3482 002 239 #	360 GMF350X	->Chass. 173809	
			 3482 106 031	360 GMF350X	Chass. 173810->	
			 1862 286 031 #	360 20 360GSDC		
			 3151 051 031	KZI-4	->Chass. 173809	
			 3182 002 131	HHIS-3	Chass. 173810-> Immer erneuern / Renew everytime	(30)
			 1888 998 902 #	350 24 DUT350/ 330	enthält eine Kupplungsscheibe / This part number includes one clutch disc Sonderausführung / Special design	(67) (60)
			 1862 962 002 ▽#	350 20 350GSDC	Lose Kupplungsscheibe / Loose clutch disc Sonderausführung / Special design	(41) (60)
U 2150,U 2150L 437.171 437.118 437.136 437.117 437.170	09.89-	OM357.924, OM366.984, OM356.997	 3482 002 239 #	360 GMF350X	->Chass. 173809 437.117-118/136	
			 3482 106 031	360 GMF350X	Chass. 173810-> 437.117-118/136	
			 1862 286 031 #	360 20 360GSDC	437.117-118/136	
			 3151 051 031	KZI-4	->Chass. 173809 437.117-118/136	
			 3182 002 131	HHIS-3	Chass. 173810-> 437.117-118/136 Immer erneuern / Renew everytime	(30)
			 1888 998 902 #	350 24 DUT350/ 330	437.117-118/136 enthält eine Kupplungsscheibe / This part number includes one clutch disc	(67)
			 1862 962 002 ▽#	350 20 350GSDC	437.117-118/136 Lose Kupplungsscheibe / Loose clutch disc	(41)
			 1878 992 401 ▽#	350 20 350GSDC	437.117-118/136 Anzahl der Beläge / Number of pads: 8 Lose Kupplungsscheibe / Loose clutch disc Sonderausführung / Special design	(3) (41) (60)
			 1888 998 902 #	350 24 DUT350/ 330	437.117-118/136 enthält eine Kupplungsscheibe / This part number includes one clutch disc Sonderausführung / Special design	(67) (60)
			 1862 962 002 ▽#	350 20 350GSDC	437.117-118/136 Lose Kupplungsscheibe / Loose clutch disc Sonderausführung / Special design	(41) (60)
			 1863 837 002	GR-4	->Chass. 186921 437.117-118/136 Sonderausführung / Special design mit Anlauffring / with thrust ring	(60) (88)
			 1863 855 000	GR-8	->Chass. 186921 437.117-118/136 Sonderausführung / Special design mit Anlauffring / with thrust ring	(60) (88)
			 3800 710 003 #	350 20 DUT350/330	Chass. 186922-> 437.117-118/136	
			 1888 998 902	350GSDC	Sonderausführung / Special design	(60)
			 1862 962 002	HHIS-3		
			 3182 003 131			
			 3482 106 031	360 GMF350X	437.170-171	
 1862 286 031 #	360 20 360GSDC	437.170-171				
 3182 002 131	HHIS-3	437.170-171 Immer erneuern / Renew everytime	(30)			

















		CODE				
--	--	------	--	---	---	---

MERCEDES-BENZ

Unimog 2100-2450

U 2400TG 437.182	07.93-	OM356.980, OM357.945	 3482 106 031	360 GMF350X		
			 1862 286 031 #	360 20 360GSDC		
			 3182 002 131	HHIS-3	Immer erneuern / Renew everytime	(30)
			 1888 998 902 #	350 24 DUT350/ 330	enthält eine Kupplungsscheibe / This part number includes one clutch disc	(67)
			 1862 962 002 #	350 20 350GSDC		
			 1863 837 002	GR-4	->Chass. 186921 mit Anlauftring / with thrust ring	(88)
			 1863 855 000	GR-8	->Chass. 186921 mit Anlauftring / with thrust ring	(88)
			 3800 710 003 #  1888 998 902  1862 962 002  3182 003 131	350 20 DUT350/330 350GSDC HHIS-3	Chass. 186922->	
U 2450L 437.156	07.93-	OM356.980, OM357.945	 3482 106 031	360 GMF350X		
			 1862 286 031 #	360 20 360GSDC		
			 3182 002 131	HHIS-3	Immer erneuern / Renew everytime	(30)
			 3800 710 003 #  1888 998 902  1862 962 002  3182 003 131	350 20 DUT350/330 350GSDC HHIS-3	Sonderausführung / Special design	(60)

















Unimog 2500-5023

U 3000 437.425/426 437.421 437.420 U 3000 437.425 437.420 U 4000 436.330 U 4000 437.420/421 437.425/426 U 4000 437.425 436.330 437.426 437.420/421	09.02-	OM900.920, OM904LA, OM904.953, OM904.952	 3482 000 462	362 MF362		
	09.02-		 1878 600 560	360 18 360CBC	Anzahl der Beläge / Number of pads: 9 Je nach Kundenwunsch mit unterschiedlicher Kupplung / Equipped with different clutch according to customer requirement	(3) (35)
	01.02-		 1878 052 842	362 18 362WGTB	Je nach Kundenwunsch mit unterschiedlicher Kupplung / Equipped with different clutch according to customer requirement	(35)
	09.02-		 1878 001 939 HD●	362 18 362WGTB	Je nach Kundenwunsch mit unterschiedlicher Kupplung / Equipped with different clutch according to customer requirement	(35)
	09.02-		 3182 600 101	HHIS-3	mit Sensor / with sensor Füllmedium: Bremsflüssigkeit / Fill Medium: Brake Fluid Immer erneuern / Renew everytime	(92) (25) (30)
	U 4000 437.421 437.420 437.425/426		09.02-	OM904LA	 3482 000 462	362 MF362
 1878 600 560		360 18 360CBC			437.421/426 Anzahl der Beläge / Number of pads: 9	(3)
 3182 600 101		HHIS-3			437.421/426 mit Sensor / with sensor Füllmedium: Bremsflüssigkeit / Fill Medium: Brake Fluid Immer erneuern / Renew everytime	(92) (25) (30)
U 4023 437.427	05.13-	OM934.974	 3400 127 701	362 18 MF362		
			 3482 000 462  1878 052 842	362 18 362WGTB		
			 3400 710 008  3482 000 462  1878 052 842  3182 600 101	362 18 MF362 362WGTB HHIS-3	mit Sensor / with sensor Füllmedium: Bremsflüssigkeit / Fill Medium: Brake Fluid	(92) (25)
			 1863 869 044	55		





		CODE				
--	--	------	--	---	---	---

MERCEDES-BENZ

Unimog 2500-5023











U 5000 437.436 437.465 437.460 437.430/431 437.435	09.02-	OM924.916	 3482 000 462	362 MF362	437.430/435	
			 1878 600 560	360 18 360CBC	437.430/435 Anzahl der Beläge / Number of pads: 9 Je nach Kundenwunsch mit unterschiedlicher Kupplung / Equipped with different clutch according to customer requirement	(3) (35)
			 1878 052 842	362 18 362WGTB	437.430/435 Je nach Kundenwunsch mit unterschiedlicher Kupplung / Equipped with different clutch according to customer requirement	(35)
			 1878 001 939 HD	362 18 362WGTB	437.430/435 Je nach Kundenwunsch mit unterschiedlicher Kupplung / Equipped with different clutch according to customer requirement	(35)
			 3182 600 101	HHIS-3	437.430/435 mit Sensor / with sensor Füllmedium: Bremsflüssigkeit / Fill Medium: Brake Fluid Immer erneuern / Renew everytime	(92) (25) (30)
			 3482 000 462	362 MF362	437.460/465	
		OM924.923	 1878 600 560	360 18 360CBC	437.460/465 Anzahl der Beläge / Number of pads: 9	(3)
			 3182 600 101	HHIS-3	437.460/465 mit Sensor / with sensor Füllmedium: Bremsflüssigkeit / Fill Medium: Brake Fluid Immer erneuern / Renew everytime	(92) (25) (30)
			 3482 000 462	362 MF362	437.431/436	
		OM924LA	 1878 600 560	360 18 360CBC	437.431/436 Anzahl der Beläge / Number of pads: 9	(3)
			 3182 600 101	HHIS-3	437.431/436 mit Sensor / with sensor Füllmedium: Bremsflüssigkeit / Fill Medium: Brake Fluid Immer erneuern / Renew everytime	(92) (25) (30)
			 3482 000 463	395 MF395		
U 5000 437.470	11.02-	OM906.935	 3182 600 101	HHIS-3	mit Sensor / with sensor Füllmedium: Bremsflüssigkeit / Fill Medium: Brake Fluid Immer erneuern / Renew everytime	(92) (25) (30)
			 U 5023 437.437	05.13-	OM934	 3182 600 101
 1863 869 044	55	437.437				











ZETROS 09.08 -



1833 A 949.016 2733 A 949.066	09.08 - 09.08 -	OM926.935, OM926.947, OM926.936	 3400 700 477	395 18 MF395		
			 3482 000 679	395WGTZC		
			 1878 006 637			
			 3182 600 141		für / for: SA 504673-16 Getr. / GBox: G131-9 ohne Sensor / without sensor Füllmedium: Mineralöl / Fill Medium: Mineral Oil Immer erneuern / Renew everytime	(69) (105) (26) (30)
			3182 600 166		für / for: SA 504673-17/27/35 Getr. / GBox: G131-9 mit Sensor / with sensor Füllmedium: Mineralöl / Fill Medium: Mineral Oil Immer erneuern / Renew everytime	(69) (92) (26) (30)
			3182 998 501	HHIS-3	für / for: SA 504673-10/22 Getr. / GBox: G131-9 ohne Sensor / without sensor Füllmedium: Bremsflüssigkeit / Fill Medium: Brake Fluid Immer erneuern / Renew everytime	(69) (105) (25) (30)
 1863 869 040			nur als Ersatz für angegebene OE-Nr. / only for the listed OE-Numbers	(100)		

		CODE				
--	--	------	--	---	---	---

MERCEDES-BENZ

206						
L 206		A60		3082 121 031	228 M228	
				1878 634 052	228 10 228GSB	
L 206 D	-05.72	OM615		1878 634 064	228 24 228CB	
				3151 270 602	KT-0	
				1805 041 200		
L 206 DG (2,4/2,5 to)		OM615		1878 634 064	228 24 228CB	->Chass. 108506
				3082 121 031	228 M228	->Chass. 108506 Nur verbauen, wenn Fahrzeug mit M-Kupplung ausgerüstet ist / Only install if the vehicle is equipped with an M-type clutch (52)
				3082 078 032	215 M215	Chass. 108507->
L 206 DG (2,8 to)		OM615		1878 634 064	228 24 228CB	
				3082 121 031	228 M228	Nur verbauen, wenn Fahrzeug mit M-Kupplung ausgerüstet ist / Only install if the vehicle is equipped with an M-type clutch (52)

306						
L 306		A60		3082 121 031	228 M228	
				1878 634 052	228 10 228GSB	
L 306 D	-05.72	OM615		1878 634 064	228 24 228CB	
				3151 270 602	KT-0	
				1805 041 200		
L 306 D L 306 DG (3,1/3,5 to)	06.72-	OM615		1878 634 064	228 24 228CB	
				3082 121 031	228 M228	Nur verbauen, wenn Fahrzeug mit M-Kupplung ausgerüstet ist / Only install if the vehicle is equipped with an M-type clutch (52)
L 306 D		OM615		3082 121 031	228 M228	
L 306 DG (4,1/5,0 to)		A70, OM615		1878 634 064	228 24 228CB	
				3082 121 031	228 M228	Nur verbauen, wenn Fahrzeug mit M-Kupplung ausgerüstet ist / Only install if the vehicle is equipped with an M-type clutch (52)

307						
L 307 606.244 606.044 606.006-045 606.200-204 606.421 606.021-024 606.245 606.041 606.241 606.000-004 606.240 606.040 606.206-208 606.226-228 606.221-224 606.026-028		A70		1861 574 132 ▲#	228 24 228CPB	606.026-028/040-041/044-045/000-004/006-008 /021-024/226-228/240-241/244-245/421/200-204 /206-208/221-224
				3082 121 031	228 M228	606.226-228/240-241/244-245/421/200-204 /206-208/221-224 Nur verbauen, wenn Fahrzeug mit M-Kupplung ausgerüstet ist / Only install if the vehicle is equipped with an M-type clutch (52)

310						
310 D 690.311 690.340 690.330 690.341 690.331				1878 000 615 ▲	240 26 240VTB	für OE-Nummer / for OE number 690 250 74 03 für / for: Sprinter Argentina nur in Verbindung mit / only in connection with: 3082 307 531 (83) (69) (101)







311						
L,LA,LP,LAP,LG 311				1860 062 037 #	280 10 280Z	





312						
L,LA,LP,LAP,LG 312				1860 062 037 #	280 10 280Z	

		CODE				
--	--	------	--	---	---	---

MERCEDES-BENZ

315						
LP 315				1881 039 532 #	350 G350KR	
				1861 034 147 #	350 10	









319						
L 319 B		M121		1881 059 208	200 KS200	->Chass. 004861
				1861 123 236	200 10 200PE	->Chass. 004861
				3082 121 031	228 M228	Chass. 004862-> Nur verbauen, wenn Fahrzeug mit M-Kupplung ausgerüstet ist / Only install if the vehicle is equipped with an M-type clutch (52)
L 319 D		OM621, 636		1881 059 208	200 KS200	->Chass. 082858
				1861 123 236	200 10 200PE	->Chass. 082858
				3082 121 031	228 M228	Chass. 082859-> Nur verbauen, wenn Fahrzeug mit M-Kupplung ausgerüstet ist / Only install if the vehicle is equipped with an M-type clutch (52)

322						
L,LA 322 327		OM352		1861 919 134	280 10 280GTZ	
				1861 919 134	280 10 280GTZ	
				3151 095 043	KZI-3	
LAK,LAS,LK,LPS,LS 322 327 LAP 322 LP 322	02.61 - 02.61 -			1861 919 134	280 10 280GTZ	

323						
LA,LAK 323				1860 062 037 #	280 10 280Z	

325						
L 325				1861 034 147 #	350 10	







326						
L,LP 326				1881 041 656 #	380 G380	





329						
L 329				1881 039 532 #	350 G350KR	Chass. 9500075->
				1861 034 147 #	350 10	
LA 329				1882 110 532 #	350 GF350	
				1861 034 147 #	350 10	
LA 329				1881 039 532 #	350 G350KR	Chass. 9500092->
				1861 034 147 #	350 10	
LP 329				1881 039 532 #	350 G350KR	Chass. 9500032->
				1861 034 147 #	350 10	

		CODE				
--	--	------	--	---	---	---



MERCEDES-BENZ

330						
L 330				1881 039 532 #	350 G350KR	Chass. 9500319->
				1861 034 147 #	350 10	

331						
L 331				1881 039 532 #	350 G350KR	Chass. 9500062->
				1861 034 147 #	350 10	
LA 331				1881 039 532 #	350 G350KR	Chass. 9500009->
				1861 034 147 #	350 10	
LP 331				1881 039 532 #	350 G350KR	Chass. 9500129->
				1861 034 147 #	350 10	



332						
L 332				1882 110 532 #	350 GF350	
				1881 039 532 #	350 G350KR	Chass. 9500277->
				1861 034 147 #	350 10	
LA 332				1881 039 532 #	350 G350KR	Chass. 9500053->
				1861 034 147 #	350 10	



333						
LP 333				1881 041 656 #	380 G380	



334						
L,LA 334				1882 166 737	380 GF380	
				1863 010 100	GR-4	mit Anlauftring / with thrust ring (88)
L,LP,LK,LS 334				1881 041 656 #	380 G380	

335						
335				1882 166 737	380 GF380	
				1863 010 100	GR-4	mit Anlauftring / with thrust ring (88)

336						
336				1882 166 737	380 GF380	
				1863 010 100	GR-4	mit Anlauftring / with thrust ring (88)

337						
337				1882 110 542 ▲	350 GF350	
				1878 001 074	350 10 350GTZ	





354						
L,LP 354				1882 110 542 ▲	350 GF350	
				1878 001 074	350 10 350GTZ	







406						
L 406 D	01.72-	OM636, OM621		1881 059 208	200 KS200	->Chass. 082858
				1861 123 236	200 10 200PE	->Chass. 082858















		CODE				
--	--	------	--	---	---	---

MERCEDES-BENZ

406						
L 406 D	-12.80	OM636, OM621		3082 121 031	228 M228	Chass. 082859-> Nur verbauen, wenn Fahrzeug mit M-Kupplung ausgerüstet ist / Only install if the vehicle is equipped with an M-type clutch (52)

408						
L 408 D		OM314		1882 205 234	250 HBX250	
				1882 600 122 ●	250 HBX250	
				1861 291 136	250 10 250GTZ	
				1878 634 082 ●	250 10 250GTZ	
				3151 095 043	KZI-3	









409							
LKO 409 309.030-035		M121		1881 059 208	200 KS200	->Chass. 004861	
				1861 123 236	200 10 200PE	->Chass. 004861	
		M115, 121		1878 634 052	228 10 228GSB	->Chass. 145736	
				3082 121 031	228 M228	->Chass. 145736 Nur verbauen, wenn Fahrzeug mit M-Kupplung ausgerüstet ist / Only install if the vehicle is equipped with an M-type clutch (52)	
		OM115, 121		3082 121 031	228 M228	Chass. 145737->	
				1878 634 052	228 10 228GSB	Chass. 145737 - Chass. 556499	
				3151 000 206	KZIS-1	Chass. 184087 - Chass. 556499	

508						
L 508		OM314		1882 205 234	250 HBX250	Chass. 145737 LHD - Mot. 678174 LHD Chass. 148037 RHD - Mot. 678174 RHD
				1882 600 122 ●	250 HBX250	Chass. 145737 LHD - Mot. 678174 LHD Chass. 148037 RHD - Mot. 678174 RHD
				1861 291 136	250 10 250GTZ	Chass. 145737 LHD - Mot. 678174 LHD Chass. 148037 RHD - Mot. 678174 RHD
				1878 634 082 ●	250 10 250GTZ	Chass. 145737 LHD - Mot. 678174 LHD Chass. 148037 RHD - Mot. 678174 RHD
				3151 033 031	KZI-3	Chass. 145737 LHD - Mot. 678174 LHD Chass. 148037 RHD - Mot. 678174 RHD
L 508 D LS 508 D		OM314		1882 205 234	250 HBX250	
				1882 600 122 ●	250 HBX250	
				1861 291 136	250 10 250GTZ	
				1878 634 082 ●	250 10 250GTZ	
	3151 095 043	KZI-3				
L 508 D 667.361		OM601		3082 121 031	228 M228	
				1861 936 142	228 10 228VTB	
				3151 000 206	KZIS-1	
LF 508 D 310.350		OM314		1800 125 201	250 10	Mot. 410748-> 310.350
				3151 033 031	KZI-3	->Mot. 410747 310.350



















		CODE				
--	--	------	--	---	---	---

MERCEDES-BENZ











508

LK 508 DG 309.445 309.440-442 309.444 LK 508 DG 309.440-445		OM314	 1800 125 201  1882 205 234  1861 291 136  3151 044 031	250 10 HBX250 250GTZ KZI-3	Mot. 678175-> 309.440-445	
			 3151 095 043	KZI-3	->Chass. 145736 LHD ->Chass. 148036 RHD 309.440-445	
			3151 033 031	KZI-3	Chass. 145737 LHD - Mot. 678174 LHD Chass. 148037 RHD - Mot. 678174 RHD 309.440-445	
LP 508 DG 309			 1882 205 234	250 HBX250	309	
			1882 600 122 ●	250 HBX250	309	
			 1861 291 136	250 10 250GTZ	309	
			1878 634 082 ●	250 10 250GTZ	309	
			 3151 033 031	KZI-3	309	

608



LP 608, LPL 608 314.056/057 314.060 314.253 314.820 314.055 314.252 314.052/053 314.058 314.251 314.059 314.051 LPS 608, LPLS 608 314.062/063 314.263	09.63 - 12.84	OM314	 1800 125 201  1882 205 234  1861 291 136  3151 044 031	250 10 HBX250 250GTZ KZI-3	Mot. 410748-> 314.251-252-253/263/051-060/062-063/072 /085-087	
	09.63 - 12.84		 3151 095 043	KZI-3	->Chass. 4282707 314.051-060/062-063/072/085-087	
			3151 033 031	KZI-3	->Mot. 410747 314.251-252-253/263/051-060/062-063/072 /085-087	
LPK 608 314.072	10.69 - 10.77	OM314	 1800 125 201  1882 205 234  1861 291 136  3151 044 031	250 10 HBX250 250GTZ KZI-3	Mot. 410748-> 314.051-060/062-063/072/085-087	
			 3151 095 043	KZI-3	->Chass. 4282707 314.051-060/062-063/072/085-087	
			3151 033 031	KZI-3	Chass. 4282708 - Mot. 410747 314.051-060/062-063/072/085-087	
LPKF 608 314.081-083 LPKO 608 314.075 314.077	09.63 - 12.84	OM314.944, OM314.910	 1800 125 201  1882 205 234  1861 291 136  3151 044 031	250 10 HBX250 250GTZ KZI-3	Mot. 410748-> 314.077/081-083	
	02.66 - 07.77		 3151 095 043	KZI-3	->Chass. 4282707 314.077/081-083	
			3151 033 031	KZI-3	Chass. 4282708 - Mot. 410747 314.077/081-083	
LT 608 D 310.100		OM314	 1800 125 201  1882 205 234  1861 291 136  3151 044 031	250 10 HBX250 250GTZ KZI-3	310.100	

709







709 673.003 673.002 673.001 709 K 673.040	03.84 - 12.98	OM364	 3482 046 031 #	280 MF280		
	03.84 - 10.90		 1861 919 134	280 10 280GTZ		
			 3482 008 038	310 MF310	für / for: SA24481-01 Sonderausführung / Special design	(69) (60)
			 1861 303 248	310 10 310GSB	für / for: SA24481-01 Sonderausführung / Special design	(69) (60)
			 3151 044 031	KZI-3		
LP 709, LPL 709 314.052 314.251/252 314.051 314.253/254 314.053 314.255 LPK 709 314.072 LPKF 709 314.083 314.082 314.081 LPS 709, LPLS 709 314.063 314.263	09.63 - 12.84	OM314	 1800 125 201  1882 205 234  1861 291 136  3151 044 031	250 10 HBX250 250GTZ KZI-3	Mot. 678175->	
	11.77 - 12.84		 3151 095 043	KZI-3	->Chass. 4282707	
	09.63 - 12.84		3151 033 031	KZI-3	Chass. 4282708 - Mot. 678174	





		CODE				
--	--	------	--	---	---	---

MERCEDES-BENZ

709						
LPKO 709 314.077 314.075	02.66 - 07.77	OM314.944, OM314.910		1800 125 201 ⊗ 1882 205 234 ⊗ 1861 291 136 ⊙ 3151 044 031	250 10 HBX250 250GTZ KZI-3	Mot. 410748->
				3151 095 043	KZI-3	->Chass. 4282707
				3151 033 031	KZI-3	Chass. 4282708 - Mot. 410747

710						
L,LK,LS 710 323				1860 062 037 #	280 10 280Z	323

























711						
711 673.007/008 673.006	03.94 - 12.98	OM354.900		3482 008 038	310 MF310	
				1862 299 032	310 10 310WGSZ	
				3151 044 031	KZI-3	
711 673.308 673.307 673.306	03.96 - 12.98	OM904LA		3400 127 701 ☉ ⊗ 3482 000 462 ⊗ 1878 052 842	362 18 MF362 362WGTB	
				3400 700 484 HD ● ☉ ⊗ 3482 000 462 ⊗ 1878 006 757	362 18 MF362 362WGTB	
				3151 170 131	KZIZ-3	

808						
LP 808, LPL 808 314.820 316.253 316.052 316.251/252 316.051 316.053 314.830 LPK 808 316.072 LPKF 808, LPKF 809 316.082/083 316.081	09.63 - 12.84	OM314		1800 125 201 ⊗ 1882 205 234 ⊗ 1861 291 136 ⊙ 3151 044 031	250 10 HBX250 250GTZ KZI-3	Mot. 410748-> 316.051-054/072/081-083/085-087
	10.69 - 10.77			3151 095 043	KZI-3	->Chass. 4282707 316.051-054/072/081-083/085-087
	10.69 - 10.77			3151 033 031	KZI-3	Chass. 4282708 - Mot. 410747 316.051-054/072/081-083/085-087
LPL 808 316.252/253 316.251		OM314		1800 125 201 ⊗ 1882 205 234 ⊗ 1861 291 136 ⊙ 3151 044 031	250 10 HBX250 250GTZ KZI-3	Mot. 678175-> 316.251-252-253
				3151 033 031	KZI-3	->Mot. 678174 316.251-252-253











809							
809 673.014 673.010-013 809 K 673.042	03.84 - 12.98	OM364		3482 046 031 #	280 MF280		
	03.84 - 12.98			1861 919 134	280 10 280GTZ		
				3482 008 038	310 MF310	für / for: SA24481-01 Sonderausführung / Special design	(69) (60)
				1861 303 248	310 10 310GSB	für / for: SA24481-01 Sonderausführung / Special design	(69) (60)
				3151 044 031	KZI-3		

MERCEDES-BENZ

809

LP 809, LPL 808, LPL 809 316.253 316.251 316.052/053 316.252 316.051 316.054	09.63 - 12.84	OM314	 1800 125 201	250 10	Mot. 410748->
			 1882 205 234	HBX250	316.051-054/072/081-083/085-087
			 1861 291 136	250GTZ	
			 3151 044 031	KZI-3	
			 1800 125 201	250 10	Mot. 678175->
			 1882 205 234	HBX250	316.251-252-253
			 1861 291 136	250GTZ	
			 3151 044 031	KZI-3	
			 1882 205 234	250	316.051-054/072/081-083/085-087/251-252-253
			 1882 600 122 ●	HBX250	316.051-054/072/081-083/085-087/251-252-253
			 1861 291 136	250 10	316.051-054/072/081-083/085-087/251-252-253
			 1878 634 082 ●	250GTZ	316.051-054/072/081-083/085-087/251-252-253
			 3151 095 043	KZI-3	->Chass. 4282707
			 3151 033 031	KZI-3	316.051-054/072/081-083/085-087
			 3151 033 031	KZI-3	Chass. 4282708 - Mot. 410747
			 3151 033 031	KZI-3	316.051-054/072/081-083/085-087
LPK 809 316.072	11.77 - 12.84	OM314	 1800 125 201	250 10	Mot. 410748->
			 1882 205 234	HBX250	316.051-054/072/081-083/085-087
			 1861 291 136	250GTZ	
			 3151 044 031	KZI-3	
			 3151 095 043	KZI-3	->Chass. 4282707
			 3151 033 031	KZI-3	316.051-054/072/081-083/085-087
 3151 033 031	KZI-3	Chass. 4282708 - Mot. 410747			
 3151 033 031	KZI-3	316.051-054/072/081-083/085-087			

811

811 318.072		OM353	 1882 317 131 #	280	318.072
			 1861 919 134	HVB280	318.072
			 3151 095 043	280GTZ	318.072
811 673.016 673.015 673.018 673.017 673.019 811 K 673.046	03.94 - 12.98	OM364LA	 3482 008 038	310	673.015-019/046
			 1862 299 032	MF310	673.015-019/046
			 3151 044 031	310WGSZ	673.015-019/046
811 673.315/316 673.319 673.317/318 811 K 673.346	03.96 - 12.98	OM904LA	 3400 121 401	362 18	673.315-319/346
			 3482 000 462	MF362	
			 1878 052 842	362WGTB	
 3151 000 374	KZIS-4				
 1878 001 939 HD ●	362 18	673.315-319/346			
				362WGTB	



CODE



SACHS

Parameter



MERCEDES-BENZ

811

LP 811 318.051-053	10.69 - 02.73	OM352		1882 252 331	310 GFX310	->Chass. 922885 318.051-054
				1882 305 131	310 GFX310	Chass. 922886 - Mot. 393780 318.051-054
				1861 303 248	310 10 310GSB	Chass. 922886 - Mot. 393780 318.051-054
				3151 095 043	KZI-3	->Mot. 393780 318.051-054
				1882 317 131 #	280 HVB280	->Chass. 4282707 Mot. 393781-> 318.051-054
				1861 919 134	280 10 280GTZ	->Chass. 4282707 Mot. 393781-> 318.051-054
				3151 095 043	KZI-3	->Chass. 4282707 Mot. 393781-> 318.051-054
				1882 317 131 #	280 HVB280	Chass. 4282708-> 318.051-054
				1861 919 134	280 10 280GTZ	Chass. 4282708-> 318.051-054
				3151 033 031	KZI-3	Chass. 4282708 - Mot. 678174 318.051-054
				3151 044 031	KZI-3	Mot. 678175-> 318.051-054
LPK 811 318.072	03.73 - 12.84	OM352		1882 317 131 #	280 HVB280	Mot. 393781-> 318.072
				1861 919 134	280 10 280GTZ	Mot. 393781-> 318.072
				3151 033 031	KZI-3	Chass. 4282708 - Mot. 678174 318.072
				3151 044 031	KZI-3	Mot. 678175-> 318.072
				1882 252 331	310 GFX310	->Chass. 922885 318.072
				1882 305 131	310 GFX310	Chass. 922886 - Mot. 393780 318.072
				1861 303 248	310 10 310GSB	->Mot. 393780 318.072
				3151 095 043	KZI-3	318.072
LPS 811 318.070	10.69 - 02.73	OM352		1882 252 331	310 GFX310	->Chass. 922885 318.070
				1882 305 131	310 GFX310	Chass. 922886 - Mot. 393780 318.070
				1861 303 248	310 10 310GSB	->Mot. 393780 318.070
				3151 095 043	KZI-3	->Mot. 393780 318.070
				1882 317 131 #	280 HVB280	->Chass. 4282707 Mot. 393781-> 318.070
				1861 919 134	280 10 280GTZ	->Chass. 4282707 Mot. 393781-> 318.070
				3151 095 043	KZI-3	->Chass. 4282707 Mot. 393781-> 318.070
				1882 317 131 #	280 HVB280	Chass. 4282708-> 318.070
				1861 919 134	280 10 280GTZ	Chass. 4282708-> 318.070
				3151 033 031	KZI-3	Chass. 4282708 - Mot. 678174 318.070
				3151 044 031	KZI-3	Mot. 678175-> 318.070



CODE



SACHS

Parameter



MERCEDES-BENZ





















813

LP 813, LPL 813 318.254 318.054 318.253 318.052/053 318.252 318.051 318.251	09.63 - 12.84	OM352	1882 317 131 #	280 HVB280	Mot. 393781-> 318.051-054	
			1861 919 134	280 10 280GTZ	Mot. 393781-> 318.051-054	
			3151 095 043	KZI-3	->Chass. 4282707 Mot. 393781-> 318.051-054	
			3151 033 031	KZI-3	Chass. 4282708 - Mot. 678174 318.051-054	
			3151 044 031	KZI-3	Mot. 678175-> 318.051-054	
			1882 252 331	310 GFX310	->Chass. 922885 318.051-052-053-054	
			1882 305 131	310 GFX310	Chass. 922886 - Mot. 393780 318.051-052-053-054	
			1861 303 248	310 10 310GSB	318.051-052-053-054	
			3151 095 043	KZI-3	->Mot. 393780 318.051-052-053-054	
			3482 008 038	310 MF310	318.051-052-053-054 Sonderausführung / Special design	(60)
			1861 303 248	310 10 310GSB	->Chass. 922885 318.051-052-053-054 Sonderausführung / Special design	(60)
			3151 095 043	KZI-3	->Chass. 4282707 318.051-052-053-054	
			3151 033 031	KZI-3	Chass. 4282708 - Mot. 678174 318.051-052-053-054	
			3151 044 031	KZI-3	Mot. 678175-> 318.051-052-053-054	
			LPK 813 318.072 LPS 813, LPLS 813 318.251/252 318.270 318.254 318.070	03.73 - 12.84	OM352	1882 252 331
09.63 - 12.84	1882 305 131	310 GFX310		Chass. 922886 - Mot. 393780 318.070/072		
	1861 303 248	310 10 310GSB		->Mot. 393780 318.070/072		
	3151 095 043	KZI-3		->Mot. 393780 318.070/072		
	1882 317 131 #	280 HVB280		->Chass. 4282707 Mot. 393781-> 318.070/072		
	1861 919 134	280 10 280GTZ		->Chass. 4282707 Mot. 393781-> 318.070/072		
	3151 095 043	KZI-3		->Chass. 4282707 Mot. 393781-> 318.070/072		
	1882 317 131 #	280 HVB280		Chass. 4282708-> 318.070/072		
	1861 919 134	280 10 280GTZ		Chass. 4282708-> 318.070/072		
	3151 033 031	KZI-3		Chass. 4282708 - Mot. 678174 318.070/072		
	3151 044 031	KZI-3		Mot. 678175-> 318.070/072		

















		CODE				
--	--	------	--	---	---	---

MERCEDES-BENZ

813







LPL 813 318.251-254		OM353	 1882 317 131 #	280 HVB280	Chass. 4367142-> 318.251-254	
			 1861 919 134	280 10 280GTZ	Chass. 4367142-> 318.251-254	
			 3151 033 031	KZI-3	Chass. 4367142 - Mot. 678174 318.251-254	
			 3151 044 031	KZI-3	Mot. 678175-> 318.251-254	
		 3482 008 038	310 MF310	318.251-254 Sonderausführung / Special design	(60)	
		 1861 303 248	310 10 310GSB	318.251-254 Sonderausführung / Special design	(60)	
		 3151 033 031	KZI-3	->Mot. 678174 318.251-254 Sonderausführung / Special design	(60)	
		 3151 044 031	KZI-3	Mot. 678175-> 318.251-254 Sonderausführung / Special design	(60)	
LPLS 813 318.270		OM353	 1882 317 131 #	280 HVB280	Chass. 4367142-> 318.270	
			 1861 919 134	280 10 280GTZ	Chass. 4367142-> 318.270	
			 3151 033 031	KZI-3	Chass. 4367142 - Mot. 678174 318.270	
			 3151 044 031	KZI-3	Mot. 678175-> 318.270	
		 1882 305 131	310 GFX310	318.270		
		 1861 303 248	310 10 310GSB	318.270		
		 1861 303 248 ●	310 10 310GSB	318.270		
		 3151 033 031	KZI-3	->Mot. 678174 318.270		
		 3151 044 031	KZI-3	Mot. 678175-> 318.270		
		 3482 008 038	310 MF310	318.270 Sonderausführung / Special design	(60)	
		 1861 303 248	310 10 310GSB	318.270 Sonderausführung / Special design	(60)	
		 3151 033 031	KZI-3	->Mot. 678174 318.270 Sonderausführung / Special design	(60)	
 3151 044 031	KZI-3	Mot. 678175-> 318.270 Sonderausführung / Special design	(60)			











814













814 F 674.082 674.090 674.080/081	05.86 - 12.98	OM366	 3400 122 401	310 10 MF310	674.010-014/042/052/080-082/212-213-214	
	814 K 674.042		03.84 - 12.98	 3482 008 038		310WGSZ
814 S 674.052		03.84 - 12.98	OM364LA, 366	 1861 964 034	KZI-3	674.010-019/042/046/052/056/085-087/090 /212-214/217-219
	 3151 044 031					
814,814L 674.214 674.010 674.013/014 674.212 674.011 674.213 674.012	01.84 - 12.98		 3400 124 301	330 10 GMF330	674.010-019/042/046/052/056/085-087/090 /212-214/217-219	
			 3482 012 211	330WGSZ		
814 F 674.385-387	03.96 - 12.98	OM904LA	 3400 121 401	362 18 MF362	674.417-419/477-478/315-319/346/356/385-387	
			 3482 000 462	362WGTB		
	814 K 674.346	03.96 - 12.98		 1878 052 842	KZIS-4	
	 3151 000 374					
814 S 674.356	03.96 - 12.98	OM904LA	 3400 127 701 ●	362 18 MF362	674.417-419/477-478/315-319/346/356/385-387	
			 3482 000 462	362WGTB		
814,814L 674.418/419 674.417 674.315 674.319 674.316-318	03.96 - 12.98	OM904LA	 1878 052 842	KZIS-4	674.417-419/477-478/315-319/346/356/385-387	
			 3151 000 958			
			 3400 700 484 HD ●	362 18	674.417-419/477-478/315-319/346/356/385-387	
			 3482 000 462	MF362		
			 1878 006 757	362WGTB		

		CODE				
--	--	------	--	---	---	---

















MERCEDES-BENZ

814						
814 F 674.085-087	03.94 - 12.98	OM364LA		3482 008 038	310 MF310	674.085-087/217/219/015-019/046/056
814 K 674.046	03.94 - 12.98			1862 299 032	310 10 310WGSZ	674.085-087/217/219/015-019/046/056
814 S 674.056	03.94 - 12.98			3151 044 031	KZI-3	674.085-087/217/219/015-019/046/056
814,814 L 674.015/016 674.018 674.017 674.218/219 674.217 674.019	01.84 - 12.98	OM364LA, 366		3400 124 301  3482 012 211  1861 963 033  3151 044 031	330 10 GMF330 330WGSZ KZI-3	674.085-087/212-214/217-219/010-019/042/046 /052/056

817						
817 F 676.082/083 676.080 676.085 676.081 676.084	03.84 - 12.98	OM366A, LA		3482 012 240	330 GMF330	
817 K 676.040 676.046	01.86 - 12.98			1861 963 033	330 10 330WGSZ	
817 S,817 LS 676.251 676.060 676.258 676.051 676.250 676.050	01.84 - 12.98			3151 044 031	KZI-3	
817,817 L 676.208 676.069 676.067/068 676.201 676.203/204 676.066 676.206 676.003 676.202 676.001 676.209 676.002 676.004 676.207	01.84 - 12.98	OM366A		3482 000 953	350 GMF350X	Getr. / GBox: G4
				1878 001 144	350 10 350WGTZ	Getr. / GBox: G4
				3151 000 374	KZIS-4	Getr. / GBox: G4
817 F 676.383-385	03.96 - 12.98	OM904LA		3400 121 401  3482 000 462  1878 052 842  3151 000 374	362 18 MF362 362WGTB KZIS-4	676.406-409/458/464/346/360/366-369/383-385
817 K 676.346	03.96 - 12.98					
817 S,817 LS 676.360 676.458	03.96 - 12.98			1878 001 939 HD●	362 18 362WGTB	676.406-409/458/464/346/360/366-369/383-385
817,817 L 676.409 676.367 676.369 676.368 676.406 676.366 676.407/408	03.96 - 12.98					

911						
L,LA 911				1882 201 132	295 GF295	Sonderausführung / Special design (60)
				1861 279 133	295 10 295GTZ	Sonderausführung / Special design (60)
				3151 095 043	KZI-3	Sonderausführung / Special design (60)
L,LA LP 911				1861 919 134	280 10 280GTZ	Sonderausführung / Special design (60)
L,LP 911		OM352		1861 919 134	280 10 280GTZ	->Mot. 040605
				1861 919 134	280 10 280GTZ	Sonderausführung / Special design (60)
				3151 095 043	KZI-3	Sonderausführung / Special design (60)
LA 911				1860 062 037 #	280 10 280Z	
LA,LK 911 B LAK,LAF,LAKO 911 B		OM353		1861 919 134	280 10 280GTZ	->Chass. 760271 nicht für Fahrgestellnummer / not for chassis no.: 500001-599999 (97)
				3151 095 043	KZI-3	->Chass. 760271 nicht für Fahrgestellnummer / not for chassis no.: 500001-599999 (97)
				1882 201 132	295 GF295	Chass. 760272-> Chass. 500001 - Chass. 599999
				1861 279 133	295 10 295GTZ	Chass. 760272-> Chass. 500001 - Chass. 599999
				3151 095 043	KZI-3	Chass. 760272-> Chass. 500001 - Chass. 599999

MERCEDES-BENZ

911						
LAS 911 B LS 911 B		OM353	 1861 919 134	280 10 280GTZ	->Chass. 760271 nicht für Fahrgestellnummer / not for chassis no.: 500001-599999	(97)
			 3151 095 043	KZI-3	->Chass. 760271 nicht für Fahrgestellnummer / not for chassis no.: 500001-599999	(97)
			 1882 201 132	295 GF295	Chass. 760272-> Chass. 500001 - Chass. 599999	
			 1861 279 133	295 10 295GTZ	Chass. 760272-> Chass. 500001 - Chass. 599999	
			 3151 095 043	KZI-3		
LP 911 B 353.056 353.053 353.058 353.052 353.057 353.051 353.054	01.67 - 03.77	OM352.907, OM352.986	 1861 919 134	280 10 280GTZ	->Mot. 040605	
			 1882 201 132	295 GF295	Mot. 040606->	
			 1861 279 133	295 10 295GTZ	Mot. 040606->	
			 3151 095 043	KZI-3	Mot. 040606->	
		OM352A	 1882 252 333	310 GFX310		
			 1861 303 248	310 10 310GSB		
LPK 911 B LPS 911 B		OM353	 1861 919 134	280 10 280GTZ		
			 3151 095 043	KZI-3		
LT 911 B		OM353	 1882 305 131	310 GFX310		
			 1861 303 248	310 10 310GSB		
			1861 303 248 ●	310 10 310GSB		
			 3151 095 043	KZI-3		



CODE



SACHS

Parameter





MERCEDES-BENZ







913













LP 913, LPL 913 318.256-258 318.058/059 318.056/057	09.63 - 12.84	OM352	1882 252 331	310 GFX310	->Chass. 922885 318.056-059	
			1882 305 131	310 GFX310	Chass. 922886 - Mot. 393780 318.056-059	
			1861 303 248	310 10 310GSB	->Mot. 393780 318.056-059	
			3151 095 043	KZI-3	->Mot. 393780 318.056-059	
			1882 317 131 #	280 HVB280	->Chass. 4282707 Mot. 393781-> 318.056-059	
			1861 919 134	280 10 280GTZ	->Chass. 4282707 Mot. 393781-> 318.056-059	
			3151 095 043	KZI-3	->Chass. 4282707 Mot. 393781-> 318.056-059	
			1882 317 131 #	280 HVB280	Chass. 4282708-> 318.056-059	
			1861 919 134	280 10 280GTZ	Chass. 4282708-> 318.056-059	
			3151 033 031	KZI-3	Chass. 4282708 - Mot. 678174 318.056-059	
			3151 044 031	KZI-3	Mot. 678175-> 318.056-059	
		OM353	1882 317 131 #	280 HVB280	Chass. 4367142-> 318.256-257-258	
			1861 919 134	280 10 280GTZ	Chass. 4367142-> 318.256-257-258	
			3151 033 031	KZI-3	Chass. 4367142 - Mot. 678174 318.256-257-258	
			3151 044 031	KZI-3	Mot. 678175-> 318.256-257-258	
		OM353.982, OM353.965, OM353.981, OM353.904	1861 303 248	310 10 310GSB	318.256-257-258 Sonderausführung / Special design	(60)
			3482 008 038	310 MF310	318.256-257-258 Sonderausführung / Special design	(60)
			3151 033 031	KZI-3	->Mot. 678174 318.256-257-258 Sonderausführung / Special design	(60)
			3151 044 031	KZI-3	Mot. 678175-> 318.256-257-258 Sonderausführung / Special design	(60)
LPK 913 318.092 LPS 913 318.090	01.67 - 12.84	OM352	1882 252 331	310 GFX310	->Chass. 922885 318.090/092	
	10.69 - 12.84		1882 305 131	310 GFX310	Chass. 922886 - Mot. 393780 318.090/092	
			1861 303 248	310 10 310GSB	->Mot. 393780 318.090/092	
			3151 095 043	KZI-3	->Mot. 393780 318.090/092	
			1882 317 131 #	280 HVB280	->Chass. 4282707 Mot. 393781-> 318.090/092	
			1861 919 134	280 10 280GTZ	->Chass. 4282707 Mot. 393781-> 318.090/092	
			3151 095 043	KZI-3	->Chass. 4282707 Mot. 393781-> 318.090/092	
			1882 317 131 #	280 HVB280	Chass. 4282708-> 318.090/092	
			1861 919 134	280 10 280GTZ	Chass. 4282708-> 318.090/092	
			3151 033 031	KZI-3	Chass. 4282708 - Mot. 678174 318.090/092	
			3151 044 031	KZI-3	Mot. 678175-> 318.090/092	

		CODE				
--	--	------	--	---	---	---

MERCEDES-BENZ































914						
914 678.003 674.021 674.023 678.008 678.006 678.002 674.022 674.024	03.84 - 12.98	OM366		3400 122 401 ⊗ 3482 008 038 ⊗ 1861 964 034 ⊙ 3151 044 031	310 10 MF310 310WGSZ KZI-3	
914 AK 674.144/145	02.87 - 12.98			3400 124 301 ⊗ 3482 012 211 ⊗ 1861 963 033 ⊙ 3151 044 031	330 10 GMF330 330WGSZ KZI-3	
914 AK 674.144	02.87 - 12.98					
914 K 674.044	03.84 - 12.98					
914 KO 674.090	01.87 - 12.98					

917						
917 676.307 676.306 676.309 676.308	03.96 - 12.98	OM904LA		3400 121 401 ⊗ 3482 000 462 ⊗ 1878 052 842 ⊙ 3151 000 374	362 18 MF362 362WGTB KZIS-4	676.306-309/341/390
917 K 676.341	03.96 - 12.98					
917 KO 676.390	03.96 - 12.98			1878 001 939 HD●	362 18 362WGTB	676.306-309/341/390
917 676.006 676.008 676.007 676.009	03.94 - 12.98	OM366A, LA		3482 012 240	330 GMF330	676.143/182-185/195-196-197-198/006-009/041/090/142
917 AF 676.196/197 676.182 676.198 676.183-185 676.195	02.87 - 12.98			1861 963 033	330 10 330WGSZ	676.143/182-185/195-196-197-198/006-009/041/090/142
917 AK 676.142/143	03.94 - 12.98			3151 044 031	KZI-3	676.143/182-185/195-196-197-198/006-009/041/090/142
917 K 676.041	03.94 - 12.98					
917 KO 676.090	03.94 - 12.98					
917 AK 674.144		OM366		3400 122 401 ⊗ 3482 008 038 ⊗ 1861 964 034 ⊙ 3151 044 031	310 10 MF310 310WGSZ KZI-3	674.144

1013						
1013 380.003/004 380.008 380.002 380.005 380.007	02.76 - 12.84	OM353		1882 317 131 #	280 HVB280	->Chass. 4276890 380.002-003/005/007
				1861 919 134	280 10 280GTZ	->Chass. 4276890 380.002-003/005/007
				3151 033 031	KZI-3	->Chass. 4696330 380.002-003/005/007
				3482 008 038	310 MF310	Chass. 4276891-> 380.002-003-004-005/007-008
				1861 303 248	310 10 310GSB	Chass. 4276891 - Chass. 4696330 380.002-003-004-005/007-008
				3151 044 031	KZI-3	Chass. 4696331-> 380.002-003/005/007/004/008
1013 A 380.102 380.104 380.103	02.76 - 12.86	OM353		1882 317 131 #	280 HVB280	->Chass. 4276890 380.102-103
				1861 919 134	280 10 280GTZ	->Chass. 4276890 380.102-103
				3151 033 031	KZI-3	->Chass. 4696330 380.102-103
				3482 008 038	310 MF310	Chass. 4276891-> 380.102-103-104
				1861 303 248	310 10 310GSB	Chass. 4276891-> 380.102-103-104
				3151 044 031	KZI-3	Chass. 4696331-> 380.102-103-104

































		CODE				
--	--	------	--	---	---	---

MERCEDES-BENZ

1013						
1013 AK 380.140 1013 K 380.040	02.76 - 12.84	OM353		1882 317 131 #	280 HVB280	->Chass. 4276890
	02.76 - 12.84			1861 919 134	280 10 280GTZ	->Chass. 4276890
				3151 033 031	KZI-3	->Chass. 4276890
				3482 008 038	310 MF310	Chass. 4276891->
				1861 303 248	310 10 310GSB	Chass. 4276891->
				3151 033 031	KZI-3	Chass. 4276891 - Chass. 4696330
				3151 044 031	KZI-3	Chass. 4696331->
1013 B 358.066 358.065 358.072 358.051 358.050 358.064 358.062/063 358.071 358.052 358.054 358.053		OM352		1861 919 134	280 10 280GTZ	->Chass. 760271 358.050-054/062-066/071-072
				3151 095 043	KZI-3	->Chass. 760271 358.050-054/062-066/071-072
				1882 201 132	295 GF295	Chass. 760272-> 358.050-054/062-066/071-072
				1861 279 133	295 10 295GTZ	Chass. 760272-> 358.050-054/062-066/071-072
				3151 095 043	KZI-3	Chass. 760272-> 358.050-054/062-066/071-072
				1882 305 132	310 GFX310	358.050-054/062-066/071-072 Sonderausführung / Special design (60)
				1861 303 248	310 10 310GSB	358.050-054/062-066/071-072 Sonderausführung / Special design (60)
				3151 095 043	KZI-3	358.050-054/062-066/071-072 Sonderausführung / Special design (60)
1013 KO 380.061 380.060	02.76 - 12.84	OM353		3482 008 038	310 MF310	380.060-061
				1861 303 248	310 10 310GSB	380.060-061
				3151 044 031	KZI-3	380.060-061
1013 S 380.050 380.053	02.76 - 12.84	OM353		3482 008 038	310 MF310	380.050/053
				1861 303 248	310 10 310GSB	380.050/053
				3151 044 031	KZI-3	380.050/053
LP 1013 318.354 LP 1013, LPL 1013 318.352/353 318.552 318.354 318.351 318.551 LPK 1013 318.392 318.372	11.76 - 12.84	OM353		1882 317 131 #	280 HVB280	318.351-354/372/551-552
	11.76 - 12.84			1861 919 134	280 10 280GTZ	318.351-354/372/551-552
	11.76 - 12.84			3151 033 031	KZI-3	->Mot. 678174 318.351-354/372/551-552
				3151 044 031	KZI-3	Mot. 678175-> 318.351-354/372/551-552
				3482 008 038	310 MF310	318.351-354/372 Sonderausführung / Special design (60)
				1861 303 248	310 10 310GSB	318.351-354/372 Sonderausführung / Special design (60)
				3151 033 031	KZI-3	->Mot. 678174 318.351-354/372 Sonderausführung / Special design (60)
				3151 044 031	KZI-3	Mot. 678175-> 318.351-354/372 Sonderausführung / Special design (60)
LP,LK,LA,LPK 1013				1882 305 131	310 GFX310	
				1861 303 248	310 10 310GSB	



















		CODE				
--	--	------	--	---	---	---

MERCEDES-BENZ







1017								
1017 380.012/013 380.018 380.014 380.017 380.015	11.75 - 02.91	OM353		3482 008 038	310 MF310	->Chass. 4275350 380.012-013-014-015/017-018		
				1861 303 248	310 10 310GSB	->Chass. 4275350 380.012-013-014-015/017-018		
				3151 044 031	KZI-3	->Chass. 4275350 380.012-013-014-015/017-018		
				3482 012 211	330 GMF330	Chass. 4275351-> 380.012-013/015/017-018		
				1861 571 236	330 10 330GSZ	Chass. 4275351-> 380.012-013/015/017-018		
				3151 044 031	KZI-3	Chass. 4275351-> 380.012-013/015/017-018		
		OM353.951		3482 012 211	330 GMF330	Chass. 4275670-> für / for: Turbo	(69)	
				1861 571 236	330 10 330GSZ	Chass. 4275670-> für / for: Turbo	(69)	
				3151 044 031	KZI-3	Chass. 4275670-> für / for: Turbo	(69)	
1017 A 380.112 380.114 380.113	11.75 - 02.91	OM353		3482 008 038	310 MF310	->Chass. 4275350 380.112-113-114		
				1861 303 248	310 10 310GSB	->Chass. 4275350 380.112-113-114		
				3151 044 031	KZI-3	->Chass. 4275350 380.112-113-114		
				3482 012 211	330 GMF330	Chass. 4275351-> 380.112-113-114		
				1861 571 236	330 10 330GSZ	Chass. 4275351-> 380.112-113-114		
				3151 044 031	KZI-3	Chass. 4275351-> 380.112-113-114		
		OM352A		3482 012 211	330 GMF330	06.1977->		
				1861 571 236	330 10 330GSZ	06.1977->		
				3151 033 031	KZI-3	06.1977->		
1017 AF 380.181 380.180	11.75 - 09.85	OM353		3482 008 038	310 MF310	->Chass. 4275350 380.180-181		
				1861 303 248	310 10 310GSB	->Chass. 4275350 380.180-181		
				3151 044 031	KZI-3	->Chass. 4275350 380.180-181		
				3482 012 211	330 GMF330	Chass. 4275351-> 380.180-181		
				1861 571 236	330 10 330GSZ	Chass. 4275351-> 380.180-181		
				3151 044 031	KZI-3	Chass. 4275351-> 380.180-181		
1017 AK 380.143 1017 AS 380.151 1017 K 380.043	02.76 - 12.84	OM353		3482 008 038	310 MF310	->Chass. 4275350 380.043/143/151		
	04.77 - 09.85			1861 303 248	310 10 310GSB	->Chass. 4275350 380.043/143/151		
				3151 044 031	KZI-3	->Chass. 4275350 380.043/143/151		
	02.76 - 12.84			3482 012 211	330 GMF330	Chass. 4275351-> 380.043/143/151		
				1861 571 236	330 10 330GSZ	Chass. 4275351-> 380.043/143/151		
				3151 044 031	KZI-3	Chass. 4275351-> 380.043/143/151		
			OM352A		3482 012 211	330 GMF330	06.1977->	
					1861 571 236	330 10 330GSZ	06.1977->	
					3151 033 031	KZI-3	06.1977->	

MERCEDES-BENZ







1017

1017 KO,1017 F 380.080/081 380.066 380.065	08.73 - 09.96	OM353	 3482 008 038	310 MF310	->Chass. 4275350 380.065-066/180-181	
			 1861 303 248	310 10 310GSB	->Chass. 4275350 380.065-066/180-181	
			 3151 044 031	KZI-3	->Chass. 4275350 380.065-066/180-181	
			 3482 012 211	330 GMF330	Chass. 4275351-> 380.065-066/180-181	
			 1861 571 236	330 10 330GSZ	Chass. 4275351-> 380.065-066/180-181	
			 3151 044 031	KZI-3	Chass. 4275351-> 380.065-066/180-181	
1017 S,1017 LS 380.052 380.252 380.251 380.051	08.73 - 09.96	OM353	 3482 008 038	310 MF310	->Chass. 4275350 380.051-052	
			 1861 303 248	310 10 310GSB	->Chass. 4275350 380.051-052	
			 3151 044 031	KZI-3	->Chass. 4275350 380.051-052	
			 3482 012 211	330 GMF330	Chass. 4275351-> 380.051-052	
			 1861 571 236	330 10 330GSZ	Chass. 4275351-> 380.051-052	
			 3151 044 031	KZI-3	Chass. 4275351-> 380.051-052	
			 3482 012 211	330 GMF330	Chass. 4275670-> 380.251-252	
			 1861 571 236	330 10 330GSZ	Chass. 4275670-> 380.251-252	
		 3151 044 031	KZI-3	Chass. 4275670-> 380.251-252		
		OM352A	 3482 012 211	330 GMF330	06.1977->	
			 1861 571 236	330 10 330GSZ	06.1977->	
			 3151 033 031	KZI-3	06.1977->	

1019







































1019 AF 380.183 1019 AF 380.183 1019 F 380.083	01.79 - 12.82	OM401	 3482 000 953	350 GMF350X	380.083/183	
	01.79 - 12.82		 1878 001 070	350 10 350GTZ	380.083/183	
	01.79 - 12.82		 3151 043 031	KZI-4,5	380.083/183	
			 1882 302 131	380 GF380	380.183 Sonderausführung / Special design	(60)
			 1878 000 105	380 10 380GTZ	380.183 Sonderausführung / Special design	(60)
			 3151 000 375	KZIS-4	380.183 Sonderausführung / Special design	(60)
			OM401.919, OM401.922, OM401.924	 3189 600 060		

1113

L,LA 1113 SA 016 655/2			 1882 201 132	295 GF295		
			 1861 279 133	295 10 295GTZ		
			 3151 095 043	KZI-3		
L,LA,LK,LP,LS 1113 B LAK,LAS,LPK,LPS 1113 B		OM358	 1861 919 134	280 10 280GTZ	->Chass. 760271 nicht für Fahrgestellnummer / not for chassis no.: 500001-599999	(97)
			 1882 201 132	295 GF295	Chass. 760272-> Chass. 500001 - Chass. 599999	
			 1861 279 133	295 10 295GTZ	Chass. 760272-> Chass. 500001 - Chass. 599999	
			 3151 095 043	KZI-3		



































		CODE				
--	--	------	--	---	---	---

MERCEDES-BENZ

1113							
L,LA,LP 1113			 1861 919 134	280 10			
			 3151 095 043	280GTZ KZI-3			
L,LA,LP 1113 B		OM352A	 1882 252 333	310			
			 1861 303 248	GFX310 310 10 310GSB			
L,LK,LS,LKO 1113 B 358.010-015 358.021-023 358.000-004		OM352, 353	 1861 919 134	280 10	->Chass. 760271 358.000-004/010-015/021-023 nicht für Fahrgestellnummer / not for chassis no.: 500001-599999	(97)	
			 1882 201 132	280GTZ 295 GF295			Chass. 760272-> Chass. 500001 - Chass. 599999 358.000-004/010-015/021-023
			 1861 279 133	295 10 295GTZ			Chass. 760272-> Chass. 500001 - Chass. 599999 358.000-004/010-015/021-023
			 3151 095 043	KZI-3			358.000-004/010-015/021-023
LF,LAF 1113 B 358.116 358.016-117		OM352, 353	 1882 252 333	310	->Chass. 922885 358.016-018/116-117		
			 1882 305 132	GFX310 310 GFX310			Chass. 922886-> 358.016-018/116-117
			 1861 303 248	310 10 310GSB			358.016-018/116-117
			 3151 095 043	KZI-3			358.016-018/116-117
LP 1113, LPL 1113 318.358 318.556 318.359 318.356/357 318.557	01.80 - 12.84	OM353	 3482 008 038	310	318.356-359/392		
			 1861 303 248	MF310 310 10 310GSB			318.356-359/392
			 3151 033 031	KZI-3			->Mot. 678174 318.356-359/392
			 3151 044 031	KZI-3			Mot. 678175-> 318.356-359/392
LP,LPK,LPS,LPF 1113 358.071/072 358.062-066 358.050-054		OM352	 1882 305 132	310	358.050-054/062-066/071-072 Sonderausführung / Special design	(60)	
			 1861 303 248	GFX310 310 10 310GSB			358.050-054/062-066/071-072 Sonderausführung / Special design
			 3151 095 043	KZI-3			358.050-054/062-066/071-072 Sonderausführung / Special design
1114							
1114,1114 L 675.012 675.213/214 678.013 675.014 675.013 675.212 678.018 678.012 678.016	01.84 - 12.98	OM366	 3400 122 401	310 10	675.012-013-014/212-213-214 678.013		
			 3482 008 038  1861 964 034  3151 044 031	MF310 310WGSZ KZI-3			
1114 A 678.118 678.161 678.112 678.116 678.162	02.87 - 12.98	OM366	 3400 124 301	330 10	675.012-013-014/212-213-214		
			 3482 012 211  1861 963 033  3151 044 031	GMF330 330WGSZ KZI-3			
1114 AK 675.143 675.142 678.116	02.87 - 12.98	OM366	 3400 122 401	310 10	675.142-143 678.116		
			 3482 008 038  1861 964 034  3151 044 031	MF310 310WGSZ KZI-3			
1114 K 675.042 1114 S 675.052/053	03.84 - 12.98	OM366	 3400 122 401	310 10			
	03.84 - 12.98		 3482 008 038  1861 964 034  3151 044 031	MF310 310WGSZ KZI-3			
			 3400 124 301	330 10			
			 3482 012 211  1861 963 033  3151 044 031	GMF330 330WGSZ KZI-3			





		CODE				
--	--	------	--	---	---	---

MERCEDES-BENZ





1117								
1117,1117 L 676.019 676.014 676.016 678.026 676.213/214 676.217-219 676.015 676.212 676.012/013 678.022 678.028 676.017 678.023 676.018	01.84 - 12.98	OM366, A	 3482 012 240	330 GMF330	676.012-019/212-214/217-219 678.023			
			 1861 963 033	330 10 330WGSZ	676.012-019/212-214/217-219 678.023			
			 3151 044 031	KZI-3	676.012-019/212-214/217-219 678.023			
			OM366	 3482 000 953	350 GMF350X	Getr. / GBox: G4 676.212-214/012-015 Sonderausführung / Special design	(60)	
				 1878 001 144	350 10 350WGTZ	Getr. / GBox: G4 676.212-214/012-015 Sonderausführung / Special design	(60)	
				 3151 000 374	KZIS-4	Getr. / GBox: G4 676.212-214/012-015 Sonderausführung / Special design	(60)	
1117,1117 L 676.316-318 676.418/419 676.417 676.319 1117 K 676.347 1117 S 676.354/355 676.454/455	03.96 - 12.98	OM904LA	 3400 121 401	362 18 MF362	676.316-319/347/354-355/417-419/454-455/476			
	03.96 - 12.98		 3482 000 462	362WGTB				
	03.96 - 12.98		 1878 052 842	KZIS-4				
			 3151 000 374					
			3400 700 484 HD	362 18 MF362	676.316-319/347/354-355/417-419/454-455/476			
			 3482 000 462	362WGTB				
			 1878 006 757					
1117 A 676.117 678.171 676.112 678.126 678.122 678.172 1117 AK 676.145 676.144	06.87 - 12.98	OM366	 3482 012 240	330 GMF330	676.112/144-145			
	04.84 - 12.98		 1861 963 033	330 10 330WGSZ	676.112/144-145			
			 3151 044 031	KZI-3	676.112/144-145			
1117 K 676.047 676.042 1117 S,1117 LS 676.053 676.055 676.054 676.252 676.255 676.052 676.253/254	04.84 - 12.98	OM366	 3482 012 240	330 GMF330	676.252-255/042			
	01.84 - 12.98		 1861 963 033	330 10 330WGSZ	676.252-255/042			
		 3151 044 031	KZI-3	676.252-255/042				
		 3482 000 953	350 GMF350X	Getr. / GBox: G4 676.052-053/252-253/042 Sonderausführung / Special design	(60)			
		 1878 001 144	350 10 350WGTZ	Getr. / GBox: G4 676.252-253/042 Sonderausführung / Special design	(60)			
		 3151 000 374	KZIS-4	Getr. / GBox: G4 676.252-253/042 Sonderausführung / Special design	(60)			
1120								
1120,1120 L 677.019 677.212/213 677.017 677.214 677.013 677.218 677.012 677.014 677.018 677.216/217 677.015/016	01.84 - 12.98	OM366, 366LA	 3482 000 953	350 GMF350X	677.012-019			
			 1878 001 070	350 10 350GTZ	677.012-019			
			 3151 000 374	KZIS-4	677.012-019			
				OM366LA	 3482 000 953	350 GMF350X	677.212-213-214	
					 1878 001 070	350 10 350GTZ	677.212-213-214	
					 3151 000 374	KZIS-4	677.212-213-214	
					 1882 166 737	380 GF380	677.216-218	
					 1878 000 105	380 10 380GTZ	677.216-218	
 3151 000 374	KZIS-4	677.216-218						
1120 AF 677.196 677.183 1120 F 677.083 1120 L 677.212	02.87 - 12.98	OM366LA	 3400 125 001	350 10 GMF350X				
	02.90 - 12.98		 3482 000 953	350GTZ				
	08.84 - 12.98		 1878 001 070	KZIS-4				
			 3151 000 374					

















		CODE				
--	--	------	--	---	---	---

MERCEDES-BENZ

1120						
1120 S,1120 LS 677.050 677.252/253 677.052 677.250/251 677.051 677.053	01.84 - 12.98	OM366, LA		3400 125 001 ⊗ 3482 000 953 ⊗ 1878 001 070 ⊕ 3151 000 374	350 10 GMF350X 350GTZ KZIS-4	677.052-053/252-253
		OM366LA		1882 166 737	380 GF380	677.250-251
				1878 000 105	380 10 380GTZ	677.250-251
				3151 000 374	KZIS-4	677.250-251















1121						
1121 L 677.212		OM366LA		3482 000 953	350 GMF350X	677.212
				1878 001 070	350 10 350GTZ	677.212
				3151 000 374	KZIS-4	677.212
L,LA,LP,LAP 321 SA 015 052/01				1861 919 134	280 10 280GTZ	





1124						
1124 AF 677.183/184 677.196/197	03.92 - 12.98	OM366LA		3400 125 001 ⊗ 3482 000 953 ⊗ 1878 001 070 ⊕ 3151 000 374	350 10 GMF350X 350GTZ KZIS-4	->Chass. K062275 677.183/196
				3400 125 001 ⊗ 3482 000 953 ⊗ 1878 001 070 ⊕ 3151 000 374	350 10 GMF350X 350GTZ KZIS-4	Chass. K062276-> 677.183/196/184
1124 F 677.083/084	03.92 - 12.98	OM366LA		3400 125 001 ⊗ 3482 000 953 ⊗ 1878 001 070 ⊕ 3151 000 374	350 10 GMF350X 350GTZ KZIS-4	->Chass. 5906887 677.083
				3400 125 001 ⊗ 3482 000 953 ⊗ 1878 001 070 ⊕ 3151 000 374	350 10 GMF350X 350GTZ KZIS-4	Chass. 5906888-> 677.083-084









1213						
1213 381.002 381.005 381.008 381.007 381.003	09.75 - 05.86	OM353.943, OM353.944, OM353.946, OM353.945		3482 008 038	310 MF310	->Chass. 4696330 381.102-103-104/002-003/005/007-008/040/050
				1861 303 248	310 10 310GSB	->Chass. 4696330 381.102-103-104/002-003/005/007-008/040/050
				3151 033 031	KZI-3	->Chass. 4696330 381.102-103-104/002-003/005/007-008/040/050
1213 AK 381.140 1213 AKO 381.160/161 1213 KO 381.061 381.060	09.75 - 05.86	OM353.943, OM353.944, OM353.946, OM353.945		3482 008 038	310 MF310	381.060-061/140/150/160-161
				1861 303 248	310 10 310GSB	381.060-061/140/150/160-161
				3151 033 031	KZI-3	381.060-061/140/150/160-161
				3151 044 031	KZI-3	Chass. 4696331-> 381.060-061/140/150/160-161
1213 AS 381.150	09.75 - 05.86	OM353.943, OM353.944, OM353.946, OM353.945		3482 008 038	310 MF310	381.060-061/140/150/160-161
				1861 303 248	310 10 310GSB	381.060-061/140/150/160-161
				3151 033 031	KZI-3	381.060-061/140/150/160-161
1213 K.S.A 381.160 381.140 381.161 381.150 381.060/061				3482 008 038	310 MF310	Chass. 4696331-> 381.060-061/140/150/160-161
				1861 303 248	310 10 310GSB	Chass. 4696331-> 381.060-061/140/150/160-161
				3151 044 031	KZI-3	Chass. 4696331-> 381.060-061/140/150/160-161
L,LA,LP,LS 1213		OM352		1882 201 132	295 GF295	
				1861 279 133	295 10 295GTZ	
				3151 095 043	KZI-3	



		CODE				
--	--	------	--	---	---	---

MERCEDES-BENZ





















1213						
LP,LPK 1213 352.072 352.063 352.050-054 352.062 352.071		OM352		1882 305 132	310 GFX310	352.050-054/062-063/071-072 Sonderausführung / Special design (60)
				1861 303 248	310 10 310GSB	352.050-054/062-063/071-072 Sonderausführung / Special design (60)
				3151 095 043	KZI-3	352.050-054/062-063/071-072 Sonderausführung / Special design (60)
LP,LPK,LPS 1213 352.072 352.050-054 352.071 352.062-065		OM352		1882 201 132	295 GF295	->Chass. 760271 352.050-054/062-065/071-072
				1861 279 133	295 10 295GTZ	->Chass. 760271 352.050-054/062-065/071-072
				3151 095 043	KZI-3	->Chass. 760271 352.050-054/062-065/071-072
				1882 252 331	310 GFX310	Chass. 760272 - Chass. 922885 352.050-054/062-065/071-072
				1882 305 131	310 GFX310	Chass. 922886-> 352.050-054/062-065/071-072
				1861 303 248	310 10 310GSB	Chass. 760272-> 352.050-054/062-065/071-072
				3151 095 043	KZI-3	Chass. 760272-> 352.050-054/062-065/071-072
				1882 252 333	310 GFX310	->Chass. 922885 352.050-054/062-065/071-072 Sonderausführung / Special design (60)
				1882 305 132	310 GFX310	Chass. 922886-> 352.050-054/062-065/071-072 Sonderausführung / Special design (60)
				1861 303 248	310 10 310GSB	352.050-054/062-065/071-072 Sonderausführung / Special design (60)
				3151 095 043	KZI-3	352.050-054/062-065/071-072 Sonderausführung / Special design (60)







1214						
1214 A 615.241	01.84 - 12.98	OM366		3400 122 401  3482 008 038  1861 964 034  3151 044 031	310 10 MF310 310WGSZ KZI-3	615.241-242

1216						
LP 1216	06.69 -	OM324		1882 234 433	350 GF350	
				1878 001 074	350 10 350GTZ	
				3151 044 031	KZI-3	
LP 1216	- 05.69	OM324		1878 001 074	350 10 350GTZ	
LP,LPK,LPS,LPKO 1216 352.055-059 352.082-087 352.091-093		OM327		1882 234 433	350 GF350	352.055-059/082-087/091-093
				1878 001 074	350 10 350GTZ	352.055-059/082-087/091-093
				3151 094 041	KZI-4	352.055-059/082-087/091-093
LP,LPKO 1216		OM352		1878 001 074	350 10 350GTZ	





































1217						
1217 Turbo-Mot. 353.951		OM353		3482 012 211	330 GMF330	Chass. 4275670-> 353.951 Turbo
				1861 571 236	330 10 330GSZ	Chass. 4275670-> 353.951 Turbo
				3151 044 031	KZI-3	Chass. 4275670-> 353.951 Turbo

MERCEDES-BENZ











1217							
1217,1217 L 381.018 381.213 381.218 381.212 381.215 381.012 381.017 381.217 381.013 381.015 1217 A 381.113 381.112 381.114 1217 AK 381.143 1217 AS 381.151 1217 K 381.043 1217 S,1217 LS 381.251 381.051 381.252 381.052	08.73 - 09.96	OM353		3482 008 038	310 MF310	->Chass. 4275669	
	09.75 - 09.85			1861 303 248	310 10 310GSB	->Chass. 4275669	
	09.75 - 09.85			3151 044 031	KZI-3	->Chass. 4275669	
	09.75 - 09.85			3482 012 211	330 GMF330	Chass. 4275670->	
	09.75 - 12.84			1861 571 236	330 10 330GSZ	Chass. 4275670->	
	08.73 - 09.96			3151 044 031	KZI-3	Chass. 4275670->	
			OM352A		3482 012 211	330 GMF330	06.1977->
					1861 571 236	330 10 330GSZ	06.1977->
					3151 033 031	KZI-3	06.1977->
	1217 CA 615.244/245	05.82 - 10.90	OM366		3482 012 240	330 GMF330	615.244-245
				1861 963 033	330 10 330WGSZ	615.244-245	
				3151 044 031	KZI-3	615.244-245	
1217 KO 381.066 381.065	09.75 - 09.85	OM353		3482 008 038	310 MF310	->Chass. 4275669	
				1861 303 248	310 10 310GSB	->Chass. 4275669	
				3151 044 031	KZI-3	->Chass. 4275669	
				3482 012 211	330 GMF330	Chass. 4275670->	
				1861 571 236	330 10 330GSZ	Chass. 4275670->	
				3151 044 031	KZI-3	Chass. 4275670->	
1217 KO 381.065/066	03.94 - 12.98	OM357.901, OM357.918		3482 012 211	330 GMF330		
				1861 571 236	330 10 330GSZ		
				3151 044 031	KZI-3		











1219							
1219 381.028 381.022/023 381.025 381.027 1219 A 381.123 381.122 1219 AF 381.183 381.182 1219 AK 381.146 1219 F 381.082 381.084 381.083 1219 K 381.046 1219 S 381.055 381.054	09.75 - 09.84	OM401		3482 000 953	350 GMF350X		
	09.75 - 12.82			1878 001 070	350 10 350GTZ		
	09.75 - 09.84			3151 043 031	KZI-4,5		
	09.75 - 12.84			1878 000 964	380 10 380GTZ	für Nebenantrieb / for PTO	(82)
	09.75 - 09.84			3151 079 031	KZI-6	für Nebenantrieb / for PTO	(82)
	09.75 - 09.84			1882 302 131	380 GF380	Sonderausführung / Special design	(60)
	09.75 - 09.84			1878 000 105	380 10 380GTZ	Sonderausführung / Special design	(60)







MERCEDES-BENZ

1222							
1222 615.027 615.122 615.026 615.028	07.82 - 02.90	OM421/422	 1882 302 131	380 GF380	->Chass. 5234953 615.122/224/226		
			 1878 000 105	380 10 380GTZ	->Chass. 5234953 615.122/224/226		
			 3151 000 375	KZIS-4	->Chass. 5095724 615.122/224/226		
			 3151 126 031	KZI-4,5	Chass. 5095725-> 615.122/224/226		
			 3482 124 541	430 GMF430	Chass. 5234954-> 615.122/224/226		
			 1882 301 238 ●#	420 GF420	Chass. 5234954-> 615.122/224/226		
			 1878 002 706	420 10 420GTZ	Chass. 5234954-> 615.122/224/226		
		OM421	 1861 643 134 #	420 10 420GSZ	615.026-027/064 für Nebenantrieb / for PTO		(82)
			 3151 079 031	KZI-6	615.026-027/064 für Nebenantrieb / for PTO		(82)
	OM421.905, OM421.909	 3189 600 060					
1222 650.036/037 650.034 1222 A, 1222 LA 650.232 650.234 1222 AF 650.286 1222 F 650.086 1222 S, 1222 LS 650.132	07.89 - 08.94	OM441	 3400 123 001	430 10 MFZ430	650.132/232/234/286/034/036-037/086		
	09.89 - 07.94		 3482 081 232	430WGTZ			
	09.89 - 09.93		 1878 080 031	KZISZ-5			
	07.89 - 08.94		 1862 225 132 #	400 10 400GTZ			
	07.89 - 08.94		 3151 000 549				
1222 A 615.224 615.248 615.226 615.242 615.244 615.247 1222 S 615.122	05.82 - 10.90	OM421/422	 1882 302 131	380 GF380	->Chass. 5234953 615.122/224/226		
	07.82 - 02.90		 1878 000 105	380 10 380GTZ	->Chass. 5234953 615.122/224/226		
			 3151 000 375	KZIS-4	->Chass. 5095724 615.122/224/226		
			 3151 126 031	KZI-4,5	Chass. 5095725-> 615.122/224/226		
			 3482 124 541	430 GMF430	Chass. 5234954-> 615.122/224/226		
			 1882 301 238 ●#	420 GF420	Chass. 5234954-> 615.122/224/226		
			 1878 002 706	420 10 420GTZ	Chass. 5234954-> 615.122/224/226		
			OM421.905, OM421.909	 3189 600 060			
1222 AF 615.264	05.82 - 12.91	OM421/422	 1882 302 131	380 GF380			
			 1878 000 105	380 10 380GTZ			
			 3151 000 375	KZIS-4			
		OM421.906	 3189 600 060				
1222 AS 615.226 615.122 615.224 L 1222 615.026 615.028 615.027		OM421/422	 1882 302 131	380 GF380	->Chass. 5234953		
			 1878 000 105	380 10 380GTZ	->Chass. 5234953		
			 3151 000 375	KZIS-4	->Chass. 5095724		
			 3151 126 031	KZI-4,5	Chass. 5095725 - Chass. 5234953		
			 3482 124 541	430 GMF430	Chass. 5234954->		
			 1882 301 238 ●#	420 GF420	Chass. 5234954->		
			 1878 002 706	420 10 420GTZ	Chass. 5234954->		
			 3151 126 031	KZI-4,5	Chass. 5234954->		
	 3189 600 060						

MERCEDES-BENZ

1222									
1222 F 615.064	05.82 - 12.91	OM421/422		1882 302 131	380 GF380	->Chass. 5234953 615.064			
				1878 000 105	380 10 380GTZ	->Chass. 5234953 615.064			
				3151 000 375	KZIS-4	->Chass. 5104252 615.064			
				3151 126 031	KZI-4,5	Chass. 5104252 - Chass. 5234953 615.064			
				3482 124 541	430 GMF430	Chass. 5234954-> 615.064			
				1882 301 238 ●#	420 GF420	Chass. 5234954-> 615.064			
				1878 002 706	420 10 420GTZ	Chass. 5234954-> 615.064			
				3151 126 031	KZI-4,5	Chass. 5234954-> 615.064			
				OM421		1861 643 134 #	420 10 420GSZ	615.026-027/064 für Nebenantrieb / for PTO	(82)
						3151 079 031	KZI-6	615.026-027/064 für Nebenantrieb / for PTO	(82)
		OM421.906		3189 600 060					

1224							
1224 650.288		OM366LA, 401LA		3400 124 101 ⊗ 3482 081 232 ⊗ 1878 005 668 ⊙ 3151 000 549	430 10 MFZ430 430WGTZ KZISZ-5		
1224 AF 650.286 650.282	02.93 - 09.96	OM366LA, 401LA		3482 051 132 #	350 GMF350X	->Chass. K062599	
				1878 001 070	350 10 350GTZ	->Chass. K062599	
				3151 000 374	KZIS-4	->Chass. K062599	
				1882 166 737	380 GF380	Chass. K062600->	
				1878 000 105	380 10 380GTZ	Chass. K062600->	
1224 AF 650.282 650.286	02.93 - 09.96	OM366LA, 401LA		3400 123 001 ⊗ 3482 081 232 ⊗ 1878 080 031 ⊙ 3151 000 549	430 10 MFZ430 430WGTZ KZISZ-5	650.286	
				1862 225 132 #	400 10 400GTZ	650.286	
1224 F 650.086	07.89 - 08.94	OM366LA, 401LA		3400 123 001 ⊗ 3482 081 232 ⊗ 1878 080 031 ⊙ 3151 000 549	430 10 MFZ430 430WGTZ KZISZ-5	650.086	
				1862 225 132 #	400 10 400GTZ	650.086	

1225								
1225 AF 615.266 615.264 1225 AF 615.266	05.82 - 12.91	OM421/422		1882 302 131	380 GF380	615.264		
	05.82 - 12.91			1878 000 105	380 10 380GTZ	615.264		
				3151 000 375	KZIS-4	615.264		
			1882 302 135 #	380 GF380	615.266			
			1878 000 105	380 10 380GTZ	615.266			
					3151 126 031	KZI-4,5	615.266	
			OM422.923, OM442.907, OM422.913		3189 600 060			





		CODE				
--	--	------	--	---	---	---

MERCEDES-BENZ









1226

1226 AF 650.288	02.93 - 09.96	OM442.933, OM401.989,		3400 124 101 ⊗ 3482 081 232 ⊗ 1878 005 668 ⊙ 3151 000 549	430 10 MFZ430 430WGTZ KZISZ-5	
1226 AF 650.288	02.90 - 09.93	OM401.978, OM441.989,				
1226 AF 650.288	02.93 - 09.96	OM442.932, OM442.926, OM442.914, OM401.973, OM442.907, OM442.920, OM401.984				



1227

1227 A 650.234	01.92 - 07.92	OM401LA		3400 123 001 ⊗ 3482 081 232 ⊗ 1878 080 031 ⊙ 3151 000 549	430 10 MFZ430 430WGTZ KZISZ-5	
				1862 225 132 #	400 10 400GTZ	
1227 AF, 1227 LAF 650.288 650.284	01.92 - 07.92	OM401LA		3400 124 101 ⊗ 3482 081 232 ⊗ 1878 005 668 ⊙ 3151 000 549	430 10 MFZ430 430WGTZ KZISZ-5	650.288
		OM441LA		3400 124 001 ⊗ 3482 081 231 ⊗ 1878 634 027 ⊙ 3151 000 278	430 10 MFZ430 430WGTZ KZISZ-5	650.284
		OM445.933		3189 600 059		



1228

1228 F 615.064		OM421/422		1882 302 131	380 GF380	->Chass. 5234953
				1878 000 105	380 10 380GTZ	->Chass. 5234953
				3151 000 375	KZIS-4	->Chass. 5104252
				3151 126 031	KZI-4,5	Chass. 5104253 - Chass. 5234953
				1882 301 238 #	420 GF420	Chass. 5234954->
				3482 124 541	430 GMF430	Chass. 5234954->
				1878 002 706	420 10 420GTZ	Chass. 5234954->
				3151 126 031	KZI-4,5	Chass. 5234954->
				3189 600 060		



1231

1231 AF 650.286	01.92 - 09.96	OM401LA		3400 123 001 ⊗ 3482 081 232 ⊗ 1878 080 031 ⊙ 3151 000 549	430 10 MFZ430 430WGTZ KZISZ-5	650.286
				1862 225 132 #	400 10 400GTZ	650.286

































1234

1234 AF 650.284 650.288	01.92 - 09.96	OM401LA		3400 124 101 ⊗ 3482 081 232 ⊗ 1878 005 668 ⊙ 3151 000 549	430 10 MFZ430 430WGTZ KZISZ-5	650.288
		OM441LA		3400 124 001 ⊗ 3482 081 231 ⊗ 1878 634 027 ⊙ 3151 000 278	430 10 MFZ430 430WGTZ KZISZ-5	
		OM441.993, OM441.989, OM445.923		3189 600 059		

1313



















L,LA,LP 1313				1882 252 331	310 GFX310	Mot. 112293->
				1861 303 248	310 10 310GSB	Mot. 112293->



































MERCEDES-BENZ

1313						
L,LA,LP 1313		OM352A		1882 252 333	310 GFX310	
				1861 303 248	310 10 310GSB	
L,LK,LS,LKO 1313 352.021-023 352.010 352.015 352.000-004 352.014 352.011		OM352, 353		1882 201 132	295 GF295	->Chass. 760271
				1861 279 133	295 10 295GTZ	->Chass. 760271
				3151 095 043	KZI-3	->Chass. 760271
				1882 252 331	310 GFX310	Chass. 760272 - Chass. 922885
				1861 303 248	310 10 310GSB	Chass. 760272->
				1882 305 131	310 GFX310	Chass. 922886->
				3151 095 043	KZI-3	
LA,LAK,LAS 1313 352.122 352.111 352.115 352.114 352.101-103 352.121 352.110		OM352, 353		1882 201 132	295 GF295	->Chass. 760271 352.101-103/110-111/114-115/121-122 nicht für Fahrgestellnummer / not for chassis no.: 500001-599999 (97)
				1861 279 133	295 10 295GTZ	->Chass. 760271 352.101-103/110-111/114-115/121-122 nicht für Fahrgestellnummer / not for chassis no.: 500001-599999 (97)
				1882 252 331	310 GFX310	Chass. 760272 - Chass. 922885 Chass. 500001 - Chass. 599999 352.101-103/110-111/114-115/121-122
				1861 303 248	310 10 310GSB	Chass. 760272-> Chass. 500001 - Chass. 599999 352.101-103/110-111/114-115/121-122
				1882 305 131	310 GFX310	Chass. 922886-> 352.101-103/110-111/114-115/121-122
				3151 095 043	KZI-3	352.101-103/110-111/114-115/121-122
LF 1313 352.018		OM352, 353		1882 252 333	310 GFX310	->Chass. 922885
				1882 305 132	310 GFX310	Chass. 922886->
				1861 303 248	310 10 310GSB	
				3151 095 043	KZI-3	
LP,LPK,LPKO 1313 352.062 352.050-054 352.072 352.071 352.063		OM352		1882 305 132	310 GFX310	Sonderausführung / Special design (60)
				1861 303 248	310 10 310GSB	Sonderausführung / Special design (60)
				3151 095 043	KZI-3	Sonderausführung / Special design (60)
LP,LPK,LPS 1313 352.050-054 352.071/072 352.062-065		OM352		1882 201 132	295 GF295	->Chass. 760271
				1861 279 133	295 10 295GTZ	->Chass. 760271
				3151 095 043	KZI-3	->Chass. 922885
				1882 252 331	310 GFX310	Chass. 760272 - Chass. 922885
				1861 303 248	310 10 310GSB	Chass. 760272->
				1882 305 131	310 GFX310	Chass. 922886->
				3151 095 043	KZI-3	
				1882 252 333	310 GFX310	->Chass. 922885 Sonderausführung / Special design (60)
				1882 305 132	310 GFX310	Chass. 922886-> Sonderausführung / Special design (60)
				1861 303 248	310 10 310GSB	Sonderausführung / Special design (60)
				3151 095 043	KZI-3	Sonderausführung / Special design (60)

		CODE				
--	--	------	--	---	---	---

MERCEDES-BENZ

1314						
1314 675.034 675.032/033 1314 AK 675.146/147 1314 K 675.046	07.84 - 12.98	OM366		3400 122 401  3482 008 038  1861 964 034  3151 044 031	310 10 MF310 310WGSZ KZI-3	
	06.87 - 12.98				3400 124 301  3482 012 211  1861 963 033  3151 044 031	330 10 für / for: SA24493-01 Sonderausführung / Special design
1314 KO 675.093	07.84 - 12.98	OM356.908, OM366.936		3400 124 301  3482 012 211  1861 963 033  3151 044 031	330 10 GMF330 330WGSZ KZI-3	
				3400 125 001  3482 000 953  1878 001 070  3151 000 374	350 10 für / for: SA33607-01 GMF350X 350GTZ KZIS-4	(69)
				3482 012 211	330 für / for: SA24482-03 GMF330	(69)
				1861 571 236	330 10 für / for: SA24482-03 330GSZ	(69)
				3151 116 031	330 10 für / for: SA24482-03 KZI-3	(69)













1317							
1317,1317 L 676.233 676.236 676.237.12 676.238 676.034-037 676.238.12 676.032/033 676.039 676.236.12 676.237 676.239.12 676.038 676.235 676.232 676.234 676.239 1317 S,1317 LS 676.256 676.056 676.257 676.059 676.057	01.84 - 12.98	OM356, 366, A, LA		3482 012 240	330 GMF330		
				1861 963 033	330 10 330WGSZ		
	01.84 - 12.98	OM366		3151 044 031	KZI-3		
				3482 000 953	350 Getr. / GBox: G4 GMF350X		
				1878 001 144	350 10 Getr. / GBox: G4 350WGTZ		
				3151 000 374	350 10 Getr. / GBox: G4 KZIS-4		
1317,1317 L 676.337 676.339 677.033 676.438 676.437 676.338 676.336 676.436 676.439 1317 K 676.343 1317 KO 676.395 1317 LS 676.457 676.456	03.96 - 12.98	OM904LA		3400 121 401  3482 000 462  1878 052 842  3151 000 374	362 18 676.436-439/456-457/336-338/343/395 MF362 362WGTB KZIS-4		
	03.96 - 12.98				3400 700 484 HD	362 18 676.436-439/456-457/336-338/343/395 MF362 362WGTB	
	03.96 - 12.98				 3482 000 462  1878 006 757		
	03.96 - 12.98						
1317 AK 675.147 675.146 1317 K 675.046	01.84 -	OM366		3400 122 401  3482 008 038  1861 964 034  3151 044 031	310 10 MF310 310WGSZ KZI-3		
	01.84 -						
1317 AK 676.147 675.146 676.146 676.149 676.148 1317 AK 676.147	08.84 - 12.98	OM366A, LA		3482 012 240	330 676.146-149 GMF330		
	12.92 - 12.98				1861 963 033	330 10 676.146-149 330WGSZ	
					3151 044 031	330 10 676.146-149 KZI-3	
1317 K 675.046 676.043	07.84 - 12.98	OM356, 366, LA		3482 012 240	330 676.032-039/043 GMF330		
				1861 963 033	330 10 676.032-039/043 330WGSZ		
				3151 044 031	330 10 676.032-039/043 KZI-3		
1317 KO 675.093		OM366		3400 124 301  3482 012 211  1861 963 033  3151 044 031	330 10 GMF330 330WGSZ KZI-3		
1317 KO 676.095 675.093	03.94 - 12.98	OM357.903, OM357.962, OM356.944		3400 124 301  3482 012 211  1861 963 033  3151 044 031	330 10 GMF330 330WGSZ KZI-3		
LP,LPK,LPS 1317 352				1882 234 433	350 GF350		
				1878 001 074	350 10 350GTZ		



		CODE				
--	--	------	--	---	---	---

MERCEDES-BENZ











1317						
LP,LPK,LPS,LPKO 1317 352.091-093 352.055-059 352.082-087		OM327		1882 234 433	350 GF350	
				1878 001 074	350 10 350GTZ	
				3151 094 041	KZI-4	
LP,LPKO 1317 352				1878 001 074	350 10 350GTZ	Nebenantriebs-ID / PTO ID: 70,80 (50)







1319						
LP,LPK,LPS,LPKO 1319 352.055-059 352.091-093 352.082-087		OM327		1882 234 433	350 GF350	
				1878 001 074	350 10 350GTZ	
				3151 094 041	KZI-4	
LP,LPKO 1319 352				1878 001 074	350 10 350GTZ	Nebenantriebs-ID / PTO ID: 70,80 (50)
LP,LPS 1319 327.				1882 234 433	350 GF350	
				1878 001 074	350 10 350GTZ	





















1320							
1320,1320 L 677.234 677.232 677.032 1320,1320 L 677.038 677.034 677.234 679.997 677.235 677.036 677.039 677.236 679.235 677.033 677.232/233 677.238 677.032 677.239 677.037 677.035 677.237	01.84 - 12.98	OM366, LA		3400 125 001 ⊗ 3482 000 953 ⊗ 1878 001 070 ⊙ 3151 000 374	350 10 GMF350X 350GTZ KZIS-4	677.032-039/232-234	
	01.84 - 12.98	OM366LA		1882 166 737	380 GF380	677.236-239/258-259 679.235	
				1878 000 105	380 10 380GTZ	677.236-239/258-259 679.235	
				3151 000 374	KZIS-4	677.236-239/258-259 679.235	
1320 AK 676.147	12.92 - 12.98	OM366LA		3482 012 240	330 GMF330	676.147	
				1861 963 033	330 10 330WGSZ	676.147	
				3151 044 031	KZI-3	676.147	
1320 L 677.235	12.92 - 12.98	OM366LA		3400 125 001 ⊗ 3482 000 953 ⊗ 1878 001 070 ⊙ 3151 000 374	350 10 GMF350X 350GTZ KZIS-4	677.235	
1320 S,1320 LS 677.059 677.258 677.257 677.256 677.057 677.056 677.259	01.84 - 12.98	OM366, LA		3400 125 001 ⊗ 3482 000 953 ⊗ 1878 001 070 ⊙ 3151 000 374	350 10 GMF350X 350GTZ KZIS-4	677.056-057	
		OM366LA		3400 125 001 ⊗ 3482 000 953 ⊗ 1878 001 070 ⊙ 3151 000 374	350 10 GMF350X 350GTZ KZIS-4	677.256-257	
					1882 166 737	380 GF380	677.236-239/258-259 679.235
					1878 000 105	380 10 380GTZ	677.236-239/258-259 679.235
					3151 000 374	KZIS-4	677.236-239/258-259 679.235

1324						
1324,1324 L 679.037 679.234 679.038 679.233 679.232 679.033 679.238 677.235 679.035 679.032 679.036 679.039 679.237 679.239 679.034 679.235/236	01.84 - 12.98	OM366LA, OM366LS		1882 166 737	380 GF380	
				1878 000 105	380 10 380GTZ	
1324 L 679.235	01.91 - 12.98			3151 000 374	KZIS-4	
1324 S,1324 LS 679.056 679.259 679.059 679.057 679.256 679.058 679.258 679.257	01.84 - 12.98					

MERCEDES-BENZ

1413						
1413 383.008 383.005 383.003 383.002 383.007	09.75 - 12.84	OM353		3482 008 038	310 MF310	
1413 A 383.103	09.75 - 12.84			1861 303 248	310 10 310GSB	
1413 AK 383.141 383.140	09.75 - 12.84			3151 033 031	KZI-3	->Chass. 469330
1413 KO 383.061 383.060	09.75 - 12.84			3151 044 031	KZI-3	Chass. 469331->
1413 AKO 383.160/161	09.75 - 12.84	OM353		3482 008 038	310 MF310	
1413 K 383.040/041	09.75 - 12.84			1861 303 248	310 10 310GSB	
				3151 044 031	KZI-3	
L 1413				1861 919 134	280 10 280GTZ	
L,LA,LP 1413		OM352		1882 201 132	295 GF295	
				1861 279 133	295 10 295GTZ	
				3151 095 043	KZI-3	

1414						
1414 616.006 616.008 616.007 616.004	04.84 - 03.91	OM366		3400 122 401  3482 008 038  1861 964 034  3151 044 031	310 10 MF310 310WGSZ KZI-3	
1414 K 616.105	04.84 - 03.91	OM366		3482 008 038	310 MF310	
				1861 303 248	310 10 310GSB	
				3151 116 031	KZI-3	

1417						
1417 651.012 651.014 651.016/017	07.89 - 09.96	OM356		3400 700 417  3482 000 953  1878 001 144  3151 000 374	350 10 651.012/014/016-017/115/315 GMF350X 350WGTZ KZIS-4	
1417 A 651.212	09.89 - 09.96					
1417 AK 651.315 651.212	09.89 - 09.96					
1417 K 651.115	07.89 - 09.96					
1417 383.015 383.013 383.018 383.017	05.75 - 12.84	OM353		3482 008 038	310 MF310	->Chass. 4274598
1417 A 383.113	05.75 - 12.84			1861 303 248	310 10 310GSB	->Chass. 4274598
1417 AK 383.143	05.75 - 12.84			3151 044 031	KZI-3	->Chass. 4274598
1417 AKO 383.166 383.165	05.75 - 12.84			3482 012 211	330 GMF330	Chass. 4274599->
1417 K 383.044 383.043	05.75 - 12.84			1861 571 236	330 10 330GSZ	Chass. 4274599->
1417 KO 383.065/066	05.75 - 12.84			3151 044 031	KZI-3	Chass. 4274599->
		OM352A		3482 012 211	330 GMF330	06.1977->
				1861 571 236	330 10 330GSZ	06.1977->
				3151 033 031	KZI-3	06.1977->
1417 C 616.016/017 616.014 616.018	04.84 - 03.91	OM366		3400 125 001  3482 000 953  1878 001 070  3151 000 374	350 10 GMF350X 350GTZ KZIS-4	
1417 CA 616.214	04.84 - 03.91					
1417 CAK 616.315	04.84 - 03.91			3482 000 953 ●	350 GMF350X	Nur zusammen verbauen / Only install together (53)
1417 CK 616.115	04.84 - 03.91			1878 001 144 ●	350 10 350WGTZ	Nur zusammen verbauen / Only install together (53)
				3151 000 374	KZIS-4	

		CODE				
--	--	------	--	---	---	---

MERCEDES-BENZ







1417

LP 1417	06.69-	OM324	 1882 234 433	350 GF350	
			 1878 001 074	350 10 350GTZ	
			 3151 044 031	KZI-3	







1418

L,LS,LK,LP,LPS 1418 338.006 338.056 338.064 354.053 354.062 338.009 338.041 338.061/062 354.052 338.007 338.057 354.054/055 354.064 338.015 338.054 338.051 338.002 354.063 338.001 338.058 338.008		OM326, 346	 1882 110 542 ▲	350 GF350	
			 1878 001 074	350 10 350GTZ	





1419

1419,1419 L 383.022/023 383.027/028 383.025 383.222/223 383.225 383.227/228	08.73-09.96	OM401	 3482 000 953	350 GMF350X	
	05.75-12.84		 1878 001 070	350 10 350GTZ	
	05.75-12.82		 3151 043 031	KZI-4,5	
	05.75-12.82				
1419 AK 383.146	05.75-12.84				
1419 AS 383.154	05.75-12.82				
1419 F 383.084	05.75-12.82				
1419 K 383.046/047	05.75-12.82				
1419 S,1419 LS 383.054/055 383.254/255	08.73-09.96				
1419 C,1419 CL 616.047 616.447/448 616.046 616.048	08.73-09.96	OM362, 366	 3400 125 001	350 10 GMF350X 350GTZ KZIS-4	
			 3482 000 953	350 GMF350X	Nur zusammen verbauen / Only install together (53)
			 1878 001 144 ●	350 10 350WGTZ	Nur zusammen verbauen / Only install together (53)
			 3151 000 374	KZIS-4	

1420





































1420,1420 L 651.427 651.027 651.426 651.014 651.024 651.026	12.87-09.96	OM366	 3400 125 001	350 10 GMF350X 350GTZ KZIS-4	651.426-427/522 616.542
	02.90-09.96		 3482 000 953		
	07.85-03.91		 1878 001 070		
1420 LS 651.522					
1420 LS 616.542					
1420,1420 L 616.046 616.048 616.448 616.047 616.447	08.73-09.96	OM362, 366	 3400 125 001	350 10 GMF350X 350GTZ KZIS-4	
			 3482 000 953 ●	350 GMF350X	Nur zusammen verbauen / Only install together (53)
			 1878 001 144 ●	350 10 350WGTZ	Nur zusammen verbauen / Only install together (53)
			 3151 044 031	KZI-3	

1422















1422 651.032 651.034 651.037 651.036	02.93-08.94	OM401LA, 441, 441LA	 3400 123 001	430 10 MFZ430 430WGTZ KZISZ-5	651.434/436-437/531-532/032/034/036-037/087 /131-132
	02.93-08.94		 3482 081 232		
1422 F 651.087	02.93-08.94		 1878 080 031		
1422 F 651.087	07.89-09.93		 3151 000 549		
1422 LS 651.532 651.531	02.93-08.94		 1862 225 132 #	400 10 400GTZ	651.434/436-437/531-532/032/034/036-037/087 /131-132

MERCEDES-BENZ

1422





































1422,1422 L 651.436 651.034 651.036 651.032 651.037 651.434 651.437 1422 F 651.087 1422 S,1422 LS 651.132 651.532 651.131 651.531	12.87 - 09.96	OM401LA, 441, 441LA		3400 123 001  3482 081 232  1878 080 031  3151 000 549	430 10 MFZ430 430WGTZ KZISZ-5	651.434/436-437/531-532/032/034/036-037/087 /131-132		
	03.93 - 08.94				1862 225 132 #  3482 081 232  1878 080 031  3151 000 549	400 10 400GTZ	651.434/436-437/531-532/032/034/036-037/087 /131-132	
	12.87 - 09.96	OM441			3400 123 001  3482 081 232  1878 080 031  3151 000 549	430 10 MFZ430 430WGTZ KZISZ-5	651.434/436-437/531-532	
					1862 225 132 #  3482 081 232  1878 080 031  3151 000 549	400 10 400GTZ	651.434/436-437/531-532	
1422,1422 L 616.026 616.426 616.028 616.024 616.027 616.428 616.427 1422 F 616.065	08.73 - 09.96	OM421, 422		1882 302 131	380 GF380	->Chass. 5234953 616.024-028/426-428		
	05.82 - 10.90				1878 000 105	380 10 380GTZ	->Chass. 5095724 616.024-028/426-428	
					3151 000 375	KZIS-4	->Chass. 5095724 616.024-028/426-428	
					3151 126 031	KZI-4,5	Chass. 5095725 - Chass. 5234953 616.024-028/426-428	
					3482 124 541	430 GMF430	Chass. 5234954-> 616.024-028/426-428	
					1882 301 238 ●#	420 GF420	Chass. 5234954-> 616.024-028/426-428	
					1878 002 706	420 10 420GTZ	Chass. 5234954-> 616.024-028/426-428	
					3151 126 031	KZI-4,5	Chass. 5234954-> 616.024-028/426-428	
		OM421			1861 643 134 #	420 10 420GSZ	616.024-027/065 für Nebenantrieb / for PTO	(82)
					3151 079 031	KZI-6	616.024-027/065 für Nebenantrieb / for PTO	(82)
	OM421.906, OM421.905			3189 600 060				
1422 S, 1422 LS 616.121 616.521/522 616.122	08.73 - 09.96	OM421, 422		1882 302 131	380 GF380	->Chass. 5234953		
				1878 000 105	380 10 380GTZ	->Chass. 5234953		
				3151 000 375	KZIS-4	->Chass. 5095724		
				3151 126 031	KZI-4,5	Chass. 5095725 - Chass. 5234953		
				3482 124 541	430 GMF430	Chass. 5234954->		
				1882 301 238 ●#	420 GF420	Chass. 5234954->		
				1878 002 706	420 10 420GTZ	Chass. 5234954->		
				3151 126 031	KZI-4,5	Chass. 5234954->		
	OM421.905			3189 600 060				

1424

1424,1424 L 651.044 651.447 651.446 651.046 651.042 651.047 651.444 1424 S,1424 LS 651.536 651.531 651.121/122 651.532 651.537	12.87 - 09.96	OM401		3400 700 411  3482 081 232  1878 080 033  3151 000 278	430 10 MFZ430 430WGTZ KZISZ-5	651.447/537	
	12.87 - 09.96	OM401LA, 441LA		3400 700 411  3482 081 232  1878 080 033  3151 000 278	430 10 MFZ430 430WGTZ KZISZ-5	651.042/044/046-047/121-122	
		OM401.977, OM401.975, OM401.973, OM401.994		3189 600 059			
1424,1424 L 651.047 651.436 651.444 651.044 651.446 651.427 651.437 651.042 651.046 651.447 1424 S,1424 LS 651.121 651.536 651.122 651.537	12.87 - 09.96	OM401LA, 441LA		3400 700 411  3482 081 232  1878 080 033  3151 000 278	430 10 MFZ430 430WGTZ KZISZ-5	651.042/044/046-047/121-122	
	12.87 - 09.96	OM445.926, OM445.938, OM445.924		3189 600 059			

		CODE				
--	--	------	--	---	---	---







MERCEDES-BENZ

















1424							
1424,1424 L 383.035 383.033 383.037/038 1424 F 383.085 1424 K 383.049 383.048 1424 S,1424 LS 383.257 383.256 383.057 383.056	08.73 - 09.96	OM402		1882 302 131	380 GF380	383.057/085/256-257/033/035/037-038/048-049/056	
	07.75 - 01.87			1878 000 105	380 10 380GTZ	383.057/085/256-257/033/035/037-038/048-049/056	
	07.75 - 01.87			3151 000 375	KZIS-4	383.057/085/256-257/033/035/037-038/048-049/056	
	08.73 - 09.96	OM402.919, OM402.911, OM402.910		3189 600 060			
1424 F 651.087		OM366LA, 401LA		3400 123 001  3482 081 232  1878 080 031  3151 000 549	430 10 MFZ430 430WGTZ KZISZ-5		
				1862 225 132 #	400 10 400GTZ		
LP 1424 354.012 354.002-006 354.015 354.053 354.013 354.062-064 354.054 354.016 354.055 354.052 LPS 1424 354.002-006 354.054 354.016 354.062-064 354.012 354.055 354.013 354.053 354.015 354.052		OM346		1882 110 542 ▲	350 GF350	354.052-053-054-055/062-064	
				1878 001 074	350 10 350GTZ	354.052-053-054-055/062-064	
			OM355		1882 166 737	380 GF380	354.002-006/012-013/015-016
					1878 000 104	380 10 380GTZ	354.002-006/012-013/015-016
					3151 000 529	KZIS-4	354.002-006/012-013/015-016
							
1425							
1425 616.026-028		OM421, 422		1882 302 131	380 GF380	->Chass. 5234953	
				1878 000 105	380 10 380GTZ	->Chass. 5234953	
				3151 000 375	KZIS-4	->Chass. 5095724	
				3151 126 031	KZI-4,5	Chass. 5095725 - Chass. 5234953	
1425 AF 615.264	08.73 - 09.96	OM421/422		1882 302 131	380 GF380	615.264	
				1878 000 105	380 10 380GTZ	615.264	
				3151 000 375	KZIS-4	615.264	
		OM422.909		3189 600 060			
1425 F 615.065 616.065 1425 L 616.426-428		OM421, 422		1882 302 131	380 GF380	->Chass. 5234953	
				1878 000 105	380 10 380GTZ	->Chass. 5234953	
				3151 000 375	KZIS-4	->Chass. 5104252	
				3151 126 031	KZI-4,5	Chass. 5104253 - Chass. 5234953	
				3482 124 541	430 GMF430	Chass. 5234954->	
				1882 301 238 ●#	420 GF420	Chass. 5234954->	
				1878 002 706	420 10 420GTZ	Chass. 5234954->	
				3151 126 031	KZI-4,5	Chass. 5234954->	
			3189 600 060				
1425 S,1425 LS 616.131/132 616.532	08.73 - 09.96	OM422.909		1882 302 135 #	380 GF380		
				1878 000 105	380 10 380GTZ	->Chass. 5104252	
				3151 000 375	KZIS-4	->Chass. 5104252	
				3151 126 031	KZI-4,5	Chass. 5104253->	
				3189 600 060			

		CODE				
--	--	------	--	---	---	---

MERCEDES-BENZ

1426						
1426 S, 1426 LS 651.141/142 651.542	12.87 - 09.96	OM366LA, 401, 442	 3400 124 101 ⊗ 3482 081 232 ⊗ 1878 005 668 ⊙ 3151 000 549	430 10 MFZ430 430WGTZ KZISZ-5	651.087/141-142/542	

1427						
1427 651.047 1427 F 651.089	02.93 - 09.96	OM401LA, 441LA	 3400 700 411 ⊗ 3482 081 232 ⊗ 1878 080 033 ⊙ 3151 000 278	430 10 MFZ430 430WGTZ KZISZ-5	651.047/089/121-122	
	02.93 - 09.96	OM401.985, OM401.991, OM401.973	 3189 600 059			
1427 F 651.089	02.93 - 09.96	OM366LA, 401LA	 3400 124 101 ⊗ 3482 081 232 ⊗ 1878 005 668 ⊙ 3151 000 549	430 10 MFZ430 430WGTZ KZISZ-5	651.131/087	
1427 S, 1427 LS 651.122 651.537 651.131	02.93 - 09.96	OM366LA, 401LA	 3400 124 101 ⊗ 3482 081 232 ⊗ 1878 005 668 ⊙ 3151 000 549	430 10 MFZ430 430WGTZ KZISZ-5	651.131	
		OM401LA, 441LA	 3400 700 411 ⊗ 3482 081 232 ⊗ 1878 080 033 ⊙ 3151 000 278	430 10 MFZ430 430WGTZ KZISZ-5	651.047/089/121-122	
		OM401.973	 3189 600 059			



1428						
1428 AF 615.264		OM421, 422	 1882 302 131	380 GF380	615.264	
			 1878 000 105	380 10 380GTZ	615.264	
			 3151 000 375	KZIS-4	615.264	
			 3189 600 060			
1428 AF 615.266 615.264	08.73 - 09.96	OM422	 1882 302 135 #	380 GF380	615.266	
			 1878 000 105	380 10 380GTZ	615.266	
			 3151 126 031	KZI-4,5	615.266	
1428 F 615.065 1428 F 615.064	05.82 - 12.91	OM421, 422	 1882 302 131	380 GF380	->Chass. 5234953	
			 1878 000 105	380 10 380GTZ	->Chass. 5234953	
			 3151 000 375	KZIS-4	->Chass. 5104252	
			 3151 126 031	KZI-4,5	Chass. 5104253 - Chass. 5234953	
			 3482 124 541	430 GMF430	Chass. 5234954->	
			 1882 301 238 ●#	420 GF420	Chass. 5234954->	
			 1878 002 706	420 10 420GTZ	Chass. 5234954->	
		 3151 126 031	KZI-4,5	Chass. 5234954->		
		 3189 600 060				

















1429						
1429 AF 650.288	01.92 - 09.96	OM442	 3400 124 101 ⊗ 3482 081 232 ⊗ 1878 005 668 ⊙ 3151 000 549	430 10 MFZ430 430WGTZ KZISZ-5	650.288	
1429 AF 615.266	08.73 - 09.96					

1431						
1431 651.034	12.87 - 08.96	OM401.979, OM442.907	 3400 124 101 ⊗ 3482 081 232 ⊗ 1878 005 668 ⊙ 3151 000 549	430 10 MFZ430 430WGTZ KZISZ-5	651.034/087	
1431 651.034	12.87 - 08.96					
1431 F 651.087	12.87 - 08.96					









		CODE				
--	--	------	--	---	---	---

MERCEDES-BENZ

1431						
1431 S 651.121		OM401LA, 441LA		3400 700 411 ⊗ 3482 081 232 ⊗ 1878 080 033 ⊙ 3151 000 278	430 10 MFZ430 430WGTZ KZISZ-5	
				3189 600 059		

1513						
L,LA,LB,LP 1513 LPS,LPK 1513		OM352		1882 252 331	310 GFX310	
				1861 303 248	310 10 310GSB	
L,LA,LK,LS 1513 360.101 360.002 360.010-015 360.102 360.003 LAK,LKO,LAKO 1513 360.122 360.021-023 360.110-113 360.121		OM352, 353		1882 305 131	310 GFX310	
				1861 303 248	310 10 310GSB	
				1861 303 248 ●	310 10 310GSB	
				3151 095 043	KZI-3	
LP,LPK,LPS 1513 360.062-065 360.050-054 360.071-073		OM352, 353		1882 252 331	310 GFX310	->Chass. 922885
				1882 305 131	310 GFX310	Chass. 922886->
				1861 303 248	310 10 310GSB	
				3151 095 043	KZI-3	
				1882 252 333	310 GFX310	->Chass. 922885 Sonderausführung / Special design (60)
				1861 303 248	310 10 310GSB	->Chass. 922885 Sonderausführung / Special design (60)
				3151 095 043	KZI-3	->Chass. 922885 Sonderausführung / Special design (60)
				1882 305 132	310 GFX310	Chass. 922886-> Sonderausführung / Special design (60)
				1861 303 248	310 10 310GSB	Chass. 922886-> Sonderausführung / Special design (60)
				3151 095 043	KZI-3	Chass. 922886-> Sonderausführung / Special design (60)

1514						
1514,1514 L 675.222 675.022 675.025 675.023 675.223-225 675.024	01.84 - 12.98	OM366		3400 122 401 ⊗ 3482 008 038 ⊗ 1861 964 034 ⊙ 3151 044 031	310 10 MF310 310WGSZ KZI-3	675.022-025/045/222-225
	1514 K 675.045		01.89 - 12.98			

1517						
1517,1517 L 676.024 676.026/027 676.045 676.226 676.225 676.228 676.022 676.025 676.222 676.224 676.227 676.229 676.028/029 676.223 676.023	01.84 - 12.98	OM366, A, LA		3482 012 240	330 GMF330	676.022-029/222-229
				1861 963 033	330 10 330WGSZ	676.022-029/222-229
				3151 044 031	KZI-3	676.022-029/222-229
1517,1517 L 676.329 676.427 676.326 676.328 676.429 676.327 676.428 676.426	03.96 - 12.98	OM904LA		3400 121 401 ⊗ 3482 000 462 ⊗ 1878 052 842 ⊙ 3151 000 374	362 18 MF362 362WGTB KZIS-4	676.326-329/349/426-429
	1517 K 676.349		03.96 - 12.98		1878 001 939 HD ●	362 18 362WGTB
1517 K 676.049 676.045	01.89 - 12.98	OM366LA		3482 000 953	350 GMF350X	676.045/049
				1878 001 144	350 10 350WGTZ	676.045/049
				3151 000 374	KZIS-4	676.045/049

		CODE				
--	--	------	--	---	---	---

MERCEDES-BENZ

1517

L,LA,LK,LP,LS 1517 360.132-134 360.107 360.006-008 360.091-093 360.082-085 360.055-059 360.032-034 360.106 LAK,LAS,LPK,LPS 1517 360.032-034 360.091-093 360.082-085 360.107 360.006-008 360.106 360.132-134 360.055-059		OM327, 360	 1882 234 433	350 GF350	360.082-085/091-093/106-107/006-008/032-034 /055-059/132-134	
			 1878 001 074	350 10 350GTZ	360.082-085/091-093/106-107/006-008/032-034 /055-059/132-134	
			 3151 094 041	KZI-4	360.082-085/091-093/106-107/006-008/032-034 /055-059/132-134	
LP 1517 360 LPKO 1517 360			 1878 001 074	350 10 350GTZ	Nebenantriebs-ID / PTO ID: 70,80	(50)

1518

LA 1518 339 LAK 1518 339			 1882 110 542 ▲	350 GF350		
			 1861 034 147 #	350 10		
LP 1518			 1882 110 542 ▲	350 GF350		
			 1878 001 074	350 10 350GTZ		





1519

L,LA,LK,LP,LS 1519 360.006-008 360.082-085 360.107 360.091-093 360.055-059 360.032-034 360.132-134 360.106 LAK,LAS,LPK,LPS 1519 360.082-085 360.055-059 360.032-034 360.107 360.106 360.132-134 360.091-093 360.006-008		OM327, 360	 1882 234 433	350 GF350	360.082-085/091-093/106-107/006-008/032-034 /055-059/132-134	
			 1878 001 074	350 10 350GTZ	360.082-085/091-093/106-107/006-008/032-034 /055-059/132-134	
			 3151 094 041	KZI-4	360.082-085/091-093/106-107/006-008/032-034 /055-059/132-134	
LP 1519 360 LPKO 1519 360			 1878 001 074	350 10 350GTZ	Nebenantriebs-ID / PTO ID: 70,80	(50)





1520

1520,1520 L 677.225 677.222 677.226 677.228 677.026 677.029 677.223/224 677.022 677.028 677.025 677.027 677.227 677.229 677.023/024	01.84 - 12.98	OM366LA	 3482 000 953	350 GMF350X	677.022-029/222-225	
			 1878 001 070	350 10 350GTZ	677.022-029/222-225	
			 3151 000 374	KZIS-4	677.022-029/222-225	
			 1882 166 737	380 GF380	677.226-229	
			 1878 000 105	380 10 380GTZ	677.226-229	
			 3151 000 374	KZIS-4	677.226-229	





























1524

1524,1524 L 679.228 679.025 677.024 679.023/024 679.022 679.224 679.026 679.222 679.229 679.029 679.223 679.226/227 679.027/028 679.225	01.84 - 12.98	OM366LA	 1882 166 737	380 GF380	677.024 679.022-029/222-229	
			 1878 000 105	380 10 380GTZ	677.024 679.022-029/222-229	
			 3151 000 374	KZIS-4	679.022-029/222-229	
			 3151 000 374	KZIS-4	677.024	





































1613

1613,1613 L 385.008/009 385.204 385.208 385.004 385.207 385.000 385.209 385.006/007	08.73 - 09.96	OM353	 3482 008 038	310 MF310		
			 1861 303 248	310 10 310GSB		
			 3151 033 031	KZI-3	->Chass. 4696330	
			 3151 044 031	KZI-3	Chass. 4696331->	

MERCEDES-BENZ

1613						
1613 K 385.040-042	01.75 - 12.84	OM353	 3482 008 038	310 MF310	385.040-041-042	
			 1861 303 248	310 10 310GSB	385.040-041-042	
			 3151 033 031	KZI-3	->Chass. 4188089 385.040	
			 3151 044 031	KZI-3	Chass. 4188090-> 385.040	
			 3151 033 031	KZI-3	->Chass. 4696330 385.041	
			 3151 044 031	KZI-3	Chass. 4696331-> 385.041	
			 3151 044 031	KZI-3	385.042	
1613 KO 385.063 385.062	01.75 - 12.84	OM353	 3482 008 038	310 MF310	385.062-063	
			 1861 303 248	310 10 310GSB	385.062-063	
			 3151 033 031	KZI-3	->Chass. 4188089 385.062-063	
			 3151 044 031	KZI-3	Chass. 4188090-> 385.062-063	
1614						
1614 617.004 617.008 617.003 617.006	04.84 - 03.91	OM366	 3400 122 401	310 10 MF310		
			 3482 008 038	310WGSZ		
			 1861 964 034	KZI-3		
1614 K 617.106/107	04.84 - 03.91	OM366	 3482 008 038	310 MF310	617.106-107	
			 1861 303 248	310 10 310GSB	617.106-107	
			 3151 116 031	KZI-3	617.106-107	
1617						
1617,1617 L 385.010 385.218 385.016/017 385.014 385.019 385.214 385.219 385.217 385.018	08.73 - 09.96	OM353	 3482 008 038	310 MF310	->Chass. 4188089 385.010/014/016-019	
			 1861 303 248	310 10 310GSB	->Chass. 4188089 385.010/014/016-019	
			 3151 033 031	KZI-3	->Chass. 4188089 385.010/014/016-019	
			 3482 012 211	330 GMF330	Chass. 4188090-> 385.010/014/016-019	
			 1861 571 236	330 10 330GSZ	Chass. 4188090-> 385.010/014/016-019	
			 3151 044 031	KZI-3	Chass. 4188090-> 385.010/014/016-019	
			 3482 012 211	330 GMF330	385.214/217-219	
			 1861 571 236	330 10 330GSZ	385.214/217-219	
			 3151 044 031	KZI-3	385.214/217-219	
			1617 A,AKO,K,KO		OM353	 3482 008 038
 1861 303 248	310 10 310GSB					
 3151 044 031	KZI-3					





MERCEDES-BENZ





















1617								
1617 AK 385.144 385.143	01.75 - 07.85	OM353	 3482 008 038	310 MF310	->Chass. 4276220			
			 1861 303 248	310 10 310GSB	->Chass. 4276220			
			 3151 033 031	KZI-3	->Chass. 4276220			
			 3482 012 211	330 GMF330	Chass. 4276221->			
			 1861 571 236	330 10 330GSZ	Chass. 4276221->			
			 3151 044 031	KZI-3	Chass. 4276221->			
		OM352A	 3482 012 211	330 GMF330	06.1977->			
			 1861 571 236	330 10 330GSZ	06.1977->			
			 3151 033 031	KZI-3	06.1977->			
1617 C,1617 CL 617.018 617.414 617.416 617.418 617.013 617.016 617.019 617.014 1617 CAK 617.316 1617 CK 617.116/117 1617 CS 617.111	08.73 - 09.96	OM362, 366	 3400 125 001	350 10 GMF350X				
	04.84 - 03.91		 3482 000 953	350GTZ				
			 1878 001 070	KZIS-4				
	04.84 - 03.91		 3482 000 953 ●	350 GMF350X	Nur zusammen verbauen / Only install together		(53)	
			 1878 001 144 ●	350 10 350WGTZ	Nur zusammen verbauen / Only install together		(53)	
			 3151 000 374	KZIS-4				
	1617 K 385.045 385.043/044		01.75 - 07.85	OM353	 3482 008 038	310 MF310	->Chass. 4188089 385.043-045	
 1861 303 248		310 10 310GSB			->Chass. 4188089 385.043-045			
 3151 033 031		KZI-3			->Chass. 4188089 385.043-045			
 3482 012 211		330 GMF330			Chass. 4188090-> 385.043-045			
 1861 571 236		330 10 330GSZ			Chass. 4188090-> 385.043-045			
 3151 044 031		KZI-3			Chass. 4188090-> 385.043-045			
OM352A		 3482 012 211		330 GMF330	06.1977->			
		 1861 571 236		330 10 330GSZ	06.1977->			
		 3151 033 031		KZI-3	06.1977->			
1617 KO 385.069 385.067/068		01.75 - 07.85		OM353	 3482 008 038	310 MF310	->Chass. 4188089 385.067-069	
					 1861 303 248	310 10 310GSB	->Chass. 4188089 385.067-069	
					 3151 033 031	KZI-3	->Chass. 4188089 385.067-069	
					 3482 012 211	330 GMF330	Chass. 4188090-> 385.067/069	
					 1861 571 236	330 10 330GSZ	Chass. 4188090-> 385.067/069	
					 3151 044 031	KZI-3	Chass. 4188090-> 385.067/069	
1617 S 385.052	01.75 - 07.85	OM353	 3482 008 038	310 MF310	->Chass. 4188089 385.052			
			 1861 303 248	310 10 310GSB	->Chass. 4188089 385.052			
			 3151 033 031	KZI-3	->Chass. 4188089 385.052			
			 3482 012 211	330 GMF330	Chass. 4188090-> 385.052			
			 1861 571 236	330 10 330GSZ	Chass. 4188090-> 385.052			
			 3151 044 031	KZI-3	Chass. 4188090-> 385.052			

		CODE				
--	--	------	--	---	---	---

MERCEDES-BENZ











1617						
LP,LPKO 1617 355.059 355.057 355.056 355.055 355.093 355.092 355.058		OM360		1882 234 433	350 GF350	
				1878 001 074	350 10 350GTZ	
				3151 094 041	KZI-4	
LP 1617 355				1878 001 074	350 10 350GTZ	Nebenantriebs-ID / PTO ID: 70,80 (50)

1618						
1618 349				1882 166 737	380 GF380	
				1878 000 104	380 10 380GTZ	
L 1618 349 LK 1618 349 LS 1618 349				1882 110 542 ▲	350 GF350	
				1861 034 147 #	350 10	









1619						
1619 370				1882 166 737	380 GF380	
				1878 000 104	380 10 380GTZ	
1619,1619 L 385.027 385.228 385.227 385.029 385.224 385.020 385.229 385.026 385.028 385.024 1619 K 385.046 385.048 385.047 1619 KO 385.071/072 385.070	08.73 - 09.96 11.74 - 12.82 11.74 - 01.87	OM401		3482 000 953	350 GMF350X	385.054-055/070-072/122/146-147/224/227-229 /020/024/026-029/046-048
				1878 001 070	350 10 350GTZ	385.054-055/070-072/122/146-147/224/227-229 /020/024/026-029/046-048
				3151 043 031	KZI-4,5	385.054-055/070-072/122/146-147/224/227-229 /020/024/026-029/046-048
				1882 302 131	380 GF380	385.054-055/070-072/227/020/024/026-029 /046-048
				1878 000 105	380 10 380GTZ	385.054-055/070-072/227/020/024/026-029 /046-048
				3151 000 375	KZIS-4	385.054-055/070-072/227/020/024/026-029 /046-048
				1878 000 964	380 10 380GTZ	385.070-072/146-147/020/024/026-028/046-048 für Nebenantrieb / for PTO (82)
1619 AK 385.146/147	11.74 - 12.82	OM401		3482 000 953	350 GMF350X	385.146-147
				1878 000 964	380 10 380GTZ	385.146-147 für Nebenantrieb / for PTO (82)
				1878 001 070	350 10 350GTZ	385.146-147
				3151 043 031	KZI-4,5	385.146-147
1619 C,1619 CL 617.043 617.049 617.044 617.448 617.447	08.73 - 09.96	OM362, 366		3400 125 001	350 10	617.043-049/447-448
				3482 000 953	GMF350X	
				1878 001 070	350GTZ	
				3151 000 374	KZIS-4	
				3482 000 953 ●	350 GMF350X	617.043-049/447-448 Nur zusammen verbauen / Only install together (53)
	1878 001 144 ●	350 10 350WGTZ	617.043-049/447-448 Nur zusammen verbauen / Only install together (53)			
	3151 000 374	KZIS-4	617.043-049/447-448			

MERCEDES-BENZ





1619

1619 S 385.055 385.054	11.74 - 12.84	OM401	 3482 000 953	350 GMF350X	385.054-055	
			 1878 001 070	350 10 350GTZ	385.054-055	
			 3151 043 031	KZI-4,5	385.054-055	
			 1882 302 131	380 GF380	385.054-055	
			 1878 000 105	380 10 380GTZ	385.054-055	
			 3151 000 375	KZIS-4	385.054-055	
		OM401.905, OM401.914	 3189 600 060			
LP 1619 355.093 355.092 355.055-059 LPKO 1619 355.092 355.055-093		OM360	 1882 234 433	350 GF350		
			 1878 001 074	350 10 350GTZ		
			 3151 094 041	KZI-4		
LP 1619 355			 1878 001 074	350 10 350GTZ	Nebenantriebs-ID / PTO ID: 70,80	(50)

1620



































1620,1620 L 617.046 617.447/448 617.048 617.047 617.049 617.043/044	08.73 - 09.96	OM362, 366	 3400 125 001	350 10 GMF350X	617.043-049/447/448	
			 3482 000 953 ●	350 GMF350X	617.043-049/447/448 Nur zusammen verbauen / Only install together	(53)
			 1878 001 144 ●	350 10 350WGTZ	617.043-049/447/448 Nur zusammen verbauen / Only install together	(53)
			 3151 000 374	KZIS-4	617.043-049/447/448	
L 1620 LK 1620 LPS 1620 LS 1620	09.65 - 09.65 - 09.65 - 09.65 -		 1882 166 737	380 GF380	Getr. / GBox: AK 6-80	
			 1878 000 104	380 10 380GTZ	Getr. / GBox: AK 6-80	
			 3151 000 529	KZIS-4	Getr. / GBox: AK 6-80	
L 1620 LP 1620	-08.65 -08.65		 1882 166 737	380 GF380	Getr. / GBox: AK 6-7	
			 1863 010 100	GR-4	Getr. / GBox: AK 6-7 mit Anlauftring / with thrust ring	(88)

1621

1621 1621 K	12.92 - 12.98		 1882 110 542 ▲	350 GF350	359.xxx	
			 1861 034 147 #	350 10	359.xxx	
		OM355	 1882 166 737	380 GF380		
			 1878 000 104	380 10 380GTZ		
			 3151 000 529	KZIS-4		











		CODE				
--	--	------	--	---	---	---



















MERCEDES-BENZ

1622							
1622,1622 L 617.029 617.023 617.425 617.025 617.028 617.024 617.424 617.428 617.026 617.426/427 617.027	08.73 - 09.96	OM421		1882 302 131	380 GF380	->Chass. 234953 617.424-428/023-029	
				1878 000 105	380 10 380GTZ	->Chass. 234953 617.023-029/424-428	
				3151 000 375	KZIS-4	->Chass. 234953 617.023-029/424-428	
				3482 124 541	430 GMF430	Chass. 234954-> 617.023-029/424-428	
				1882 301 238 ●#	420 GF420	Chass. 234954-> 617.023-029/424-428	
				1878 002 706	420 10 420GTZ	Chass. 234954-> 617.424-428/023-029	
				3151 000 375	KZIS-4	Chass. 234954-> 617.424-428/023-029	
				1861 643 134 #	420 10 420GSZ	617.023-029 für Nebenantrieb / for PTO	(82)
				3151 079 031	KZI-6	617.023-029 für Nebenantrieb / for PTO	(82)
		OM421.905, OM441.906, OM441.907		3189 600 060			
1622 AK 617.326 1622 K 617.126/127 1622 S 617.121/122	05.82 - 10.89	OM421		1882 302 131	380 GF380	->Chass. 234953	
				1878 000 105	380 10 380GTZ	->Chass. 234953	
				3151 000 375	KZIS-4	->Chass. 234953	
				3482 124 541	430 GMF430	Chass. 234954->	
				1882 301 238 ●#	420 GF420	Chass. 234954->	
				1878 002 706	420 10 420GTZ	Chass. 234954->	
				3151 000 375	KZIS-4	Chass. 234954->	
				1861 643 134 #	420 10 420GSZ	für Nebenantrieb / for PTO	(82)
				3151 079 031	KZI-6	für Nebenantrieb / for PTO	(82)
		OM421.905		3189 600 060			
1623							
1623 K,L,S,AK,AS,LS 387.027 387.227 387.222-224 387.022-024 387.154 387.053 387.122 387.054 387.026 387.226		OM403		1800 125 301	420 10 GF420	387.154/222-224/226-227/022-024/026-027/053 /054/122	
				1882 301 239	420GTZ		
				1878 002 706	KZIS-4		
				3482 124 534 ●	430 GMF430	387.154/222-224/226-227/022-024/026-027/053 /054/122	
				3189 600 060			
L 1623 LA 1623 LP 1623				1882 166 737	380 GF380		
				1878 000 104	380 10 380GTZ		
1624							
1624 335, 346				1882 166 737	380 GF380		
				1878 000 104	380 10 380GTZ		
				3151 000 529	KZIS-4		
1624,1624 L 385.237 385.239 385.030 385.036 385.238 385.037 385.034 385.039 385.038	08.73 - 09.96	OM402		1882 302 131	380 GF380	385.030/034/036-039/237-239	
				1878 000 105	380 10 380GTZ	385.030/034/036-039/237-239	
				3151 000 375	KZIS-4	385.030/034/036-039/237-239	
				1861 643 134 #	420 10 420GSZ	Chass. 4372224-> 385.034/036 für Nebenantrieb / for PTO	(82)
		OM402.911,		3189 600 060			

		CODE				
--	--	------	--	---	---	---













MERCEDES-BENZ











1624						
1624 K 385.090 385.049 1624 S,1624 LS 385.256 385.056/057	07.75 - 08.82	OM402		1882 302 131	380 GF380	385.049/056-057/256
	08.73 - 09.96	OM402.911, OM402.910		1878 000 105	380 10 380GTZ	385.049/056-057/256
				3151 000 375	KZIS-4	385.049/056-057/256
				3189 600 060		
1624 S 651.121 1624 S 651.121	12.87 - 09.96	OM401.975, OM445.924		3400 700 411  3482 081 232  1878 080 033  3151 000 278	430 10 MFZ430 430WGTZ KZISZ-5	
L 1624 335.365 335.352 335.354-356 335.362 335.364 LA 1624 335.364/365 335.352 335.354-356 335.362 LAK 1624 349.305 346.302-304 346.333 346.103/104 LAS 1624 349.305 346.104 346.333 346.103 346.302-304 LK 1624 346.333 346.302-304 346.103/104 349.305 LP 1624 335.362 335.365 335.352 335.354-356 335.364 LPK 1624 335.362 335.352 335.354-356 335.365 335.364 LPS 1624 335.365 335.362 335.364 335.352 335.354-356 LS 1624 349.305 346.104 346.103 346.302-304 346.333		OM355		1882 166 737	380 GF380	
		1878 000 104	380 10 380GTZ			
		3151 000 529	KZIS-4			

1625							
1625,1625 L 617.036 617.035 617.437 617.435/436 617.033/034	08.73 - 09.96	OM422		1882 302 135 #	380 GF380	617.033-034-035-036	
				1878 000 105	380 10 380GTZ	617.033-034-035-036	
				3151 000 375	KZIS-4	->Chass. 5107148 617.033-034-035-036	
				3151 126 031	KZI-4,5	Chass. 5107149-> 617.033-034-035-036	
				1882 302 135 #	380 GF380	617.435-436-437	
				1878 000 105	380 10 380GTZ	617.435-436-437	
				3151 000 375	KZIS-4	617.435-436	
				3151 126 031	KZI-4,5	617.437	
				1800 125 301  1882 301 239  1878 002 706  3151 000 375	420 10 GF420 420GTZ KZIS-4	617.435/436/437 Sonderausführung / Special design	(60)
				1878 000 964	380 10 380GTZ	617.036 für Nebenantrieb / for PTO	(82)
	3151 204 001	KZI-6	617.036 für Nebenantrieb / for PTO mit Schmierrohranschluss / with lubrication pipe connection	(82) (91)			
1625 AK 617.336	10.80 - 11.89	OM422		1882 302 135 #	380 GF380		
				1878 000 105	380 10 380GTZ		
				3151 126 031	KZI-4,5		
		OM422.909		3189 600 060			

		CODE				
--	--	------	--	---	---	---

MERCEDES-BENZ

1625						
1625 K 617.136	05.80 - 11.89	OM422		1882 302 135 #	380 GF380	
				1878 000 105	380 10 380GTZ	
				3151 000 375	KZIS-4	
		OM422.909		3189 600 060		
1625 S,1625 LS 617.532 617.132 617.130/131 617.531	08.73 - 09.96	OM422		1882 302 135 #	380 GF380	617.532
				1878 000 105	380 10 380GTZ	617.532
				3151 000 375	KZIS-4	617.532
				1882 302 135 #	380 GF380	617.130-131-132
				1878 000 105	380 10 380GTZ	617.130-131-132
				3151 000 375	KZIS-4	->Chass. 5107148 617.130-131-132
			3151 126 031	KZI-4,5	Chass. 5107149-> 617.130-131-132	
		OM422.909		3189 600 060		



























1626						
1626,1626 L 387.217/218 387.018 387.294 387.016/017 387.216 1626 AS 387.112 387.114 1626 S,1626 LS 387.011 387.013 387.212 387.012 387.214 387.213 387.014	08.73 - 09.96	OM402		1882 302 131	380 GF380	387.011-014/016-018/112/114/212-214/216-218 /294
	05.74 - 12.80			1878 000 105	380 10 380GTZ	387.011-014/016-018/112/114/212-214/216-218 /294
	08.73 - 09.96			3151 000 375	KZIS-4	387.011-014/016-018/112/114/212-214/216-218 /294
		OM402.906, OM402.912, OM402.916		3189 600 060		
1626 AK 387.144 1626 K 387.044 387.043	08.73 - 12.80	OM402		1882 302 131	380 GF380	387.144/043-044
	08.73 - 12.80			1878 000 105	380 10 380GTZ	387.144/043-044
				3151 000 375	KZIS-4	387.144/043-044
				1861 643 134 #	420 10 420GSZ	Chass. 4372224-> 387.043-044/144 für Nebenantrieb / for PTO
		OM402.906		3189 600 060		
LP 1626 363.011-013 363.001-004 LPK 1626 363.011-013 363.001-004 LPS 1626 363.001-004 363.011-013		OM402		1882 166 737	380 GF380	
				1878 000 104	380 10 380GTZ	

1627						
1627 AF 650.288	01.92 - 09.96	OM401LA		3400 124 101 3482 081 232 1878 005 668 3151 000 549	430 10 MFZ430 430WGTZ KZISZ-5	650.288















		CODE				
--	--	------	--	---	---	---

MERCEDES-BENZ

1628

1628,1628 L 620.016 620.415-417 620.015 617.034 617.033 620.066 620.466	08.73 - 09.96	OM422	 1882 302 135 #	380 GF380	617.437	
			 1878 000 105	380 10 380GTZ	617.437	
			 3151 126 031	KZI-4,5	617.437	
			 1800 125 301  1882 301 239  1878 002 706  3151 000 375	420 10 GF420 420GTZ KZIS-4	620.015/016/020/066/415-417/466	
			 3482 124 534 ●	430 GMF430	620.015/016/020/066/415-417/466	
		OM421	 1882 342 134	420 GF420X	620.066/416/466 Sonderausführung / Special design	(60)
			 1878 002 878	420 10 420GTZ	620.066/416/466 Sonderausführung / Special design	(60)
			 3151 110 031	KZI-4,5	620.066/416/466 Sonderausführung / Special design	(60)
		OM422.905, OM422.911, OM422.906, OM422.913	 3189 600 060			
1628 A 621.219	01.80 - 05.89	OM422	 1800 125 301  1882 301 239  1878 002 706  3151 000 375	420 10 GF420 420GTZ KZIS-4		
			 3482 124 534 ●	430 GMF430		
			 1882 346 131 #	420 GF420XN	für Nebenantrieb / for PTO	(82)
			 1878 634 014 ▲	420 10 420GSZ	für Nebenantrieb / for PTO	(82)
		OM422.905, OM422.911, OM422.906	 3189 600 060			
1628 S,1628 LS 620.162 620.563 620.511 620.111 620.512 620.112/113 620.562 620.110 620.163 620.513	08.73 - 09.96	OM422	 1800 125 301  1882 301 239  1878 002 706  3151 000 375	420 10 GF420 420GTZ KZIS-4		
			 3482 124 534 ●	430 GMF430		
		OM422.905, OM422.911, OM422.906	 3189 600 060			















1632

1632,1632 L 387.026 387.226 387.027 387.227 1632 AS 387.122	08.73 - 09.96	OM403	 1800 125 301  1882 301 239  1878 002 706  3151 000 375	420 10 GF420 420GTZ KZIS-4	387.122/026-027/226/227	
	05.74 - 09.83	OM403.932, OM403.916, OM403.931	 3482 124 534 ●	430 GMF430	387.122/026-027/226/227	
			 3189 600 060			
1632 AK 387.154 1632 K 387.053/054	08.73 - 08.82	OM403	 1800 125 301  1882 301 239  1878 002 706  3151 000 375	420 10 GF420 420GTZ KZIS-4	387.053-054/154	
	08.73 - 08.82		 3482 124 534 ●	430 GMF430	387.053-054/154	
			 1882 346 131 #	420 GF420XN	387.053-054/154 für Nebenantrieb / for PTO	(82)
			 1878 634 014 ▲	420 10 420GSZ	387.053-054/154 für Nebenantrieb / for PTO	(82)
		OM403.916	 3189 600 060			













		CODE				
--	--	------	--	---	---	---

MERCEDES-BENZ

1632

1632 S,1632 LS 387.022 387.223 387.023/024 387.222 387.224	08.73 - 09.96	OM403	 1800 125 301	420 10	387.022-024/223/224		
			 1882 301 239	GF420			
		 1878 002 706	420GTZ				
		 3151 000 375	KZIS-4				
		 3482 124 534 ●	430	387.022-024/223/224			
			GMF430				
		OM422LA	 1888 042 009	380	01.1980->	für / for: Turbo enthält eine Kupplungsscheibe / This part number includes one clutch disc	(69) (67)
			 1878 000 968 ▽	380 10	01.1980->	für / for: Turbo Lose Kupplungsscheibe / Loose clutch disc	(69) (41)
	 3151 108 031	KZI-4,5	01.1980->	für / for: Turbo	(69)		
	 1882 341 001	380	01.1980->	für / for: Turbo In 1888 enthalten / Contained in 1888	(69) (31)		
	 1859 250 102	380	01.1980->	für / for: Turbo In 1888 enthalten / Contained in 1888	(69) (31)		
	 1878 000 968 △	380 10	01.1980->	für / for: Turbo In 1888 enthalten / Contained in 1888	(69) (31)		
	OM403.932, OM403.916, OM403.931	 3189 600 060					
LP 1632 363.061-067 363.051-057 LPK 1632 363.051-057 363.061-067 LPS 1632 363.061-067 363.051-057		OM403	 3482 124 534	430			
				GMF430			
			 1882 301 239 ●	420			
		 1878 003 320	420 10	420GTZ			







1633

1633,1633 L 620.446 620.096 620.046 620.416 620.496 620.415	08.73 - 09.96	OM422A, 423	 1882 342 134	420	620.046/096/446/496	
				GF420X		
			 1878 002 878	420 10	620.046/096/446/496	
				420GTZ		
			 3151 110 031	KZI-4,5	620.046/096/446/496	
		 1882 346 131 #	420	620.046/142-143 für Nebenantrieb / for PTO	(82)	
			GF420XN			
	 1878 002 706	420 10	620.046/142-143 für Nebenantrieb / for PTO	(82)		
	420GTZ					
	OM421	 1882 342 134	420	620.446 Sonderausführung / Special design	(60)	
		 1878 002 878	420 10	620.446 Sonderausführung / Special design	(60)	
		 3151 110 031	KZI-4,5	620.446 Sonderausführung / Special design	(60)	
1633 S,1633 LS 620.543 620.142/143 620.192/193 620.593	08.73 - 09.96	OM422A, 423	 1882 342 134	420	620.142-143/192-193/543/593	
				GF420X		
			 1878 002 878	420 10	620.142-143/192-193/543/593	
				420GTZ		
			 3151 110 031	KZI-4,5	620.142-143/192-193/543/593	
	 1882 346 131 #	420	620.142-143/192-193/543/593 für Nebenantrieb / for PTO	(82)		
		 1878 002 706	420 10	620.142-143/192-193/543/593 für Nebenantrieb / for PTO	(82)	
		420GTZ				









		CODE				
--	--	------	--	---	---	---

MERCEDES-BENZ







1635

1635,1635 L 645.476 645.026 645.426 645.076 1635 K 645.127 1635 S,1635 LS 645.172 645.573 645.122 645.173 645.523 645.522 645.123	08.73 - 09.96	OM422A, OM442A		1888 055 041	380 GF2/380	enthält eine Kupplungsscheibe / This part number includes one clutch disc	(67)
	02.86 - 07.89			1878 006 055 ▽	380 10 380GT	Lose Kupplungsscheibe / Loose clutch disc	(41)
	08.73 - 09.96			3151 108 031	KZI-4,5		
				1882 349 003	380 GF2/380	In 1888 enthalten / Contained in 1888	(31)
				1859 250 100	380 GF2/380	In 1888 enthalten / Contained in 1888	(31)
				1862 138 032 △#	380 10 380GSZ	In 1888 enthalten / Contained in 1888	(31)







1636

1636,1636 L 620.466 620.026 620.446 620.416 620.066	08.73 - 09.96	OM422A, 423		1882 342 134	420 GF420X	620.026	
				1878 002 878	420 10 420GTZ	620.026	
				3151 110 031	KZI-4,5	620.026	
1636 S,1636 LS 620.122/123 620.523 620.563	08.73 - 09.96	OM422A, 423		1882 342 134	420 GF420X	620.122-123/523	
				1878 002 878	420 10 420GTZ	620.122-123/523	
				3151 110 031	KZI-4,5	620.122-123/523	
		OM421		1882 342 134	420 GF420X	620.563 Sonderausführung / Special design	(60)
				1878 002 878	420 10 420GTZ	620.563 Sonderausführung / Special design	(60)
				3151 110 031	KZI-4,5	620.563 Sonderausführung / Special design	(60)

1638







































1638 620.086 1638 S,1638 LS 620.182 620.583 620.183	11.80 - 12.86	OM422LA		1888 042 009	380 GF2/380	620.086/182-183/583 enthält eine Kupplungsscheibe / This part number includes one clutch disc	(67)
	08.73 - 09.96			1878 000 968 ▽	380 10 380GTZ	620.086/182-183/583 Lose Kupplungsscheibe / Loose clutch disc	(41)
				3151 108 031	KZI-4,5	620.086/182-183/583	
				1882 341 001	380 GF2/380	620.086/182-183/583 In 1888 enthalten / Contained in 1888	(31)
				1859 250 102	380 GF2/380	620.086/182-183/583 In 1888 enthalten / Contained in 1888	(31)
				1878 000 968 △	380 10 380GTZ	620.086/182-183/583 In 1888 enthalten / Contained in 1888	(31)

1644

























1644 645.096 1644 S,1644 LS 645.593 645.193 645.192	06.86 - 08.89	OM442LA		1888 055 247	380 GF2/380	645.096/192-193 enthält eine Kupplungsscheibe / This part number includes one clutch disc	(67)
	08.73 - 09.96			1862 123 131 ▽	380 10 380GV	645.096/192-193 Lose Kupplungsscheibe / Loose clutch disc	(41)
				3151 108 031	KZI-4,5	645.096/192-193	
				1882 349 003	380 GF2/380	645.096/192-193 In 1888 enthalten / Contained in 1888	(31)
				1859 250 100	380 GF2/380	645.096/192-193 In 1888 enthalten / Contained in 1888	(31)
				1862 122 132 △	380 10 380GVZ	645.096/192-193 In 1888 enthalten / Contained in 1888	(31)

		CODE				
--	--	------	--	---	---	---

MERCEDES-BENZ

































1717						
1717,1717 L 652.415 652.010 652.015 652.019 652.419 652.014 652.017 652.417 652.013	12.87 - 09.96	OM356	 3400 700 417  3482 000 953  1878 001 144  3151 000 374	350 10 GMF350X 350WGTZ KZIS-4	652.010/013-015/017/019/415/417/419	
			 1882 166 737	380 GF380	652.013-014-015 Sonderausführung / Special design	(60)
			 1878 001 152	380 10 380WGTZ	652.013-014-015 Sonderausführung / Special design	(60)
			 3151 000 374	KZIS-4	652.013-014-015 Sonderausführung / Special design	(60)
1717 AK 652.316.13 652.316	09.89 - 08.94	OM366.952, OM356.940	 3400 125 001  3482 000 953  1878 001 070  3151 000 374	350 10 GMF350X 350GTZ KZIS-4	652.126-127/326	
			 3400 700 417  3482 000 953  1878 001 144  3151 000 374	350 10 GMF350X 350WGTZ KZIS-4	652.316	
1717 K 652.117 652.116	09.89 - 08.94	OM356	 3400 700 417  3482 000 953  1878 001 144  3151 000 374	350 10 GMF350X 350WGTZ KZIS-4	652.116-117	
			 1882 166 737	380 GF380	652.116-117 Sonderausführung / Special design	(60)
			 1878 001 152	380 10 380WGTZ	652.116-117 Sonderausführung / Special design	(60)
			 3151 000 374	KZIS-4	652.116-117 Sonderausführung / Special design	(60)
1719						
1719 387.006	09.73 - 08.82	OM401	 1882 302 132 #	380 GF380	387.006	
			 1878 000 105	380 10 380GTZ	387.006	
			 3151 000 375	KZIS-4	387.006	
			 1882 302 131	380 GF380	387.006 Sonderausführung / Special design	(60)
			 1878 000 105	380 10 380GTZ	387.006 Sonderausführung / Special design	(60)
			 3151 000 375	KZIS-4	387.006 Sonderausführung / Special design	(60)
			 1878 000 964	380 10 380GTZ	387.006 für Nebenantrieb / for PTO	(82)
		 3151 079 031	KZI-6	387.006 für Nebenantrieb / for PTO	(82)	
		OM401.909, OM401.916	 3189 600 060			
1719 AK 387.134	09.73 - 08.82	OM401	 1882 302 132 #	380 GF380	387.134	
			 1878 000 105	380 10 380GTZ	387.134	
			 3151 000 375	KZIS-4	387.134	
			 1882 302 131	380 GF380	387.134 Sonderausführung / Special design	(60)
			 1878 000 105	380 10 380GTZ	387.134 Sonderausführung / Special design	(60)
		 3151 000 375	KZIS-4	387.134 Sonderausführung / Special design	(60)	
		OM401.909	 3189 600 060			

MERCEDES-BENZ

























1719							
1719 K 387.033/034	09.73 - 08.82	OM401		1882 302 132 #	380 GF380	387.033-034	
				1878 000 105	380 10 380GTZ	387.033-034	
				3151 000 375	KZIS-4	387.033-034	
				1882 302 131	380 GF380	387.033-034 Sonderausführung / Special design	(60)
				1878 000 105	380 10 380GTZ	387.033-034 Sonderausführung / Special design	(60)
				3151 000 375	KZIS-4	387.033-034 Sonderausführung / Special design	(60)
				1878 000 964	380 10 380GTZ	387.034 für Nebenantrieb / for PTO	(82)
				OM401.909		3189 600 060	
1719 S 387.002	09.73 - 08.82	OM401		1882 302 132 #	380 GF380		
				1878 000 105	380 10 380GTZ		
				3151 000 375	KZIS-4		
				1882 302 131	380 GF380	Sonderausführung / Special design	(60)
				1878 000 105	380 10 380GTZ	Sonderausführung / Special design	(60)
				3151 000 375	KZIS-4	Sonderausführung / Special design	(60)
				OM401.909, OM401.916		3189 600 060	
1720							
1720 677.024 677.022 677.026	01.84 - 12.98	OM366LA		3482 000 953	350 GMF350X	677.022/024	
				1878 001 070	350 10 350GTZ	677.022/024	
				3151 000 374	KZIS-4	677.022/024	
1720,1720 L 652.020 652.023 652.029 652.436 652.428/429 652.025 652.024 652.027/028 699.001	12.87 - 09.96	OM356		3400 125 001 ⊗ 3482 000 953 ⊗ 1878 001 070 ⊙ 3151 000 374	350 10 GMF350X 350GTZ KZIS-4	652.020-029/428-429	
				1882 166 737	380 GF380	652.020-029/428-429	
				1878 001 152	380 10 380WGTZ	652.020-029/428-429	
				3151 000 374	KZIS-4	652.020-029/428-429	
1720 L 652.436	12.88 - 08.94	OM441.916, OM441.932, OM441.920		3400 123 001 ⊗ 3482 081 232 ⊗ 1878 080 031 ⊙ 3151 000 549	430 10 MFZ430 430WGTZ KZISZ-5		
1720 S 652.121	02.90 - 08.94	OM356		3400 125 001 ⊗ 3482 000 953 ⊗ 1878 001 070 ⊙ 3151 000 374	350 10 GMF350X 350GTZ KZIS-4	652.121	
1722							
1722 652.033	12.88 - 08.94	OM401.979, OM401.978,		3400 123 001 ⊗ 3482 081 232 ⊗ 1878 080 031 ⊙ 3151 000 549	430 10 MFZ430 430WGTZ KZISZ-5		
1722 AK 652.336	12.88 - 08.94	OM356.999, OM366.983,					
1722 AK 652.336	12.88 - 08.94	OM401.973, OM442.907					
1722 K 652.136	12.88 - 08.94						
1722 L 652.436 652.439 652.438 652.437	12.88 - 08.94						

		CODE				
--	--	------	--	---	---	---

MERCEDES-BENZ



1722							
1722 652.131/132 1722,1722 L, 1722 LL 652.033/034 652.437 652.439 652.039 652.038 652.436 652.035-037 652.435 652.438 1722, 1722 L, 1722 LL 652.132 652.439 652.478 652.131 652.438 1722 AK 652.336 1722 K 652.136/137 1722 S 652.131/132	08.88 - 08.94	OM441		3482 081 232	430 MFZ430	->Chass. 563495	
	12.87 - 09.96			1862 225 132 #	400 10 400GTZ	->Chass. 563495	
	08.88 - 08.94			3151 000 549	KZISZ-5	->Chass. 563495 für Ausrückgabel mit Rollen / for release fork with rollers	(71)
	12.88 - 08.94			3400 123 001  3482 081 232  1878 080 031  3151 000 549	430 10 MFZ430 430WGTZ KZISZ-5	Chass. 563496->	
12.88 - 08.94							
12.88 - 08.94							
12.88 - 08.94							
1724							
1723, 1724 679.022	01.84 - 12.98	OM366LA		1882 166 737	380 GF380	679.022	
				1878 000 105	380 10 380GTZ	679.022	
				3151 000 374	KZIS-4	679.022	
1726							
1726,1726 L, 1726 LL 652.446/447 652.043 652.047 652.448 652.046 652.045 1726 AK 652.346 1726 S,1726 LS 652.541 652.142 652.542 652.141	12.87 - 09.96	OM442		3400 124 101  3482 081 232  1878 005 668  3151 000 549	430 10 MFZ430 430WGTZ KZISZ-5	652.346/446-448/541-542/043/045-047/141-142 /146	
	06.89 - 08.94			1878 003 269	420 10 420GTZ	652.346/446-448/541-542/043/045-047/141-142 für Nebenantrieb / for PTO	(82)
	12.87 - 09.96			3151 166 031	KZI-6	652.346/446-448/541-542/043/045-047/141-142 für Nebenantrieb / for PTO	(82)
1726 K 652.146	12.88 - 08.94	OM442		3400 124 101  3482 081 232  1878 005 668  3151 000 549	430 10 MFZ430 430WGTZ KZISZ-5	652.146	
1726 L, 1726 LL 652.446/447 1726 LL 652.448	12.88 - 08.94	OM401.978, OM401.973, OM441.960		3400 124 101  3482 081 232  1878 005 668  3151 000 549	430 10 MFZ430 430WGTZ KZISZ-5	652.446-448	
	12.87 - 09.96			1878 003 269	420 10 420GTZ	652.446-448 für Nebenantrieb / for PTO	(82)
				3151 166 031	KZI-6	652.446-448 für Nebenantrieb / for PTO	(82)
1727							
1727 L 652.448	12.88 - 08.94	OM401.978, OM401.973		3400 124 101  3482 081 232  1878 005 668  3151 000 549	430 10 MFZ430 430WGTZ KZISZ-5	652.446-448	
				1878 003 269	420 10 420GTZ	652.446-448 für Nebenantrieb / for PTO	(82)
				3151 166 031	KZI-6	652.446-448 für Nebenantrieb / for PTO	(82)















MERCEDES-BENZ

1729							
1729 652.045 652.043 652.046	12.87 - 09.96	OM442		1888 063 137	380 GF2/380N	652.043/045-046 Nebenantriebs-ID / PTO ID: 4/125 enthält eine Kupplungsscheibe / This part number includes one clutch disc	(50) (67)
				1862 304 033 ▽	380 10 380GV	652.043/045-046 Nebenantriebs-ID / PTO ID: 4/125 Lose Kupplungsscheibe / Loose clutch disc	(50) (41)
				3151 166 031	KZI-6	652.043/045-046 Nebenantriebs-ID / PTO ID: 4/125	(50)
				1882 019 133	380 GF2/380N	652.043/045-046 Nebenantriebs-ID / PTO ID: 4/125 In 1888 enthalten / Contained in 1888	(50) (31)
				1859 250 101	380 GF2/380	652.043/045-046 Nebenantriebs-ID / PTO ID: 4/125 In 1888 enthalten / Contained in 1888	(50) (31)
				1862 305 033 △	380 10 380GVZ	652.043/045-046 Nebenantriebs-ID / PTO ID: 4/125 In 1888 enthalten / Contained in 1888	(50) (31)
				1878 003 269	420 10 420GTZ	652.043/045-047 Nebenantriebs-ID / PTO ID: 4/120	(50)
				3151 166 031	KZI-6	652.043/045-047 Nebenantriebs-ID / PTO ID: 4/120	(50)
1729 652.346 652.446-448 652.541 652.045-047 652.142 652.542 652.043 652.141 1729 LS 652.542	12.87 - 09.96	OM442		1888 063 137	380 GF2/380N	652.346/446-448/541-542/043/045-047/141-142 Nebenantriebs-ID / PTO ID: 4/125 enthält eine Kupplungsscheibe / This part number includes one clutch disc	(50) (67)
				1862 304 033 ▽	380 10 380GV	652.346/446-448/541-542/043/045-047/141-142 Nebenantriebs-ID / PTO ID: 4/125 Lose Kupplungsscheibe / Loose clutch disc	(50) (41)
				3151 166 031	KZI-6	652.346/446-448/541-542/043/045-047/141-142 Nebenantriebs-ID / PTO ID: 4/125	(50)
				1882 019 133	380 GF2/380N	652.346/446-448/541-542/043/045-047/141-142 Nebenantriebs-ID / PTO ID: 4/125 In 1888 enthalten / Contained in 1888	(50) (31)
				1859 250 101	380 GF2/380	652.346/446-448/541-542/043/045-047/141-142 In 1888 enthalten / Contained in 1888	(31)
				1862 305 033 △	380 10 380GVZ	652.346/446-448/541-542/043/045-047/141-142 In 1888 enthalten / Contained in 1888	(31)
1728, 1729, 1729 L 655.016 655.416 655.418 655.015 655.476 1729 K 655.116/117	07.87 - 09.96	OM442		3400 124 101	430 10 MFZ430	Sonderausführung / Special design	(60)
	07.88 - 08.94			<ul style="list-style-type: none"> ● 3482 081 232 ● 1878 005 668 ● 3151 000 549 	<ul style="list-style-type: none"> 430WGTZ KZISZ-5 		
			3400 122 501	430 10 MFZ430	430WGTZ		
			<ul style="list-style-type: none"> ● 3482 081 232 ● 1878 634 027 ● 3151 000 278 	KZISZ-5			
1729 AK 655.316/317	07.88 - 09.93	OM442		3400 124 101	430 10 MFZ430		
			<ul style="list-style-type: none"> ● 3482 081 232 ● 1878 005 668 ● 3151 000 549 	<ul style="list-style-type: none"> 430WGTZ KZISZ-5 			
1729 S, 1729 LS 655.111/112 655.513 655.113 655.511/512	07.87 - 09.96	OM442		3400 124 101	430 10 MFZ430	Sonderausführung / Special design	(60)
				<ul style="list-style-type: none"> ● 3482 081 232 ● 1878 005 668 ● 3151 000 549 	<ul style="list-style-type: none"> 430WGTZ KZISZ-5 		
				3400 122 501	430 10 MFZ430		
			1878 003 269	420 10 420GTZ	655.511-512-513 Nebenantriebs-ID / PTO ID: 4/125		
OM442.925, OM442.906, OM442.923, OM442.907				3151 166 031	KZI-6	655.511-512-513 Nebenantriebs-ID / PTO ID: 4/125	(50)
				3189 600 059			

		CODE				
--	--	------	--	---	---	---















MERCEDES-BENZ























1733						
1733,1733 L, 1734 L 652.068 652.065 652.067 652.066 652.467 652.465 652.478 652.466 652.468 652.446/447	12.87 - 09.96	OM441		3400 124 001 ⊗ 3482 081 231 ⊗ 1878 634 027 ⊙ 3151 000 278	430 10 MFZ430 430WGTZ KZISZ-5	652.478/561-563/065-068/161-163/465-468
1733 S,1733 LS 652.561 652.563 652.162 652.161 652.562 652.163	12.87 - 09.96	OM441.986, OM441.962, OM441.989, OM445.920, OM441.981, OM441.983, OM445.939, OM441.960		3189 600 059		



1735							
1735,1735 L 655.027 655.426 655.026 655.476 655.076	07.87 - 09.96	OM442A		3400 122 601 ⊗ 3482 081 231 ⊗ 1878 080 037 ⊙ 3151 000 278	430 10 MFZ430 430WGTZ KZISZ-5		
				1888 063 137	380 GF2/380N	655.026-027/426 656.116/215 Nebenantriebs-ID / PTO ID: 4/125 enthält eine Kupplungsscheibe / This part number includes one clutch disc	(50) (67)
				1862 304 033 ▽	380 10 380GV	655.026-027/426 656.116/215 Nebenantriebs-ID / PTO ID: 4/125 Lose Kupplungsscheibe / Loose clutch disc	(50) (41)
				3151 166 031	KZI-6	655.026-027/426 656.116/215 Nebenantriebs-ID / PTO ID: 4/125	(50)
				1882 019 133	380 GF2/380N	655.026-027/426 656.116/215 In 1888 enthalten / Contained in 1888	(31)
				1859 250 101	380 GF2/380	655.026-027/426 656.116/215 In 1888 enthalten / Contained in 1888	(31)
				1862 305 033 △	380 10 380GVZ	655.026-027/426 656.116/215 In 1888 enthalten / Contained in 1888	(31)
				3189 600 059			
1735 ,AF 656.215 656.116		OM442		3400 124 101 ⊗ 3482 081 232 ⊗ 1878 005 668 ⊙ 3151 000 549	430 10 MFZ430 430WGTZ KZISZ-5		
				1888 063 137	380 GF2/380N	Nebenantriebs-ID / PTO ID: 4/125 enthält eine Kupplungsscheibe / This part number includes one clutch disc	(50) (67)
				1862 304 033 ▽	380 10 380GV	Nebenantriebs-ID / PTO ID: 4/125 Lose Kupplungsscheibe / Loose clutch disc	(50) (41)
				3151 166 031	KZI-6	Nebenantriebs-ID / PTO ID: 4/125	(50)
				1882 019 133	380 GF2/380N	In 1888 enthalten / Contained in 1888	(31)
				1859 250 101	380 GF2/380	In 1888 enthalten / Contained in 1888	(31)
	1862 305 033 △	380 10 380GVZ	In 1888 enthalten / Contained in 1888	(31)			

		CODE				
--	--	------	--	---	---	---







MERCEDES-BENZ

1735							
1735 AK 655.327 1735 K 655.127 1735 L 655.476 1735 S,1735 LS 655.122 655.523 655.522 655.572 655.172 655.123 655.573 655.173	08.89 - 08.94	OM442A		3400 122 601  3482 081 231  1878 080 037  3151 000 278	430 10 MFZ430 430WGTZ KZISZ-5		
	07.88 - 08.94						
	07.88 - 08.94	OM442LA		3400 121 601  3488 017 432  1878 634 022  3151 000 547	400 10 MFZ2/400X 400GVZ KZISZ-5	Sonderausführung / Special design (60)	
	07.87 - 09.96						
		OM442.964, OM442.966, OM442.976, OM442.906, OM442.963, OM442.944, OM440.940, OM442.942			1888 063 137	380 GF2/380N	Nebenantriebs-ID / PTO ID: 4/125 enthält eine Kupplungsscheibe / This part number includes one clutch disc (50) (67)
					1862 304 033 ▽	380 10 380GV	Nebenantriebs-ID / PTO ID: 4/125 Lose Kupplungsscheibe / Loose clutch disc (50) (41)
					3151 166 031	KZI-6	Nebenantriebs-ID / PTO ID: 4/125 (50)
					1882 019 133	380 GF2/380N	In 1888 enthalten / Contained in 1888 (31)
					1859 250 101	380 GF2/380	In 1888 enthalten / Contained in 1888 (31)
					1862 305 033 △	380 10 380GVZ	In 1888 enthalten / Contained in 1888 (31)
				3189 600 059			







1748						
1748,1748 L 655.096 655.496 655.494	07.87 - 09.96	OM442LA		3400 121 601  3488 017 432  1878 634 022  3151 000 547	400 10 MFZ2/400X 400GVZ KZISZ-5	->Chass. K 011863 655.096/494
				3400 121 601  3488 017 432  1878 634 022  3151 000 547	400 10 MFZ2/400X 400GVZ KZISZ-5	655.496
				3482 081 233	430 MFZ430	Chass. K 011864-> 655.096/494
				1878 002 735	430 10 430GTZ	Chass. K 011864-> 655.096/494
				3151 000 278	KZISZ-5	Chass. K 011864-> 655.096/494
				3189 600 059		
1748 S,1748 LS 655.193 655.192 655.592/593	07.87 - 09.96	OM442LA		3400 121 601  3488 017 432  1878 634 022  3151 000 547	400 10 MFZ2/400X 400GVZ KZISZ-5	->Chass. K 011863 655.494/496/592-593/096/192-193
				1888 063 137	380 GF2/380N	655.192 für Nebenantrieb / for PTO enthält eine Kupplungsscheibe / This part number includes one clutch disc (82) (67)
				1862 304 033 ▽	380 10 380GV	655.192 für Nebenantrieb / for PTO Lose Kupplungsscheibe / Loose clutch disc (82) (41)
				3151 166 031	KZI-6	655.192 für Nebenantrieb / for PTO (82)
				1882 019 133	380 GF2/380N	655.192 In 1888 enthalten / Contained in 1888 (31)
				1859 250 101	380 GF2/380	655.192 In 1888 enthalten / Contained in 1888 (31)
				1862 305 033 △	380 10 380GVZ	655.192 In 1888 enthalten / Contained in 1888 (31)

1813						
1813 6x2		OM352		1882 201 132	295 GF295	
				1861 279 133	295 10 295GTZ	
				3151 095 043	KZI-3	







MERCEDES-BENZ

1813						
L 1813 352.408 352.401-403 352.407		OM352		1882 252 331	310 GFX310	->Chass. 922885
				1882 305 131	310 GFX310	Chass. 922886->
				1861 303 248	310 10 310GSB	
				3151 095 043	KZI-3	
L 1813		OM352A		1882 252 333	310 GFX310	
				1861 303 248	310 10 310GSB	

1814						
1814 616.006	04.84 - 03.91	OM366		3400 122 401 ⊗ 3482 008 038 ⊗ 1861 964 034 ⊗ 3151 044 031	310 10 MF310 310WGSZ KZI-3	616.004/006-007-008

1817						
L 1817 360.401-403		OM360		1882 234 433	350 GF350	
				1878 001 074	350 10 350GTZ	
				3151 094 041	KZI-4	
LP 1817	06.69 -	OM324		1882 234 433	350 GF350	
				1878 001 074	350 10 350GTZ	
				3151 044 031	KZI-3	
LP 1817	- 05.69	OM324		1878 001 074	350 10 350GTZ	





1819						
1819 6x4 L 327				1882 234 433	350 GF350	
				1878 001 074	350 10 350GTZ	
L 1819 360.401-403		OM360		1882 234 433	350 GF350	
				1878 001 074	350 10 350GTZ	
				3151 094 041	KZI-4	

1820						
1820,1820 L 652.028 652.025 652.420 652.428/429 652.027 652.023/024 652.020 652.029	12.87 - 09.96	OM357.925, OM356.984, OM356.987		3400 125 001 ⊗ 3482 000 953 ⊗ 1878 001 070 ⊗ 3151 000 374	350 10 GMF350X 350GTZ KZIS-4	652.428-429/020-029/316
		OM356		1882 166 737	380 GF380	652.013-015/023-025/110-119/310-319
				1878 001 152	380 10 380WGTZ	652.013-015/023-025/110-119/310-319
				3151 000 374	KZIS-4	652.013-015/023-025/110-119/310-319
1820 AK 652.316 652.326	07.93 - 09.96	OM357.925, OM356.987		3400 700 417 ⊗ 3482 000 953 ⊗ 1878 001 144 ⊗ 3151 000 374	350 10 GMF350X 350WGTZ KZIS-4	652.316
				3400 125 001 ⊗ 3482 000 953 ⊗ 1878 001 070 ⊗ 3151 000 374	350 10 GMF350X 350GTZ KZIS-4	652.126-127/326
1820 K 652.127 652.126	05.92 - 09.96	OM357.925, OM356.987		3400 125 001 ⊗ 3482 000 953 ⊗ 1878 001 070 ⊗ 3151 000 374	350 10 GMF350X 350GTZ KZIS-4	652.126-127/326



























		CODE					
--	--	------	--	--	---	---	---

MERCEDES-BENZ

1824









1824 652.036 652.038 652.033 1824 652.033 1824 AK 652.336	08.92 - 09.96 12.88 - 08.94 08.92 - 09.96	OM356.999, OM401.975, OM442.907	 	3400 123 001 ⊗ 3482 081 232 ⊗ 1878 080 031 ⊙ 3151 000 549 3189 600 059	430 10 MFZ430 430WGTZ KZISZ-5		
1824 652.004 652.003 652.005-009 1824, 1824 L 652.009 652.407 652.405 652.004 652.006 652.409 652.003 652.008 652.005 652.007 652.406 652.408 1824 AK 652.302 652.336 652.303 1824 AK 652.302/303 1824 K 652.106/107 1824 K 652.106/107	01.94 - 09.96 12.87 - 09.96 08.92 - 09.96 01.94 - 09.96 08.92 - 09.96 01.94 - 09.96	OM401LA, 441LA OM445.930, OM445.938, OM401.975, OM445.941, OM445.924, OM445.925, OM401.984, OM401.990	 	3400 700 411 ⊗ 3482 081 232 ⊗ 1878 080 033 ⊙ 3151 000 278 3189 600 059	430 10 MFZ430 430WGTZ KZISZ-5	652.302-303/405-409/003-009/106-107	



1827



1827, 1827 L 652.059 652.456/457 652.455 652.458 652.054 652.056 652.459 652.053 652.055 652.057/058 1827, 1827 L 652.059 652.459 652.456 652.055 652.455 652.457 652.054 652.057 652.053 652.056 652.058 652.458	12.87 - 09.96 12.87 - 09.96	OM401.977, OM445.936, OM401.991, OM445.926, OM401.973 OM401LA, 441LA	              	1888 063 137 1862 304 033 ▽ 3151 166 031 1882 019 133 1859 250 101 1862 305 033 △ 3189 600 059 3400 700 411 ⊗ 3482 081 232 ⊗ 1878 080 033 ⊙ 3151 000 278	380 GF2/380N 380 10 380GV 380 KZI-6 380 GF2/380N 380 GF2/380 380 10 380GVZ 430 10 MFZ430 430WGTZ KZISZ-5	652.053-059/151-153 für Nebenantrieb / for PTO enthält eine Kupplungsscheibe / This part number includes one clutch disc 652.053-059/151-153 für Nebenantrieb / for PTO Lose Kupplungsscheibe / Loose clutch disc 652.053-059/151-153 für Nebenantrieb / for PTO 652.053-059/151-153 In 1888 enthalten / Contained in 1888 652.053-059/151-153 In 1888 enthalten / Contained in 1888 652.053-059/151-153 In 1888 enthalten / Contained in 1888 652.053-059/151-153 für Nebenantrieb / for PTO enthält eine Kupplungsscheibe / This part number includes one clutch disc 652.053-059/151-153 für Nebenantrieb / for PTO Lose Kupplungsscheibe / Loose clutch disc 652.053-059/151-153 für Nebenantrieb / for PTO 652.053-059/151-153 In 1888 enthalten / Contained in 1888 652.053-059/151-153 In 1888 enthalten / Contained in 1888 652.053-059/151-153 In 1888 enthalten / Contained in 1888 652.053-059/151-153 für Nebenantrieb / for PTO enthält eine Kupplungsscheibe / This part number includes one clutch disc 652.053-059/151-153 für Nebenantrieb / for PTO Lose Kupplungsscheibe / Loose clutch disc 652.053-059/151-153 für Nebenantrieb / for PTO 652.053-059/151-153 In 1888 enthalten / Contained in 1888 652.053-059/151-153 In 1888 enthalten / Contained in 1888 652.053-059/151-153 In 1888 enthalten / Contained in 1888 652.053-059/151-153 für Nebenantrieb / for PTO enthält eine Kupplungsscheibe / This part number includes one clutch disc	(82) (67) (82) (41) (82) (31) (31) (31) (31) (71) (82) (67) (82) (41) (82) (31) (31) (31) (71) (82) (67) (82) (41) (82) (31) (31) (31) (71) (82) (67)
1827 AK 652.303 652.302 1827 AK 652.302/303 1827 K 652.107 652.106	08.92 - 09.96 08.92 - 09.96 01.94 - 09.96	OM401.989, OM445.926, OM401.973, OM445.933	  	3400 700 411 ⊗ 3482 081 232 ⊗ 1878 080 033 ⊙ 3151 000 278 3189 600 059	430 10 MFZ430 430WGTZ KZISZ-5		
1827 S, 1827 LS 652.153 652.551 652.151/152 652.552/553 1827 S, 1827 LS 652.151-153 652.551 652.553 652.552	12.87 - 09.96 12.87 - 09.96	OM401.977, OM445.936, OM445.926, OM401.991, OM401.973	        	3482 081 232 1878 080 033 3151 000 549 1888 063 137 1862 304 033 ▽ 3151 166 031 1882 019 133 1859 250 101 1862 305 033 △ 3189 600 059 3400 700 411	430 MFZ430 430 10 430WGTZ 380 KZISZ-5 380 GF2/380N 380 10 380GV 380 KZI-6 380 GF2/380N 380 GF2/380 380 10 380GVZ 430 10 MFZ430 430WGTZ KZISZ-5	652.151-153 652.151-153 652.151-153 für Ausrückgabel mit Rollen / for release fork with rollers 652.053-059/151-153 für Nebenantrieb / for PTO enthält eine Kupplungsscheibe / This part number includes one clutch disc 652.053-059/151-153 für Nebenantrieb / for PTO Lose Kupplungsscheibe / Loose clutch disc 652.053-059/151-153 für Nebenantrieb / for PTO 652.053-059/151-153 In 1888 enthalten / Contained in 1888 652.053-059/151-153 In 1888 enthalten / Contained in 1888 652.053-059/151-153 In 1888 enthalten / Contained in 1888 652.053-059/151-153 In 1888 enthalten / Contained in 1888 652.053-059/151-153 für Nebenantrieb / for PTO enthält eine Kupplungsscheibe / This part number includes one clutch disc 652.053-059/151-153 für Nebenantrieb / for PTO Lose Kupplungsscheibe / Loose clutch disc 652.053-059/151-153 für Nebenantrieb / for PTO 652.053-059/151-153 In 1888 enthalten / Contained in 1888 652.053-059/151-153 In 1888 enthalten / Contained in 1888 652.053-059/151-153 In 1888 enthalten / Contained in 1888 652.053-059/151-153 für Nebenantrieb / for PTO enthält eine Kupplungsscheibe / This part number includes one clutch disc	(71) (82) (67) (82) (41) (82) (31) (31) (31) (31) (71) (82) (67) (82) (41) (82) (31) (31) (31) (71) (82) (67)

		CODE				
--	--	------	--	---	---	---

MERCEDES-BENZ

1831						
1831,1831 L 655.006 655.008 655.101 655.408 655.007 655.406 655.409 655.405 655.103 655.009 655.102 655.005 655.407	07.87 - 09.96	OM401LA, 441LA		3400 124 001 ⊗ 3482 081 231 ⊗ 1878 634 027 ⊙ 3151 000 278	430 10 MFZ430 430WGTZ KZISZ-5	
1831,1831 L 655.006 655.009 655.103 655.407 655.007 655.405 655.408 655.101/102 655.005 655.406 655.409 655.008	07.87 - 09.96	OM442A		3400 122 601 ⊗ 3482 081 231 ⊗ 1878 080 037 ⊙ 3151 000 278	430 10 MFZ430 430WGTZ KZISZ-5	
1831,1831 L 652.096/097 652.191 652.495 652.095 652.193 652.496 652.098 652.192 652.498 652.497	12.87 - 09.96	OM401.979, OM401.986, OM441.986, OM441.993, OM445.930, OM445.937, OM445.929, OM401.972, OM401.993		1888 063 137	380 GF2/380N	für Nebenantrieb / for PTO enthält eine Kupplungsscheibe / This part number includes one clutch disc (82) (67)
1831,1831 L 652.097/098 652.495 652.095 652.193 652.096 652.192 652.497 652.496 652.191 652.498	12.87 - 09.96			1862 304 033 ▽	380 10 380GV	für Nebenantrieb / for PTO Lose Kupplungsscheibe / Loose clutch disc (82) (41)
1831 AK 655.307	05.91 - 09.96			3151 166 031	KZI-6	für Nebenantrieb / for PTO (82)
1831 AK 655.307	01.94 - 09.96			1882 019 133	380 GF2/380N	In 1888 enthalten / Contained in 1888 (31)
1831 K 655.107	07.92 - 09.96			1859 250 101	380 GF2/380	In 1888 enthalten / Contained in 1888 (31)
1831 K 655.107	07.92 - 09.96			1862 305 033 △	380 10 380GVZ	In 1888 enthalten / Contained in 1888 (31)
1831 S,1831 LS 655.102/103 655.508 655.501-503	07.87 - 09.96			3189 600 059		
1831 S,1831 LS 655.501 655.508 655.502/503 655.102/103	07.87 - 09.96					
1831 S,1831 LS 652.193 652.192 652.191 652.592 652.591 652.593	12.87 - 09.96					
1831 S,1831 LS 652.192 652.591 652.193 652.593 652.592 652.191	12.87 - 09.96					



















1834						
1834 AK 655.317	07.88 - 09.93	OM401LA, 441LA		3400 124 001 ⊗ 3482 081 231 ⊗ 1878 634 027 ⊙ 3151 000 278	430 10 MFZ430 430WGTZ KZISZ-5	652.420-423/541-543/548/065-068/161-163/562 /563
1834,1834 L 655.021 655.421 655.020 655.023 655.422/423 655.022 655.420	07.87 - 09.96					655.020-023/107/141-143/307
1834,1834 L 652.065-068 652.466 652.468 652.467 652.478 652.465	12.87 - 09.96	OM445.921, OM441.986, OM441.989, OM445.920, OM441.987, OM445.939, OM441.991, OM441.996		3189 600 059		
1834 S,1834 LS 655.141 655.143 655.142 655.542/543 655.548 655.541	07.87 - 09.96					
1834 S,1834 LS 652.163 652.161 652.563 652.561/562 652.162	12.87 - 09.96					

1838						
1838 655.138 655.133 655.132 655.533 655.538 655.582/583 655.337 655.532 655.588 655.183 655.086 655.434 655.486/487 655.035-038 655.436 655.484 655.087 655.182 655.437		OM402LA, 442LA		3400 122 901 ⊗ 3482 081 233 ⊗ 1878 002 735 ⊙ 3151 000 278	430 10 MFZ430 430GTZ KZISZ-5	für / for: SA033617-01 (69) 655.182-183/337/434/436-437/484/486-487/532 /533/538/582-583/588/035-038/086-087/132-133 /138
				3189 600 059		



















		CODE				
--	--	------	--	---	---	---

MERCEDES-BENZ

1838

1838,1838 L 655.086 655.485 655.487 655.036 655.183 655.436 655.434 655.486 655.035 655.037 655.182 655.132 655.435 655.484 655.087 655.138	07.87 - 09.96	OM402LA, 442LA		3400 122 601  3482 081 231  1878 080 037  3151 000 278	430 10 MFZ430 430WGTZ KZISZ-5		
	1838,1838 L 655.038 655.138 655.183 655.486 655.036/037 655.436/437 655.434 655.132 655.487 655.035 655.182	07.87 - 09.96			3400 122 901  3482 081 233  1878 002 735  3151 000 278	430 10 MFZ430 430GTZ KZISZ-5	für / for: SA033617-01
1838,1838 L 655.038 655.037 655.436 655.035/036 655.437 655.434	07.87 - 09.96	OM402, OM442LA		3488 017 432	400 MFZ2/400X	für OE-Nummer / for OE number 005 250 88 04 für OE-Nummer / for OE number 005 250 76 04 für OE-Nummer / for OE number 005 250 77 04 enthält eine Kupplungsscheibe / This part number includes one clutch disc Sonderausführung / Special design	(83) (83) (83) (67)
1838 AK 655.337	12.92 - 09.96						(60)
1838 AK 655.337	01.94 - 09.96			1878 005 805	400 10 400GTZ	für OE-Nummer / for OE number 014 250 70 03 für OE-Nummer / for OE number 014 250 08 03 Sonderausführung / Special design	(83) (83) (60)
1838 AK 655.337	12.92 - 09.96			1878 634 022 #	400 10 400GVZ	für OE-Nummer / for OE number 014 250 70 03 für OE-Nummer / for OE number 014 250 08 03 Sonderausführung / Special design	(83) (83) (60)
1838 AK 655.337	12.92 - 09.96						
1838 K 655.138	12.90 - 09.96			3151 000 278	KZISZ-5	für OE-Nummer / for OE number 001 250 65 15 für OE-Nummer / for OE number 001 250 64 15 für OE-Nummer / for OE number 001 250 98 15 für OE-Nummer / for OE number 001 250 86 15 für OE-Nummer / for OE number 001 250 79 15 Sonderausführung / Special design	(83) (83) (83) (83) (83) (60)
1838 K 655.138	06.95 - 09.96						
1838 S,1838 LS 655.588 655.182/183 655.533 655.582/583 655.132/133 655.532	07.87 - 09.96	OM402.971, OM402.975, OM440.978, OM446.943, OM446.927,		1888 063 137	380 GF2/380N	für Nebenantrieb / for PTO enthält eine Kupplungsscheibe / This part number includes one clutch disc	(82) (67)
1838 S,1838 LS 655.533 655.583 655.532 655.582 655.588 655.133 655.132 655.538	07.87 - 09.96	OM446.925, OM440.991, OM440.979, OM402.996, OM402.986, OM440.982, OM402.978, OM446.924, OM402.972		1862 304 033 ▽	380 10 380GV	für Nebenantrieb / for PTO Lose Kupplungsscheibe / Loose clutch disc	(82) (41)
1838 S,1838 LS 655.533 655.588 655.532 655.133 655.538 655.132	07.87 - 09.96			3151 166 031	KZI-6	für Nebenantrieb / for PTO	(82)
				1882 019 133	380 GF2/380N	In 1888 enthalten / Contained in 1888	(31)
				1859 250 101	380 GF2/380	In 1888 enthalten / Contained in 1888	(31)
				1862 305 033 △	380 10 380GVZ	In 1888 enthalten / Contained in 1888	(31)
				3483 023 032 ⊕	445 GMFZ445W	für Fahrzeuge mit Wandlerschaltkupplung / for vehicles with converter and clutch unit	(76)
				1878 003 780	445 24 445GTZ	für Fahrzeuge mit Wandlerschaltkupplung / for vehicles with converter and clutch unit	(76)
				3189 600 059			





























1840

1840 LS 655.533	07.91 - 07.92	OM402.971		3400 122 601  3482 081 231  1878 080 037  3151 000 278	430 10 MFZ430 430WGTZ KZISZ-5	für Fahrzeuge mit Einscheibenkupplung / for vehicles with single disc clutch	(72)
				3400 121 601  3488 017 432  1878 634 022  3151 000 547	400 10 MFZ2/400X 400GVZ KZISZ-5	für Fahrzeuge mit Zweisheibenkupplung / for vehicles with double disc clutch	(77)
				3400 122 901  3482 081 233  1878 002 735  3151 000 278	430 10 MFZ430 430GTZ KZISZ-5	für / for: SA33613 02	(69)
				1888 063 137	380 GF2/380N	für Nebenantrieb / for PTO enthält eine Kupplungsscheibe / This part number includes one clutch disc	(82) (67)
				1862 304 033 ▽	380 10 380GV	für Nebenantrieb / for PTO Lose Kupplungsscheibe / Loose clutch disc	(82) (41)
				3151 166 031	KZI-6	für Nebenantrieb / for PTO	(82)
				1882 019 133	380 GF2/380N	In 1888 enthalten / Contained in 1888	(31)
				1859 250 101	380 GF2/380	In 1888 enthalten / Contained in 1888	(31)
				1862 305 033 △	380 10 380GVZ	In 1888 enthalten / Contained in 1888	(31)















		CODE				
--	--	------	--	---	---	---

MERCEDES-BENZ











1844















1844 655.434 655.337 655.138 655.437 655.533 655.436 655.035-037		OM402LA, 442LA	 3400 122 601  3482 081 231  1878 080 037  3151 000 278	430 10 MFZ430 430WGTZ KZISZ-5			
			 3400 122 901  3482 081 233  1878 002 735  3151 000 278	430 10 MFZ430 430GTZ KZISZ-5	für / for: SA033617-01	(69)	
		 1888 063 137	380 GF2/380N	Nebenantriebs-ID / PTO ID: 4/125 enthält eine Kupplungsscheibe / This part number includes one clutch disc	(50) (67)		
		 1862 304 033 ▽	380 10 380GV	Nebenantriebs-ID / PTO ID: 4/125 Lose Kupplungsscheibe / Loose clutch disc	(50) (41)		
		 3151 166 031	KZI-6	Nebenantriebs-ID / PTO ID: 4/125	(50)		
		 1882 019 133	380 GF2/380N	In 1888 enthalten / Contained in 1888	(31)		
		 1859 250 101	380 GF2/380	In 1888 enthalten / Contained in 1888	(31)		
		 1862 305 033 △	380 10 380GVZ	In 1888 enthalten / Contained in 1888	(31)		
		 3483 023 032 ⊕	445 GMFZ445W	655.337 für Fahrzeuge mit Wandlerschaltkupplung / for vehicles with converter and clutch unit	(76)		
		 1878 003 780	445 24 445GTZ	655.337 für Fahrzeuge mit Wandlerschaltkupplung / for vehicles with converter and clutch unit	(76)		
 3189 600 059							
1844, 1844 L 655.037 655.093 655.434 655.490 655.492 655.436 655.138 655.191 655.337 655.437 655.190 655.035/036 1844 S, 1844 LS 655.590/591 655.191 655.190 655.533	07.87 - 09.96	OM442LA	 3400 121 601  3488 017 432  1878 634 022  3151 000 547	400 10 MFZ2/400X 400GVZ KZISZ-5	->Chass. K011863 655.590-591/593/093/190-191/490/492		
	07.87 - 09.96		 3400 122 901  3482 081 233  1878 002 735  3151 000 278	430 10 MFZ430 430GTZ KZISZ-5	Chass. K011864-> 655.590-591/593/093/190-191/490/492		
			OM440.970, OM440.978, OM446.922	 3483 023 032 ⊕	445 GMFZ445W	655.337 für Fahrzeuge mit Wandlerschaltkupplung / for vehicles with converter and clutch unit	(76)
				 1878 003 780	445 24 445GTZ	655.337 für Fahrzeuge mit Wandlerschaltkupplung / for vehicles with converter and clutch unit	(76)
			 3189 600 059				

1850

1850, 1850 L 655.337 655.494 655.496 655.096 1850 LAS 655.592 1850 S, 1850 LS 655.192 655.133 655.193 655.593 655.592	07.87 - 09.96	OM442LA	 3400 121 601  3488 017 432  1878 634 022  3151 000 547	400 10 MFZ2/400X 400GVZ KZISZ-5	->Chass. K011863 655.494/496/592-593/096/192-193	
	07.87 - 09.96		 3400 122 901  3482 081 233  1878 002 735  3151 000 278	430 10 MFZ430 430GTZ KZISZ-5	Chass. K011864-> 655.494/496/592-593/096/192-193	
	07.87 - 09.96		 3400 121 601  3488 017 432  1878 634 022  3151 000 547	400 10 MFZ2/400X 400GVZ KZISZ-5	für / for: SA33613-03	(69)
			OM440.973, OM442.985, OM442.997, OM442.992, OM442.989	 3483 023 032 ⊕	445 GMFZ445W	für Fahrzeuge mit Wandlerschaltkupplung / for vehicles with converter and clutch unit
			 1878 003 780	445 24 445GTZ	für Fahrzeuge mit Wandlerschaltkupplung / for vehicles with converter and clutch unit	(76)
			 3189 600 059			

MERCEDES-BENZ























1850							
1850 K 655.127 1850 655.127 655.133 655.337 655.138	07.88 - 08.94	OM442LA	 3400 122 601 Ⓢ 3482 081 231 Ⓢ 1878 080 037 Ⓢ 3151 000 278	430 10 MFZ430 430WGTZ KZISZ-5			
			 3400 122 901 Ⓢ 3482 081 233 Ⓢ 1878 002 735 Ⓢ 3151 000 278	430 10 MFZ430 430GTZ KZISZ-5	für / for: SA033617-01	(69)	
			OM442.997	 1888 063 137	380 GF2/380N	Nebenantriebs-ID / PTO ID: 4/125 enthält eine Kupplungsscheibe / This part number includes one clutch disc	(50) (67)
		 1862 304 033 ▽		380 10 380GV	Nebenantriebs-ID / PTO ID: 4/125 Lose Kupplungsscheibe / Loose clutch disc	(50) (41)	
		 3151 166 031		KZI-6	Nebenantriebs-ID / PTO ID: 4/125	(50)	
		 1882 019 133		380 GF2/380N	In 1888 enthalten / Contained in 1888	(31)	
		 1859 250 101		380 GF2/380	In 1888 enthalten / Contained in 1888	(31)	
		 1862 305 033 △		380 10 380GVZ	In 1888 enthalten / Contained in 1888	(31)	
		 3483 023 032 ⊕		445 GMFZ445W	655.337 für Fahrzeuge mit Wandlerschaltkupplung / for vehicles with converter and clutch unit	(76)	
		 1878 003 780		445 24 445GTZ	655.337 für Fahrzeuge mit Wandlerschaltkupplung / for vehicles with converter and clutch unit	(76)	
 3189 600 059							



1853							
1853,1853 L 655.494 655.496 655.096 1853 S,1853 LS 655.192 655.593 655.193 655.592	07.87 - 09.96	OM442LA	 3400 121 601 Ⓢ 3488 017 432 Ⓢ 1878 634 022 Ⓢ 3151 000 547	400 10 MFZ2/400X 400GVZ KZISZ-5	->Chass. K011863 655.593		
	07.87 - 09.96		 3400 122 901 Ⓢ 3482 081 233 Ⓢ 1878 002 735 Ⓢ 3151 000 278	430 10 MFZ430 430GTZ KZISZ-5	Chass. K118864-> 655.593		
		OM446.920	 3189 600 059				
1853 AK 655.337	01.96 - 09.96	OM442LA	 3400 122 601 Ⓢ 3482 081 231 Ⓢ 1878 080 037 Ⓢ 3151 000 278	430 10 MFZ430 430WGTZ KZISZ-5			
			 3400 122 901 Ⓢ 3482 081 233 Ⓢ 1878 002 735 Ⓢ 3151 000 278	430 10 MFZ430 430GTZ KZISZ-5	für / for: SA033617-01	(69)	
			OM402, OM442LA	 3400 121 601 Ⓢ 3488 017 432 Ⓢ 1878 634 022 Ⓢ 3151 000 547	400 10 MFZ2/400X 400GVZ KZISZ-5	für / for: SA25801-03	(69)
		 1888 063 137		380 GF2/380N	für Nebenantrieb / for PTO enthält eine Kupplungsscheibe / This part number includes one clutch disc	(82) (67)	
		 1862 304 033 ▽		380 10 380GV	für Nebenantrieb / for PTO Lose Kupplungsscheibe / Loose clutch disc	(82) (41)	
		 3151 166 031		KZI-6	für Nebenantrieb / for PTO	(82)	
		 1882 019 133		380 GF2/380N	In 1888 enthalten / Contained in 1888	(31)	
		 1859 250 101		380 GF2/380	In 1888 enthalten / Contained in 1888	(31)	
		 1862 305 033 △		380 10 380GVZ	In 1888 enthalten / Contained in 1888	(31)	
		 3483 023 032 ⊕		445 GMFZ445W	655.337 für Fahrzeuge mit Wandlerschaltkupplung / for vehicles with converter and clutch unit	(76)	
 1878 003 780	445 24 445GTZ	655.337 für Fahrzeuge mit Wandlerschaltkupplung / for vehicles with converter and clutch unit	(76)				
 3189 600 059							





		CODE				
--	--	------	--	---	---	---

MERCEDES-BENZ

1918						
L 1918 349				1882 110 542 ▲	350 GF350	
LK 1918 349				1861 034 147 #	350 10	
LS 1918		OM346		1882 166 737	380 GF380	
				1863 010 100	GR-4	mit Anlauftring / with thrust ring

1919								
1919 389.006 389.008/009 389.007	05.74 - 08.82	OM401		1882 302 131	380 GF380	389.006-007-008-009		
				1878 000 105	380 10 380GTZ	389.006-007-008-009 Sonderausführung / Special design	(60)	
				1882 302 132 #	380 GF380	389.006-007-008-009		
				1878 000 105	380 10 380GTZ	389.006-007-008-009		
			3151 000 375	KZIS-4	389.006-007-008-009			
			OM401.909, OM401.916		1878 000 964	380 10 380GTZ	389.006-007/034 für Nebenantrieb / for PTO	(82)
			3189 600 060					
1919 AK 389.134	05.74 - 08.82	OM401		1882 302 131	380 GF380			
				1882 302 132 #	380 GF380			
				1878 000 105	380 10 380GTZ			
				3151 000 375	KZIS-4			
			OM401.909		3189 600 060			
1919 K 389.034	05.74 - 08.82	OM401		1882 302 131	380 GF380	389.034		
				1882 302 132 #	380 GF380	389.034		
				1878 000 105	380 10 380GTZ	389.034		
				3151 000 375	KZIS-4	389.034		
			OM401.909		1878 000 964	380 10 380GTZ	389.006-007/034 für Nebenantrieb / for PTO	(82)
			3189 600 060					
1919 S 389.003 389.002	05.74 - 08.82	OM401		1882 302 131	380 GF380	389.002-003		
				1882 302 132 #	380 GF380	389.002-003		
				1878 000 105	380 10 380GTZ	389.002-003		
				3151 000 375	KZIS-4	389.002-003		
			OM401.909, OM401.916		3189 600 060			



1920						
L,LA,LK,LP,LS,LPS 1920				1882 166 737	380 GF380	
				1878 000 104	380 10 380GTZ	

1921							
1921 349				1882 110 542 ▲	350 GF350		
				1861 034 147 #	350 10		
				1882 166 737	380 GF380		
				1878 000 104	380 10 380GTZ		
				3151 000 529	KZIS-4		





























		CODE				
--	--	------	--	---	---	---

MERCEDES-BENZ



1921

L 1921 349.313 349.311 349.314 LK 1921 349.313/314 349.311 LS 1921 349.313 349.311 349.314		OM355		1882 166 737	380 GF380		
				1878 000 104	380 10 380GTZ		
				3151 000 529	KZIS-4		

1922









1922 621.007 621.006 621.005 621.008	10.81 - 10.90	OM421		1882 302 131	380 GF380	->Chass. 234953 621.005-008	
				1878 000 105	380 10 380GTZ	->Chass. 234953 621.005-008	
				3151 000 375	KZIS-4	->Chass. 234953 621.005-008	
				3482 124 541	430 GMF430	Chass. 234954-> 621.005-008	
				1882 301 238 ●#	420 GF420	Chass. 234954-> 621.005-008	
				1878 002 706	420 10 420GTZ	Chass. 234954-> 621.005-008	
				3151 000 375	KZIS-4	Chass. 234954-> 621.005-008	
				3482 124 541	430 GMF430	621.007-008	
				1882 301 238 ●#	420 GF420	621.007-008	
				1878 001 136	420 10 420GTZ	621.007-008	
				3151 000 375	KZIS-4	621.007-008	
				1861 643 134 #	420 10 420GSZ	621.005/106-107 für Nebenantrieb / for PTO	(82)
				3151 079 031	KZI-6	621.005/106-107 für Nebenantrieb / for PTO	(82)
		OM421.905		3189 600 060			
1922 656.008/009 656.006 656.005 1922 AK 656.307 656.306 1922 K 656.106/107 1922 S 656.101/102	05.89 - 08.94	OM441		3400 123 001	430 10 MFZ430	656.106-107/306-307/005-006/008-009/101	
	08.89 - 08.94			3482 081 232	430WGTZ		
	05.89 - 08.94			1878 080 031	KZISZ-5		
	05.89 - 08.94			3151 000 549			
				1862 225 132 #	400 10 400GTZ	656.106-107/306-307/005-006/008-009/101	
1922 AK 621.307 621.306 1922 K 621.106/107 1922 S 621.102 621.101	10.81 - 03.91	OM421		1882 302 131	380 GF380	->Chass. 234953	
	10.81 - 03.91			1878 000 105	380 10 380GTZ	->Chass. 234953	
	10.81 - 03.91			3151 000 375	KZIS-4	->Chass. 234953	
				3482 124 541	430 GMF430	Chass. 234954->	
				1882 301 238 ●#	420 GF420	Chass. 234954->	
				1878 002 706	420 10 420GTZ	Chass. 234954->	
				3151 000 375	KZIS-4	Chass. 234954->	
				1861 643 134 #	420 10 420GSZ	für Nebenantrieb / for PTO	(82)
				3151 079 031	KZI-6	für Nebenantrieb / for PTO	(82)
				OM421.905		3189 600 060	

















1923

L 1923 LA 1923 LP 1923				1882 166 737	380 GF380		
				1878 000 104	380 10 380GTZ		



		CODE				
--	--	------	--	---	---	---

MERCEDES-BENZ

1924						
1924 336 336, 346				1882 166 737	380 GF380	354.052-053-054-055/062-064 354.052-053-054-055/062-064
				1878 000 104	380 10 380GTZ	354.002-006/012-013/015-016 354.002-006/012-013/015-016
				3151 000 529	KZIS-4	354.002-006/012-013/015-016 354.002-006/012-013/015-016
L,LA,LP,LS,LK 1924 346.351 346.111-114 346.361 346.311-314 346.324 346.323 346.355 346.362 346.365 346.352 LAK,LAS,LPS 1924 346.324 346.362 346.352 346.365 346.351 346.355 346.311-314 346.361 346.323 346.111-114 L,LK,LS 1924 346.001-004 346.013		OM355		1882 166 737	380 GF380	346.351-352/355/361-362/365/111-114/311-314 /323-324
				1878 000 104	380 10 380GTZ	346.351-352/355/361-362/365/111-114/311-314 /323-324
				3151 000 529	KZIS-4	346.351-352/355/361-362/365/111-114/311-314 /323-324
		OM355		1882 302 131	380 GF380	
				1878 000 105	380 10 380GTZ	
				3151 000 392	KZIS-4	

















1926							
1926 652.046	12.87 - 09.96	OM442		3400 124 101  3482 081 232  1878 005 668  3151 000 549	430 10 MFZ430 430WGTZ KZISZ-5		
				1878 003 269	420 10 420GTZ	Nebenantriebs-ID / PTO ID: 4/120	(50)
				3151 166 031	KZI-6	Nebenantriebs-ID / PTO ID: 4/120	(50)
1926 389.018 389.016 389.019 389.017 1926 A 389.115/116 1926 AK 389.144 1926 K 389.043/044	05.74 - 12.80	OM402		1882 302 131	380 GF380		
	05.74 - 12.80			1878 000 105	380 10 380GTZ		
	08.73 - 12.80	OM402.906, OM402.912		3151 000 375	KZIS-4		
	08.73 - 12.80			1861 643 134 #	420 10 420GSZ	Chass. 4372224-> für Nebenantrieb / for PTO	(82)
				3189 600 060			
1926 AS 389.112 1926 S,1926 LS 389.013 389.012 389.213 389.014	05.74 - 12.80	OM402		1882 302 131	380 GF380		
	08.73 - 09.96			1878 000 105	380 10 380GTZ		
		OM402.906, OM402.912, OM402.916		3151 000 375	KZIS-4		
				3189 600 060			
LP 1926 363.030-032 363.040-042 LPS 1926 363.030-032 363.040-042		OM402		1882 166 737	380 GF380		
				1878 000 104	380 10 380GTZ		

1927						
1927 AK 656.307		OM401LA		3400 123 001  3482 081 232  1878 080 031  3151 000 549	430 10 MFZ430 430WGTZ KZISZ-5	





















1928						
1928 346.002 346.001 346.003/004 346.013				1882 302 131	380 GF380	
				1878 000 105	380 10 380GTZ	
				3151 000 392	KZIS-4	

MERCEDES-BENZ

1928













1928,1928 L 621.017 621.016 621.466 621.416 621.015 621.066 1928 A 621.215 621.214 1928 AK 621.316/317 1928 AS 621.312 1928 S,1928 LS 621.112/113 621.163 621.111 621.512 621.162 621.511 621.562	08.73 - 09.96	OM422		1800 125 301  1882 301 239  1878 002 706  3151 000 375	420 10 GF420 420GTZ KZIS-4		
	01.80 - 03.91			3482 124 534 ●	430 GMF430		
	01.80 - 03.91			1882 346 131 #	420 GF420XN	für Nebenantrieb / for PTO	(82)
	01.80 - 03.91			1878 003 269	420 10 420GTZ	für Nebenantrieb / for PTO	(82)
	08.73 - 09.96			3151 204 001	KZI-6	für Nebenantrieb / for PTO mit Schmierrohranschluss / with lubrication pipe connection	(82) (91)
			OM422.905, OM422.907, OM422.911, OM422.913, OM422.906		3189 600 060		
1928 K 621.116/117 1928 L,LK,LS 346.034 346.043 346.032/033 346.031	01.80 - 03.91	OM422		1800 125 301  1882 301 239  1878 002 706  3151 000 375	420 10 GF420 420GTZ KZIS-4		
				3482 124 534 ●	430 GMF430		
				1861 643 134 #	420 10 420GSZ	621.116 für Nebenantrieb / for PTO	(82)
				3151 204 001	KZI-6	621.116 für Nebenantrieb / for PTO mit Schmierrohranschluss / with lubrication pipe connection	(82) (91)
		OM422.905, OM422.907, OM422.911, OM422.913		3189 600 060			





1929













1929,1929 L 656.016 656.015 656.018 656.416 1929 A 656.215 656.214 1929 A 656.215 1929 A 656.215 1929 AK 656.317 656.316 1929 AS 656.312 656.112 1929 K 656.116/117 1929 S 656.112/113	07.87 - 09.96	OM442		3400 124 101  3482 081 232  1878 005 668  3151 000 549	430 10 MFZ430 430WGTZ KZISZ-5		
	07.88 - 08.94			3400 122 501  3482 081 232  1878 634 027  3151 000 278	430 10 MFZ430 430WGTZ KZISZ-5		
	07.88 - 09.93			1888 063 137	380 GF2/380N	für Nebenantrieb / for PTO enthält eine Kupplungsscheibe / This part number includes one clutch disc	(82) (67)
	07.88 - 08.94			1862 304 033 ▽	380 10 380GV	für Nebenantrieb / for PTO Lose Kupplungsscheibe / Loose clutch disc	(82) (41)
	07.88 - 08.94			3151 166 031	KZI-6	für Nebenantrieb / for PTO	(82)
	07.88 - 08.94			1882 019 133	380 GF2/380N	In 1888 enthalten / Contained in 1888	(31)
	07.88 - 08.94			1859 250 101	380 GF2/380	In 1888 enthalten / Contained in 1888	(31)
	07.88 - 08.94			1862 305 033 △	380 10 380GVZ	In 1888 enthalten / Contained in 1888	(31)
	07.88 - 08.94			1888 055 247	380 GF2/380	656.317 enthält eine Kupplungsscheibe / This part number includes one clutch disc Sonderausführung / Special design	(67) (60)
	07.88 - 08.94			1862 123 131 ▽	380 10 380GV	656.317 Sonderausführung / Special design	(60)
	07.88 - 08.94			3151 108 031	KZI-4,5	656.317 Sonderausführung / Special design	(60)
	07.88 - 08.94			1882 349 003	380 GF2/380	656.317 In 1888 enthalten / Contained in 1888 Sonderausführung / Special design	(31) (60)
	07.88 - 08.94			1859 250 100	380 GF2/380	656.317 In 1888 enthalten / Contained in 1888 Sonderausführung / Special design	(31) (60)
	07.88 - 08.94			1862 122 132 △	380 10 380GVZ	656.317 In 1888 enthalten / Contained in 1888 Sonderausführung / Special design	(31) (60)
			OM442.925,		3189 600 059		

		CODE				
--	--	------	--	---	---	---

MERCEDES-BENZ









1932							
1932 389.05 389.02		OM423		3482 124 522	430 GMF430		
				1878 002 706	420 10 420GTZ		
1932 389.027 389.026 1932 A 389.125 1932 AK 389.154 1932 AS 389.122 389.124 1932 K 389.054 389.053 1932 S,1932 LS 389.023 389.223 389.022 389.024 LP 1932 363.080-082 363.090-092 LPS 1932 363.080-082 363.090-092	05.74 - 03.83	OM403		1800 125 301  1882 301 239  1878 002 706  3151 000 375	420 10 GF420 420GTZ KZIS-4	389.124-125/154/223/022-024/026-027/053-054 /122	
	05.74 - 03.83			3482 124 534 ●	430 GMF430	389.124-125/154/223/022-024/026-027/053-054 /122	
	08.73 - 09.83	OM403.916, OM403.931		1882 346 131 #	420 GF420XN	für Nebenantrieb / for PTO	(82)
	05.74 - 12.82			1878 634 014 ▲	420 10 420GSZ	für Nebenantrieb / for PTO	(82)
	08.73 - 08.82			3189 600 060			
	08.73 - 09.96				3482 124 534	430 GMF430	
				1882 301 239 ●	420 GF420		
				1878 003 320	420 10 420GTZ		













1933							
1933 621.047 621.046 621.097 621.096 1933 S,1933 LS 621.142/143 621.192 621.592 621.543 621.542	11.80 - 03.91	OM422A, 423		1882 342 134	420 GF420X		
	08.73 - 09.96			1878 002 878	420 10 420GTZ		
				3151 110 031	KZI-4,5		
				1882 346 131 #	420 GF420XN	für Nebenantrieb / for PTO	(82)
				1878 002 706	420 10 420GTZ	für Nebenantrieb / for PTO	(82)







1935							
1935 656.215		OM442		3482 081 231	430 MFZ430		
				1878 005 668	430 10 430WGTZ		
				3151 000 549	KZISZ-5		
1935 646.025 646.077 646.076 646.026/027 1935 AK 646.327 646.322 1935 AS 646.322 1935 S,1935 LS 646.172 646.121 646.123 646.522/523 646.122 646.573 646.572	02.86 - 09.89	OM422A		1888 055 041	380 GF2/380	enthält eine Kupplungsscheibe / This part number includes one clutch disc	(67)
	09.87 - 03.91			1878 006 055 ▽	380 10 380GT	Lose Kupplungsscheibe / Loose clutch disc	(41)
	09.87 - 03.91			3151 108 031	KZI-4,5		
	08.73 - 09.96			1882 349 003	380 GF2/380	In 1888 enthalten / Contained in 1888	(31)
				1859 250 100	380 GF2/380	In 1888 enthalten / Contained in 1888	(31)
				1862 138 032 Δ#	380 10 380GSZ	In 1888 enthalten / Contained in 1888	(31)
				1888 063 137	380 GF2/380N	für Nebenantrieb / for PTO enthält eine Kupplungsscheibe / This part number includes one clutch disc	(82) (67)
				1862 304 033	380 10 380GV	für Nebenantrieb / for PTO	(82)
				3151 204 001	KZI-6	für Nebenantrieb / for PTO mit Schmierrohranschluss / with lubrication pipe connection	(82) (91)

		CODE				
--	--	------	--	---	---	---

MERCEDES-BENZ

1935						
1935 656.026 656.025 656.074 656.076 656.078 656.028 656.215 656.024	05.89 - 08.94	OM442A		3400 122 601 ⊗ 3482 081 231 ⊗ 1878 080 037 ⊙ 3151 000 278	430 10 MFZ430 430WGTZ KZISZ-5	
1935 AK 656.327 656.327.11	05.89 - 08.94			1888 063 137	380 GF2/380N	für Nebenantrieb / for PTO enthält eine Kupplungsscheibe / This part number includes one clutch disc (82) (67)
1935 AS 656.322	05.89 - 08.94	OM442.966, OM442.964, OM442.977,		1862 304 033 ▽	380 10 380GV	für Nebenantrieb / for PTO Lose Kupplungsscheibe / Loose clutch disc (82) (41)
1935 K 656.127	05.89 - 08.94	OM442.976, OM442.963, OM442.971, OM442.972,		3151 166 031	KZI-6	für Nebenantrieb / for PTO (82)
1935 S 656.122/123 656.172	05.89 - 08.94	OM442.972, OM442.944, OM442.978, OM440.940, OM442.943, OM442.942		1882 019 133	380 GF2/380N	In 1888 enthalten / Contained in 1888 (31)
				1859 250 101	380 GF2/380	In 1888 enthalten / Contained in 1888 (31)
				1862 305 033 △	380 10 380GVZ	In 1888 enthalten / Contained in 1888 (31)
				3189 600 059		







1936						
1936 621.026 621.075 621.025	10.81 - 03.91	OM422A, 423		1882 342 134	420 GF420X	
1936 AK 621.327	10.81 - 03.91			1878 002 878	420 10 420GTZ	
1936 AS 621.322	10.81 - 03.91			3151 110 031	KZI-4,5	
1936 K 621.127	10.81 - 03.91			1882 346 131 #	420 GF420XN	für Nebenantrieb / for PTO (82)
1936 S,1936 LS 621.123 621.522 621.122	08.73 - 09.96			1878 002 706	420 10 420GTZ	für Nebenantrieb / for PTO (82)
				3151 204 001	KZI-6	für Nebenantrieb / for PTO mit Schmierrohranschluss / with lubrication pipe connection (82) (91)
		OM423		1888 042 009	380 GF2/380	enthält eine Kupplungsscheibe / This part number includes one clutch disc (67)
				1878 000 968 ▽	380 10 380GTZ	Lose Kupplungsscheibe / Loose clutch disc (41)
				3151 108 031	KZI-4,5	
				1882 341 001	380 GF2/380	In 1888 enthalten / Contained in 1888 (31)
				1859 250 102	380 GF2/380	In 1888 enthalten / Contained in 1888 (31)
				1878 000 968 △	380 10 380GTZ	In 1888 enthalten / Contained in 1888 (31)

1938						
1938 621.086 621.085	11.80 - 06.90	OM422LA		1888 042 009	380 GF2/380	621.085-086/182/582-583 enthält eine Kupplungsscheibe / This part number includes one clutch disc (67)
1938 S,1938 LS 621.583 621.182 621.582	08.73 - 09.96			1878 000 968 ▽	380 10 380GTZ	621.085-086/182/582-583 Lose Kupplungsscheibe / Loose clutch disc (41)
				3151 108 031	KZI-4,5	621.085-086/182/582-583
				1882 341 001	380 GF2/380	621.085-086/182/582-583 In 1888 enthalten / Contained in 1888 (31)
				1859 250 102	380 GF2/380	621.085-086/182/582-583 In 1888 enthalten / Contained in 1888 (31)
				1878 000 968 △	380 10 380GTZ	621.085-086/182/582-583 In 1888 enthalten / Contained in 1888 (31)

















		CODE				
--	--	------	--	---	---	---

MERCEDES-BENZ





1944

1944 646.095/096 1944 S,1944 LS 646.192 646.592/593 646.193	10.85 - 12.89	OM442LA		1888 055 247	380 GF2/380	enthält eine Kupplungsscheibe / This part number includes one clutch disc	(67)
	08.73 - 09.96			1862 123 131 ▽	380 10 380GV	Lose Kupplungsscheibe / Loose clutch disc	(41)
				3151 108 031	KZI-4,5		
				1882 349 003	380 GF2/380	In 1888 enthalten / Contained in 1888	(31)
				1859 250 100	380 GF2/380	In 1888 enthalten / Contained in 1888	(31)
				1862 122 132 △	380 10 380GVZ	In 1888 enthalten / Contained in 1888	(31)

1945

























1945 AK 656.317	07.88 - 08.94	OM442, 443A		3400 124 101  3482 081 232  1878 005 668  3151 000 549	430 10 MFZ430 430WGTZ KZISZ-5			
			OM443A		1888 055 247	380 GF2/380	enthält eine Kupplungsscheibe / This part number includes one clutch disc Sonderausführung / Special design	(67) (60)
					1862 123 131 ▽	380 10 380GV	Lose Kupplungsscheibe / Loose clutch disc Sonderausführung / Special design	(41) (60)
					3151 108 031	KZI-4,5	Sonderausführung / Special design	(60)
					1882 349 003	380 GF2/380	In 1888 enthalten / Contained in 1888 Sonderausführung / Special design	(31) (60)
					1859 250 100	380 GF2/380	In 1888 enthalten / Contained in 1888 Sonderausführung / Special design	(31) (60)
		1862 122 132 △		380 10 380GVZ	In 1888 enthalten / Contained in 1888 Sonderausführung / Special design	(31) (60)		
	OM443.940			1888 063 137	380 GF2/380N	Nebenantriebs-ID / PTO ID: 4/125 enthält eine Kupplungsscheibe / This part number includes one clutch disc	(50) (67)	
				1862 304 033 ▽	380 10 380GV	Nebenantriebs-ID / PTO ID: 4/125 Lose Kupplungsscheibe / Loose clutch disc	(50) (41)	
				3151 166 031	KZI-6	Nebenantriebs-ID / PTO ID: 4/125	(50)	
				1882 019 133	380 GF2/380N	In 1888 enthalten / Contained in 1888	(31)	
			1859 250 101	380 GF2/380	In 1888 enthalten / Contained in 1888	(31)		
					1862 305 033 △	380 10 380GVZ	In 1888 enthalten / Contained in 1888	(31)

1948

1948 656.215 656.317				1888 063 137	380 GF2/380N	Nebenantriebs-ID / PTO ID: 4/125 enthält eine Kupplungsscheibe / This part number includes one clutch disc	(50) (67)
				1862 304 033 ▽	380 10 380GV	Nebenantriebs-ID / PTO ID: 4/125 Lose Kupplungsscheibe / Loose clutch disc	(50) (41)
				3151 166 031	KZI-6	Nebenantriebs-ID / PTO ID: 4/125	(50)
				1882 019 133	380 GF2/380N	In 1888 enthalten / Contained in 1888	(31)
				1859 250 101	380 GF2/380	In 1888 enthalten / Contained in 1888	(31)
				1862 305 033 △	380 10 380GVZ	In 1888 enthalten / Contained in 1888	(31)





























		CODE				
--	--	------	--	---	---	---

MERCEDES-BENZ

1948							
1948 656.094-096	09.88 - 07.92	OM442		3400 121 601 ⊗ 3488 017 432 ⊗ 1878 634 022 ⊙ 3151 000 547	400 10 MFZ2/400X 400GVZ KZISZ-5	->Chass. K011863	
				3400 122 901 ⊗ 3482 081 233 ⊗ 1878 002 735 ⊙ 3151 000 278	430 10 MFZ430 430GTZ KZISZ-5	Chass. K011863->	
		OM442LA		3488 017 432	400 MFZ2/400X	für OE-Nummer / for OE number 005 250 88 04 für OE-Nummer / for OE number 005 250 76 04 für OE-Nummer / for OE number 005 250 77 04 enthält eine Kupplungsscheibe / This part number includes one clutch disc Sonderausführung / Special design	(83) (83) (83) (67)
				1878 005 805	400 10 400GTZ	für OE-Nummer / for OE number 014 250 70 03 für OE-Nummer / for OE number 014 250 08 03 Sonderausführung / Special design	(83) (83) (60)
				1878 634 022 #	400 10 400GVZ	für OE-Nummer / for OE number 014 250 70 03 für OE-Nummer / for OE number 014 250 08 03 Sonderausführung / Special design	(83) (83) (60)
				3151 000 547	KZISZ-5	für OE-Nummer / for OE number 002 250 08 15 für OE-Nummer / for OE number 001 250 88 15 für OE-Nummer / for OE number 001 250 80 15 Sonderausführung / Special design	(83) (83) (83) (60)
		OM442.984, OM442.985, OM442.982, OM442.989		3189 600 059			
1948 AK							
1948 AK 656.317		OM442		1888 055 247	380 GF2/380	enthält eine Kupplungsscheibe / This part number includes one clutch disc Sonderausführung / Special design	(67) (60)
				1862 123 131 ▽	380 10 380GV	Lose Kupplungsscheibe / Loose clutch disc Sonderausführung / Special design	(41) (60)
				3151 108 031	KZI-4,5	Sonderausführung / Special design	(60)
				1882 349 003	380 GF2/380	In 1888 enthalten / Contained in 1888 Sonderausführung / Special design	(31) (60)
				1859 250 100	380 GF2/380	In 1888 enthalten / Contained in 1888 Sonderausführung / Special design	(31) (60)
				1862 122 132 △	380 10 380GVZ	In 1888 enthalten / Contained in 1888	(31)
1953							
1953 655.593		OM442		3400 121 601 ⊗ 3488 017 432 ⊗ 1878 634 022 ⊙ 3151 000 547	400 10 MFZ2/400X 400GVZ KZISZ-5	für Ausrückgabel mit Rollen / for release fork with rollers	(71)
2020							
2020 L 677.224 677.233	01.84 - 12.98	OM366LA		3482 000 953	350 GMF350X	677.224/233	
				1878 001 070	350 10 350GTZ	677.224/233	
				3151 000 374	KZIS-4	677.224/233	
L,LA,LB,LAB 2220 345.		OM344		1882 166 737	380 GF380		
				1878 000 104	380 10 380GTZ		
				3151 000 529	KZIS-4		
LPS 2020				1882 166 737	380 GF380		
				1878 000 104	380 10 380GTZ		
				3151 000 529	KZIS-4		
2023							
LPS 2023				1882 166 737	380 GF380		
				1878 000 104	380 10 380GTZ		
				3151 000 529	KZIS-4		







































		CODE				
--	--	------	--	---	---	---

MERCEDES-BENZ

2024							
2024 336				1882 166 737	380 GF380		
				1878 000 104	380 10 380GTZ		
				3151 000 529	KZIS-4		
2024 656.045 656.049 656.046 656.048 2024 656.046 656.049 656.045 656.048 2024 AK 656.307 656.309 2024 AK 656.309 2024 K 656.109 2024 K 656.109	02.93 - 09.96	OM401LA		3400 700 411 ⊗ 3482 081 232 ⊗ 1878 080 033 ⊙ 3151 000 278	430 10 MFZ430 430WGTZ KZISZ-5	656.109/309/045-046/048-049	
	01.94 - 09.96						
	02.93 - 09.96	OM401.975, OM445.924, OM401.984		1888 063 137	380 GF2/380N	Nebenantriebs-ID / PTO ID: 4 enthält eine Kupplungsscheibe / This part number includes one clutch disc	(50) (67)
	01.94 - 09.96			1862 304 033 ▽	380 10 380GV	Nebenantriebs-ID / PTO ID: 4 Lose Kupplungsscheibe / Loose clutch disc	(50) (41)
	02.93 - 09.96			3151 166 031	KZI-6	Nebenantriebs-ID / PTO ID: 4	(50)
	01.94 - 09.96			1882 019 133	380 GF2/380N	In 1888 enthalten / Contained in 1888	(31)
				1859 250 101	380 GF2/380	In 1888 enthalten / Contained in 1888	(31)
				1862 305 033 △	380 10 380GVZ	In 1888 enthalten / Contained in 1888	(31)
				3189 600 059			
	2024 AK 656.307		OM401LA		3400 123 001 ⊗ 3482 081 232 ⊗ 1878 080 031 ⊙ 3151 000 549	430 10 MFZ430 430WGTZ KZISZ-5	
2024 L 679.227 679.223	01.84 - 12.98	OM366LA		1882 166 737	380 GF380	679.223/227	
				1878 000 105	380 10 380GTZ	679.223/227	
				3151 000 374	KZIS-4	679.223/227	
LPS 2024 366.366 366.356		OM355		1882 166 737	380 GF380		
				1878 000 104	380 10 380GTZ		
				3151 000 529	KZIS-4		
2025							
2025 S 619.211	08.83 - 03.91	OM422		1882 302 135 #	380 GF380		
				1878 000 105	380 10 380GTZ		
				3151 000 375	KZIS-4		
			OM422.909		3189 600 060		
2026							
2026 S 391.310	10.76 - 10.80	OM402		1882 302 131	380 GF380		
				1878 000 105	380 10 380GTZ		
				3151 000 375	KZIS-4		
			OM402.912, OM402.916		3189 600 060		
2027							
2027 AK 656.309	02.93 - 09.96	OM401LA		3400 700 411 ⊗ 3482 081 232 ⊗ 1878 080 033 ⊙ 3151 000 278	430 10 MFZ430 430WGTZ KZISZ-5		
		OM401.989		3189 600 059			











		CODE				
--	--	------	--	---	---	---









MERCEDES-BENZ







2027						
2027 AK 656.309	02.93 - 09.96	OM445.933	 3400 700 411  3482 081 232  1878 080 033  3151 000 278	430 10 MFZ430 430WGTZ KZISZ-5	für Fahrzeuge mit Einscheibenkupplung / for vehicles with single disc clutch	(72)
			 1888 063 137	380 GF2/380N	für / for: SA32910 08 für Fahrzeuge mit Zweischeibenkupplung / for vehicles with double disc clutch enthält eine Kupplungsscheibe / This part number includes one clutch disc	(69) (77) (67)
			 1862 304 033 ▽	380 10 380GV	für / for: SA32910 08 für Fahrzeuge mit Zweischeibenkupplung / for vehicles with double disc clutch Lose Kupplungsscheibe / Loose clutch disc	(69) (77) (41)
			 3151 166 031	KZI-6	für / for: SA32910 08 für Fahrzeuge mit Zweischeibenkupplung / for vehicles with double disc clutch	(69) (77)
			 3189 600 059			
2028						
2028 A 624.202 624.304 624.203	01.80 - 06.89	OM422	 1800 125 301  1882 301 239  1878 002 706  3151 000 375	420 10 GF420 420GTZ KZIS-4	624.202-203/304	
			 3482 124 534 ●	430 GMF430	624.202-203/304	
			 1882 346 131 #	420 GF420XN	624.304 Nebenantriebs-ID / PTO ID: 110	(50)
			 1878 634 014 ▲	420 10 420GSZ	624.304 Nebenantriebs-ID / PTO ID: 110	(50)
			 3189 600 060			
2028 LS 622.505 622.555	01.80 - 06.89	OM422	 1800 125 301  1882 301 239  1878 002 706  3151 000 375	420 10 GF420 420GTZ KZIS-4		
			 3482 124 534 ●	430 GMF430		
			 3189 600 060			
2031 656.014 656.011/012 2031 A 656.214 656.205 2031 A 656.205 2031 A 656.205 2031 A 656.205 2031 A 656.205 2031 AS 656.302 2031 S 656.142	03.92 - 09.96	OM401LA	 3400 124 001  3482 081 231  1878 634 027  3151 000 278	430 10 MFZ430 430WGTZ KZISZ-5	656.147/205/302/011-012/014/142	
			 1888 063 137	380 GF2/380N	Nebenantriebs-ID / PTO ID: 4/125 enthält eine Kupplungsscheibe / This part number includes one clutch disc	(50) (67)
			 1862 304 033 ▽	380 10 380GV	Nebenantriebs-ID / PTO ID: 4/125 Lose Kupplungsscheibe / Loose clutch disc	(50) (41)
2031 A 656.205 2031 A 656.205 2031 A 656.205 2031 AS 656.302 2031 S 656.142	03.92 - 09.96	OM401.986, OM401.979, OM446.927, OM445.930, OM440.979, OM402.996, OM402.978, OM401.972, OM401.993	 3151 166 031	KZI-6	Nebenantriebs-ID / PTO ID: 4/125	(50)
			 1882 019 133	380 GF2/380N	In 1888 enthalten / Contained in 1888	(31)
			 1859 250 101	380 GF2/380	In 1888 enthalten / Contained in 1888	(31)
			 1862 305 033 △	380 10 380GVZ	In 1888 enthalten / Contained in 1888	(31)
			 3189 600 059			
2031 K 656.147 2031 K 656.147	03.92 - 09.96	OM401LA	 3400 124 001  3482 081 231  1878 634 027  3151 000 278	430 10 MFZ430 430WGTZ KZISZ-5	656.147	
			 3189 600 059			









		CODE				
--	--	------	--	---	---	---

MERCEDES-BENZ











2032						
2032 6x2 391.32		OM423		3482 124 522	430 GMF430	
				1878 002 706	420 10 420GTZ	
2032 S 391.320	08.75 - 09.83	OM403		1800 125 301  1882 301 239  1878 002 706  3151 000 375	420 10 GF420 420GTZ KZIS-4	
				3482 124 534 ●	430 GMF430	
LPS 2032 363.362 363.352		OM403		3189 600 060		
				3482 124 534	430 GMF430	
				1882 301 239 ●	420 GF420	
				1878 003 320	420 10 420GTZ	











2033								
2033 LS 622.520 622.570	12.81 - 05.87	OM422A		1888 042 009	380 GF2/380	622.570 enthält eine Kupplungsscheibe / This part number includes one clutch disc (67)		
				1878 000 968 ▽	380 10 380GTZ	622.570 Lose Kupplungsscheibe / Loose clutch disc (41)		
				3151 108 031	KZI-4,5	622.570		
				1882 341 001	380 GF2/380	622.570 In 1888 enthalten / Contained in 1888 (31)		
						1878 000 968 △	380 10 380GTZ	622.570 In 1888 enthalten / Contained in 1888 (31)
				OM422A, 423		1882 342 134	420 GF420X	622.520/570
						1878 002 878	420 10 420GTZ	622.520/570
						3151 110 031	KZI-4,5	622.520/570





2035						
2035 S, 2035 LS 647.110 647.560 647.510	08.73 - 09.96	OM422A		1888 055 041	380 GF2/380	647.510/560/110 625.123 enthält eine Kupplungsscheibe / This part number includes one clutch disc (67)
				1878 006 055 ▽	380 10 380GT	647.510/560 625.123 Lose Kupplungsscheibe / Loose clutch disc (41)
				3151 108 031	KZI-4,5	647.510/560/110 625.123
				1882 349 003	380 GF2/380	647.510/560 625.123 In 1888 enthalten / Contained in 1888 (31)
				1859 250 100	380 GF2/380	647.510/560 625.123 In 1888 enthalten / Contained in 1888 (31)
				1862 138 032 △#	380 10 380GSZ	647.510/560 625.123 In 1888 enthalten / Contained in 1888 (31)

2036						
2036 A 624.304 624.203	01.80 - 06.89	OM442.950, OM442.962		1800 125 301  1882 301 239  1878 002 706  3151 000 375	420 10 GF420 420GTZ KZIS-4	
				3189 600 060		
2036 LS 622.510	03.84 - 03.91	OM422A, 423		1882 342 134	420 GF420X	
				1878 002 878	420 10 420GTZ	
				3151 110 031	KZI-4,5	

MERCEDES-BENZ

2038							
2038 656.086 656.038 656.036 656.132 656.085 656.034 656.088 656.035 655.337 2038 656.088 656.085 655.337 656.086 2038 AS 656.332 2038 AS 656.332 2038 AS 656.332 2038 S 656.132	11.91 - 09.96	OM402LA, 442LA, 446		3400 122 601 ⚙️ 3482 081 231 ⚙️ 1878 080 037 ⚙️ 3151 000 278	430 10 MFZ430 430WGTZ KZISZ-5		
	12.92 -				3400 122 901 ⚙️ 3482 081 233 ⚙️ 1878 002 735 ⚙️ 3151 000 278	430 10 MFZ430 430GTZ KZISZ-5	für / for: SA033617-01 (69)
	12.92 - 09.96				1888 063 137	380 GF2/380N	für Nebenantrieb / for PTO enthält eine Kupplungsscheibe / This part number includes one clutch disc (82) (67)
	01.94 - 09.96		OM440.970, OM402.971, OM446.925, OM446.927, OM402.985, OM440.979, OM402.986, OM402.996, OM402.978, OM402.972		1862 304 033 ▽	380 10 380GV	für Nebenantrieb / for PTO Lose Kupplungsscheibe / Loose clutch disc (82) (41)
					3151 166 031	KZI-6	für Nebenantrieb / for PTO (82)
					1882 019 133	380 GF2/380N	In 1888 enthalten / Contained in 1888 (31)
					1859 250 101	380 GF2/380	In 1888 enthalten / Contained in 1888 (31)
					1862 305 033 △	380 10 380GVZ	In 1888 enthalten / Contained in 1888 (31)
					3483 023 032 ⊕	445 GMFZ445W	für Fahrzeuge mit Wandlerschaltkupplung / for vehicles with converter and clutch unit (76)
					1878 003 780	445 24 445GTZ	für Fahrzeuge mit Wandlerschaltkupplung / for vehicles with converter and clutch unit (76)
					3189 600 059		

















2044							
2044 656.091 656.034 656.190 656.092/093 655.337 2044 S 656.190	01.92 - 09.96	OM442LA		3400 121 601 ⚙️ 3488 017 432 ⚙️ 1878 634 022 ⚙️ 3151 000 547	400 10 MFZ2/400X 400GVZ KZISZ-5	->Chass. K011863 656.091-092-093/190	
	01.92 - 09.96				3400 122 901 ⚙️ 3482 081 233 ⚙️ 1878 002 735 ⚙️ 3151 000 278	430 10 MFZ430 430GTZ KZISZ-5	Chass. K011864-> 656.091-092-093/190
			OM440.970, OM440.978, OM446.922		3483 023 032 ⊕	445 GMFZ445W	655.337 für Fahrzeuge mit Wandlerschaltkupplung / for vehicles with converter and clutch unit (76)
					1878 003 780	445 24 445GTZ	655.337 für Fahrzeuge mit Wandlerschaltkupplung / for vehicles with converter and clutch unit (76)
					3189 600 059		
2044 AS 656.332	01.94 - 09.96	OM440.970, OM440.979		1888 063 137	380 GF2/380N	626.332 Nebenantriebs-ID / PTO ID: 4/125 enthält eine Kupplungsscheibe / This part number includes one clutch disc (50) (67)	
					1862 304 033 ▽	380 10 380GV	626.332 Nebenantriebs-ID / PTO ID: 4/125 Lose Kupplungsscheibe / Loose clutch disc (50) (41)
					3151 166 031	KZI-6	626.332 Nebenantriebs-ID / PTO ID: 4/125 (50)
					1882 019 133	380 GF2/380N	626.332 In 1888 enthalten / Contained in 1888 (31)
					1859 250 101	380 GF2/380	626.332 In 1888 enthalten / Contained in 1888 (31)
				1862 305 033 △	380 10 380GVZ	626.332 In 1888 enthalten / Contained in 1888 (31)	



2050							
2050 656.096 656.094/095 2050 S 656.192	01.91 - 09.96	OM442		3400 121 601 ⚙️ 3488 017 432 ⚙️ 1878 634 022 ⚙️ 3151 000 547	400 10 MFZ2/400X 400GVZ KZISZ-5	->Chass. K011863 656.094-095-096/192	
	01.91 - 09.96				3400 122 901 ⚙️ 3482 081 233 ⚙️ 1878 002 735 ⚙️ 3151 000 278	430 10 MFZ430 430GTZ KZISZ-5	Chass. K011864-> 656.094-095-096/192
			OM442LA		3400 121 601 ⚙️ 3488 017 432 ⚙️ 1878 634 022 ⚙️ 3151 000 547	400 10 MFZ2/400X 400GVZ KZISZ-5	für / for: SA33613-03 656.094-095-096/192 (69)
			OM442.985, OM442.997,		3189 600 059		

		CODE				
--	--	------	--	---	---	---

MERCEDES-BENZ







































2055						
2055 AF 656.091	01.92 - 09.96	OM442.997		3400 121 601 ⊗ 3488 017 432 ⊗ 1878 634 022 ⊙ 3151 000 547	400 10 MFZ2/400X 400GVZ KZISZ-5	->Chass. K011863 für Fahrzeuge mit Zweis Scheibenkupplung / for vehicles with double disc clutch (77)
				3400 122 901 ⊗ 3482 081 233 ⊗ 1878 002 735 ⊙ 3151 000 278	430 10 MFZ430 430GTZ KZISZ-5	Chass. K011864-> für Fahrzeuge mit Einscheibenkupplung / for vehicles with single disc clutch (72)

2219							
2219 385.375 385.372 385.377 385.373 2219 K 385.390/391 2219 KO 385.392	06.76 - 01.87	OM401.925, OM401.914, OM401.926		3482 000 953	350 GMF350X		
					1878 001 070	350 10 350GTZ	
					3151 043 031	KZI-4,5	
					1878 000 964	380 10 380GTZ	385.079/372-373/375/392 für Nebenantrieb / for PTO (82)
2219 C, 2219 CL 619.412 619.011 619.203/204 619.012 619.414 619.014 619.411	08.73 - 09.96	OM362, 366		3482 000 953	350 GMF350X	619.011-012/014/411-412/414/203-204	
					1878 001 070	350 10 350GTZ	619.011-012/014/411-412/414/203-204
					3482 000 953 ●	350 GMF350X	619.411-412/414/011-012/014/203-204 Nur zusammen verbauen / Only install together (53)
					1878 001 144 ●	350 10 350WGTZ	619.411-412/414/011-012/014/203-204 Nur zusammen verbauen / Only install together (53)
					3151 000 374	KZIS-4	619.011-012/014/411-412/414/203-204
2219, 2219 L 385.323 385.528 385.328 385.322 385.525 385.078/079 385.325 385.523	08.73 - 09.96	OM362, 366, 401		3482 000 953	350 GMF350X	385.323/325/523/525/528	
					1878 001 070	350 10 350GTZ	385.323/325/523/525/528
					3151 043 031	KZI-4,5	385.323/325/523/525/528
				OM401.923, OM401.927, OM401.926		1878 000 964	380 10 380GTZ
LP, LPK 2219 355.451-453 355.461 360.355-357		OM360		1882 234 433	350 GF350		
					1878 001 074	350 10 350GTZ	
					3151 094 041	KZI-4	

2220							
2220, 2220 L 619.014 619.203 619.414 619.204 619.402 619.411 619.012 619.412 619.011	08.73 - 09.96	OM362, 366		3482 000 953	350 GMF350X	619.011-012/014/411-412/414/203-204	
					1878 001 070	350 10 350GTZ	619.011-012/014/411-412/414/203-204
					3482 000 953 ●	350 GMF350X	619.411-412/414 Nur zusammen verbauen / Only install together (53)
					1878 001 144 ●	350 10 350WGTZ	619.411-412/414 Nur zusammen verbauen / Only install together (53)
					3151 000 374	KZIS-4	

		CODE				
--	--	------	--	---	---	---



MERCEDES-BENZ

2222								
2222 619.036-038 2222 K 619.137/138	05.82-03.91	OM421	 1882 302 131	380 GF380	->Chass. 234953			
	05.82-03.91	OM421	 1878 000 105	380 10 380GTZ	->Chass. 234953			
			 3151 000 375	KZIS-4	->Chass. 234953			
			 3482 124 541	430 GMF430	Chass. 234954->			
			 1882 301 238 ●#	420 GF420	Chass. 234954->			
			 1878 002 706	420 10 420GTZ	Chass. 234954->			
			 3151 000 375	KZIS-4	Chass. 234954->			
			 1861 643 134 #	420 10 420GSZ	für Nebenantrieb / for PTO	(82)		
			 3151 079 031	KZI-6	für Nebenantrieb / for PTO	(82)		
	OM421.905	 3189 600 060						
2222,2222 L 619.419 619.017 619.019 619.417 619.208/209	08.73-09.96	OM421.905	 1800 125 301	420 10 GF420				
		OM421	 1882 301 239	420GTZ				
			 1878 002 706	KZIS-4				
		 3151 000 375						
		 3189 600 060						
		OM421	 1882 302 131	380 GF380	->Chass. 234953 619.017/019/208-209/417/419			
			 1878 000 105	380 10 380GTZ	->Chass. 234953 619.017/019/417/419/208-209			
			 3151 126 031	KZI-4,5	->Chass. 234953 619.017/019/417/419/208-209			
			 3482 124 541	430 GMF430	Chass. 234954-> 619.017/019/417/419/208-209			
			 1882 301 238 ●#	420 GF420	Chass. 234954-> 619.017/019/417/419/208-209			
			 1878 002 706	420 10 420GTZ	Chass. 234954-> 619.417/419/208-209/017/019			
			 3151 126 031	KZI-4,5	Chass. 234954-> 619.208-209/417/419/017/019			
			 1861 643 134 #	420 10 420GSZ	619.208-209 für Nebenantrieb / for PTO	(82)		
			 3151 079 031	KZI-6	619.208-209 für Nebenantrieb / for PTO	(82)		
			OM441	 3482 124 541	430 GMF430	619.419		
		 1882 301 238 ●#		420 GF420	619.419			
		 1878 002 706		420 10 420GTZ	619.419			
		 3151 126 031		KZI-4,5	619.419			
		2222 B 619.045 619.047	05.82-03.91	OM421	 1800 125 301	420 10 GF420	619.045/047	
					 1882 301 239	420GTZ		
 1878 002 706	KZIS-4							
 3151 000 375								
 3482 124 534 ●	430 GMF430				619.045/047			
 1882 346 131 #	420 GF420XN				619.045 für Nebenantrieb / for PTO	(82)		
 1861 643 134 #	420 10 420GSZ				619.045 für Nebenantrieb / for PTO	(82)		
 3151 079 031	KZI-6				619.045 für Nebenantrieb / for PTO	(82)		
OM421.905, OM421.907, OM441.906	 3189 600 060							
	 1861 643 134 #	420 10 420GSZ	619.045/047 für Nebenantrieb / for PTO	(82)				
	 3151 079 031	KZI-6	619.045/047 für Nebenantrieb / for PTO	(82)				



































		CODE				
--	--	------	--	---	---	---

MERCEDES-BENZ

2223







LP 2223 335.462 335.452		OM355	 1882 166 737	380 GF380		
			 1878 000 104	380 10 380GTZ		
			 3151 000 529	KZIS-4		

2224



















2224 385.335 385.332 385.338 385.333	04.76 - 12.82	OM402	 1882 302 131	380 GF380	385.332-333/335/338/383/385/387/395/397/399	
			 1878 000 105	380 10 380GTZ	385.332-333/335/338/383/385/387/395/397/399	
			 3151 000 375	KZIS-4	385.332-333/335/338/383/385/387/395/397/399	
		OM402, 403	 1882 302 131	380 GF380		
			 1878 000 105	380 10 380GTZ		
			 3151 000 375	KZIS-4		
OM402.928, OM402.911	 3189 600 060					
2224 385.383 385.387 385.385 2224 K 385.397 385.395	04.76 - 12.82	OM402	 1882 302 131	380 GF380		
	04.76 - 12.82		 1878 000 105	380 10 380GTZ		
			 3151 000 375	KZIS-4		
		OM402, 403	 1882 302 131	380 GF380		
	 1878 000 105		380 10 380GTZ			
	 3151 000 375		KZIS-4			
	OM402.928, OM402.927, OM402.911, OM402.910	 1861 643 134 #	420 10 420GSZ	für Nebenantrieb / for PTO	(82)	
		 3151 079 031	KZI-6	für Nebenantrieb / for PTO	(82)	
		 3189 600 060				
2224 B 385.394 385.396 385.398	05.75 - 03.84	OM402	 1882 330 032 #	420 GF420	->08.1976	
			 1878 001 136	420 10 420GTZ	->08.1976	
			 3151 000 375	KZIS-4	->08.1976	
			 3482 124 541	430 GMF430	09.1976->	
			 1882 301 238 ●#	420 GF420	09.1976->	
			 1878 001 136	420 10 420GTZ	09.1976->	
			 3151 000 375	KZIS-4	09.1976->	
			 1861 643 134 #	420 10 420GSZ	385.383/385/387/394/396-398 für Nebenantrieb / for PTO	(82)
		OM402.914	 3151 079 031	KZI-6	385.383/385/387/394/396-398 für Nebenantrieb / for PTO	(82)
			 3189 600 060			
		OM403	 1800 125 301	420 10 GF420	385.394/396/398	
			 1882 301 239	420GTZ		
			 1878 002 706	KZIS-4		
			 3482 124 534 ●	430 GMF430	385.394/396/398	
2224 S 385.399	07.76 - 12.82	OM402	 1882 302 131	380 GF380	385.332-333/335/338/383/385/387/395/397/399	
			 1878 000 105	380 10 380GTZ	385.332-333/335/338/383/385/387/395/397/399	
			 3151 000 375	KZIS-4	385.332-333/335/338/383/385/387/395/397/399	
		OM402.928, OM402.911	 3189 600 060			

MERCEDES-BENZ







2224

LP 2224				3482 124 534	430 GMF430		
				1882 301 239 ●	420 GF420		
				1878 003 320	420 10 420GTZ		
				3151 000 529	KZIS-4		
LP,LPB,LPK,LPS 2224 355.452 361.465 361.455-457 361.467 355.462 361.463 361.453				1882 166 737	380 GF380		
				1878 000 104	380 10 380GTZ		
				3151 000 529	KZIS-4		

2225

2225 619.034 619.017 617.033 619.019	04.85 - 03.91	OM422		1882 302 135 #	380 GF380		
				1878 000 105	380 10 380GTZ		
				3151 000 375	KZIS-4		
				3151 000 375	KZIS-4	->Chass. 5107148 617.033	
				3151 126 031	KZI-4,5	Chass. 5107149-> 617.033	
		OM422.909		3189 600 060			
2225 B 617.532 619.048/049	08.83 - 03.91	OM422		3482 124 534	430 GMF430		
				1882 301 239 ●	420 GF420		
				1878 002 706	420 10 420GTZ		
				3151 126 031	KZI-4,5		
			OM421		1861 643 134 #	420 10 420GSZ	619.048-049 Nebenantriebs-ID / PTO ID: 3/90
				3151 079 031	619.048-049 Nebenantriebs-ID / PTO ID: 3/90	(50)	
2225 L 617.436 617.435	08.73 - 09.96	OM422		1882 302 135 #	380 GF380		
				1878 000 105	380 10 380GTZ		
				3151 000 375	KZIS-4	->Chass. 5107148 617.033	
				3151 126 031	KZI-4,5	Chass. 5107149-> 617.033	
				3151 182 031 ▲	KZI-5	für / for: SA26602 01	(69)
			OM422.909		3189 600 060		

2226

2226 393.316 393.315 2226,2226 L 393.374 393.376 393.375 393.377 393.574-576	09.75 - 12.80	OM402		1882 302 131	380 GF380		
	08.73 - 09.96			1878 000 105	380 10 380GTZ		
				1878 000 105	380 10 380GTZ	393.311/315-316/374-377	
				3151 000 375	KZIS-4		
		OM402.924, OM402.912, OM402.916		3189 600 060			
LP,LPB,LPK,LPS 2226 363.471-474 363.482 363.026 363.481 363.021		OM402		1882 166 737	380 GF380		
				1878 000 104	380 10 380GTZ		























		CODE				
--	--	------	--	---	---	---

MERCEDES-BENZ

2227

LP 2217	06.69-	OM324	 1882 234 433	350 GF350		
			 1878 001 074	350 10 350GTZ		
			 3151 044 031	KZI-3		
LP 2217	-05.69	OM324	 1878 001 074	350 10 350GTZ		
LP 2217 355,360 LPB 2217 355,360			 1878 001 074	350 10 350GTZ	Nebenantriebs-ID / PTO ID: 70,80	(50)

2228

2228 623.033 623.032	12.79-03.91	OM422	 1800 125 301	420 10 GF420	623.032-033/130			
			 1882 301 239	420 10 420GTZ				
			 1878 002 706	420 10 KZIS-4				
			 3151 000 375					
			 3482 124 534 ●	430 GMF430	623.032-033/130			
		OM422.905, OM422.911	 3189 600 060					
2228 S 623.180 623.130	12.79-03.91	OM421, 422	 1882 342 134	420 GF420X	623.180			
			 1878 002 878	420 10 420GTZ	623.180			
			 3151 110 031	KZI-4,5	623.180			
		OM422	 3482 124 534	430 GMF430	623.032-033/130/180			
			 1882 301 239 ●	420 GF420	623.032-033/130/180			
			 1878 002 706	420 10 420GTZ	623.032-033/130/180			
			 3151 000 375	KZIS-4	623.032-033/130/180			
		OM422.905, OM422.911	 3189 600 060					
2228,2228 L 623.008 623.058 623.007 623.458 623.009 623.408 623.006 617.033 623.407	08.73-09.96	OM422	 3482 124 534	430 GMF430	623.006-007-008-009/058/407-408/458			
			 1882 301 239 ●	420 GF420	623.006-007-008-009/058/407-408/458			
			 1878 002 706	420 10 420GTZ	623.006-007-008-009/058/407-408/458			
			 3151 000 375	KZIS-4	623.006-007-008-009/058/407-408/458			
				OM422.905, OM422.911, OM422.906	 1882 346 131 #	420 GF420XN	623.006-007 für Nebenantrieb / for PTO	(82)
					 1878 003 269	420 10 420GTZ	623.006-007 für Nebenantrieb / for PTO	(82)
					 3151 204 001	KZI-6	623.006-007 für Nebenantrieb / for PTO mit Schmierrohranschluss / with lubrication pipe connection	(82) (91)
			 3189 600 060					















2232

2232 393.316 393.374 393.376 393.32 393.375 393.377 393.315 393.311 393.38		OM402, 403	 1882 302 131	380 GF380	393.311/315-316/374-375-376-377		
			 1878 000 105	380 10 380GTZ	393.311/315-316/374-375-376-377		
			 3151 000 375	KZIS-4	393.311/315-316/374-375-376-377		
			OM423	 3482 124 522	430 GMF430	393.32/38	
				 1878 002 706	420 10 420GTZ	393.32/38	
				 3189 600 060			















		CODE				
--	--	------	--	---	---	---

MERCEDES-BENZ

2232

2232 393.325/326 2232,2232 L 393.385 393.387 393.386 393.384 393.585/586 2232 S,2232 LS 393.521 393.321	05.74 - 09.83	OM403		1800 125 301  1882 301 239  1878 002 706  3151 000 375	420 10 GF420 420GTZ KZIS-4	393.321/325-326/384-387/521/585-586	
	08.73 - 09.96				3482 124 534 ● 430 GMF430	393.321/325-326/384-387/521/585-586	
2232 L 393.576 393.511 393.575 393.574	08.73 - 09.96	OM403.932, OM403.931		3189 600 060			
		OM402, 403		1882 302 131	380 GF380		
				1878 000 105	380 10 380GTZ		
				3151 000 375	KZIS-4		
LP 2232 363.482 363.481 363.471-474		OM403		1882 166 737	380 GF380		
				1878 000 104	380 10 380GTZ		
LP 2232		OM403		1882 346 131 #	420 GF420XN	Nebenantriebs-ID / PTO ID: 110	(50)
LP,LPL,LPK,LPS 2232 363.452 363.461 363.071 363.454 363.451 363.072 363.462 363.464 363.077 363.076		OM403		3482 124 534	430 GMF430	363.461-462/464/071-072/076-077/451-452/454	
				1882 301 239 ●	420 GF420	363.461-462/464/071-072/076-077/451-452/454	
				1878 003 320	420 10 420GTZ	363.461-462/464/071-072/076-077/451-452/454	













2233

2233 623.048 2233,2233 L 623.073 623.423 623.473 623.023	11.80 - 05.87	OM422A, 423		1882 342 134	420 GF420X	623.023/048/073/423/473		
	08.73 - 09.96				1878 002 878	420 10 420GTZ	623.023/048/073/423/473	
					3151 110 031	KZI-4,5	623.023/048/073/423/473	
					1882 346 131 #	420 GF420XN	623.023/048 für Nebenantrieb / for PTO	(82)
					1878 002 706	420 10 420GTZ	623.023/048 für Nebenantrieb / for PTO	(82)
2233 S 623.195 623.145	11.80 - 05.87	OM422A, 423		1882 342 134	420 GF420X			
				1878 002 878	420 10 420GTZ			
				3151 110 031	KZI-4,5			
		OM423		1888 042 009	380 GF2/380	623.145 enthält eine Kupplungsscheibe / This part number includes one clutch disc Sonderausführung / Special design	(67)	
				1878 000 968 ▽	380 10 380GTZ	623.145 Sonderausführung / Special design Lose Kupplungsscheibe / Loose clutch disc	(60) (41)	
				3151 108 031	KZI-4,5	623.145 Sonderausführung / Special design	(60)	
				1882 341 001	380 GF2/380	623.145 In 1888 enthalten / Contained in 1888 Sonderausführung / Special design	(31) (60)	
				1859 250 102	380 GF2/380	623.145 In 1888 enthalten / Contained in 1888 Sonderausführung / Special design	(31) (60)	
	1878 000 968 △	380 10 380GTZ	623.145 Sonderausführung / Special design In 1888 enthalten / Contained in 1888	(60) (31)				





















		CODE		 Parameter		
--	--	------	--	---	---	---

MERCEDES-BENZ











2235

2235,2235 L 648.413 648.063 648.463 648.012 648.038 648.013 2235 K 648.137 2235 S, 2235 LS 648.111 648.135 648.463	08.73 - 09.96	OM422A, 442A		1888 055 041	380 GF2/380	648.012-013/038/063/111/135/137/413/463 enthält eine Kupplungsscheibe / This part number includes one clutch disc	(67)
	03.86 - 07.89			1878 006 055 ▽	380 10 380GT	648.012-013/038/063/111/135/137/413/463 Lose Kupplungsscheibe / Loose clutch disc	(41)
	08.73 - 09.96			3151 108 031	KZI-4,5	648.012-013/038/063/111/135/137/413/463	
				1882 349 003	380 GF2/380	648.012-013/038/063/111/135/137/413/463 In 1888 enthalten / Contained in 1888	(31)
				1859 250 100	380 GF2/380	648.012-013/038/063/111/135/137/413/463 In 1888 enthalten / Contained in 1888	(31)
				1862 138 032 △#	380 10 380GSZ	648.012-013/038/063/111/135/137/413/463 In 1888 enthalten / Contained in 1888	(31)
				1888 063 137	380 GF2/380N	648.038 für Nebenantrieb / for PTO enthält eine Kupplungsscheibe / This part number includes one clutch disc	(82) (67)
				1862 304 033	380 10 380GV	648.038 für Nebenantrieb / for PTO	(82)
				3151 204 001	KZI-6	648.038 für Nebenantrieb / for PTO mit Schmierrohranschluss / with lubrication pipe connection	(82) (91)
				1882 346 131 #	420 GF420XN	648.137 für Nebenantrieb / for PTO	(82)
				1878 003 269	420 10 420GTZ	648.137 für Nebenantrieb / for PTO	(82)
				3151 204 001	KZI-6	648.137 für Nebenantrieb / for PTO mit Schmierrohranschluss / with lubrication pipe connection	(82) (91)

2236







2236 623.012 623.058 623.013 2236 S 623.135	09.82 - 03.91	OM422		1800 125 301	420 10 GF420				
	12.84 - 03.91				1882 301 239	420GTZ			
					1878 002 706	KZIS-4			
					3151 000 375				
				3482 124 534 ●	430 GMF430				
				OM422A, 423		1882 342 134	420 GF420X		
						1878 002 878	420 10 420GTZ		
						3151 110 031	KZI-4,5		
						1882 346 131 #	420 GF420XN	für Nebenantrieb / for PTO	(82)
						1878 002 706	420 10 420GTZ	für Nebenantrieb / for PTO	(82)
		3151 204 001	KZI-6		für Nebenantrieb / for PTO mit Schmierrohranschluss / with lubrication pipe connection	(82) (91)			
	OM423.908, OM423.905		3189 600 060						











2238





2238,2238 L 623.068 623.468 2238 S 623.190	08.73 - 09.96	OM422LA		1888 042 009	380 GF2/380	623.068/190/468 enthält eine Kupplungsscheibe / This part number includes one clutch disc	(67)	
	01.81 - 12.86				1878 000 968 ▽	380 10 380GTZ	623.068/190/468 Lose Kupplungsscheibe / Loose clutch disc	(41)
					3151 108 031	KZI-4,5	623.068/190/468	
					1882 341 001	380 GF2/380	623.068/190/468 In 1888 enthalten / Contained in 1888	(31)
					1859 250 102	380 GF2/380	623.068/190/468 In 1888 enthalten / Contained in 1888	(31)
					1878 000 968 △	380 10 380GTZ	623.068/190/468 In 1888 enthalten / Contained in 1888	(31)





		CODE				
--	--	------	--	---	---	---

MERCEDES-BENZ

2244							
2244,2244 L 648.073 648.473 2244 S 648.195	08.73 - 09.96	OM442LA		1888 055 247	380 GF2/380	enthält eine Kupplungsscheibe / This part number includes one clutch disc (67)	
	10.85 - 07.89			1862 123 131 ▽	380 10 380GV	Lose Kupplungsscheibe / Loose clutch disc (41)	
					3151 108 031	KZI-4,5	
					1882 349 003	380 GF2/380	In 1888 enthalten / Contained in 1888 (31)
					1859 250 100	380 GF2/380	In 1888 enthalten / Contained in 1888 (31)
					1862 122 132 △	380 10 380GVZ	In 1888 enthalten / Contained in 1888 (31)





2327						
2327 L 651.446 2327 L 651.446	12.87 - 09.96	OM445.926, OM401.973		3400 700 411	430 10 MFZ430	
	12.87 - 09.96			 3482 081 232  1878 080 033  3151 000 278	430WGTZ KZISZ-5	
				3189 600 059		
2327 L 654.446				3400 700 411	430 10 MFZ430	Chass. K 017132->
				 3482 081 232  1878 080 033  3151 000 278	430WGTZ KZISZ-5	
				3189 600 059		



2420						
2420,2420 L 653.411 653.012 653.011 653.014 653.414 654.413 653.412 654.411 2420,2420 L 653.411 653.414 653.014 653.412 653.011 654.413 654.411 653.012	12.87 - 09.96	OM356, 366LA		3400 125 001	350 10 GMF350X	
	12.87 - 09.96			 3482 000 953  1878 001 070  3151 000 374	350GTZ KZIS-4	



2422							
2422 653.038 653.036/037 2422 617.024 617.026 2422 617.026 617.024 2422 621.006 621.008 621.005 621.007 2422,2422 L 653.419 652.036 653.019 653.417 653.017 2422,2422 L 652.036 653.419 653.017 653.417 653.019 2422, 2422 L 652.438/439 652.036 2422, 2422 L 652.438 652.036 652.439 2422 B 653.074 653.076 2422 K 653.137/138 2422 K 621.107 2422 L 654.416-418 2422 L 656.009 2422 L 654.417/418 654.416	09.89 - 08.94	OM401LA, 441		3400 123 001	430 10 MFZ430	653.017/019/036-037-038/074/076/137-138/417 /419	
	08.73 - 09.96				 3482 081 232  1878 080 031  3151 000 549	430WGTZ KZISZ-5	654.416-417-418 656.009
	08.73 - 09.96				1862 225 132 #	400 10 400GTZ	653.017/019/036-037-038/074/076/137-138/417 /419
	10.81 - 10.90						654.416-417-418 656.009
	12.87 - 09.96						
	12.87 - 09.96						
	09.89 - 08.94						
	09.89 - 08.94						
	09.89 - 08.94						
	10.81 - 03.91						
	12.87 - 09.96						
	07.87 - 09.96						
	12.87 - 09.96						





		CODE				
--	--	------	--	---	---	---





MERCEDES-BENZ

2425						
2425 617.033	04.85 - 03.91	OM422		1882 302 135 #	380 GF380	617.033
				1878 000 105	380 10 380GTZ	617.033
				3151 000 375	KZIS-4	->Chass. 5107148 617.033
				3151 126 031	KZI-4,5	Chass. 5107149-> 617.033
		OM422.909		3189 600 060		

2426							
2426 652.047 652.046 2426 653.044 2426 B 653.077 653.079 2426, 2426 L 652.046 652.447 652.047 654.422 2426 L 652.447 652.446 2426 L 654.422 2426 L 654.422	12.87 - 09.96	OM441, 442		3400 124 101 ⊙ 3482 081 232 ⊙ 1878 005 668 ◦ 3151 000 549	430 10 MFZ430 430WGTZ KZISZ-5	652.046-047 653.044/077/079 654.418/422	
	01.90 - 08.94						
	02.90 - 08.94	OM442		1878 003 269	420 10 420GTZ	652.046-047 653.044/079 654.422 für Nebenantrieb / for PTO	(82)
	02.90 - 08.94						
	12.87 - 09.96				3151 166 031	KZI-6	652.046-047 653.044/079 654.422 für Nebenantrieb / for PTO



























2427						
2427 B 653.077 2427 B 653.077	02.90 - 08.94	OM401LA, 442		3400 124 101 ⊙ 3482 081 232 ⊙ 1878 005 668 ◦ 3151 000 549	430 10 MFZ430 430WGTZ KZISZ-5	653.077
	02.90 - 08.94					
2427 L 654.418	12.87 - 09.96	OM401LA, 442		3400 123 001 ⊙ 3482 081 232 ⊙ 1878 080 031 ◦ 3151 000 549	430 10 MFZ430 430WGTZ KZISZ-5	654.418 653.417
				1862 225 132 #	400 10 400GTZ	654.418

2428							
2428 621.016 621.015 621.017	08.73 - 09.96	OM422		1800 125 301 ⊙ 1882 301 239 ⊙ 1878 002 706 ◦ 3151 000 375	420 10 GF420 420GTZ KZIS-4	621.015-016-017/066/416/466	
				3482 124 534 ●	430 GMF430	621.015-016-017/066/416/466	
		OM422.905, OM422.911, OM422.913, OM422.916		1882 346 131 #	420 GF420XN	621.015-016-017/111-112-113 für Nebenantrieb / for PTO	(82)
				1878 634 014 ▲	420 10 420GSZ	621.015-016-017/111-112-113 für Nebenantrieb / for PTO	(82)
					3189 600 060		

2429						
2429 422.916 2429 652.043 652.045 2429 652.045 652.043 2429, 2429 L 656.416 656.016 656.015 655.418 656.018 655.416	07.87 - 09.96	OM422		1882 302 135 #	380 GF380	617.033
	12.87 - 09.96			1878 000 105	380 10 380GTZ	617.033
	12.87 - 09.96			3151 000 375	KZIS-4	->Chass. 5107148 617.033
	07.87 - 09.96			3151 126 031	KZI-4,5	Chass. 5107149-> 617.033
		OM442.925, OM442.906, OM442.923, OM442.908, OM442.916, OM442.909, OM442.907, OM422.916			3189 600 060	











		CODE				
--	--	------	--	---	---	---

























MERCEDES-BENZ

2429							
2429 658.032/033 2429 K 658.132 658.134	07.88 - 08.94	OM442		3400 124 101 ● 3482 081 232 ● 1878 005 668 ● 3151 000 549	430 10 MFZ430 430WGTZ KZISZ-5		
	07.88 - 08.94			3400 122 501 ● 3482 081 232 ● 1878 634 027 ● 3151 000 278	430 10 MFZ430 430WGTZ KZISZ-5		
		OM442.925, OM442.906, OM442.923, OM442.907		1888 063 137	380 GF2/380N	Nebenantriebs-ID / PTO ID: 4/125 enthält eine Kupplungsscheibe / This part number includes one clutch disc	(50) (67)
				1862 304 033 ▽	380 10 380GV	Nebenantriebs-ID / PTO ID: 4/125 Lose Kupplungsscheibe / Loose clutch disc	(50) (41)
				3151 166 031	KZI-6	Nebenantriebs-ID / PTO ID: 4/125	(50)
				1882 019 133	380 GF2/380N	In 1888 enthalten / Contained in 1888	(31)
				1859 250 101	380 GF2/380	In 1888 enthalten / Contained in 1888	(31)
				1862 305 033 △	380 10 380GVZ	In 1888 enthalten / Contained in 1888	(31)
				3189 600 059			
2429 656.018 656.015/016 656.416		OM442		3400 124 101 ● 3482 081 232 ● 1878 005 668 ● 3151 000 549	430 10 MFZ430 430WGTZ KZISZ-5	656.416	
				1878 003 269	420 10 420GTZ	652.043/045 Nebenantriebs-ID / PTO ID: 4/120	(50)
				3151 166 031	KZI-6	652.043/045 Nebenantriebs-ID / PTO ID: 4/120	(50)
		OM422, 442		3482 081 232	430 MFZ430	656.015-016/018	
				1878 005 668	430 10 430WGTZ	656.015-016/018	
				3151 000 278	KZISZ-5	656.015-016/018	
				1888 063 137	380 GF2/380N	Nebenantriebs-ID / PTO ID: 4/125 enthält eine Kupplungsscheibe / This part number includes one clutch disc	(50) (67)
				1862 304 033 ▽	380 10 380GV	Nebenantriebs-ID / PTO ID: 4/125 Lose Kupplungsscheibe / Loose clutch disc	(50) (41)
				3151 166 031	KZI-6	Nebenantriebs-ID / PTO ID: 4/125	(50)
				1882 019 133	380 GF2/380N	In 1888 enthalten / Contained in 1888	(31)
			1859 250 101	380 GF2/380	In 1888 enthalten / Contained in 1888	(31)	
			1862 305 033 △	380 10 380GVZ	In 1888 enthalten / Contained in 1888	(31)	
				3189 600 059			
2429,2429 L 658.001 658.006/007 658.009 658.408 658.407 658.008 2429 S 658.130 2429 S,2429 LS 657.105 657.505	07.87 - 09.96	OM442		3400 124 101 ● 3482 081 232 ● 1878 005 668 ● 3151 000 549	430 10 MFZ430 430WGTZ KZISZ-5		
	07.88 - 08.94			3400 122 501 ● 3482 081 232 ● 1878 634 027 ● 3151 000 278	430 10 MFZ430 430WGTZ KZISZ-5		
	07.87 - 09.96			3189 600 059			
		OM442.925, OM442.906, OM442.907		3189 600 059			

		CODE				
--	--	------	--	---	---	---

MERCEDES-BENZ



2431								
2431 652.096/097 652.095 2431 652.095 652.097 652.096 2431 652.096 652.095 652.097	12.87 - 09.96	OM401LA, 441LA		3400 124 001  3482 081 231  1878 634 027  3151 000 278	430 10 MFZ430 430WGTZ KZISZ-5	652.095-097		
	12.87 - 09.96							
	12.87 - 09.96	OM401.979, OM445.937, OM401.972, OM401.993, OM445.929		1888 063 137	380 GF2/380N	652.095-097 Nebenantriebs-ID / PTO ID: 4/125 enthält eine Kupplungsscheibe / This part number includes one clutch disc	(50) (67)	
					1862 304 033 ▽	380 10 380GV	652.095-097 Nebenantriebs-ID / PTO ID: 4/125 Lose Kupplungsscheibe / Loose clutch disc	(50) (41)
					3151 166 031	KZI-6	652.095-097 Nebenantriebs-ID / PTO ID: 4/125	(50)
					1882 019 133	380 GF2/380N	652.095-097 In 1888 enthalten / Contained in 1888	(31)
					1859 250 101	380 GF2/380	652.095-097 In 1888 enthalten / Contained in 1888	(31)
					1862 305 033 △	380 10 380GVZ	652.095-097 In 1888 enthalten / Contained in 1888	(31)
				3189 600 059				

2433								
2433 621.046/047 2433 623.023	11.80 - 03.91	OM422A, 423		1882 342 134	420 GF420X			
	10.80 - 09.96				1878 002 878	420 10 420GTZ		
					3151 110 031	KZI-4,5		
2433 654.422 623.023 623.408 621.046		OM441, 442		3400 124 101  3482 081 232  1878 005 668  3151 000 549	430 10 MFZ430 430WGTZ KZISZ-5	654.422		
		OM422A, 423		1882 342 134	420 GF420X	621.046 623.023		
				1878 002 878	420 10 420GTZ	621.046 623.023		
					3151 110 031	KZI-4,5	621.046 623.023	
			OM441		1878 087 141 ▲ ▽	380 10 380GT	623.408 Lose Kupplungsscheibe / Loose clutch disc	(41)
					3151 182 031 ▲	KZI-5	623.408	
		OM442		1878 003 269	420 10 420GTZ	654.422 Nebenantriebs-ID / PTO ID: 4/120	(50)	
				3151 166 031	KZI-6	654.422 Nebenantriebs-ID / PTO ID: 4/120	(50)	
2433,2433 L, 2434 L 653.061/062 653.475 652.067 653.463 653.064 652.467/468 653.461 652.466 653.063 653.464 653.462 2433 K 653.158 2433 S 652.163 652.136 2433 S,2433 LS 654.555 654.155	12.87 - 09.96	OM441LA		3400 124 001  3482 081 231  1878 634 027  3151 000 278	430 10 MFZ430 430WGTZ KZISZ-5			
	09.89 - 07.92	OM441.986, OM441.989, OM441.962, OM445.920,		1888 063 137	380 GF2/380N	653.158 für Nebenantrieb / for PTO enthält eine Kupplungsscheibe / This part number includes one clutch disc	(82) (67)	
	12.87 - 09.96	OM441.981, OM441.983, OM445.939, OM441.960		1862 304 033 ▽	380 10 380GV	653.158 für Nebenantrieb / for PTO Lose Kupplungsscheibe / Loose clutch disc	(82) (41)	
	12.87 - 09.96			3151 166 031	KZI-6	653.158 für Nebenantrieb / for PTO	(82)	
					1882 019 133	380 GF2/380N	653.158 In 1888 enthalten / Contained in 1888	(31)
					1859 250 101	380 GF2/380	653.158 In 1888 enthalten / Contained in 1888	(31)
					1862 305 033 △	380 10 380GVZ	653.158 In 1888 enthalten / Contained in 1888	(31)
					3189 600 059			

		CODE				
--	--	------	--	---	---	---

MERCEDES-BENZ









2433

2433 L 654.422	12.87 - 09.96	OM441, 442		3400 124 101 ⊗ 3482 081 232 ⊗ 1878 005 668 ⊕ 3151 000 549	430 10 MFZ430 430WGTZ KZISZ-5	654.422	
2433 L 654.422	12.87 - 09.96	OM442		1878 003 269	420 10 420GTZ	654.422 Nebenantriebs-ID / PTO ID: 4/120	(50)
				3151 166 031	KZI-6	654.422 Nebenantriebs-ID / PTO ID: 4/120	(50)







2434

2434 L 658.408	07.87 - 09.96	OM441LA		3400 124 101 ⊗ 3482 081 232 ⊗ 1878 005 668 ⊕ 3151 000 549	430 10 MFZ430 430WGTZ KZISZ-5	658.408	
--------------------------	---------------	---------	---	---	---	---------	--







2435

2435 655.426 656.025 656.327 656.026 656.074 655.026 656.076	07.87 - 09.96	OM442A		3400 122 601 ⊗ 3482 081 231 ⊗ 1878 080 037 ⊕ 3151 000 278	430 10 MFZ430 430WGTZ KZISZ-5		
2435 658.014-016 658.038 658.116 658.137 658.139 658.012 658.017 658.019 658.013 658.018 658.063	07.88 - 08.94	OM442.964, OM442.966, OM442.976,		1888 063 137	380 GF2/380N	für / for: SA32910-01 Nebenantriebs-ID / PTO ID: 4/125 enthält eine Kupplungsscheibe / This part number includes one clutch disc	(69) (50) (67)
2435,2435 L 658.063 658.413 658.463 658.012/013	07.87 - 09.96	OM440.942, OM442.962,		1862 304 033 ▽	380 10 380GV	für / for: SA32910-01 Nebenantriebs-ID / PTO ID: 4/125 Lose Kupplungsscheibe / Loose clutch disc	(69) (50) (41)
2435 K 658.139 658.137	07.88 - 08.94	OM442.963, OM442.944,		3151 166 031	KZI-6	für / for: SA32910-01 Nebenantriebs-ID / PTO ID: 4/125	(69) (50)
2435 LS 658.463	07.87 - 09.96	OM442.978, OM440.940,		1882 019 133	380 GF2/380N	für / for: SA32910-01 In 1888 enthalten / Contained in 1888	(69) (31)
2435 S 658.135	07.88 - 08.94	OM442.943, OM442.965,		1859 250 101	380 GF2/380	für / for: SA32910-01 In 1888 enthalten / Contained in 1888	(69) (31)
2435 S,2435 LS 658.116 657.510 657.560 657.110	07.87 - 09.96	OM440.941, OM442.942		1862 305 033 △	380 10 380GVZ	für / for: SA32910-01 In 1888 enthalten / Contained in 1888	(69) (31)
2435 S,2435 LS 658.116 657.110 657.560 657.510	07.87 - 09.96			3189 600 059			

2438







2438 623.068	08.73 - 09.96	OM422LA		1888 042 009	380 GF2/380	enthält eine Kupplungsscheibe / This part number includes one clutch disc	(67)
2438 L 621.085	11.80 - 06.90			1878 000 968 ▽	380 10 380GTZ	Lose Kupplungsscheibe / Loose clutch disc	(41)
				3151 108 031	KZI-4,5		
				1882 341 001	380 GF2/380	In 1888 enthalten / Contained in 1888	(31)
				1859 250 102	380 GF2/380	In 1888 enthalten / Contained in 1888	(31)
				1878 000 968 △	380 10 380GTZ	In 1888 enthalten / Contained in 1888	(31)

2444







2444 LS 645.593	08.73 - 09.96	OM422LA		1888 042 009	380 GF2/380	enthält eine Kupplungsscheibe / This part number includes one clutch disc	(67)
2444 LS 646.593	08.73 - 09.96			1878 000 968 ▽	380 10 380GTZ	Lose Kupplungsscheibe / Loose clutch disc	(41)
				3151 108 031	KZI-4,5		
				1882 341 001	380 GF2/380	In 1888 enthalten / Contained in 1888	(31)
				1859 250 102	380 GF2/380	In 1888 enthalten / Contained in 1888	(31)
				1878 000 968 △	380 10 380GTZ	In 1888 enthalten / Contained in 1888	(31)

		CODE				
--	--	------	--	---	---	---

MERCEDES-BENZ









































2448							
2448 658.195 2448,2448 L 658.473 658.070/071 658.073 2448 LS 657.585 658.195 658.473 657.510 2448 S 658.195	07.88 - 07.92	OM442LA		3400 121 601 ⊗ 3488 017 432 ⊗ 1878 634 022 ⊙ 3151 000 547	400 10 MFZ2/400X 400GVZ KZISZ-5	->Chass. K011863	
	07.87 - 09.96						
	07.88 - 07.92			3400 122 901 ⊗ 3482 081 233 ⊗ 1878 002 735 ⊙ 3151 000 278	430 10 MFZ430 430GTZ KZISZ-5	Chass. K011864->	
	07.88 - 07.92			3400 121 601 ⊗ 3488 017 432 ⊗ 1878 634 022 ⊙ 3151 000 547	400 10 MFZ2/400X 400GVZ KZISZ-5	für / for: SA33613-03 Sonderausführung / Special design	(69) (60)
		OM442.984, OM442.985, OM442.992, OM442.989		3189 600 059			
2448 L 657.510	01.88 -	OM442		3400 122 601 ⊗ 3482 081 231 ⊗ 1878 080 037 ⊙ 3151 000 278	430 10 MFZ430 430WGTZ KZISZ-5		
				3189 600 059			
2448 LS 655.593	01.88 -	OM442LA		3400 121 601 ⊗ 3488 017 432 ⊗ 1878 634 022 ⊙ 3151 000 547	400 10 MFZ2/400X 400GVZ KZISZ-5	für Ausrückgabel mit Rollen / for release fork with rollers	(71)



2522							
2522 L 654.417	12.87 - 09.96	OM441		3400 123 001 ⊗ 3482 081 232 ⊗ 1878 080 031 ⊙ 3151 000 549	430 10 MFZ430 430WGTZ KZISZ-5	654.417	
2522 L 654.417	12.87 - 09.96						

2524							
2524 653.036 653.033 653.031/032	06.92 - 09.96	OM401LA, 441LA		3400 700 411 ⊗ 3482 081 232 ⊗ 1878 080 033 ⊙ 3151 000 278	430 10 MFZ430 430WGTZ KZISZ-5	653.128/148/022/024/031-033/047/049/070/072	
2524 653.031-033	01.94 - 09.96						
2524 K 653.128	06.92 - 09.96	OM401.975, OM445.924		3189 600 059			
2524 K 653.128	01.94 - 09.96						
2524 653.042 653.050-054 653.040		OM401LA, 441LA		3400 124 001 ⊗ 3482 081 231 ⊗ 1878 634 027 ⊙ 3151 000 278	430 10 MFZ430 430WGTZ KZISZ-5		
				3189 600 059			
2524 L 652.405 653.417 652.409	12.87 - 09.96	OM401LA, 441LA		3400 123 001 ⊗ 3482 081 232 ⊗ 1878 080 031 ⊙ 3151 000 549	430 10 MFZ430 430WGTZ KZISZ-5	653.036/417 654.416-418	
2524 L 652.409 652.405	12.87 - 09.96						
2524,2524 L 654.428 653.022 654.417/418 653.024 653.429 654.426/427 653.427 654.416	12.87 - 09.96			3400 700 411 ⊗ 3482 081 232 ⊗ 1878 080 033 ⊙ 3151 000 278	430 10 MFZ430 430WGTZ KZISZ-5	653.128/148/022/024/031-033/047/049/070/072 652.405/409 653.427/429 654.426-428	
2524,2524 L 653.024 653.429 654.428 654.416 653.022 654.427 653.427 654.418 654.417 654.426	12.87 - 09.96	OM401.975, OM445.938, OM445.941, OM445.924, OM401.973		3189 600 059			
2524,2524 L 653.429 654.426 653.024 654.416 654.427 653.022 653.427 654.417/418 654.428	12.87 - 09.96						
2524,2524 L 654.427 653.022 654.417 653.429 654.418 653.024 653.427 654.428 654.416 654.426	12.87 - 09.96						

		CODE				
--	--	------	--	---	---	---



MERCEDES-BENZ











2527								
2527 653.049 653.047 652.055 2527 654.433 653.049 653.148 653.022 653.047 652.055 653.427 654.432 2527 B 653.072 653.070 2527 B 653.072 653.070 2527 K 653.148 2527 K 653.148 2527 L 652.455 652.458 653.427 652.457 654.433 654.432 653.429	10.93 - 09.96	OM401LA, 441LA		3400 700 411  3482 081 232  1878 080 033  3151 000 278	430 10 MFZ430 430WGTZ KZISZ-5	653.022/047/049/070/072/148/427-428		
	01.94 - 09.96							
	03.91 - 09.96	OM445.927, OM401.980, OM401.978,		1888 063 137	380 GF2/380N	653.047/049/148 652.055 für Nebenantrieb / for PTO enthält eine Kupplungsscheibe / This part number includes one clutch disc	(82) (67)	
	01.94 - 09.96	OM445.936, OM445.926, OM401.973, OM445.929, OM445.940			1862 304 033 ▽	380 10 380GV	653.047/049/148 652.055 für Nebenantrieb / for PTO Lose Kupplungsscheibe / Loose clutch disc	(82) (41)
	10.93 - 09.96				3151 166 031	KZI-6	653.047/049/148 652.055 für Nebenantrieb / for PTO	(82)
	01.94 - 09.96				1882 019 133	380 GF2/380N	653.047/049/148 652.055 für Nebenantrieb / for PTO In 1888 enthalten / Contained in 1888	(82) (31)
					1859 250 101	380 GF2/380	653.047/049/148 652.055 In 1888 enthalten / Contained in 1888	(31)
					1862 305 033 △	380 10 380GVZ	653.047/049/148 652.055 In 1888 enthalten / Contained in 1888	(31)
					3189 600 059			
	2527 L 652.458 654.422 652.457 654.426/427 652.455		OM401LA, 441LA		3400 700 411  3482 081 232  1878 080 033  3151 000 278	430 10 MFZ430 430WGTZ KZISZ-5	652.455/457-458 654.426-427	
		OM401LA, 442		3400 124 101  3482 081 232  1878 005 668  3151 000 549	430 10 MFZ430 430WGTZ KZISZ-5	654.422		
					3189 600 059			
2527 L 654.422		OM401LA, 442A		1878 003 269	420 10 420GTZ	Nebenantriebs-ID / PTO ID: 4/120	(50)	
				3151 166 031	KZI-6	Nebenantriebs-ID / PTO ID: 4/120	(50)	
2527 L 654.416 654.433 654.417 654.432 654.418 654.426/427 653.419 653.417 653.427	09.92 - 09.96	OM401LA, 441, 442		3400 123 001  3482 081 232  1878 080 031  3151 000 549	430 10 MFZ430 430WGTZ KZISZ-5	653.417/419 654.416-418		
		OM401LA		3400 700 411  3482 081 232  1878 080 033  3151 000 278	430 10 MFZ430 430WGTZ KZISZ-5	654.432-433		
		OM401.977, OM401.979, OM401.973		3189 600 059				
2527 L 654.418	03.91 - 08.94	OM401LA, 441, 442		3400 123 001  3482 081 232  1878 080 031  3151 000 549	430 10 MFZ430 430WGTZ KZISZ-5	653.417/419 654.416-418		
2527 L 652.455 652.458 652.457 2527 L 652.457 652.455 652.458	12.87 - 09.96	OM401LA, 441LA		3400 700 411  3482 081 232  1878 080 033  3151 000 278	430 10 MFZ430 430WGTZ KZISZ-5	652.455/457-458		
	12.87 - 09.96	OM401.977, OM445.936, OM445.926, OM401.991, OM401.973		3189 600 059				

2528							
2528 A 621.214/215	01.80 - 03.91	OM422.907, OM422.911, OM422.916		1878 003 269	420 10 420GTZ	621.214 für Nebenantrieb / for PTO	(82)
				3151 204 001	KZI-6	621.214 für Nebenantrieb / for PTO mit Schmierrohranschluss / with lubrication pipe connection	(82) (91)

		CODE				
--	--	------	--	---	---	---



MERCEDES-BENZ



2528						
2528 AK 621.312 621.316/317	01.80 - 03.91	OM422.907, OM422.911, OM422.913, OM422.916	 1882 346 131 #	420 GF420XN	621.312 für Nebenantrieb / for PTO	(82)
			 1878 003 269	420 10 420GTZ	621.312 für Nebenantrieb / for PTO	(82)
			 3151 204 001	KZI-6	621.312 für Nebenantrieb / for PTO mit Schmierrohranschluss / with lubrication pipe connection	(82) (91)















2529						
2529 656.215		OM443A	 3482 081 232	430 MFZ430		
			 1878 005 668	430 10 430WGTZ		
			 3151 000 278	KZISZ-5		
		 1888 063 137	380 GF2/380N	Nebenantriebs-ID / PTO ID: 4/125 enthält eine Kupplungsscheibe / This part number includes one clutch disc	(50) (67)	
		 1862 304 033 ▽	380 10 380GV	Nebenantriebs-ID / PTO ID: 4/125 Lose Kupplungsscheibe / Loose clutch disc	(50) (41)	
		 3151 166 031	KZI-6	Nebenantriebs-ID / PTO ID: 4/125	(50)	
		 1882 019 133	380 GF2/380N	In 1888 enthalten / Contained in 1888	(31)	
		 1859 250 101	380 GF2/380	In 1888 enthalten / Contained in 1888	(31)	
		 1862 305 033 △	380 10 380GVZ	In 1888 enthalten / Contained in 1888	(31)	
 3189 600 059						

		CODE				
--	--	------	--	---	---	---





















MERCEDES-BENZ

2535						
2535 L 658.038		OM442A		3400 122 601 ⊗ 3482 081 231 ⊗ 1878 080 037 ⊙ 3151 000 278	430 10 MFZ430 430WGTZ KZISZ-5	
				3189 600 059		

2536						
2536 AK 621.327 2536 AK 621.327	10.81 - 03.91	OM442.950, OM442.962,		1882 346 131 #	420 GF420XN	621.327 für Nebenantrieb / for PTO (82)
	10.81 - 03.91	OM423.905, OM442.952, OM423.907		1878 002 706	420 10 420GTZ	621.327 für Nebenantrieb / for PTO (82)
				3151 204 001	KZI-6	621.327 für Nebenantrieb / for PTO mit Schmierrohranschluss / with lubrication pipe connection (82) (91)



2538							
2538 658.043 658.146 2538 658.029 2538 658.043 658.146 2538 658.043 2538 658.043 2538,2538 L 658.021 658.023/024 658.078 658.418 658.468/469 658.149 658.419 658.026/027 658.029 658.466 658.022 658.079 658.028 658.416 2538,2538 L 658.024 658.029 658.418 658.021 658.419 658.022 658.028 658.026 658.078/079 658.416 658.023 658.027 658.149 2538,2538 L 658.416 658.466 658.469 658.022 658.079 658.029 658.026/027 658.418/419 658.024 658.076 658.468 658.021 658.028 658.078 658.149 658.023 2538 K, 2538 LK 658.149 658.147 2538 K, 2538 LK 658.147 658.149 2538 K, 2538 LK 658.147 658.149 2538 K, 2538 LK 658.149 658.147 2538 S 658.146 2538 S,2538 LS 657.520 658.146 657.570 2538 S,2538 LS 657.520 657.120 657.570 658.146 2538 S,2538 LS 658.146 657.570	03.91 - 09.96	OM402LA, 423, 442LA		3400 122 601 ⊗ 3482 081 231 ⊗ 1878 080 037 ⊙ 3151 000 278	430 10 MFZ430 430WGTZ KZISZ-5		
		03.91 - 09.96			3400 121 601 HD ⊗ 3488 017 432 ⊗ 1878 634 022 ⊙ 3151 000 547	400 10 MFZ2/400X 400GVZ KZISZ-5	für Fahrzeuge mit Zweischeibenkupplung / for vehicles with double disc clutch (77)
		01.94 - 09.96			3400 122 901 ⊗ 3482 081 233 ⊗ 1878 002 735 ⊙ 3151 000 278	430 10 MFZ430 430GTZ KZISZ-5	für / for: SA033617-01 (69)
		03.91 - 09.96			1888 063 137	380 GF2/380N	für Nebenantrieb / for PTO enthält eine Kupplungsscheibe / This part number includes one clutch disc (82) (67)
		07.87 - 09.96	OM440.971, OM440.970, OM402.971, OM402.975, OM440.978, OM440.981, OM446.925, OM402.985, OM442.997, OM440.980, OM402.986, OM402.989, OM446.924, OM442.989, OM402.972		1862 304 033 ▽	380 10 380GV	für Nebenantrieb / for PTO Lose Kupplungsscheibe / Loose clutch disc (82) (41)
		07.87 - 09.96			3151 166 031	KZI-6	für Nebenantrieb / for PTO (82)
		07.87 - 09.96			1882 019 133	380 GF2/380N	In 1888 enthalten / Contained in 1888 (31)
		03.91 - 09.96			1859 250 101	380 GF2/380	In 1888 enthalten / Contained in 1888 (31)
		01.94 - 09.96			1862 305 033 △	380 10 380GVZ	In 1888 enthalten / Contained in 1888 (31)
		03.91 - 09.96			3189 600 059		
		03.91 - 09.96			3189 600 059		
		03.91 - 09.96	OM402LA, 423, 442LA		3400 122 601 ⊗ 3482 081 231 ⊗ 1878 080 037 ⊙ 3151 000 278	430 10 MFZ430 430WGTZ KZISZ-5	
		07.87 - 09.96			3400 122 901 ⊗ 3482 081 233 ⊗ 1878 002 735 ⊙ 3151 000 278	430 10 MFZ430 430GTZ KZISZ-5	für / for: SA033617-01 (69)
		07.87 - 09.96			3400 121 601 HD ⊗ 3488 017 432 ⊗ 1878 634 022 ⊙ 3151 000 547	400 10 MFZ2/400X 400GVZ KZISZ-5	für Fahrzeuge mit Zweischeibenkupplung / for vehicles with double disc clutch (77)
			OM440.971, OM440.970, OM402.971, OM402.975, OM402.990, OM440.978, OM440.981, OM446.928, OM446.925, OM402.985, OM446.942, OM440.980, OM446.929, OM402.986, OM402.989,		3189 600 059		





















MERCEDES-BENZ

2544								
2544, 2544 L 655.093 658.418/419	01.92 - 09.96	OM442LA		3400 121 601 Ⓢ 3488 017 432 Ⓢ 1878 634 022 Ⓢ 3151 000 547	400 10 MFZ2/400X 400GVZ KZISZ-5	->Chass. K011863		
				3400 122 901 Ⓢ 3482 081 233 Ⓢ 1878 002 735 Ⓢ 3151 000 278	430 10 MFZ430 430GTZ KZISZ-5	Chass. K011864->		
		OM440.970, OM440.978, OM446.922		3189 600 059				
2544 658.146 2544 LS 657.570 2544 S 658.135	01.94 - 09.96	OM440.970, OM440.978, OM446.942		3400 122 601 Ⓢ 3482 081 231 Ⓢ 1878 080 037 Ⓢ 3151 000 278	430 10 MFZ430 430WGTZ KZISZ-5			
	01.92 - 09.96				3400 122 901 Ⓢ 3482 081 233 Ⓢ 1878 002 735 Ⓢ 3151 000 278	430 10 MFZ430 430GTZ KZISZ-5	für / for: SA033617-01	
	07.88 - 08.94				3189 600 059		(69)	
2544,2544 L 658.032 658.053 655.337 658.050 658.054 658.029 658.051 658.418 658.470/471 658.419	07.87 - 09.96	OM440, 442LA		3400 121 601 Ⓢ 3488 017 432 Ⓢ 1878 634 022 Ⓢ 3151 000 547	400 10 MFZ2/400X 400GVZ KZISZ-5	->Chass. K011863 658.050-051/053-054/190/470 655.591 657.580		
				3400 122 901 Ⓢ 3482 081 233 Ⓢ 1878 002 735 Ⓢ 3151 000 278	430 10 MFZ430 430GTZ KZISZ-5	Chass. K011864-> 658.050-051/053-054/190/470-471 655.591 657.580		
				OM440.970, OM440.978, OM446.922		3483 023 032 ⊕	445 GMFZ445W	655.337 für Fahrzeuge mit Wandlerschaltkupplung / for vehicles with converter and clutch unit
						1878 003 780	445 24 445GTZ	655.337 für Fahrzeuge mit Wandlerschaltkupplung / for vehicles with converter and clutch unit
						3189 600 059		
2544 A,K,L,S,LS		OM440, 442A, LA		3400 122 601 Ⓢ 3482 081 231 Ⓢ 1878 080 037 Ⓢ 3151 000 278	430 10 MFZ430 430WGTZ KZISZ-5	655.138/337/436-437 658.029/043/135/146-147/419 656.327 657.570		
				3400 122 901 Ⓢ 3482 081 233 Ⓢ 1878 002 735 Ⓢ 3151 000 278	430 10 MFZ430 430GTZ KZISZ-5	für / for: SA033617-01 655.138/337/436-437 658.029/043/135/146-147/419 657.570		
				OM442LA		3400 124 101 Ⓢ 3482 081 232 Ⓢ 1878 005 668 Ⓢ 3151 000 549	430 10 MFZ430 430WGTZ KZISZ-5	658.032
						1888 063 137	380 GF2/380N	655.138/337/436-437 658.029/043 656.327 Nebenantriebs-ID / PTO ID: 4/125 enthält eine Kupplungsscheibe / This part number includes one clutch disc
						1862 304 033 ▽	380 10 380GV	655.138/337/436-437 658.029/043 656.327 Nebenantriebs-ID / PTO ID: 4/125 Lose Kupplungsscheibe / Loose clutch disc
						3151 166 031	KZI-6	655.138/337/436-437 658.029/043 656.327 Nebenantriebs-ID / PTO ID: 4/125
						1882 019 133	380 GF2/380N	655.138/337/436-437 658.029/043 656.327 In 1888 enthalten / Contained in 1888
						1859 250 101	380 GF2/380	655.138/337/436-437 658.029/043 656.327 In 1888 enthalten / Contained in 1888
						1862 305 033 △	380 10 380GVZ	655.138/337/436-437 658.029/043 656.327 In 1888 enthalten / Contained in 1888
						3189 600 059		(31)















		CODE				
--	--	------	--	---	---	---







MERCEDES-BENZ

2544						
2544 S, LS 658.190 657.580 655.591	01.92 - 09.96	OM440, 442LA		3400 121 601 ● 3488 017 432 ● 1878 634 022 ● 3151 000 547	400 10 MFZ2/400X 400GVZ KZISZ-5	->Chass. K011863 658.050-051/053-054/190/470 655.591 657.580
				3400 122 901 ● 3482 081 233 ● 1878 002 735 ● 3151 000 278	430 10 MFZ430 430GTZ KZISZ-5	Chass. K011864-> 658.050-051/053-054/190/470-471 655.591 657.580
		OM440.970, OM440.972, OM446.922		3189 600 059		

2550							
2550 658.043 658.147 658.149 656.327 656.028		OM402LA, 423, 442A, LA		3400 122 601 ● 3482 081 231 ● 1878 080 037 ● 3151 000 278	430 10 MFZ430 430WGTZ KZISZ-5	656.028/327 658.043/147/149	
				3400 122 901 ● 3482 081 233 ● 1878 002 735 ● 3151 000 278	430 10 MFZ430 430GTZ KZISZ-5	für / for: SA033617-01 658.043/147/149	(69)
				1888 063 137	380 GF2/380N	656.028/327 658.043 Nebenantriebs-ID / PTO ID: 4/125 enthält eine Kupplungsscheibe / This part number includes one clutch disc	(50) (67)
				1862 304 033 ▽	380 10 380GV	656.028/327 658.043 Nebenantriebs-ID / PTO ID: 4/125 Lose Kupplungsscheibe / Loose clutch disc	(50) (41)
				3151 166 031	KZI-6	656.028/327 658.043 Nebenantriebs-ID / PTO ID: 4/125	(50)
				1882 019 133	380 GF2/380N	656.028/327 658.043 In 1888 enthalten / Contained in 1888	(31)
				1859 250 101	380 GF2/380	656.028/327 658.043 In 1888 enthalten / Contained in 1888	(31)
				1862 305 033 △	380 10 380GVZ	656.028/327 658.043 In 1888 enthalten / Contained in 1888	(31)
				3189 600 059			
		2550 656.028	07.87 - 09.96	OM442.997, OM442.989		3400 122 601 ● 3482 081 231 ● 1878 080 037 ● 3151 000 278	430 10 MFZ430 430WGTZ KZISZ-5
	1888 063 137				380 GF2/380N	Nebenantriebs-ID / PTO ID: 4/125 enthält eine Kupplungsscheibe / This part number includes one clutch disc	(50) (67)
	1862 304 033 ▽				380 10 380GV	Nebenantriebs-ID / PTO ID: 4/125 Lose Kupplungsscheibe / Loose clutch disc	(50) (41)
	3151 166 031				KZI-6	Nebenantriebs-ID / PTO ID: 4/125	(50)
	1882 019 133				380 GF2/380N	In 1888 enthalten / Contained in 1888	(31)
	1859 250 101				380 GF2/380	In 1888 enthalten / Contained in 1888	(31)
	1862 305 033 △				380 10 380GVZ	In 1888 enthalten / Contained in 1888	(31)
		3189 600 059					
2550 658.195	01.91 - 09.96	OM442LA		3400 121 601 ● 3488 017 432 ● 1878 634 022 ● 3151 000 547	400 10 MFZ2/400X 400GVZ KZISZ-5	->Chass. K011863	
				3400 122 901 ● 3482 081 233 ● 1878 002 735 ● 3151 000 278	430 10 MFZ430 430GTZ KZISZ-5	Chass. K011864->	
				3400 121 601 ● 3488 017 432 ● 1878 634 022 ● 3151 000 547	400 10 MFZ2/400X 400GVZ KZISZ-5	für / for: SA33613-03 Sonderausführung / Special design	(69) (60)
		OM440.971, OM440.973		3189 600 059			



MERCEDES-BENZ



2550									
2550,2550 L 658.074 655.496 658.073 658.071 658.070 658.474 658.473	07.87 - 09.96	OM442LA		3400 121 601 ⚙ 3488 017 432 ⚙ 1878 634 022 ⚙ 3151 000 547	400 10 MFZ2/400X 400GVZ KZISZ-5	->Chass. K011863			
				3400 122 901 ⚙ 3482 081 233 ⚙ 1878 002 735 ⚙ 3151 000 278	430 10 MFZ430 430GTZ KZISZ-5	Chass. K011864->			
				3400 121 601 ⚙ 3488 017 432 ⚙ 1878 634 022 ⚙ 3151 000 547	400 10 MFZ2/400X 400GVZ KZISZ-5	für / for: SA33613-03 Sonderausführung / Special design	(69) (60)		
				OM440.971, OM440.973, OM442.998, OM442.997, OM446.920		1888 063 137	380 GF2/380N	656.028/327 658.043 Nebenantriebs-ID / PTO ID: 4/125 enthält eine Kupplungsscheibe / This part number includes one clutch disc	(50) (67)
						1862 304 033 ▽	380 10 380GV	656.028/327 658.043 Nebenantriebs-ID / PTO ID: 4/125 Lose Kupplungsscheibe / Loose clutch disc	(50) (41)
						3151 166 031	KZI-6	656.028/327 658.043 Nebenantriebs-ID / PTO ID: 4/125	(50)
						1882 019 133	380 GF2/380N	656.028/327 658.043 In 1888 enthalten / Contained in 1888	(31)
						1859 250 101	380 GF2/380	656.028/327 658.043 In 1888 enthalten / Contained in 1888	(31)
						1862 305 033 △	380 10 380GVZ	656.028/327 658.043 In 1888 enthalten / Contained in 1888	(31)
						3189 600 059			
2550 K 658.147 658.149	07.87 - 09.96	OM440.971, OM440.981, OM442.997, OM442.989		3400 122 601 ⚙ 3482 081 231 ⚙ 1878 080 037 ⚙ 3151 000 278	430 10 MFZ430 430WGTZ KZISZ-5				
				3400 122 901 ⚙ 3482 081 233 ⚙ 1878 002 735 ⚙ 3151 000 278	430 10 MFZ430 430GTZ KZISZ-5				
				3189 600 059					
2550 S, 2550 LS 657.585 658.195	01.91 - 09.96	OM442LA		3400 121 601 ⚙ 3488 017 432 ⚙ 1878 634 022 ⚙ 3151 000 547	400 10 MFZ2/400X 400GVZ KZISZ-5	für / for: SA33613/03	(69)		



2553							
2553,2553 L 658.070 658.474 658.074 658.027 658.073 658.071 2553 S, 2553 LS 655.593 658.195	07.87 - 09.96	OM442LA		3400 121 601 ⚙ 3488 017 432 ⚙ 1878 634 022 ⚙ 3151 000 547	400 10 MFZ2/400X 400GVZ KZISZ-5	->Chass. K011863	
				3400 122 901 ⚙ 3482 081 233 ⚙ 1878 002 735 ⚙ 3151 000 278	430 10 MFZ430 430GTZ KZISZ-5	Chass. K011864->	
				3400 121 601 ⚙ 3488 017 432 ⚙ 1878 634 022 ⚙ 3151 000 547	400 10 MFZ2/400X 400GVZ KZISZ-5	für / for: SA33613-03 Sonderausführung / Special design	(69) (60)
			OM446.920		3189 600 059		
2553 K 658.149 658.027		OM402LA, 423, 442LA		3400 122 601 ⚙ 3482 081 231 ⚙ 1878 080 037 ⚙ 3151 000 278	430 10 MFZ430 430WGTZ KZISZ-5		
				3400 122 901 ⚙ 3482 081 233 ⚙ 1878 002 735 ⚙ 3151 000 278	430 10 MFZ430 430GTZ KZISZ-5	für / for: SA033617-01	(69)
						3189 600 059	













		CODE				
--	--	------	--	---	---	---









MERCEDES-BENZ

2553						
2553 LS 655.593		OM442LA		3400 121 601 ⊗ 3488 017 432 ⊗ 1878 634 022 ⊙ 3151 000 547	400 10 MFZ2/400X 400GVZ KZISZ-5	->Chass. K011863
				3400 122 901 ⊗ 3482 081 233 ⊗ 1878 002 735 ⊙ 3151 000 278	430 10 MFZ430 430GTZ KZISZ-5	Chass. K011864->
				3189 600 059		

2620						
2620 L,LA,LB,LAB 343.		OM346		1882 166 737	380 GF380	
				1878 000 104	380 10 380GTZ	
				3151 000 529	KZIS-4	











2623						
L,LA,LB,LAB,LH,LP 2623 343.		OM355		1882 166 737	380 GF380	
				1878 000 104	380 10 380GTZ	
				3151 000 529	KZIS-4	











2624						
L,LA,LB,LK,LS 2624 343.114 343.303 343.103 343.334 343.314 343.104 343.101 343.134 343.301 343.304 LAB,LAK,LAS 2624 343.103 343.134 343.101 343.314 343.304 343.114 343.303 343.334 343.301 343.104		OM355		1882 166 737	380 GF380	343.301/303-304/314/334/101/103-104/114/134
				1878 000 104	380 10 380GTZ	343.301/303-304/314/334/101/103-104/114/134
				3151 000 529	KZIS-4	343.301/303-304/314/334/101/103-104/114/134
L,LK,LS 2624 343.014 343.004 343.003 343.001		OM355		1882 302 131	380 GF380	343.001/003-004/014
				1878 000 105	380 10 380GTZ	343.001/003-004/014
				3151 000 392	KZIS-4	343.001/003-004/014
L 2624 343.001 LA 2624 343.101 LAK 2624 343.104 343.103 LAS 2624 343.114 LAB 2624 343.134 LB 2624 343.334 LK 2624 343.303/304 343.003/004 LS 2624 343.314 343.014		OM355		1882 302 131	380 GF380	343.001/003-004/014
				1878 000 105	380 10 380GTZ	343.001/003-004/014
				3151 000 392	KZIS-4	343.001/003-004/014
				1882 166 737	380 GF380	343.301/303-304/314/334/101/103-104/114/134
				1878 000 104	380 10 380GTZ	343.301/303-304/314/334/101/103-104/114/134
				3151 000 529	KZIS-4	343.301/303-304/314/334/101/103-104/114/134

2626								
2626 395.316 395.315 2626 A 395.415 2626 AK 395.443/444 395.442 2626 AS 395.412 2626 K 395.342 395.344 2626 S 395.312	06.75-03.81	OM402		1882 302 131	380 GF380			
				1878 000 105	380 10 380GTZ			
				3482 124 541	430 GMF430			
				1882 301 238 ●#	420 GF420			
				1878 001 136	420 10 420GTZ			
				3151 000 375	KZIS-4			
				1861 643 134 #	420 10 420GSZ	für Nebenantrieb / for PTO (82)		
				3189 600 060				
					OM402.906,			

		CODE				
--	--	------	--	---	---	---





















MERCEDES-BENZ

2626							
2626 AB 395.472 2626 B 395.372	05.74 - 12.80	OM402		1882 302 131	380 GF380	->Chass. 4372223	
	05.74 - 12.80			1878 000 105	380 10 380GTZ	->Chass. 4372223	
				3151 000 375	KZIS-4	->Chass. 4372223	
				3482 124 541	430 GMF430	Chass. 4372224->	
				1882 301 238 ●#	420 GF420	Chass. 4372224->	
				1878 001 136	420 10 420GTZ	Chass. 4372224->	
				3151 000 375	KZIS-4	Chass. 4372224->	
				1861 643 134 #	420 10 420GSZ	für Nebenantrieb / for PTO	(82)
				3189 600 060			
	OM402.906, OM402.912, OM402.926						

2628							
2628 624.033 623.007 624.032 623.009 2628 A 624.233 624.203 624.232 2628 AS 624.331 2628 B 624.030 2628 K 624.134 624.132 2628 S 624.131	02.80 - 03.91	OM422		1800 125 301	420 10 GF420	623.007/009 624.030/032-033/131-132/134/232-233/331	
	02.80 - 03.91			1882 301 239	420GTZ		
				1878 002 706	KZIS-4		
				3151 000 375			
				3482 124 534 ●	430 GMF430	623.007/009 624.030/032-033/131-132/134/232-233/331	
				1882 346 131 #	420 GF420XN	623.007 624.030/032-033/131-132/134/232-233/331/333 /334 für Nebenantrieb / for PTO	(82)
				1878 003 269	420 10 420GTZ	623.007 624.030/032-033/131-132/134/232-233/331/333 /334 für Nebenantrieb / for PTO	(82)
			3151 204 001	KZI-6	623.007 624.030/032-033/131-132/134/232-233/331/333 /334 für Nebenantrieb / for PTO mit Schmierrohranschluss / with lubrication pipe connection	(82) (91)	
			3189 600 060				
2628 A 624.233	01.90 - 03.91	OM443.940		1878 000 964	380 10 380GTZ	Getr. / GBox: ZF 16S-160 624.233 für Nebenantrieb / for PTO Nebenantriebs-ID / PTO ID: NMV	(82) (50)
				3151 204 001	KZI-6	Getr. / GBox: ZF 16S-160 624.233 für Nebenantrieb / for PTO mit Schmierrohranschluss / with lubrication pipe connection Nebenantriebs-ID / PTO ID: NMV	(82) (91) (50)

		CODE				
--	--	------	--	---	---	---











MERCEDES-BENZ

2628									
2628 AK 624.334 624.333	02.80 - 03.91	OM422	 1800 125 301  1882 301 239  1878 002 706  3151 000 375	420 10 GF420 420GTZ KZIS-4	624.333-334				
			 3482 124 534 ●	430 GMF430	624.333-334				
			 1888 042 009	380 GF2/380	624.333-334 enthält eine Kupplungsscheibe / This part number includes one clutch disc	(67)			
			 1878 000 968 ▽	380 10 380GTZ	624.333-334 Lose Kupplungsscheibe / Loose clutch disc	(41)			
			 3151 108 031	KZI-4,5	624.333-334				
			 1882 341 001	380 GF2/380	624.333-334 In 1888 enthalten / Contained in 1888	(31)			
			 1859 250 102	380 GF2/380	624.333-334 In 1888 enthalten / Contained in 1888	(31)			
			 1878 000 968 △	380 10 380GTZ	624.333-334 In 1888 enthalten / Contained in 1888	(31)			
					OM422.913	 1882 346 131 #	420 GF420XN	624.333-334 für Nebenantrieb / for PTO	(82)
						 1878 003 269	420 10 420GTZ	624.333-334 für Nebenantrieb / for PTO	(82)
						 3151 204 001	KZI-6	624.333-334 für Nebenantrieb / for PTO mit Schmierrohranschluss / with lubrication pipe connection	(82) (91)
						 3189 600 060			
L,LK,LS 2628 343.044 343.031 343.033/034 L 2628 343.031 LK 2628 343.033/034 LS 2628 343.044		OM355.969	 1800 125 301  1882 301 239  1878 002 706  3151 000 375	420 10 GF420 420GTZ KZIS-4	343.031/033-034/044				
			 3482 124 534 ●	430 GMF430	343.031/033-034/044				
			 3189 600 060		343.031/033-034/044				









		CODE				
--	--	------	--	---	---	---

MERCEDES-BENZ

2629









2629 659.033 659.032	07.88-08.94	OM442		3400 124 101 ⊗ 3482 081 232 ⊗ 1878 005 668 ⊙ 3151 000 549	430 10 MFZ430 430WGTZ KZISZ-5		
2629 659.032	07.88-08.94						
2629 A 659.232/233	07.88-08.94			3400 122 501 ⊗ 3482 081 232 ⊗ 1878 634 027 ⊙ 3151 000 278	430 10 MFZ430 430WGTZ KZISZ-5	659.030/032-033/131-132/134 Sonderausführung / Special design	(60)
2629 A 659.233 659.232	07.88-08.94			3400 122 601 ⊗ 3482 081 231 ⊗ 1878 080 037 ⊙ 3151 000 278	430 10 MFZ430 430WGTZ KZISZ-5	659.232-233/333 Sonderausführung / Special design	(60)
2629 A 659.233	07.88-08.94	OM442.925, OM440.971, OM440.970,		1888 063 137	380 GF2/380N	für Nebenantrieb / for PTO enthält eine Kupplungsscheibe / This part number includes one clutch disc	(82) (67)
2629 A 659.232/233	07.88-08.94	OM442.959, OM442.966,		1862 304 033 ▽	380 10 380GV	für Nebenantrieb / for PTO Lose Kupplungsscheibe / Loose clutch disc	(82) (41)
2629 AK 659.334 659.333	07.88-08.94	OM443.940, OM442.906,		3151 166 031	KZI-6	für Nebenantrieb / for PTO	(82)
2629 AK 659.333	07.88-08.94	OM401.979, OM402.982,		1882 019 133	380 GF2/380N	In 1888 enthalten / Contained in 1888	(31)
2629 AK 659.333	07.88-08.94	OM442.929, OM442.926,		1859 250 101	380 GF2/380	In 1888 enthalten / Contained in 1888	(31)
2629 AK 659.334	07.88-08.94	OM442.917, OM442.907,		1862 305 033 △	380 10 380GVZ	In 1888 enthalten / Contained in 1888	(31)
2629 AS 659.331	07.88-08.94	OM442.989, OM442.942		3189 600 059			
2629 AS 659.331	07.88-08.94						
2629 B 659.030	07.88-08.94						
2629 K 659.132 659.134	07.88-08.94						
2629 K 659.134	07.88-08.94						
2629 K 659.134	07.88-08.94						
2629 S 659.131	07.88-08.94						











2631











2631 659.102 659.000 659.003 659.101 659.104 659.002	06.92-09.96	OM401, 441		3400 124 001 ⊗ 3482 081 231 ⊗ 1878 634 027 ⊙ 3151 000 278	430 10 MFZ430 430WGTZ KZISZ-5		
2631 659.002/003 659.101 659.104 659.000 659.102	06.92-09.96	OM401		1888 063 137	380 GF2/380N	für Nebenantrieb / for PTO enthält eine Kupplungsscheibe / This part number includes one clutch disc	(82) (67)
2631 A 659.203	06.92-09.96			1862 304 033 ▽	380 10 380GV	für Nebenantrieb / for PTO Lose Kupplungsscheibe / Loose clutch disc	(82) (41)
2631 A 659.203	01.94-09.96			3151 166 031	KZI-6	für Nebenantrieb / for PTO	(82)
2631 AK, 2634 AK 659.303/304	06.92-09.96			1882 019 133	380 GF2/380N	In 1888 enthalten / Contained in 1888	(31)
2631 AK, 2634 AK 659.304 659.303	01.94-09.96			1859 250 101	380 GF2/380	In 1888 enthalten / Contained in 1888	(31)
2631 AS 659.301	06.92-09.96			1862 305 033 △	380 10 380GVZ	In 1888 enthalten / Contained in 1888	(31)
2631 B 659.000	06.92-09.96						
2631 K 659.104 659.134	07.88-08.94	OM445.931, OM401.979, OM401.986,		3189 600 059			
2631 K 659.134 659.104	07.88-08.94	OM445.930, OM445.920, OM441.998,					
2631 S 659.101	06.92-09.96	OM401.987, OM445.929,					
2631 S 659.101	06.92-09.96	OM401.972, OM401.993, OM401.981					

		CODE		 Parameter		
--	--	------	--	---	---	---























MERCEDES-BENZ

2632							
2632 395.325/326	05.74 - 09.83	OM403		1800 125 301 ⊗ 1882 301 239 ⊗ 1878 002 706 ⊙ 3151 000 375	420 10 GF420 420GTZ KZIS-4	395.322/325-326/352/354/422/425/452-453-454	
2632 A 395.425	05.74 - 09.83						
2632 AK 395.453/454 395.452	08.73 - 09.83			3482 124 534 ●	430 GMF430	395.322/325-326/352/354/422/425/452-453-454	
2632 AS 395.422	05.74 - 09.83			1882 346 131 #	420 GF420XN	395.425/452-453-454 für Nebenantrieb / for PTO	(82)
2632 K 395.354 395.352	08.73 - 09.83			1878 003 269	420 10 420GTZ	395.425/452-453-454 für Nebenantrieb / for PTO	(82)
2632 S 395.322	05.74 - 09.83	OM413		3482 124 522	430 GMF430	395.322/352/354/452-453-454 Sonderausführung / Special design	(60)
				1878 002 706 ●	420 10 420GTZ	395.322/352/354/452-453-454 Sonderausführung / Special design	(60)
				3151 000 375	KZIS-4	395.322/352/354/452-453-454 Sonderausführung / Special design	(60)
		OM403.932, OM403.916, OM403.931, OM403.935		3189 600 060			

2633							
2633 624.048 623.023 623.073	05.82 - 05.87	OM422A, 423		1882 342 134	420 GF420X		
2633 S 624.146 624.196	05.82 - 05.87			1878 002 878	420 10 420GTZ		
				3151 110 031	KZI-4,5		
				1882 346 131 #	420 GF420XN	für Nebenantrieb / for PTO	(82)
				1878 002 706	420 10 420GTZ	für Nebenantrieb / for PTO	(82)
		OM422LA, 423		1888 042 009	380 GF2/380	enthält eine Kupplungsscheibe / This part number includes one clutch disc	(67)
				1878 000 968 ▽	380 10 380GTZ	Lose Kupplungsscheibe / Loose clutch disc	(41)
				3151 108 031	KZI-4,5		
				1882 341 001	380 GF2/380	In 1888 enthalten / Contained in 1888	(31)
				1859 250 102	380 GF2/380	In 1888 enthalten / Contained in 1888	(31)
				1878 000 968 △	380 10 380GTZ	In 1888 enthalten / Contained in 1888	(31)









2634							
2634 659.002	06.92 - 09.96	OM401, 441		3400 124 001 ⊗ 3482 081 231 ⊗ 1878 634 027 ⊙ 3151 000 278	430 10 MFZ430 430WGTZ KZISZ-5		
		OM401		1888 063 137	380 GF2/380N	für Nebenantrieb / for PTO enthält eine Kupplungsscheibe / This part number includes one clutch disc	(82) (67)
				1862 304 033 ▽	380 10 380GV	für Nebenantrieb / for PTO Lose Kupplungsscheibe / Loose clutch disc	(82) (41)
				3151 166 031	KZI-6	für Nebenantrieb / for PTO	(82)
				1882 019 133	380 GF2/380N	In 1888 enthalten / Contained in 1888	(31)
				1859 250 101	380 GF2/380	In 1888 enthalten / Contained in 1888	(31)
				1862 305 033 △	380 10 380GVZ	In 1888 enthalten / Contained in 1888	(31)
		OM445.920		3189 600 059			
2634 S 659.101	06.92 - 09.96	OM401, 441		3400 124 001 ⊗ 3482 081 231 ⊗ 1878 634 027 ⊙ 3151 000 278	430 10 MFZ430 430WGTZ KZISZ-5	659.101/303	
		OM441.986		3189 600 059			













MERCEDES-BENZ





2635							
2635 658.019 659.038 2635 658.019 659.038 2635 659.038 658.019	07.88 - 08.94	OM442LA		3400 121 601 ⚙️ 3488 017 432 ⚙️ 1878 634 022 ⚙️ 3151 000 547	400 10 MFZ2/400X 400GVZ KZISZ-5	->Chass. K011863	
	07.88 - 08.94						
	01.91 - 08.94				3400 122 901 ⚙️ 3482 081 233 ⚙️ 1878 002 735 ⚙️ 3151 000 278	430 10 MFZ430 430GTZ KZISZ-5	Chass. K011864->
			OM442A		3400 122 601 ⚙️ 3482 081 231 ⚙️ 1878 080 037 ⚙️ 3151 000 278	430 10 MFZ430 430WGTZ KZISZ-5	658.019 659.038
			OM442.964, OM442.966, OM442.976, OM442.923, OM442.944, OM442.909, OM442.997		1888 063 137	380 GF2/380N	für Nebenantrieb / for PTO enthält eine Kupplungsscheibe / This part number includes one clutch disc (82) (67)
					1862 304 033 ▽	380 10 380GV	für Nebenantrieb / for PTO Lose Kupplungsscheibe / Loose clutch disc (82) (41)
					3151 166 031	KZI-6	für Nebenantrieb / for PTO (82)
					1882 019 133	380 GF2/380N	In 1888 enthalten / Contained in 1888 (31)
					1859 250 101	380 GF2/380	In 1888 enthalten / Contained in 1888 (31)
					1862 305 033 △	380 10 380GVZ	In 1888 enthalten / Contained in 1888 (31)
				3189 600 059			
2635 648.013 649.038 2635 A 649.237 2635 AK 649.339 649.338 2635 AS 649.336 2635 S 649.186 649.136	04.86 - 03.91	OM422A, 442A		1888 055 041	380 GF2/380	649.038/136/186/237/336/338-339 enthält eine Kupplungsscheibe / This part number includes one clutch disc (67)	
	09.87 - 03.91				1878 006 055 ▽	380 10 380GT	649.038/136/186/237/336/338-339 Lose Kupplungsscheibe / Loose clutch disc (41)
	09.87 - 03.91				3151 108 031	KZI-4,5	649.038/136/186/237/336/338-339
	09.87 - 03.91				1882 349 003	380 GF2/380	649.038/136/186/237/336/338-339 In 1888 enthalten / Contained in 1888 (31)
	04.86 - 03.91				1859 250 100	380 GF2/380	649.038/136/186/237/336/338-339 In 1888 enthalten / Contained in 1888 (31)
					1862 138 032 △#	380 10 380GSZ	649.038/136/186/237/336/338-339 In 1888 enthalten / Contained in 1888 (31)
					1882 346 131 #	420 GF420XN	649.237/336 für Nebenantrieb / for PTO (82)
					1878 003 269	420 10 420GTZ	649.237/336 für Nebenantrieb / for PTO (82)
					3151 204 001	KZI-6	649.237/336 für Nebenantrieb / for PTO mit Schmierrohranschluss / with lubrication pipe connection (82) (91)
					1888 063 137	380 GF2/380N	649.038 für Nebenantrieb / for PTO enthält eine Kupplungsscheibe / This part number includes one clutch disc (82) (67)
					1862 304 033	380 10 380GV	649.038 für Nebenantrieb / for PTO (82)
					3151 204 001	KZI-6	649.038 für Nebenantrieb / for PTO mit Schmierrohranschluss / with lubrication pipe connection (82) (91)

		CODE				
--	--	------	--	---	---	---

MERCEDES-BENZ

2635						
2635 A 659.237	02.90 - 08.94	OM442A		3400 122 601 ⊗ 3482 081 231 ⊗ 1878 080 037 ⊙ 3151 000 278	430 10 MFZ430 430WGTZ KZISZ-5	
2635 A 659.237	12.91 - 08.94					
2635 AK 659.333 659.339 659.338	02.90 - 08.94			3400 121 601 HD ⊗ 3488 017 432 ⊗ 1878 634 022 ⊙ 3151 000 547	400 10 MFZ2/400X 400GVZ KZISZ-5	für Fahrzeuge mit Zweischeibenkupplung / for vehicles with double disc clutch (77)
2635 AK 659.339 659.338	02.90 - 08.94					
2635 AS 659.336	02.92 - 08.94	OM442.966, OM442.964, OM440.970, OM440.971, OM440.973,		1888 063 137	380 GF2/380N	für Nebenantrieb / for PTO enthält eine Kupplungsscheibe / This part number includes one clutch disc (82) (67)
2635 AS 659.336	02.90 - 09.96			1862 304 033 ▽	380 10 380GV	für Nebenantrieb / for PTO Lose Kupplungsscheibe / Loose clutch disc (82) (41)
2635 K 659.137 659.139	07.88 - 08.94	OM402.971, OM440.942, OM442.972, OM442.944, OM440.940, OM442.997, OM442.994, OM442.989, OM442.942, OM440.941		3151 166 031	KZI-6	für Nebenantrieb / for PTO (82)
2635 K 659.137	01.91 - 08.94			1882 019 133	380 GF2/380N	In 1888 enthalten / Contained in 1888 (31)
2635 K 659.137	07.91 - 08.94			1859 250 101	380 GF2/380	In 1888 enthalten / Contained in 1888 (31)
2635 K 659.139	07.88 - 08.94			1862 305 033 △	380 10 380GVZ	In 1888 enthalten / Contained in 1888 (31)
2635 S 659.136 659.186	07.88 - 08.94			3189 600 059		
2635 S 659.136	07.88 - 08.94					

2636						
2636 623.012 624.038 624.037 623.013	11.81 - 03.91	OM422A, 423		1882 342 134	420 GF420X	
2636 A 624.237	11.81 - 03.91			1878 002 878	420 10 420GTZ	
2636 AK 624.339 624.338	11.81 - 03.91			3151 110 031	KZI-4,5	
2636 AS 624.336	11.81 - 03.91			1882 346 131 #	420 GF420XN	für Nebenantrieb / for PTO (82)
2636 K 624.137 624.139	11.81 - 03.91			1878 002 706	420 10 420GTZ	für Nebenantrieb / for PTO (82)
2636 S 624.136	11.81 - 03.91			3151 204 001	KZI-6	für Nebenantrieb / for PTO mit Schmierrohranschluss / with lubrication pipe connection (82) (91)
		OM422LA, 423		1888 042 009	380 GF2/380	enthält eine Kupplungsscheibe / This part number includes one clutch disc (67)
				1878 000 968 ▽	380 10 380GTZ	Lose Kupplungsscheibe / Loose clutch disc (41)
				3151 108 031	KZI-4,5	
				1882 341 001	380 GF2/380	In 1888 enthalten / Contained in 1888 (31)
				1859 250 102	380 GF2/380	In 1888 enthalten / Contained in 1888 (31)
				1878 000 968 △	380 10 380GTZ	In 1888 enthalten / Contained in 1888 (31)

2637						
2637 659.343		OM402		3400 122 601 ⊗ 3482 081 231 ⊗ 1878 080 037 ⊙ 3151 000 278	430 10 MFZ430 430WGTZ KZISZ-5	
				3400 121 601 ⊗ 3488 017 432 ⊗ 1878 634 022 ⊙ 3151 000 547	400 10 MFZ2/400X 400GVZ KZISZ-5	Sonderausführung / Special design (60)
				3400 122 901 ⊗ 3482 081 233 ⊗ 1878 002 735 ⊙ 3151 000 278	430 10 MFZ430 430GTZ KZISZ-5	für / for: SA033617-01 (69)
				3189 600 059		























MERCEDES-BENZ

2638						
2638, 2638 L 659.028 659.142 659.197 659.144 659.147	09.91 - 09.96	OM402LA, 422LA		3400 122 601 ⊗ 3482 081 231 ⊗ 1878 080 037 ⊙ 3151 000 278	430 10 MFZ430 430WGTZ KZISZ-5	
2638, 2638 L 659.142 659.144 659.147 659.028 659.197	09.91 - 09.96					
2638, 2638 L 659.142 659.028	09.91 - 09.96			3400 122 901 ⊗ 3482 081 233 ⊗ 1878 002 735 ⊙ 3151 000 278	430 10 MFZ430 430GTZ KZISZ-5	für / for: SA033617-01 (69)
2638, 2638 L 659.028 659.142	09.91 - 09.96					
2638 A, LA 659.242	09.91 - 09.96	OM402, 442LA		3400 121 601 ⊗ 3488 017 432 ⊗ 1878 634 022 ⊙ 3151 000 547	400 10 MFZ2/400X 400GVZ KZISZ-5	für Fahrzeuge mit Zweischeibenkupplung / for vehicles with double disc clutch Sonderausführung / Special design (77)
2638 A, LA 659.242	09.91 - 09.96					(60)
2638 A, LA 659.242	09.91 - 09.96	OM440.970, OM402.975, OM402.971,		1888 063 137	380 GF2/380N	für Nebenantrieb / for PTO enthält eine Kupplungsscheibe / This part number includes one clutch disc (82) (67)
2638 AK 659.343/344	07.92 - 09.96	OM440.978, OM446.927,		1862 304 033 ▽	380 10 380GV	für Nebenantrieb / for PTO Lose Kupplungsscheibe / Loose clutch disc (82) (41)
2638 AK 659.343/344	01.94 - 09.96	OM440.981, OM446.926,		3151 166 031	KZI-6	für Nebenantrieb / for PTO (82)
2638 AK 659.343/344	07.92 - 09.96	OM446.925, OM402.985,		1882 019 133	380 GF2/380N	In 1888 enthalten / Contained in 1888 (31)
2638 AK 659.343	09.91 - 09.96	OM440.979, OM402.996,		1859 250 101	380 GF2/380	In 1888 enthalten / Contained in 1888 (31)
2638 AS 659.341	07.92 - 09.96	OM442.997, OM402.986,		1862 305 033 △	380 10 380GVZ	In 1888 enthalten / Contained in 1888 (31)
2638 AS 659.341	01.94 - 09.96	OM446.936, OM440.990,		3483 023 032 ⊕	445 GMFZ445W	659.344 für Fahrzeuge mit Wandlerschaltkupplung / for vehicles with converter and clutch unit (76)
2638 AS 659.341	07.92 - 09.96	OM446.924, OM440.982,		1878 003 780	445 24 445GTZ	659.344 für Fahrzeuge mit Wandlerschaltkupplung / for vehicles with converter and clutch unit (76)
2638 AS 659.341	07.92 - 09.96	OM442.989, OM402.972				
2638 K 659.137 659.142 659.144 659.147	09.91 - 09.96			3189 600 059		
2638 K 659.142 659.144 659.147	09.91 - 09.96					
2638 K 659.142 659.147 659.144	09.91 - 09.96					
2638 K 659.144 659.147 659.142	09.91 - 09.96					
2638 K 659.142 659.144 659.147	09.91 - 09.96					
2638 S 659.197	09.91 - 09.96					
2638 S 659.197	09.91 - 09.96					
2638 S 624.191	01.81 - 12.86	OM422LA		1888 042 009	380 GF2/380	enthält eine Kupplungsscheibe / This part number includes one clutch disc (67)
2638 623.068	01.81 - 12.86			1878 000 968 ▽	380 10 380GTZ	Lose Kupplungsscheibe / Loose clutch disc (41)
				3151 108 031	KZI-4,5	
				1882 341 001	380 GF2/380	In 1888 enthalten / Contained in 1888 (31)
				1859 250 102	380 GF2/380	In 1888 enthalten / Contained in 1888 (31)
				1878 000 968 △	380 10 380GTZ	In 1888 enthalten / Contained in 1888 (31)
2638, L, LK, LS 696.365 696.369 696.367				3400 700 355 ⊕ ⊗ 3488 000 158 ⊗ 1878 002 019	400 18 MFZ2/400X 400WGTZ	für / for: Lateinamerika (69)
				3100 000 003	KZISZ-5	für / for: Lateinamerika mit Zubehör / with accessories Beinhaltet Ausrücker und Montagesatz / Contains releaser and fitting kit In 3488 enthalten / Contained in 3488 (69) (93) (9) (33)







		CODE				
--	--	------	--	---	---	---



MERCEDES-BENZ

















2644								
2644, 2644 L 659.191 659.093 659.028 659.147 2644 S 659.191	01.92 - 09.96	OM440		3400 121 601 ● 3488 017 432 ● 1878 634 022 ○ 3151 000 547	400 10 MFZ2/400X 400GVZ KZISZ-5	->Chass. K011863 659.093/191		
	01.92 - 09.96			3400 122 901 ● 3482 081 233 ● 1878 002 735 ○ 3151 000 278	430 10 MFZ430 430GTZ KZISZ-5	Chass. K011864-> 659.093/191		
		OM440.970, OM440.978, OM446.922		3189 600 059				
2644 ,K,AK 659.142 659.147 659.137 659.343/344 2644 648.073	08.73 - 09.96	OM402, 442LA		3400 122 601 ● 3482 081 231 ● 1878 080 037 ○ 3151 000 278	430 10 MFZ430 430WGTZ KZISZ-5			
				3400 122 901 ● 3482 081 233 ● 1878 002 735 ○ 3151 000 278	430 10 MFZ430 430GTZ KZISZ-5	für / for: SA033617-01	(69)	
				3400 121 601 ● 3488 017 432 ● 1878 634 022 ○ 3151 000 547	400 10 MFZ2/400X 400GVZ KZISZ-5	659.344 für Fahrzeuge mit Zweischeibenkupplung / for vehicles with double disc clutch	(77)	
			OM442.953, OM442.980, OM442.951		3483 023 032 ⊕	445 GMFZ445W	659.344 für Fahrzeuge mit Wandlerschaltkupplung / for vehicles with converter and clutch unit	(76)
			1878 003 780	445 24 445GTZ	659.344 für Fahrzeuge mit Wandlerschaltkupplung / for vehicles with converter and clutch unit	(76)		
			3189 600 059					
2644 A 659.242	01.92 - 09.96	OM440.970, OM440.979, OM446.936		3400 122 601 ● 3482 081 231 ● 1878 080 037 ○ 3151 000 278	430 10 MFZ430 430WGTZ KZISZ-5			
				3400 122 901 ● 3482 081 233 ● 1878 002 735 ○ 3151 000 278	430 10 MFZ430 430GTZ KZISZ-5	für / for: SA033617-01	(69)	
				3400 121 601 ● 3488 017 432 ● 1878 634 022 ○ 3151 000 547	400 10 MFZ2/400X 400GVZ KZISZ-5	659.344 für Fahrzeuge mit Zweischeibenkupplung / for vehicles with double disc clutch	(77)	
				3189 600 059				
2644 AK 659.343/344				3400 122 601 ● 3482 081 231 ● 1878 080 037 ○ 3151 000 278	430 10 MFZ430 430WGTZ KZISZ-5	659.344		
				3400 121 601 ● 3488 017 432 ● 1878 634 022 ○ 3151 000 547	400 10 MFZ2/400X 400GVZ KZISZ-5	659.344 für Fahrzeuge mit Zweischeibenkupplung / for vehicles with double disc clutch	(77)	
				3483 023 032 ⊕	445 GMFZ445W	659.344 für Fahrzeuge mit Wandlerschaltkupplung / for vehicles with converter and clutch unit	(76)	
				1878 003 780	445 24 445GTZ	659.344 für Fahrzeuge mit Wandlerschaltkupplung / for vehicles with converter and clutch unit	(76)	
				3189 600 059				
2644 AK 659.333		OM442LA		3400 124 101 ● 3482 081 232 ● 1878 005 668 ○ 3151 000 549	430 10 MFZ430 430WGTZ KZISZ-5			
				3400 122 601 ● 3482 081 231 ● 1878 080 037 ○ 3151 000 278	430 10 MFZ430 430WGTZ KZISZ-5	Sonderausführung / Special design	(60)	
			3189 600 059					

		CODE				
--	--	------	--	---	---	---

MERCEDES-BENZ























2644						
2644 S 649.196	10.85 - 02.90	OM442LA		1888 055 247	380 GF2/380	enthält eine Kupplungsscheibe / This part number includes one clutch disc (67)
				1862 123 131 ▽	380 10 380GV	Lose Kupplungsscheibe / Loose clutch disc (41)
				3151 108 031	KZI-4,5	
				1882 349 003	380 GF2/380	In 1888 enthalten / Contained in 1888 (31)
				1859 250 100	380 GF2/380	In 1888 enthalten / Contained in 1888 (31)
				1862 122 132 △	380 10 380GVZ	In 1888 enthalten / Contained in 1888 (31)

2645						
2645 AS 659.336	02.90 - 09.96	OM442.989		3400 122 601 ⊕ 3482 081 231 ⊕ 1878 080 037 ⊕ 3151 000 278	430 10 MFZ430 430WGTZ KZISZ-5	
				3189 600 059		

2648							
2648 AK 659.338	02.90 - 08.94	OM440.973, OM442.989		3400 122 601 ⊕ 3482 081 231 ⊕ 1878 080 037 ⊕ 3151 000 278	430 10 MFZ430 430WGTZ KZISZ-5		
				3189 600 059			
2648 AS 659.331	07.88 - 08.94	OM442LA		3400 124 101 ⊕ 3482 081 232 ⊕ 1878 005 668 ⊕ 3151 000 549	430 10 MFZ430 430WGTZ KZISZ-5		
2648 K,AS 659.134 659.331							
2648 S 659.196 2648 S 659.196	12.88 - 07.92	OM440		3400 121 601 ⊕ 3488 017 432 ⊕ 1878 634 022 ⊕ 3151 000 547	400 10 MFZ2/400X 400GVZ KZISZ-5	->Chass. K011863	
	12.88 - 07.92	OM442LA		3400 122 901 ⊕ 3482 081 233 ⊕ 1878 002 735 ⊕ 3151 000 278	430 10 MFZ430 430GTZ KZISZ-5	Chass. K011864->	
				3400 121 601 ⊕ 3488 017 432 ⊕ 1878 634 022 ⊕ 3151 000 547	400 10 MFZ2/400X 400GVZ KZISZ-5		
			OM442.985, OM442.983, OM442.992, OM442.994, OM442.989		3483 023 032 ⊕	445 GMFZ445W	für Fahrzeuge mit Wandlerschaltkupplung / for vehicles with converter and clutch unit (76)
					1878 003 780	445 24 445GTZ	für Fahrzeuge mit Wandlerschaltkupplung / for vehicles with converter and clutch unit (76)
					3189 600 059		
2648 S,AS,AK 659.136 659.336 659.338		OM442LA		3400 122 601 ⊕ 3482 081 231 ⊕ 1878 080 037 ⊕ 3151 000 278	430 10 MFZ430 430WGTZ KZISZ-5		
				3189 600 059			
2648 S,LS 659.196		OM440		3400 121 601 ⊕ 3488 017 432 ⊕ 1878 634 022 ⊕ 3151 000 547	400 10 MFZ2/400X 400GVZ KZISZ-5	->Chass. K011863	
				3400 122 901 ⊕ 3482 081 233 ⊕ 1878 002 735 ⊕ 3151 000 278	430 10 MFZ430 430GTZ KZISZ-5	Chass. K011864->	
					3483 023 032 ⊕	445 GMFZ445W	für Fahrzeuge mit Wandlerschaltkupplung / for vehicles with converter and clutch unit (76)
					1878 003 780	445 24 445GTZ	für Fahrzeuge mit Wandlerschaltkupplung / for vehicles with converter and clutch unit (76)
					3189 600 059		









		CODE				
--	--	------	--	---	---	---









MERCEDES-BENZ



2650							
2650 656.215				1888 063 137	380 GF2/380N	Nebenantriebs-ID / PTO ID: 4/125 enthält eine Kupplungsscheibe / This part number includes one clutch disc (50) (67)	
				1862 304 033 ▽	380 10 380GV	Nebenantriebs-ID / PTO ID: 4/125 Lose Kupplungsscheibe / Loose clutch disc (50) (41)	
				3151 166 031	KZI-6	Nebenantriebs-ID / PTO ID: 4/125 (50)	
				1882 019 133	380 GF2/380N	In 1888 enthalten / Contained in 1888 (31)	
				1859 250 101	380 GF2/380	In 1888 enthalten / Contained in 1888 (31)	
				1862 305 033 △	380 10 380GVZ	In 1888 enthalten / Contained in 1888 (31)	
2650, 2650 L 659.098 659.144 655.496 659.028 659.142 2650 A 659.203 2650 AK 659.334 659.339 659.343 2650 AS 659.334 659.341 2650 K 659.139 2650 S 659.196	07.92 - 09.96	OM440		3400 121 601 ⊙ 3488 017 432 ⊙ 1878 634 022 ⊙ 3151 000 547	400 10 MFZ2/400X 400GVZ KZISZ-5	->Chass. K011863	
	07.87 - 09.96						
	07.88 - 08.94				3400 122 901 ⊙ 3482 081 233 ⊙ 1878 002 735 ⊙ 3151 000 278	430 10 MFZ430 430GTZ KZISZ-5	Chass. K011864->
	01.94 - 09.96						
	07.88 - 08.94	OM442LA		3400 121 601 ⊙ 3488 017 432 ⊙ 1878 634 022 ⊙ 3151 000 547	400 10 MFZ2/400X 400GVZ KZISZ-5		
	07.92 - 09.96						
		OM440.971, OM440.973, OM440.981, OM442.997, OM440.982, OM442.994, OM442.989		3483 023 032 ⊕	445 GMFZ445W	für Fahrzeuge mit Wandlerschaltkupplung / for vehicles with converter and clutch unit (76)	
				1878 003 780	445 24 445GTZ	für Fahrzeuge mit Wandlerschaltkupplung / for vehicles with converter and clutch unit (76)	
				3189 600 059			
	2650 ,K,S,AK 659.142 659.144 659.339 659.136 659.139 625.197		OM402, 442LA		3400 122 601 ⊙ 3482 081 231 ⊙ 1878 080 037 ⊙ 3151 000 278	430 10 MFZ430 430WGTZ KZISZ-5	659.136/139/142/144/339 625.197
				3400 122 901 ⊙ 3482 081 233 ⊙ 1878 002 735 ⊙ 3151 000 278	430 10 MFZ430 430GTZ KZISZ-5	für / for: SA033617-01 659.142/144 (69)	
				3189 600 059			
2653							
2653 , 2653 L 659.028 659.196 659.098 2653 AK 659.344	09.95 - 09.96	OM446.946, OM446.920		3483 023 032 ⊕	445 GMFZ445W	659.196/344 für Fahrzeuge mit Wandlerschaltkupplung / for vehicles with converter and clutch unit (76)	
	07.92 - 09.96				1878 003 780	445 24 445GTZ	659.196/344 für Fahrzeuge mit Wandlerschaltkupplung / for vehicles with converter and clutch unit (76)
2653 AK,K,S 659.142 659.344 659.343				3400 122 601 ⊙ 3482 081 231 ⊙ 1878 080 037 ⊙ 3151 000 278	430 10 MFZ430 430WGTZ KZISZ-5	659.344	
				3400 121 601 ⊙ 3488 017 432 ⊙ 1878 634 022 ⊙ 3151 000 547	400 10 MFZ2/400X 400GVZ KZISZ-5	659.344 für Fahrzeuge mit Zweischeibenkupplung / for vehicles with double disc clutch (77)	
				3483 023 032 ⊕	445 GMFZ445W	659.344 für Fahrzeuge mit Wandlerschaltkupplung / for vehicles with converter and clutch unit (76)	
				1878 003 780	445 24 445GTZ	659.344 für Fahrzeuge mit Wandlerschaltkupplung / for vehicles with converter and clutch unit (76)	
				3189 600 059			



		CODE				
--	--	------	--	---	---	---

MERCEDES-BENZ

3025							
3025 B 625.005 3025 B 619.049 619.048 3025 K 625.009 3025 K 619.034	12.85 - 07.87	OM422.920, OM422.909, OM422.912, OM422.919		1800 125 301  1882 301 239  1878 002 706  3151 000 375	420 10 GF420 420GTZ KZIS-4		
	08.83 - 03.91			3482 124 534 ●	430 GMF430		
	12.85 - 07.87			1882 346 131 #	420 GF420XN	625.005/009 für Nebenantrieb / for PTO	(82)
	04.85 - 03.91			1878 003 269	420 10 420GTZ	625.005/009 für Nebenantrieb / for PTO	(82)
				3151 204 001	KZI-6	625.005/009 für Nebenantrieb / for PTO mit Schmierrohranschluss / with lubrication pipe connection	(82) (91)
				3189 600 060			













3028							
3028 B 625.016 625.015 3028 K 625.018/019 3028 623.009	12.85 - 07.87	OM422.905, OM422.911, OM422.919		1800 125 301  1882 301 239  1878 002 706  3151 000 375	420 10 GF420 420GTZ KZIS-4		
	12.85 - 07.87			3482 124 534 ●	430 GMF430		
				1882 346 131 #	420 GF420XN	für Nebenantrieb / for PTO	(82)
	02.80 - 03.91			1878 003 269	420 10 420GTZ	für Nebenantrieb / for PTO	(82)
				3151 204 001	KZI-6	für Nebenantrieb / for PTO mit Schmierrohranschluss / with lubrication pipe connection	(82) (91)
				3189 600 060			







3033							
3033 623.023	05.82 - 05.87	OM422A, 423		1882 342 134	420 GF420X		
				1878 002 878	420 10 420GTZ		
				3151 110 031	KZI-4,5		







3035							
3035 K 648.038				1888 063 137	380 GF2/380N	648.038 für Nebenantrieb / for PTO enthält eine Kupplungsscheibe / This part number includes one clutch disc	(82) (67)
				1862 304 033	380 10 380GV	648.038 für Nebenantrieb / for PTO	(82)
				3151 204 001	KZI-6	648.038 für Nebenantrieb / for PTO mit Schmierrohranschluss / with lubrication pipe connection	(82) (91)







		CODE				
--	--	------	--	---	---	---

MERCEDES-BENZ

3036								
3036 K 623.012 624.237 3036 623.012	11.81 - 03.91	OM422A, 423		1882 342 134	420 GF420X			
				1878 002 878	420 10 420GTZ			
				3151 110 031	KZI-4,5			
				OM422LA, 423		1888 042 009	380 GF2/380	enthält eine Kupplungsscheibe / This part number includes one clutch disc Sonderausführung / Special design (67)
						1878 000 968 ▽	380 10 380GTZ	Sonderausführung / Special design (60) Lose Kupplungsscheibe / Loose clutch disc (41)
						3151 108 031	KZI-4,5	Sonderausführung / Special design (60)
						1882 341 001	380 GF2/380	In 1888 enthalten / Contained in 1888 Sonderausführung / Special design (31) (60)
						1859 250 102	380 GF2/380	In 1888 enthalten / Contained in 1888 Sonderausführung / Special design (31) (60)
						1878 000 968 △	380 10 380GTZ	Sonderausführung / Special design (60) In 1888 enthalten / Contained in 1888 (31)
						1882 346 131 #	420 GF420XN	für Nebenantrieb / for PTO (82)
						1878 002 706	420 10 420GTZ	für Nebenantrieb / for PTO (82)
						3151 204 001	KZI-6	für Nebenantrieb / for PTO mit Schmierrohranschluss / with lubrication pipe connection (82) (91)









3038						
3038 623.068 3038 623.068	01.81 - 12.86	OM422LA		1888 042 009	380 GF2/380	623.068 enthält eine Kupplungsscheibe / This part number includes one clutch disc (67)
				1878 000 968 ▽	380 10 380GTZ	623.068 Lose Kupplungsscheibe / Loose clutch disc (41)
				3151 108 031	KZI-4,5	623.068
				1882 341 001	380 GF2/380	623.068 In 1888 enthalten / Contained in 1888 (31)
				1859 250 102	380 GF2/380	623.068 In 1888 enthalten / Contained in 1888 (31)
				1878 000 968 △	380 10 380GTZ	623.068 In 1888 enthalten / Contained in 1888 (31)





3050						
3050 625.036/037 3050 ,S 625.036/037 625.197 625.196 3053 S 625.037	01.94 - 09.96	OM442LA		3400 122 601  3482 081 231  1878 080 037  3151 000 278	430 10 MFZ430 430WGTZ KZISZ-5	625.036-037/196-197
			12.93 - 09.96	OM446.933, OM440.976		3483 023 032 ⊕
		1878 003 780			445 24 445GTZ	625.036-037 für Fahrzeuge mit Wandlerschaltkupplung / for vehicles with converter and clutch unit (76)
		3189 600 059				





3053						
3053 ,A 625.037		OM442LA		3400 122 601  3482 081 231  1878 080 037  3151 000 278	430 10 MFZ430 430WGTZ KZISZ-5	625.037
				3483 023 032 ⊕	445 GMFZ445W	625.037 für Fahrzeuge mit Wandlerschaltkupplung / for vehicles with converter and clutch unit (76)
				1878 003 780	445 24 445GTZ	625.037 für Fahrzeuge mit Wandlerschaltkupplung / for vehicles with converter and clutch unit (76)
				3189 600 059		















		CODE				
--	--	------	--	---	---	---









MERCEDES-BENZ

3228								
3228 B 625.005 3228 K 625.018 625.009 625.019	07.87 - 03.91	OM422		1800 125 301  1882 301 239  1878 002 706  3151 000 375	420 10 GF420 420GTZ KZIS-4	625.005/009/018-019		
	07.87 - 03.91			3482 124 534 ●	430 GMF430	625.005/009/018-019		
					1882 346 131 #	420 GF420XN	625.005/009/018 für Nebenantrieb / for PTO	(82)
					1878 003 269	420 10 420GTZ	625.005/009/018 für Nebenantrieb / for PTO	(82)
					3151 204 001	KZI-6	625.005/009/018 für Nebenantrieb / for PTO mit Schmierrohranschluss / with lubrication pipe connection	(82) (91)
			OM422.921, OM422.919		3189 600 060			



















3229							
3229 625.101 3229 B 625.105 3229 K 625.108	09.89 - 08.94	OM441, 442		3400 124 101  3482 081 232  1878 005 668  3151 000 549	430 10 MFZ430 430WGTZ KZISZ-5	625.101/105/108	
	09.89 - 07.92						
	09.89 - 01.92						

3231							
3231 L 653.452 653.454 3231 L 653.454 653.452	12.87 - 09.96	OM401LA, 441LA		3400 124 001  3482 081 231  1878 634 027  3151 000 278	430 10 MFZ430 430WGTZ KZISZ-5	653.452/454	
	12.87 - 09.96	OM401.979, OM445.929, OM401.972, OM401.993		3189 600 059			

3233								
3233 ,B 625.005		OM441A, LA		1800 125 301  1882 301 239  1878 002 706  3151 000 375	420 10 GF420 420GTZ KZIS-4	625.005		
				3482 124 534 ●	430 GMF430	625.005		
					1882 346 131 #	420 GF420XN	625.005 für Nebenantrieb / for PTO	(82)
					1878 003 269	420 10 420GTZ	625.005 für Nebenantrieb / for PTO	(82)
					3151 204 001	KZI-6	625.005 für Nebenantrieb / for PTO mit Schmierrohranschluss / with lubrication pipe connection	(82) (91)
					3189 600 060			
3233 B 625.115 3233 K 625.118	10.90 - 07.92	OM441.982, OM441.985		3400 124 001  3482 081 231  1878 634 027  3151 000 278	430 10 MFZ430 430WGTZ KZISZ-5			
	10.90 - 07.92			3189 600 059				















3234								
3234 B 625.115 3234 K 625.119 625.118	02.92 - 09.96	OM441LA		3400 124 001  3482 081 231  1878 634 027  3151 000 278	430 10 MFZ430 430WGTZ KZISZ-5	625.115/118-119 653.463-464		
	02.92 - 09.96	OM441.988, OM445.922, OM441.992, OM441.990		1888 063 137	380 GF2/380N	625.115 Nebenantriebs-ID / PTO ID: NMV-4 enthält eine Kupplungsscheibe / This part number includes one clutch disc	(50) (67)	
					1862 304 033	380 10 380GV	625.115 Nebenantriebs-ID / PTO ID: NMV-4	(50)
					3151 166 031	KZI-6	625.115 Nebenantriebs-ID / PTO ID: NMV-4	(50)
					3189 600 059			



MERCEDES-BENZ

3235							
3235 625.120/121 3235 658.063 658.013 658.019 3235 658.038 3235 L 658.413	10.88-07.92	OM442A		3400 122 601  3482 081 231  1878 080 037  3151 000 278	430 10 MFZ430 430WGTZ KZISZ-5	625.120-121/128 658.019	
	07.88-08.94			3400 121 601  3488 017 432  1878 634 022  3151 000 547	400 10 MFZ2/400X 400GVZ KZISZ-5	625.120-121/128 Sonderausführung / Special design	(60)
	07.88-08.94			3400 122 601  3482 081 231  1878 080 037  3151 000 278	430 10 MFZ430 430WGTZ KZISZ-5	658.013/019/038/063/413	
	07.87-09.96			1888 063 137	380 GF2/380N	625.120-121/128 für Nebenantrieb / for PTO enthält eine Kupplungsscheibe / This part number includes one clutch disc	(82) (67)
				1862 304 033 ▽	380 10 380GV	625.120-121/128 für Nebenantrieb / for PTO Lose Kupplungsscheibe / Loose clutch disc	(82) (41)
				3151 166 031	KZI-6	625.120-121/128 für Nebenantrieb / for PTO	(82)
				1882 019 133	380 GF2/380N	625.120-121/128 In 1888 enthalten / Contained in 1888	(31)
				1859 250 101	380 GF2/380	625.120-121/128 In 1888 enthalten / Contained in 1888	(31)
				1862 305 033 △	380 10 380GVZ	625.120-121/128 In 1888 enthalten / Contained in 1888	(31)
				OM442.959, OM442.976, OM442.963, OM442.944		3189 600 059	

		CODE		 Parameter		
--	--	------	--	---	---	---



















MERCEDES-BENZ









3235							
3235 K 625.018/019 625.120	07.87 - 07.92	OM442A		3400 122 601 3482 081 231 1878 080 037 3151 000 278	430 10 MFZ430 430WGTZ KZISZ-5	01.1988-> 625.120-121/128	
				3400 121 601 3488 017 432 1878 634 022 3151 000 547	400 10 MFZ2/400X 400GVZ KZISZ-5	01.1988-> 625.120-121/128 Sonderausführung / Special design	(60)
				1800 125 301 1882 301 239 1878 002 706 3151 000 375	420 10 GF420 420GTZ KZIS-4	625.018-019	
				3482 124 534 ●	430 GMF430	625.018-019	
				1888 063 137	380 GF2/380N	01.1988-> 625.120-121/128 für Nebenantrieb / for PTO enthält eine Kupplungsscheibe / This part number includes one clutch disc	(82) (67)
				1862 304 033 ▽	380 10 380GV	01.1988-> 625.120-121/128 für Nebenantrieb / for PTO Lose Kupplungsscheibe / Loose clutch disc	(82) (41)
				3151 166 031	KZI-6	01.1988-> 625.120-121/128 für Nebenantrieb / for PTO	(82)
				1882 019 133	380 GF2/380N	01.1988-> 625.120-121/128 In 1888 enthalten / Contained in 1888	(31)
				1859 250 101	380 GF2/380	01.1988-> 625.120-121/128 In 1888 enthalten / Contained in 1888	(31)
				1862 305 033 △	380 10 380GVZ	01.1988-> 625.120-121/128 In 1888 enthalten / Contained in 1888	(31)
				1882 346 131 #	420 GF420XN	625.018-019 für Nebenantrieb / for PTO	(82)
				1878 003 269	420 10 420GTZ	625.018-019 für Nebenantrieb / for PTO	(82)
				3151 204 001	KZI-6	625.018-019 für Nebenantrieb / for PTO mit Schmierrohranschluss / with lubrication pipe connection	(82) (91)
					OM442.959, OM442.950, OM442.952	 3189 600 060 3189 600 059	

3236							
3236 A 625.374	07.87 - 09.96	OM423.909		3483 000 510 ⊕	445 GMFZ445W	für Fahrzeuge mit Wandlerschaltkupplung / for vehicles with converter and clutch unit	(76)
				1878 051 801	445 24 445GTZC	für Fahrzeuge mit Wandlerschaltkupplung / for vehicles with converter and clutch unit	(76)

		CODE					
--	--	------	--	--	---	---	---









MERCEDES-BENZ



3238								
3238 658.043 3238 625.130 625.132 625.131 3238 658.043 3238 658.043 3238 625.132 625.130/131 3238, 3238 L 658.024 625.130-132 3238, 3238 L 625.130 625.132 625.131 3238 L 658.468 658.416 3238 L 658.468 658.416	03.91 - 09.96	OM402LA, 423, 442LA		3400 122 601  3482 081 231  1878 080 037  3151 000 278	430 10 MFZ430 430WGTZ KZISZ-5	625.130-131-132 658.024/043		
	10.90 - 09.96							
	03.91 - 09.96				3400 122 901  3482 081 233  1878 002 735  3151 000 278	430 10 MFZ430 430GTZ KZISZ-5	für / for: SA033617-01 625.130-131-132 658.024/043	(69)
	03.91 - 09.96							
	10.90 - 09.96	OM442LA			3400 121 601 HD  3488 017 432  1878 634 022  3151 000 547	400 10 MFZ2/400X 400GVZ KZISZ-5	für / for: SA/W25801/03 für Fahrzeuge mit Zweiseibenkupplung / for vehicles with double disc clutch Sonderausführung / Special design	(69) (77)
	01.94 - 09.96							(60)
	10.90 - 09.96	OM402LA, 442LA			1888 063 137	380 GF2/380N	625.130-131-132 658.024/043 für Nebenantrieb / for PTO enthält eine Kupplungsscheibe / This part number includes one clutch disc	(82) (67)
	07.87 - 09.96							
	07.87 - 09.96				1862 304 033 ▽	380 10 380GV	625.130-131-132 658.024/043 für Nebenantrieb / for PTO Lose Kupplungsscheibe / Loose clutch disc	(82) (41)
					3151 166 031	KZI-6	625.130-131-132 658.024/043 für Nebenantrieb / for PTO	(82)
					1882 019 133	380 GF2/380N	625.130-131-132 658.024/043 In 1888 enthalten / Contained in 1888	(31)
					1859 250 101	380 GF2/380	625.130-131-132 658.024/043 In 1888 enthalten / Contained in 1888	(31)
					1862 305 033 △	380 10 380GVZ	625.130-131-132 658.024/043 In 1888 enthalten / Contained in 1888	(31)
			OM402.971, OM402.975, OM440.971, OM440.970, OM423.905, OM402.982, OM446.925, OM446.927, OM402.985, OM446.926, OM402.986, OM442.997, OM440.980, OM446.924, OM423.907, OM402.972, OM442.989, OM446.939, OM402.973, OM402.977, OM402.987		3189 600 059			







3244							
3244 625.130 625.132 625.131	01.94 - 09.96	OM402LA, 423, 442LA		3400 122 601  3482 081 231  1878 080 037  3151 000 278	430 10 MFZ430 430WGTZ KZISZ-5	625.130-132	
				3400 122 901  3482 081 233  1878 002 735  3151 000 278	430 10 MFZ430 430GTZ KZISZ-5	für / for: SA033617-01 625.130-132	(69)
			3189 600 059				

		CODE		 Parameter		
--	--	------	--	---	---	---

MERCEDES-BENZ











3244						
3244 L 658.471	07.87 - 09.96	OM402LA, 423, 442LA	 3400 122 601 ⊗ 3482 081 231 ⊗ 1878 080 037 ⊙ 3151 000 278	430 10 MFZ430 430WGTZ KZISZ-5	658.029/043 625.130-132	
			 3400 122 901 ⊗ 3482 081 233 ⊗ 1878 002 735 ⊙ 3151 000 278	430 10 MFZ430 430GTZ KZISZ-5	für / for: SA033617-01 658.029/043 625.130-132	(69)
	OM402LA, 442LA	 1888 063 137	380 GF2/380N	658.043 für Nebenantrieb / for PTO enthält eine Kupplungsscheibe / This part number includes one clutch disc	(82) (67)	
		 1862 304 033 ▽	380 10 380GV	658.043 für Nebenantrieb / for PTO Lose Kupplungsscheibe / Loose clutch disc	(82) (41)	
		 3151 166 031	KZI-6	658.043 für Nebenantrieb / for PTO	(82)	
		 1882 019 133	380 GF2/380N	658.043 In 1888 enthalten / Contained in 1888	(31)	
		 1859 250 101	380 GF2/380	658.043 In 1888 enthalten / Contained in 1888	(31)	
		 1862 305 033 △	380 10 380GVZ	658.043 In 1888 enthalten / Contained in 1888	(31)	
		 3189 600 059				
	OM440.970, OM446.922					



3248						
3248 658.071 658.073 3248 658.195	07.87 - 09.96	OM442LA	 3400 121 601 ⊗ 3488 017 432 ⊗ 1878 634 022 ⊙ 3151 000 547	400 10 MFZ2/400X 400GVZ KZISZ-5	->Chass. K011863 658.071/073/195	
	07.87 - 09.96		 3400 122 901 ⊗ 3482 081 233 ⊗ 1878 002 735 ⊙ 3151 000 278	430 10 MFZ430 430GTZ KZISZ-5	Chass. K011864-> 658.071/073/195	
		OM442.984, OM442.985, OM442.992, OM442.989	 3189 600 059			









3250						
3250 A 625.382	09.85 - 08.94	OM423.950, OM423.951	 3483 000 510 ⊕	445 GMFZ445W	625.382 für Fahrzeuge mit Wandlerschaltkupplung / for vehicles with converter and clutch unit	(76)
3250 L 658.473	07.87 - 09.96	OM442LA	 3400 122 601 ⊗ 3482 081 231 ⊗ 1878 080 037 ⊙ 3151 000 278	430 10 MFZ430 430WGTZ KZISZ-5	625.130-131-132	
			 3400 122 901 ⊗ 3482 081 233 ⊗ 1878 002 735 ⊙ 3151 000 278	430 10 MFZ430 430GTZ KZISZ-5	für / for: SA033617-01 625.130-131-132	(69)
			 3400 121 601 ⊗ 3488 017 432 ⊗ 1878 634 022 ⊙ 3151 000 547	400 10 MFZ2/400X 400GVZ KZISZ-5	->Chass. K011863 658.473	
			 3400 122 901 ⊗ 3482 081 233 ⊗ 1878 002 735 ⊙ 3151 000 278	430 10 MFZ430 430GTZ KZISZ-5	Chass. K011864-> 658.473	
		OM440.971, OM440.973, OM440.975, OM442.997	 3189 600 059			

		CODE				
--	--	------	--	---	---	---















MERCEDES-BENZ











3253							
3253, 3253 L 625.132 658.071 625.130 658.474 625.131	01.96 - 09.96	OM446.933, OM446.920, OM446.945		3400 122 601 ⊗ 3482 081 231 ⊗ 1878 080 037 ⊙ 3151 000 278	430 10 MFZ430 430WGTZ KZISZ-5		
				3400 122 901 ⊗ 3482 081 233 ⊗ 1878 002 735 ⊙ 3151 000 278	430 10 MFZ430 430GTZ KZISZ-5	für / for: SA033617-01	(69)
				3400 121 601 HD ⊗ 3488 017 432 ⊗ 1878 634 022 ⊙ 3151 000 547	400 10 MFZ2/400X 400GVZ KZISZ-5	für Fahrzeuge mit Zweischeibenkupplung / for vehicles with double disc clutch Sonderausführung / Special design	(77) (60)
				1888 063 137	380 GF2/380N	für Nebenantrieb / for PTO enthält eine Kupplungsscheibe / This part number includes one clutch disc	(82) (67)
				1862 304 033 ▽	380 10 380GV	für Nebenantrieb / for PTO Lose Kupplungsscheibe / Loose clutch disc	(82) (41)
				3151 166 031	KZI-6	für Nebenantrieb / for PTO	(82)
				1882 019 133	380 GF2/380N	In 1888 enthalten / Contained in 1888	(31)
				1859 250 101	380 GF2/380	In 1888 enthalten / Contained in 1888	(31)
				1862 305 033 △	380 10 380GVZ	In 1888 enthalten / Contained in 1888	(31)
				3189 600 059			









3255						
3255 658.195	07.87 - 09.96	OM442LA		3400 121 601 ⊗ 3488 017 432 ⊗ 1878 634 022 ⊙ 3151 000 547	400 10 MFZ2/400X 400GVZ KZISZ-5	->Chass. K011863 658.195
				3400 122 901 ⊗ 3482 081 233 ⊗ 1878 002 735 ⊙ 3151 000 278	430 10 MFZ430 430GTZ KZISZ-5	Chass. K011864-> 658.195
		OM446.920		3189 600 059		

3328							
3328 624.033	02.80 - 03.91	OM422		1800 125 301 ⊗ 1882 301 239 ⊗ 1878 002 706 ⊙ 3151 000 375	420 10 GF420 420GTZ KZIS-4	624.033/233	
				3482 124 534 ●	430 GMF430	624.033/233	
				1882 346 131 #	420 GF420XN	624.033 für Nebenantrieb / for PTO	(82)
				1878 003 269	420 10 420GTZ	624.033 für Nebenantrieb / for PTO	(82)
				3151 204 001	KZI-6	624.033 für Nebenantrieb / for PTO mit Schmierrohranschluss / with lubrication pipe connection	(82) (91)
				1878 000 964	380 10 380GTZ	Getr. / GBox: ZF 16S-160 624.233 für Nebenantrieb / for PTO Nebenantriebs-ID / PTO ID: NMV	(82) (50)
				3151 204 001	KZI-6	Getr. / GBox: ZF 16S-160 624.233 für Nebenantrieb / for PTO mit Schmierrohranschluss / with lubrication pipe connection Nebenantriebs-ID / PTO ID: NMV	(82) (91) (50)
		OM422.905, OM422.911, OM422.913		3189 600 060			

MERCEDES-BENZ

































3328								
3328 B 625.025 625.028 3328 B 624.032 624.232 3328 K 625.029	07.82 - 07.87	OM422		1800 125 301  1882 301 239  1878 002 706  3151 000 375	420 10 GF420 420GTZ KZIS-4	624.032/232 625.025/028-029		
	02.80 - 03.91			3482 124 534 ●	430 GMF430	624.032/232 625.025/028-029		
	07.82 - 07.87			<u>1888 055 041</u>	380 GF2/380	625.028-029 enthält eine Kupplungsscheibe / This part number includes one clutch disc		(67)
				<u>1878 006 055 ▽</u>	380 10 380GT	625.028-029 Lose Kupplungsscheibe / Loose clutch disc		(41)
				<u>3151 108 031</u>	KZI-4,5	625.028-029		
				1882 349 003	380 GF2/380	625.028-029 In 1888 enthalten / Contained in 1888		(31)
				1859 250 100	380 GF2/380	625.028-029 In 1888 enthalten / Contained in 1888		(31)
				1862 138 032 △#	380 10 380GSZ	625.028-029 In 1888 enthalten / Contained in 1888		(31)
				1882 346 131 #	420 GF420XN	625.025/028-029 624.032/232 für Nebenantrieb / for PTO		(82)
				1878 003 269	420 10 420GTZ	625.025/028-029 624.032/232 für Nebenantrieb / for PTO		(82)
				3151 204 001	KZI-6	625.025/028-029 624.032/232 für Nebenantrieb / for PTO mit Schmierrohranschluss / with lubrication pipe connection		(82) (91)
				3189 600 060				

3332								
3332 395.325/326		OM403		1800 125 301  1882 301 239  1878 002 706  3151 000 375	420 10 GF420 420GTZ KZIS-4	395.325-326		
				3482 124 534 ●	430 GMF430	395.325-326		
				1800 125 301  1882 301 239  1878 002 706  3151 000 375	420 10 GF420 420GTZ KZIS-4	395.325-326 Sonderausführung / Special design		(60)
				3482 124 534 ●	430 GMF430	395.325-326 Sonderausführung / Special design		(60)
				3189 600 060				

3333								
3333 624.048 623.048 3333 624.048 3333 K 624.048 3333 B 624.048	12.82 - 11.91	OM422A, 423		1882 342 134	420 GF420X	623.048 624.048		
				1878 002 878	420 10 420GTZ	623.048 624.048		
				3151 110 031	KZI-4,5	623.048 624.048		
		12.82 - 11.91	OM422LA, 423		<u>1888 042 009</u>	380 GF2/380	624.048 enthält eine Kupplungsscheibe / This part number includes one clutch disc Sonderausführung / Special design	(67) (60)
				<u>1878 000 968 ▽</u>	380 10 380GTZ	624.048 Lose Kupplungsscheibe / Loose clutch disc Sonderausführung / Special design		(41) (60)
				<u>3151 108 031</u>	KZI-4,5	624.048 Sonderausführung / Special design		(60)
				1882 341 001	380 GF2/380	624.048 In 1888 enthalten / Contained in 1888 Sonderausführung / Special design		(31) (60)
				1859 250 102	380 GF2/380	624.048 In 1888 enthalten / Contained in 1888 Sonderausführung / Special design		(31) (60)
				1878 000 968 △	380 10 380GTZ	624.048 In 1888 enthalten / Contained in 1888 Sonderausführung / Special design		(31) (60)













		CODE				
--	--	------	--	---	---	---







MERCEDES-BENZ







3335						
3335 648.013 649.038	04.86 - 03.91	OM422A	 1888 055 041	380 GF2/380	649.038 enthält eine Kupplungsscheibe / This part number includes one clutch disc	(67)
			 1878 006 055 ▽	380 10 380GT	649.038 Lose Kupplungsscheibe / Loose clutch disc	(41)
			 3151 108 031	KZI-4,5	649.038	
			 1882 349 003	380 GF2/380	649.038 In 1888 enthalten / Contained in 1888	(31)
			 1859 250 100	380 GF2/380	649.038 In 1888 enthalten / Contained in 1888	(31)
			 1862 138 032 △#	380 10 380GSZ	649.038 In 1888 enthalten / Contained in 1888	(31)
			 1888 063 137	380 GF2/380N	649.038 für Nebenantrieb / for PTO enthält eine Kupplungsscheibe / This part number includes one clutch disc	(82) (67)
			 1862 304 033	380 10 380GV	649.038 für Nebenantrieb / for PTO	(82)
			 3151 204 001	KZI-6	649.038 für Nebenantrieb / for PTO mit Schmierrohranschluss / with lubrication pipe connection	(82) (91)
3335 624.233 648.038		OM423	 1800 125 301	420 10 GF420	624.233	
			 1882 301 239	420GTZ		
			 1878 002 706	KZIS-4		
			 3151 000 375			
			 3482 124 534 ●	430 GMF430	624.233	
			 3189 600 060			
3335 A 649.237	04.86 - 03.91	OM422A	 1888 055 041	380 GF2/380	649.237 enthält eine Kupplungsscheibe / This part number includes one clutch disc	(67)
			 1878 006 055 ▽	380 10 380GT	649.237 Lose Kupplungsscheibe / Loose clutch disc	(41)
			 3151 108 031	KZI-4,5	649.237	
			 1882 349 003	380 GF2/380	649.237 In 1888 enthalten / Contained in 1888	(31)
			 1859 250 100	380 GF2/380	649.237 In 1888 enthalten / Contained in 1888	(31)
			 1862 138 032 △#	380 10 380GSZ	649.237 In 1888 enthalten / Contained in 1888	(31)
			 1882 346 131 #	420 GF420XN	649.237 für Nebenantrieb / for PTO	(82)
			 1878 003 269	420 10 420GTZ	649.237 für Nebenantrieb / for PTO	(82)
			 3151 204 001	KZI-6	649.237 für Nebenantrieb / for PTO mit Schmierrohranschluss / with lubrication pipe connection	(82) (91)
3336 624.233		OM442A	 1800 125 301	420 10 GF420	624.233	
			 1882 301 239	420GTZ		
			 1878 002 706	KZIS-4		
			 3151 000 375			
			 3482 124 534 ●	430 GMF430	624.233	
			 1878 000 964	380 10 380GTZ	Getr. / GBox: ZF 16S-160 624.233 für Nebenantrieb / for PTO Nebenantriebs-ID / PTO ID: NMV	(82) (50)
			 3151 204 001	KZI-6	Getr. / GBox: ZF 16S-160 624.233 für Nebenantrieb / for PTO mit Schmierrohranschluss / with lubrication pipe connection Nebenantriebs-ID / PTO ID: NMV	(82) (91) (50)
			 3189 600 060			

		CODE		 Parameter		
--	--	------	--	---	---	---

MERCEDES-BENZ













3336							
3336 624.203 624.037/038	12.82 - 11.91	OM422A, 423		1882 342 134	420 GF420X	624.037-038/136-137/139/237	
3336 A 624.237	11.81 - 03.91			1878 002 878	420 10 420GTZ	624.037-038/136-137/139/237	
3336 A 624.237	11.81 - 03.91			3151 110 031	KZI-4,5	624.037-038/136-137/139/237	
3336 AK 624.237	09.86 - 11.91	OM422LA, 423		1888 042 009	380 GF2/380	624.037-038/136-137/139/237 enthält eine Kupplungsscheibe / This part number includes one clutch disc	(67)
3336 B 624.139	12.82 - 11.91			1878 000 968 ▽	380 10 380GTZ	624.037-038/136-137/139/237 Lose Kupplungsscheibe / Loose clutch disc	(41)
3336 K 624.139 624.137	12.82 - 11.91			3151 108 031	KZI-4,5	624.037-038/136-137/139/237	
3336 S 624.136	12.82 - 11.91			1882 341 001	380 GF2/380	624.037-038/136-137/139/237 In 1888 enthalten / Contained in 1888	(31)
				1859 250 102	380 GF2/380	624.037-038/136-137/139/237 In 1888 enthalten / Contained in 1888	(31)
				1878 000 968 △	380 10 380GTZ	624.037-038/136-137/139/237 In 1888 enthalten / Contained in 1888	(31)
				1882 346 131 #	420 GF420XN	624.037/136-137/139/237	
				1878 002 706	420 10 420GTZ	624.037/136-137/139/237	
				3151 204 001	KZI-6	624.037/136-137/139/237 mit Schmierrohranschluss / with lubrication pipe connection	(91)

3338							
3338 624.191	01.81 - 12.86	OM422LA		1888 042 009	380 GF2/380	624.191 enthält eine Kupplungsscheibe / This part number includes one clutch disc	(67)
				1878 000 968 ▽	380 10 380GTZ	624.191 Lose Kupplungsscheibe / Loose clutch disc	(41)
				3151 108 031	KZI-4,5	624.191	
				1882 341 001	380 GF2/380	624.191 In 1888 enthalten / Contained in 1888	(31)
				1859 250 102	380 GF2/380	624.191 In 1888 enthalten / Contained in 1888	(31)
				1878 000 968 △	380 10 380GTZ	624.191 In 1888 enthalten / Contained in 1888	(31)









3344							
3344 ,S 649.196		OM442		1888 055 247	380 GF2/380	649.196 enthält eine Kupplungsscheibe / This part number includes one clutch disc	(67)
				1862 123 131 ▽	380 10 380GV	649.196 Lose Kupplungsscheibe / Loose clutch disc	(41)
				3151 108 031	KZI-4,5	649.196	
				1882 349 003	380 GF2/380	649.196 In 1888 enthalten / Contained in 1888	(31)
				1859 250 100	380 GF2/380	649.196 In 1888 enthalten / Contained in 1888	(31)
				1862 122 132 △	380 10 380GVZ	649.196 In 1888 enthalten / Contained in 1888	(31)



		CODE				
--	--	------	--	---	---	---

MERCEDES-BENZ

































3528						
3528 625.028	07.82 - 07.87	OM422		1800 125 301 ⊗ 1882 301 239 ⊗ 1878 002 706 ⊙ 3151 000 375	420 10 GF420 420GTZ KZIS-4	624.033/232-233 625.025/028-029
3528 B 625.025	07.87 - 09.89					
3528 K 624.232	07.87 - 09.89			3482 124 534 ●	430 GMF430	624.033/232-233 625.025/028-029
3528 K 625.029	07.82 - 07.87			1888 055 041	380 GF2/380	625.028-029 enthält eine Kupplungsscheibe / This part number includes one clutch disc (67)
				1878 006 055	380 10 380GT	625.028-029 Lose Kupplungsscheibe / Loose clutch disc (41)
				3151 108 031	KZI-4,5	625.028-029
				1882 349 003	380 GF2/380	625.028-029 In 1888 enthalten / Contained in 1888 (31)
				1859 250 100	380 GF2/380	625.028-029 In 1888 enthalten / Contained in 1888 (31)
				1862 138 032 #	380 10 380GSZ	625.028-029 In 1888 enthalten / Contained in 1888 (31)
		OM422.905, OM422.919		1882 346 131 #	420 GF420XN	625.025/028-029 624.033/232 für Nebenantrieb / for PTO (82)
				1878 003 269	420 10 420GTZ	625.025/028-029 624.033/232 für Nebenantrieb / for PTO (82)
				3151 204 001	KZI-6	625.025/029 624.033/232 für Nebenantrieb / for PTO mit Schmierrohranschluss / with lubrication pipe connection (82) (91)
				3189 600 060		

3529						
3529 659.032	07.88 - 08.94	OM442		3400 124 101 ⊗ 3482 081 232 ⊗ 1878 005 668 ⊙ 3151 000 549	430 10 MFZ430 430WGTZ KZISZ-5	659.032

3534						
3534 K 625.140 625.142	10.93 - 09.96	OM441.988, OM445.922		3400 124 001 ⊗ 3482 081 231 ⊗ 1878 634 027 ⊙ 3151 000 278	430 10 MFZ430 430WGTZ KZISZ-5	625.140/142
				1888 063 137	380 GF2/380N	625.140/142 für Nebenantrieb / for PTO enthält eine Kupplungsscheibe / This part number includes one clutch disc (82) (67)
				1862 304 033 ▽	380 10 380GV	625.140/142 für Nebenantrieb / for PTO Lose Kupplungsscheibe / Loose clutch disc (82) (41)
				3151 166 031	KZI-6	625.140/142 für Nebenantrieb / for PTO (82)
				1882 019 133	380 GF2/380N	625.140/142 In 1888 enthalten / Contained in 1888 (31)
				1859 250 101	380 GF2/380	625.140/142 In 1888 enthalten / Contained in 1888 (31)
				1862 305 033 △	380 10 380GVZ	625.140/142 In 1888 enthalten / Contained in 1888 (31)
				3189 600 059		





























3535						
3535 659.233 625.019 624.232				1882 346 131 #	420 GF420XN	625.019 für Nebenantrieb / for PTO (82)
3535,K 625.019				1878 003 269	420 10 420GTZ	625.019 für Nebenantrieb / for PTO (82)
				3151 204 001	KZI-6	625.019 für Nebenantrieb / for PTO mit Schmierrohranschluss / with lubrication pipe connection (82) (91)

MERCEDES-BENZ

3535						
3535 659.038 659.233	07.88 - 08.94	OM442.964, OM442.966, OM442.959, OM442.944, OM442.942	 3400 122 601  3482 081 231  1878 080 037  3151 000 278	430 10 MFZ430 430WGTZ KZISZ-5	659.038	
			 3400 124 101  3482 081 232  1878 005 668  3151 000 549	430 10 MFZ430 430WGTZ KZISZ-5	659.233	
			 3400 122 601  3482 081 231  1878 080 037  3151 000 278	430 10 MFZ430 430WGTZ KZISZ-5	659.233 Sonderausführung / Special design	(60)
			 3189 600 059			
3535 A 649.237			 1882 346 131 #	420 GF420XN	für Nebenantrieb / for PTO	(82)
			 1878 003 269	420 10 420GTZ	für Nebenantrieb / for PTO	(82)
			 3151 204 001	KZI-6	für Nebenantrieb / for PTO mit Schmierrohranschluss / with lubrication pipe connection	(82) (91)
3535 AK 624.232/233	09.87 - 02.90	OM423, 442	 1800 125 301  1882 301 239  1878 002 706  3151 000 375	420 10 GF420 420GTZ KZIS-4	624.232-233 625.029/025/028	
			 3482 124 534 ●	430 GMF430	624.232-233 625.029/025/028	
		OM442	 1888 055 041	380 GF2/380	624.232-233 625.029 enthält eine Kupplungsscheibe / This part number includes one clutch disc	(67)
			 1878 006 055 ▽	380 10 380GT	624.232-233 625.029 Lose Kupplungsscheibe / Loose clutch disc	(41)
			 3151 108 031	KZI-4,5	624.232-233 625.029	
			 1882 349 003	380 GF2/380	624.232-233 625.029 In 1888 enthalten / Contained in 1888	(31)
			 1859 250 100	380 GF2/380	624.232-233 625.029 In 1888 enthalten / Contained in 1888	(31)
			 1862 138 032 △#	380 10 380GSZ	624.232-233 625.029 In 1888 enthalten / Contained in 1888	(31)
			 1882 346 131 #	420 GF420XN	624.232 für Nebenantrieb / for PTO	(82)
			 1878 003 269	420 10 420GTZ	624.232 für Nebenantrieb / for PTO	(82)
			 3151 204 001	KZI-6	624.232 für Nebenantrieb / for PTO mit Schmierrohranschluss / with lubrication pipe connection	(82) (91)
			 1878 000 964	380 10 380GTZ	Getr. / GBox: ZF16S-160 624.233 für Nebenantrieb / for PTO Nebenantriebs-ID / PTO ID: NMV	(82) (50)
			 3151 204 001	KZI-6	Getr. / GBox: ZF16S-160 624.233 für Nebenantrieb / for PTO mit Schmierrohranschluss / with lubrication pipe connection Nebenantriebs-ID / PTO ID: NMV	(82) (91) (50)
			 3189 600 060			
					OM442.950, OM442.952	

























		CODE				
--	--	------	--	---	---	---









MERCEDES-BENZ

3535							
3535 AK 625.249 3535 B 625.145 3535 B 625.145 3535 K 625.148/149 3535 K 625.149 625.148 3535 S 659.136	02.90 - 08.94	OM442A		3400 122 601  3482 081 231  1878 080 037  3151 000 278	430 10 MFZ430 430WGTZ KZISZ-5	625.145/148-149/249 659.038/136/237	
	10.88 - 08.94			1888 063 137	380 GF2/380N	625.148-149/249 656.215 für Nebenantrieb / for PTO enthält eine Kupplungsscheibe / This part number includes one clutch disc	(82) (67)
	10.88 - 08.94			1862 304 033 ▽	380 10 380GV	625.148-149/249 656.215 für Nebenantrieb / for PTO Lose Kupplungsscheibe / Loose clutch disc	(82) (41)
	10.88 - 08.94			3151 166 031	KZI-6	625.148-149/249 656.215 für Nebenantrieb / for PTO	(82)
	10.88 - 08.94			1882 019 133	380 GF2/380N	625.148-149/249 656.215 In 1888 enthalten / Contained in 1888	(31)
	10.88 - 08.94			1859 250 101	380 GF2/380	625.148-149/249 656.215 In 1888 enthalten / Contained in 1888	(31)
	07.88 - 08.94			1862 305 033 △	380 10 380GVZ	625.148-149/249 656.215 In 1888 enthalten / Contained in 1888	(31)
				OM442.964, OM442.959, OM442.945, OM442.946, OM442.944, OM442.957, OM440.940, OM442.989		3189 600 059	
3535 AK 625.249 3535 K 625.149	03.91 - 08.94	OM402.982, OM402.983		3400 122 601  3482 081 231  1878 080 037  3151 000 278	430 10 MFZ430 430WGTZ KZISZ-5		
	03.91 - 08.94			3400 121 601 HD  3488 017 432  1878 634 022  3151 000 547	400 10 MFZ2/400X 400GVZ KZISZ-5	für Fahrzeuge mit Zweischeibenkupplung / for vehicles with double disc clutch	(77)
				1888 063 137	380 GF2/380N	für Nebenantrieb / for PTO enthält eine Kupplungsscheibe / This part number includes one clutch disc	(82) (67)
				1862 304 033 ▽	380 10 380GV	für Nebenantrieb / for PTO Lose Kupplungsscheibe / Loose clutch disc	(82) (41)
				3151 166 031	KZI-6	für Nebenantrieb / for PTO	(82)
				1882 019 133	380 GF2/380N	In 1888 enthalten / Contained in 1888	(31)
				1859 250 101	380 GF2/380	In 1888 enthalten / Contained in 1888	(31)
				1862 305 033 △	380 10 380GVZ	In 1888 enthalten / Contained in 1888	(31)
				3189 600 059			
3535 B 625.148 649.038 625.149 625.145				1888 063 137	380 GF2/380N	649.038 für Nebenantrieb / for PTO enthält eine Kupplungsscheibe / This part number includes one clutch disc	(82) (67)
				1862 304 033	380 10 380GV	649.038 für Nebenantrieb / for PTO	(82)
				3151 204 001	KZI-6	649.038 für Nebenantrieb / for PTO mit Schmierrohranschluss / with lubrication pipe connection	(82) (91)

		CODE				
--	--	------	--	---	---	---













MERCEDES-BENZ





























3535						
3535 K 625.019 625.029 625.025 625.028	09.87 - 01.89	OM423, 442	 1800 125 301  1882 301 239  1878 002 706  3151 000 375	420 10 GF420 420GTZ KZIS-4	624.232-233 625.029/025/028	
			 3482 124 534 ●	430 GMF430	624.232-233 625.029/025/028	
		OM442A	 1882 346 131 #	420 GF420XN	01.1988-> 625.019/025 für Nebenantrieb / for PTO	(82)
			 1878 003 269	420 10 420GTZ	01.1988-> 625.019/025 für Nebenantrieb / for PTO	(82)
			 3151 204 001	KZI-6	01.1988-> 625.019/025 für Nebenantrieb / for PTO mit Schmierrohranschluss / with lubrication pipe connection	(82) (91)
		OM442	 1888 055 041	380 GF2/380	624.232-233 625.029 enthält eine Kupplungsscheibe / This part number includes one clutch disc	(67)
			 1878 006 055 ▽	380 10 380GT	624.232-233 625.029 Lose Kupplungsscheibe / Loose clutch disc	(41)
			 3151 108 031	KZI-4,5	624.232-233 625.029	
			 1882 349 003	380 GF2/380	624.232-233 625.029 In 1888 enthalten / Contained in 1888	(31)
			 1859 250 100	380 GF2/380	624.232-233 625.029 In 1888 enthalten / Contained in 1888	(31)
			 1862 138 032 Δ#	380 10 380GSZ	624.232-233 625.029 In 1888 enthalten / Contained in 1888	(31)
		OM442.959, OM442.950	 3189 600 060			
3535 K 659.232 3535 L,K 659.032 659.232/233 656.215	07.87 - 09.96	OM442A, 443A	 3400 124 101  3482 081 232  1878 005 668  3151 000 549	430 10 MFZ430 430WGTZ KZISZ-5	659.032/232-233 656.215	
			 3400 122 601  3482 081 231  1878 080 037  3151 000 278	430 10 MFZ430 430WGTZ KZISZ-5	659.232-233 Sonderausführung / Special design	(60)
		OM442.966, OM442.942	 3189 600 059			

3536						
3536 K 624.139	12.82 - 11.91	OM422A, 423	 1882 342 134	420 GF420X		
			 1878 002 878	420 10 420GTZ		
			 3151 110 031	KZI-4,5		
		OM422LA, 423	 1888 042 009	380 GF2/380	enthält eine Kupplungsscheibe / This part number includes one clutch disc Sonderausführung / Special design	(67) (60)
			 1878 000 968 ▽	380 10 380GTZ	Lose Kupplungsscheibe / Loose clutch disc Sonderausführung / Special design	(41) (60)
			 3151 108 031	KZI-4,5	Sonderausführung / Special design	(60)
			 1882 341 001	380 GF2/380	In 1888 enthalten / Contained in 1888 Sonderausführung / Special design	(31) (60)
			 1859 250 102	380 GF2/380	In 1888 enthalten / Contained in 1888 Sonderausführung / Special design	(31) (60)
			 1878 000 968 Δ	380 10 380GTZ	In 1888 enthalten / Contained in 1888 Sonderausführung / Special design	(31) (60)















































		CODE				
--	--	------	--	---	---	---

MERCEDES-BENZ

3536						
3536 S 624.136/137		OM422A, 423	 1882 342 134	420 GF420X	624.136-137	
			 1878 002 878	420 10 420GTZ	624.136-137	
			 3151 110 031	KZI-4,5	624.136-137	
		OM422LA, 423	 1888 042 009	380 GF2/380	624.136-137 enthält eine Kupplungsscheibe / This part number includes one clutch disc Sonderausführung / Special design	(67) (60)
			 1878 000 968 ▽	380 10 380GTZ	624.136-137 Lose Kupplungsscheibe / Loose clutch disc Sonderausführung / Special design	(41) (60)
			 3151 108 031	KZI-4,5	624.136-137 Sonderausführung / Special design	(60)
			 1882 341 001	380 GF2/380	624.136-137 In 1888 enthalten / Contained in 1888 Sonderausführung / Special design	(31) (60)
			 1859 250 102	380 GF2/380	624.136-137 In 1888 enthalten / Contained in 1888 Sonderausführung / Special design	(31) (60)
			 1878 000 968 △	380 10 380GTZ	624.136-137 In 1888 enthalten / Contained in 1888 Sonderausführung / Special design	(31) (60)
			 1882 346 131 #	420 GF420XN	624.136-137 für Nebenantrieb / for PTO	(82)
			 1878 002 706	420 10 420GTZ	624.136-137 für Nebenantrieb / for PTO	(82)
			 3151 204 001	KZI-6	624.136-137 für Nebenantrieb / for PTO mit Schmierrohranschluss / with lubrication pipe connection	(82) (91)

















3538						
3538 625.135 625.137 3538 625.137 625.135 3538 659.028 3538 659.028 3538 AK 625.269 625.249 625.258/259 3538 AK 625.258/259 625.269 3538 AK 625.269 625.258/259 3538 AK 625.258/259 3538 K 625.137	03.91 - 09.96		 3400 122 601	430 10 MFZ430		
			 3482 081 231	430WGTVZ		
			 1878 080 037	KZISZ-5		
			 3151 000 278		für / for: SA33613	(69)
			 3400 122 901	430 10 MFZ430	für / for: SA33617	(69)
			 3482 081 233	430GTZ		
			 1878 002 735	KZISZ-5		
			 3151 000 278			
			 3400 121 601 HD	400 10 MFZ2/400X	für / for: SA32903-01/12	(69)
			 3488 017 432	400GVZ	für / for: SA32903-05	(69)
			 1878 634 022	KZISZ-5	für Fahrzeuge mit Zweischeibenkupplung / for vehicles with double disc clutch	(77)
			 3151 000 547			
			 1888 063 137	380 GF2/380N	für Nebenantrieb / for PTO enthält eine Kupplungsscheibe / This part number includes one clutch disc	(82) (67)
			 1862 304 033 ▽	380 10 380GV	für Nebenantrieb / for PTO Lose Kupplungsscheibe / Loose clutch disc	(82) (41)
			 3151 166 031	KZI-6	für Nebenantrieb / for PTO	(82)
 1882 019 133	380 GF2/380N	In 1888 enthalten / Contained in 1888	(31)			
 1859 250 101	380 GF2/380	In 1888 enthalten / Contained in 1888	(31)			
 1862 305 033 △	380 10 380GVZ	In 1888 enthalten / Contained in 1888	(31)			
 3189 600 059						
3538 659.233 625.137		OM402LA	 3400 124 101	430 10 MFZ430	659.233	
			 3482 081 232	430WGTVZ		
		 1878 005 668	KZISZ-5			
 3151 000 549		659.233 Sonderausführung / Special design	(60)			
		OM442A	 3400 121 601	400 10 MFZ2/400X	625.137	
			 3488 017 432	400GVZ		
			 1878 634 022	KZISZ-5		
			 3151 000 547			
			 3189 600 059			





















MERCEDES-BENZ

3538								
3538 AK 659.344				3400 122 601  3482 081 231  1878 080 037  3151 000 278	430 10 MFZ430 430WGTZ KZISZ-5	659.344		
				3400 121 601  3488 017 432  1878 634 022  3151 000 547	400 10 MFZ2/400X 400GVZ KZISZ-5	659.344 für Fahrzeuge mit Zweischeibenkupplung / for vehicles with double disc clutch	(77)	
				3483 023 032 ⊕	445 GMFZ445W	659.344 für Fahrzeuge mit Wandlerschaltkupplung / for vehicles with converter and clutch unit	(76)	
				1878 003 780	445 24 445GTZ	659.344 für Fahrzeuge mit Wandlerschaltkupplung / for vehicles with converter and clutch unit	(76)	
				3189 600 059				
3538 K 625.149 625.137 625.136 625.135 3538 K 625.136/137 3538 K 625.137 625.136	03.91 - 09.96	OM440.970, OM440.984, OM402.982, OM446.926, OM446.930, OM440.979, OM402.983, OM402.978, OM446.939, OM446.940, OM402.973, OM402.987		3400 122 601  3482 081 231  1878 080 037  3151 000 278	430 10 MFZ430 430WGTZ KZISZ-5			
		01.94 - 09.96			3400 122 901  3482 081 233  1878 002 735  3151 000 278	430 10 MFZ430 430GTZ KZISZ-5	für / for: SA33613 für / for: SA33617	(69) (69)
		03.91 - 09.96			3400 121 601 HD  3488 017 432  1878 634 022  3151 000 547	400 10 MFZ2/400X 400GVZ KZISZ-5	für / for: SA32903-01/12 für / for: SA32903-05 für Fahrzeuge mit Zweischeibenkupplung / for vehicles with double disc clutch	(69) (69) (77)
					1888 063 137	380 GF2/380N	für Nebenantrieb / for PTO enthält eine Kupplungsscheibe / This part number includes one clutch disc	(82) (67)
					1862 304 033 ▽	380 10 380GV	für Nebenantrieb / for PTO Lose Kupplungsscheibe / Loose clutch disc	(82) (41)
					3151 166 031	KZI-6	für Nebenantrieb / for PTO	(82)
					1882 019 133	380 GF2/380N	In 1888 enthalten / Contained in 1888	(31)
					1859 250 101	380 GF2/380	In 1888 enthalten / Contained in 1888	(31)
					1862 305 033 △	380 10 380GVZ	In 1888 enthalten / Contained in 1888	(31)
					3483 023 032 ⊕	445 GMFZ445W	625.136 für Fahrzeuge mit Wandlerschaltkupplung / for vehicles with converter and clutch unit	(76)
					1878 003 780	445 24 445GTZ	625.136 für Fahrzeuge mit Wandlerschaltkupplung / for vehicles with converter and clutch unit	(76)
					3189 600 059			
	3544							
	3544 648.073 3544 S 649.196	08.73 - 09.96	OM442LA		1888 055 247	380 GF2/380	648.073/473 enthält eine Kupplungsscheibe / This part number includes one clutch disc	(67)
			08.73 - 09.96			1862 123 131 ▽	380 10 380GV	648.473 Lose Kupplungsscheibe / Loose clutch disc
					3151 108 031	KZI-4,5	648.073/473	
					1882 349 003	380 GF2/380	648.473 In 1888 enthalten / Contained in 1888	(31)
					1859 250 100	380 GF2/380	648.473 In 1888 enthalten / Contained in 1888	(31)
					1862 122 132 △	380 10 380GVZ	648.473 In 1888 enthalten / Contained in 1888	(31)
3544 659.191 659.093	01.92 - 09.96	OM440		3400 121 601  3488 017 432  1878 634 022  3151 000 547	400 10 MFZ2/400X 400GVZ KZISZ-5	->Chass. K011863 659.191		
				3400 122 901  3482 081 233  1878 002 735  3151 000 278	430 10 MFZ430 430GTZ KZISZ-5	Chass. K011863-> 659.191		
			OM440.970, OM440.978, OM446.922		3189 600 059			

		CODE				
--	--	------	--	---	---	---





MERCEDES-BENZ

















3544								
3544 AK 625.269 3544 K 625.136 3544 ,K,AK 625.269 625.258/259 625.137 625.136	03.91 - 09.96	OM402LA, 442LA		3400 122 601  3482 081 231  1878 080 037  3151 000 278	430 10 MFZ430 430WGTZ KZISZ-5	625.136-137/258-259/269		
	03.91 - 09.96				3400 122 901  3482 081 233  1878 002 735  3151 000 278	430 10 MFZ430 430GTZ KZISZ-5	für / for: SA033617-01 625.136-137/258-259/269	(69)
			OM442LA		1888 063 137	380 GF2/380N	625.269 Nebenantriebs-ID / PTO ID: 4/125 enthält eine Kupplungsscheibe / This part number includes one clutch disc	(50) (67)
					1862 304 033 ▽	380 10 380GV	625.269 Nebenantriebs-ID / PTO ID: 4/125 Lose Kupplungsscheibe / Loose clutch disc	(50) (41)
					3151 166 031	KZI-6	625.269 Nebenantriebs-ID / PTO ID: 4/125	(50)
					1882 019 133	380 GF2/380N	625.269 In 1888 enthalten / Contained in 1888	(31)
					1859 250 101	380 GF2/380	625.269 In 1888 enthalten / Contained in 1888	(31)
					1862 305 033 △	380 10 380GVZ	625.269 In 1888 enthalten / Contained in 1888	(31)
			OM440.970, OM440.980, OM440.985		3483 023 032 ⊕	445 GMFZ445W	625.136 für Fahrzeuge mit Wandlerschaltkupplung / for vehicles with converter and clutch unit	(76)
					1878 003 780	445 24 445GTZ	625.136 für Fahrzeuge mit Wandlerschaltkupplung / for vehicles with converter and clutch unit	(76)
					3189 600 059			

3548								
3548 625.196/197 3548 K,S 625.197 625.149 625.196	05.92 - 09.96	OM402LA, 442LA		3400 122 601  3482 081 231  1878 080 037  3151 000 278	430 10 MFZ430 430WGTZ KZISZ-5	625.149/196-197		
			OM442.993, OM440.975		3189 600 059			
3548 659.232 625.149		OM442LA		3400 124 101  3482 081 232  1878 005 668  3151 000 549	430 10 MFZ430 430WGTZ KZISZ-5	659.232		
					3400 122 601  3482 081 231  1878 080 037  3151 000 278	430 10 MFZ430 430WGTZ KZISZ-5	659.232 Sonderausführung / Special design	(60)
			OM402LA		1888 063 137	380 GF2/380N	625.149 Nebenantriebs-ID / PTO ID: 4/125 enthält eine Kupplungsscheibe / This part number includes one clutch disc	(50) (67)
					1862 304 033 ▽	380 10 380GV	625.149 Nebenantriebs-ID / PTO ID: 4/125 Lose Kupplungsscheibe / Loose clutch disc	(50) (41)
					3151 166 031	KZI-6	625.149 Nebenantriebs-ID / PTO ID: 4/125	(50)
					1882 019 133	380 GF2/380N	625.149 In 1888 enthalten / Contained in 1888	(31)
					1859 250 101	380 GF2/380	625.149 In 1888 enthalten / Contained in 1888	(31)
					1862 305 033 △	380 10 380GVZ	625.149 In 1888 enthalten / Contained in 1888	(31)
				3189 600 059				

		CODE				
--	--	------	--	---	---	---







MERCEDES-BENZ





3548							
3548 S 659.196		OM440		3400 121 601 ● 3488 017 432 ● 1878 634 022 ● 3151 000 547	400 10 MFZ2/400X 400GVZ KZISZ-5	->Chass. K011863 659.196	
				3400 122 901 ● 3482 081 233 ● 1878 002 735 ● 3151 000 278	430 10 MFZ430 430GTZ KZISZ-5	Chass. K011863-> 659.196	
			3483 023 032 ⊕	445 GMFZ445W	659.196 für Fahrzeuge mit Wandlerschaltkupplung / for vehicles with converter and clutch unit	(76)	
			1878 003 780	445 24 445GTZ	659.196 für Fahrzeuge mit Wandlerschaltkupplung / for vehicles with converter and clutch unit	(76)	
			3189 600 059				















3550							
3550 656.215	01.88 -	OM442		3400 124 101 ● 3482 081 232 ● 1878 005 668 ● 3151 000 549	430 10 MFZ430 430WGTZ KZISZ-5	656.215	
				1888 063 137	380 GF2/380N	656.215 Nebenantriebs-ID / PTO ID: 4/125 enthält eine Kupplungsscheibe / This part number includes one clutch disc	(50) (67)
				1862 304 033 ▽	380 10 380GV	656.215 Nebenantriebs-ID / PTO ID: 4/125 Lose Kupplungsscheibe / Loose clutch disc	(50) (41)
				3151 166 031	KZI-6	656.215 Nebenantriebs-ID / PTO ID: 4/125	(50)
				1882 019 133	380 GF2/380N	656.215 In 1888 enthalten / Contained in 1888	(31)
				1859 250 101	380 GF2/380	656.215 In 1888 enthalten / Contained in 1888	(31)
				1862 305 033 △	380 10 380GVZ	656.215 In 1888 enthalten / Contained in 1888	(31)
			3550 659.196 625.196 625.137 625.197 659.098 625.037	05.92 - 09.96	OM442LA		3400 122 601 ● 3482 081 231 ● 1878 080 037 ● 3151 000 278
OM442, 442LA		3400 121 601 ● 3488 017 432 ● 1878 634 022 ● 3151 000 547			400 10 MFZ2/400X 400GVZ KZISZ-5	->Chass. K011863 659.098/196	
		3400 122 901 ● 3482 081 233 ● 1878 002 735 ● 3151 000 278			430 10 MFZ430 430GTZ KZISZ-5	Chass. K011864-> 659.098/196	
OM440.975, OM442.993, OM442.997, OM440.976		3483 023 032 ⊕			445 GMFZ445W	625.037 659.196 für Fahrzeuge mit Wandlerschaltkupplung / for vehicles with converter and clutch unit	(76)
		1878 003 780			445 24 445GTZ	625.037 659.196 für Fahrzeuge mit Wandlerschaltkupplung / for vehicles with converter and clutch unit	(76)
		3189 600 059					
3550 ,K,S 625.259 625.137 625.258 3550 K 625.259	03.91 - 09.96	OM442LA				3400 122 601 ● 3482 081 231 ● 1878 080 037 ● 3151 000 278	430 10 MFZ430 430WGTZ KZISZ-5
				3400 122 901 ● 3482 081 233 ● 1878 002 735 ● 3151 000 278	430 10 MFZ430 430GTZ KZISZ-5	für / for: SA033617-01 625.137/258-259	(69)
		OM440.975, OM442.997, OM440.982		3189 600 059			

		CODE				
--	--	------	--	---	---	---

MERCEDES-BENZ



3550							
3550 S 659.191		OM442	 3400 121 601 ⊗ 3488 017 432 ⊗ 1878 634 022 ⊙ 3151 000 547	400 10 MFZ2/400X 400GVZ KZISZ-5	->Chass. K011863 659.191		
			 3400 122 901 ⊗ 3482 081 233 ⊗ 1878 002 735 ⊙ 3151 000 278	430 10 MFZ430 430GTZ KZISZ-5		Chass. K011863-> 659.191	
			 3189 600 059				
3550 S, 3553 S 625.197 625.196 625.037	05.92 - 09.96	OM442LA	 3400 122 601 ⊗ 3482 081 231 ⊗ 1878 080 037 ⊙ 3151 000 278	430 10 MFZ430 430WGTZ KZISZ-5	625.037/137/196-197/258-259 659.038		
			 3483 023 032 ⊕	445 GMFZ445W		625.037 für Fahrzeuge mit Wandlerschaltkupplung / for vehicles with converter and clutch unit	(76)
		OM440.975, OM442.993, OM442.997	 1878 003 780	445 24 445GTZ	625.037 für Fahrzeuge mit Wandlerschaltkupplung / for vehicles with converter and clutch unit	(76)	
			 3189 600 059				







3553						
3553, 3553 L 659.196 659.098	01.94 - 09.96	OM446.920	 3483 023 032 ⊕	445 GMFZ445W	659.196 für Fahrzeuge mit Wandlerschaltkupplung / for vehicles with converter and clutch unit	(76)
			 1878 003 780	445 24 445GTZ		659.196 für Fahrzeuge mit Wandlerschaltkupplung / for vehicles with converter and clutch unit
3553 S 625.197 625.196	04.92 -	OM442LA	 3400 122 601 ⊗ 3482 081 231 ⊗ 1878 080 037 ⊙ 3151 000 278	430 10 MFZ430 430WGTZ KZISZ-5	625.197	
		OM446.933	 3189 600 059			

3636							
3636 624.137		OM422LA, 423	 1888 042 009	380 GF2/380	624.137 enthält eine Kupplungsscheibe / This part number includes one clutch disc Sonderausführung / Special design	(67)	
			 1878 000 968 ▽	380 10 380GTZ		624.137 Lose Kupplungsscheibe / Loose clutch disc Sonderausführung / Special design	(41) (60)
			 3151 108 031	KZI-4,5	624.137 Sonderausführung / Special design	(60)	
			 1882 341 001	380 GF2/380	624.137 In 1888 enthalten / Contained in 1888 Sonderausführung / Special design	(31) (60)	
			 1859 250 102	380 GF2/380	624.137 In 1888 enthalten / Contained in 1888 Sonderausführung / Special design	(31) (60)	
			 1878 000 968 △	380 10 380GTZ	624.137 In 1888 enthalten / Contained in 1888 Sonderausführung / Special design	(31) (60)	
			 1882 346 131 #	420 GF420XN	624.137 für Nebenantrieb / for PTO	(82)	
			 1878 002 706	420 10 420GTZ	624.137 für Nebenantrieb / for PTO	(82)	
			 3151 204 001	KZI-6	624.137 für Nebenantrieb / for PTO mit Schmierrohranschluss / with lubrication pipe connection	(82) (91)	
			3636 AK 624.137		OM422A, 423	 1882 342 134	420 GF420X
 1878 002 878	420 10 420GTZ	624.137					
 3151 110 031	KZI-4,5	624.137					
OM422LA, 423	 1882 346 131 #	420 GF420XN			624.137 für Nebenantrieb / for PTO	(82)	
 1878 002 706	420 10 420GTZ	624.137 für Nebenantrieb / for PTO			(82)		
 3151 204 001	KZI-6	624.137 für Nebenantrieb / for PTO mit Schmierrohranschluss / with lubrication pipe			(82) (91)		







		CODE				
--	--	------	--	---	---	---











MERCEDES-BENZ

3836						
3836 AK 624.339	11.81 - 03.91	OM423.907	 1878 002 706	420 10 420GTZ	624.339 für Nebenantrieb / for PTO	(82)
			 3151 204 001	KZI-6	624.339 für Nebenantrieb / for PTO mit Schmierrohranschluss / with lubrication pipe connection	(82) (91)

3844						
3844 ,S 649.196		OM442	 1888 055 247	380 GF2/380	649.196 enthält eine Kupplungsscheibe / This part number includes one clutch disc	(67)
			 1862 123 131 ▽	380 10 380GV	649.196 Lose Kupplungsscheibe / Loose clutch disc	(41)
			 3151 108 031	KZI-4,5	649.196	
			 1882 349 003	380 GF2/380	649.196 In 1888 enthalten / Contained in 1888	(31)
			 1859 250 100	380 GF2/380	649.196 In 1888 enthalten / Contained in 1888	(31)
			 1862 122 132 △	380 10 380GVZ	649.196 In 1888 enthalten / Contained in 1888	(31)













3850						
3850 A 625.392	09.85 - 08.94	OM423.950	 3483 000 510 ⊕	445 GMFZ445W	625.392 für Fahrzeuge mit Wandlerschaltkupplung / for vehicles with converter and clutch unit	(76)





4044						
4044 S 649.196		OM442	 1888 055 247	380 GF2/380	649.196 enthält eine Kupplungsscheibe / This part number includes one clutch disc	(67)
			 1862 123 131 ▽	380 10 380GV	649.196 Lose Kupplungsscheibe / Loose clutch disc	(41)
			 3151 108 031	KZI-4,5	649.196	
			 1882 349 003	380 GF2/380	649.196 In 1888 enthalten / Contained in 1888	(31)
			 1859 250 100	380 GF2/380	649.196 In 1888 enthalten / Contained in 1888	(31)
			 1862 122 132 △	380 10 380GVZ	649.196 In 1888 enthalten / Contained in 1888	(31)





4435						
4435 ,K 625.149 659.038		OM442A	 3400 122 601	430 10 MFZ430	625.149 659.038	
			 3482 081 231	430WGTZ		
			 1878 080 037	KZISZ-5		
			 3151 000 278			
		OM402LA	 1888 063 137	380 GF2/380N	625.149 Nebenantriebs-ID / PTO ID: 4/125 enthält eine Kupplungsscheibe / This part number includes one clutch disc	(50) (67)
			 1862 304 033 ▽	380 10 380GV	625.149 Nebenantriebs-ID / PTO ID: 4/125 Lose Kupplungsscheibe / Loose clutch disc	(50) (41)
			 3151 166 031	KZI-6	625.149 Nebenantriebs-ID / PTO ID: 4/125	(50)
			 1882 019 133	380 GF2/380N	625.149 In 1888 enthalten / Contained in 1888	(31)
	 1859 250 101	380 GF2/380	625.149 In 1888 enthalten / Contained in 1888	(31)		
	 1862 305 033 △	380 10 380GVZ	625.149 In 1888 enthalten / Contained in 1888	(31)		
			 3189 600 059			

		CODE				
--	--	------	--	---	---	---

MERCEDES-BENZ



4436						
4436 AK 624.237 624.137	OM422A, 423		1882 342 134	420 GF420X	624.137/237	
			1878 002 878	420 10 420GTZ	624.137/237	
			3151 110 031	KZI-4,5	624.137/237	
	OM422LA, 423		1888 042 009	380 GF2/380	624.137/237 enthält eine Kupplungsscheibe / This part number includes one clutch disc Sonderausführung / Special design	(67) (60)
			1878 000 968 ▽	380 10 380GTZ	624.137/237 Lose Kupplungsscheibe / Loose clutch disc Sonderausführung / Special design	(41) (60)
			3151 108 031	KZI-4,5	624.137/237 Sonderausführung / Special design	(60)
			1882 341 001	380 GF2/380	624.137/237 In 1888 enthalten / Contained in 1888 Sonderausführung / Special design	(31) (60)
			1859 250 102	380 GF2/380	624.137/237 In 1888 enthalten / Contained in 1888 Sonderausführung / Special design	(31) (60)
			1878 000 968 △	380 10 380GTZ	624.137/237 In 1888 enthalten / Contained in 1888 Sonderausführung / Special design	(31) (60)
			1882 346 131 #	420 GF420XN	624.137/237 für Nebenantrieb / for PTO	(82)
			1878 002 706	420 10 420GTZ	624.137/237 für Nebenantrieb / for PTO	(82)
			3151 204 001	KZI-6	624.137/237 für Nebenantrieb / for PTO mit Schmierrohranschluss / with lubrication pipe connection	(82) (91)
						







4445						
4445 624.233	OM442A, 443A		1800 125 301 ● 1882 301 239 ● 1878 002 706 ● 3151 000 375	420 10 GF420 420GTZ KZIS-4	624.233	
			3482 124 534 ●	430 GMF430	624.233	
	OM442		1878 000 964	380 10 380GTZ	Getr. / GBox: ZF16S-160 624.233 für Nebenantrieb / for PTO Nebenantriebs-ID / PTO ID: NMV	(82) (50)
			3151 204 001	KZI-6	Getr. / GBox: ZF16S-160 624.233 für Nebenantrieb / for PTO mit Schmierrohranschluss / with lubrication pipe connection Nebenantriebs-ID / PTO ID: NMV	(82) (91) (50)
			3189 600 060			



4635						
4635 659.233 659.237	OM442A		3400 122 601 ● 3482 081 231 ● 1878 080 037 ● 3151 000 278	430 10 MFZ430 430WGTZ KZISZ-5	659.237	
			3400 124 101 ● 3482 081 232 ● 1878 005 668 ● 3151 000 549	430 10 MFZ430 430WGTZ KZISZ-5	659.233	
			3400 122 601 ● 3482 081 231 ● 1878 080 037 ● 3151 000 278	430 10 MFZ430 430WGTZ KZISZ-5	659.233 Sonderausführung / Special design	(60)
		3189 600 059				

		CODE				
--	--	------	--	---	---	---

MERCEDES-BENZ













































4644						
4644 659.233		OM442LA		3400 124 101 ⊗ 3482 081 232 ⊗ 1878 005 668 ⊙ 3151 000 549	430 10 MFZ430 430WGTZ KZISZ-5	659.233
				3400 122 601 ⊗ 3482 081 231 ⊗ 1878 080 037 ⊙ 3151 000 278	430 10 MFZ430 430WGTZ KZISZ-5	659.233 Sonderausführung / Special design
			3189 600 059			

4645							
4645 624.233 659.233		OM442A, 443A		1800 125 301 ⊗ 1882 301 239 ⊗ 1878 002 706 ⊙ 3151 000 375	420 10 GF420 420GTZ KZIS-4	624.233	
				3482 124 534 ●	430 GMF430	624.233	
				1878 000 964	380 10 380GTZ	Getr. / GBox: ZF16S-160 624.233 für Nebenantrieb / for PTO Nebenantriebs-ID / PTO ID: NMV	(82) (50)
				3151 204 001	KZI-6	Getr. / GBox: ZF16S-160 624.233 für Nebenantrieb / for PTO mit Schmierrohranschluss / with lubrication pipe connection Nebenantriebs-ID / PTO ID: NMV	(82) (91) (50)
		OM443A		3400 124 101 ⊗ 3482 081 232 ⊗ 1878 005 668 ⊙ 3151 000 549	430 10 MFZ430 430WGTZ KZISZ-5	659.233	
				3400 122 601 ⊗ 3482 081 231 ⊗ 1878 080 037 ⊙ 3151 000 278	430 10 MFZ430 430WGTZ KZISZ-5	659.233 Sonderausführung / Special design	(60)
				3189 600 060 3189 600 059			

4648						
4648 659.233 659.232		OM442LA, 443A		3400 124 101 ⊗ 3482 081 232 ⊗ 1878 005 668 ⊙ 3151 000 549	430 10 MFZ430 430WGTZ KZISZ-5	659.232-233
				3400 122 601 ⊗ 3482 081 231 ⊗ 1878 080 037 ⊙ 3151 000 278	430 10 MFZ430 430WGTZ KZISZ-5	659.232-233 Sonderausführung / Special design
			3189 600 059			









		CODE				
--	--	------	--	---	---	---



MERCEDES-BENZ









4844							
4844 659.237 659.242 4844 ,K 625.259 625.269 625.258 659.237 4844 K 625.258	12.91 - 08.94	OM442LA	 3400 122 601  3482 081 231  1878 080 037  3151 000 278	430 10 MFZ430 430WGTZ KZISZ-5	625.258-259/269 659.237		
	03.91 - 09.96		 3400 122 901  3482 081 233  1878 002 735  3151 000 278	430 10 MFZ430 430GTZ KZISZ-5	für / for: SA033617-01 625.258-259/269	(69)	
			 1888 063 137	380 GF2/380N	625.258-259/269 Nebenantriebs-ID / PTO ID: 4/125 enthält eine Kupplungsscheibe / This part number includes one clutch disc	(50) (67)	
			 1862 304 033 ▽	380 10 380GV	625.258-259/269 Nebenantriebs-ID / PTO ID: 4/125 Lose Kupplungsscheibe / Loose clutch disc	(50) (41)	
			 3151 166 031	KZI-6	625.258-259/269 Nebenantriebs-ID / PTO ID: 4/125	(50)	
			 1882 019 133	380 GF2/380N	625.258-259/269 In 1888 enthalten / Contained in 1888	(31)	
			 1859 250 101	380 GF2/380	625.258-259/269 In 1888 enthalten / Contained in 1888	(31)	
			 1862 305 033 △	380 10 380GVZ	625.258-259/269 In 1888 enthalten / Contained in 1888	(31)	
		OM440.970, OM440.984, OM440.979, OM446.940	 3189 600 059				
4844 S 649.196		OM442	 1888 055 247	380 GF2/380	649.196 enthält eine Kupplungsscheibe / This part number includes one clutch disc	(67)	
			 1862 123 131 ▽	380 10 380GV	649.196 Lose Kupplungsscheibe / Loose clutch disc	(41)	
			 3151 108 031	KZI-4,5	649.196		
			 1882 349 003	380 GF2/380	649.196 In 1888 enthalten / Contained in 1888	(31)	
			 1859 250 100	380 GF2/380	649.196 In 1888 enthalten / Contained in 1888	(31)	
			 1862 122 132 △	380 10 380GVZ	649.196 In 1888 enthalten / Contained in 1888	(31)	
4850							
4850 625.269 625.259 659.233 625.258 4850 A 625.057	07.87 -	OM442LA	 3400 122 601  3482 081 231  1878 080 037  3151 000 278	430 10 MFZ430 430WGTZ KZISZ-5	625.258-259/269		
			 3400 122 901  3482 081 233  1878 002 735  3151 000 278	430 10 MFZ430 430GTZ KZISZ-5	für / for: SA033617-01 625.258-259/269	(69)	
			 1888 063 137	380 GF2/380N	625.258-259/269 Nebenantriebs-ID / PTO ID: 4/125 enthält eine Kupplungsscheibe / This part number includes one clutch disc	(50) (67)	
			 1862 304 033 ▽	380 10 380GV	625.258-259/269 Nebenantriebs-ID / PTO ID: 4/125 Lose Kupplungsscheibe / Loose clutch disc	(50) (41)	
			 3151 166 031	KZI-6	625.258-259/269 Nebenantriebs-ID / PTO ID: 4/125	(50)	
			 1882 019 133	380 GF2/380N	625.258-259/269 In 1888 enthalten / Contained in 1888	(31)	
			 1859 250 101	380 GF2/380	625.258-259/269 In 1888 enthalten / Contained in 1888	(31)	
			 1862 305 033 △	380 10 380GVZ	625.258-259/269 In 1888 enthalten / Contained in 1888	(31)	
			OM443A	 3400 124 101  3482 081 232  1878 005 668  3151 000 549	430 10 MFZ430 430WGTZ KZISZ-5	659.233	
				 3400 122 601  3482 081 231  1878 080 037  3151 000 278	430 10 MFZ430 430WGTZ KZISZ-5	659.233 Sonderausführung / Special design	(60)
			OM423.950	 3189 600 059			

		CODE				
--	--	------	--	---	---	---

MERCEDES-BENZ





4853						
4853 625.259 625.269	OM442LA		3400 122 601 ⊗ 3482 081 231 ⊗ 1878 080 037 ⊙ 3151 000 278	430 10 MFZ430 430WGTZ KZISZ-5	625.259/269	
			3400 122 901 ⊗ 3482 081 233 ⊗ 1878 002 735 ⊙ 3151 000 278	430 10 MFZ430 430GTZ KZISZ-5	für / for: SA033617-01 625.259/269	(69)
			1888 063 137	380 GF2/380N	625.259/269 Nebenantriebs-ID / PTO ID: 4/125 enthält eine Kupplungsscheibe / This part number includes one clutch disc	(50) (67)
			1862 304 033 ▽	380 10 380GV	625.259/269 Nebenantriebs-ID / PTO ID: 4/125 Lose Kupplungsscheibe / Loose clutch disc	(50) (41)
			3151 166 031	KZI-6	625.259/269 Nebenantriebs-ID / PTO ID: 4/125	(50)
			1882 019 133	380 GF2/380N	625.259/269 In 1888 enthalten / Contained in 1888	(31)
			1859 250 101	380 GF2/380	625.259/269 In 1888 enthalten / Contained in 1888	(31)
			1862 305 033 △	380 10 380GVZ	625.259/269 In 1888 enthalten / Contained in 1888	(31)
			3189 600 059			

5035						
5035 659.232	OM442A		3400 124 101 ⊗ 3482 081 232 ⊗ 1878 005 668 ⊙ 3151 000 549	430 10 MFZ430 430WGTZ KZISZ-5	659.232	
			3400 122 601 ⊗ 3482 081 231 ⊗ 1878 080 037 ⊙ 3151 000 278	430 10 MFZ430 430WGTZ KZISZ-5	659.232 Sonderausführung / Special design	(60)
			3189 600 059			



5038						
5038 ,AK 625.269	OM442LA		3400 122 601 ⊗ 3482 081 231 ⊗ 1878 080 037 ⊙ 3151 000 278	430 10 MFZ430 430WGTZ KZISZ-5	625.269	
			3400 122 901 ⊗ 3482 081 233 ⊗ 1878 002 735 ⊙ 3151 000 278	430 10 MFZ430 430GTZ KZISZ-5	für / for: SA033617-01 625.269	(69)
			1888 063 137	380 GF2/380N	625.269 Nebenantriebs-ID / PTO ID: 4/125 enthält eine Kupplungsscheibe / This part number includes one clutch disc	(50) (67)
			1862 304 033 ▽	380 10 380GV	625.269 Nebenantriebs-ID / PTO ID: 4/125 Lose Kupplungsscheibe / Loose clutch disc	(50) (41)
			3151 166 031	KZI-6	625.269 Nebenantriebs-ID / PTO ID: 4/125	(50)
			1882 019 133	380 GF2/380N	625.269 In 1888 enthalten / Contained in 1888	(31)
			1859 250 101	380 GF2/380	625.269 In 1888 enthalten / Contained in 1888	(31)
			1862 305 033 △	380 10 380GVZ	625.269 In 1888 enthalten / Contained in 1888	(31)
			3189 600 059			

		CODE				
--	--	------	--	---	---	---



MERCEDES-BENZ

5248						
5248 K 659.196		OM440		3400 121 601 ⊗ 3488 017 432 ⊗ 1878 634 022 ⊙ 3151 000 547	400 10 MFZ2/400X 400GVZ KZISZ-5	->Chass. K011863 659.196
				3400 122 901 ⊗ 3482 081 233 ⊗ 1878 002 735 ⊙ 3151 000 278	430 10 MFZ430 430GTZ KZISZ-5	Chass. K011864-> 659.196
			3483 023 032 ⊕	445 GMFZ445W	659.196 für Fahrzeuge mit Wandlerschaltkupplung / for vehicles with converter and clutch unit	(76)
			1878 003 780	445 24 445GTZ	659.196 für Fahrzeuge mit Wandlerschaltkupplung / for vehicles with converter and clutch unit	(76)
			3189 600 059			

MITSUBISHI

Canter 07.86 -						
Canter 75 FE 649	10.97 - 05.96 -	4D34-2AT4		3400 700 386	300	Nabenprofil / Hub Profile: 14 x 35mm (48)
FE 211	11.78 - 12.85			3400 700 384	260	Nabenprofil / Hub Profile: 14 x 29mm (48)
FE 444	01.86 - 12.96			3400 700 388	275	Nabenprofil / Hub Profile: 14 x 29mm (48)

MULTICAR

M26 06.92 - 09.10						
1.9	06.92 - 12.96	028.BM344/M84 1		3082 178 132	228 MF228	
				1878 030 841	228 23 228VTB	

MZKT

LKW						
LKW		Deutz		3482 083 032	430 MFZ430	Getr. / GBox: ZF 16S-251
				3151 000 034	KZISZ-5	Getr. / GBox: ZF 16S-251





NISSAN

CABSTAR E 10.98 - 10.06						
105.35, 110.35 110.45	10.98 - 10.06 10.98 - 10.06	BD-30Ti		3000 951 373 ■	242 10	Getr. / GBox: M5-25 Nabenprofil / Hub Profile: 23,1x28,7-10N (48)



CABSTAR 09.06 - 12.12						
28.11 35.13 35.15 45.13 45.15	10.06 - 09.06 - 12.12 10.06 - 10.06 - 10.06 -	YD25ETi, YD25DDTi, ZD30DDTi, ZD30HHD-5, ZD30		1863 600 116	GR-2	







		CODE				
--	--	------	--	---	---	---





NISSAN







PRIMASTAR Pritsche/Fahrgestell 07.02 - 08.06							
1.9 dCi	07.02 - 08.06	F9Q760		3000 990 101 3000 951 103 3182 654 142	240 21	->01.2003 Anzahl der Befestigungsbohrungen am CSC: 3 / Number of fastening bores at the CSC: 3	(2)
				3000 990 382	240 21	01.2003-> Anzahl der Befestigungsbohrungen am CSC: 3 / Number of fastening bores at the CSC: 3	(2)
				3000 990 394	240 21	01.2003-> Anzahl der Befestigungsbohrungen am CSC: 2 / Number of fastening bores at the CSC: 2	(1)
				1863 869 009	40	Kugellager / Ball Bearing	(38)
				6284 600 736 <small>LHD</small>			

ÖSTERREICHISCHE AUTOMOBILFABRIK (ÖAF)









16...						
16.192 H, HA, F				1882 110 532 #	350 GF350	
				1878 005 367	350 10 350WGTZ	
				3151 000 395	KZIS-4	









17...						
17.192 E49	01.88 -	D0826LF, GF		3482 017 035	380 GMF380	
				1878 000 957	380 10 380GTZ	
				3151 000 395	KZIS-4	
17.232 E49	01.89 -	D0826LF02, 06		3482 017 035	380 GMF380	
				1878 000 957	380 10 380GTZ	
				3151 000 395	KZIS-4	







18...							
18.373 E61 18.403 E61 18.423 E61 18.463 E61		D2866LF21, D2866LF20, D2866LF22, D2876LF02		3400 122 201 3482 083 032 1878 004 832 3151 000 034	430 10 MFZ430 430WGTZ KZISZ-5		
				3482 114 031	430 GMFZ430N	für Nebenantrieb / for PTO	(82)
				1878 004 832	430 10 430WGTZ	für Nebenantrieb / for PTO	(82)
				3151 263 031	KZIS-6	für Nebenantrieb / for PTO	(82)
				3189 600 020		Getr. / GBox: ZF Ecosplit-3	

19...						
19.192 H, HA,				1882 110 532 #	350 GF350	
				1878 005 367	350 10 350WGTZ	
				3151 000 395	KZIS-4	
19.230 H, HA, F				3151 000 395	KZIS-4	
19.256 H, HA, F 19.304 F				3482 124 541	430 GMF430	
				1882 330 032 ●#	420 GF420	
				1878 634 039 ▲	420 10 420WGTZ	
				3151 000 395	KZIS-4	





ÖSTERREICHISCHE AUTOMOBILFABRIK (ÖAF)





















19...						
19.273 E52	01.94-	D2865		3400 122 301 ⊗ 3482 083 032 ⊗ 1878 080 034 ⊙ 3151 000 034	430 10 MFZ430 430WGTZ KZISZ-5	
19.293 E52	01.94-			3189 600 020		Getr. / GBox: ZF Ecosplit-3
19.323 E52	01.94-					
19.344 E52	01.94-					
19.373 E61,62		D2866LF21, D2866LF20, D2866LF22, D2876LF02		3400 122 201 ⊗ 3482 083 032 ⊗ 1878 004 832 ⊙ 3151 000 034	430 10 MFZ430 430WGTZ KZISZ-5	
19.404 E61,62				3400 700 327 ⊗ 3482 114 031 ⊗ 1878 004 832 ⊙ 3151 263 031	430 10 GMFZ430N 430WGTZ KZIZ-6	für Nebenantrieb / for PTO (82)
19.423 E61,62				3400 700 641 HD ⊗ 3482 114 031 ⊗ 1878 007 729 ⊙ 3151 263 031	430 10 GMFZ430N 430WGTZ KZIZ-6	Nebenantriebs-ID / PTO ID: NMV 221 (50)
19.464 E61,62				3189 600 020		Getr. / GBox: ZF Ecosplit-3
19.463 E61,62	01.95-	D2866LF		3400 700 327 ⊗ 3482 114 031 ⊗ 1878 004 832 ⊙ 3151 263 031	430 10 GMFZ430N 430WGTZ KZIZ-6	für Nebenantrieb / for PTO (82)
19.464 E61,62	01.95-			3400 700 641 HD ⊗ 3482 114 031 ⊗ 1878 007 729 ⊙ 3151 263 031	430 10 GMFZ430N 430WGTZ KZIZ-6	Nebenantriebs-ID / PTO ID: NMV 221 (50)

21...						
21.273 E52	01.94-	D2865		3400 122 301 ⊗ 3482 083 032 ⊗ 1878 080 034 ⊙ 3151 000 034	430 10 MFZ430 430WGTZ KZISZ-5	
21.293 E52	01.94-			3482 114 031	430 GMFZ430N	für Nebenantrieb / for PTO (82)
21.323 E52	01.94-			1878 080 034	430 10 430WGTZ	für Nebenantrieb / for PTO (82)
21.343 E52	01.94-			3151 000 034	KZISZ-5	für Nebenantrieb / for PTO (82)
				3189 600 020		Getr. / GBox: ZF Ecosplit-3
21.373 E62	01.94-	D2866LF21		3400 122 301 ⊗ 3482 083 032 ⊗ 1878 080 034 ⊙ 3151 000 034	430 10 MFZ430 430WGTZ KZISZ-5	
21.403 E62	01.94-			3482 114 031	430 GMFZ430N	für Nebenantrieb / for PTO (82)
21.423 E62	01.94-			1878 080 034	430 10 430WGTZ	für Nebenantrieb / for PTO (82)
21.463 E62	01.94-			3151 000 034	KZISZ-5	für Nebenantrieb / for PTO (82)
				3189 600 020		Getr. / GBox: ZF Ecosplit-3

















22...						
22.192 FN				1882 110 532 #	350 GF350	
				1878 005 367	350 10 350WGTZ	
				3151 000 395	KZIS-4	
22.256 HN, HNA, FN 22.304 FN				3482 124 541	430 GMF430	
				1882 330 032 ●#	420 GF420	
				1878 634 039 ▲	420 10 420WGTZ	
				3151 000 395	KZIS-4	











ÖSTERREICHISCHE AUTOMOBILFABRIK (ÖAF)





24...						
24.273 E53		D2865		3400 122 301 ⊗ 3482 083 032 ⊗ 1878 080 034 ⊙ 3151 000 034	430 10 MFZ430 430WGTZ KZISZ-5	
24.293 E53				3482 114 031	430 GMFZ430N	für Nebenantrieb / for PTO (82)
24.323 E53				1878 080 034	430 10 430WGTZ	für Nebenantrieb / for PTO (82)
24.343 E53				3151 263 031	KZIZ-6	für Nebenantrieb / for PTO (82)
				3189 600 020		Getr. / GBox: ZF Ecosplit-3











26...						
26.273 E53,69		D2865, 2866		3400 122 301 ⊗ 3482 083 032 ⊗ 1878 080 034 ⊙ 3151 000 034	430 10 MFZ430 430WGTZ KZISZ-5	
26.293 E53,69				3482 114 031	430 GMFZ430N	für Nebenantrieb / for PTO (82)
26.323 E53,69				1878 080 034	430 10 430WGTZ	für Nebenantrieb / for PTO (82)
26.343 E53,69				3151 263 031	KZIZ-6	für Nebenantrieb / for PTO (82)
				3189 600 020		Getr. / GBox: ZF Ecosplit-3
26.352 E76,78	01.94 -	D2866		3400 122 201 ⊗ 3482 083 032 ⊗ 1878 004 832 ⊙ 3151 000 034	430 10 MFZ430 430WGTZ KZISZ-5	
26.482 E76,78	01.94 -			3400 700 327 ⊗ 3482 114 031 ⊗ 1878 004 832 ⊙ 3151 263 031	430 10 GMFZ430N 430WGTZ KZIZ-6	für Nebenantrieb / for PTO (82)
				3400 700 641 HD ⊗ 3482 114 031 ⊗ 1878 007 729 ⊙ 3151 263 031	430 10 GMFZ430N 430WGTZ KZIZ-6	Nebenantriebs-ID / PTO ID: NMV 221 (50)
				3189 600 020		Getr. / GBox: ZF Ecosplit-3
26.373 E72	01.94 -	D2866		3400 122 301 ⊗ 3482 083 032 ⊗ 1878 080 034 ⊙ 3151 000 034	430 10 MFZ430 430WGTZ KZISZ-5	
26.404 E69,72	01.94 -			3482 114 031	430 GMFZ430N	für Nebenantrieb / for PTO (82)
26.423 E69,72	01.94 -			1878 080 034	430 10 430WGTZ	für Nebenantrieb / for PTO (82)
26.464 E69,72	01.94 -			3151 263 031	KZIZ-6	für Nebenantrieb / for PTO (82)
				3189 600 020		Getr. / GBox: ZF Ecosplit-3
26.463 E69	01.94 -	D2866		3400 122 301 ⊗ 3482 083 032 ⊗ 1878 080 034 ⊙ 3151 000 034	430 10 MFZ430 430WGTZ KZISZ-5	
				3482 114 031	430 GMFZ430N	für Nebenantrieb / for PTO (82)
				1878 080 034	430 10 430WGTZ	für Nebenantrieb / for PTO (82)
				3151 263 031	KZIZ-6	für Nebenantrieb / for PTO (82)
				3483 000 509 ⊕	445 GMFZ445W	für Fahrzeuge mit Wandlerschaltkupplung / for vehicles with converter and clutch unit (76)
				1878 051 801	445 24 445GTZC	für Fahrzeuge mit Wandlerschaltkupplung / for vehicles with converter and clutch unit (76)
				3189 600 020		Getr. / GBox: ZF Ecosplit-3

ÖSTERREICHISCHE AUTOMOBILFABRIK (ÖAF)

27...						
27.273 E53,69		D2865, 2866	 3400 122 301  3482 083 032  1878 080 034  3151 000 034	430 10 MFZ430 430WGTZ KZISZ-5	03.1996->	
27.293 E53,69			 3482 114 031	430 GMFZ430N	für Nebenantrieb / for PTO	(82)
27.323 E53,69			 1878 080 034	430 10 430WGTZ	für Nebenantrieb / for PTO	(82)
27.343 E53,69			 3151 263 031	KZIZ-6	für Nebenantrieb / for PTO	(82)
27.403 E53,69,72			 3189 600 020		Getr. / GBox: ZF Ecosplit-3	
27.423 E53,69,72						
27.463 E53,69,72						
27.373 E72		D2866	 3400 122 301  3482 083 032  1878 080 034  3151 000 034	430 10 MFZ430 430WGTZ KZISZ-5	01.1995->	
27.403 E69,72			 3482 114 031	430 GMFZ430N	für Nebenantrieb / for PTO	(82)
27.423 E69,72			 1878 080 034	430 10 430WGTZ	für Nebenantrieb / for PTO	(82)
27.463 E69,72			 3151 263 031	KZIZ-6	für Nebenantrieb / for PTO	(82)
			 3189 600 020		Getr. / GBox: ZF Ecosplit-3	









28...						
28.273 E69		D2866	 3400 122 301  3482 083 032  1878 080 034  3151 000 034	430 10 MFZ430 430WGTZ KZISZ-5	01.1994->	
28.403 E69			 3482 114 031	430 GMFZ430N	für Nebenantrieb / for PTO	(82)
28.423 E69			 1878 080 034	430 10 430WGTZ	für Nebenantrieb / for PTO	(82)
28.463 E69			 3151 263 031	KZIZ-6	für Nebenantrieb / for PTO	(82)
			 3483 000 509 	445 GMFZ445W	für Fahrzeuge mit Wandlerschaltkupplung / for vehicles with converter and clutch unit	(76)
			 1878 051 801	445 24 445GTZC	für Fahrzeuge mit Wandlerschaltkupplung / for vehicles with converter and clutch unit	(76)
			 3189 600 020		Getr. / GBox: ZF Ecosplit-3	







30...						
30.230 HD, HDA			 3151 000 395	KZIS-4		
30.256 HD, HDA			 1882 330 032 #	420 GF420		
			3482 124 541	430 GMF430		
			 1878 634 039 ▲	420 10 420WGTZ		
			 3151 000 395	KZIS-4		





32...						
32.292 E15,17,18,26	01.88-	D2866LF	 3400 127 601  3482 078 133  1862 364 031  3151 000 034	400 10 MFZ400 400WGVZ KZISZ-5	Nabenprofil / Hub Profile: 2"-10N Je nach Kundenwunsch mit unterschiedlicher Kupplung / Equipped with different clutch according to customer requirement	(48) (35)
32.332 E15,17,18,26	01.88-		 3400 122 201  3482 083 032  1878 004 832  3151 000 034	430 10 MFZ430 430WGTZ KZISZ-5	Je nach Kundenwunsch mit unterschiedlicher Kupplung / Equipped with different clutch according to customer requirement	(35)
32.362 E12,15,17,18	01.88-		 1882 017 131	420 GF420XN	Nebenantriebs-ID / PTO ID: 130	(50)
32.372 E15,17,18	01.88-		 1878 086 941	420 10 420WGTZ	Nebenantriebs-ID / PTO ID: 130	(50)
32.422 E15,17,18	01.88-	D2865, D2866, LF, KF	 3189 600 020		Getr. / GBox: ZF Ecosplit-3	

		CODE				
--	--	------	--	---	---	---























ÖSTERREICHISCHE AUTOMOBILFABRIK (ÖAF)

32...							
32.322 E15	01.89 - 07.97	D2866LF		3400 127 601 ⊗ 3482 078 133 ⊗ 1862 364 031 ⊙ 3151 000 034	400 10 MFZ400 400WGVZ KZISZ-5	Nabenprofil / Hub Profile: 2"-10N Je nach Kundenwunsch mit unterschiedlicher Kupplung / Equipped with different clutch according to customer requirement	(48) (35)
				3400 122 201 ⊗ 3482 083 032 ⊗ 1878 004 832 ⊙ 3151 000 034	430 10 MFZ430 430WGTZ KZISZ-5	Je nach Kundenwunsch mit unterschiedlicher Kupplung / Equipped with different clutch according to customer requirement	(35)
		D2865, D2866, LF, KF		1882 017 131	420 GF420XN	Nebenantriebs-ID / PTO ID: 130	(50)
				1878 086 941	420 10 420WGTZ	Nebenantriebs-ID / PTO ID: 130	(50)
			3483 000 510 ⊕	445 GMFZ445W	für Fahrzeuge mit Wandlerschaltkupplung / for vehicles with converter and clutch unit	(76)	
			1878 051 801	445 24 445GTZC	für Fahrzeuge mit Wandlerschaltkupplung / for vehicles with converter and clutch unit	(76)	
			3189 600 020	Getr. / GBox: ZF Ecosplit-3			
32.362 E12,15,17,18	01.88 -	D2866LF, KF		3400 122 201 ⊗ 3482 083 032 ⊗ 1878 004 832 ⊙ 3151 000 034	430 10 MFZ430 430WGTZ KZISZ-5		
				3189 600 020	Getr. / GBox: ZF Ecosplit-3		

























































33...							
33.273 E69 33.403 E69 33.423 E69 33.463 E69		D2866		3400 122 301 ⊗ 3482 083 032 ⊗ 1878 080 034 ⊙ 3151 000 034	430 10 MFZ430 430WGTZ KZISZ-5	01.1994->	
				3482 114 031	430 GMFZ430N	für Nebenantrieb / for PTO	(82)
				1878 080 034	430 10 430WGTZ	für Nebenantrieb / for PTO	(82)
				3151 263 031	KZIZ-6	für Nebenantrieb / for PTO	(82)
			3483 000 509 ⊕	445 GMFZ445W	für Fahrzeuge mit Wandlerschaltkupplung / for vehicles with converter and clutch unit	(76)	
			1878 051 801	445 24 445GTZC	für Fahrzeuge mit Wandlerschaltkupplung / for vehicles with converter and clutch unit	(76)	
			3189 600 020	Getr. / GBox: ZF Ecosplit-3			

35...							
35.292 E15,17,18,26 35.332 E14,15,17,18,26 35.362 E15,17,18 35.372 E15,17,18 35.422 E15,17,18	01.88 -	D2866LF		3400 127 601 ⊗ 3482 078 133 ⊗ 1862 364 031 ⊙ 3151 000 034	400 10 MFZ400 400WGVZ KZISZ-5	Nabenprofil / Hub Profile: 2"-10N Je nach Kundenwunsch mit unterschiedlicher Kupplung / Equipped with different clutch according to customer requirement	(48) (35)
	01.88 -			3400 122 201 ⊗ 3482 083 032 ⊗ 1878 004 832 ⊙ 3151 000 034	430 10 MFZ430 430WGTZ KZISZ-5	Je nach Kundenwunsch mit unterschiedlicher Kupplung / Equipped with different clutch according to customer requirement	(35)
	01.88 -	D2865, 2866LF, KF		1882 017 131	420 GF420XN	Nebenantriebs-ID / PTO ID: 130	(50)
	01.88 -			1878 086 941	420 10 420WGTZ	Nebenantriebs-ID / PTO ID: 130	(50)
				3189 600 020	Getr. / GBox: ZF Ecosplit-3		





ÖSTERREICHISCHE AUTOMOBILFABRIK (ÖAF)





35...						
35.322 E15	01.89 - 07.97	D2866LF	 3400 127 601 ⊗ 3482 078 133 ⊗ 1862 364 031 ⊙ 3151 000 034	400 10 MFZ400 400WGVZ KZISZ-5	Nabenprofil / Hub Profile: 2"-10N Je nach Kundenwunsch mit unterschiedlicher Kupplung / Equipped with different clutch according to customer requirement	(48) (35)
			 3400 122 201 ⊗ 3482 083 032 ⊗ 1878 004 832 ⊙ 3151 000 034	430 10 MFZ430 430WGTZ KZISZ-5	Je nach Kundenwunsch mit unterschiedlicher Kupplung / Equipped with different clutch according to customer requirement	(35)
		D2865, 2866LF, KF	 1882 017 131	420 GF420XN	Nebenantriebs-ID / PTO ID: 130	(50)
			 1878 086 941	420 10 420WGTZ	Nebenantriebs-ID / PTO ID: 130	(50)
		 3483 000 510 ⊕	445 GMFZ445W	für Fahrzeuge mit Wandlerschaltkupplung / for vehicles with converter and clutch unit	(76)	
		 1878 051 801	445 24 445GTZC	für Fahrzeuge mit Wandlerschaltkupplung / for vehicles with converter and clutch unit	(76)	
		 3189 600 020		Getr. / GBox: ZF Ecosplit-3		
35.373 E68 35.403 E68 35.423 E68 35.463 E68	01.94 - 01.94 - 01.94 - 01.94 -	D2866LF21, D2866LF20, D2866LF22, D2876LF02	 3400 122 301 ⊗ 3482 083 032 ⊗ 1878 080 034 ⊙ 3151 000 034	430 10 MFZ430 430WGTZ KZISZ-5	06.1996->	
			 3400 700 327 ⊗ 3482 114 031 ⊗ 1878 004 832 ⊙ 3151 263 031	430 10 GMFZ430N 430WGTZ KZIZ-6	für Nebenantrieb / for PTO	(82)
			 3400 700 641 HD ⊗ 3482 114 031 ⊗ 1878 007 729 ⊙ 3151 263 031	430 10 GMFZ430N 430WGTZ KZIZ-6	Nebenantriebs-ID / PTO ID: NMV 221	(50)
			 3483 000 509 ⊕	445 GMFZ445W	für Fahrzeuge mit Wandlerschaltkupplung / for vehicles with converter and clutch unit	(76)
			 1878 051 801	445 24 445GTZC	für Fahrzeuge mit Wandlerschaltkupplung / for vehicles with converter and clutch unit	(76)
			 3189 600 020		Getr. / GBox: ZF Ecosplit-3	
36...						
36.372 E26 36.422 E26	01.90 - 01.90 -	D2866LF	 3400 122 201 ⊗ 3482 083 032 ⊗ 1878 004 832 ⊙ 3151 000 034	430 10 MFZ430 430WGTZ KZISZ-5		
			 3483 000 510 ⊕	445 GMFZ445W	für Fahrzeuge mit Wandlerschaltkupplung / for vehicles with converter and clutch unit	(76)
		 1878 051 801	445 24 445GTZC	für Fahrzeuge mit Wandlerschaltkupplung / for vehicles with converter and clutch unit	(76)	
		 3189 600 020		Getr. / GBox: ZF Ecosplit-3		
37...						
37.373 E68 37.403 E68 37.423 E68 37.463 E68		D2866	 3400 122 201 ⊗ 3482 083 032 ⊗ 1878 004 832 ⊙ 3151 000 034	430 10 MFZ430 430WGTZ KZISZ-5		
			 3400 700 327 ⊗ 3482 114 031 ⊗ 1878 004 832 ⊙ 3151 263 031	430 10 GMFZ430N 430WGTZ KZIZ-6	für Nebenantrieb / for PTO	(82)
			 3400 700 641 HD ⊗ 3482 114 031 ⊗ 1878 007 729 ⊙ 3151 263 031	430 10 GMFZ430N 430WGTZ KZIZ-6	Nebenantriebs-ID / PTO ID: NMV 221	(50)
		 3483 000 509 ⊕	445 GMFZ445W	für Fahrzeuge mit Wandlerschaltkupplung / for vehicles with converter and clutch unit	(76)	
		 1878 051 801	445 24 445GTZC	für Fahrzeuge mit Wandlerschaltkupplung / for vehicles with converter and clutch unit	(76)	
		 3189 600 020		Getr. / GBox: ZF Ecosplit-3		





ÖSTERREICHISCHE AUTOMOBILFABRIK (ÖAF)



41...									
41.292 E15,17,18,26 41.332 E15,17,18,26 41.362 E12,15,17,18,26 41.372 E12,15,17,18,26 41.422 E12,15,17,18	01.88-	D2866LF		3400 127 601  3482 078 133  1862 364 031  3151 000 034	400 10 MFZ400 400WGVZ KZISZ-5	Nebenprofil / Hub Profile: 2"-10N Je nach Kundenwunsch mit unterschiedlicher Kupplung / Equipped with different clutch according to customer requirement	(48) (35)		
	01.88-			3400 122 201  3482 083 032  1878 004 832  3151 000 034	430 10 MFZ430 430WGTZ KZISZ-5	Je nach Kundenwunsch mit unterschiedlicher Kupplung / Equipped with different clutch according to customer requirement	(35)		
	01.88-	D2865, 2866LF, KF		1882 017 131	420 GF420XN	Nebenantriebs-ID / PTO ID: 130	(50)		
	01.88-			1878 086 941	420 10 420WGTZ	Nebenantriebs-ID / PTO ID: 130	(50)		
					3189 600 020		Getr. / GBox: ZF Ecosplit-3		
41.322 E15	01.89-07.97	D2866LF		3400 127 601  3482 078 133  1862 364 031  3151 000 034	400 10 MFZ400 400WGVZ KZISZ-5	Nebenprofil / Hub Profile: 2"-10N Je nach Kundenwunsch mit unterschiedlicher Kupplung / Equipped with different clutch according to customer requirement	(48) (35)		
				3400 122 201  3482 083 032  1878 004 832  3151 000 034	430 10 MFZ430 430WGTZ KZISZ-5	Je nach Kundenwunsch mit unterschiedlicher Kupplung / Equipped with different clutch according to customer requirement	(35)		
			D2865, 2866LF, KF		1882 017 131	420 GF420XN	Nebenantriebs-ID / PTO ID: 130	(50)	
					1878 086 941	420 10 420WGTZ	Nebenantriebs-ID / PTO ID: 130	(50)	
						3483 000 510 ⊕	445 GMFZ445W	für Fahrzeuge mit Wandlerschaltkupplung / for vehicles with converter and clutch unit	(76)
						1878 051 801	445 24 445GTZC	für Fahrzeuge mit Wandlerschaltkupplung / for vehicles with converter and clutch unit	(76)
						3189 600 020		Getr. / GBox: ZF Ecosplit-3	
41.373 E68,78 41.403 E68,78 41.423 E68,78 41.463 E68,78		D2866		3400 122 201  3482 083 032  1878 004 832  3151 000 034	430 10 MFZ430 430WGTZ KZISZ-5	E68			
				3400 700 327  3482 114 031  1878 004 832  3151 263 031	430 10 GMFZ430N 430WGTZ KZIZ-6	für Nebenantrieb / for PTO	(82)		
				3400 700 641 HD  3482 114 031  1878 007 729  3151 263 031	430 10 GMFZ430N 430WGTZ KZIZ-6	Nebenantriebs-ID / PTO ID: NMV 221	(50)		
				3400 122 201  3482 083 032  1878 004 832  3151 000 034	430 10 MFZ430 430WGTZ KZISZ-5	06.1996-> E78			
			D2866LF21		3400 122 301  3482 083 032  1878 080 034  3151 000 034	430 10 MFZ430 430WGTZ KZISZ-5	06.1996-> E68		
					3189 600 020		Getr. / GBox: ZF Ecosplit-3		
41.462 E12 41.502 E12	01.85-	D2840LF		3400 121 901  3488 017 333  1862 303 031  3151 000 034	400 10 MFZ2/400X 400WGVZ KZISZ-5	für Fahrzeuge mit Zweischeibenkupplung / for vehicles with double disc clutch Je nach Kundenwunsch mit unterschiedlicher Kupplung / Equipped with different clutch according to customer requirement	(77) (35)		
	01.85-			3400 122 201  3482 083 032  1878 004 832  3151 000 034	430 10 MFZ430 430WGTZ KZISZ-5	Je nach Kundenwunsch mit unterschiedlicher Kupplung / Equipped with different clutch according to customer requirement	(35)		
					3483 000 510 ⊕	445 GMFZ445W	für Fahrzeuge mit Wandlerschaltkupplung / for vehicles with converter and clutch unit	(76)	
					1878 051 801	445 24 445GTZC	für Fahrzeuge mit Wandlerschaltkupplung / for vehicles with converter and clutch unit	(76)	
					3189 600 020		Getr. / GBox: ZF Ecosplit-3		

ÖSTERREICHISCHE AUTOMOBILFABRIK (ÖAF)



42..						
42.373 E78	01.94-	D2866		3400 122 201 ⊗ 3482 083 032 ⊗ 1878 004 832 ⊙ 3151 000 034	430 10 MFZ430 430WGTZ KZISZ-5	06.1996->
42.403 E78	01.94-					
42.423 E78	01.94-			3400 700 327 ⊗ 3482 114 031 ⊗ 1878 004 832 ⊙ 3151 263 031	430 10 GMFZ430N 430WGTZ KZIZ-6	für Nebenantrieb / for PTO (82)
42.463 E78	01.94-			3400 700 641 HD ⊗ 3482 114 031 ⊗ 1878 007 729 ⊙ 3151 263 031	430 10 GMFZ430N 430WGTZ KZIZ-6	Nebenantriebs-ID / PTO ID: NMV 221 (50)
				3189 600 020		Getr. / GBox: ZF Ecosplit-3

47...						
47.292 E15,17,18,26	01.88-	D2865, 2866LF, KF		3400 127 601 ⊗ 3482 078 133 ⊗ 1862 364 031 ⊙ 3151 000 034	400 10 MFZ400 400WGVZ KZISZ-5	Nabenprofil / Hub Profile: 2"-10N Je nach Kundenwunsch mit unterschiedlicher Kupplung / Equipped with different clutch according to customer requirement (48) (35)
47.332 E15,17,18	01.88-					
47.362 E12,15,17,18	01.88-			3400 122 201 ⊗ 3482 083 032 ⊗ 1878 004 832 ⊙ 3151 000 034	430 10 MFZ430 430WGTZ KZISZ-5	Je nach Kundenwunsch mit unterschiedlicher Kupplung / Equipped with different clutch according to customer requirement (35)
				1882 017 131	420 GF420XN	Nebenantriebs-ID / PTO ID: 130 (50)
				1878 086 941	420 10 420WGTZ	Nebenantriebs-ID / PTO ID: 130 (50)
				3189 600 020		Getr. / GBox: ZF Ecosplit-3

48...						
48.372 E17,18	01.89-	D2866LF, KF		3400 122 201 ⊗ 3482 083 032 ⊗ 1878 004 832 ⊙ 3151 000 034	430 10 MFZ430 430WGTZ KZISZ-5	
48.402 E18	01.89-					
48.422 E17,18	01.89-			1882 017 131	420 GF420XN	für Nebenantrieb / for PTO (82)
				1878 086 941	420 10 420WGTZ	für Nebenantrieb / for PTO (82)
				3189 600 020		Getr. / GBox: ZF Ecosplit-3



E 2000						
26.414.DFARC E40	01.97-03.04	D2866LF03, D2866LF25		3400 122 201 ⊗ 3482 083 032 ⊗ 1878 004 832 ⊙ 3151 000 034	430 10 MFZ430 430WGTZ KZISZ-5	Getr. / GBox: ZF / EATON
26.414.DFRC E40	01.97-03.04					
26.464.DFARC E40	01.97-03.04			3189 600 020		Getr. / GBox: ZF Ecosplit-3
26.464.DFLRS E40	01.97-03.04					

F...						
FKD -160				1878 001 074	350 10 350GTZ	
				3151 000 395	KZIS-4	

K...						
K 16-180E				1878 001 074	350 10 350GTZ	
				3151 000 395	KZIS-4	
KA 200				1882 325 134	380 G380	

L...						
L 200 L 200 /1-3 LA 200 LA 200 /1 A LA 200 /1-2				1882 325 134	380 G380	

ÖSTERREICHISCHE AUTOMOBILFABRIK (ÖAF)







O...						
ORZT 66 L			 1861 206 211 #	420 10 420GS		
			 1863 600 123	GR-4	mit Anlauftring / with thrust ring	(88)





S...						
SAF 200 /38 SAFD 200 /33 SF 200 /33 SF 200 /36			 1882 325 134	380 G380		





T...						
TSH 158 TSH 158 /1			 1861 206 211 #	420 10 420GS		
			 1863 600 123	GR-4	mit Anlauftring / with thrust ring	(88)

Z...						
Z 200 ZA 200 ZA 200 /1-4 ZAFD 200 /36			 1882 325 134	380 G380		

RENAULT TRUCKS



















































B 01.83 - 09.95						
80	10.82 -		 1850 280 790 #	235 MF235	Nur bei Altteil-Rückgabe lieferbar (Reparatur; Werk Bielefeld) / Please return old unit for repair (plant Bielefeld)	(51)
			 1878 001 713 ▲	235 10 235VTB		
			 3151 600 751	KZAS-0		
			 1863 869 041			
110	10.92 - 01.96	Sofim8140.27	 3499 373 055	250 MF250	Getr. / GBox: ZF	
			 1897 375 775	KZA-5	Getr. / GBox: ZF	
			 1863 869 041			

B Kasten/Kombi 01.83 - 01.92						
70	01.83 - 12.90	8140.61.235	 1850 280 790 #	235 MF235	Nur bei Altteil-Rückgabe lieferbar (Reparatur; Werk Bielefeld) / Please return old unit for repair (plant Bielefeld)	(51)
			 1878 001 713 ▲	235 10 235VTB		
			 3151 600 751	KZAS-0		
90, 68 kW 90, 71 kW	04.86 - 09.90 08.90 - 01.92	8140.21.235IDS 8140.27.2530ID S	 3499 373 055	250 MF250	Getr. / GBox: ZF	
			 1897 375 775	KZA-5	Getr. / GBox: ZF	



































B Pritsche/Fahrgestell 01.83 - 06.99						
70	01.83 - 12.90	8140.61.235	 1850 280 790 #	235 MF235	Nur bei Altteil-Rückgabe lieferbar (Reparatur; Werk Bielefeld) / Please return old unit for repair (plant Bielefeld)	(51)
			 1878 001 713 ▲	235 10 235VTB		
			 3151 600 751	KZAS-0		
90, 68 kW 90, 71 kW 90 4x4, 68 kW 90 4x4, 71 kW	04.86 - 09.90 08.90 - 01.92 08.90 - 01.92 08.90 - 01.92	8140.21.235IDS 8140.27.2530ID S	 3499 373 055	250 MF250	Getr. / GBox: ZF	
			 1897 375 775	KZA-5	Getr. / GBox: ZF	

















		CODE				
--	--	------	--	---	---	---

RENAULT TRUCKS









C 10.82 - 10.98						
C 210.19	12.83 - 05.91	MIDS06.20.30N	 3482 037 141	380 GM380		
			 1878 000 960	380 16 380GTZ		
			 3151 000 285	KZI-4		
C 230ti.19	05.90 - 07.92	MIDR06.02.26D	 3482 037 141	380 GM380	Getr. / GBox: G406/409	
			 1878 000 960	380 16 380GTZ	Getr. / GBox: G406/409	
			 3151 000 285	KZI-4	Getr. / GBox: G406/409	
C 260.19 C 260.19,C 280.19 C 260.26	10.82 - 05.91	MIDS06.20.45B	 1878 027 442	430 20 430GTZ	->04.1985 Getr. / GBox: RVI	
	10.82 - 10.98		 3482 097 141	430 GMFZ430	->12.1985 Getr. / GBox: Fuller	
	10.82 - 05.91		 1878 022 841	430 10 430GTZ	->12.1985 Getr. / GBox: Fuller	
			 3400 116 801	430 20 GMFZ430	05.1985-> Getr. / GBox: B9/B18	
			 3482 097 141	430GTZ		
			 1878 027 442	KZISZ-5		
			 3100 008 106			
		 3400 116 601 HD	430 20 GMFZ430	05.1985-> Getr. / GBox: RVI		
		 3482 097 141	430WGTZ			
		 1878 020 241	KZISZ-5			
		 3100 008 106				
		 1882 022 101 #	420 G420XN	Getr. / GBox: 5S-110 Nebenantriebs-ID / PTO ID: 110	(50)	
		 1878 634 014 ▲	420 10 420GSZ	Getr. / GBox: 5S-110 Nebenantriebs-ID / PTO ID: 110	(50)	
C 280.19	07.92 - 03.93	MIDS06.20.45B	 3400 116 801	430 20 GMFZ430	->09.1992 Getr. / GBox: RVI	
			 3482 097 141	430GTZ		
			 1878 027 442	KZISZ-5		
			 3100 008 106			
			 3482 083 044	430 MFZ430	11.1992-> Getr. / GBox: B9	
		 1878 020 241	430 20 430WGTZ	11.1992-> Getr. / GBox: B9		
		 1878 027 442	430 20 430GTZ	11.1992-> Getr. / GBox: B9		
		 3100 008 106	KZISZ-5	11.1992-> Getr. / GBox: B9		
		 3151 234 132	KZISZ-5	Beinhaltet Ausrücker und Montagesatz / Contains releaser and fitting kit	(9)	
		 3180 000 009				
C 290.19,C 300.19 C 290.26,C 300.26	10.82 - 10.98	MIDR062045B	 3400 116 601	430 20 GMFZ430	Getr. / GBox: B9/B18	
	10.82 - 10.98		 3482 097 141	430WGTZ		
			 1878 020 241	KZISZ-5		
			 3100 008 106			
			 3482 097 141	430 GMFZ430	Getr. / GBox: Fuller RTO 9505	
		 3482 097 141	430 GMFZ430	Getr. / GBox: Fuller RTX 116.09		
		 1878 022 841	430 10 430GTZ	Getr. / GBox: Fuller		
		 3100 008 106	KZISZ-5	Getr. / GBox: Fuller RTX 116.09		
		 3151 234 132	KZISZ-5	Beinhaltet Ausrücker und Montagesatz / Contains releaser and fitting kit	(9)	
		 3180 000 009				
C 290.19/T C 290.26,C 300.26	05.86 - 05.91	MIDR062045B	 3400 116 801	430 20 GMFZ430	Getr. / GBox: RVI	
	05.86 - 10.98		 3482 097 141	430GTZ		
			 1878 027 442	KZISZ-5		
		 3100 008 106				
		 3400 116 601	430 20 GMFZ430	Getr. / GBox: B9/B18		
		 3482 097 141	430WGTZ			
		 1878 020 241	KZISZ-5			
		 3100 008 106				
		 3400 700 336	430 10 GMFZ430	Getr. / GBox: Fuller		
		 3482 097 141	430GTZ			
		 1878 022 841	KZISZ-5			
		3100 008 106				

























RENAULT TRUCKS

C		10.82 - 10.98				
C 300.19 C 300.24 C 300.26 CCH 300.26 CCH 300.30	04.87 - 10.98 04.87 - 10.98 04.87 - 10.98 09.90 - 03.93 09.90 - 03.93	MIDR062045D 	 3400 116 601  3482 097 141  1878 020 241  3100 008 106	430 20 GMFZ430 430WGTZ KZISZ-5	->09.1992 Getr. / GBox: B9/B18	
			 3400 116 801 ●  3482 097 141  1878 027 442  3100 008 106	430 20 GMFZ430 430GTZ KZISZ-5	->09.1992 Getr. / GBox: B9/B18	
			 3400 117 202  3482 083 044  1878 020 241  3100 008 106	430 20 MFZ430 430WGTZ KZISZ-5	10.1992-> Getr. / GBox: B9	
			 3400 117 201  3482 083 044  1878 020 241  3100 008 204	430 20 MFZ430 430WGTZ	10.1992-> Getr. / GBox: B9+35mm,B18	
			 3400 116 701  3482 097 141  1878 026 241  3100 008 106	430 10 GMFZ430 430WGTZ KZISZ-5	10.1992-> Getr. / GBox: ZF S6-90	
			 3400 116 901  3482 083 044  1878 026 241  3100 008 106	430 10 MFZ430 430WGTZ KZISZ-5	10.1992-> Getr. / GBox: ZF 9S-109	
C 340.19/T C 340ti.17/T C 340ti.19/T	07.90 - 10.98 07.90 - 10.98 07.90 - 10.98	MIDR062045E	 3400 116 601  3482 097 141  1878 020 241  3100 008 106	430 20 GMFZ430 430WGTZ KZISZ-5	->09.1992 Getr. / GBox: B9/B18	
			 3400 117 101  3482 123 243  1878 020 241  3100 008 204	430 20 MFZ430 430WGTZ	10.1992-> Getr. / GBox: B9+35mm,B18	
			 3400 123 101 #  3482 123 243  1878 020 241  3100 008 106	430 20 MFZ430 430WGTZ KZISZ-5	10.1992-> Getr. / GBox: B9	

C-Serie		01.13 -				
250P 250P, 250PK 280P 280P, 280PK 320P 320P, 320PK 250FG P 250FG P, 250FG PK 280FG P 280FG P, 280FG PK 320FG P 320FG P, 320FG PK	01.13- 01.13- 01.13- 01.13- 01.13- 01.13- 01.13- 01.13- 01.13- 01.13- 01.13-	DTI8-122HQ, DTI8-122HS, DTI8-122HR	 3400 700 466 (M)  3482 634 003  1878 634 034  3151 000 752	395 10 MF395 395WGTZ KZIS-4	Getr. / GBox: ZF6S 1000 TO	
			 3400 700 628  3482 634 003  1878 007 939  3151 000 752	395 10 MF395 395WGTZ KZIS-4	Getr. / GBox: ZF6AS 1000 TO	
			 1863 869 039	52	Getr. / GBox: ZF6S 1000 TO Getr. / GBox: ZF6AS 1000 TO	
			 3189 600 045		Getr. / GBox: ZF 6S/6AS-800/1000	
380P 380P, 380PK 380P, 380PK, 380P XLOAD 380T, 380TK 430P 430P, 430PK 430P, 430PK, 430P XLOAD 430T, 430TK 460P 460P, 460PK 460P, 460PK, 460P XLOAD 460T, 460TK 380FG P 380T 430FG P 430T	01.13- 01.13- 01.13- 01.13- 01.13- 01.13- 01.13- 01.13- 01.13- 01.13- 01.13- 01.13- 01.13- 01.13- 01.13- 01.13- 01.13- 01.13- 01.13- 01.13-	DTI11	 3400 700 600 (M+)  3483 000 348  1878 007 046	430 24 MFZ430 430WGTZ	Getr. / GBox: MT 2214B / MT 2514B Getr. / GBox: MTO 2214B/MTO 2514B Euro 6 / Euro 6	(18)
			 3400 710 064  3482 001 310  1878 007 170  6482 000 155	430 24 MF430 430WGTZ PHIS-6/38	Getr. / GBox: AT 2412/E /AT 2612/E Getr. / GBox: ATO 2612/E Euro 6 / Euro 6	(18)























RENAULT TRUCKS

C-Serie		01.13 -					
440P 440P, 440PK 440T, 440TK 480P 480P, 480PK 480T, 480TK	01.13- 01.13- 01.13- 01.13- 01.13- 01.13-	DTI13	 	3400 700 600  ⊗ 3483 000 348 ⊗ 1878 007 046	430 24 MFZ430 430WGTZ	Getr. / GBox: MT 2214B / MT 2514B Getr. / GBox: MTO 2214B/MTO 2514B Euro 6 / Euro 6	(18)
				3400 710 064 ⊗ 3482 001 310 ⊗ 1878 007 170 ⚡ 6482 000 155	430 24 MF430 430WGTZ PHIS-6/38	Getr. / GBox: AT 2412/E / AT 2612/E Getr. / GBox: ATO 2612/E Euro 6 / Euro 6	(18)
520P 520P, 520PK 520T, 520TK	01.13- 01.13- 01.13-	DTI13	 	3400 700 600  ⊗ 3483 000 348 ⊗ 1878 007 046	430 24 MFZ430 430WGTZ	Getr. / GBox: MTO 2514B Euro 6 / Euro 6	(18)
				3400 710 064 ⊗ 3482 001 310 ⊗ 1878 007 170 ⚡ 6482 000 155	430 24 MF430 430WGTZ PHIS-6/38	Getr. / GBox: AT2612/E / ATO2612/E Euro 6 / Euro 6	(18)



CBH							
CBH 280.26 CBH 280.26/T CBH 280.34 CBH 280.34/T	04.86 - 10.92 04.86 - 10.92 04.86 - 10.92 04.86 - 10.92	MIDS063540	   	3482 097 141 1878 022 841 3400 116 601 ⊗ 3482 097 141 ⊗ 1878 020 241 ⚡ 3100 008 106	430 GMFZ430 430 10 430GTZ 430 20 GMFZ430 430WGTZ KZISZ-5	-> 05.1986 Getr. / GBox: Fuller RTO 9509 -> 05.1986 Getr. / GBox: Fuller RTO 9509 Getr. / GBox: RVI	
				3400 123 201 ▲ ⊗ 3482 123 441 ⊗ 1878 022 841 ⚡ 3100 008 106	430 10 GMFZ430 430GTZ KZISZ-5	Getr. / GBox: Fuller RTX 113.09	
CBH 320.24 CBH 320.24/T CBH 320.34 CBH 320.34/T	10.92 - 10.98 10.92 - 10.98 10.92 - 10.98 10.92 - 10.98	MIDR06.35.40M 3	   	3400 117 202 ⊗ 3482 083 044 ⊗ 1878 020 241 ⚡ 3100 008 106	430 20 MFZ430 430WGTZ KZISZ-5	Getr. / GBox: B9	
				3400 117 201 ⊗ 3482 083 044 ⊗ 1878 020 241 ⚡ 3100 008 204	430 20 MFZ430 430WGTZ	Getr. / GBox: B9+35mm,B18	
				3483 000 510 ⊕	445 GMFZ445W	für Fahrzeuge mit Wandlerschaltkupplung / for vehicles with converter and clutch unit	(76)
				1878 051 801	445 24 445GTZC	für Fahrzeuge mit Wandlerschaltkupplung / for vehicles with converter and clutch unit	(76)
CBH 320.26 CBH 320.26/T	10.92 - 10.98 10.92 - 10.98	MIDR06.35.40M 3	 	3400 117 202 ⊗ 3482 083 044 ⊗ 1878 020 241 ⚡ 3100 008 106	430 20 MFZ430 430WGTZ KZISZ-5	Getr. / GBox: B9	
				3400 117 201 ⊗ 3482 083 044 ⊗ 1878 020 241 ⚡ 3100 008 204	430 20 MFZ430 430WGTZ	Getr. / GBox: B9+35mm,B18	
CBH 340.26	02.88 - 10.92	MIDR063540	 	3400 116 601 ⊗ 3482 097 141 ⊗ 1878 020 241 ⚡ 3100 008 106	430 20 GMFZ430 430WGTZ KZISZ-5	Getr. / GBox: B9/B18 Getr. / GBox: RVI	
				3400 117 001 ⊗ 3482 123 441 ⊗ 1878 020 241 ⚡ 3100 008 106	430 20 GMFZ430 430WGTZ KZISZ-5	für / for: TELMA Getr. / GBox: B9/B18	(69)
CBH 340.26	02.88 - 10.92	MIDR063540	 	3400 116 601 ⊗ 3482 097 141 ⊗ 1878 020 241 ⚡ 3100 008 106	430 20 GMFZ430 430WGTZ KZISZ-5	Getr. / GBox: B9/B18 Getr. / GBox: RVI	
				3400 117 001 ⊗ 3482 123 441 ⊗ 1878 020 241 ⚡ 3100 008 106	430 20 GMFZ430 430WGTZ KZISZ-5	für / for: Telma Getr. / GBox: B9/B18	(69)
CBH 350.26 CBH 350.34	05.90 - 01.93 05.90 - 01.93	MIDR063540G	 	3400 116 601 ⊗ 3482 097 141 ⊗ 1878 020 241 ⚡ 3100 008 106	430 20 GMFZ430 430WGTZ KZISZ-5	-> 10.1992 Getr. / GBox: B9/B18	
				3400 117 001 HD ⊗ 3482 123 441 ⊗ 1878 020 241 ⚡ 3100 008 106	430 20 GMFZ430 430WGTZ KZISZ-5	-> 10.1992 Getr. / GBox: B9/B18	
CBH 380.26 CBH 380.34	01.90 - 10.92 01.90 - 10.92	MIDR063540		3400 117 001	430 20	Getr. / GBox: B9/B18	







		CODE				
--	--	------	--	---	---	---

RENAULT TRUCKS

CBH						
CBH 385.24	10.92 - 10.98	MIDR06.35.40N/3		3400 117 001 ⊗ 3482 123 441 ⊗ 1878 020 241 ⊙ 3100 008 106	430 20 GMFZ430 430WGTZ KZISZ-5	->10.1992 Getr. / GBox: B9/B18
CBH 385.26	10.92 - 10.98					
CBH 385.34	10.92 - 10.98					
CBH 385.34/T	10.92 - 10.98			3400 093 031 ⊕ ⊗ 3488 017 334 ⊗ 1862 379 031	400 20 MFZ2/400X 400WGVZ	10.1992 - 10.1996
				3483 000 510 ⊕	445 GMFZ445W	für Fahrzeuge mit Wandlerschaltkupplung / for vehicles with converter and clutch unit (76)
				1878 051 801	445 24 445GTZC	für Fahrzeuge mit Wandlerschaltkupplung / for vehicles with converter and clutch unit (76)
CBH 385.24	10.92 - 10.98	MIDR06.35.40N/3		3400 117 001 ⊗ 3482 123 441 ⊗ 1878 020 241 ⊙ 3100 008 106	430 20 GMFZ430 430WGTZ KZISZ-5	->10.1992 Getr. / GBox: B9/B18
CBH 385.26	10.92 - 10.98					
CBH 385.26/T	10.92 - 10.98			3400 093 031 ⊕ ⊗ 3488 017 334 ⊗ 1862 379 031	400 20 MFZ2/400X 400WGVZ	10.1992 - 10.1996
CLM						
CLM 280	11.92 -	MIDS063540		3400 116 601 ⊗ 3482 097 141 ⊗ 1878 020 241 ⊙ 3100 008 106	430 20 GMFZ430 430WGTZ KZISZ-5	Getr. / GBox: B9/B18
				3400 123 201 ▲ ⊗ 3482 123 441 ⊗ 1878 022 841 ⊙ 3100 008 106	430 10 GMFZ430 430GTZ KZISZ-5	Getr. / GBox: Eaton RTX 11609B
CLM 280.19/T	04.86 - 10.92	MIDS063540		3482 097 141	430 GMFZ430	->07.1986 Getr. / GBox: Fuller RTO 9509
				1878 022 841	430 10 430GTZ	->07.1986 Getr. / GBox: Fuller RTO 9509
				3400 116 601 ⊗ 3482 097 141 ⊗ 1878 020 241 ⊙ 3100 008 106	430 20 GMFZ430 430WGTZ KZISZ-5	Getr. / GBox: B9/B18
				3400 123 201 ▲ ⊗ 3482 123 441 ⊗ 1878 022 841 ⊙ 3100 008 106	430 10 GMFZ430 430GTZ KZISZ-5	Getr. / GBox: Eaton RTX 11609 B
CLM 320.19/T	10.92 - 10.98	MIDR06.35.40M/3		3400 117 202 ⊗ 3482 083 044 ⊗ 1878 020 241 ⊙ 3100 008 106	430 20 MFZ430 430WGTZ KZISZ-5	Getr. / GBox: B9
CLM 320.25/T	10.92 - 10.98			3400 117 201 ⊗ 3482 083 044 ⊗ 1878 020 241 ⊙ 3100 008 204	430 20 MFZ430 430WGTZ	Getr. / GBox: B9+35mm,B18
				3483 000 510 ⊕	445 GMFZ445W	für Fahrzeuge mit Wandlerschaltkupplung / for vehicles with converter and clutch unit (76)
				1878 051 801	445 24 445GTZC	für Fahrzeuge mit Wandlerschaltkupplung / for vehicles with converter and clutch unit (76)
CLM 340 T	- 09.92	MIDR063540		3400 117 001 HD ⊗ 3482 123 441 ⊗ 1878 020 241 ⊙ 3100 008 106	430 20 GMFZ430 430WGTZ KZISZ-5	Getr. / GBox: B9/B18
CLM 380.19/T	05.91 - 10.92			3400 116 601 ⊗ 3482 097 141 ⊗ 1878 020 241 ⊙ 3100 008 106	430 20 GMFZ430 430WGTZ KZISZ-5	Getr. / GBox: B9/B18
CLM 350	- 09.92	MIDR063540		3400 116 601 ⊗ 3482 097 141 ⊗ 1878 020 241 ⊙ 3100 008 106	430 20 GMFZ430 430WGTZ KZISZ-5	Getr. / GBox: B9/B18
CLM 385.19/T	10.92 - 10.98	MIDR06.35.40N/3		3400 093 031 ⊕ ⊗ 3488 017 334 ⊗ 1862 379 031	400 20 MFZ2/400X 400WGVZ	Getr. / GBox: B9/B18
CLM 385.22/T	10.92 - 10.98			3483 000 510 ⊕	445 GMFZ445W	für Fahrzeuge mit Wandlerschaltkupplung / for vehicles with converter and clutch unit (76)
CLM 385.25/T	10.92 - 10.98			1878 051 801	445 24 445GTZC	für Fahrzeuge mit Wandlerschaltkupplung / for vehicles with converter and clutch unit (76)



















RENAULT TRUCKS

CLR						
220		MIDS062030	 3482 037 141	380 GM380	Getr. / GBox: B6 Für Export / for export	(27)
			 3151 000 285	KZI-4	Getr. / GBox: B6 Für Export / for export	(27)
220 (11G.)		MIDS062030	 3482 037 141	380 GM380	Getr. / GBox: BD SL 132 + Relais Für Export / for export	(27)
			 3151 000 285	KZI-4	Getr. / GBox: BD SL 132 + Relais Für Export / for export	(27)
230 CLR 230.19	10.92 - 09.90 - 10.98	MIDR062226D	 3482 037 141	380 GM380	Getr. / GBox: G406/409	
			 3151 000 285	KZI-4	Getr. / GBox: G406/409	

D-Serie 01.13 -						
10 P 210	01.13-	DTI5-122HN, DTI5-122HP		3400 700 627	395 10	Getr. / GBox: 6AS 800TO
10 P 240	01.13-			 3482 634 003	MF395	Getr. / GBox: 6AS 1000TO
12 P 210	01.13-			 1878 007 934	395WGTZ	Getr. / GBox: 6S 800, 6S 1000TO
12 P 240	01.13-			 3151 000 752	KZIS-4	
13 P 210, 13 KP 210	01.13-			1863 869 039	52	Getr. / GBox: 6AS 800TO
13 P 240, 13 KP 240	01.13-					Getr. / GBox: 6AS 1000TO
14 P 210, 14 KP 210	01.13-					Getr. / GBox: 6S 800, 6S 1000TO
14 P 240, 14 KP 240	01.13-					Getr. / GBox: ZF 6S/6AS-800/1000
16 P 210, 16 KP 210	01.13-			3189 600 045		
16 P 240, 16 KP 240	01.13-					

		CODE				
--	--	------	--	---	---	---





























RENAULT TRUCKS

D-Serie		01.13 -																																																																												
12 KP 250	01.13-	DTI8-122HQ, DTI8-122HS, DTI8-122HR, DTI3	 3400 700 466   3482 634 003  1878 634 034  3151 000 752	395 10 MF395 395WGTZ KZIS-4	Getr. / GBox: ZF6S 1000 TO																																																																									
12 KP 280	01.13-				 3400 700 628  3482 634 003  1878 007 939  3151 000 752	395 10 MF395 395WGTZ KZIS-4	Getr. / GBox: ZF6AS 1000 TO																																																																							
12 P 250	01.13-						 1863 869 039	52	Getr. / GBox: ZF6S 1000 TO Getr. / GBox: ZF6AS 1000 TO																																																																					
12 P 280	01.13-								 3189 600 045		Getr. / GBox: ZF 6S/6AS-800/1000																																																																			
13 P 250, 13 KP 250	01.13-																																																																													
13 P 280, 13 KP 280	01.13-																																																																													
14 KP 250	01.13-																																																																													
14 P 250	01.13-																																																																													
14 P 250, 14 KP 250	01.13-																																																																													
14 P 280, 14 KP 280	01.13-																																																																													
16 KP 250	01.13-																																																																													
16 KP 280	01.13-																																																																													
16 P 250	01.13-																																																																													
16 P 250, 16 KP 250	01.13-																																																																													
16 P 280, 16 KP 280	01.13-																																																																													
18 ACCESS P 280	01.13-																																																																													
18 ACCESS P 320	01.13-																																																																													
18 P 250	01.13-																																																																													
18 P 250, 18 KP 250	01.13-																																																																													
18 P 280	01.13-																																																																													
18 P 280, 18 KP 280	01.13-																																																																													
18 P 320	01.13-																																																																													
18 P 320, 18 KP 320	01.13-																																																																													
18 T 280	01.13-																																																																													
18 T 320	01.13-																																																																													
25 P 250	01.13-																																																																													
25 P 280	01.13-																																																																													
25 P 320	01.13-																																																																													
26 ACCESS P 280	01.13-																																																																													
26 ACCESS P 320	01.13-																																																																													
26 P 250	01.13-																																																																													
26 P 250, 26 KP 250	01.13-																																																																													
26 P 280	01.13-																																																																													
26 P 280, 26 KP 280	01.13-																																																																													
26 P 320	01.13-																																																																													
26 P 320, 26 KP 320	01.13-																																																																													
6.5 P 150	01.16-																																																																													
7.5 P 180	01.16-																																																																													
18 P 380, 18 FG 380	01.13-																																																																		DTI11	 3400 700 600   3483 000 348  1878 007 046	430 24 MFZ430 430WGTZ	Getr. / GBox: MT 2214B / MT 2514B Getr. / GBox: MTO 2214B/MTO 2514B Euro 6 / Euro 6								
18 P 430, 18 FG 430	01.13-																																																																					 3400 710 064  3482 001 310  1878 007 170  6482 000 155	430 24 MF430 430WGTZ PHIS-6/38	Getr. / GBox: AT 2412/E /AT 2612/E Getr. / GBox: ATO 2612/E Euro 6 / Euro 6	(18)					
18 T 380	01.13-																																																																													
18 T 430	01.13-																																																																													

F			
620	 1878 001 729	350 10 350GTD	

G		10.82 - 09.91						
G 170.11	05.83 - 02.90	MIDR06.02.12D	 3482 124 041	350 MF350	Getr. / GBox: Fuller RTX 7609			
G 170.13	05.83 - 02.90				 3151 000 285	350 MF350	Getr. / GBox: Fuller RTX 7609	
G 170.15	05.83 - 02.90	MIDR060212	 3482 124 041 	350 MF350			Getr. / GBox: RVI	
G 170.16	05.83 - 02.90				 1878 002 075 # 	350 16 350GTZ	Getr. / GBox: RVI	
G 170.17	05.83 - 02.90						 3151 000 285 	350 16 350GTZ



















RENAULT TRUCKS

G 10.82 - 09.91						
G 200.13	05.90 - 09.91	MIDR060226H		3400 700 339  3482 124 041  1878 001 729  3151 270 341	350 10 MF350 350GTD KZIS-3	Getr. / GBox: ZF S6-36S
G 200.15	05.90 - 09.91					
G 200.16	05.90 - 09.91					
G 200.17	05.90 - 09.91					
G 200.18	05.90 - 09.91					
G 210.16	11.83 - 02.90	MIDS06.20.45,		3482 037 141	380 GM380	Getr. / GBox: G406/409
G 210.16/T	11.83 - 02.90	MIDR06.02.26D,				
G 210.19/T	11.83 - 02.90	MIDS06.20.45J,				
G 220.17 BOM	03.91 - 09.91	MIDS06.20.30P,				
G 220.19 BOM	03.91 - 09.91	MIDR06.20.45,				
G 230.19/T	01.85 - 03.93	MIDS06.20.30N				
G 230ti.13	02.90 - 08.91	1,				
G 230ti.19	02.90 - 08.91	MIDR06.20.45D,				
G 260.19	10.82 - 05.90	MIDS06.20.30N				
G 260.19/T	10.82 - 05.90					
G 290.19	11.85 - 12.89					
G 290.19/T	11.85 - 12.89					
G 210.17 BOM	11.83 - 02.90	MIDS062030		1864 497 043	430 16 430Z	Getr. / GBox: B6 Getr. / GBox: G406/409
G 210.18 BOM	11.83 - 02.90					
G 210.19 BOM	11.83 - 02.90					
G 210.19	11.83 - 02.90	MIDS062030		3482 037 141	380 GM380	Getr. / GBox: RVI
				3151 000 285	KZI-4	Getr. / GBox: RVI
G 230.11	01.85 - 05.90	MIDO62030		3482 037 141	380 GM380	
G 230.13	01.85 - 05.90					
G 230.13 SP	01.85 - 08.91					
G 230.15	01.85 - 05.90					
G 230.15/T	01.85 - 05.90					
G 230.16	01.85 - 05.90					
G 230.17	01.85 - 05.90					
G 230.17/T	01.85 - 05.90					
G 230.19	01.85 - 05.90					
G 230ti.15	02.90 - 08.91	MIDR06.02.26D		3482 037 141	380 GM380	Getr. / GBox: G406/409
G 230ti.16	02.90 - 08.91					
G 230ti.17	02.90 - 08.91			3151 000 285	KZI-4	Getr. / GBox: G406/409
G 230ti.18	02.90 - 08.91					
G 230ti.19	02.90 - 08.91					
G 260.15/T	10.82 - 05.90	MIDS062045		3400 116 801  3482 097 141  1878 027 442  3100 008 106	430 20 GMFZ430 430GTZ KZISZ-5	04.1985-> Getr. / GBox: RVI
G 260.16	10.82 - 05.90					
G 260.17	10.82 - 05.90					
G 260.17/T	10.82 - 05.90			3482 097 141	430 GMFZ430	->05.1985 Getr. / GBox: Fuller
G 260.19	10.82 - 05.90					
G 260.19	10.82 - 05.90			1878 022 841	430 10 430GTZ	->05.1985 Getr. / GBox: Fuller
G 260.19/T	10.82 - 05.90					
G 260.22/T	10.82 - 05.90					
G 260.24 CIT	10.82 - 05.90					
G 260.17	01.90 - 09.91	MIDS062045		3400 116 801  3482 097 141  1878 027 442  3100 008 106	430 20 GMFZ430 430GTZ KZISZ-5	Getr. / GBox: RVI
G 280.13	01.90 - 09.91	MIDS062045B		3400 116 801  3482 097 141  1878 027 442  3100 008 106	430 20 GMFZ430 430GTZ KZISZ-5	Getr. / GBox: RVI
G 280.15	01.90 - 09.91					
G 280.15/T	01.90 - 09.91					
G 280.16	01.90 - 09.91			1882 022 101 #	420 G420XN	Getr. / GBox: 16S-130 Nebenantriebs-ID / PTO ID: 130 (50)
G 280.18	01.90 - 09.91					
G 280.19	01.90 - 09.91			1878 003 276	420 10 420GTZ	Getr. / GBox: 16S-130 Nebenantriebs-ID / PTO ID: 130 (50)
G 280.24	01.90 - 09.91					
G 280.26	01.90 - 09.91			3151 204 001	KZI-6	Getr. / GBox: 16S-130 mit Schmierrohranschluss / with lubrication pipe connection Nebenantriebs-ID / PTO ID: 130 (91)

		CODE		 Parameter		
--	--	------	--	---	---	---

RENAULT TRUCKS

G 10.82 - 09.91

G 290.17/TD G 290.19 G 290.19/T G 290.22/TD G 290.24 G 290.24 CIT G 290.26	11.85 - 12.89 11.85 - 12.89 11.85 - 12.89 11.85 - 12.89 11.85 - 12.89 11.85 - 12.89 11.85 - 12.89	MIDR062045	 	3400 116 601 ⊗ 3482 097 141 ⊗ 1878 020 241 ⊙ 3100 008 106	430 20 GMFZ430 430WGTZ KZISZ-5	Getr. / GBox: B9/B18	
G 300.13 G 300.15 G 300.15/T G 300.16 G 300.17 G 300.19 G 300.19/T G 300.24 G 300.25 G 300.26 G 300.26 CIT G 300.26/T	01.90 - 08.91 01.90 - 08.91 01.90 - 08.91 01.90 - 08.91 01.90 - 08.91 01.90 - 08.91 01.90 - 08.91 01.90 - 08.91 01.90 - 08.91 01.90 - 08.91 01.90 - 08.91 01.90 - 08.91	MIDR06.20.45D	    	3400 116 801 ⊗ 3482 097 141 ⊗ 1878 027 442 ⊙ 3100 008 106	430 20 GMFZ430 430GTZ KZISZ-5	Getr. / GBox: B9/B18	
				3400 123 201 ▲ ⊗ 3482 123 441 ⊗ 1878 022 841 ⊙ 3100 008 106	430 10 GMFZ430 430GTZ KZISZ-5	Getr. / GBox: ZF 16S-130 Getr. / GBox: Eaton RTXF 116	
				1882 022 101 #	420 G420XN	Getr. / GBox: 16S-130+ Nebenantriebs-ID / PTO ID: 130	(50)
				1878 003 276	420 10 420GTZ	Getr. / GBox: 16S-130+ Nebenantriebs-ID / PTO ID: 130	(50)
				3151 204 001	KZI-6	Getr. / GBox: 16S-130+ mit Schmierrohranschluss / with lubrication pipe connection Nebenantriebs-ID / PTO ID: 130	(91)
G 320.19 G 320.19 T G 320.24	11.88 - 05.90 11.88 - 05.90 11.88 - 05.90	MIDR06.20.45H		3400 116 601 ⊗ 3482 097 141 ⊗ 1878 020 241 ⊙ 3100 008 106	430 20 GMFZ430 430WGTZ KZISZ-5	Getr. / GBox: B9/B18	
G 330.13 G 330.15 G 330.16 G 330.17 G 330.17/T G 330.19 G 330.24 G 330.26	02.90 - 08.91 02.90 - 08.91 02.90 - 08.91 02.90 - 08.91 02.90 - 08.91 02.90 - 08.91 02.90 - 08.91 02.90 - 08.91	MIDR06.20.45H	 	3400 123 201 ▲ ⊗ 3482 123 441 ⊗ 1878 022 841 ⊙ 3100 008 106	430 10 GMFZ430 430GTZ KZISZ-5	Getr. / GBox: Eaton RTXF 116	
				3400 116 601 ⊗ 3482 097 141 ⊗ 1878 020 241 ⊙ 3100 008 106	430 20 GMFZ430 430WGTZ KZISZ-5	Getr. / GBox: B9/B18	
G 340ti.19/T,G 330.19/T,G 330.17/T G 340ti.19/T,G 330.19/T	01.90 - 08.91 02.90 - 08.91	MIDR06.20.45H, MIDR06.20.45E 3	 	3400 123 201 ▲ ⊗ 3482 123 441 ⊗ 1878 022 841 ⊙ 3100 008 106	430 10 GMFZ430 430GTZ KZISZ-5	Getr. / GBox: ZF 16S-130	
				3400 116 601 ⊗ 3482 097 141 ⊗ 1878 020 241 ⊙ 3100 008 106	430 20 GMFZ430 430WGTZ KZISZ-5	Getr. / GBox: RVI	

GB

131	10.78 -	797		3400 700 339 ⊗ 3482 124 041 ⊗ 1878 001 729 ⊙ 3151 270 341	350 10 MF350 350GTD KZIS-3	Getr. / GBox: ZFS5-35	
191 , A	10.78 - 10.81	MIDO62030		3482 037 141	380 GM380	Getr. / GBox: 6G.	
191 , A	11.81 -	MIDO62030	 	3482 037 141 3151 000 285	380 GM380 KZI-4	Getr. / GBox: 6G. Getr. / GBox: 6G.	
231 , A, B 231 , A, B	10.78 - 10.81 11.81 -	MIDSO62030		1864 497 043	430 16 430Z		







GC



















190	01.75 - 12.79	MID062030		3482 037 141	380 GM380	Getr. / GBox: 10G.	
191 191 , BOM	10.78 - 10.81 10.79 - 10.81	MID062030		3482 037 141 ⊗	380 GM380		
191	11.81 -	MIDO62030	 	3482 037 141 ⊗ 3151 000 285 ⊗	380 GM380 KZI-4		













		CODE				
--	--	------	--	---	---	---

RENAULT TRUCKS

GC						
191 , BOM	11.81-	MIDO62030		3482 037 141	380 GM380	Getr. / GBox: 6G.
				3151 000 285	KZI-4	Getr. / GBox: 6G.



GF						
190 , A 191	01.75- 12.79	MID062030		3482 037 141	380 GM380	Getr. / GBox: 6G.
	01.75- 12.79					
191 (6G.)	11.81-	MID062030		3482 037 141	380 GM380	Getr. / GBox: BD SL021
				3151 000 285	KZI-4	Getr. / GBox: BD SL021
230 , A	01.75- 12.79	MID062030		1864 497 043	430 16 430Z	
231 , A	10.78- 10.81	MID062030		1864 497 043 	430 16 430Z	
231 , A	11.81-					

GL						
GL 900 E (5G.)	06.75- 12.79	MID042030		1878 001 729	350 10 350GTD	Getr. / GBox: ZF
				1864 454 101	350 10 350B	Getr. / GBox: ZF
GLM 280	04.86-	MIDS063540		3400 700 336  3482 097 141  1878 022 841  3100 008 106	430 10 GMFZ430 430GTZ KZISZ-5	Getr. / GBox: Fuller RTO 9509
GLM 280		MIDS063540		3482 097 141	430 GMFZ430	-> 03.1986 Getr. / GBox: Fuller RTO 9509
				1878 022 841	430 10 430GTZ	-> 03.1986 Getr. / GBox: Fuller RTO 9509 Beinhaltet Ausrücker und Montagesatz / Contains releaser and fitting kit (9)
				3482 097 141	430 GMFZ430	04.1986-> Getr. / GBox: RVI Getr. / GBox: Fuller RTO 9505
				1878 027 442	430 20 430GTZ	04.1986-> Getr. / GBox: RVI Getr. / GBox: Fuller RTO 9505
				3100 008 106  3151 234 132  3180 000 009	KZISZ-5 KZISZ-5	04.1986-> Getr. / GBox: RVI Getr. / GBox: Fuller RTO 9509 Beinhaltet Ausrücker und Montagesatz / Contains releaser and fitting kit (9)
GLR 190 , A	10.78-	MID062030		3482 037 141 	380 GM380	
				3151 000 285 	KZI-4	11.1981->
GLR 230	10.78-	MIDS062030		1864 497 043	430 16 430Z	













GR						
191 , A, B	10.78-	MIDO62030		3482 037 141 	380 GM380	
				3151 000 285 	KZI-4	11.1981->
230 , A	10.77- 12.79	MIDSO62030		1864 497 043	430 16 430Z	Getr. / GBox: BDSL
231 , A (6G.)	01.81-					
231 , A	10.78-	MIDSO62030		1864 497 043 	430 16 430Z	Getr. / GBox: BDSL
260	02.72- 12.74	MIDSO62030		1864 497 042	430 20 430Z	Getr. / GBox: BM 8.120
280 , A, B	01.73- 12.82			1878 027 442	430 20 430GTZ	
		MIDSO62030		1864 497 042	430 20 430Z	Getr. / GBox: BM 8.120
305 , A, B	01.77- 12.80			1864 497 042	430 20 430Z	Getr. / GBox: BM 8.120
320 , B	01.74- 12.78			1864 497 042	430 20 430Z	



















		CODE				
--	--	------	--	---	---	---

RENAULT TRUCKS

















GRH						
235 R 6x4 305 6x4	10.78-			1878 027 442	430 20 430GTZ	Getr. / GBox: B9.150
	10.77 - 12.80			1864 497 042	430 20 430Z	Getr. / GBox: BM8.120

H						
HB 15, 17, 19, 26	01.78 - 12.80			3482 002 234	350 GMF350X	
				3151 000 395	KZIS-4	
HM 15, 17, 19, 26	01.78 - 12.80	MAN2566		3482 002 234	350 GMF350X	
				3151 000 395	KZIS-4	













J						
JK 60, 65, 75, 85 JN 85 BOM (5G.) JN 85 Tankwagen / road tanker (5G.)	-04.86	720		3499 373 055	250 MF250	Getr. / GBox: ZFS5-24
	06.79-			1897 375 775	KZA-5	Getr. / GBox: ZFS5-24
JK 60, 85	-04.86			3499 373 055	250 MF250	Getr. / GBox: 321
				1862 353 041 ▲	250 10 250CB	Getr. / GBox: 321
JK 75 Müllwagen / refuse collecting vehicle				3499 373 055	250 MF250	Getr. / GBox: ZFS5-24
				1897 375 775	KZA-5	Getr. / GBox: ZFS5-24
JN 60, 75, 80 (5G.) JN 90 (5G.) JP 11, 13, 14 (5G.)	01.78 - 12.83	797		3400 117 301 #	310 10 MF310	Getr. / GBox: ZFS5-35
	01.76 - 12.83			3482 008 033 1861 577 037 3151 199 001	310GTD KZIS-3	
JP 13 JR 19 JR 21	01.76 - 12.83	798		3400 700 339	350 10 MF350	Getr. / GBox: ZF
	-12.76			3482 124 041 1878 001 729 3151 270 341	350GTD KZIS-3	
JP 13 A (12G.) JR 19 JX 21	01.76 - 12.83	797		3482 124 041	350 MF350	Getr. / GBox: ZFS6-65+GV80
	01.79-	798		3482 124 041	350 MF350	Getr. / GBox: ZF

K-Serie 01.13 -						
380P MEDIUM, 380P HEAVY 380P MEDIUM, 380P HEAVY, 380P XTREM	01.13-	DTI11		3400 700 600  	430 24 MFZ430	Getr. / GBox: MT 2214B / MT 2514B
	01.13-			3483 000 348 1878 007 046	430WGZ	Getr. / GBox: MTO 2214B/MTO 2514B Euro 6 / Euro 6
380T MEDIUM, 380T HEAVY 430P MEDIUM, 430P HEAVY 430P MEDIUM, 430P HEAVY, 430P XTREM	01.13-			3400 710 064	430 24 MF430	Getr. / GBox: AT 2412/E / AT 2612/E
	01.13-			3482 001 310 1878 007 170 6482 000 155	430WGZ PHIS-6/38	Getr. / GBox: ATO 2612/E Euro 6 / Euro 6
430T MEDIUM, 430T HEAVY 460P MEDIUM, 460P HEAVY 460P MEDIUM, 460P HEAVY, 480P XTREM	01.13-			3400 700 600  	430 24 MFZ430	Getr. / GBox: MT 2214B / MT 2514B
	01.13-			3483 000 348 1878 007 046	430WGZ	Getr. / GBox: MTO 2214B/MTO 2514B Euro 6 / Euro 6
460T MEDIUM, 460T HEAVY 440P MEDIUM, 440P HEAVY 480P MEDIUM, 480P HEAVY 480P MEDIUM, 480P HEAVY, 480P XTREM	01.13-	DTI13		3400 710 064	430 24 MF430	Getr. / GBox: AT 2412/E / AT 2612/E
	01.13-			3482 001 310 1878 007 170 6482 000 155	430WGZ PHIS-6/38	Getr. / GBox: ATO 2612/E Euro 6 / Euro 6
480T MEDIUM, 480T HEAVY 520P MEDIUM, 520P HEAVY 520P MEDIUM, 520P HEAVY, 520P XTREM	01.13-	DTI13		3400 700 600  	430 24 MFZ430	Getr. / GBox: MTO 2514B
	01.13-			3483 000 348 1878 007 046	430WGZ	Euro 6 / Euro 6
520T MEDIUM, 520T HEAVY	01.13-			3400 710 064	430 24 MF430	Getr. / GBox: AT2612/E / ATO2612/E
	01.13-			3482 001 310 1878 007 170 6482 000 155	430WGZ PHIS-6/38	Euro 6 / Euro 6

RENAULT TRUCKS



















Kerax		06.97 -					
260.18 260.18/B 300.18/B 300.26/A,300.26/B 300.26/B	06.97 -	MIDR06.20.45D/ 41, MIDR06.20.45C/ 4	 3400 700 335 ▲ ⊗ 3482 083 252 ⊗ 1878 026 241 ⊙ 3151 278 941	430 10 MFZ430 430WGTZ KZIS-5	->12.1999 Getr. / GBox: ZF 9S-109		
	06.97 -		 3400 700 333 ⊗ 3482 083 252 ⊗ 1878 004 832 ⊙ 3151 278 941	430 10 MFZ430 430WGTZ KZIS-5	->12.1999 Getr. / GBox: ZF 16S-151		
	06.97 -		 3400 700 409 ⊗ 3482 083 252 ⊗ 1878 026 241 ⊙ 3151 250 231	430 10 MFZ430 430WGTZ KZISZ-5	01.2000-> Getr. / GBox: ZF 9S-109		
	06.97 -		 3400 700 334 ⊗ 3482 083 252 ⊗ 1878 004 832 ⊙ 3151 274 131	430 10 MFZ430 430WGTZ KZISZ-5	01.2000-> Getr. / GBox: ZF 16S-151		
			 3400 700 335 ▲ ⊗ 3482 083 252 ⊗ 1878 026 241 ⊙ 3151 278 941	430 10 MFZ430 430WGTZ KZIS-5	Getr. / GBox: ZF 8S-151		
			 3400 700 409 ⊗ 3482 083 252 ⊗ 1878 026 241 ⊙ 3151 250 231	430 10 MFZ430 430WGTZ KZISZ-5	Getr. / GBox: Eaton 8209A		
			 3400 700 311 ⊗ 3488 017 439 ⊗ 1862 379 032 ⊙ 3151 262 031	400 10 MFZ2/400X 400WGTZ KZISZ-5	Getr. / GBox: ZF 16S-151 Getr. / GBox: ZF 8S-151 für Fahrzeuge mit Zweischeibenkupplung / for vehicles with double disc clutch	(77)	
			 3400 700 485 # ⊗ 3482 123 631 ⊗ 1878 004 832 ⊙ 3151 263 031	430 10 GMFZ430N 430WGTZ KZIZ-6	Getr. / GBox: ZF 16S-151 für Nebenantrieb / for PTO	(82)	
270.18	01.01 -	dCi11-270	 3400 700 409 ⊗ 3482 083 252 ⊗ 1878 026 241 ⊙ 3151 250 231	430 10 MFZ430 430WGTZ KZISZ-5	Getr. / GBox: ZF 9S-109 Getr. / GBox: Eaton 8309/A		
			 3400 700 311 ⊗ 3488 017 439 ⊗ 1862 379 032 ⊙ 3151 262 031	400 10 MFZ2/400X 400WGTZ KZISZ-5	für Fahrzeuge mit Zweischeibenkupplung / for vehicles with double disc clutch	(77)	
			 3400 700 485 # ⊗ 3482 123 631 ⊗ 1878 004 832 ⊙ 3151 263 031	430 10 GMFZ430N 430WGTZ KZIZ-6	Getr. / GBox: ZF 16S-151 Nebenantriebs-ID / PTO ID: 221	(50)	
			 3189 600 009				
320.18 320.26	01.01 -	dCi11G	 3400 700 334 ⊗ 3482 083 252 ⊗ 1878 004 832 ⊙ 3151 274 131	430 10 MFZ430 430WGTZ KZISZ-5	Getr. / GBox: ZF 8S-151 Getr. / GBox: ZF 16S-151		
	01.01 -		 3400 700 311 ⊗ 3488 017 439 ⊗ 1862 379 032 ⊙ 3151 262 031	400 10 MFZ2/400X 400WGTZ KZISZ-5	für Fahrzeuge mit Zweischeibenkupplung / for vehicles with double disc clutch	(77)	
			 3400 700 485 # ⊗ 3482 123 631 ⊗ 1878 004 832 ⊙ 3151 263 031	430 10 GMFZ430N 430WGTZ KZIZ-6	Getr. / GBox: ZF 16S-151 Nebenantriebs-ID / PTO ID: 221	(50)	
			 3189 600 009				

RENAULT TRUCKS























Kerax		06.97 -				
340.18	06.97 -	MIDR06.20.45E/ 41	 3400 123 401 ⊗ 3482 083 252 ⊗ 1878 020 241 ⊙ 3151 250 231	430 20 MFZ430 430WGTZ KZISZ-5	Getr. / GBox: B9	
340.18/B	06.97 -		 3400 700 408 ⊗ 3482 083 252 ⊗ 1878 020 241 ⊙ 3151 000 404	430 20 MFZ430 430WGTZ KZISZ-5	Getr. / GBox: B9+35mm,B18	
340.26/A,340.26/B	06.97 -		 3400 117 532 ● ⊗ 3488 017 439 ⊗ 1862 379 031 ⊙ 3151 250 231	400 20 MFZ2/400X 400WGVZ KZISZ-5	Getr. / GBox: B9+35mm,B18 für Fahrzeuge mit Zweischeibenkupplung / for vehicles with double disc clutch	(77)
340.26/B	06.97 -		 3400 700 333 ⊗ 3482 083 252 ⊗ 1878 004 832 ⊙ 3151 278 941	430 10 MFZ430 430WGTZ KZIS-5	Getr. / GBox: ZF 8S-151	
340.32/A	06.97 -		 3482 083 252	430 MFZ430	->05.2001 Getr. / GBox: ZF 16S-151 Produktionsnummer bis / Production number to: CAM 16E1	(56)
			 1878 022 841	430 10 430GTZ	->05.2001 Getr. / GBox: ZF 16S-151 Produktionsnummer bis / Production number to: CAM 16E1	(56)
			 3151 278 941	KZIS-5	->05.2001 Getr. / GBox: ZF 16S-151 Produktionsnummer bis / Production number to: CAM 16E1	(56)
			 3400 700 410 ⊗ 3482 083 252 ⊗ 1878 022 841 ⊙ 3151 274 131	430 10 MFZ430 430GTZ KZISZ-5	05.2001-> Getr. / GBox: ZF 16S-151 Produktionsnummer ab / Production number from: CAM 17E1	(55)
			 3400 700 340 ● ⊗ 3488 017 439 ⊗ 1862 379 032 ⊙ 3151 250 231	400 10 MFZ2/400X 400WGTZ KZISZ-5	->12.1999 Getr. / GBox: ZF 16S-151 für Fahrzeuge mit Zweischeibenkupplung / for vehicles with double disc clutch	(77)
			 3400 700 311 ⊗ 3488 017 439 ⊗ 1862 379 032 ⊙ 3151 262 031	400 10 MFZ2/400X 400WGTZ KZISZ-5	01.2000-> Getr. / GBox: ZF 8S-151 Getr. / GBox: ZF 16S-151 Getr. / GBox: ZF 16S-221 für Fahrzeuge mit Zweischeibenkupplung / for vehicles with double disc clutch	(77)
			 3400 700 485 # ⊗ 3482 123 631 ⊗ 1878 004 832 ⊙ 3151 263 031	430 10 GMFZ430N 430WGTZ KZIS-6	Getr. / GBox: ZF 16S-151 Nebenantriebs-ID / PTO ID: NMV 221	(50)
			 3400 700 409 ⊗ 3482 083 252 ⊗ 1878 026 241 ⊙ 3151 250 231	430 10 MFZ430 430WGTZ KZISZ-5	Getr. / GBox: Eaton 8209 A	

		CODE				
--	--	------	--	---	---	---

RENAULT TRUCKS

























Kerax		06.97 -				
340.26	06.97 - 01.01	MIDR06.20.45E/41	 3400 123 401 ⊗ 3482 083 252 ⊗ 1878 020 241 ⊙ 3151 250 231	430 20 MFZ430 430WGTZ KZISZ-5	Getr. / GBox: B9	
			 3400 700 408 ⊗ 3482 083 252 ⊗ 1878 020 241 ⊙ 3151 000 404	430 20 MFZ430 430WGTZ KZISZ-5	Getr. / GBox: B9+35mm,B18	
			 3400 117 532 ● ⊗ 3488 017 439 ⊗ 1862 379 031 ⊙ 3151 250 231	400 20 MFZ2/400X 400WGVZ KZISZ-5	Getr. / GBox: B9+35mm,B18 für Fahrzeuge mit Zweischeibenkupplung / for vehicles with double disc clutch	(77)
			 3400 700 333 ⊗ 3482 083 252 ⊗ 1878 004 832 ⊙ 3151 278 941	430 10 MFZ430 430WGTZ KZISZ-5	Getr. / GBox: ZF 8S-151	
			 3482 083 252	430 MFZ430	Getr. / GBox: ZF 16S-151 Produktionsnummer bis / Production number to: CAM 16E1	(56)
			 1878 022 841	430 10 430GTZ	Getr. / GBox: ZF 16S-151 Produktionsnummer bis / Production number to: CAM 16E1	(56)
			 3151 278 941	KZISZ-5	Getr. / GBox: ZF 16S-151 Produktionsnummer bis / Production number to: CAM 16E1	(56)
			 3400 700 340 ● ⊗ 3488 017 439 ⊗ 1862 379 032 ⊙ 3151 250 231	400 10 MFZ2/400X 400WGTZ KZISZ-5	->12.1999 Getr. / GBox: ZF 16S-151 für Fahrzeuge mit Zweischeibenkupplung / for vehicles with double disc clutch	(77)
			 3400 700 311 ⊗ 3488 017 439 ⊗ 1862 379 032 ⊙ 3151 262 031	400 10 MFZ2/400X 400WGTZ KZISZ-5	01.2000-> Getr. / GBox: ZF 8S-151 Getr. / GBox: ZF 16S-151 Getr. / GBox: ZF 16S-221 für Fahrzeuge mit Zweischeibenkupplung / for vehicles with double disc clutch	(77)
			 3400 700 485 # ⊗ 3482 123 631 ⊗ 1878 004 832 ⊙ 3151 263 031	430 10 GMFZ430N 430WGTZ KZIZ-6	Getr. / GBox: ZF 16S-151 Nebenantriebs-ID / PTO ID: NMV 221	(50)
			 3400 700 409 ⊗ 3482 083 252 ⊗ 1878 026 241 ⊙ 3151 250 231	430 10 MFZ430 430WGTZ KZISZ-5	Getr. / GBox: Eaton 8209 A	
350.34	01.03 -	MIDR06.23.56A/3	 3400 700 334 ⊗ 3482 083 252 ⊗ 1878 004 832 ⊙ 3151 274 131	430 10 MFZ430 430WGTZ KZISZ-5	Getr. / GBox: ZF 16S-151	
			 3400 700 485 # ⊗ 3482 123 631 ⊗ 1878 004 832 ⊙ 3151 263 031	430 10 GMFZ430N 430WGTZ KZIZ-6	Getr. / GBox: ZF 16S-151 Nebenantriebs-ID / PTO ID: 221	(50)
370		DXi11	 3400 700 399 ⊗ 3482 083 034 ⊗ 1878 004 832 ⊙ 3151 274 131	430 10 MFZ430 430WGTZ KZISZ-5	Getr. / GBox: 16S1620TD/1820TO Getr. / GBox: 1920TD/2220TO/2220TD	
			 3400 710 060 ⊗ 3482 001 307 ⊗ 1878 003 867 ⊙ 6482 000 155	430 24 MF430 430WGTZ PHIS-6/38	Getr. / GBox: AT2412C/ATO2512C	
370.18 370.26	01.01 - 01.01 -	dCi11E	 3400 700 409 ⊗ 3482 083 252 ⊗ 1878 026 241 ⊙ 3151 250 231	430 10 MFZ430 430WGTZ KZISZ-5	Getr. / GBox: ZF 9S-109	
			 3482 083 252	430 MFZ430	Getr. / GBox: ZF 8S-151 Getr. / GBox: ZF 16S-151 Getr. / GBox: ZF 16S-221	
			 3151 274 131	KZISZ-5	Getr. / GBox: ZF 8S-151 Getr. / GBox: ZF 16S-151 Getr. / GBox: ZF 16S-221	
			 3400 700 485 # ⊗ 3482 123 631 ⊗ 1878 004 832 ⊙ 3151 263 031	430 10 GMFZ430N 430WGTZ KZIZ-6	Getr. / GBox: ZF 16S-151 Nebenantriebs-ID / PTO ID: 221	(50)

RENAULT TRUCKS

Kerax		06.97 -					
370.18 370.26 370.32	01.01- 01.01- 01.01-	dCi11E	    	3400 700 409 ⊗ 3482 083 252 ⊗ 1878 026 241 ⊙ 3151 250 231	430 10 MFZ430 430WGTZ KZISZ-5	Getr. / GBox: ZF 9S-109	
				3482 083 252	430 MFZ430	Getr. / GBox: ZF 8S-151 Getr. / GBox: ZF 16S-151 Getr. / GBox: ZF 16S-221	
				3151 274 131	KZISZ-5	Getr. / GBox: ZF 8S-151 Getr. / GBox: ZF 16S-151 Getr. / GBox: ZF 16S-221	
				3400 700 485 # ⊗ 3482 123 631 ⊗ 1878 004 832 ⊙ 3151 263 031	430 10 GMFZ430N 430WGTZ KZIZ-6	Getr. / GBox: ZF 16S-151 Nebenantriebs-ID / PTO ID: 221	(50)
				3189 600 009			
370.18 370.26 370.32 410.18 410.26 410.32	10.05- 10.05- 10.05- 10.05- 10.05- 10.05-	DXi11	     	3400 700 399 ⊗ 3482 083 034 ⊗ 1878 004 832 ⊙ 3151 274 131	430 10 MFZ430 430WGTZ KZISZ-5	Getr. / GBox: ZF	
				3488 017 439	400 MFZ2/400X	für Fahrzeuge mit Zweischeibenkupplung / for vehicles with double disc clutch enthält eine Kupplungsscheibe / This part number includes one clutch disc mit Zwischenring / with intermediate ring	(77) (67) (94)
				1862 380 031 ▽	400 8 400GVZ	für Fahrzeuge mit Zweischeibenkupplung / for vehicles with double disc clutch In 3488 enthalten / Contained in 3488	(77) (33)
				1862 379 032	400 10 400WGTZ	für Fahrzeuge mit Zweischeibenkupplung / for vehicles with double disc clutch	(77)
				3151 262 031	KZISZ-5	für Fahrzeuge mit Zweischeibenkupplung / for vehicles with double disc clutch	(77)
				3400 710 060 ⊗ 3482 001 307 ⊗ 1878 003 867 ⊙ 6482 000 155	430 24 MF430 430WGTZ PHIS-6/38	Getr. / GBox: AT2412C/ATO2512C	
385.18 385.18/B 385.18T 385.26 385.26/A,385.26/B 385.26/A,385.26/B,385.26/C 385.26/B 385.32/A,385.32/B 385.32/A,385.32/B,385.32/C 385.32/B	06.97- 06.97- 06.97- 06.97- 06.97- 06.97- 06.97- 06.97- 06.97- 06.97-	MIDR06.23.56A/ 41	          	3400 123 401 ⊗ 3482 083 252 ⊗ 1878 020 241 ⊙ 3151 250 231	430 20 MFZ430 430WGTZ KZISZ-5	Getr. / GBox: B9	
				3400 700 408 ⊗ 3482 083 252 ⊗ 1878 020 241 ⊙ 3151 000 404	430 20 MFZ430 430WGTZ KZISZ-5	Getr. / GBox: B9+35mm,B18	
				3400 117 532 ● ⊗ 3488 017 439 ⊗ 1862 379 031 ⊙ 3151 250 231	400 20 MFZ2/400X 400WGVZ KZISZ-5	Getr. / GBox: B9+35mm,B18 für Fahrzeuge mit Zweischeibenkupplung / for vehicles with double disc clutch	(77)
				3400 700 333 ⊗ 3482 083 252 ⊗ 1878 004 832 ⊙ 3151 278 941	430 10 MFZ430 430WGTZ KZIS-5	Getr. / GBox: ZF 8S-151	
				3400 700 333 ⊗ 3482 083 252 ⊗ 1878 004 832 ⊙ 3151 278 941	430 10 MFZ430 430WGTZ KZIS-5	->05.2001 Getr. / GBox: ZF 16S-151 Produktionsnummer bis / Production number to: CAM 16E1	(56)
				3400 700 334 ⊗ 3482 083 252 ⊗ 1878 004 832 ⊙ 3151 274 131	430 10 MFZ430 430WGTZ KZISZ-5	05.2001-> Getr. / GBox: ZF 16S-151 Produktionsnummer ab / Production number from: CAM 17E1	(55)
				3400 700 340 ● ⊗ 3488 017 439 ⊗ 1862 379 032 ⊙ 3151 250 231	400 10 MFZ2/400X 400WGTZ KZISZ-5	->12.1999 Getr. / GBox: ZF 16S-151 für Fahrzeuge mit Zweischeibenkupplung / for vehicles with double disc clutch	(77)
				3400 700 311 ⊗ 3488 017 439 ⊗ 1862 379 032 ⊙ 3151 262 031	400 10 MFZ2/400X 400WGTZ KZISZ-5	01.2000-> Getr. / GBox: ZF 8S-151 Getr. / GBox: ZF 16S-151 Getr. / GBox: ZF 16S-221 für Fahrzeuge mit Zweischeibenkupplung / for vehicles with double disc clutch	(77)
				3400 700 485 # ⊗ 3482 123 631 ⊗ 1878 004 832 ⊙ 3151 263 031	430 10 GMFZ430N 430WGTZ KZIZ-6	Getr. / GBox: ZF 16S-151 Nebenantriebs-ID / PTO ID: NMV 221	(50)
				3400 700 409	430 10	Getr. / GBox: Eaton 8209 A	



















		CODE				
--	--	------	--	---	---	---

RENAULT TRUCKS

Kerax		06.97 -				
385.26T	06.97 -	MIDR06.23.56A/41	 3400 123 401 ⊗ 3482 083 252 ⊗ 1878 020 241 ⊙ 3151 250 231	430 20 MFZ430 430WGTZ KZISZ-5	Getr. / GBox: B9	
			 3400 700 408 ⊗ 3482 083 252 ⊗ 1878 020 241 ⊙ 3151 000 404	430 20 MFZ430 430WGTZ KZISZ-5	Getr. / GBox: B9+35mm,B18	
			 3400 117 532 ● ⊗ 3488 017 439 ⊗ 1862 379 031 ⊙ 3151 250 231	400 20 MFZ2/400X 400WGVZ KZISZ-5	Getr. / GBox: B9+35mm,B18 für Fahrzeuge mit Zweischeibenkupplung / for vehicles with double disc clutch	(77)
			 3400 700 333 ⊗ 3482 083 252 ⊗ 1878 004 832 ⊙ 3151 278 941	430 10 MFZ430 430WGTZ KZIS-5	Getr. / GBox: ZF 8S-151	
			 3400 700 333 ⊗ 3482 083 252 ⊗ 1878 004 832 ⊙ 3151 278 941	430 10 MFZ430 430WGTZ KZIS-5	->05.2001 Getr. / GBox: ZF 16S-151 Produktionsnummer bis / Production number to: CAM 16E1	(56)
			 3400 700 334 ⊗ 3482 083 252 ⊗ 1878 004 832 ⊙ 3151 274 131	430 10 MFZ430 430WGTZ KZISZ-5	05.2001-> Getr. / GBox: ZF 16S-151 Produktionsnummer ab / Production number from: CAM 17E1	(55)
			 3400 700 340 ● ⊗ 3488 017 439 ⊗ 1862 379 032 ⊙ 3151 250 231	400 10 MFZ2/400X 400WGTZ KZISZ-5	->12.1999 Getr. / GBox: ZF 16S-151 für Fahrzeuge mit Zweischeibenkupplung / for vehicles with double disc clutch	(77)
			 3400 700 311 ⊗ 3488 017 439 ⊗ 1862 379 032 ⊙ 3151 262 031	400 10 MFZ2/400X 400WGTZ KZISZ-5	01.2000-> Getr. / GBox: ZF 8S-151 Getr. / GBox: ZF 16S-151 Getr. / GBox: ZF 16S-221 für Fahrzeuge mit Zweischeibenkupplung / for vehicles with double disc clutch	(77)
			 3482 123 631	430 GMFZ430N	Getr. / GBox: ZF 16S-151 Nebenantriebs-ID / PTO ID: NMV 221	(50)
			 1878 004 832	430 10 430WGTZ	Getr. / GBox: ZF 16S-151 Nebenantriebs-ID / PTO ID: NMV 221	(50)
			 3151 263 031	KZIZ-6	Getr. / GBox: ZF 16S-151 Nebenantriebs-ID / PTO ID: NMV 221	(50)
			 3400 700 409 ⊗ 3482 083 252 ⊗ 1878 026 241 ⊙ 3151 250 231	430 10 MFZ430 430WGTZ KZISZ-5	Getr. / GBox: Eaton 8209 A	
400.18 400.18T 400.26 400.26/A,400.26/B,400.26/C 400.26/B 400.26T 400.32/A,400.32/B,400.32/C 400.32/B	01.00 - 01.00 - 09.98 - 01.00 - 01.00 - 01.00 - 01.00 - 01.00 -	MIDR06.23.56B/41	 3400 700 409 ⊗ 3482 083 252 ⊗ 1878 026 241 ⊙ 3151 250 231	430 10 MFZ430 430WGTZ KZISZ-5	Getr. / GBox: Eaton 8209 A	
			 3400 700 333 ⊗ 3482 083 252 ⊗ 1878 004 832 ⊙ 3151 278 941	430 10 MFZ430 430WGTZ KZIS-5	Getr. / GBox: ZF 8S-151	
			 3400 700 333 ⊗ 3482 083 252 ⊗ 1878 004 832 ⊙ 3151 278 941	430 10 MFZ430 430WGTZ KZIS-5	->05.2001 Getr. / GBox: ZF 16S-151 Produktionsnummer bis / Production number to: CAM 16E1	(56)
			 3400 700 334 ⊗ 3482 083 252 ⊗ 1878 004 832 ⊙ 3151 274 131	430 10 MFZ430 430WGTZ KZISZ-5	05.2001-> Getr. / GBox: ZF 16S-151 Produktionsnummer ab / Production number from: CAM 17E1	(55)
			 3400 700 311 ⊗ 3488 017 439 ⊗ 1862 379 032 ⊙ 3151 262 031	400 10 MFZ2/400X 400WGTZ KZISZ-5	Getr. / GBox: ZF 8S-151 Getr. / GBox: ZF 16S-151/221/251 für Fahrzeuge mit Zweischeibenkupplung / for vehicles with double disc clutch	(77)
			 3400 700 485 # ⊗ 3482 123 631 ⊗ 1878 004 832 ⊙ 3151 263 031	430 10 GMFZ430N 430WGTZ KZIZ-6	Getr. / GBox: ZF 16S-151 Nebenantriebs-ID / PTO ID: 221	(50)
			 3400 700 399 ⊗ 3482 083 034 ⊗ 1878 004 832 ⊙ 3151 274 131	430 10 MFZ430 430WGTZ KZISZ-5	Getr. / GBox: 16S1620TD/1820TO Getr. / GBox: 1920TD/2220TO/2220TD	
			 3400 700 358 ☹ ⊗ 3482 001 307 ⊗ 1878 003 867	430 24 MF430 430WGTZ	Getr. / GBox: AT2412C/ATO2512C	
 6482 000 155	PHIS-6/38	Getr. / GBox: AT2412C/ATO2512C				
410		DXi11	 3400 700 399 ⊗ 3482 083 034 ⊗ 1878 004 832 ⊙ 3151 274 131	430 10 MFZ430 430WGTZ KZISZ-5	Getr. / GBox: 16S1620TD/1820TO Getr. / GBox: 1920TD/2220TO/2220TD	
			 3400 700 358 ☹ ⊗ 3482 001 307 ⊗ 1878 003 867	430 24 MF430 430WGTZ	Getr. / GBox: AT2412C/ATO2512C	
			 6482 000 155	PHIS-6/38	Getr. / GBox: AT2412C/ATO2512C	



















		CODE				
--	--	------	--	---	---	---

RENAULT TRUCKS

Kerax		06.97 -					
420.18	01.01-	dCi11C		3400 700 334 ⊗ 3482 083 252 ⊗ 1878 004 832 ⊙ 3151 274 131	430 10 MFZ430 430WGTZ KZISZ-5	Getr. / GBox: ZF 8S-151 Getr. / GBox: ZF 16S-151 Getr. / GBox: ZF 16S-221	
420.26	01.01-			3400 700 330 ⊗ 3482 083 252 ⊗ 1878 004 832 ⊙ 3151 250 231	430 10 MFZ430 430WGTZ KZISZ-5	Getr. / GBox: Eaton 8309/A	
420.32	10.01-			3400 700 311 ⊗ 3488 017 439 ⊗ 1862 379 032 ⊙ 3151 262 031	400 10 MFZ2/400X 400WGTZ KZISZ-5	für Fahrzeuge mit Zweischeibenkupplung / for vehicles with double disc clutch	(77)
420.34	01.01-			3400 700 485 # ⊗ 3482 123 631 ⊗ 1878 004 832 ⊙ 3151 263 031	430 10 GMFZ430N 430WGTZ KZISZ-6	Getr. / GBox: ZF 16S-151 Nebenantriebs-ID / PTO ID: 221	(50)
				3189 600 009			
440.18	04.06-	DXi11		3400 700 399 ⊗ 3482 083 034 ⊗ 1878 004 832 ⊙ 3151 274 131	430 10 MFZ430 430WGTZ KZISZ-5	Getr. / GBox: ZF	
450.18	10.05-			3488 017 439	400 MFZ2/400X	für Fahrzeuge mit Zweischeibenkupplung / for vehicles with double disc clutch enthält eine Kupplungsscheibe / This part number includes one clutch disc mit Zwischenring / with intermediate ring	(77) (67)
450.26	10.05-			1862 380 031 ▽	400 8 400GVZ	für Fahrzeuge mit Zweischeibenkupplung / for vehicles with double disc clutch In 3488 enthalten / Contained in 3488	(77) (33)
450.32	10.05-			1862 379 032	400 10 400WGTZ	für Fahrzeuge mit Zweischeibenkupplung / for vehicles with double disc clutch	(77)
				3151 262 031	KZISZ-5	für Fahrzeuge mit Zweischeibenkupplung / for vehicles with double disc clutch	(77)
				3400 710 061 # ⊗ 3482 000 553 ⊗ 1878 007 046 ⊙ 6482 000 155	430 24 MF430 430WGTZ PHIS-6/38	Getr. / GBox: AT2412C/ATO2512C Euro 5 / Euro 5	(17)
				3400 710 066 ● ⊗ 3482 001 308 ⊗ 1878 007 046 ⊙ 6482 000 155	430 24 MF430 430WGTZ PHIS-6/38	Getr. / GBox: AT2412C/ATO2512C Euro 6 / Euro 6	(18)
450		DXi11		3400 700 399 ⊗ 3482 083 034 ⊗ 1878 004 832 ⊙ 3151 274 131	430 10 MFZ430 430WGTZ KZISZ-5	Getr. / GBox: 16S1620TD/1820TO Getr. / GBox: 1920TD/2220TO/2220TD	
				3400 710 061 # ⊗ 3482 000 553 ⊗ 1878 007 046 ⊙ 6482 000 155	430 24 MF430 430WGTZ PHIS-6/38	Getr. / GBox: AT2412C/ATO2512C Euro 5 / Euro 5	(17)
460.32	05.06-	DXi13		3400 710 061 # ⊗ 3482 000 553 ⊗ 1878 007 046 ⊙ 6482 000 155	430 24 MF430 430WGTZ PHIS-6/38	Getr. / GBox: AT2412C/AT2512C Getr. / GBox: ATO2512C Euro 5 / Euro 5	(17)
500.32	05.06-			3400 700 470 ⊗ 3482 634 004 ⊗ 1878 003 968 ⊙ 3151 274 131	430 10 MFZ430 430WGTZ KZISZ-5	Getr. / GBox: ZF 16S-2520 TO Getr. / GBox: ZF 16S-2320 TD für Fahrzeuge mit Einscheibenkupplung / for vehicles with single disc clutch	(72)
				3400 700 311 ⊗ 3488 017 439 ⊗ 1862 379 032 ⊙ 3151 262 031	400 10 MFZ2/400X 400WGTZ KZISZ-5	Getr. / GBox: ZF 16S-2520 TO Getr. / GBox: ZF 16S-2320 TD für Fahrzeuge mit Zweischeibenkupplung / for vehicles with double disc clutch	(77)
				1863 869 037	72		
Magnum		09.90 -					
AE 380. 19 (11AZA1)	03.90 - 09.92	MIDR06.35.40N/ 3, MIDR06.35.40H		3400 117 001 ⊗ 3482 123 441 ⊗ 1878 020 241 ⊙ 3100 008 106	430 20 GMFZ430 430WGTZ KZISZ-5	Getr. / GBox: B9/B18	
AE 380. 26 6x2 (11CZA1)	03.90 - 09.92						
AE 380. TI (11GZA1)	03.90 - 09.92						
AE 380.18	09.90 - 06.92						
AE 380.18T	09.90 - 06.92						
AE 380.26	09.90 - 06.92						
AE 380.26T	09.90 - 06.92						
AE 420. TI	- 09.92						































		CODE				
--	--	------	--	---	---	---

RENAULT TRUCKS

Magnum		09.90 -						
AE 385. TI	-09.92	MIDR063540L1	 3400 117 001 ⊗ 3482 123 441 ⊗ 1878 020 241 ⊙ 3100 008 106	430 20 GMFZ430 430WGTZ KZISZ-5	Getr. / GBox: B9/B18			
			 3400 123 201 ▲ ⊗ 3482 123 441 ⊗ 1878 022 841 ⊙ 3100 008 106	430 10 GMFZ430 430GTZ KZISZ-5	Getr. / GBox: Fuller			
AE 385ti.18	02.92 - 10.96	MIDR06.35.40N/ 3	 3400 117 101 ⊗ 3482 123 243 ⊗ 1878 020 241 ⊙ 3100 008 204	430 20 MFZ430 430WGTZ	Getr. / GBox: B18 Getr. / GBox: B9+35mm			
AE 385ti.18T	02.92 - 10.96							
AE 385ti.19	02.92 - 10.96							
AE 385ti.19T	02.92 - 10.96			 3400 123 101 # ⊗ 3482 123 243 ⊗ 1878 020 241 ⊙ 3100 008 106	430 20 MFZ430 430WGTZ KZISZ-5	Getr. / GBox: B9		
AE 385ti.24	02.92 - 10.96							
AE 385ti.26	02.92 - 10.96			 3400 123 301 ▲ ⊗ 3482 123 243 ⊗ 1878 022 841 ⊙ 3100 008 106	430 10 MFZ430 430GTZ KZISZ-5	Getr. / GBox: Fuller		
AE 390.18	09.96 -	MIDR062465A/4 2	 3400 123 401 ⊗ 3482 083 252 ⊗ 1878 020 241 ⊙ 3151 250 231	430 20 MFZ430 430WGTZ KZISZ-5	Getr. / GBox: B9			
AE 390.18T	09.96 -							
AE 390.19	09.96 -							
AE 390.19T	09.96 -			 3400 700 408 ⊗ 3482 083 252 ⊗ 1878 020 241 ⊙ 3151 000 404	430 20 MFZ430 430WGTZ KZISZ-5	Getr. / GBox: B9+35mm,B18		
AE 390.26	09.96 -			 3400 117 532 ● ⊗ 3488 017 439 ⊗ 1862 379 031 ⊙ 3151 250 231	400 20 MFZ2/400X 400WGVZ KZISZ-5	Getr. / GBox: B9+35mm,B18 für Fahrzeuge mit Zweis Scheibenkupplung / for vehicles with double disc clutch	(77)	
			 3400 700 311 ⊗ 3488 017 439 ⊗ 1862 379 032 ⊙ 3151 262 031	400 10 MFZ2/400X 400WGTZ KZISZ-5	03.1999-> Getr. / GBox: ZF 16S 221 für Fahrzeuge mit Zweis Scheibenkupplung / for vehicles with double disc clutch	(77)		
AE 420ti.18	10.92 - 12.96	MIDR063540J/3 MIDR063540P/4 1	 3400 117 101 ⊗ 3482 123 243 ⊗ 1878 020 241 ⊙ 3100 008 204	430 20 MFZ430 430WGTZ	->08.1996 Getr. / GBox: B9+35mm,B18			
AE 420ti.18T	10.92 - 12.96							
AE 420ti.19	10.92 - 12.96							
AE 420ti.19T	10.92 - 12.96			 3400 093 031 ●⊕ ⊗ 3488 017 334 ⊗ 1862 379 031	400 20 MFZ2/400X 400WGVZ	->08.1996 Getr. / GBox: B9+35mm,B18 für Fahrzeuge mit Zweis Scheibenkupplung / for vehicles with double disc clutch	(77)	
AE 420ti.22T	10.92 - 10.96							
AE 420ti.24	10.92 - 12.96							
AE 420ti.24T	10.92 - 12.96			 3400 700 408 ⊗ 3482 083 252 ⊗ 1878 020 241 ⊙ 3151 000 404	430 20 MFZ430 430WGTZ KZISZ-5	09.1996-> Getr. / GBox: B9+35mm,B18		
AE 420ti.26	10.92 - 12.96			 3400 117 532 ● ⊗ 3488 017 439 ⊗ 1862 379 031 ⊙ 3151 250 231	400 20 MFZ2/400X 400WGVZ KZISZ-5	09.1996-> Getr. / GBox: B9+35mm,B18 für Fahrzeuge mit Zweis Scheibenkupplung / for vehicles with double disc clutch	(77)	
AE 420ti.26T	10.92 - 12.96							
AE 430.18	09.96 -	MIDR06.24.65C/ 42, MIDR06.24.65B/ 42	 3400 123 401 ⊗ 3482 083 252 ⊗ 1878 020 241 ⊙ 3151 250 231	430 20 MFZ430 430WGTZ KZISZ-5	Getr. / GBox: B9			
AE 430.18T	09.96 -							
AE 430.19	09.96 -							
AE 430.19T	09.96 -			 3400 700 408 ⊗ 3482 083 252 ⊗ 1878 020 241 ⊙ 3151 000 404	430 20 MFZ430 430WGTZ KZISZ-5	Getr. / GBox: B9+35mm,B18		
AE 430.26	09.96 -							
AE 430.26T	01.97 -							
AE 470.18	11.96 -			 3400 117 532 ● ⊗ 3488 017 439 ⊗ 1862 379 031 ⊙ 3151 250 231	400 20 MFZ2/400X 400WGVZ KZISZ-5	Getr. / GBox: B9+35mm,B18 für Fahrzeuge mit Zweis Scheibenkupplung / for vehicles with double disc clutch	(77)	
AE 470.18T	11.96 -							
AE 470.19	11.96 -							
AE 470.19T	11.96 -			 3400 700 331 ⊗ 3482 083 252 ⊗ 1878 085 741 ⊙ 3151 000 404	430 10 MFZ430 430WGTZ KZISZ-5	11.1997-> Getr. / GBox: ZF 16S 221		
AE 470.26	01.97 -			 3400 700 340 ● ⊗ 3488 017 439 ⊗ 1862 379 032 ⊙ 3151 250 231	400 10 MFZ2/400X 400WGTZ KZISZ-5	11.1997-> Getr. / GBox: ZF 16S 221 für Fahrzeuge mit Zweis Scheibenkupplung / for vehicles with double disc clutch	(77)	













		CODE		 Parameter		
--	--	------	--	---	---	---

RENAULT TRUCKS

















Magnum		09.90 -				
AE 430.26T AE 470.26T	01.98 -	MIDR06.24.65C/ 42, MIDR06.24.65B/ 42	 3400 123 401  3482 083 252  1878 020 241  3151 250 231	430 20 MFZ430 430WGTZ KZISZ-5	Getr. / GBox: B9	
	01.98 -		 3400 700 408  3482 083 252  1878 020 241  3151 000 404	430 20 MFZ430 430WGTZ KZISZ-5	Getr. / GBox: B9+35mm,B18	
			 3400 117 532 ●  3488 017 439  1862 379 031  3151 250 231	400 20 MFZ2/400X 400WGVZ KZISZ-5	Getr. / GBox: B9+35mm,B18 für Fahrzeuge mit Zweischeibenkupplung / for vehicles with double disc clutch	(77)
			 3400 700 331  3482 083 252  1878 085 741  3151 000 404	430 10 MFZ430 430WGTZ KZISZ-5	Getr. / GBox: ZF 16S 221	
			 3400 700 340 ●  3488 017 439  1862 379 032  3151 250 231	400 10 MFZ2/400X 400WGTZ KZISZ-5	Getr. / GBox: ZF 16S 221 für Fahrzeuge mit Zweischeibenkupplung / for vehicles with double disc clutch	(77)
	AE 440			DXI12	 3400 700 350 ⊕  3483 034 042  1878 000 634	430 24 MFZ430 430WGTZ
			 3488 000 122	400 MFZ2/400X	Getr. / GBox: 16S 221DD Getr. / GBox: 16S 122 Getr. / GBox: 16S 181 für Fahrzeuge mit Zweischeibenkupplung / for vehicles with double disc clutch enthält eine Kupplungsscheibe / This part number includes one clutch disc	(77) (67)
			 1862 379 032	400 10 400WGTZ	Getr. / GBox: 16S 221DD Getr. / GBox: 16S 122 Getr. / GBox: 16S 181 für Fahrzeuge mit Zweischeibenkupplung / for vehicles with double disc clutch	(77)
			 3151 262 031	KZISZ-5	Getr. / GBox: 16S 221DD Getr. / GBox: 16S 122 Getr. / GBox: 16S 181 für Fahrzeuge mit Zweischeibenkupplung / for vehicles with double disc clutch	(77)
			 3459 018 004	400 MFZ2/400X	Getr. / GBox: 16S 221DD Getr. / GBox: 16S 122 Getr. / GBox: 16S 181 für Fahrzeuge mit Zweischeibenkupplung / for vehicles with double disc clutch In 3488 enthalten / Contained in 3488	(77) (33)
			 3496 006 000		Getr. / GBox: 16S 221DD Getr. / GBox: 16S 122 Getr. / GBox: 16S 181 für Fahrzeuge mit Zweischeibenkupplung / for vehicles with double disc clutch langer Bügel / long handle	(77) (86)
			 1878 004 832	430 10 430WGTZ	Getr. / GBox: 16S 221DD Getr. / GBox: 16S 122 Getr. / GBox: 16S 181	
			 3151 274 131	KZISZ-5	Getr. / GBox: 16S 221DD Getr. / GBox: 16S 122 Getr. / GBox: 16S 181	

		CODE				
--	--	------	--	---	---	---

RENAULT TRUCKS

Magnum		09.90 -					
AE 480		DXI12	 3400 700 351 ⊕ ⊗ 3483 034 043 ⊗ 1878 006 129	430 24 MFZ430 430WGTZ	Getr. / GBox: VT2412B Euro 5 / Euro 5	(17)	
			 3488 000 122	400 MFZ2/400X	Getr. / GBox: 16S 221DD Getr. / GBox: 16S 122 Getr. / GBox: 16S 181 für Fahrzeuge mit Zweischeibenkupplung / for vehicles with double disc clutch enthält eine Kupplungsscheibe / This part number includes one clutch disc	(77) (67)	
			 1862 379 032	400 10 400WGTZ	Getr. / GBox: 16S 221DD Getr. / GBox: 16S 122 Getr. / GBox: 16S 181 für Fahrzeuge mit Zweischeibenkupplung / for vehicles with double disc clutch	(77)	
			 3151 262 031	KZISZ-5	Getr. / GBox: 16S 221DD Getr. / GBox: 16S 122 Getr. / GBox: 16S 181 für Fahrzeuge mit Zweischeibenkupplung / for vehicles with double disc clutch	(77)	
			 3459 018 004	400 MFZ2/400X	Getr. / GBox: 16S 221DD Getr. / GBox: 16S 122 Getr. / GBox: 16S 181 für Fahrzeuge mit Zweischeibenkupplung / for vehicles with double disc clutch In 3488 enthalten / Contained in 3488	(77) (33)	
			 3496 006 000		Getr. / GBox: 16S 221DD Getr. / GBox: 16S 122 Getr. / GBox: 16S 181 für Fahrzeuge mit Zweischeibenkupplung / for vehicles with double disc clutch langer Bügel / long handle	(77) (86)	
			 3151 274 131	KZISZ-5	Getr. / GBox: 16S 221DD Getr. / GBox: 16S 122 Getr. / GBox: 16S 181		
AE 500. (11CWA1)	01.92 -	MackEE9	 3400 093 031 ⊕ ⊗ 3488 017 334 ⊗ 1862 379 031	400 20 MFZ2/400X 400WGVZ			
AE 500. 18 T (11GWA3)	01.90 - 04.92	MackEE9	 3400 117 001 ⊗ 3482 123 441 ⊗ 1878 020 241 ⊕ 3100 008 106	430 20 GMFZ430 430WGTZ KZISZ-5	Getr. / GBox: B18		
AE 500. 19 (11AWA1)	01.90 - 04.92						
AE 500. 19 T (11GWA1)	01.90 - 04.92						
AE 500. 22 T (11GWA1)	01.90 - 04.92						
AE 500. 26 6x2 (11CWA1)	01.90 - 04.92						
AE 520.18	10.92 - 05.96	MackEE9	 3400 117 532 ⊗ 3488 017 439 ⊗ 1862 379 031 ⊕ 3151 250 231	400 20 MFZ2/400X 400WGVZ KZISZ-5	04.1995-> Getr. / GBox: B9+35mm,B18 für Fahrzeuge mit Zweischeibenkupplung / for vehicles with double disc clutch	(77)	
AE 520.18T	10.92 - 05.96						
AE 520.19	10.92 - 05.96						
AE 520.19T	10.92 - 05.96						
AE 520.22T	10.92 - 05.96						
AE 520.24	10.92 - 05.96						
AE 520.24T	10.92 - 05.96						
AE 520.26T	10.92 - 05.96						
AE 520.26	10.92 -	MackEE9	 3400 117 532 ⊗ 3488 017 439 ⊗ 1862 379 031 ⊕ 3151 250 231	400 20 MFZ2/400X 400WGVZ KZISZ-5	04.1995 - 05.1996 Getr. / GBox: B9+35mm,B18 für Fahrzeuge mit Zweischeibenkupplung / for vehicles with double disc clutch	(77)	
AE 560.18	04.96 -	MackEE9	 3400 117 631 ▲ ⊗ 3488 017 442 ⊗ 1878 002 455 ⊕ 3151 250 231	400 20 MFZ2/400X 400WGTZ KZISZ-5	Getr. / GBox: B9+35mm,18 für Fahrzeuge mit Zweischeibenkupplung / for vehicles with double disc clutch	(77)	
AE 560.18T	04.96 -						
AE 560.19	04.96 -						
AE 560.19T	04.96 -						
AE 560.26	04.96 -						
AE 560.26T	01.97 -						
AE 560.26T	01.98 -						

RENAULT TRUCKS

















Magnum		09.90 -					
DXi 12 440.18	10.04 - 04.06	DXi12		3400 700 350 ⊕ ⊗ 3483 034 042 ⊗ 1878 000 634	430 24 MFZ430 430WGTZ	Getr. / GBox: VT2412B	
DXi 12 440.18 T	10.04 - 04.06			3488 000 122	400 MFZ2/400X	Getr. / GBox: 16S-2220 / 16S-221DD Getr. / GBox: 16S-122 / 16S-181 für Fahrzeuge mit Zweischeibenkupplung / for vehicles with double disc clutch enthält eine Kupplungsscheibe / This part number includes one clutch disc	(77) (67)
DXi 12 440.24	10.04 - 04.06			1862 379 032	400 10 400WGTZ	Getr. / GBox: 16S-2220 / 16S-221DD Getr. / GBox: 16S-122 / 16S-181 für Fahrzeuge mit Zweischeibenkupplung / for vehicles with double disc clutch	(77)
DXi 12 440.26	10.04 - 04.06			3151 262 031	KZISZ-5	Getr. / GBox: 16S-2220 / 16S-221DD Getr. / GBox: 16S-122 / 16S-181 für Fahrzeuge mit Zweischeibenkupplung / for vehicles with double disc clutch	(77)
DXi 12 440.26 T	10.04 - 04.06			3496 006 000		Getr. / GBox: 16S-2220 / 16S-221DD Getr. / GBox: 16S-122 / 16S-181 für Fahrzeuge mit Zweischeibenkupplung / for vehicles with double disc clutch langer Bügel / long handle	(77) (86)
				3400 700 399 ⊗ 3482 083 034 ⊗ 1878 004 832 ⊗ 3151 274 131	430 10 MFZ430 430WGTZ KZISZ-5	Getr. / GBox: 16S-221DD / 16S-122 Getr. / GBox: 16S-181 / 16S-222 Getr. / GBox: 16S-220	
DXi 12 480.18	10.04 - 04.06		DXi12		3400 700 351 ⊕ ⊗ 3483 034 043 ⊗ 1878 006 129	430 24 MFZ430 430WGTZ	Getr. / GBox: VT2412B Euro 5 / Euro 5
DXi 12 480.18 T	10.04 - 04.06			3488 000 122	400 MFZ2/400X	Getr. / GBox: 16S-2220 / 16S-221DD Getr. / GBox: 16S-122 / 16S-181 für Fahrzeuge mit Zweischeibenkupplung / for vehicles with double disc clutch enthält eine Kupplungsscheibe / This part number includes one clutch disc	(77) (67)
DXi 12 480.24	10.04 - 04.06			1862 379 032	400 10 400WGTZ	Getr. / GBox: 16S-2220 / 16S-221DD Getr. / GBox: 16S-122 / 16S-181 für Fahrzeuge mit Zweischeibenkupplung / for vehicles with double disc clutch	(77)
DXi 12 480.26	10.04 - 04.06			3151 262 031	KZISZ-5	Getr. / GBox: 16S-2220 / 16S-221DD Getr. / GBox: 16S-122 / 16S-181 für Fahrzeuge mit Zweischeibenkupplung / for vehicles with double disc clutch	(77)
DXi 12 480.26 T	10.04 - 04.06			3496 006 000		Getr. / GBox: 16S-2220 / 16S-221DD Getr. / GBox: 16S-122 / 16S-181 für Fahrzeuge mit Zweischeibenkupplung / for vehicles with double disc clutch langer Bügel / long handle	(77) (86)
				3400 700 399 ⊗ 3482 083 034 ⊗ 1878 004 832 ⊗ 3151 274 131	430 10 MFZ430 430WGTZ KZISZ-5	Getr. / GBox: 16S-2220	
				3400 700 382 ⊗ 3482 000 691 ⊗ 1878 003 968 ⊗ 3151 274 131	430 10 MFZ430 430WGTZ KZISZ-5	Getr. / GBox: 16S-222	
				3482 000 246	430 MFZ430	Getr. / GBox: 16S-221DD / 16S-122 Getr. / GBox: 16S-181	
				1878 003 968	430 10 430WGTZ	Getr. / GBox: 16S-221DD / 16S-122 Getr. / GBox: 16S-181	
				3151 274 131	KZISZ-5	Getr. / GBox: 16S-221DD / 16S-122 Getr. / GBox: 16S-181	



RENAULT TRUCKS





















Magnum		09.90 -						
DXi 13 440.19 DXi 13 480.19 DXi 13 480.26 DXi 13 520.18 DXi 13 520.19 DXi 13 520.24 DXi 13 520.25 DXi 13 520.26	03.09- 03.09- 03.09- 08.09- 08.09- 08.09- 08.09- 08.09-	DXi13	 3400 710 061 # ⊙ 3482 000 553 ⊙ 1878 007 046 ⬠ 6482 000 155	430 24 MF430 430WGTX PHIS-6/38	Getr. / GBox: AT2412C/AT2512C Getr. / GBox: ATO2512C Euro 5 / Euro 5	(17)		
			 3400 710 066 ● ⊙ 3482 001 308 ⊙ 1878 007 046 ⬠ 6482 000 155	430 24 MF430 430WGTX PHIS-6/38	Getr. / GBox: AT2412C/AT2512C Getr. / GBox: ATO2512C Euro 6 / Euro 6	(18)		
			 3400 700 470 ⊙ 3482 634 004 ⊙ 1878 003 968 ⬠ 3151 274 131	430 10 MFZ430 430WGTX KZISZ-5	Getr. / GBox: ZF 16S-2520 TO Getr. / GBox: ZF 16S-2320 TD für Fahrzeuge mit Einscheibenkupplung / for vehicles with single disc clutch	(72)		
			 3400 700 311 ⊙ 3488 017 439 ⊙ 1862 379 032 ⬠ 3151 262 031	400 10 MFZ2/400X 400WGTX KZISZ-5	Getr. / GBox: ZF 16S-2520 TO Getr. / GBox: ZF 16S-2320 TD für Fahrzeuge mit Zweis Scheibenkupplung / for vehicles with double disc clutch	(77)		
			 3400 700 438 ⊙ 3482 634 004 ⊙ 1878 003 968 ⬠ 3151 001 035	430 10 MFZ430 430WGTX	Getr. / GBox: 16S2230			
DXi 13 460.18 T DXi 13 460.24 DXi 13 460.25 DXi 13 460.26 DXi 13 460.26 T DXi 13 500.18 T DXi 13 500.24 DXi 13 500.25 DXi 13 500.26 DXi 13 500.26 T	05.06- 05.06- 05.06- 05.06- 05.06- 05.06- 05.06- 05.06- 05.06- 05.06-	DXi13	 3400 710 061 # ⊙ 3482 000 553 ⊙ 1878 007 046 ⬠ 6482 000 155	430 24 MF430 430WGTX PHIS-6/38	Getr. / GBox: AT2412C/AT2512C Getr. / GBox: ATO2512C Euro 5 / Euro 5	(17)		
			 3400 700 470 ⊙ 3482 634 004 ⊙ 1878 003 968 ⬠ 3151 274 131	430 10 MFZ430 430WGTX KZISZ-5	Getr. / GBox: ZF 16S-2520 TO Getr. / GBox: ZF 16S-2320 TD für Fahrzeuge mit Einscheibenkupplung / for vehicles with single disc clutch	(72)		
			 3400 700 311 ⊙ 3488 017 439 ⊙ 1862 379 032 ⬠ 3151 262 031	400 10 MFZ2/400X 400WGTX KZISZ-5	Getr. / GBox: ZF 16S-2520 TO Getr. / GBox: ZF 16S-2320 TD für Fahrzeuge mit Zweis Scheibenkupplung / for vehicles with double disc clutch	(77)		
E.TECH 400.18 E.TECH 400.18T E.TECH 400.24 E.TECH 400.26 E.TECH 480.18 E.TECH 480.18T E.TECH 480.24 E.TECH 480.26 E.TECH 480.26T	05.00- 05.00- 05.00- 05.00- 05.00- 05.00- 05.00- 05.00- 05.00-	MACKE.TECHC /46, MACKE.TECHA /46	 3400 700 334 ⊙ 3482 083 252 ⊙ 1878 004 832 ⬠ 3151 274 131	430 10 MFZ430 430WGTX KZISZ-5	->03.2003			
			 3400 700 332 ⊙ 3482 083 252 ⊙ 1878 004 832 ⬠ 3151 000 144	430 10 MFZ430 430WGTX KZISZ-5	03.2003->			
			 3400 700 311 ⊙ 3488 017 439 ⊙ 1862 379 032 ⬠ 3151 262 031	400 10 MFZ2/400X 400WGTX KZISZ-5	für Fahrzeuge mit Zweis Scheibenkupplung / for vehicles with double disc clutch	(77)		
E.TECH 440.18 E.TECH 440.18T E.TECH 440.24 E.TECH 440.26 E.TECH 440.26T	05.00- 05.00- 05.00- 05.00- 05.00-	MACKE.TECHB /46	 3400 700 332 ⊙ 3482 083 252 ⊙ 1878 004 832 ⬠ 3151 000 144	430 10 MFZ430 430WGTX KZISZ-5				
			 3400 700 311 ⊙ 3488 017 439 ⊙ 1862 379 032 ⬠ 3151 262 031	400 10 MFZ2/400X 400WGTX KZISZ-5	für Fahrzeuge mit Zweis Scheibenkupplung / for vehicles with double disc clutch	(77)		
E.TECH 440.26T E.TECH 480.26T	05.00- 05.00-	MACKE.TECHC /46, MACKE.TECHB /46	 3400 700 311 ⊙ 3488 017 439 ⊙ 1862 379 032 ⬠ 3151 262 031	400 10 MFZ2/400X 400WGTX KZISZ-5	für Fahrzeuge mit Zweis Scheibenkupplung / for vehicles with double disc clutch	(77)		
Major		05.91 - 10.96						
360	04.82-	MIVS083530	 3400 116 601 ⊙ 3482 097 141 ⊙ 1878 020 241 ⬠ 3100 008 106	430 20 GMFZ430 430WGTX KZISZ-5	Getr. / GBox: B9/B18			
360	01.86-	MIVS083530	 3400 123 201 ▲ ⊙ 3482 123 441 ⊙ 1878 022 841 ⬠ 3100 008 106	430 10 GMFZ430 430GTZ KZISZ-5				
360	- 12.86	MIVS083530	 3482 097 141	430 GMFZ430	Getr. / GBox: Fuller			
			 1878 022 841	430 10 430GTZ	Getr. / GBox: Fuller			

RENAULT TRUCKS

































































Major		05.91 - 10.96				
R 340ti.16/T R 340ti.17 R 340ti.18 R 340ti.19 R 340ti.19/T R 340ti.24	05.91 - 10.96	MIDR06.20.45E, MIDR06.20.45E 2,	 3400 123 201 ▲ ⊗ 3482 123 441 ⊗ 1878 022 841 ⬤ 3100 008 106	430 10 GMFZ430 430GTZ KZISZ-5	->09.1992 Getr. / GBox: Eaton	
	05.91 - 10.96	MIDR06.20.45E 3	 3400 116 601 ⊗ 3482 097 141 ⊗ 1878 020 241 ⬤ 3100 008 106	430 20 GMFZ430 430WGTZ KZISZ-5	->09.1992 Getr. / GBox: B9/B18	
	05.91 - 10.96		 3400 123 301 ▲ ⊗ 3482 123 243 ⊗ 1878 022 841 ⬤ 3100 008 106	430 10 MFZ430 430GTZ KZISZ-5	10.1992-> Getr. / GBox: Fuller	
	05.91 - 10.96		 3400 123 101 # ⊗ 3482 123 243 ⊗ 1878 020 241 ⬤ 3100 008 106	430 20 MFZ430 430WGTZ KZISZ-5	Getr. / GBox: B9	
	05.91 - 10.96		 3400 117 101 ⊗ 3482 123 243 ⊗ 1878 020 241 ⬤ 3100 008 204	430 20 MFZ430 430WGTZ	Getr. / GBox: B9+35mm,B18	
	05.91 - 10.96					
R 340ti.18/T R 340ti.26 R 350.18/T	05.91 - 10.96	MIDR06.35.40G	 3400 117 001 ⊗ 3482 123 441 ⊗ 1878 020 241 ⬤ 3100 008 106	430 20 GMFZ430 430WGTZ KZISZ-5	->09.1992 Getr. / GBox: B9/B18	
	05.91 - 10.96	MIDR06.20.45E, MIDR06.20.45E 2,	 3400 093 031 ⊕ ⊗ 3488 017 334 ⊗ 1862 379 031	400 20 MFZ2/400X 400WGVZ	für Fahrzeuge mit Zweischeibenkupplung / for vehicles with double disc clutch	(77)
	05.91 - 12.92	MIDR06.20.45E 3	 3400 117 101 ⊗ 3482 123 243 ⊗ 1878 020 241 ⬤ 3100 008 204	430 20 MFZ430 430WGTZ	Getr. / GBox: B9+35mm,B18	
R 350.17 R 350.17/T R 350.18 R 350.19 R 350.19/T R 350.19/TB R 350.24 R 350.26	05.91 - 12.92	MIDR06.35.40G	 3400 116 601 ⊗ 3482 097 141 ⊗ 1878 020 241 ⬤ 3100 008 106	430 20 GMFZ430 430WGTZ KZISZ-5	->09.1992 Getr. / GBox: B9/B18	
	05.91 - 12.92		 3400 123 201 ▲ ⊗ 3482 123 441 ⊗ 1878 022 841 ⬤ 3100 008 106	430 10 GMFZ430 430GTZ KZISZ-5	->09.1992 Getr. / GBox: Fuller	
	05.91 - 12.92		 3400 117 101 ⊗ 3482 123 243 ⊗ 1878 020 241 ⬤ 3100 008 204	430 20 MFZ430 430WGTZ	10.1992-> Getr. / GBox: B9+35mm	
	05.91 - 12.92		 3400 123 101 # ⊗ 3482 123 243 ⊗ 1878 020 241 ⬤ 3100 008 106	430 20 MFZ430 430WGTZ KZISZ-5	10.1992-> Getr. / GBox: B9	
	05.91 - 10.92					
R 380.22/T R 380.25	05.91 - 12.92	MIDR06.35.40H	 3400 117 001 ⊗ 3482 123 441 ⊗ 1878 020 241 ⬤ 3100 008 106	430 20 GMFZ430 430WGTZ KZISZ-5	->09.1992 Getr. / GBox: B9/B18	
	05.91 - 12.92		 3400 123 201 ▲ ⊗ 3482 123 441 ⊗ 1878 022 841 ⬤ 3100 008 106	430 10 GMFZ430 430GTZ KZISZ-5	->09.1992 Getr. / GBox: Eaton 14613	
	05.91 - 12.92		 3400 123 101 # ⊗ 3482 123 243 ⊗ 1878 020 241 ⬤ 3100 008 106	430 20 MFZ430 430WGTZ KZISZ-5	10.1992-> Getr. / GBox: B9	
	05.91 - 12.92		 3400 117 101 ⊗ 3482 123 243 ⊗ 1878 020 241 ⬤ 3100 008 204	430 20 MFZ430 430WGTZ	10.1992-> Getr. / GBox: B9+35mm,B18	

		CODE				
--	--	------	--	---	---	---

RENAULT TRUCKS





















Major		05.91 - 10.96					
R 385ti.17,R 380.17	05.91 - 10.96	MIDR06.35.40L		3400 117 001 ⊗ 3482 123 441 ⊗ 1878 020 241 ⬢ 3100 008 106	430 20 GMFZ430 430WGTZ KZISZ-5	->09.1992 Getr. / GBox: B9/B18	
R 385ti.18,R 380.18	05.91 - 10.96	¹ MIDR06.35.40N/					
R 385ti.18/T,R 380.18/T	05.91 - 10.96	3,					
R 385ti.19,R 380.19	05.91 - 10.96	MIDR06.35.40H		3400 123 201 ▲ ⊗ 3482 123 441 ⊗ 1878 022 841 ⬢ 3100 008 106	430 10 GMFZ430 430GTZ KZISZ-5	->09.1992 Getr. / GBox: Eaton RTX 14613	
R 385ti.19/T,R 380.19/T	05.91 - 10.96						
R 385ti.22/T,R 380.19/TB	05.91 - 10.96						
R 385ti.24,R 380.24	05.91 - 10.96			3400 123 301 ▲ ⊗ 3482 123 243 ⊗ 1878 022 841 ⬢ 3100 008 106	430 10 MFZ430 430GTZ KZISZ-5	10.1992-> Getr. / GBox: Eaton	
R 385ti.25,R 380.25	05.91 - 10.96						
R 385ti.25/T,R 380.25/T	05.91 - 10.96						
R 385ti.26	12.91 - 10.96			3400 123 101 # ⊗ 3482 123 243 ⊗ 1878 020 241 ⬢ 3100 008 106	430 20 MFZ430 430WGTZ KZISZ-5	10.1992-> Getr. / GBox: B9	
R 385ti.26,R 380.26	05.91 - 10.96						
R 385ti.26/T,R 380.26/T	05.91 - 10.96			3400 117 101 ⊗ 3482 123 243 ⊗ 1878 020 241 ⬢ 3100 008 204	430 20 MFZ430 430WGTZ	10.1992-> Getr. / GBox: B9+35mm,B18	
R 420ti.18/T	10.92 - 10.96	MIDR06.35.40J		3400 117 101 ⊗ 3482 123 243 ⊗ 1878 020 241 ⬢ 3100 008 204	430 20 MFZ430 430WGTZ	Getr. / GBox: B9+35mm,B18	
R 420ti.19/T	10.92 - 10.96	¹ MIDR06.35.40J/					
R 420ti.22/T	10.92 - 10.96	3					
R 420ti.24/TS	04.92 - 10.96			3400 093 031 ⊕ ⊗ 3488 017 334 ⊗ 1862 379 031	400 20 MFZ2/400X 400WGVZ		
R 420ti.26/TS	04.92 - 10.96						
R 420ti.35/TS	04.92 - 10.96						
RI 357	-09.92	MIDRL1063540		3400 117 001 ⊗ 3482 123 441 ⊗ 1878 020 241 ⬢ 3100 008 106	430 20 GMFZ430 430WGTZ KZISZ-5	Getr. / GBox: B9/B18	
				3400 123 201 ▲ ⊗ 3482 123 441 ⊗ 1878 022 841 ⬢ 3100 008 106	430 10 GMFZ430 430GTZ KZISZ-5	Getr. / GBox: Fuller	
Manager		09.91 - 10.96					
G 200.13	09.91 - 03.93	MIDRO60226H		3400 700 339 ⊗ 3482 124 041 ⊗ 1878 001 729 ⬢ 3151 270 341	350 10 MF350 350GTD KZIS-3	Getr. / GBox: ZFS6.36S	
G 200.15	09.91 - 03.93						
G 200.16	09.91 - 03.93						
G 200.17	09.91 - 03.93						
G 200.18	09.91 - 03.93						
G 210.16	05.92 - 10.96	MIDRO60226H		3400 700 339 ⊗ 3482 124 041 ⊗ 1878 001 729 ⬢ 3151 270 341	350 10 MF350 350GTD KZIS-3	Getr. / GBox: ZFS6.36S Getr. / GBox: Eaton 41067	
G 210.18	05.92 - 10.96						
G 220.17 BOM	09.91 - 10.96	MIDS062045J		1878 049 041 #	430 16 430WGTZ	->06.1995 Getr. / GBox: G406/409	
G 220.19 BOM	09.91 - 10.96			3400 700 341 # ⊗ 3482 083 044 ⊗ 1878 049 041 ⬢ 3100 008 106	430 16 MFZ430 430WGTZ KZISZ-5	07.1995-> Getr. / GBox: G406/409 Getr. / GBox: G406/409 ACS	
G 230.13 SP	09.91 - 03.93	MIDS062030P		3482 037 141	380 GM380	11.1992-> Getr. / GBox: 6.69,B6	
				3482 083 044	430 MFZ430		
				3100 008 106 ⬢ 3151 234 132 ⊗ 3180 000 009	KZISZ-5 KZISZ-5	Beinhaltet Ausrücker und Montagesatz / Contains releaser and fitting kit	(9)
G 230ti.13	09.91 - 03.93	MIDR060226D		3482 037 141	380 GM380	Getr. / GBox: G406/409	
G 230ti.15	09.91 - 03.93						
G 230ti.16	09.91 - 10.96			3151 000 285	KZI-4	Getr. / GBox: G406/409	
G 230ti.17	09.91 - 10.96						
G 230ti.18	05.92 - 10.96						
G 230ti.19	09.91 - 10.96						
G 270.13 SP	03.93 - 10.96	MIDRO62045B/		3400 117 201 ⊗ 3482 083 044 ⊗ 1878 020 241 ⬢ 3100 008 204	430 20 MFZ430 430WGTZ	Getr. / GBox: B9+35mm/B18	
G 270.14 SP	03.93 - 10.96	³					
G 270.18,G 270.17	11.92 - 10.96			3400 117 202	430 20	Getr. / GBox: B9	

RENAULT TRUCKS

Manager		09.91 - 10.96				
G 280.13,G 270.13	09.91 - 10.96	MIDS062045B	 3400 116 801  3482 097 141  1878 027 442  3100 008 106	430 20 GMFZ430 430GTZ KZISZ-5	->09.1992 Getr. / GBox: B9,B18	
G 280.15,G 270.15	09.91 - 10.96		 3400 117 202  3482 083 044  1878 020 241  3100 008 106	430 20 MFZ430 430WGTZ KZISZ-5	10.1992-> Getr. / GBox: B9	
G 280.15/T,G 270.15/T	09.91 - 10.96		 3400 117 201  3482 083 044  1878 020 241  3100 008 204	430 20 MFZ430 430WGTZ	Getr. / GBox: B9+35mm,B18	
G 280.16	09.91 - 03.93		 3400 700 329  3482 083 044  1878 022 841  3100 008 106	430 10 MFZ430 430GTZ KZISZ-5	Getr. / GBox: Fuller	
G 280.16,G 270.16	09.91 - 10.96		 1882 022 101 #	420 G420XN	Getr. / GBox: ZF 16S-130 Nebenantriebs-ID / PTO ID: NMV 130 E	(50)
G 280.17,G 270.18	09.91 - 10.96		 1878 003 276	420 10 420GTZ	Getr. / GBox: ZF 16S-130 Nebenantriebs-ID / PTO ID: NMV 130 E	(50)
G 280.17/T,G 270.17/T	09.91 - 10.96		 3151 204 001	KZI-6	Getr. / GBox: ZF 16S-130 mit Schmierrohranschluss / with lubrication pipe connection Nebenantriebs-ID / PTO ID: NMV 130 E	(91) (50)
G 280.18,G 270.18,G 270.17	09.91 - 10.96		 3400 123 201 ▲  3482 123 441  1878 022 841  3100 008 106	430 10 GMFZ430 430GTZ KZISZ-5	->09.1992 Getr. / GBox: ZF 16S-130 Getr. / GBox: Eaton RTXF 116	
G 280.19	09.91 - 03.93		 3400 116 801  3482 097 141  1878 027 442  3100 008 106	430 20 GMFZ430 430GTZ KZISZ-5	->09.1992 Getr. / GBox: B9,B18	
G 280.19,G 270.19	09.91 - 10.96		 3400 117 202  3482 083 044  1878 020 241  3100 008 106	430 20 MFZ430 430WGTZ KZISZ-5	10.1992-> Getr. / GBox: B9	
G 280.24	09.91 - 10.96	 3400 117 201  3482 083 044  1878 020 241  3100 008 204	430 20 MFZ430 430WGTZ	10.1992-> Getr. / GBox: B9+35mm,B18		
G 280.26,G 270.26	09.91 - 10.96	 3400 116 701  3482 097 141  1878 026 241  3100 008 106	430 10 GMFZ430 430WGTZ KZISZ-5	10.1992-> Getr. / GBox: ZF S6-90		
		 1882 022 101 #	420 G420XN	Getr. / GBox: ZF 16S-130+ Nebenantriebs-ID / PTO ID: NMV130E	(50)	
		 1878 003 276	420 10 420GTZ	Getr. / GBox: ZF 16S-130+ Nebenantriebs-ID / PTO ID: NMV130E	(50)	
		 3151 204 001	KZI-6	Getr. / GBox: ZF 16S-130+ mit Schmierrohranschluss / with lubrication pipe connection Nebenantriebs-ID / PTO ID: NMV130E	(91) (50)	
G 300.13	09.91 - 10.96	MIDR06.20.45D 3, MIDR06.20.45D	 3400 123 201 ▲  3482 123 441  1878 022 841  3100 008 106	430 10 GMFZ430 430GTZ KZISZ-5	->09.1992 Getr. / GBox: ZF 16S-130 Getr. / GBox: Eaton RTXF 116	
G 300.15	09.91 - 10.96		 3400 116 801  3482 097 141  1878 027 442  3100 008 106	430 20 GMFZ430 430GTZ KZISZ-5	->09.1992 Getr. / GBox: B9,B18	
G 300.15/T	09.91 - 10.96		 3400 117 202  3482 083 044  1878 020 241  3100 008 106	430 20 MFZ430 430WGTZ KZISZ-5	10.1992-> Getr. / GBox: B9	
G 300.16	09.91 - 10.96		 3400 117 201  3482 083 044  1878 020 241  3100 008 204	430 20 MFZ430 430WGTZ	10.1992-> Getr. / GBox: B9+35mm,B18	
G 300.17	09.91 - 10.96		 3400 116 701  3482 097 141  1878 026 241  3100 008 106	430 10 GMFZ430 430WGTZ KZISZ-5	10.1992-> Getr. / GBox: ZF S6-90	
G 300.17/T	09.92 - 10.96		 1882 022 101 #	420 G420XN	Getr. / GBox: ZF 16S-130+ Nebenantriebs-ID / PTO ID: NMV130E	(50)
G 300.18	09.92 - 10.96		 1878 003 276	420 10 420GTZ	Getr. / GBox: ZF 16S-130+ Nebenantriebs-ID / PTO ID: NMV130E	(50)
G 300.18	09.92 - 10.96		 3151 204 001	KZI-6	Getr. / GBox: ZF 16S-130+ mit Schmierrohranschluss / with lubrication pipe connection Nebenantriebs-ID / PTO ID: NMV130E	(91) (50)
G 300.19	09.91 - 03.93					
G 300.19	09.91 - 10.96					
G 300.19/T	09.91 - 10.96					
G 300.24	09.91 - 10.96					
G 300.25	09.91 - 10.96					
G 300.26	09.91 - 10.96					
G 300.26 CIT	09.91 - 10.96					
G 300.26/T	09.91 - 10.96					

		CODE				
--	--	------	--	---	---	---







RENAULT TRUCKS

Manager		09.91 - 10.96					
G 300.24	09.91 - 10.96	MIDR06.20.45D 3, MIDR06.20.45D	 3400 123 201 ▲ ⊗ 3482 123 441 ⊗ 1878 022 841 ⊙ 3100 008 106	430 10 GMFZ430 430GTZ KZISZ-5	->09.1992 Getr. / GBox: ZF 16S-130 Getr. / GBox: Eaton RTXF 116		
			 3400 116 801 ⊗ 3482 097 141 ⊗ 1878 027 442 ⊙ 3100 008 106	430 20 GMFZ430 430GTZ KZISZ-5	->09.1992 Getr. / GBox: B9,B18		
			 3400 117 202 ⊗ 3482 083 044 ⊗ 1878 020 241 ⊙ 3100 008 106	430 20 MFZ430 430WGTZ KZISZ-5	10.1992-> Getr. / GBox: B9		
			 3400 117 201 ⊗ 3482 083 044 ⊗ 1878 020 241 ⊙ 3100 008 204	430 20 MFZ430 430WGTZ	10.1992-> Getr. / GBox: B9+35mm,B18		
			 3400 116 701 ⊗ 3482 097 141 ⊗ 1878 026 241 ⊙ 3100 008 106	430 10 GMFZ430 430WGTZ KZISZ-5	10.1992-> Getr. / GBox: ZF S6-90		
			 1882 022 101 #	420 G420XN	Getr. / GBox: ZF 16S-130+ Nebenantriebs-ID / PTO ID: NMV130E	(50)	
			 1866 030 102	250 32 250/210GS	Getr. / GBox: ZF 16S-130+ Nebenantriebs-ID / PTO ID: NMV130E max. übertragbares Motormoment [Nm] / max. transmittable engine torque [Nm]: 2200	(50) (87)	
			 1878 003 276	420 10 420GTZ	Getr. / GBox: ZF 16S-130+ Nebenantriebs-ID / PTO ID: NMV130E	(50)	
			 3151 204 001	KZI-6	Getr. / GBox: ZF 16S-130+ mit Schmierrohranschluss / with lubrication pipe connection Nebenantriebs-ID / PTO ID: NMV130E	(91) (50)	
G 330.13 G 330.15 G 330.17 G 330.18 G 330.19 G 330.24 G 330.26	09.91 - 03.93	MIDR062045H	 3400 123 201 ▲ ⊗ 3482 123 441 ⊗ 1878 022 841 ⊙ 3100 008 106	430 10 GMFZ430 430GTZ KZISZ-5	Getr. / GBox: Eaton RTXF 116		
			 3400 116 601 ⊗ 3482 097 141 ⊗ 1878 020 241 ⊙ 3100 008 106	430 20 GMFZ430 430WGTZ KZISZ-5	10.1992-> Getr. / GBox: B9/B18		
			 1882 022 101 #	420 G420XN	Getr. / GBox: ZF 16S-130 Nebenantriebs-ID / PTO ID: NMV 130 E	(50)	
			 1878 003 276	420 10 420GTZ	Getr. / GBox: ZF 16S-130 Nebenantriebs-ID / PTO ID: NMV 130 E	(50)	
			 3151 204 001	KZI-6	Getr. / GBox: ZF 16S-130 mit Schmierrohranschluss / with lubrication pipe connection Nebenantriebs-ID / PTO ID: NMV 130 E	(91) (50)	
			G 340ti.16,G 330.16 G 340ti.17,G 330.19 G 340ti.17/T,G 330.17/T G 340ti.18,G 330.18 G 340ti.18/T G 340ti.19,G 330.19 G 340ti.19/T,G 330.19/T G 340ti.19/T,G 330.19/T,G 330.17/T G 340ti.26,G 330.26	09.91 - 10.96	MIDR062045H	 3400 116 601 ⊗ 3482 097 141 ⊗ 1878 020 241 ⊙ 3100 008 106	430 20 GMFZ430 430WGTZ KZISZ-5
 3400 123 201 ▲ ⊗ 3482 123 441 ⊗ 1878 022 841 ⊙ 3100 008 106	430 10 GMFZ430 430GTZ KZISZ-5	->09.1992 Getr. / GBox: ZF 16S-130					
 3400 117 201 ⊗ 3482 083 044 ⊗ 1878 020 241 ⊙ 3100 008 204	430 20 MFZ430 430WGTZ	10.1992-> Getr. / GBox: B9+35mm,B18					
 3400 117 202 ⊗ 3482 083 044 ⊗ 1878 020 241 ⊙ 3100 008 106	430 20 MFZ430 430WGTZ KZISZ-5	10.1992-> Getr. / GBox: B9					
 3400 700 329 ⊗ 3482 083 044 ⊗ 1878 022 841 ⊙ 3100 008 106	430 10 MFZ430 430GTZ KZISZ-5	10.1992-> Getr. / GBox: Eaton					
MASCOTT Kasten/Kombi 01.99 - 12.10							
90.35	01.99 - 12.01	8140.63				 3000 951 026 ⊗ 3083 039 031 ⊗ 1878 002 072 ⊙ 3151 600 529	235 10 MFZ235X 235VTB KZISZ-2





		CODE				
--	--	------	--	---	---	---

RENAULT TRUCKS

MASCOTT Kasten/Kombi 01.99 - 12.10

110.35	01.99 - 06.04	8140.43C	 3000 951 026 ⊗ 3083 039 031 ⊗ 1878 002 072 ⊙ 3151 600 529	235 10 MFZ235X 235VTB KZISZ-2	Getr. / GBox: ZF 5S-200 Getr. / GBox: ZF 6S-300	
		8140.43B	 3151 600 529	KZISZ-2	Getr. / GBox: ZF 5S-200 Getr. / GBox: ZF 6S-300	
110.50 110.55	01.99 - 06.04 01.99 - 06.04	8140.43.B.3588, 8140.43.C.2586, 8140.43.B.3586	 3400 700 444 ■  3151 600 529	265 10 KZISZ-2	Getr. / GBox: ZF 5S-200 Nabenprofil / Hub Profile: 23x29,2x10N Getr. / GBox: ZF 5S-200 Getr. / GBox: ZF 6S-300	(48)
130.35 130.55	01.99 - 06.04 01.99 - 06.04	8140.43.S.2585, 8140.43.S.3585	 3151 600 529	KZISZ-2	Getr. / GBox: ZF 6S-300	
140.35 140.55	01.01 - 06.04 01.01 - 06.04	8140-43k	 3151 600 529	KZISZ-2		

MASCOTT Pritsche/Fahrgestell 01.99 - 12.13

90	01.99 - 12.01	8140.63	 3000 951 026 ⊗ 3083 039 031 ⊗ 1878 002 072 ⊙ 3151 600 529	235 10 MFZ235X 235VTB KZISZ-2	Getr. / GBox: ZF 5S-200	
110	01.99 - 06.04	8140.43.B.3588, 8140.43.C.2586, 8140.43.B.3586	 3400 700 444 ■  3151 600 529	265 10 KZISZ-2	Getr. / GBox: ZF 5S-200 Nabenprofil / Hub Profile: 23x29,2x10N Getr. / GBox: ZF 5S-200 Getr. / GBox: ZF 6S-300	(48)
		8140.43.S.2585, 8140.43.S.3585	 3151 600 529	KZISZ-2	Getr. / GBox: ZF 6S-300	
140 150.35 (A00300161)	01.01 - 06.04 10.01 - 06.04	8140.43N.3585, 8140-43k	 3151 600 529	KZISZ-2		

MASCOTT Kipper 01.00 - 12.10

90	01.00 - 06.04	8140.43C	 3000 951 026 ⊗ 3083 039 031 ⊗ 1878 002 072 ⊙ 3151 600 529	235 10 MFZ235X 235VTB KZISZ-2	Getr. / GBox: ZF 5S-200 Getr. / GBox: ZF 6S-300	
		8140.43B	 3151 600 529	KZISZ-2	Getr. / GBox: ZF 5S-200 Getr. / GBox: ZF 6S-300	
110	01.00 - 06.04	8140.43.B.3588, 8140.43.C.2586, 8140.43.B.3586	 3400 700 444 ■  3151 600 529	265 10 KZISZ-2	Getr. / GBox: ZF 5S-200 Nabenprofil / Hub Profile: 23x29,2x10N Getr. / GBox: ZF 5S-200 Getr. / GBox: ZF 6S-300	(48)

Maxity 03.07 -







150.35 150.45	03.07 - 03.07 -	DXi3	 3400 700 632	280 10		
------------------	--------------------	------	--	--------	--	--







Maxter 10.92 - 06.97









G 230ti.19	10.92 - 05.95	MIDR06.02.26D, MIDR06.02.26X	 3482 000 270 #	380 GM380		
G 280.18 G 280.18/T	10.92 - 03.93 10.92 - 03.93	MIDS062045B	 3400 117 201 ⊗ 3482 083 044 ⊗ 1878 020 241 ⊙ 3100 008 204	430 20 MFZ430 430WGTZ	Getr. / GBox: B9+35mm,B18	
			 3400 117 202 ⊗ 3482 083 044 ⊗ 1878 020 241 ⊙ 3100 008 106	430 20 MFZ430 430WGTZ KZISZ-5	Getr. / GBox: B9	

		CODE				
--	--	------	--	---	---	---

RENAULT TRUCKS













Maxter		10.92 - 06.97					
G 300.18	10.92 - 10.96	MIDR06.20.45E/41,		3400 117 201 ⊕ 3482 083 044 ⊕ 1878 020 241 ⊕ 3100 008 204	430 20 MFZ430 430WGTZ	Getr. / GBox: B9+35mm,B18	
G 300.19	02.96 - 06.97	MIDR06.20.45D					
G 300.19	10.92 - 10.96	3,					
G 300.19/T	10.92 - 10.96	MIDR06.20.45D/41,		3400 117 202 ⊕ 3482 083 044 ⊕ 1878 020 241 ⊕ 3100 008 106	430 20 MFZ430 430WGTZ KZISZ-5	Getr. / GBox: B9	
G 300.26	10.92 - 10.96	MIDR06.20.45E					
G 340ti.19	10.92 - 06.97	3,					
G 340ti.19/T	10.92 - 06.97	MIDR06.20.45D					
G 340ti.25/A,G 340ti.25/B	10.92 - 06.97						
G 340ti.26	10.92 - 06.97						
G 340ti.26,G 340ti.26/B	10.92 - 06.97						
G 340ti.26/B	10.92 - 06.97						
G 340ti.26/C	10.92 - 06.97						
G 340ti.32,G 340ti.32/B	10.92 - 06.97						
G 340ti.32/A,G 340ti.32/B,G 340ti.32/C	10.92 - 06.97						
G 340ti.34	10.92 - 06.97						
G 340ti.34	10.92 - 06.97	MIDR06.20.45E/41,		3400 117 201 ⊕ 3482 083 044 ⊕ 1878 020 241 ⊕ 3100 008 204	430 20 MFZ430 430WGTZ	Getr. / GBox: B9+35mm Getr. / GBox: B18	
G 340ti.34	10.92 - 06.97	MIDR06.20.45E					
G 340ti.40	10.92 - 06.97	3					
		MIDRO62045E		3400 117 202 ⊕ 3482 083 044 ⊕ 1878 020 241 ⊕ 3100 008 106	430 20 MFZ430 430WGTZ KZISZ-5	Getr. / GBox: B9	
				3400 093 031 ⊕ ⊕ 3488 017 334 ⊕ 1862 379 031	400 20 MFZ2/400X 400WGVZ	Getr. / GBox: B9/B18	
				3400 700 329 ⊕ 3482 083 044 ⊕ 1878 022 841 ⊕ 3100 008 106	430 10 MFZ430 430GTZ KZISZ-5	Getr. / GBox: Fuller	



Messenger		05.92 - 06.99					
B 80	01.92 -	SOFIM8140.07		1850 280 790 #	235 MF235	Getr. / GBox: ZF S5.18 Nur bei Altteil-Rückgabe lieferbar (Reparatur; Werk Bielefeld) / Please return old unit for repair (plant Bielefeld)	(51)
				1878 001 713 ▲	235 10 235VTB	Getr. / GBox: ZF S5.18	
				3151 600 751	KZAS-0	Getr. / GBox: ZF S5.18	
B 110	11.92 -	SOFIM8140.27		3499 373 055	250 MF250	->02.1993 Getr. / GBox: ZF S5.24	
				1897 375 775	KZA-5	Getr. / GBox: ZF S5.24	
B 120	11.92 - 02.93	SOFIM8140.47		3499 373 055	250 MF250	Getr. / GBox: ZF S5.24	
				1897 375 775	KZA-5	Getr. / GBox: ZF S5.24	

MESSENGER Kasten/Kombi		09.90 - 06.99					
B 80.35 (FN40B5), 56 kW	09.90 - 06.99	8140.07.2585,		1850 280 790 #	235 MF235	Getr. / GBox: ZF S5.18 Nur bei Altteil-Rückgabe lieferbar (Reparatur; Werk Bielefeld) / Please return old unit for repair (plant Bielefeld)	(51)
B 80.35 (FN40B5), 55 kW	09.90 - 06.99	8140.07.2530ID,					
B 80.45 (FN40A5), 55 kW	09.90 - 06.99	8140.67.2585					
B 80.45 (FN40A5), 56 kW	09.90 - 06.99			1878 001 713 ▲	235 10 235VTB	Getr. / GBox: ZF S5.18	
				1878 002 072 ●	235 10 235VTB	Getr. / GBox: ZF S5.18	
				3151 600 751	KZAS-0	Getr. / GBox: ZF S5.18	
B 110.45 4x4 (4x4F06)	09.96 - 06.99	8140.23.2565		3400 700 630	250 10		
		Sofim8140.28		1897 375 775	KZA-5	Getr. / GBox: ZF	
B 120.35	09.96 - 06.99	8140.43.2585		3400 700 630	250 10		
B 120.55 (FN60F7)	09.96 - 06.99			1897 375 775	KZA-5		
B 120.55 (FN60F5)	01.94 - 09.96	8140.47.2585		1897 375 775	KZA-5		







		CODE				
--	--	------	--	---	---	---

RENAULT TRUCKS

















MESSENGER Pritsche/Fahrgestell 09.90 - 06.99							
B 80.35 (FN40B5), 55 kW B 80.35 (FN40B5), 56 kW B 80.45 (FN40A5), 55 kW B 80.45 (FN40A5), 56 kW	09.90 - 06.99 09.90 - 06.99 09.90 - 06.99 09.90 - 06.99	8140.07.2585, 8140.07.2530ID, 8140.67.2585		1850 280 790 #	235 MF235	Getr. / GBox: ZF S5.18 Nur bei Altteil-Rückgabe lieferbar (Reparatur; Werk Bielefeld) / Please return old unit for repair (plant Bielefeld)	(51)
				1878 001 713 ▲	235 10 235VTB	Getr. / GBox: ZF S5.18	
				1878 002 072 ●	235 10 235VTB	Getr. / GBox: ZF S5.18	
				3151 600 751	KZAS-0	Getr. / GBox: ZF S5.18	
B 110.45 4x4 (4x4F06) B 110.45 16V 4x4 (4x4F06)	09.96 - 06.99 09.96 - 06.99	8140.23.2565, 8140.23.2585 Sofim8140.28		3400 700 630	250 10		
				1897 375 775	KZA-5	Getr. / GBox: ZF	
B 120.35 (FN40B5)	10.91 - 07.96	8140.47.2590, 8140.47.2530ID R		3400 700 630	250 10		
				3499 373 055	250 MF250	->02.1993	
				1897 375 775	KZA-5		
B 120.35 (FN40B7) B 120.55 (FN60F7)	09.96 - 06.99 09.96 - 06.99	8140.43.2585		3400 700 630	250 10		
				1897 375 775	KZA-5		
B 120.55 (FN60F5) B 120.65 (FN60F8) B 120.65 (FN60F6)	01.94 - 09.96 09.96 - 06.99 01.94 - 09.96	8140.43.2585, 8140.47.2585		1897 375 775	KZA-5		

MESSENGER Sattelschlepper 01.94 - 06.99							
B 120.55T (FN60F5)	01.94 - 09.96	8140.47.2585		1897 375 775	KZA-5		
B 120.55T (FN60F7)	09.96 - 06.99	8140.43.2585		3400 700 630	250 10		
				1897 375 775	KZA-5		











































MESSENGER Kipper 09.96 - 06.99							
B 120.35 B 120.55 B 120.65	09.96 - 06.99 09.96 - 06.99 09.96 - 06.99	8140.43.2585		3400 700 630	250 10		
				1897 375 775	KZA-5		

Midliner 10.82 - 01.00							
M 140.11/T M 140.12/C M 140.13/T	05.89 - 03.93 05.89 - 03.93 04.89 - 03.93	MIDS060212C		3400 117 301 # ⊗ 3482 008 033 ⊗ 1861 577 037 ⊙ 3151 199 001	310 10 MF310 310GTD KZIS-3	Getr. / GBox: ZF S 5-35	
		MIDS060212		3400 700 339 ⊗ 3482 124 041 ⊗ 1878 001 729 ⊙ 3151 270 341	350 10 MF350 350GTD KZIS-3	Getr. / GBox: ZF S 6-36	
M 140.13/C M 140.13/C	04.89 - 03.93 05.89 - 03.93	MIDS060212		3400 700 339 ⊗ 3482 124 041 ⊗ 1878 001 729 ⊙ 3151 270 341	350 10 MF350 350GTD KZIS-3	Getr. / GBox: ZF S 6-36	
M 150.09/C M 150.09/C SP M 150.11/C M 150.11/C SP M 150.14/C CIT	11.92 - 10.96 11.92 - 10.96 11.92 - 10.96 11.92 - 10.96 11.92 - 10.96	MIDS060226U		3400 700 339 ⊗ 3482 124 041 ⊗ 1878 001 729 ⊙ 3151 270 341	350 10 MF350 350GTD KZIS-3	Getr. / GBox: Fuller 4106A	
M 150.12/C M 150.12/C BTP M 150.13/C M 150.13/C BTP	11.92 - 10.96 11.92 - 10.96 11.92 - 10.96 11.92 - 10.96	MIDS060226U		3400 700 339 ⊗ 3482 124 041 ⊗ 1878 001 729 ⊙ 3151 270 341	350 10 MF350 350GTD KZIS-3	Getr. / GBox: Fuller 4106A Getr. / GBox: ZF S 6-36	
M 150.12/C M 150.14/C BOM	05.96 - 01.00 11.92 - 10.96	MIDS060226U		3400 700 338 ⊗ 3482 124 041 ⊗ 1878 001 145 ⊙ 3151 270 341	350 10 MF350 350WGTZ KZIS-3	Getr. / GBox: Fuller 4106A	
M 150.13/C	05.96 - 01.00	MIDS060226U		3400 700 338 ⊗ 3482 124 041 ⊗ 1878 001 145 ⊙ 3151 270 341	350 10 MF350 350WGTZ KZIS-3	Getr. / GBox: Fuller 4106A Getr. / GBox: ZF S 6-36	

RENAULT TRUCKS

Midliner		10.82 - 01.00									
M 160.12/C	05.89 - 03.93	MIDS060212	 3400 700 339 ⊗ 3482 124 041 ⊗ 1878 001 729 ⊙ 3151 270 341	350 10 MF350 350GTD KZIS-3	Getr. / GBox: ZF S5-35 Getr. / GBox: ZF S6-36						
M 160.13/C	05.89 - 03.93	MIDS060212B	 3482 124 041	350 MF350	Getr. / GBox: G406/409						
M 160.14/C BOM	05.89 - 03.93				 1878 001 079	350 10 350GTZ	Getr. / GBox: G406/409				
M 160.14/C CIT	05.89 - 03.93				 1878 002 075 #	350 16 350GTZ	Getr. / GBox: G406/409				
M 160.15/D	05.89 - 03.93						 3151 000 285	KZI-4	Getr. / GBox: G406/409		
ME 160.13	05.89 - 03.93										
ME 160.15	05.89 - 03.93										
M 180.10/C	11.92 - 10.96	MIDR06.02.26W	 3400 700 338 ⊗ 3482 124 041 ⊗ 1878 001 145 ⊙ 3151 270 341	350 10 MF350 350WGTZ KZIS-3	Getr. / GBox: Euro1/ZFS6-36						
M 180.11/C	11.92 - 10.96	/41, MIDR06.02.26W									
M 180.11/C SP	11.92 - 10.96										
M 180.12/C	11.92 - 10.96	MIDR06.02.26W/ 41,									
M 180.12/C	05.96 - 01.00	MIDR06.02.26V									
M 180.12/C BTP	11.92 - 10.96										
M 180.13 SP	11.92 - 10.96										
M 180.13/C	11.92 - 10.96										
M 180.13/C	05.96 - 01.00										
M 180.13/C BTP	11.92 - 10.96										
M 180.15/D	11.92 - 10.96										
M 180.15/D	10.96 - 01.00										
M 180.15/D BTP	11.92 - 10.96										
M 180.16/D	11.92 - 10.96										
M 180.16/D	05.96 - 01.00										
M 210.12/C	05.92 - 01.00										
M 210.13/C	05.92 - 01.00										
M 210.15/D	05.92 - 01.00										
M 210.16/D	05.92 - 01.00										
M 200.10/C	05.88 - 03.93	MIDR060226				 3400 700 339 ⊗ 3482 124 041 ⊗ 1878 001 729 ⊙ 3151 270 341	350 10 MF350 350GTD KZIS-3	Getr. / GBox: ZF Getr. / GBox: RVIG406			
M 200.12/C	05.88 - 03.93	MIDR060226H	 3482 124 041	350 MF350	Getr. / GBox: G406/409						
M 200.13/C	05.88 - 03.93				 1878 002 075 #			350 16 350GTZ	Getr. / GBox: G406/409		
M 200.14/C BOM	05.88 - 03.93								 3151 000 285	KZI-4	Getr. / GBox: G406/409
M 200.14/C CIT	05.88 - 03.93										
M 200.15/D	05.88 - 03.93										
M 200.16/D	05.88 - 03.93										
M 210.13/C	05.92 - 01.00	MIDR06.02.26W	 3400 700 339 ⊗ 3482 124 041 ⊗ 1878 001 729 ⊙ 3151 270 341	350 10 MF350 350GTD KZIS-3	Getr. / GBox: ZF S 6-36S						
M 210.13/C SP	05.92 - 10.96	/41, MIDR06.02.26W									
M 210.14/D	05.96 - 01.00										
M 210.15/D CIT	05.92 - 10.96										
M 210.16/D	05.92 - 01.00										
M 210.16/D	05.96 - 01.00										
M 210.16/D CIT	05.92 - 10.96										
M 210.14/C BOM	05.92 - 10.96	MIDR060226W	 3400 700 338 ⊗ 3482 124 041 ⊗ 1878 001 145 ⊙ 3151 270 341	350 10 MF350 350WGTZ KZIS-3	Getr. / GBox: Eaton 4106A						
		 3482 124 041			350 MF350	Getr. / GBox: G406					
						 1878 002 075 #	350 16 350GTZ	Getr. / GBox: G406			
								 3151 000 285	KZI-4	Getr. / GBox: G406	
M 230.10/C	05.89 - 07.92	MIDR060226D	 3482 037 141	380 GM380	Getr. / GBox: G406-1 40ACC4						
					 3151 000 285	KZI-4	Getr. / GBox: G406-1 40ACC4				

RENAULT TRUCKS









































Midliner		10.82 - 01.00						
M 230.12/C	05.92 - 10.96	MIDR06.02.26D, MIDR06.02.26X, MIDR06.02.26S		3482 000 270 #	380			
M 230.12/D	05.89 - 07.92					GM380		
M 230.13/C	05.92 - 10.96			3151 000 285		KZI-4		
M 230.13/C, M 230.13/D	05.89 - 10.96							
M 230.13/D	05.89 - 07.92							
M 230.13C/T	05.89 - 10.96							
M 230.15/D	05.89 - 10.96							
M 230.16/D	05.89 - 10.96							
M 230.16/D CIT	05.89 - 07.92							
M 230.16D/T	05.89 - 10.96							
M 230.15/D	05.89 - 10.96	MIDR060226D		3482 037 141	380	Getr. / GBox: G409 40ACD1		
M 230.15/D CIT	05.89 - 07.92				3151 000 285		Getr. / GBox: G409 40ACD1	
M 250.13/C	05.96 - 01.00	MIDR06.02.26Y/ 41		3400 700 337	395 10			
M 250.15/C, M 250.15/D	05.96 - 01.00				3482 115 031	MFZ395		
M 250.15C/T	05.96 - 01.00				1878 039 631	395GTZ		
M 250.16/D	05.96 - 01.00				3151 250 231	KZISZ-5		
S 90		T4.38		1897 375 775	KZA-5	Getr. / GBox: ZF S5-24		
S 90 09 BOM		720		3499 373 055	250	Getr. / GBox: ZF S5-24		
					1897 375 775	KZA-5	Getr. / GBox: ZF S5-24	
					3499 373 055	250	Getr. / GBox: RVI 321+U407	
					1862 353 041 ▲	250 10	Getr. / GBox: RVI 321+U407	
					1897 375 775	KZA-5	Getr. / GBox: RVI 321+U407	
S 100.06/A	01.86 - 09.90	PerkinsT4-38		1897 375 775	KZA-5	Getr. / GBox: ZFS5-24		
S 100.07/A	01.86 - 09.90							
S 100.08/A	01.86 - 09.90							
S 100.08/A	01.86 - 09.90							
S 100.09/A CIT	01.86 - 09.90							
S 100.09/A BOM	01.86 - 09.90	T4.38		1897 375 775	KZA-5	Getr. / GBox: ZF S5-24		
S 110.06/A	06.85 - 09.90	797		1897 375 775	KZA-5	Getr. / GBox: ZFS5-24		
S 110.07/A	06.85 - 09.90							
S 110.08/A	06.85 - 09.90							
S 120.06/A	09.90 - 11.92	T4.40, T4.40A/3, T4.40CC		3482 092 031 	280	Getr. / GBox: ZF S5-42		
S 120.06/A, S 120.07/A	09.90 - 11.92				1878 001 727 	280 10	Getr. / GBox: ZF S5-42	
S 120.06/A, S 120.07/A	11.92 - 10.94				3151 600 544 	KZISZ-3	Getr. / GBox: ZF S5-42	
S 120.07/A	09.90 - 11.92							
S 120.07/A	11.92 - 10.94							
S 120.08/A	09.92 - 11.92				3400 700 449 	310 10	Getr. / GBox: ZF S5-42	
S 120.08/A	11.92 - 10.94				3482 094 031	MFZ310	Nabenprofil / Hub Profile: 1 1/2"-10N	(48)
S 120.09/A	11.92 - 10.94				1878 000 611	310TB		
S 120.09/B	11.92 - 10.94				3151 600 544	KZISZ-3		
S 120.09/B BOM	09.90 - 11.92							
S 120.09/B BOM	11.92 - 10.94							
S 120.09/B CIT	09.90 - 11.92							
S 120.07/A	09.90 - 11.92	T4.40		3482 092 031 	280			
					1878 001 727 	280 10		
					3151 600 544 	KZISZ-3		
					3400 700 449 	310 10	01.1992->	
					3482 094 031	MFZ310	Nabenprofil / Hub Profile: 1 1/2"-10N	(48)
				1878 000 611	310TB			
				3151 600 544	KZISZ-3			
				3400 700 339	350 10	Getr. / GBox: ZFS5-42		
				3482 124 041	MF350			
				1878 001 729	350GTD			
				3151 270 341	KZIS-3			



RENAULT TRUCKS













Midliner		10.82 - 01.00					
S 120.08/A	09.90 - 11.92	T4.40	3482 092 031 LHD# 280	Getr. / GBox: ZF S5-42			
			1878 001 727 LHD 280 10	MFZ280	Getr. / GBox: ZF S5-42		
			3151 600 544 LHD KZISZ-3	Getr. / GBox: ZF S5-42			
			3400 700 449 RHD # 3482 094 031 MFZ310 1878 000 611 310TB 3151 600 544 KZISZ-3	01.1992-> Getr. / GBox: ZF S5-42 Nabenprofil / Hub Profile: 1 1/2"-10N	(48)		
S 130.06	09.83 - 01.90	797	3400 117 301 #	310 10	Getr. / GBox: ZFS5-35		
S 130.07	09.83 - 01.90		3482 008 033	MF310	Nur zusammen verbauen / Only install together	(53)	
S 130.08/A	09.83 - 01.90		1861 577 037	310GTD			
S 130.08/A, S 130.08/B	09.83 - 01.90		3151 199 001	KZIS-3			
S 130.08/B	09.83 - 01.90		3400 700 339	350 10	Getr. / GBox: ZFS6-36		
S 130.08/R	09.83 - 01.90		3482 124 041	MF350			
S 130.09/B	09.83 - 01.90		1878 001 729	350GTD			
S 130.11	09.83 - 01.90		3151 270 341	KZIS-3			
S 130.11/B	09.83 - 01.90	3482 124 041	350	Getr. / GBox: ZFS6-65			
S 130.13/B	09.83 - 01.90		MF350				
S 135.08/A	02.94 - 05.96	T4.40B/3	3400 700 449 LHD #	310 10	Nabenprofil / Hub Profile: 1 1/2"-10N	(48)	
			3482 094 031 MFZ310 1878 000 611 310TB 3151 600 544 KZISZ-3				
			1878 001 145 RHD 350 10	04.1996->			
			3151 600 544 RHD KZISZ-3	04.1996->			
S 135.08/A, S 150.08/A	05.96 - 01.00	MIDR04.02.26A/ 41, MIDR04.02.26B/ 41	3400 700 449 LHD #	310 10	Nabenprofil / Hub Profile: 1 1/2"-10N	(48)	
S 135.09/B, S 150.09/B	05.96 - 01.00		3482 094 031 MFZ310 1878 000 611 310TB 3151 600 544 KZISZ-3				
			1878 001 145 RHD 350 10	350WGTZ			
			3151 600 544 RHD KZISZ-3				
S 140.07/A	01.90 - 09.93	MIDS060212C	3400 117 301 #	310 10	Getr. / GBox: ZF5-35/6-36		
S 140.08/A, S 140.08/B	01.90 - 09.93		3482 008 033	MF310			
S 140.08/B	01.90 - 09.93		1861 577 037	310GTD			
S 140.09/B	01.90 - 09.93		3151 199 001	KZIS-3			
S 150.08/A	11.92 - 01.94	MIDR060226U	3400 700 339	350 10	Getr. / GBox: Eaton 4106B		
S 150.08/A	05.96 - 01.00		3482 124 041	MF350			
S 150.08/A, S 150.08/B	11.92 - 01.94		1878 001 729	350GTD			
S 150.08/B	11.92 - 01.94		3151 270 341	KZIS-3			
S 150.09/B	11.92 - 01.94						
S 150.09/B	05.96 - 01.00						
S 150.08/A, S 150.08/B	01.94 - 05.96	MIDS06.02.12B, MIDS06.02.12D/ 3	3400 700 339	350 10	Getr. / GBox: ZFS5-42		
S 150.08/B	01.94 - 05.96		3482 124 041	MF350			
S 150.08TI	05.86 - 09.90		1878 001 729	350GTD			
S 150.09/B	01.94 - 05.96		3151 270 341	KZIS-3			
S 150.09TI	05.86 - 09.90						
S 150.11TI	05.86 - 09.90						
S 150.13TI	04.86 - 09.90						
S 150.13TI	05.86 - 09.90						
S 150.14TI BOM	05.86 - 09.90						
S 150.08TI	05.83 - 07.86	798-10	3400 700 339	350 10	Getr. / GBox: ZFS5-35 Getr. / GBox: ZFS6-36		
S 150.09TI	05.83 - 07.86		3482 124 041 MF350 1878 001 729 350GTD 3151 270 341 KZIS-3				
			3482 124 041	350	Getr. / GBox: ZFS6-65		
				MF350			
S 150.08TI/R	05.86 - 09.90	MIDS06.02.12B, MIDS06.02.12D/ 3	3400 700 339	350 10	Getr. / GBox: ZFS5-35 Getr. / GBox: ZFS6-36		
S 150.09/B	01.94 - 05.96		3482 124 041 MF350 1878 001 729 350GTD 3151 270 341 KZIS-3				

RENAULT TRUCKS

Midliner		10.82 - 01.00				
S 150.09/B, S 135.09/B	05.96 - 01.00	MIDR04.02.26A/41, MIDR04.02.26B/41		1878 001 145	350 10 350WGTZ	Getr. / GBox: ZF S5-42 Getr. / GBox: Eaton 4106A
				3151 600 544	KZISZ-3	Getr. / GBox: ZF S5-42 Getr. / GBox: Eaton 4106A
S 160.08/A, S 160.08/B S 160.08/B S 160.09/B S 160.09/B SP	01.90 - 09.93 01.90 - 09.93 01.90 - 09.93 01.90 - 09.93	MIDS060212B		3400 700 339  3482 124 041  1878 001 729  3151 270 341	350 10 MF350 350GTD KZIS-3	Getr. / GBox: ZFS5-35
S 170.11TI S 170.11TI/R S 170.13TI S 170.13TI, S 170 SP S 170.13TI, S 170.13TI/R S 170.13TI/T S 170.14TI S 170.14TI/R S 170.15TI	10.87 - 05.89 10.87 - 05.89 10.83 - 03.93 10.83 - 03.93 10.83 - 05.89 10.84 - 05.89 10.83 - 05.89 10.87 - 05.89 10.82 - 09.93	MIDR060212 798	   	3400 700 339  3482 124 041  1878 001 729  3151 270 341 3482 124 041 1878 002 075 # 3151 000 285	350 10 MF350 350GTD KZIS-3 350 MF350 350 16 350GTZ 350 KZI-4	Getr. / GBox: ZFS5-35 Getr. / GBox: ZFS6-65 Getr. / GBox: BDSL Getr. / GBox: BDSL Getr. / GBox: BDSL Getr. / GBox: ZFS6-65
S 180.08/A S 180.08/A S 180.08/A, S 180.08/B	11.92 - 10.96 05.96 - 01.00 11.92 - 10.96	MIDR060226V		3400 700 339  3482 124 041  1878 001 729  3151 270 341	350 10 MF350 350GTD KZIS-3	Getr. / GBox: Eaton 4106A
S 180.08/A, S 180.08/B S 180.09/B S 180.09/B	11.92 - 10.96 11.92 - 10.96 05.96 - 01.00	MIDR06.02.26V/41, MIDR06.02.26V		3400 700 339  3482 124 041  1878 001 729  3151 270 341	350 10 MF350 350GTD KZIS-3	
S 220.11TI S 220.13TI S 220.13TI/T S 220.14TI S 220.14TI/T	09.87 - 09.90 09.87 - 09.90 09.87 - 09.90 09.87 - 09.90 09.87 - 09.90	MIDR060226		3482 037 141	380 GM380	
Midlum		01.00 -				
135.08/B, 150.08/B 135.09/B, 150.09/B 135.10/B, 150.10/B	01.00 - 01.00 - 01.00 -	MIDR04.02.26B/4, MIDR04.02.26A/4		3400 700 480 ■	350 10	Getr. / GBox: Eaton 4106 Nabenprofil / Hub Profile: 31x38-10N (48)
				3400 700 449 ■  3482 094 031  1878 000 611  3151 600 544	310 10 MFZ310 310TB KZISZ-3	für / for: Midlum 135 (69) Getr. / GBox: ZF S5.42 Getr. / GBox: Eaton 8209 Nabenprofil / Hub Profile: 1 1/2"-10N (48)
150.08/B 150.10/B 150.12/B 180.08/B 180.10/B	10.01 - 10.01 - 01.00 - 10.01 - 10.01 -	MIDR04.02.26B/4, dCi4B, dCi4C		3400 700 626 <small>LHD</small>  3482 001 071  1878 006 847  3151 270 341	362 10 MF362 362WGTZ KZIS-3	Getr. / GBox: ZF 5S-42 Getr. / GBox: Eaton 4106A/B
				3400 700 625  3482 634 003  1878 634 034  3151 600 595	395 10 MF395 395WGTZ	Getr. / GBox: Eaton 9-Gang/shift
160.08 160.10 160.12 190.08 190.10 190.12 190.13 190.14 190.16 220.08 220.10 220.12 220.13 220.14 220.16	05.06 - 05.06 - 05.06 - 05.06 - 05.06 - 05.06 - 05.06 - 05.06 - 05.06 - 05.06 - 05.06 - 05.06 - 05.06 - 05.06 - 05.06 -	DXI5		3400 700 439  3482 001 071  1878 006 848  3151 000 752	362 10 MF362 362WGTZ KZIS-4	
180.08/B	01.00 -	MIDR06.02.26V/4		3400 700 480 ■	350 10	Getr. / GBox: Eaton 4106 Nabenprofil / Hub Profile: 31x38-10N (48)









		CODE				
--	--	------	--	---	---	---











































RENAULT TRUCKS

Midlum		01.00 -					
180.12 220.15 220.18/D	10.01- 10.01- 10.01-	dci6W, dCi4C		3400 700 626 <small>LHD</small> ⊗ 3482 001 071 ⊗ 1878 006 847 ⊙ 3151 270 341	362 10 MF362 362WGTZ KZIS-3	Getr. / GBox: ZF 5S-42 Getr. / GBox: Eaton 5206A	
180.12/B, 180.12/C	10.01-	dCi4C		3400 700 626 <small>LHD</small> ⊗ 3482 001 071 ⊗ 1878 006 847 ⊙ 3151 270 341	362 10 MF362 362WGTZ KZIS-3	Getr. / GBox: ZF 5S-42 Getr. / GBox: Eaton 4106A/B Getr. / GBox: Eaton 4106 OD/5206A	
				3400 700 625 ⊗ 3482 634 003 ⊗ 1878 634 034 ⊙ 3151 600 595	395 10 MF395 395WGTZ	Getr. / GBox: Eaton 9-Gang/shift	
210.08/B	01.00-	MIDR06.02.26W /4		3400 700 626 <small>LHD</small> ⊗ 3482 001 071 ⊗ 1878 006 847 ⊙ 3151 270 341	362 10 MF362 362WGTZ KZIS-3	Getr. / GBox: ZF 5S-42 Getr. / GBox: Eaton 4106 OD/5206A	
				3400 700 480 	350 10	Getr. / GBox: Eaton 4106 Nabenprofil / Hub Profile: 31x38-10N	(48)
210.08/B, 220.08/B	01.00-	dci6W, MIDR06.02.2 6W/4		3400 700 626 <small>LHD</small> ⊗ 3482 001 071 ⊗ 1878 006 847 ⊙ 3151 270 341	362 10 MF362 362WGTZ KZIS-3	Getr. / GBox: ZF 5S-42 Getr. / GBox: Eaton 4106 OD/5206A	
				3400 700 625 ⊗ 3482 634 003 ⊗ 1878 634 034 ⊙ 3151 600 595	395 10 MF395 395WGTZ	Getr. / GBox: Eaton 9-Gang/shift	
210.09/B 210.10/B	01.00- 01.00-	MIDR06.02.26W /4		3400 700 626 <small>LHD</small> ⊗ 3482 001 071 ⊗ 1878 006 847 ⊙ 3151 270 341	362 10 MF362 362WGTZ KZIS-3	Getr. / GBox: ZF 5S-42	
				3400 700 480 	350 10	Getr. / GBox: Eaton 4106 Nabenprofil / Hub Profile: 31x38-10N	(48)
210.10/B, 220.10/B	01.00-	dci6W, MIDR06.02.2 6W/4		3400 700 626 <small>LHD</small> ⊗ 3482 001 071 ⊗ 1878 006 847 ⊙ 3151 270 341	362 10 MF362 362WGTZ KZIS-3	Getr. / GBox: ZF 5S-42	
				3400 700 625 ⊗ 3482 634 003 ⊗ 1878 634 034 ⊙ 3151 600 595	395 10 MF395 395WGTZ	Getr. / GBox: Eaton 9-Gang/shift	
210.12/C 210.13/C 210.15/C	01.00- 01.00- 01.00-	MIDR06.02.26W /4		3400 700 626 <small>LHD</small> ⊗ 3482 001 071 ⊗ 1878 006 847 ⊙ 3151 270 341	362 10 MF362 362WGTZ KZIS-3	Getr. / GBox: ZF 5S-42 Getr. / GBox: Eaton 4106A/B Getr. / GBox: Eaton 4106 OD/5206A	
				3400 700 480 	350 10	Getr. / GBox: Eaton 4106 Nabenprofil / Hub Profile: 31x38-10N	(48)
210.12/C, 220.12/C 210.13/C, 220.13/C, 220.13/D 210.14/C, 220.14/C, 220.14/D 210.16/C, 220.16/C, 22.16/D 270.12/C 270.13/C, 270.13/D 270.14/C, 270.14/D 270.16/C, 270.16/D	01.00- 01.00- 01.00- 01.00- 10.01- 10.01- 10.01- 10.01-	dci6A, dci6W, MIDR06.02.2 6W/4		3400 700 626 <small>LHD</small> ⊗ 3482 001 071 ⊗ 1878 006 847 ⊙ 3151 270 341	362 10 MF362 362WGTZ KZIS-3	Getr. / GBox: ZF 5S-42 Getr. / GBox: Eaton 4106A/B Getr. / GBox: Eaton 4106 OD/5206A	
220.12 220.14 220.16	10.01- 10.01- 10.01-	dci6W		3400 700 626 <small>LHD</small> ⊗ 3482 001 071 ⊗ 1878 006 847 ⊙ 3151 270 341	362 10 MF362 362WGTZ KZIS-3	Getr. / GBox: ZF 5S-42 Getr. / GBox: Eaton 5206A	
				3400 700 625 ⊗ 3482 634 003 ⊗ 1878 634 034 ⊙ 3151 600 595	395 10 MF395 395WGTZ	Getr. / GBox: Eaton 9-Gang/shift	



















		CODE					
--	--	------	--	--	---	---	---

RENAULT TRUCKS

























































Midlum		01.00 -					
240.12	05.06-	DXI7		3400 700 466	395 10	Getr. / GBox: ZF 9S1110TO Getr. / GBox: ZF 6S1000TO Getr. / GBox: ZF 6S850OD	
240.13	05.06-			 3482 634 003	MF395		
240.14	05.06-			 1878 634 034	395WGTZ		
240.15	05.06-			 3151 000 752	KZIS-4		
240.16	05.06-						
240.18	05.06-						
280.12	05.06-						
280.13	05.06-						
280.14	05.06-						
280.16	05.06-						
280.18	05.06-						
270.16/C	10.01-	dci6A		3400 700 626 ^{LHD}	362 10	Getr. / GBox: ZF 5S-42	
270.18/D	10.01-			 3482 001 071	MF362		
				 1878 006 847	362WGTZ		
				 3151 270 341	KZIS-3		

Premium		04.96 -									
Distribution 210.16	04.96-	MIDR06.02.26V/4		1878 001 145	350 10	Getr. / GBox: Eaton 4106 A					
				 3151 600 544	350WGTZ						
				 3400 700 337	KZISZ-3						
				 3482 115 031	395 10	Getr. / GBox: Eaton 8209 A					
				 1878 039 631	MFZ395						
				 3151 250 231	395GTZ						
Distribution 210.18D, 220.18	04.96-	dci6W, MIDR06.02.2 6W/4		1878 001 145	350 10	für / for: Premium 210 Getr. / GBox: Eaton 4106 A	(69)				
				 3151 600 544	350WGTZ						
								 3482 115 031	395 10	für / for: Premium 210 Getr. / GBox: Eaton 4106 A	(69)
								 1878 039 631	MFZ395		
								 3151 250 231	395GTZ	für / for: Premium 210 Getr. / GBox: Eaton 8209 A	(69)
				 3400 700 625	KZISZ-5						
				 3482 634 003	395 10	Getr. / GBox: Eaton 9-Gang/shift					
				 1878 634 034	MF395						
				 3151 600 595	395WGTZ						
				 3400 700 337		Getr. / GBox: Eaton 8209 A					
Distribution 250.16	04.96-	MIDR06.02.26V/ 41		 3482 115 031	395 10						
Distribution 250.18D	04.96-			 1878 039 631	MFZ395						
Distribution 250.19	04.96-			 3151 250 231	395GTZ						
				 3400 700 409	430 10	Getr. / GBox: Eaton 8209 A Getr. / GBox: ZF 9S-109 Getr. / GBox: ZF 16S-109					
Distribution 260 BOM	06.96-	MIDR062045C/4		 3482 083 252	430 10						
Distribution 260.16	04.96-			 1878 026 241	MFZ430						
Distribution 260.18	04.96-			 3151 250 231	430WGTZ						
Distribution 260.19	04.96-				KZISZ-5						
Distribution 270.18	08.00-	dci6A		3400 700 625	395 10	Getr. / GBox: Eaton 9-Gang/shift					
				 3482 634 003	MF395						
				 1878 634 034	395WGTZ						
				 3151 600 595		für / for: MF 362	(69)				
				 3151 270 341	KZIS-3						
				 3400 700 009							
Distribution 300 BOM	06.96-	MIDR06.20.45D/ 41		3400 123 401	430 20	Getr. / GBox: B9					
				 3482 083 252	MFZ430						
Distribution 300.16D	04.96-		 1878 020 241	430WGTZ							
Distribution 300.16T	04.96-		 3151 250 231	KZISZ-5							
Distribution 300.18D	04.96-										
Distribution 300.18D/T	04.96-										
Distribution 300.19	04.96-										
Distribution 300.19D/T	04.96-										
Distribution 300.26D	04.96-										
Route 300.16	09.96-										
Route 300.18	09.96-										
Route 300.18T	09.96-										
Route 300.19	09.96-										
Route 300.19T	09.96-										
				 3400 117 532	400 20	Getr. / GBox: B9+35mm,B18 für Fahrzeuge mit Zweischeibenkupplung / for vehicles with double disc clutch	(77)				
				 3488 017 439	MFZ2/400X						
				 1862 379 031	400WGVZ	Je nach Kundenwunsch mit unterschiedlicher Kupplung / Equipped with different clutch according to customer requirement	(35)				
				 3151 250 231	KZISZ-5						
				 3400 700 409	430 10	Getr. / GBox: ZF 9S-109 Getr. / GBox: ZF 16S-109 Getr. / GBox: Eaton 8209 A					
				 3482 083 252	MFZ430						
				 1878 026 241	430WGTZ						
				 3151 250 231	KZISZ-5						

RENAULT TRUCKS























Premium		04.96 -					
Distribution 320.18 Distribution 320.18 D Route 320.18	08.00-	dCi11G	 3400 700 409 ⊗ 3482 083 252 ⊗ 1878 026 241 ⊙ 3151 250 231	430 10 MFZ430 430WGTZ KZISZ-5	Getr. / GBox: ZF 9S-109		
	08.00-		 3400 700 332 ⊗ 3482 083 252 ⊗ 1878 004 832 ⊙ 3151 000 144	430 10 MFZ430 430WGTZ KZISZ-5	Getr. / GBox: ZF AS Tronic		
	08.00-		 3400 700 311 ⊗ 3488 017 439 ⊗ 1862 379 032 ⊙ 3151 262 031	400 10 MFZ2/400X 400WGTZ KZISZ-5	Getr. / GBox: ZF 12AS2301 für Fahrzeuge mit Zweischeibenkupplung / for vehicles with double disc clutch	(77)	
			 3400 700 625 ⊗ 3482 634 003 ⊗ 1878 634 034 ⊙ 3151 600 595	395 10 MF395 395WGTZ	Getr. / GBox: Eaton 9-Gang/shift		
			 3189 600 009				
Distribution 320.24D Distribution 320.26D Route 320.18	08.00-	dCi11G	 3400 700 409 ⊗ 3482 083 252 ⊗ 1878 026 241 ⊙ 3151 250 231	430 10 MFZ430 430WGTZ KZISZ-5	Getr. / GBox: ZF 9S-109		
	08.00-		 3482 083 252	430 MFZ430	Getr. / GBox: ZF 12AS2301		
	08.00-		 3151 000 144	KZISZ-5	Getr. / GBox: ZF 12AS2301 für Ausrückgabel mit Nocken / for release fork with cams	(70)	
			 3400 700 311 ⊗ 3488 017 439 ⊗ 1862 379 032 ⊙ 3151 262 031	400 10 MFZ2/400X 400WGTZ KZISZ-5	Getr. / GBox: ZF 12AS2301 für Fahrzeuge mit Zweischeibenkupplung / for vehicles with double disc clutch	(77)	
			 3400 700 625 ⊗ 3482 634 003 ⊗ 1878 634 034 ⊙ 3151 600 595	395 10 MF395 395WGTZ	Getr. / GBox: Eaton 9-Gang/shift		
	 3189 600 009						
Distribution 320.26D Distribution 370.26D	08.00- 08.00-	dCi11G, dCi11E	 3189 600 009				
Distribution 340.18D Distribution 340.18D/T Distribution 340.19D Distribution 340.19D/T Distribution 340.26D	04.96-	MIDR06.20.45E/ 41	 3400 123 401 ⊗ 3482 083 252 ⊗ 1878 020 241 ⊙ 3151 250 231	430 20 MFZ430 430WGTZ KZISZ-5	Getr. / GBox: B9		
	04.96-		 3400 700 408 ⊗ 3482 083 252 ⊗ 1878 020 241 ⊙ 3151 000 404	430 20 MFZ430 430WGTZ KZISZ-5	Getr. / GBox: B18,B9+35mm Getr. / GBox: B9 TBV		
	04.96-		 3400 117 532 ⊗ 3488 017 439 ⊗ 1862 379 031 ⊙ 3151 250 231	400 20 MFZ2/400X 400WGVZ KZISZ-5	Getr. / GBox: B18,B9+35mm für Fahrzeuge mit Zweischeibenkupplung / for vehicles with double disc clutch Je nach Kundenwunsch mit unterschiedlicher Kupplung / Equipped with different clutch according to customer requirement	(77) (35)	
	04.96-		 3400 700 409 ⊗ 3482 083 252 ⊗ 1878 026 241 ⊙ 3151 250 231	430 10 MFZ430 430WGTZ KZISZ-5	Getr. / GBox: ZF 9S-109 Getr. / GBox: ZF 16S-109		
	04.96-		 3400 700 410 ⊗ 3482 083 252 ⊗ 1878 022 841 ⊙ 3151 274 131	430 10 MFZ430 430GTZ KZISZ-5	09.1999-> Getr. / GBox: ZF 8S-151 Getr. / GBox: ZF 16S-151		
	04.96-		 3400 700 311 ⊗ 3488 017 439 ⊗ 1862 379 032 ⊙ 3151 262 031	400 10 MFZ2/400X 400WGTZ KZISZ-5	Getr. / GBox: ZF 8S-151 Getr. / GBox: ZF 16S-151 für Fahrzeuge mit Zweischeibenkupplung / for vehicles with double disc clutch	(77)	

RENAULT TRUCKS













































Premium		04.96 -					
Distribution 370.18 Route 370.18	08.00 -	dCi11E	 3482 083 252	430 MFZ430	Getr. / GBox: ZF 8S-151 Getr. / GBox: ZF 16S-151 Getr. / GBox: ZF 16S-181 Getr. / GBox: ZF 12AS 2301 Getr. / GBox: ZF 12AS "Full Auto"		
	08.00 -		 3151 274 131	KZISZ-5	Getr. / GBox: ZF 8S-151 Getr. / GBox: ZF 16S-151 Getr. / GBox: ZF 16S-181 Getr. / GBox: ZF 12AS 2301		
			 3151 000 144	KZISZ-5	Getr. / GBox: ZF 12AS "Full Auto" für Ausrückgabel mit Nocken / for release fork with cams	(70)	
			 3400 700 311  3488 017 439  1862 379 032  3151 262 031	400 10 MFZ2/400X 400WGTZ KZISZ-5	für Fahrzeuge mit Zweischeibenkupplung / for vehicles with double disc clutch	(77)	
			 3189 600 009				
Distribution 370.18D	08.00 -	dCi11E	 3400 700 311  3488 017 439  1862 379 032  3151 262 031	400 10 MFZ2/400X 400WGTZ KZISZ-5	für Fahrzeuge mit Zweischeibenkupplung / for vehicles with double disc clutch	(77)	
			 3400 700 332  3482 083 252  1878 004 832  3151 000 144	430 10 MFZ430 430WGTZ KZISZ-5	Getr. / GBox: ZF AS Tronic		
			 3400 700 334  3482 083 252  1878 004 832  3151 274 131	430 10 MFZ430 430WGTZ KZISZ-5	Getr. / GBox: ZF 8S-151 Getr. / GBox: ZF 16S-151 Getr. / GBox: ZF 16S-181		
			 3400 700 625  3482 634 003  1878 634 034  3151 600 595	395 10 MF395 395WGTZ	Getr. / GBox: Eaton 9-Gang/shift		
			 3189 600 009				
Distribution 370.24D Distribution 370.26D Route 370.18 Route 370.24 Route 370.26 Route 420.18 Route 420.24 Route 420.25 Route 420.26	08.00 -	dCi11E, dCi11C	 3482 083 252	430 MFZ430	Getr. / GBox: ZF 8S-151 Getr. / GBox: ZF 16S-151 Getr. / GBox: ZF 16S-181 Getr. / GBox: ZF 12AS 2301 Getr. / GBox: ZF 12AS "Full Auto"		
	08.00 -		 3151 274 131	KZISZ-5	Getr. / GBox: ZF 8S-151 Getr. / GBox: ZF 16S-151 Getr. / GBox: ZF 16S-181 Getr. / GBox: ZF 12AS 2301		
	08.00 -		 3151 000 144	KZISZ-5	Getr. / GBox: ZF 12AS "Full Auto" für Ausrückgabel mit Nocken / for release fork with cams	(70)	
	08.00 -		 3400 700 311  3488 017 439  1862 379 032  3151 262 031	400 10 MFZ2/400X 400WGTZ KZISZ-5	für Fahrzeuge mit Zweischeibenkupplung / for vehicles with double disc clutch	(77)	
	08.00 -		 3400 700 625  3482 634 003  1878 634 034  3151 600 595	395 10 MF395 395WGTZ	Getr. / GBox: Eaton 9-Gang/shift		
	08.00 -		 3189 600 009				
	08.00 -						
Distribution 400.18D Distribution 400.18D/T	01.00 -	MIDR06.23.56B/ 41	 3400 700 401   3483 034 035  1878 032 331	430 10 MFZ430 430WGTZ	Getr. / GBox: B9		
	01.00 -		 3400 700 408  3482 083 252  1878 020 241  3151 000 404	430 20 MFZ430 430WGTZ KZISZ-5	Getr. / GBox: B18 Getr. / GBox: B9 TBV		
			 3400 117 532  3488 017 439  1862 379 031  3151 250 231	400 20 MFZ2/400X 400WGVZ KZISZ-5	Getr. / GBox: B9, B18 für Fahrzeuge mit Zweischeibenkupplung / for vehicles with double disc clutch	(77)	
			 3400 700 334  3482 083 252  1878 004 832  3151 274 131	430 10 MFZ430 430WGTZ KZISZ-5	Getr. / GBox: ZF 8S-151 Getr. / GBox: ZF 16S-151 Getr. / GBox: ZF 16S-181		
			 3400 700 311  3488 017 439  1862 379 032  3151 262 031	400 10 MFZ2/400X 400WGTZ KZISZ-5	Getr. / GBox: ZF 8S-151 Getr. / GBox: ZF 16S-151 für Fahrzeuge mit Zweischeibenkupplung / for vehicles with double disc clutch	(77)	

		CODE				
--	--	------	--	---	---	---

















RENAULT TRUCKS

Premium		04.96 -					
Distribution 420.18	08.00-	dCi11C	 3400 700 334 ⊗ 3482 083 252 ⊗ 1878 004 832 ⊙ 3151 274 131	430 10 MFZ430 430WGTZ KZISZ-5	Getr. / GBox: ZF 8S-151 Getr. / GBox: ZF 16S-151 Getr. / GBox: ZF 16S-181 Getr. / GBox: ZF 12AS 2301		
			 3400 700 332 ⊗ 3482 083 252 ⊗ 1878 004 832 ⊙ 3151 000 144	430 10 MFZ430 430WGTZ KZISZ-5	Getr. / GBox: ZF 12AS "Full Auto"		
			 3400 700 311 ⊗ 3488 017 439 ⊗ 1862 379 032 ⊙ 3151 262 031	400 10 MFZ2/400X 400WGTZ KZISZ-5	für Fahrzeuge mit Zweischeibenkupplung / for vehicles with double disc clutch	(77)	
			 3189 600 009				
Distribution 420.18D Route 420.18T	08.00 - 08.00-	dCi11B/43, dCi11C	 3400 700 311 ⊗ 3488 017 439 ⊗ 1862 379 032 ⊙ 3151 262 031	400 10 MFZ2/400X 400WGTZ KZISZ-5	für Fahrzeuge mit Zweischeibenkupplung / for vehicles with double disc clutch	(77)	
			 3400 700 332 ⊗ 3482 083 252 ⊗ 1878 004 832 ⊙ 3151 000 144	430 10 MFZ430 430WGTZ KZISZ-5	Getr. / GBox: ZF AS Tronic		
			 3400 700 334 ⊗ 3482 083 252 ⊗ 1878 004 832 ⊙ 3151 274 131	430 10 MFZ430 430WGTZ KZISZ-5	Getr. / GBox: ZF 8S-151 Getr. / GBox: ZF 16S-151 Getr. / GBox: ZF 16S-181		
			 3189 600 009				
Route 340.18 Route 340.18T Route 340.19 Route 340.19T Route 340.24 Route 340.26	04.96 - 04.96 - 04.96 - 04.96 - 04.96 - 04.96 -	MIDR06.20.45E/ 41	 3400 123 401 ⊗ 3482 083 252 ⊗ 1878 020 241 ⊙ 3151 250 231	430 20 MFZ430 430WGTZ KZISZ-5	Getr. / GBox: B9		
			 3400 700 408 ⊗ 3482 083 252 ⊗ 1878 020 241 ⊙ 3151 000 404	430 20 MFZ430 430WGTZ KZISZ-5	Getr. / GBox: B9+35mm,B18 Getr. / GBox: B9 TBV		
			 3400 117 532 ⊗ 3488 017 439 ⊗ 1862 379 031 ⊙ 3151 250 231	400 20 MFZ2/400X 400WGVZ KZISZ-5	Getr. / GBox: B9+35mm,B18 für Fahrzeuge mit Zweischeibenkupplung / for vehicles with double disc clutch	(77)	
			 3400 700 410 ⊗ 3482 083 252 ⊗ 1878 022 841 ⊙ 3151 274 131	430 10 MFZ430 430GTZ KZISZ-5	Getr. / GBox: ZF 8S-151 Getr. / GBox: ZF 16S-151		
			 3400 700 311 ⊗ 3488 017 439 ⊗ 1862 379 032 ⊙ 3151 262 031	400 10 MFZ2/400X 400WGTZ KZISZ-5	Getr. / GBox: ZF 8S-151 Getr. / GBox: ZF 16S-151 für Fahrzeuge mit Zweischeibenkupplung / for vehicles with double disc clutch	(77)	
			 3400 123 401 ⊗ 3482 083 252 ⊗ 1878 020 241 ⊙ 3151 250 231	430 20 MFZ430 430WGTZ KZISZ-5	Getr. / GBox: B9		
			 3400 700 408 ⊗ 3482 083 252 ⊗ 1878 020 241 ⊙ 3151 000 404	430 20 MFZ430 430WGTZ KZISZ-5	Getr. / GBox: B9+35mm,B18		
Route 385.18,400.18 Route 385.18T,400.18T Route 385.19,400.19 Route 385.19T,400.19T Route 385.24,400.24 Route 385.24T,400.24T Route 385.26 Route 385.26,400.26	04.96 - 04.96 - 04.96 - 04.96 - 09.96 - 04.96 - 04.96 -	MIDR06.23.56B/ 41, MIDR06.23.56A/ 41	 3400 123 401 ⊗ 3482 083 252 ⊗ 1878 020 241 ⊙ 3151 250 231	430 20 MFZ430 430WGTZ KZISZ-5	Getr. / GBox: B9		
			 3400 700 408 ⊗ 3482 083 252 ⊗ 1878 020 241 ⊙ 3151 000 404	430 20 MFZ430 430WGTZ KZISZ-5	Getr. / GBox: B9+35mm,B18		
			 3400 117 532 ⊗ 3488 017 439 ⊗ 1862 379 031 ⊙ 3151 250 231	400 20 MFZ2/400X 400WGVZ KZISZ-5	Getr. / GBox: B9+35mm,B18 für Fahrzeuge mit Zweischeibenkupplung / for vehicles with double disc clutch	(77)	
			 3400 700 334 ⊗ 3482 083 252 ⊗ 1878 004 832 ⊙ 3151 274 131	430 10 MFZ430 430WGTZ KZISZ-5	Getr. / GBox: ZF 8S-151 Getr. / GBox: ZF 16S-151 Getr. / GBox: ZF 16S-181		
			 3400 700 311 ⊗ 3488 017 439 ⊗ 1862 379 032 ⊙ 3151 262 031	400 10 MFZ2/400X 400WGTZ KZISZ-5	Getr. / GBox: ZF 8S-151 Getr. / GBox: ZF 16S-151 für Fahrzeuge mit Zweischeibenkupplung / for vehicles with double disc clutch	(77)	
Premium 2		10.05 -					
370 410		DXI7	 3400 710 067 ⊗ 3482 001 307 ⊗ 1878 006 584 ⚡ 6482 000 155	430 24 MF430 430WGTZ PHIS-6/38	Getr. / GBox: AT2412D		
			 3400 710 060	430 24	Getr. / GBox: AT2412C/ATO2512C		

RENAULT TRUCKS

Premium 2		10.05 -					
450		DXi7	 3400 710 067  3482 001 307  1878 006 584  6482 000 155 3400 710 061 #  3482 000 553  1878 007 046  6482 000 155	430 24 MF430 430WGTZ PHIS-6/38 430 24 MF430 430WGTZ PHIS-6/38	Getr. / GBox: AT2412D		
					Getr. / GBox: AT2412C/ATO2512C Euro 5 / Euro 5	(17)	
Distribution 240.18 D Distribution 270.19 Distribution 280.18 D Distribution 280.26 Distribution 310.18 Distribution 310.26 Distribution 340.18 Distribution 340.26 Lander 270.18, Lander 270.19 Lander 280.18 Lander 310.19 Lander 310.26 Lander 320.18 Lander 340.18, Lander 340.19 Lander 340.26	05.06 - 10.06 - 10.05 - 10.05 - 10.06 - 10.06 - 10.06 - 10.06 - 10.06 - 10.06 - 06.08 -04.13 10.06 - 10.06 - 02.09 - 10.06 - 10.06 -	DXi7	 3400 700 466  3482 634 003  1878 634 034  3151 000 752  3400 710 067  3482 001 307  1878 006 584  6482 000 155	395 10 MF395 395WGTZ KZIS-4 430 24 MF430 430WGTZ PHIS-6/38	Getr. / GBox: ZF 9S1110TO Getr. / GBox: ZF 6S1000TO		
					Getr. / GBox: AT2412D		
Distribution 320.18	05.06 -	DXi7	 3400 700 622  3482 001 199  1878 026 241  3151 000 809  1874 000 068  3400 710 067  3482 001 307  1878 006 584  6482 000 155	430 10 MF430 430WGTZ KZIS-4 430 24 MF430 430WGTZ PHIS-6/38	Getr. / GBox: ZF 9S1110		
					Getr. / GBox: AT2412D		
Distribution 320.18 D Distribution 320.26	10.05 - 10.05 -	DXi7	 3400 700 466  3482 634 003  1878 634 034  3151 000 752  3400 700 622  3482 001 199  1878 026 241  3151 000 809  1874 000 068  3400 710 067  3482 001 307  1878 006 584  6482 000 155	395 10 MF395 395WGTZ KZIS-4 430 10 MF430 430WGTZ KZIS-4 430 24 MF430 430WGTZ PHIS-6/38	Getr. / GBox: ZF 9S1110TO Getr. / GBox: ZF 6S1000TO		
					Getr. / GBox: ZF 9S1110		
					Getr. / GBox: AT2412D		
Distribution 330.18 Distribution 420.18 Distribution 440.18	04.07 - 05.08 10.05 - 02.07 02.07 -	DXi11	 3400 700 399  3482 083 034  1878 004 832  3151 274 131  3488 017 439 MFZ2/400X  1862 380 031 ▽ 400 8 400GVZ  1862 379 032 400 10 400WGTZ  3151 262 031 KZISZ-5	430 10 MFZ430 430WGTZ KZISZ-5 400 MFZ2/400X 400 8 400GVZ 400 10 400WGTZ 430 24 MF430 430WGTZ PHIS-6/38	Getr. / GBox: ZF		
					für Fahrzeuge mit Zweis Scheibenkupplung / for vehicles with double disc clutch enthält eine Kupplungsscheibe / This part number includes one clutch disc mit Zwischenring / with intermediate ring	(77) (67) (94)	
					für Fahrzeuge mit Zweis Scheibenkupplung / for vehicles with double disc clutch In 3488 enthalten / Contained in 3488	(77) (33)	
					für Fahrzeuge mit Zweis Scheibenkupplung / for vehicles with double disc clutch	(77)	
					für Fahrzeuge mit Zweis Scheibenkupplung / for vehicles with double disc clutch	(77)	
					Getr. / GBox: AT2412C/ATO2512C Euro 5 / Euro 5	(17)	
					Getr. / GBox: AT2412C/ATO2512C Euro 6 / Euro 6	(18)	

RENAULT TRUCKS











Premium 2		10.05 -					
Distribution 340.19 Lander 310.26 Lander 340.26	10.06- 10.06- 10.06-	DXi7	 3400 710 067 ⊗ 3482 001 307 ⊗ 1878 006 584 📍 6482 000 155	430 24 MF430 430WGTZ PHIS-6/38	Getr. / GBox: AT2412D		
Distribution 370.18 D Distribution 370.26 Distribution 410.18 D Distribution 410.26 Route 330.18 T Route 410.18 Route 410.24 Route 410.25 Route 410.26	10.05- 10.05- 10.05- 10.05- 10.05- 10.05- 10.05- 10.05- 10.05-	DXi11	 3400 700 399 ⊗ 3482 083 034 ⊗ 1878 004 832 ⦿ 3151 274 131	430 10 MFZ430 430WGTZ KZISZ-5	Getr. / GBox: 16S-2220		
			 3400 700 311 ⊗ 3488 017 439 ⊗ 1862 379 032 ⦿ 3151 262 031	400 10 MFZ2/400X 400WGTZ KZISZ-5	für Fahrzeuge mit Zweischeibenkupplung / for vehicles with double disc clutch	(77)	
			 3400 710 060 ⊗ 3482 001 307 ⊗ 1878 003 867 📍 6482 000 155	430 24 MF430 430WGTZ PHIS-6/38	Getr. / GBox: AT2412		
Distribution 380.18 Distribution 380.19 Distribution 380.26 Lander 380.19 Lander 380.26 Lander 380.32 Route 380.18 Route 380.19 Route 380.26	10.06- 10.06- 10.06- 10.06- 10.06- 10.06- 10.06- 10.06- 10.06-	DXi11	 3400 700 399 ⊗ 3482 083 034 ⊗ 1878 004 832 ⦿ 3151 274 131	430 10 MFZ430 430WGTZ KZISZ-5	Getr. / GBox: 16S-2220		
			 3400 700 311 ⊗ 3488 017 439 ⊗ 1862 379 032 ⦿ 3151 262 031	400 10 MFZ2/400X 400WGTZ KZISZ-5	für Fahrzeuge mit Zweischeibenkupplung / for vehicles with double disc clutch	(77)	
			 3400 710 060 ⊗ 3482 001 307 ⊗ 1878 003 867 📍 6482 000 155	430 24 MF430 430WGTZ PHIS-6/38	Getr. / GBox: AT2412		
			 3400 700 495 ⊗ 3482 083 034 ⊗ 1878 004 832 ⦿ 3151 001 035	430 10 MFZ430 430WGTZ	Getr. / GBox: 16S1930		
Distribution 430.18 Distribution 430.19 Distribution 430.26 Distribution 460.19 Lander 430.32 Lander 460.18 Lander 460.26 Lander 460.32 Route 430.18 Route 430.19 Route 430.26 Route 460.18 Route 460.26	10.06- 10.06- 10.06- 10.06- 10.06- 10.06- 10.06- 10.06- 10.06- 10.06- 10.06- 10.06- 10.06-	DXi11	 3400 700 399 ⊗ 3482 083 034 ⊗ 1878 004 832 ⦿ 3151 274 131	430 10 MFZ430 430WGTZ KZISZ-5	Getr. / GBox: 16S-2220		
			 3400 700 311 ⊗ 3488 017 439 ⊗ 1862 379 032 ⦿ 3151 262 031	400 10 MFZ2/400X 400WGTZ KZISZ-5	für Fahrzeuge mit Zweischeibenkupplung / for vehicles with double disc clutch	(77)	
			 3400 710 061 # ⊗ 3482 000 553 ⊗ 1878 007 046 📍 6482 000 155	430 24 MF430 430WGTZ PHIS-6/38	Getr. / GBox: AT 2412 C/ATO Euro 5 / Euro 5	(17)	
			 3400 710 066 ● ⊗ 3482 001 308 ⊗ 1878 007 046 📍 6482 000 155	430 24 MF430 430WGTZ PHIS-6/38	Getr. / GBox: AT 2412 C/ATO Euro 6 / Euro 6	(18)	
			 3400 700 438 ⊗ 3482 634 004 ⊗ 1878 003 968 ⦿ 3151 001 035	430 10 MFZ430 430WGTZ	Getr. / GBox: 16S-2230		
Distribution 450.18 D Lander 440.18 Lander 440.19 Lander 440.26 Lander 440.32 Route 410.18 D Route 450.18 Route 450.18 D Route 450.24 Route 450.25 Route 450.26	10.05- 10.05- 10.05- 10.05- 10.05- 10.05- 10.05- 10.05- 10.05- 10.05- 10.05-	DXi11	 3400 700 399 ⊗ 3482 083 034 ⊗ 1878 004 832 ⦿ 3151 274 131	430 10 MFZ430 430WGTZ KZISZ-5	Getr. / GBox: 16S-2220		
			 3400 700 311 ⊗ 3488 017 439 ⊗ 1862 379 032 ⦿ 3151 262 031	400 10 MFZ2/400X 400WGTZ KZISZ-5	für Fahrzeuge mit Zweischeibenkupplung / for vehicles with double disc clutch	(77)	
			 3400 710 061 # ⊗ 3482 000 553 ⊗ 1878 007 046 📍 6482 000 155	430 24 MF430 430WGTZ PHIS-6/38	Getr. / GBox: AT 2412 C/ATO Euro 5 / Euro 5	(17)	











RENAULT TRUCKS

Premium 2		10.05 -					
Lander 430.18	10.06-	DXI11		3400 700 399 ⊗ 3482 083 034 ⊗ 1878 004 832 ⊙ 3151 274 131	430 10 MFZ430 430WGTZ KZISZ-5	Getr. / GBox: 16S-2220	
Lander 430.26	10.06-			3400 700 311 ⊗ 3488 017 439 ⊗ 1862 379 032 ⊙ 3151 262 031	400 10 MFZ2/400X 400WGTZ KZISZ-5	für Fahrzeuge mit Zweischeibenkupplung / for vehicles with double disc clutch	(77)
				3400 710 060 ⊗ 3482 001 307 ⊗ 1878 003 867 ⊙ 6482 000 155	430 24 MF430 430WGTZ PHIS-6/38	Getr. / GBox: AT2412	
				3400 700 438 ⊗ 3482 634 004 ⊗ 1878 003 968 ⊙ 3151 001 035	430 10 MFZ430 430WGTZ	Getr. / GBox: 16S-2230	
R		10.80 - 12.96					
R 310.16	10.80-03.89	MIDR063540		3400 116 601 ⊗ 3482 097 141 ⊗ 1878 020 241 ⊙ 3100 008 106	430 20 GMFZ430 430WGTZ KZISZ-5	Getr. / GBox: RVI	
R 310.16/T	10.80-03.89			3482 097 141	430 GMFZ430	->03.1986 Getr. / GBox: Fuller	
R 310.17	10.80-03.89			1878 022 841	430 10 430GTZ	->03.1986 Getr. / GBox: Fuller	
R 310.17/T	10.80-03.89						
R 310.19	10.80-03.89						
R 310.19/T	10.80-03.89						
R 310.22	10.80-03.89						
R 310.22/T	10.80-03.89						
R 330.17	05.88-05.91	MIDR063540		3400 116 601 ⊗ 3482 097 141 ⊗ 1878 020 241 ⊙ 3100 008 106	430 20 GMFZ430 430WGTZ KZISZ-5	Getr. / GBox: RVI	
R 330.17/T	05.88-05.91			3400 700 336 ⊗ 3482 097 141 ⊗ 1878 022 841 ⊙ 3100 008 106	430 10 GMFZ430 430GTZ KZISZ-5	Getr. / GBox: Fuller	
R 330.19	05.88-05.91						
R 330.19/T	05.88-05.91						
R 330.24	05.88-05.91						
R 340.17	03.86-01.90						
R 340.17/T	03.86-01.90						
R 340.19	03.86-01.90						
R 340.19/T	03.86-01.90						
R 340.24	03.86-01.90						
R 340.ti	01.93-	MIDR06.20.45E, MIDR06.35.40J/ 3, MIDR06.35.40L 1		3483 000 510 ⊕	445 GMFZ445W	für Fahrzeuge mit Wandlerschaltkupplung / for vehicles with converter and clutch unit	(76)
R 385.ti	01.93-			1878 051 801	445 24 445GTZC	für Fahrzeuge mit Wandlerschaltkupplung / for vehicles with converter and clutch unit	(76)
R 420.ti	01.93-						
R 340ti.16/T	01.90-05.91	MIDR062045E		3400 116 601 ⊗ 3482 097 141 ⊗ 1878 020 241 ⊙ 3100 008 106	430 20 GMFZ430 430WGTZ KZISZ-5	Getr. / GBox: B9/B18	
R 340ti.17	01.90-05.91			3400 123 201 ▲ ⊗ 3482 123 441 ⊗ 1878 022 841 ⊙ 3100 008 106	430 10 GMFZ430 430GTZ KZISZ-5	Getr. / GBox: Fuller	
R 340ti.18	01.90-05.91						
R 340ti.18/T	01.90-05.91						
R 340ti.19	01.90-05.91						
R 340ti.19/T	01.90-05.91						
R 340ti.24	01.90-05.91						
R 340ti.26	01.90-05.91						
R 350.17	01.90-05.91	MIDR063540G		3400 116 601 ⊗ 3482 097 141 ⊗ 1878 020 241 ⊙ 3100 008 106	430 20 GMFZ430 430WGTZ KZISZ-5	Getr. / GBox: B9/B18	
R 350.17/T	01.90-05.91			3400 123 201 ▲ ⊗ 3482 123 441 ⊗ 1878 022 841 ⊙ 3100 008 106	430 10 GMFZ430 430GTZ KZISZ-5	Getr. / GBox: Fuller	
R 350.18	01.90-05.91						
R 350.18/T	01.90-05.91						
R 350.19	01.90-05.91						
R 350.19/T	01.90-05.91						
R 350.19/TB	01.90-05.91						
R 350.24	01.90-05.91						
R 350.26	01.90-05.91						
R 365.17	10.87-05.90						
R 365.17/T	10.87-05.90						
R 365.19	10.87-05.90						
R 365.19/T	10.87-05.90						
R 365.24	10.87-05.90						









		CODE				
--	--	------	--	---	---	---



















RENAULT TRUCKS

R						
10.80 - 12.96						
R 370.16	10.83 - 07.85	MIVS083530		3400 116 601 ⊗ 3482 097 141 ⊗ 1878 020 241 ⊙ 3100 008 106	430 20 GMFZ430 430WGTZ KZISZ-5	Getr. / GBox: B9/B18
R 370.16/T	10.83 - 07.85					
R 370.19/T	10.83 - 07.85					
R 370.22/T	10.83 - 07.85			3400 123 201 ▲ ⊗ 3482 123 441 ⊗ 1878 022 841 ⊙ 3100 008 106	430 10 GMFZ430 430GTZ KZISZ-5	Getr. / GBox: Fuller
R 370.26/T	10.83 - 07.85					
R 380.17	01.90 - 05.91	MIDR063540H		3400 117 001 ⊗ 3482 123 441 ⊗ 1878 020 241 ⊙ 3100 008 106	430 20 GMFZ430 430WGTZ KZISZ-5	Getr. / GBox: B9/B18
R 380.18	01.90 - 05.91					
R 380.18/T	01.90 - 05.91					
R 380.19	01.90 - 05.91			3400 123 201 ▲ ⊗ 3482 123 441 ⊗ 1878 022 841 ⊙ 3100 008 106	430 10 GMFZ430 430GTZ KZISZ-5	Getr. / GBox: Fuller 14613
R 380.19/T	01.90 - 05.91					
R 380.19/TB	01.90 - 05.91					
R 380.22/T	01.90 - 05.91					
R 380.24	01.90 - 05.91					
R 380.25	01.90 - 05.91					
R 380.25/T	01.90 - 05.91					
R 380.26	01.90 - 05.91					
R 380.26/T	01.90 - 05.91					
R 390.16	07.85 - 03.89	MIVR083530		3400 116 601 ⊗ 3482 097 141 ⊗ 1878 020 241 ⊙ 3100 008 106	430 20 GMFZ430 430WGTZ KZISZ-5	Getr. / GBox: B9/B18
R 390.16/T	07.85 - 03.89					
R 390.17	07.85 - 03.89					
R 390.17/T	07.85 - 03.89			3400 123 201 ▲ ⊗ 3482 123 441 ⊗ 1878 022 841 ⊙ 3100 008 106	430 10 GMFZ430 430GTZ KZISZ-5	Getr. / GBox: Fuller
R 390.19/T	07.85 - 03.89					
R 390.22/T	07.85 - 03.89					
R 390.24	07.85 - 03.89					
R 390.24/T	07.85 - 03.89					
R 420.17	10.88 - 10.91	MIVR083530G		3400 116 601 ⊗ 3482 097 141 ⊗ 1878 020 241 ⊙ 3100 008 106	430 20 GMFZ430 430WGTZ KZISZ-5	Getr. / GBox: B9/B18
R 420.17/T	10.88 - 10.91					
R 420.19	10.88 - 10.91					
R 420.19/T	10.88 - 10.91			3400 700 336 ⊗ 3482 097 141 ⊗ 1878 022 841 ⊙ 3100 008 106	430 10 GMFZ430 430GTZ KZISZ-5	Getr. / GBox: ZF 16S-190
R 420.24	10.88 - 10.91					
R 420.24/T	10.88 - 10.91					
R 420.35/T	10.88 - 10.91	MIDR063540J		3400 117 001 ⊗ 3482 123 441 ⊗ 1878 020 241 ⊙ 3100 008 106	430 20 GMFZ430 430WGTZ KZISZ-5	Getr. / GBox: B9/B18
				3400 123 201 ▲ ⊗ 3482 123 441 ⊗ 1878 022 841 ⊙ 3100 008 106	430 10 GMFZ430 430GTZ KZISZ-5	Getr. / GBox: ZF 16S-190









































Saviem						
12. 215		MAN2156HM		1878 000 104 ●	380 10 380GTZ	
19. 215						
22. 215				3151 000 395	KZIS-4	
12. 230		MAN2356HM		1878 000 104 ●	380 10 380GTZ	
19. 230						
22. 230				3151 000 395	KZIS-4	
32. 230						
13. 168, HAB	01.78 - 12.81			3482 002 234	350 GMF350X	
15. 168, HAB 4x4	01.78 - 12.81					
19. 192 H 17, 18, 19 B	01.78 - 12.81			1878 001 144	350 10 350WGTZ	
19. 192 HA 17, 18, 19 B	01.78 - 12.81			1878 001 147 #	350 10 350WGTZ	
19. 268	01.78 - 12.81			3151 000 958	KZIS-4	
19. 240 H, HB, HAB, HA TB	01.74 - 12.81			1882 302 131	380 GF380	
26. 240 DHB 6x4	01.75 - 12.81					
32. 240 DHB, DHAB, DHRB	01.75 - 12.81			1878 001 152	380 10 380WGTZ	
				3151 000 395	KZIS-4	

RENAULT TRUCKS

SG							
2 3	01.69-01.79	712, 817		3499 373 055	250 MF250	Getr. / GBox: 321	
	01.74-01.79			1862 353 041 ▲	250 10 250CB	Getr. / GBox: 321	
SG 2 SG 3	02.79- 02.79-	712, 817		3499 373 055	250 MF250	Getr. / GBox: 321	
				1862 353 041 ▲	250 10 250CB	Getr. / GBox: 321	
				1897 375 775	KZA-5	Getr. / GBox: 321	
SG 5	01.74-12.79			3499 373 055	250 MF250	Getr. / GBox: ZFS5-24	
				1897 375 775	KZA-5	Getr. / GBox: ZFS5-24	
SG 5 D	01.69-12.79			3499 373 055	250 MF250	Getr. / GBox: 321 Diesel / Diesel	(13)
				1862 353 041 ▲	250 10 250CB	Getr. / GBox: 321 Diesel / Diesel	(13)





















SM							
10 , T 12 , T 15 .186	- 12.79			1882 110 532 #	350 GF350		
	01.74-12.79			1878 005 367	350 10 350WGTZ		
				3151 000 395	KZIS-4		
170	- 12.79			1882 110 532 #	350 GF350	Getr. / GBox: ZF	
				1878 005 367	350 10 350WGTZ	Getr. / GBox: ZF	
				3151 000 395	KZIS-4	Getr. / GBox: ZF	
19 .240 (Sachs Version) 26 .240 (Sachs Version) 32 .240 6x6 (Sachs Version)	01.75-12.79	MAN2356		1882 302 131 HD	380 GF380	Getr. / GBox: 343.02	
	01.75-12.79			3151 000 395	KZIS-4	Getr. / GBox: 343.02	
19 .240 (Valeo Version) 21 .240 (Valeo Version) 26 .240 (Valeo Version) 260 32 .230 6x4, 6x6 32 .240 6x6 (Valeo Version)	01.75-12.79	MAN2356		3482 037 141	380 GM380	Getr. / GBox: 343.02	
	01.74-12.79						
	01.75-12.79						
	11.77-12.79						
	01.75-12.79						
200	01.71-12.74	MAN2456		3482 037 141	380 GM380	Getr. / GBox: Saviem	
21 .180	01.76-12.78			1882 110 532 #	350 GF350		
				1878 005 367	350 10 350WGTZ		
21 .240 (Sachs Version)	01.74-12.79	MAN2356		1882 302 131 HD	380 GF380	Getr. / GBox: 343.032	
				3151 000 395	KZIS-4	Getr. / GBox: 343.032	
240	01.71-12.79	MAN2156		3482 037 141	380 GM380	Getr. / GBox: Saviem	
240 (Sachs Version)	11.77-12.79	MAN2156		1882 302 131 HD	380 GF380	Getr. / GBox: ZFAK6-80	
				3151 000 395	KZIS-4	Getr. / GBox: ZFAK6-80	
240 (Valeo Version)	11.77-12.79	MAN2156		3482 037 141	380 GM380	Getr. / GBox: ZFAK6-80	
240 HT	01.74-12.79			3151 000 395	KZIS-4		





RENAULT TRUCKS



SM						
280	11.77 - 12.79	MAN2156	 3482 124 541	430 GMF430	Getr. / GBox: Fuller RTO 9509	
			 1882 330 032 ●#	420 GF420	Getr. / GBox: Fuller RTO 9509	
			 1878 001 136	420 10 420GTZ	Getr. / GBox: Fuller RTO 9509	
			 3151 000 395	KZIS-4	Getr. / GBox: Fuller RTO 9509	
		MAN2858	 3482 124 541	430 GMF430	Getr. / GBox: Fuller RTO 9509 Getr. / GBox: ZF	
			 1882 330 032 ●#	420 GF420	Getr. / GBox: Fuller RTO 9509 Getr. / GBox: ZF	
			 1878 634 039 ▲	420 10 420WGTZ	Getr. / GBox: ZF	
			 1861 206 211 ●#	420 10 420GS	Getr. / GBox: ZF	
			 1878 001 136	420 10 420GTZ	Getr. / GBox: Fuller RTO 9509	
			 3151 000 395	KZIS-4	Getr. / GBox: Fuller RTO 9509 Getr. / GBox: ZF	
300	11.77 - 12.79		 3482 124 541	430 GMF430	Getr. / GBox: Fuller RTO 9509	
			 1882 330 032 ●#	420 GF420	Getr. / GBox: Fuller RTO 9509	
			 1878 001 136	420 10 420GTZ	Getr. / GBox: Fuller RTO 9509	
			 3151 000 395	KZIS-4	Getr. / GBox: Fuller RTO 9509	
		MAN2858	 3482 124 541	430 GMF430	Getr. / GBox: ZF	
			 1882 330 032 ●#	420 GF420	Getr. / GBox: ZF	
			 1878 634 039 ▲	420 10 420WGTZ	Getr. / GBox: ZF	
			 1861 206 211 ●#	420 10 420GS	Getr. / GBox: ZF	
			 3151 000 395	KZIS-4	Getr. / GBox: ZF	
			 3151 000 395	KZIS-4	Getr. / GBox: 343.02	
32 .230 6x4, 6x6	01.74 - 12.79	MAN2858	 3482 124 541	430 GMF430	Getr. / GBox: ZF	
			 1882 330 032 ●#	420 GF420	Getr. / GBox: ZF	
			 1878 634 039 ▲	420 10 420WGTZ	Getr. / GBox: ZF	
			 1861 206 211 ●#	420 10 420GS	Getr. / GBox: ZF	
			 3151 000 395	KZIS-4	Getr. / GBox: ZF	
32 .256 340 , T	01.76 - 12.77 01.74 - 12.79	MAN2858	 3482 124 541	430 GMF430	Getr. / GBox: Fuller	
			 1882 330 032 ●#	420 GF420	Getr. / GBox: Fuller	
			 1878 001 136	420 10 420GTZ	Getr. / GBox: Fuller	
			 3151 000 395	KZIS-4	Getr. / GBox: Fuller	
			 3482 124 541	430 GMF430	Getr. / GBox: Fuller RTO	
32 .256 (Sachs Version)	01.76 - 12.77	MAN2858	 1882 330 032 ●#	420 GF420	Getr. / GBox: Fuller RTO	
			 1878 001 136	420 10 420GTZ	Getr. / GBox: Fuller RTO	
			 3151 000 395	KZIS-4	Getr. / GBox: Fuller RTO	
			 3482 124 541	430 GMF430	Getr. / GBox: Fuller RTO	
340 , T			 1882 330 032 ●#	420 GF420	Getr. / GBox: Fuller RTO	
			 1878 001 136	420 10 420GTZ	Getr. / GBox: Fuller RTO	
			 3151 000 395	KZIS-4	Getr. / GBox: Fuller RTO	
			 3482 124 541	430 GMF430	Getr. / GBox: Fuller RTO	
SP						
5	03.75 -		 3499 373 055	250 MF250	Getr. / GBox: 321	
			 1862 353 041 ▲	250 10	Getr. / GBox: 321	

		CODE				
--	--	------	--	---	---	---

RENAULT TRUCKS

T-Serie		01.13 -										
380P LOW	01.13-	DTI11		3400 700 600 	430 24	Getr. / GBox: MT 2214B / MT 2514B	(18)					
380P, 380P LOW	01.13-				3483 000 348	MFZ430		Getr. / GBox: MTO 2214B/MTO 2514B				
380T LOW, 380T TAG	01.13-				1878 007 046	430WGTZ		Euro 6 / Euro 6				
380T PUS	01.13-				3400 710 064	430 24		Getr. / GBox: AT 2412/E /AT 2612/E	(18)			
380T, 380T LOW, 380T X-LOW	01.13-					3482 001 310		MF430		Getr. / GBox: ATO 2612/E		
430P LOW	01.13-					1878 007 170		430WGTZ		Euro 6 / Euro 6		
430P, 430P LOW	01.13-				6482 000 155	PHIS-6/38						
430T PUS	01.13-											
430T TAG, 430T LOW	01.13-											
430T, 430T LOW, 430T X-LOW	01.13-											
460P LOW	01.13-											
460P, 460P LOW	01.13-											
460T LOW, 460T TAG	01.13-											
460T PUS	01.13-											
460T, 460T LOW, 460T X-LOW	01.13-											
480P, 480P LOW	01.13-											
440P LOW	01.13-	DTI13		3400 700 600 	430 24	Getr. / GBox: MT 2214B / MT 2514B	(18)					
440P, 440P LOW	01.13-				3483 000 348	MFZ430		Getr. / GBox: MTO 2214B/MTO 2514B				
440T LOW, 440T TAG	01.13-				1878 007 046	430WGTZ		Euro 6 / Euro 6				
440T PUS	01.13-				3400 710 064	430 24		Getr. / GBox: AT 2412/E /AT 2612/E	(18)			
440T, 440T LOW, 440T X-LOW	01.13-					3482 001 310		MF430		Getr. / GBox: ATO 2612/E		
480P LOW	01.13-					1878 007 170		430WGTZ		Euro 6 / Euro 6		
480P, 480P LOW	01.13-				6482 000 155	PHIS-6/38						
480T LOW, 480T TAG	01.13-											
480T PUS	01.13-											
480T, 480T LOW, 480T X-LOW	01.13-											
520P LOW	01.13-			DTI13		3400 700 600 		430 24	Getr. / GBox: MTO 2514B	(18)		
520P, 520P LOW	01.13-							3483 000 348	MFZ430		Euro 6 / Euro 6	
520T LOW, 520T TAG	01.13-							1878 007 046	430WGTZ			
520T PUS	01.13-							3400 710 064	430 24		Getr. / GBox: AT2612/E / ATO2612/E	(18)
520T, 520T LOW, 520T X-LOW	01.13-								3482 001 310		MF430	
			1878 007 170	430WGTZ								
			6482 000 155	PHIS-6/38								













TB							
191 A,B,C,E,F,G	10.78 - 10.81	MIDS062030		3482 037 141	380	Getr. / GBox: 6 G.	
					GM380		
191 B,C,E,F,G	11.81 -	MIDS062030		3482 037 141	380	Getr. / GBox: 10 G.	
				3151 000 285	KZI-4	Getr. / GBox: 10 G.	
231 A,B,C,E,F,G	10.78 - 10.81	MIDS062030		1864 497 043	430 16		
					430Z		
231 B,C,E,F,G	11.81 -	MIDS062030		1864 497 043	430 16	Getr. / GBox: 10 G.	
					430Z		





TBH							
260 6x4	01.78 -			1864 497 042	430 20	Getr. / GBox: BM8.120	
280 6x4	01.76 - 12.79				430Z		
280		MIDR063540		1882 022 101 #	420	Nebenantriebs-ID / PTO ID: 110	(50)
				1878 634 014 ▲	420 10	Nebenantriebs-ID / PTO ID: 110	(50)
					420GSZ		





TP							
3 MB 35, 39 4x4	01.75 - 01.79			3499 373 055	250	Getr. / GBox: 321	
					MF250		
				1862 353 041 ▲	250 10	Getr. / GBox: 321	
					250CB		
3 MB 35, 39 4x4	02.79 - 12.83			3499 373 055	250	Getr. / GBox: 321	
					MF250		
				1862 353 041 ▲	250 10	Getr. / GBox: 321	
					250CB		
				1897 375 775	KZA-5	Getr. / GBox: 321	

		CODE				
--	--	------	--	---	---	---

RENAULT TRUCKS

TR						
280 , A	01.74 - 12.84		 1878 027 442	430 20 430GTZ	Getr. / GBox: B9.150	
			 1864 497 042	430 20 430Z	Getr. / GBox: BM8.120	
305 A, Turbo 4x2	10.77 - 12.80	MIVS083530	 1864 497 042	430 20 430Z	Getr. / GBox: BM8.120/3	
320 , A	01.74 - 12.78	MIV083530	 1864 497 042	430 20 430Z	Getr. / GBox: BM8.120	
M 2000 M 2000 Militär / military	11.92 -		 3499 373 055	250 MF250	Getr. / GBox: ZFS5-24	
			 1897 375 775	KZA-5	Getr. / GBox: ZFS5-24	
			 3499 373 055	250 MF250	Getr. / GBox: ZFS5-24	
			 1897 375 775	KZA-5	Getr. / GBox: ZFS5-24	
M 10000	11.92 -	MIDS062045B	 3482 083 044	430 MFZ430	Getr. / GBox: B18	
			 1878 027 442	430 20 430GTZ	Getr. / GBox: B18	
			 3100 008 204 ◊ 3151 234 231 ◎ 3180 000 009	KZISZ-5	Getr. / GBox: B18 Beinhaltet Ausrücker und Montagesatz / Contains releaser and fitting kit	(9)
M 10000	- 10.92	MIDS062045B	 3400 116 801 ◎ 3482 097 141 ◎ 1878 027 442 ◊ 3100 008 106	430 20 GMFZ430 430GTZ KZISZ-5	Getr. / GBox: B9	
M 10000 Militär / military		MIDR062045	 3400 116 801 ◎ 3482 097 141 ◎ 1878 027 442 ◊ 3100 008 106	430 20 GMFZ430 430GTZ KZISZ-5	Getr. / GBox: B9.150	

85 - 90						
85.150 TI 4x4 (10G.)	10.85 -	MIDS060212B	 3400 700 339 ◎ 3482 124 041 ◎ 1878 001 729 ◊ 3151 270 341	350 10 MF350 350GTD KZIS-3	Getr. / GBox: ZFS5-35+BT232S	
90 B (5G.)	01.78 - 12.80		 3499 373 055	250 MF250	Getr. / GBox: ZF	
			 1897 375 775	KZA-5	Getr. / GBox: ZF	
90 B 6	01.78 - 12.80		 3499 373 055	250 MF250	Getr. / GBox: 321	
			 1862 353 041 ▲	250 10 250CB	Getr. / GBox: 321	

100						
110.150 TI 4x4 (10G.)	10.85 -	MIDS060212B	 3400 700 339 ◎ 3482 124 041 ◎ 1878 001 729 ◊ 3151 270 341	350 10 MF350 350GTD KZIS-3	Getr. / GBox: ZF	
110.170 4x4 (6G.)	09.85 -		 3482 124 041	350 MF350	Getr. / GBox: ZF	
130 B (5G.)	01.78 - 12.80	797	 3400 117 301 # ◎ 3482 008 033 ◎ 1861 577 037 ◊ 3151 199 001	310 10 MF310 310GTD KZIS-3	Getr. / GBox: ZF Nur zusammen verbauen / Only install together	(53)
130 TB (6G.)	01.76 - 12.80	797	 3482 124 041	350 MF350	Getr. / GBox: ZF S6-65	
150 B (5G.)	01.76 - 12.80	798	 3400 700 339 ◎ 3482 124 041 ◎ 1878 001 729 ◊ 3151 270 341	350 10 MF350 350GTD KZIS-3	Getr. / GBox: ZF	



ROBUR

1800 - 3000						
1800			 3151 870 001	KZA-3		
2002						
2500						
3000						



		CODE				
--	--	------	--	---	---	---



SCANIA









65						
CF 65		K422-1		1878 001 138	420 10 420GTZ	Mot. D11



75						
B 75		K422-1		1878 001 138	420 10 420GTZ	Mot. D11
CF 75						
L 75		K422-1		1878 001 138	420 10 420GTZ	Mot. DS10
LS 75						





76						
L 76		K422-1		1878 001 138	420 10 420GTZ	Mot. D11,DS11
LS 76						

80						
L 80		K422-1		1878 001 138	420 10 420GTZ	Mot. D8,DS8
LB 80		K422-3		3482 124 514 ▲	430 GMF430	Mot. D8,DS8
				1878 001 138	420 10 420GTZ	Mot. D8,DS8

81						
L 81		K422-1		1878 001 138	420 10 420GTZ	Mot. D8,DS8 Getr. / GBox: G,GS760
LB 81		K422-3		3482 124 514 ▲	430 GMF430	Mot. D8,DS8 Getr. / GBox: G,GS760/770
				1878 003 238	420 22 420GTZ	Mot. D8,DS8 Getr. / GBox: G,GS770





































85						
L 85		K422-1		1878 001 138	420 10 420GTZ	Mot. D8,DS8
LB 85		K422-3		3482 124 514 ▲	430 GMF430	Mot. D8,DS8
				1878 001 138	420 10 420GTZ	Mot. D8,DS8
LBS 85		K422-3		3482 124 514 ▲	430 GMF430	Mot. D8,DS8
				1878 001 138	420 10 420GTZ	Mot. D8,DS8
LS 85		K422-3		3482 124 514 ▲	430 GMF430	Mot. D8,DS8
				1878 001 138	420 10 420GTZ	Mot. D8,DS8
		K422-1		1878 001 138	420 10 420GTZ	Mot. D8,DS8

86						
L 86		K422-1		1878 001 138	420 10 420GTZ	Mot. D8,DS8 Getr. / GBox: G,GS760
LB 86		K422-3		3482 124 514 ▲	430 GMF430	Mot. D8,DS8 Getr. / GBox: G,GS760/770
				1878 003 238	420 22 420GTZ	Mot. D8,DS8 Getr. / GBox: G,GS770



























110						
L 110		K422-1		1878 001 138	420 10 420GTZ	->12.1975 Mot. D,DS11
LB 110		K422-4		3482 119 034	430 GMF430	01.1976-> Mot. DS11
LBS 110				3482 001 234 ●#	420 GMF420	01.1976-> Mot. DS11
LBT 110				1878 003 339	420 10 420GTZ	01.1976-> Mot. DS11
LS 110						
LT 110						

		CODE					
--	--	------	--	--	---	---	---

SCANIA

























111							
BF 111		K422-4	 3482 119 034	430 GMF430	Mot. DS11 Getr. / GBox: G763		
			 3482 001 234 ●#	420 GMF420	Mot. DS11 Getr. / GBox: G763		
			 1878 003 339	420 10 420GTZ	Mot. DS11 Getr. / GBox: G763		
L 111		K422-3	 3482 124 514 ▲	430 GMF430	Mot. D11 Getr. / GBox: G770,GR870		
			 1878 003 238	420 22 420GTZ	Mot. D11 Getr. / GBox: G770,GR870		
		K422-1	 1878 001 138	420 10 420GTZ	Mot. D11 Getr. / GBox: G760,GR860		
		K422-4, K422-9	 3482 001 234 ●#	420 GMF420	Mot. DS11 Getr. / GBox: G760,770/GR860,870		
			 3400 125 901 ☹  3482 119 034  1878 003 238	430 22 GMF430 420GTZ	Mot. DS11 Getr. / GBox: G760,770/GR860,870		
K422-4	 1878 003 339	420 10 420GTZ	Mot. DS11 Getr. / GBox: G760,GR860				
LB 111		K422-9	 3400 125 901 ☹  3482 119 034  1878 003 238	430 22 GMF430 420GTZ	Mot. D11 Getr. / GBox: G770,GR870		
			 3482 124 514 ▲	430 GMF430	Mot. D11 Getr. / GBox: G770,GR870		
			 3482 001 234 ●#	420 GMF420	Mot. DS11 Getr. / GBox: G770,GR870		
			 1878 003 238	420 22 420GTZ	Mot. DS11 Getr. / GBox: G770,GR870		
		K422-4	 3482 119 034	430 GMF430	Mot. DS11 Getr. / GBox: G760,GR860		
			 3482 001 234 ●#	420 GMF420	Mot. DS11 Getr. / GBox: G760,GR860		
			 1878 003 339	420 10 420GTZ	Mot. DS11 Getr. / GBox: G760,GR860		
K422-1	 1878 001 138	420 10 420GTZ	Mot. D11 Getr. / GBox: G760,GR860				
LBS 111		K422-4	 3482 119 034	430 GMF430	Mot. DS11 Getr. / GBox: G760,GR860		
			 3482 001 234 ●#	420 GMF420	Mot. DS11 Getr. / GBox: G760,GR860		
			 1878 003 339	420 10 420GTZ	Mot. DS11 Getr. / GBox: G760,GR860		
LS 111		K422-4	 3482 119 034	430 GMF430	Mot. DS11 Getr. / GBox: G760,GR860		
			 3482 001 234 ●#	420 GMF420	Mot. DS11 Getr. / GBox: G760,GR860		
			 1878 003 339	420 10 420GTZ	Mot. DS11 Getr. / GBox: G760,GR860		
Serie 2							
05.80 - 05.88							
82	10.82 - 03.88	K422-9	 3400 125 901 ☹  3482 119 034  1878 003 238	430 22 GMF430 420GTZ	Mot. DN8,DS8,11,DSC11,DS		
			 3482 001 234 ●#	420 GMF420	Mot. DN8,DS8,11,DSC11,DS		
92	01.85 - 12.88	K422-9	 3400 125 901 ☹  3482 119 034  1878 003 238	430 22 GMF430 420GTZ	Mot. DN8,DS8,11,DSC11,		
			 3482 001 234 ●#	420 GMF420	Mot. DN8,DS8,11,DSC11,		
		K422-8	 3483 019 031 #⊕	430 GMFZ430N	Mot. DN11,DS11 Getr. / GBox: GRE870 für Nebenantrieb / for PTO		(82)
			 1878 003 365	420 22 420GTZ	Mot. DN11,DS11 Getr. / GBox: GRE870		

SCANIA

Serie 2		05.80 - 05.88				
112		K422-8	 3483 019 031 #⊕	430 GMFZ430N	Mot. DN11,DS11 Getr. / GBox: GRE870	
			 1878 003 365	420 22 420GTZ	Mot. DN11,DS11 Getr. / GBox: GRE870	
		K422-9	 3400 125 901 ⊖  3482 119 034  1878 003 238	430 22 GMF430 420GTZ	Mot. DN8,DS8,11,DSC11,	
			 3482 001 234 ●#	420 GMF420	Mot. DN8,DS8,11,DSC11,	
142	05.80 - 03.88	K384-4	 3400 116 401 #⊖  3482 033 401  3459 004 108  1878 006 118 x	380 22 GTF380 GTF2/380 380GTZ	->Chass. 4263275 Mot. DS,DSC14 Getr. / GBox: GR871	
			 3488 009 634	380 GTF2/380	->Chass. 4263275 Mot. DS,DSC14 Getr. / GBox: GR871 enthält eine Kupplungsscheibe / This part number includes one clutch disc	(67)
			 1878 006 118	380 22 380GTZ	->Chass. 4263275 Mot. DS,DSC14 Getr. / GBox: GR871 Lose Kupplungsscheibe / Loose clutch disc	(41)
		K384-8	 3400 116 401 #⊖  3482 033 401  3459 004 108  1878 006 118 x	380 22 GTF380 GTF2/380 380GTZ	->Chass. 4263275 Mot. DS,DSC14	
			 3488 009 634	380 GTF2/380	->Chass. 4263275 Mot. DS,DSC14 enthält eine Kupplungsscheibe / This part number includes one clutch disc	(67)
			 1878 006 118	380 22 380GTZ	->Chass. 4263275 Mot. DS,DSC14 Lose Kupplungsscheibe / Loose clutch disc	(41)
		K432-6	 3400 123 901 ⊕  3483 020 033  1878 062 944	430 22 MFZ430 430GTZ	Chass. 4263276-> Mot. DS,DSC14 Getr. / GBox: GR871/880	
			 3482 083 039	430 MFZ430	Chass. 4263276-> Mot. DS,DSC14 Getr. / GBox: GR871/880 In 3483/3488 enthalten / Contained in 3483, 3488	(32)
		K436-6	 3400 123 901 ⊕  3483 020 033  1878 062 944	430 22 MFZ430 430GTZ	Chass. 4263276-> Mot. DS,DSC14	
			 3482 083 039	430 MFZ430	Chass. 4263276-> Mot. DS,DSC14 In 3483/3488 enthalten / Contained in 3483, 3488	(32)













































		CODE					
--	--	------	--	--	---	---	---

SCANIA

Serie 3		01.88 - 12.96					
93	01.88 - 12.96	K402-1		3400 123 501 ⊕ ⊗ 3483 028 031 ⊗ 1862 450 031	400 22 MFZ400X 400GVZ		
	01.88 - 12.96			3482 112 031	400 MFZ400X	In 3483/3488 enthalten / Contained in 3483, 3488	(32)
113	01.88 - 12.96	K402-3		3400 123 601 ⊕ ⊗ 3483 028 031 ⊗ 1878 043 231	400 24 MFZ400X 400WGVZ		
				3482 112 031	400 MFZ400X	In 3483/3488 enthalten / Contained in 3483, 3488	(32)
143	01.88 - 12.96	K402-4		3483 024 031 ⊕	430 GMFZ430N	Nebenantriebs-ID / PTO ID: EK330/340/630/640	(50)
				1878 043 231	400 24 400WGVZ	Nebenantriebs-ID / PTO ID: EK330/340/630/640	(50)
		K422-8		3483 019 031 #⊕	430 GMFZ430N	Nebenantriebs-ID / PTO ID: EK422	(50)
				1878 003 365	420 22 420GTZ	Nebenantriebs-ID / PTO ID: EK421/422	(50)
		K422-9		3400 125 901 ⊖ ⊗ 3482 119 034 ⊗ 1878 003 238	430 22 GMF430 420GTZ		
				3482 001 234 ●#	420 GMF420		
		K422-12		3482 119 034	430 GMF430		
				3482 001 234 ●#	420 GMF420		
				1878 003 658	420 24 420WGTZ		
		K422-13		3483 024 031 ⊕	430 GMFZ430N	Chass. 1196681 - Chass. 1217685 Nebenantriebs-ID / PTO ID: EK330	(50)
				1878 003 658	420 24 420WGTZ	Chass. 1196681 - Chass. 1217685 Nebenantriebs-ID / PTO ID: EK330	(50)
		K432-3		3482 119 034	430 GMF430	Nur zusammen verbauen / Only install together	(53)
				3482 001 234 ●#	420 GMF420	Nur zusammen verbauen / Only install together	(53)
				1878 005 487	420 22 420WGTZ	Nur zusammen verbauen / Only install together	(53)
		K432-5		3400 123 801 ⊕ ⊗ 3483 020 036 ⊗ 1878 062 944	430 22 MFZ430 430GTZ		
				3482 083 039	430 MFZ430	In 3483/3488 enthalten / Contained in 3483, 3488	(32)
		K432-6		3400 123 901 ⊕ ⊗ 3483 020 033 ⊗ 1878 062 944	430 22 MFZ430 430GTZ		
				3482 083 039	430 MFZ430	In 3483/3488 enthalten / Contained in 3483, 3488	(32)
		K432-10, K432-14, K432-7, K432-8		3400 123 701 ⊕ ⊗ 3483 020 036 ⊗ 1878 003 066	430 24 MFZ430 430WGTZ		
				3483 024 031 ⊕	430 GMFZ430N	Nebenantriebs-ID / PTO ID: EK300/310/330 Nebenantriebs-ID / PTO ID: EK340/630/640	(50) (50)
		K432-13		1878 063 231 #	430 24 430WGTZ	Nebenantriebs-ID / PTO ID: EK300/310/330 Nebenantriebs-ID / PTO ID: EK340/630/640	(50) (50)

		CODE					
--	--	------	--	--	---	---	---

SCANIA

Serie 4		05.95 -					
94	09.95 - 09.04	K402-4	 3483 024 031 ⊕	430 GMFZ430N	Nebenantriebs-ID / PTO ID: EK300/310/330 Nebenantriebs-ID / PTO ID: EK340/630/640	(50)	(50)
114	09.95 - 09.04		 1878 043 231	400 24 400WGVZ	Nebenantriebs-ID / PTO ID: EK300/310/330 Nebenantriebs-ID / PTO ID: EK340/630/640	(50)	(50)
124	09.95 - 09.04		 3400 700 323 ⊖	400 24 MFZ400X 400WGVZ			
144	09.95 - 09.04	K402-5	 3482 112 031				
164	09.95 - 09.04		 1878 043 231				
			 3180 007 000				
			 3182 009 938	HHISZ-4	Immer erneuern / Renew everytime	(30)	
			 3180 007 000		Immer erneuern / Renew everytime Montagesatz für Ausrücklager / Fitting kit for releaser	(30)	(47)
		K432-13	 3483 024 031 ⊕	430 GMFZ430N	Nebenantriebs-ID / PTO ID: EK300/310/330 Nebenantriebs-ID / PTO ID: EK340/630/640	(50)	(50)
			 1878 063 231 #	430 24 430WGTZ	Nebenantriebs-ID / PTO ID: EK300/310/330 Nebenantriebs-ID / PTO ID: EK340/630/640	(50)	(50)
		K432-15	 3482 083 039	430 MFZ430			
			 1878 063 231 #	430 24 430WGTZ			
			 3182 009 938	HHISZ-4	Immer erneuern / Renew everytime	(30)	
			 3180 007 000		Immer erneuern / Renew everytime Montagesatz für Ausrücklager / Fitting kit for releaser	(30)	(47)
		K432-16	 3400 122 001 ⊖	430 24 MFZ430 430WGTZ			
			 3482 083 150				
			 1878 063 231				
			 3400 710 004	430 24 MFZ430			
			 3482 083 150	430WGTZ			
			 1878 003 066	HHISZ-4			
			 3182 009 938	HHISZ-4	Immer erneuern / Renew everytime	(30)	
			 3180 007 000		Immer erneuern / Renew everytime Montagesatz für Ausrücklager / Fitting kit for releaser	(30)	(47)
		K432-17	 3482 083 039	430 MFZ430			
			 1878 063 231 #	430 24 430WGTZ			
			 3182 009 938	HHISZ-4	Immer erneuern / Renew everytime	(30)	
			 3180 007 000		Immer erneuern / Renew everytime Montagesatz für Ausrücklager / Fitting kit for releaser	(30)	(47)
		K432-19	 3400 700 324 ⊖	430 24 MFZ430 430WGTZ			
			 3482 124 731				
			 1878 003 065				
			 3182 009 938	HHISZ-4	Immer erneuern / Renew everytime	(30)	
			 3180 007 000		Immer erneuern / Renew everytime Montagesatz für Ausrücklager / Fitting kit for releaser	(30)	(47)
		K432-30	 3482 000 251	430 MFZ430			
			 1878 063 231 #	430 24 430WGTZ			
			 3151 000 151	KZISZ-5			
		K432-31	 3482 000 251	430 MFZ430			
			 1878 063 231 #	430 24 430WGTZ			
			 3151 000 151	KZISZ-5			
		K432-32	 3482 000 251	430 MFZ430			
			 1878 063 231 #	430 24 430WGTZ			
			 3151 000 151	KZISZ-5			
		K432-33	 3400 700 352	430 24 MFZ430			
			 3482 000 257	430WGTZ			
			 1878 003 065	KZISZ-5			
			 3151 000 151				
		K442-3	 3182 009 938	HHISZ-4	Immer erneuern / Renew everytime	(30)	



















SCANIA

Serie P, G, R, T 01.03 -





P, G, R, T - Serie						
	K432-20		3400 700 611 ⊗ 3482 000 999 ⊗ 1878 007 253 ⊙ 3151 000 151	430 24 MFZ430 430WGTZ KZISZ-5		
	K432-25		3483 000 259 ⊕	430 GMFZ430N	Nebenantriebs-ID / PTO ID: EK630,640	(50)
			1878 007 253	430 24 430WGTZ	Nebenantriebs-ID / PTO ID: EK630,640	(50)
			3100 005 202 ⊙ 3151 205 202 ⊙ 3180 001 008	KZIZ-5 KZIZ-5	Nebenantriebs-ID / PTO ID: EK630,640	(50)
	K432-26		3400 700 374 ⊗ 3482 000 999 ⊗ 1878 007 123 ⊙ 3151 000 151	430 24 MFZ430 KZISZ-5		
	K432-27, K432-44		3400 700 370 ⊗ 3482 000 999 ⊗ 1878 007 120 ⊙ 3151 000 151	430 24 MFZ430 KZISZ-5		
	K432-33, K432-35, K432-39		3400 700 352 ⊗ 3482 000 257 ⊗ 1878 003 065 ⊙ 3151 000 151	430 24 MFZ430 430WGTZ KZISZ-5		
	K432-36, K432-37		3400 700 372 ⊗ 3482 000 257 ⊗ 1878 007 253 ⊙ 3151 000 151	430 24 MFZ430 430WGTZ KZISZ-5		
	K432-38		3400 700 373 ⊗ 3482 000 257 ⊗ 1878 007 120 ⊙ 3151 000 151	430 24 MFZ430 KZISZ-5		
	K432-40		3482 000 589	430 GMFZ430N	Nebenantriebs-ID / PTO ID: EK730, 740	(50)
			3151 000 273	KZIZ-5	Nebenantriebs-ID / PTO ID: EK730, 740	(50)
	K432-41		3482 000 589	430 GMFZ430N	Nebenantriebs-ID / PTO ID: EK730, 740	(50)
			1878 007 253	430 24 430WGTZ	Nebenantriebs-ID / PTO ID: EK730, 740	(50)
			3151 000 273	KZIZ-5	Nebenantriebs-ID / PTO ID: EK730, 740	(50)
	K432-42		3482 000 589	430 GMFZ430N	Nebenantriebs-ID / PTO ID: EK730, 740	(50)
			1878 003 895	430 24 430WGTZ	Nebenantriebs-ID / PTO ID: EK730, 740	(50)
			3151 000 273	KZIZ-5	Nebenantriebs-ID / PTO ID: EK730, 740	(50)
	K432-45		3482 000 589	430 GMFZ430N	Nebenantriebs-ID / PTO ID: EK730, 740	(50)
			1878 007 120	430 24	Nebenantriebs-ID / PTO ID: EK730, 740	(50)
	K432-46		3483 000 259 ⊕	430 GMFZ430N	Nebenantriebs-ID / PTO ID: EK630, 640	(50)
			3100 005 202 ⊙ 3151 205 202 ⊙ 3180 001 008	KZIZ-5 KZIZ-5	Nebenantriebs-ID / PTO ID: EK630, 640	(50)
	K432-48		3400 700 491 ⊗ 3482 000 999 ⊗ 1878 006 370 ⊙ 3151 000 151	430 24 MFZ430 430WGTZ KZISZ-5		
	K432-49		3482 000 589	430 GMFZ430N	Nebenantriebs-ID / PTO ID: EK730, 740	(50)
			1878 007 254	430 24 430WGTZ	Nebenantriebs-ID / PTO ID: EK730, 740	(50)
			3151 000 273	KZIZ-5	Nebenantriebs-ID / PTO ID: EK730, 740	(50)
	K432-54		3482 000 257	430 MFZ430		

		CODE				
--	--	------	--	---	---	---







SCANIA



Serie P, G, R, T		01.03 -			
P, G, R, T - Serie	K432-55	 3482 000 257	430 MFZ430		
		 3151 000 151	KZISZ-5		
	K432-56	 3400 700 619	430 24 MFZ430 430WGTZ KZISZ-5		
		 3482 000 999			
		 1878 007 124			
	K432-62	 3400 700 611	430 24 MFZ430 430WGTZ KZISZ-5		
		 3482 000 589	430 GMFZ430N	für Nebenantrieb / for PTO	(82)
		 1878 007 253	430 24 430WGTZ	für Nebenantrieb / for PTO	(82)
		 3151 000 273	KZISZ-5	für Nebenantrieb / for PTO	(82)
		 3400 700 624	395 10 395/WGTZ KZISZ-5		
		 3482 001 346			
		 1878 007 278			
	 3151 001 101				
	 1863 869 045	62	nur als Ersatz für angegebene OE-Nr. / only for the listed OE-Numbers	(100)	
	 6283 600 557		Länge Kolbenstange [mm] / Piston Rod Length [mm]: 129,5 nur als Ersatz für angegebene OE-Nr. / only for the listed OE-Numbers	(44) (100)	
	 3189 600 056		nur als Ersatz für angegebene OE-Nr. / only for the listed OE-Numbers	(100)	

SINOTRUK (CNHTC)

STEYR KING		05.07 -			
ZZ4256V324HD1/U6HBM	MC11.44-40	 3400 122 201	430 10 MFZ430 430WGTZ KZISZ-5	Getr. / GBox: ZF 16S2210D Euro 4 (D4) / Euro 4 (D4)	(16)
ZZ5517V5777D1	MC11.44-40	 3482 114 031	430 GMFZ430N	Getr. / GBox: 16S2222TO Euro 4 (D4) / Euro 4 (D4)	(16)
		 1878 004 832	430 10 430WGTZ	Getr. / GBox: 16S2222TO Euro 4 (D4) / Euro 4 (D4)	(16)
		 3151 263 031	KZIZ-6	Getr. / GBox: 16S2222TO Euro 4 (D4) / Euro 4 (D4)	(16)



SISU



E				
E 12	 3488 017 439	400 MFZ2/400X	enthält eine Kupplungsscheibe / This part number includes one clutch disc mit Zwischenring / with intermediate ring	(67) (94)
	 1862 380 031 ▽	400 8 400GVZ	In 3488 enthalten / Contained in 3488	(33)
	 1862 379 031	400 20 400WGVZ		
E 12M	 3400 700 485 #	430 10 GMFZ430N 430WGTZ KZIZ-6		
	 3482 123 631			
	 1878 004 832			
	 3151 263 031			

SK					
SK 171 SK 181	10.85-	 3482 021 031	380 GM380		
		 1861 902 032 #	380 10 380GTD		
		 3151 027 102	KZI4,5		

		CODE				
--	--	------	--	---	---	---

SISU

SL						
SL 171 SL 181	10.85-			3482 021 031	380 GM380	
				1861 902 032 #	380 10 380GTD	
				3151 027 102	KZI4,5	

























SM						
SM Serie	08.95-	CumminsN11, 14		3482 000 209	430 MFZ430	
				1878 054 933	430 10 430GTZ	
				3151 000 034	KZISZ-5	

POLAR 01.11 -						
625 ROCK	01.11-			3400 700 535 	400 MFZ/400E PHIS-6/38	XTend Nur zusammen verbauen / Only install together (53)
				6482 000 218		Immer erneuern / Renew everytime (30)













SNVI

TB						
TB 400		ISM420E-30, ISM11E400		3189 600 028		Getr. / GBox: 16S 221









STEYR















6...						
6 S 10		D0824FL, LFL		3400 700 322   3482 093 032  1862 438 032	330 10 MFZ330 330WTB	->03.1996 Je nach Kundenwunsch mit unterschiedlicher Kupplung / Equipped with different clutch according to customer requirement (35)
				3400 710 001  3482 120 031  1878 044 631  3182 005 231	362 10 MFZ362 362GTZ HHISZ-3	
				3400 121 801   3482 120 031  1878 044 631	362 10 MFZ362 362GTZ	
6 S 16		D0824LFL		3400 700 322   3482 093 032  1862 438 032	330 10 MFZ330 330WTB	->03.1996 Je nach Kundenwunsch mit unterschiedlicher Kupplung / Equipped with different clutch according to customer requirement (35)
				3400 710 001  3482 120 031  1878 044 631  3182 005 231	362 10 MFZ362 362GTZ HHISZ-3	
				3400 121 801   3482 120 031  1878 044 631	362 10 MFZ362 362GTZ	



7...						
7 G 1 F-K 7 GA 1 F-K				1882 325 134	380 G380	
				3151 000 395	KZIS-4	

8...						
8 S 10		D0824FL, LFL		3400 700 322   3482 093 032  1862 438 032	330 10 MFZ330 330WTB	->03.1996 Je nach Kundenwunsch mit unterschiedlicher Kupplung / Equipped with different clutch according to customer requirement (35)
				3400 710 001  3482 120 031  1878 044 631  3182 005 231	362 10 MFZ362 362GTZ HHISZ-3	
				3400 121 801   3482 120 031  1878 044 631	362 10 MFZ362 362GTZ	

STEYR





























































8...						
8 S 15 8 S 16	D0824LFL	 3400 700 322 ☾ ⊗ 3482 093 032 ⊗ 1862 438 032	330 10 MFZ330 330WTB	->03.1996 Je nach Kundenwunsch mit unterschiedlicher Kupplung / Equipped with different clutch according to customer requirement	(35)	
		 3400 710 001 ⊗ 3482 120 031 ⊗ 1878 044 631 ⚡ 3182 005 231	362 10 MFZ362 362GTZ HHISZ-3			
		 3400 121 801 ☾ ⊗ 3482 120 031 ⊗ 1878 044 631	362 10 MFZ362 362GTZ			
8 S 18	WD612.63	 3151 156 003	KZIZ-4,5			
8 S 22	D0826LFL	 3400 125 501 ⊗ 3482 060 132 ⊗ 1878 001 077 ⚡ 3151 199 001	350 10 MF350 350GTZ KZIS-3	->02.1994		
		 3482 060 132	350 MF350	03.1994->		
		 1878 001 145	350 10 350WGTZ	03.1994->		
		 3151 199 001	KZIS-3	03.1994->		

9...						
9 G 4 F-K 9 GNFNA-L		 1882 325 134	380 G380			
		 3151 000 395	KZIS-4			
9 S 14	WD612.24	 3482 063 101 #	310 MFZ310			
		 1862 125 202 #	310 10 310GTD			
		 3151 156 003	KZIZ-4,5			
9 S 15 9 S 16	D0824LFL	 3400 700 322 ☾ ⊗ 3482 093 032 ⊗ 1862 438 032	330 10 MFZ330 330WTB	->03.1996 Je nach Kundenwunsch mit unterschiedlicher Kupplung / Equipped with different clutch according to customer requirement	(35)	
		 3400 710 001 ⊗ 3482 120 031 ⊗ 1878 044 631 ⚡ 3182 005 231	362 10 MFZ362 362GTZ HHISZ-3			
		 3400 121 801 ☾ ⊗ 3482 120 031 ⊗ 1878 044 631	362 10 MFZ362 362GTZ			
9 S 18	WD612.71, 73 WD612.63	 1878 001 144	350 10 350WGTZ			
		 3151 156 003	KZIZ-4,5			
9 S 22	D0826LFL	 3400 125 501 ⊗ 3482 060 132 ⊗ 1878 001 077 ⚡ 3151 199 001	350 10 MF350 350GTZ KZIS-3	->02.1994		
		 3482 060 132	350 MF350	03.1994->		
		 1878 001 145	350 10 350WGTZ	03.1994->		
		 3151 199 001	KZIS-3	03.1994->		







10...						
10 S 14	WD612.24	 3482 063 101 #	310 MFZ310			
		 1862 125 202 #	310 10 310GTD			
		 3151 156 003	KZIZ-4,5			























		CODE				
--	--	------	--	---	---	---

























STEYR

10...						
10 S 15 10 S 16		D0824LFL	 3400 700 322 ☉  3482 093 032  1862 438 032	330 10 MFZ330 330WTB	->03.1996 Je nach Kundenwunsch mit unterschiedlicher Kupplung / Equipped with different clutch according to customer requirement	(35)
			 3400 710 001  3482 120 031  1878 044 631  3182 005 231	362 10 MFZ362 362GTZ HHISZ-3		
			 3400 121 801 ☉  3482 120 031  1878 044 631	362 10 MFZ362 362GTZ		
10 S 18		WD612.71, 73	 1878 001 144	350 10 350WGTZ		
10 S 22		D0826LFL	 3400 125 501  3482 060 132  1878 001 077  3151 199 001	350 10 MF350 350GTZ KZIS-3	->02.1994	
			 3482 060 132	350 MF350	03.1994->	
			 1878 001 145	350 10 350WGTZ	03.1994->	
			 3151 199 001	KZIS-3	03.1994->	
11...						
11 S 15 11 S 16	-03.96 -03.96	D0824LFL	 3400 700 322 ☉  3482 093 032  1862 438 032	330 10 MFZ330 330WTB	Je nach Kundenwunsch mit unterschiedlicher Kupplung / Equipped with different clutch according to customer requirement	(35)
			 3400 710 001  3482 120 031  1878 044 631  3182 005 231	362 10 MFZ362 362GTZ HHISZ-3		
			 3400 121 801 ☉  3482 120 031  1878 044 631	362 10 MFZ362 362GTZ	Je nach Kundenwunsch mit unterschiedlicher Kupplung / Equipped with different clutch according to customer requirement	(35)
11 S 15 (T72) 11 S 16 (T72)	04.96 - 04.96 -	D0824LFL	 3400 121 701  3482 000 467  1862 506 131  3151 253 031	395 10 MFZ395 395WGTZ KZIZ-4,5	Je nach Kundenwunsch mit unterschiedlicher Kupplung / Equipped with different clutch according to customer requirement	(35)
			 3400 121 801 ☉  3482 120 031  1878 044 631	362 10 MFZ362 362GTZ	Je nach Kundenwunsch mit unterschiedlicher Kupplung / Equipped with different clutch according to customer requirement	(35)
			 3400 710 001  3482 120 031  1878 044 631  3182 005 231	362 10 MFZ362 362GTZ HHISZ-3		
11 S 18		WD612.63	 3151 156 003	KZIZ-4,5		
12...						
12 S 14		WD612.24	 3482 063 101 #	310 MFZ310		
			 1862 125 202 #	310 10 310GTD		
			 3151 156 003	KZIZ-4,5		
12 S 15 12 S 16	-03.96 -03.96	D0824LFL	 3400 700 322 ☉  3482 093 032  1862 438 032	330 10 MFZ330 330WTB	Je nach Kundenwunsch mit unterschiedlicher Kupplung / Equipped with different clutch according to customer requirement	(35)
			 3400 710 001  3482 120 031  1878 044 631  3182 005 231	362 10 MFZ362 362GTZ HHISZ-3		
			 3400 121 801 ☉  3482 120 031  1878 044 631	362 10 MFZ362 362GTZ	Je nach Kundenwunsch mit unterschiedlicher Kupplung / Equipped with different clutch according to customer requirement	(35)
12 S 15 (T72) 12 S 16 (T72)	04.96 - 04.96 -	D0824LFL	 3400 121 701  3482 000 467  1862 506 131  3151 253 031	395 10 MFZ395 395WGTZ KZIZ-4,5	Je nach Kundenwunsch mit unterschiedlicher Kupplung / Equipped with different clutch according to customer requirement	(35)
			 3400 121 801 ☉  3482 120 031  1878 044 631	362 10 MFZ362 362GTZ	Je nach Kundenwunsch mit unterschiedlicher Kupplung / Equipped with different clutch according to customer requirement	(35)
			 3400 710 001	362 10		

STEYR





12...						
12 S 18		WD612.71, 73		1878 001 144	350 10 350WGTZ	
12 S 21		WD612.75		3482 067 102 #	380 GMFZ380	
				1878 001 152	380 10 380WGTZ	
12 S 22 12 S 26	01.96 - 01.96 -	D0826		3400 121 701  3482 000 467  1862 506 131  3151 253 031	395 10 MFZ395 395WGTZ KZIZ-4,5	

































13...								
13 S 15 13 S 16	-03.96 -03.96	D0824LFL		3400 700 322 	330 10 MFZ330 330WTB	Je nach Kundenwunsch mit unterschiedlicher Kupplung / Equipped with different clutch according to customer requirement (35)		
					3400 710 001  3482 120 031  1878 044 631  3182 005 231		362 10 MFZ362 362GTZ HHISZ-3	
					3400 121 801 		362 10 MFZ362 362GTZ	Je nach Kundenwunsch mit unterschiedlicher Kupplung / Equipped with different clutch according to customer requirement (35)
13 S 15 (T72) 13 S 16 (T72)	04.96 - 04.96 -	D0824LFL		3400 121 701  3482 000 467  1862 506 131  3151 253 031	395 10 MFZ395 395WGTZ KZIZ-4,5	Je nach Kundenwunsch mit unterschiedlicher Kupplung / Equipped with different clutch according to customer requirement (35)		
					3400 121 801 		362 10 MFZ362 362GTZ	Je nach Kundenwunsch mit unterschiedlicher Kupplung / Equipped with different clutch according to customer requirement (35)
					3400 710 001  3482 120 031  1878 044 631  3182 005 231		362 10 MFZ362 362GTZ HHISZ-3	Je nach Kundenwunsch mit unterschiedlicher Kupplung / Equipped with different clutch according to customer requirement (35)
13 S 18		WD612.63		3151 156 003	KZIZ-4,5			
13 S 22 13 S 26	01.96 - 01.96 -	D0826		3400 121 701  3482 000 467  1862 506 131  3151 253 031	395 10 MFZ395 395WGTZ KZIZ-4,5			



14...								
14 S 14		WD612.24		3482 063 101 #	310 MFZ310			
					1862 125 202 #	310 10 310GTD		
					3151 156 003	KZIZ-4,5		
14 S 15 14 S 16	-03.96 -03.96	D0824LFL		3400 700 322 	330 10 MFZ330 330WTB	Je nach Kundenwunsch mit unterschiedlicher Kupplung / Equipped with different clutch according to customer requirement (35)		
					3400 121 801 		362 10 MFZ362 362GTZ	Je nach Kundenwunsch mit unterschiedlicher Kupplung / Equipped with different clutch according to customer requirement (35)
					3400 710 001  3482 120 031  1878 044 631  3182 005 231		362 10 MFZ362 362GTZ HHISZ-3	
14 S 15 (T72) 14 S 16 (T72)	04.96 - 04.96 -	D0824LFL		3400 121 701  3482 000 467  1862 506 131  3151 253 031	395 10 MFZ395 395WGTZ KZIZ-4,5	Je nach Kundenwunsch mit unterschiedlicher Kupplung / Equipped with different clutch according to customer requirement (35)		
					3400 121 801 		362 10 MFZ362 362GTZ	Je nach Kundenwunsch mit unterschiedlicher Kupplung / Equipped with different clutch according to customer requirement (35)
					3400 710 001  3482 120 031  1878 044 631  3182 005 231		362 10 MFZ362 362GTZ HHISZ-3	
14 S 18		WD612.71, 73		1878 001 144	350 10 350WGTZ			
14 S 21		WD612.75		3482 067 102 #	380 GMFZ380			
					1878 001 152	380 10 380WGTZ		

		CODE				
--	--	------	--	---	---	---



STEYR



14...						
14 S 22	01.96-	D0826		3400 121 701  3482 000 467  1862 506 131  3151 253 031	395 10 MFZ395 395WGTZ KZIZ-4,5	
14 S 26	01.96-					

15...						
15 S 15	-03.96	D0824LFL		3400 700 322   3482 093 032  1862 438 032	330 10 MFZ330 330WTB	Je nach Kundenwunsch mit unterschiedlicher Kupplung / Equipped with different clutch according to customer requirement (35)
15 S 16	-03.96			3400 121 801   3482 120 031  1878 044 631	362 10 MFZ362 362GTZ	Je nach Kundenwunsch mit unterschiedlicher Kupplung / Equipped with different clutch according to customer requirement (35)
				3400 710 001  3482 120 031  1878 044 631  3182 005 231	362 10 MFZ362 362GTZ HHISZ-3	
15 S 15 (T72)	04.96-	D0824LFL		3400 121 701  3482 000 467  1862 506 131  3151 253 031	395 10 MFZ395 395WGTZ KZIZ-4,5	Je nach Kundenwunsch mit unterschiedlicher Kupplung / Equipped with different clutch according to customer requirement (35)
15 S 16 (T72)	04.96-			3400 121 801   3482 120 031  1878 044 631	362 10 MFZ362 362GTZ	Je nach Kundenwunsch mit unterschiedlicher Kupplung / Equipped with different clutch according to customer requirement (35)
				3400 710 001  3482 120 031  1878 044 631  3182 005 231	362 10 MFZ362 362GTZ HHISZ-3	
15 S 18		WD612.71, 73		1878 001 144	350 10 350WGTZ	
		WD612.63		3151 156 003	KZIZ-4,5	
15 S 21		WD612.75		3482 067 102 #	380 GMFZ380	
				1878 001 152	380 10 380WGTZ	
15 S 22	01.95-	D0826		3400 121 701  3482 000 467  1862 506 131  3151 253 031	395 10 MFZ395 395WGTZ KZIZ-4,5	
15 S 26	01.95-					























16...						
16 S 18		WD612.71, 73		1878 001 144	350 10 350WGTZ	
16 S 21		WD612.75		3482 067 102 #	380 GMFZ380	
				1878 001 152	380 10 380WGTZ	









17...						
17 S 18		WD612.63		3151 156 003	KZIZ-4,5	

18...						
18 S 26		WD612.34		3482 067 102 #	380 GMFZ380	
				1878 001 152	380 10 380WGTZ	
				3151 156 003	KZIZ-4,5	

19...						
19 S 28				1882 304 208	420 GF420N	für Nebenantrieb / for PTO (82)
				1878 003 661	420 10 420WGTZ	für Nebenantrieb / for PTO (82)
				3151 082 001	KZI-6	für Nebenantrieb / for PTO mit Schmierrohranschluss / with lubrication pipe connection (82) (91)











STEYR





19...							
19 S 29 T03 19 S 34 T03	01.94 - 01.00	D2865LF24, D2865LF20, D2865LF21	 3400 122 301 ⊗ 3482 083 032 ⊗ 1878 080 034 ⊙ 3151 000 034	430 10 MFZ430 430WGTZ KZISZ-5			
	01.94 - 01.00		 3482 114 031	430 GMFZ430N	für Nebenantrieb / for PTO	(82)	
			 1878 080 034	430 10 430WGTZ	für Nebenantrieb / for PTO	(82)	
			 3151 263 031	KZIS-6	für Nebenantrieb / for PTO	(82)	
19 S 31		WD615.68, 78	 3482 118 031	430 GMF430			
			 1878 003 661	420 10 420WGTZ			
			 3151 000 515	KZIS-4			
				 1882 304 208	420 GF420N	für Nebenantrieb / for PTO	(82)
				 1878 003 661	420 10 420WGTZ	für Nebenantrieb / for PTO	(82)
				 3151 082 001	KZI-6	für Nebenantrieb / for PTO mit Schmierrohranschluss / with lubrication pipe connection	(82) (91)
19 S 37		WD815.66	 3482 083 113	430 MFZ430			
			 1862 315 101 #	430 10 430GVZ			
			 3151 217 001	KZIS-5			
19 S 40 19 S 46		D2840	 3488 017 447	400 MFZ2/400X	enthält eine Kupplungsscheibe / This part number includes one clutch disc	(67)	
			 1878 002 643 ▽	400 10 400WGTZ	Lose Kupplungsscheibe / Loose clutch disc	(41)	
			 3151 262 031	KZISZ-5			
			 1878 002 023 △	400 8 400GTZ	In 3483/3488 enthalten / Contained in 3483, 3488	(32)	
			D2866	 3482 083 032	430 MFZ430		
				 1878 004 832	430 10 430WGTZ		
				 3151 000 034	KZISZ-5		
				 3400 700 327 ⊗ 3482 114 031 ⊗ 1878 004 832 ⊙ 3151 263 031	430 10 GMFZ430N 430WGTZ KZIS-6	01.1994-> für Nebenantrieb / for PTO	(82)
				 3400 700 641 HD ⊗ 3482 114 031 ⊗ 1878 007 729 ⊙ 3151 263 031	430 10 GMFZ430N 430WGTZ KZIS-6	01.1994-> Nebenantriebs-ID / PTO ID: NMV 221	(50)
				 3189 600 036		für Fahrzeuge mit Zweischeibenkupplung / for vehicles with double disc clutch	(77)



























22...						
22 S 31		WD615.68, 78	 3482 118 031	430 GMF430		
			 1878 003 661	420 10 420WGTZ		
			 3151 000 515	KZIS-4		
22 S 34		WD815.69	 3482 083 113	430 MFZ430		
			 1862 315 101 #	430 10 430GVZ		
			 3151 217 001	KZIS-5		
22 S 37		WD815.66	 3482 083 113	430 MFZ430		
			 1862 315 101 #	430 10 430GVZ		
			 3151 217 001	KZIS-5		

		CODE				
--	--	------	--	---	---	---







STEYR













23...						
23 S 34	01.94-	D2865LF21	 3400 122 301  3482 083 032  1878 080 034  3151 000 034	430 10 MFZ430 430WGTZ KZISZ-5		
			 3482 114 031	430 GMFZ430N	für Nebenantrieb / for PTO	(82)
			 1878 080 034	430 10 430WGTZ	für Nebenantrieb / for PTO	(82)
			 3151 263 031	KZIZ-6	für Nebenantrieb / for PTO	(82)
23 S 40 23 S 46	01.94 - 01.94-	D2866, 2876	 3482 083 032	430 MFZ430		
			 1878 004 832	430 10 430WGTZ		
			 3151 000 034	KZISZ-5		

























25...						
25 S 22 25 S 26	06.95 - 06.95-	D0826LF	 3400 121 701  3482 000 467  1862 506 131  3151 253 031	395 10 MFZ395 395WGTZ KZIZ-4,5		

26...										
26 S 29		D2865	 3400 122 301  3482 083 032  1878 080 034  3151 000 034	430 10 MFZ430 430WGTZ KZISZ-5						
			 3482 114 031	430 GMFZ430N	für Nebenantrieb / for PTO	(82)				
			 1878 080 034	430 10 430WGTZ	für Nebenantrieb / for PTO	(82)				
			 3151 263 031	KZIZ-6	für Nebenantrieb / for PTO	(82)				
26 S 31		WD615.68, 78	 3482 118 031	430 GMF430						
			 1878 003 661	420 10 420WGTZ						
			 3151 000 515	KZIS-4						
26 S 32		WD615.68	 3482 083 113	430 MFZ430						
			 1878 003 662	420 10 420WGTZ						
			 3151 000 144	KZISZ-5	für Ausrückgabel mit Nocken / for release fork with cams	(70)				
26 S 34	WD815.69		 3482 083 113	430 MFZ430						
			 1862 315 101 #	430 10 430GVZ						
			 3151 217 001	KZIZ-5						
	D2865			 3400 122 301  3482 083 032  1878 080 034  3151 000 034	430 10 MFZ430 430WGTZ KZISZ-5					
				 3482 114 031	430 GMFZ430N	01.1994-> für Nebenantrieb / for PTO	(82)			
				 1878 080 034	430 10 430WGTZ	01.1994-> für Nebenantrieb / for PTO	(82)			
				 3151 263 031	KZIZ-6	01.1994-> für Nebenantrieb / for PTO	(82)			
				WD815.66			 3482 083 113	430 MFZ430		
							 1862 315 101 #	430 10 430GVZ		
 3151 217 001	KZIZ-5									

STEYR



26...						
26 S 40 T38 26 S 46			 3400 122 301  3482 083 032  1878 080 034  3151 000 034	430 10 MFZ430 430WGTZ KZISZ-5		
		D2866	 3482 114 031	430 GMFZ430N	für Nebenantrieb / for PTO	(82)
			 1878 080 034	430 10 430WGTZ	für Nebenantrieb / for PTO	(82)
			 3151 263 031	KZIZ-6	für Nebenantrieb / for PTO	(82)



32...						
32 S 31		WD615.68, 78	 3482 118 031	430 GMF430		
			 1878 003 661	420 10 420WGTZ		
			 3151 000 515	KZIS-4		
32 S 34		WD815.69	 3482 083 113	430 MFZ430		
			 1862 315 101 #	430 10 430GVZ		
			 3151 217 001	KZIZ-5		
		WD815.74	 3482 118 031	430 GMF430		
			 1878 002 706	420 10 420GTZ		
			 3151 000 515	KZIS-4		
32 S 37		WD815.66	 3482 083 113	430 MFZ430		
			 1862 315 101 #	430 10 430GVZ		
			 3151 217 001	KZIZ-5		





33...						
33 S 40			 3400 122 301  3482 083 032  1878 080 034  3151 000 034	430 10 MFZ430 430WGTZ KZISZ-5		
		D2866	 3482 114 031	430 GMFZ430N	für Nebenantrieb / for PTO	(82)
			 1878 080 034	430 10 430WGTZ	für Nebenantrieb / for PTO	(82)
			 3151 263 031	KZIZ-6	für Nebenantrieb / for PTO	(82)
33 S 46		D2840	 3488 017 447	400 MFZ2/400X	enthält eine Kupplungsscheibe / This part number includes one clutch disc	(67)
			 1878 002 643 ▽	400 10 400WGTZ	Lose Kupplungsscheibe / Loose clutch disc	(41)
			 3151 262 031	KZISZ-5		
			 1878 002 023 △	400 8 400GTZ	In 3483/3488 enthalten / Contained in 3483, 3488	(32)
		D2876	 3400 122 201  3482 083 032  1878 004 832  3151 000 034	430 10 MFZ430 430WGTZ KZISZ-5		
			 3400 700 327  3482 114 031  1878 004 832  3151 263 031	430 10 GMFZ430N 430WGTZ KZIZ-6	für Nebenantrieb / for PTO	(82)
			 3400 700 641 HD  3482 114 031  1878 007 729  3151 263 031	430 10 GMFZ430N 430WGTZ KZIZ-6	Nebenantriebs-ID / PTO ID: NMV 221	(50)
			 3189 600 036		für Fahrzeuge mit Zweischeibenkupplung / for vehicles with double disc clutch	(77)















		CODE				
--	--	------	--	---	---	---

STEYR

35...							
35 S 36 T46 35 S 41 T46	06.98-	D2866LF31, D2866LF35		3400 122 201 ⊗ 3482 083 032 ⊗ 1878 004 832 ⊙ 3151 000 034	430 10 MFZ430 430WGTZ KZISZ-5		
	06.98-			3400 700 327 ⊗ 3482 114 031 ⊗ 1878 004 832 ⊙ 3151 263 031	430 10 GMFZ430N 430WGTZ KZIZ-6	für Nebenantrieb / for PTO	(82)
				3400 700 641 HD ⊗ 3482 114 031 ⊗ 1878 007 729 ⊙ 3151 263 031	430 10 GMFZ430N 430WGTZ KZIZ-6	Nebenantriebs-ID / PTO ID: NMV 221	(50)









41...							
41 S 36 T46 41 S 40 T46 41 S 41 T46 41 S 46 T46	06.98-	D2876LF03, D2866LF20, D2876LF02, D2866LF31, D2866LF35		3400 122 201 ⊗ 3482 083 032 ⊗ 1878 004 832 ⊙ 3151 000 034	430 10 MFZ430 430WGTZ KZISZ-5		
	08.95-			3400 700 327 ⊗ 3482 114 031 ⊗ 1878 004 832 ⊙ 3151 263 031	430 10 GMFZ430N 430WGTZ KZIZ-6	für Nebenantrieb / for PTO	(82)
	08.95-			3400 700 641 HD ⊗ 3482 114 031 ⊗ 1878 007 729 ⊙ 3151 263 031	430 10 GMFZ430N 430WGTZ KZIZ-6	Nebenantriebs-ID / PTO ID: NMV 221	(50)



















42...							
42 S 40 42 S 46		D2866		3482 083 032	430 MFZ430	06.1996->	
				1878 004 832	430 10 430WGTZ	06.1996->	
				3151 000 034	KZISZ-5	06.1996->	
				3400 700 327 ⊗ 3482 114 031 ⊗ 1878 004 832 ⊙ 3151 263 031	430 10 GMFZ430N 430WGTZ KZIZ-6	für Nebenantrieb / for PTO	(82)
				3400 700 641 HD ⊗ 3482 114 031 ⊗ 1878 007 729 ⊙ 3151 263 031	430 10 GMFZ430N 430WGTZ KZIZ-6	Nebenantriebs-ID / PTO ID: NMV 221	(50)

60 - 991						
90				1864 347 102 #	350 22 350Z	
780 E		Ladermot.		1880 092 415 #	310 G310	
				1878 634 072	310 10 310GTD	
791		70, 77, 90, WD612.00, 20, 60, 67,		1882 110 513	350 GF350	
				1878 001 144	350 10 350WGTZ	
				3151 000 395	KZIS-4	
880 Z				1881 039 531 #	350 G350	
				1878 001 074	350 10 350GTZ	
890 990		614.01		1881 039 531 #	350 G350	
				1878 005 367	350 10 350WGTZ	
				3151 000 395	KZIS-4	
891		WD612.60		1882 110 513	350 GF350	
				1878 001 144	350 10 350WGTZ	
				3151 000 395	KZIS-4	

























		CODE					
--	--	------	--	--	---	---	---

STEYR

60 - 991							
990		+614.60, 230PS, WD614.01, 180PS		1882 261 013 #	380 G380N	Nebenantriebs-ID / PTO ID: 80/3	(50)
				3151 111 032	KZI-6	ohne Schmierrohranschluss / without lubricating pipe connection	(103)
990 4x4		614.20		1881 039 531 #	350 G350	Nebenantriebs-ID / PTO ID: 80/3	(50)
				1878 005 367	350 10 350WGTZ		
				3151 000 395	KZIS-4		
991		WD615.00, 20		1882 327 003 #	380 GF380		
				1878 001 152	380 10 380WGTZ		
				3151 000 395	KZIS-4		

1090 - 2891							
1090 , a		WD610.42		1881 039 531 #	350 G350		
				1864 347 102 #	350 22 350Z		
1100 , a		WD610.40		1881 039 531 #	350 G350		
				1864 347 102 #	350 22 350Z		
1108 , a		WD610.44		1881 039 531 #	350 G350		
				1864 347 102 #	350 22 350Z		
1200 , a		WD610.43		1881 039 531 #	350 G350		
				1864 347 102 #	350 22 350Z		
1290		614, 70		1882 327 003 #	380 GF380		
				3151 000 395	KZIS-4		
		WD614.60		1882 327 003 #	380 GF380		
				3151 000 395	KZIS-4		
1290 1490		WD815.60, V8		3482 124 522	430 GMF430		
				3151 000 395	KZIS-4		
1290 1490		D1815.60, 320PS, WD815.00, 270PS+W		3482 124 522	430 GMF430		
				1878 002 706	420 10 420GTZ		
				3151 000 395	KZIS-4		
		+614.60, 230PS, WD614.01, 180PS		1882 261 013 #	380 G380N	Nebenantriebs-ID / PTO ID: 80/3	(50)
	3151 111 032		KZI-6	ohne Schmierrohranschluss / without lubricating pipe connection	(103)		
					Nebenantriebs-ID / PTO ID: 80/3	(50)	

























STEYR

1090 - 2891						
1291 1491		69, 71, 75, 77, WD615.61, 65, 66, 67,	 3482 124 522	430 GMF430		
			 1878 003 661	420 10 420WGTZ		
 3151 000 515	KZIS-4					
	WD615.60, 70		 1882 327 003 #	380 GF380		
			 1878 001 152	380 10 380WGTZ		
			 3151 000 395	KZIS-4		
	WD615.78		 3482 118 031	430 GMF430	Getr. / GBox: ZF 16 S 130	
			 1878 003 661	420 10 420WGTZ	Getr. / GBox: ZF 16 S 130	
			 3151 000 515	KZIS-4	Getr. / GBox: ZF 16 S 130	
	WD815.61, 63, 71		 3482 124 522	430 GMF430		
			 1878 002 706	420 10 420GTZ		
			 3151 000 515	KZIS-4		
	WD815.62, 64, 74		 3482 118 031	430 GMF430		
			 1878 002 706	420 10 420GTZ		
			 3151 000 515	KZIS-4		
	WD815.67, 68, 97		 1882 342 134	420 GF420X		
			 1878 002 706	420 10 420GTZ		
			 3151 000 515	KZIS-4		
	WD815.61-69, 71, 75, 77		 1878 003 661	420 10 420WGTZ	für Nebenantrieb / for PTO	(82)
			 3151 082 001	KZI-6	für Nebenantrieb / for PTO mit Schmierrohranschluss / with lubrication pipe connection	(82) (91)
1391		WD612.60	 1882 110 513	350 GF350		
			 1878 001 144	350 10 350WGTZ		
			 3151 000 395	KZIS-4		
1490		WD614.60	 1882 327 003 #	380 GF380		
			 3151 000 395	KZIS-4		

		CODE				
--	--	------	--	---	---	---

STEYR



1090 - 2891

1891	69, 71, 75, 77, WD615.61, 65, 66, 67,		3482 124 522	430 GMF430			
			1878 003 661	420 10 420WGTZ			
			3151 000 515	KZIS-4			
		WD815.61, 63, 71		3482 124 522	430 GMF430		
				1878 002 706	420 10 420GTZ		
				3151 000 515	KZIS-4		
		WD815.62, 64, 74		3482 118 031	430 GMF430		
				1878 002 706	420 10 420GTZ		
				3151 000 515	KZIS-4		
	WD815.67, 68, 97		1882 342 134	420 GF420X			
			1878 002 706	420 10 420GTZ			
			3151 000 515	KZIS-4			
WD815.61-69, 71, 75, 77		1878 003 661	420 10 420WGTZ	Nebenantriebs-ID / PTO ID: 110	(50)		
		3151 082 001	KZI-6	mit Schmierrohranschluss / with lubrication pipe connection Nebenantriebs-ID / PTO ID: 110	(91)		
1920	WD614e		1882 327 003 #	380 GF380			
			3151 000 395	KZIS-4			
2891	69, 71, 75, 77, WD615.61, 65, 66, 67,		3482 124 522	430 GMF430			
			1878 003 661	420 10 420WGTZ			
			3151 000 515	KZIS-4			
	WD615.92, 93		3482 118 031	430 GMF430			
			1878 003 661	420 10 420WGTZ			
			3151 000 515	KZIS-4			
	WD815.67, 68, 97		1882 342 134	420 GF420X			
			1878 002 706	420 10 420GTZ			
			3151 000 515	KZIS-4			

Pinzgauer





















Pinzgauer 712 Pinzgauer 716, 717 Pinzgauer 720		3082 007 338	240 MF240		
		1878 634 065	240 10 240TD		
		3151 011 001 ▲	KZI-1		

SL

SL 10 H 210 , 9 G	4F		1882 325 134	380 G380		
			3151 000 395	KZIS-4		









		CODE				
--	--	------	--	---	---	---

STEYR









TG-A		01.00 -				
18 S 31 H05 H01 18 S 36 H01 H05 18 S 41 H05 H01	04.00-	D2866LF27, D2866LF26, D2866LF28, D2866LF36, D2866LF37, D2866LF32	 3400 127 401 ⊗ 3482 000 361 ⊗ 1878 004 832 ⊙ 3151 000 034	430 10 MFZ430 430WGTZ KZISZ-5	Getr. / GBox: ZF Ecosplit-3	
	04.00-		 3488 017 447	400 MFZ2/400X	Getr. / GBox: ZF Ecosplit-3 für Fahrzeuge mit Zweischeibenkupplung / for vehicles with double disc clutch enthält eine Kupplungsscheibe / This part number includes one clutch disc	(77) (67)
	04.00-		 1878 002 643	400 10 400WGTZ	Getr. / GBox: ZF Ecosplit-3 für Fahrzeuge mit Zweischeibenkupplung / for vehicles with double disc clutch	(77)
			 3151 262 031	KZISZ-5	Getr. / GBox: ZF Ecosplit-3 für Fahrzeuge mit Zweischeibenkupplung / for vehicles with double disc clutch	(77)
			 3400 700 327 ⊗ 3482 114 031 ⊗ 1878 004 832 ⊙ 3151 263 031	430 10 GMFZ430N 430WGTZ KZIZ-6	Getr. / GBox: ZF Ecosplit-3 für Nebenantrieb / for PTO	(82)
			 3400 700 641 HD ⊗ 3482 114 031 ⊗ 1878 007 729 ⊙ 3151 263 031	430 10 GMFZ430N 430WGTZ KZIZ-6	Getr. / GBox: ZF 16S-151/181 Nebenantriebs-ID / PTO ID: NMV 221	(50)
			 3400 700 403 ⊗ 3482 000 361 ⊗ 1878 004 832 ⊙ 3151 000 144	430 10 MFZ430 430WGTZ KZISZ-5	Getr. / GBox: AS-Tronic für Ausrückgabel mit Nocken / for release fork with cams	(70)
			 3400 700 450 ⊗ 3482 000 361 ⊗ 1878 004 832 ⊙ 3151 000 493	430 10 MFZ430 430WGTZ KZISZ-5	Getr. / GBox: AS-Tronic für Ausrückgabel mit Rollen / for release fork with rollers	(71)
			 3189 600 004		Getr. / GBox: ZF AS Tronic Rollenausführung / roller version	(58)
			3189 600 036		für Fahrzeuge mit Zweischeibenkupplung / for vehicles with double disc clutch	(77)
18 S 46 H01 H05 18 S 51 H05	04.00-	D2876LF07, D2876LF08, D2676LF05, D2876LF04	 3400 700 402 ⊗ 3482 000 246 ⊗ 1878 002 139 ⊙ 3151 000 034	430 10 MFZ430 430WGTZ KZISZ-5	Getr. / GBox: ZF Ecosplit-3 Getr. / GBox: Eaton	
	04.00-		 3400 700 460 HD ⊗ 3482 000 246 ⊗ 1878 004 104 ⊙ 3151 000 034	430 10 MFZ430 430WGTZ KZISZ-5	Getr. / GBox: ZF Ecosplit-3 Getr. / GBox: Eaton	
			 3488 017 447	400 MFZ2/400X	Getr. / GBox: ZF Ecosplit-3 für Fahrzeuge mit Zweischeibenkupplung / for vehicles with double disc clutch enthält eine Kupplungsscheibe / This part number includes one clutch disc	(77) (67)
			 1878 002 643	400 10 400WGTZ	Getr. / GBox: ZF Ecosplit-3 für Fahrzeuge mit Zweischeibenkupplung / for vehicles with double disc clutch	(77)
			 3151 262 031	KZISZ-5	Getr. / GBox: ZF Ecosplit-3 für Fahrzeuge mit Zweischeibenkupplung / for vehicles with double disc clutch	(77)
			 3400 700 327 ⊗ 3482 114 031 ⊗ 1878 004 832 ⊙ 3151 263 031	430 10 GMFZ430N 430WGTZ KZIZ-6	Getr. / GBox: ZF 16S-151/185 für Nebenantrieb / for PTO	(82)
			 3400 700 641 HD ⊗ 3482 114 031 ⊗ 1878 007 729 ⊙ 3151 263 031	430 10 GMFZ430N 430WGTZ KZIZ-6	Getr. / GBox: ZF 16S-151/185 Nebenantriebs-ID / PTO ID: NMV 221	(50)
			 3400 700 404 ⊗ 3482 000 246 ⊗ 1878 002 139 ⊙ 3151 000 144	430 10 MFZ430 430WGTZ KZISZ-5	Getr. / GBox: AS-Tronic für Ausrückgabel mit Nocken / for release fork with cams	(70)
			 3400 700 445 ⊗ 3482 000 246 ⊗ 1878 002 139 ⊙ 3151 000 493	430 10 MFZ430 430WGTZ KZISZ-5	Getr. / GBox: AS-Tronic für Ausrückgabel mit Rollen / for release fork with rollers	(71)
			 3400 700 459 HD ⊗ 3482 000 246 ⊗ 1878 004 104 ⊙ 3151 000 493	430 10 MFZ430 430WGTZ KZISZ-5	Getr. / GBox: AS-Tronic für Ausrückgabel mit Rollen / for release fork with rollers	(71)
			 3189 600 036		für Fahrzeuge mit Zweischeibenkupplung / for vehicles with double disc clutch	(77)
			3189 600 004		Getr. / GBox: ZF AS Tronic Rollenausführung / roller version	(58)

		CODE				
--	--	------	--	---	---	---

STEYR





















TG-A		01.00 -					
26 S 31 H17 H86 26 S 36 H17 H86	09.00 -	D2866LF27, D2866LF26, D2866LF36, D2866LF37		3400 127 401 ⊗ 3482 000 361 ⊗ 1878 004 832 ⊙ 3151 000 034	430 10 MFZ430 430WGTZ KZISZ-5	Getr. / GBox: ZF Ecosplit-3	
	09.00 -			3488 017 447	400 MFZ2/400X	Getr. / GBox: ZF Ecosplit-3 für Fahrzeuge mit Zweischeibenkupplung / for vehicles with double disc clutch enthält eine Kupplungsscheibe / This part number includes one clutch disc	(77) (67)
				1878 002 643	400 10 400WGTZ	Getr. / GBox: ZF Ecosplit-3 für Fahrzeuge mit Zweischeibenkupplung / for vehicles with double disc clutch	(77)
				3151 262 031	KZISZ-5	Getr. / GBox: ZF Ecosplit-3 für Fahrzeuge mit Zweischeibenkupplung / for vehicles with double disc clutch	(77)
				3400 700 403 ⊗ 3482 000 361 ⊗ 1878 004 832 ⊙ 3151 000 144	430 10 MFZ430 430WGTZ KZISZ-5	Getr. / GBox: ZF-AS-Tronic für Ausrückgabel mit Nocken / for release fork with cams	(70)
				3400 700 450 ⊗ 3482 000 361 ⊗ 1878 004 832 ⊙ 3151 000 493	430 10 MFZ430 430WGTZ KZISZ-5	Getr. / GBox: ZF-AS-Tronic für Ausrückgabel mit Rollen / for release fork with rollers	(71)
				3400 700 327 ⊗ 3482 114 031 ⊗ 1878 004 832 ⊙ 3151 263 031	430 10 GMFZ430N 430WGTZ KZIZ-6	Getr. / GBox: ZF 16S-151/181 für Nebenantrieb / for PTO	(82)
				3400 700 641 HD ⊗ 3482 114 031 ⊗ 1878 007 729 ⊙ 3151 263 031	430 10 GMFZ430N 430WGTZ KZIZ-6	Getr. / GBox: ZF 16S-151/181 Nebenantriebs-ID / PTO ID: NMV 221	(50)
				3189 600 004		Getr. / GBox: ZF AS Tronic Rollenausführung / roller version	(58)
				3189 600 036		für Fahrzeuge mit Zweischeibenkupplung / for vehicles with double disc clutch	(77)















TAM

Nkw							
75 A5,6 75 T3B,4B 75 T5B,BK 5000 5000 5000 DC,HS,DVC 5000 F,K,P			1880 083 132 #	280 G280			
			1882 137 307 #	310 GF310			
110 T-10			1861 600 033 #	310 10 310GTD			
			3482 008 036 #	310 MF310			
122 T8			1861 034 147 #	350 10			
125 T10,12 125 T12 4x4 5500 5500,G 5500 DK,QG 6500 K,GO 6500 SN,BVL			1878 001 074	350 10 350GTZ			
			1882 325 134	380 G380			
150 T11B 6x6 150 T11BV 6x6			1878 001 152	380 10 380WGTZ			
			1878 003 657	420 10 420WGTZ			
190 T15 3,5 190 T15 4,1 190 T15 4x4 3,5 190 TBK 3,5							
260 T17 260 T22 6x4 260 T26 6x4 3,2 260 T26 6x4 4,7							

		CODE				
--	--	------	--	---	---	---





VOLKSWAGEN

CRAFTER 30-50 Kasten / Box (2E) 04.06 -							
2.0 TDI, 80 kW	05.11-	CKUC, CSLB, CKTB, CKTC		3000 950 746 ☉	240	XTend	
2.0 TDI, 84 kW	11.13-			3000 990 362	240		
2.0 TDI, 100 kW	05.11-			3182 654 192 Ⓜ	HHAS-1	Immer erneuern / Renew everytime	(30)
2.0 TDI, 105 kW	10.11-			6284 605 004			
2.0 TDI, 120 kW	07.11-	CSNA, CKUB		3000 990 415 ■	260		
		CKUB		6284 605 004			
2.0 TDI 4motion	11.11-	CSNA, CKUB		3000 990 415 ■	260		
2.5 TDI, 65 kW	04.06-07.11	BJJ, CEBA		3000 990 204 ☉ 3000 951 841 3182 654 192	240 26		
				2294 501 207	240	ohne Schwungradbefestigungsschrauben / without bolt for flywheel mounting	(104)
				1863 869 012	28	Nadellager / Needle Bearing	(49)
				6284 605 004			
2.5 TDI, 80 kW	04.06-	BJK, CEBB, BJL, CECA		3000 990 204 ☉ ☉ 3000 951 841 3182 654 192	240 26		
2.5 TDI, 100 kW	04.06-			3000 990 217 ☉ 3000 951 876 3182 997 802	240	Getr. / GBox: Shiftmatic (SMC)	
				2294 501 207	240	ohne Schwungradbefestigungsschrauben / without bolt for flywheel mounting	(104)
				1863 869 012	28	Nadellager / Needle Bearing	(49)
				6284 605 004 ☉			
2.5 TDI, 120 kW	04.06-07.11	BJM, CECB		3000 990 217 ☉ 3000 951 876 3182 997 802	240	Getr. / GBox: Shiftmatic (SMC)	
				3000 990 246 ☉ ☉ 3000 951 932 3182 654 192	260 26		
				1863 869 012	28	Nadellager / Needle Bearing	(49)
				6284 605 004 ☉			
				6284 605 004 ☉			





















CRAFTER 30-50 Pritsche / Flatbed (2E) 04.06 -							
2.0 TDI, 80 kW	05.11-	CKUC, CSLB, CKTB, CKTC		3000 950 746 ☉	240	XTend	
2.0 TDI, 84 kW	11.13-			3000 990 362	240		
2.0 TDI, 100 kW	05.11-			3182 654 192 Ⓜ	HHAS-1	Immer erneuern / Renew everytime	(30)
2.0 TDI, 105 kW	10.11-			6284 605 004			
2.0 TDI, 120 kW	07.11-	CSNA, CKUB		3000 990 415 ■	260		
		CKUB		6284 605 004			
2.0 TDI 4motion	11.11-	CSNA, CKUB		3000 990 415 ■	260		
2.5 TDI, 65 kW	04.06-07.11	BJJ, CEBA		3000 990 204 ☉ 3000 951 841 3182 654 192	240 26		
				2294 501 207	240	ohne Schwungradbefestigungsschrauben / without bolt for flywheel mounting	(104)
				1863 869 012	28	Nadellager / Needle Bearing	(49)
				6284 605 004			
2.5 TDI, 80 kW	04.06-	BJK, CEBB, BJL, CECA		3000 990 204 ☉ ☉ 3000 951 841 3182 654 192	240 26		
2.5 TDI, 100 kW	04.06-			3000 990 217 ☉ 3000 951 876 3182 997 802	240	Getr. / GBox: Shiftmatic (SMC)	
				2294 501 207	240	ohne Schwungradbefestigungsschrauben / without bolt for flywheel mounting	(104)
				1863 869 012	28	Nadellager / Needle Bearing	(49)
				6284 605 004 ☉			

		CODE				
--	--	------	--	---	---	---

VOLKSWAGEN

CRAFTER 30-50 Pritsche / Flatbed (2E) 04.06 -							
2.5 TDI, 120 kW	04.06 - 07.11	BJM, CECB		3000 990 217 3000 951 876 3182 997 802	240 HHAS-1	Getr. / GBox: Shiftmatic (SMC)	
				3000 990 246 3000 951 932 3182 654 192	260 26 HHAS-1		
				1863 869 012	28	Nadellager / Needle Bearing	(49)
				6284 605 004			





















L 80 07.95 - 12.00						
4.3	07.95 - 12.00	AGF		3482 934 001	325 MF325	
				1878 654 641	325 10 325CPB	
				3151 997 201	KZI-3	

LT 28-35 Kasten / Box (281-363) 04.75 - 06.96							
2.4	12.82 - 07.92	DL		3000 055 006 ▲ 3082 190 031 1861 897 034 3151 193 041	228 23 M228 228TB KZIS-0		
				1863 869 002	24	Nadellager / Needle Bearing	(49)
				3074 003 343 LHD		08.1989->	
2.4 i	03.94 - 06.96	1E		3000 055 006 ▲ 3082 190 031 1861 897 034 3151 193 041	228 23 M228 228TB KZIS-0		
				1863 869 002	24	Nadellager / Needle Bearing	(49)
				3074 003 343 LHD		->12.1995	
2.4 D, 51 kW 2.4 TD, 70 kW	07.90 - 05.96 06.92 - 05.96	1S, ACL, ACT		3000 055 005 3082 190 031 1878 004 776 3151 193 041	228 23 M228 220VTPB KZIS-0		
				1863 869 002	24	Nadellager / Needle Bearing	(49)
				3074 003 343 LHD		->12.1995	
2.4 D, 55 kW	01.79 - 07.92	DW, CP		3000 055 005 3082 190 031 1878 004 776 3151 193 041	228 23 M228 220VTPB KZIS-0		
				1863 869 002	24	Nadellager / Needle Bearing	(49)
		DW		3074 003 343 LHD		08.1989->	
2.4 TD, 68 kW	08.88 - 08.92	1G		3000 055 005 3082 190 031 1878 004 776 3151 193 041	228 23 M228 220VTPB KZIS-0		
				1863 869 002	24	Nadellager / Needle Bearing	(49)
2.4 TD, 75 kW	02.86 - 08.92	DV		3000 055 005 3082 190 031 1878 004 776 3151 193 041	228 23 M228 220VTPB KZIS-0		
				1863 869 002	24	Nadellager / Needle Bearing	(49)
				3074 003 343 LHD		08.1989->	
2.7 D	11.75 - 01.80	Perkins		3082 086 434	228 M228		
				1861 897 034 ▲	228 23 228TB		
				3151 193 041	KZIS-0		











		CODE				
--	--	------	--	---	---	---

VOLKSWAGEN

LT 28-35 | Pritsche / Flatbed (281-363) 04.75 - 06.96

2.4	12.82-07.92	DL	 3000 055 006 ▲ ⊗ 3082 190 031 ⊗ 1861 897 034 ⊙ 3151 193 041	228 23 M228 228TB KZIS-0		
			 1863 869 002	24	Nadellager / Needle Bearing	(49)
			 3074 003 343 (LHD)		08.1989->	
2.4 i	03.94-06.96	1E	 3000 055 006 ▲ ⊗ 3082 190 031 ⊗ 1861 897 034 ⊙ 3151 193 041	228 23 M228 228TB KZIS-0		
			 1863 869 002	24	Nadellager / Needle Bearing	(49)
			 3074 003 343 (LHD)		->12.1995	
2.4 D, 51 kW	08.90-06.96	1S, ACT	 3000 055 005 ⊗ 3082 190 031 ⊗ 1878 004 776 ⊙ 3151 193 041	228 23 M228 220VTPB KZIS-0		
			 1863 869 002	24	Nadellager / Needle Bearing	(49)
			 3074 003 343 (LHD)		->12.1995	
2.4 D, 55 kW	12.78-02.91	DW, CP	 3000 055 005 ⊗ 3082 190 031 ⊗ 1878 004 776 ⊙ 3151 193 041	228 23 M228 220VTPB KZIS-0		
			 1863 869 002	24	Nadellager / Needle Bearing	(49)
		DW	 3074 003 343 (LHD)		08.1989->	
2.4 TD, 68 kW 2.4 TD, 70 kW	08.90-08.92 08.92-06.96	ACL, 1G	 3000 055 005 ⊗ 3082 190 031 ⊗ 1878 004 776 ⊙ 3151 193 041	228 23 M228 220VTPB KZIS-0		
			 1863 869 002	24	Nadellager / Needle Bearing	(49)
2.4 TD, 75 kW	12.82-09.93	DV	 3000 055 005 ⊗ 3082 190 031 ⊗ 1878 004 776 ⊙ 3151 193 041	228 23 M228 220VTPB KZIS-0		
			 1863 869 002	24	Nadellager / Needle Bearing	(49)
			 3074 003 343		08.1989 - 08.1992	
2.7 D	11.75-01.80	Perkins	 3082 086 434	228 M228		
			 1861 897 034 ▲	228 23 228TB		
			 3151 193 041	KZIS-0		























LT 28-46 II Kasten / Box (2DX0AE) 04.96 - 07.06

2.3	05.96-07.06	AGL	 3000 826 901 ⊗ 3082 268 031 ⊗ 1878 994 001 ⊙ 3151 248 031	240 26 M240 240TB KZIS-0		
			 6283 600 115			
			 6284 600 573			
2.5 SDI	09.96-07.06	AGX	 3000 845 801 ⊗ 3082 639 402 ⊗ 1878 988 102 ⊙ 3151 248 031	240 26 MF240 240TB KZIS-0		
			 1863 869 005	24	Nadellager / Needle Bearing	(49)
			 6283 600 115			
2.5 TDI, 61 kW 2.5 TDI, 70 kW	05.01-07.06 05.01-07.06	BBF, BBE	 3000 951 104 ⊗ 3082 600 522 ⊗ 1878 988 102 ⊙ 3151 248 031	240 26 M240 240TB KZIS-0		
			 1863 869 005	24	Nadellager / Needle Bearing	(49)
			 6283 600 115			
			 6284 600 573			

		CODE					
--	--	------	--	--	---	---	---

VOLKSWAGEN

LT 28-46 II Kasten / Box (2DX0AE) 04.96 - 07.06

2.5 TDI, 66 kW	05.99 - 07.06	APA	 3000 845 101 ⊗ 3082 308 043 ⊗ 1878 988 102 ⊙ 3151 248 031	240 26 MF240 240TB KZIS-0		
			 1863 869 005	24	Nadellager / Needle Bearing	(49)
			 6283 600 115			
			 6284 600 573			
2.5 TDI, 75 kW	05.96 - 08.99	AHD	 3000 828 601 ⊗ 3082 308 043 ⊗ 1864 528 442 ⊙ 3151 248 031	240 26 MF240 240B KZIS-0	->Mot. 047 378 für / for: LT 28/35	(69)
			 3000 845 101 ⊗ 3082 308 043 ⊗ 1878 988 102 ⊙ 3151 248 031	240 26 MF240 240TB KZIS-0	Mot. 047 379-> für / for: LT 28/35	(69)
			 3000 845 101 ⊗ 3082 308 043 ⊗ 1878 988 102 ⊙ 3151 248 031	240 26 MF240 240TB KZIS-0	für / for: LT 46	(69)
			 1863 869 005	24	Nadellager / Needle Bearing	(49)
			 6283 600 115			
			 6284 600 573			
2.5 TDI, 80 kW	05.99 - 07.06	ANJ	 3000 951 710 ⊗ 3082 600 509 ⊗ 1878 988 102 ⊙ 3151 248 031	240 26 MF240 240TB KZIS-0	->Mot. 052609	
			 3000 951 104 ⊗ 3082 600 522 ⊗ 1878 988 102 ⊙ 3151 248 031	240 26 M240 240TB KZIS-0	Mot. 052610->	
		AVR	 3000 951 104 ⊗ 3082 600 522 ⊗ 1878 988 102 ⊙ 3151 248 031	240 26 M240 240TB KZIS-0		
		AVR, ANJ	 1863 869 005	24	Nadellager / Needle Bearing	(49)
			 6283 600 115			
			 6284 600 573			
2.8 TDI, 92 kW 2.8 TDI, 96 kW	07.97 - 01.02 01.99 - 07.06	ATA, AGK	 3000 845 001 ⊗ 3082 919 001 ⊗ 1864 528 442 ⊙ 3151 248 031	240 26 MF240 240B KZIS-0		
			 1863 869 005	24	Nadellager / Needle Bearing	(49)
			 6283 600 115			
			 6284 600 573			
2.8 TDI, 116 kW	04.02 - 07.06	AUH, BCQ	 3000 951 107 ■	240 26	XTend ->Chass. 2D-2-036 000 Nabenprofil / Hub Profile: 26,5x28,9-26N nur in Verbindung mit / only in connection with: 062 105 266 F	(48) (101)
			3000 951 107 ■	240 26	XTend Chass. 2D-2-036 001-> Nabenprofil / Hub Profile: 26,5x28,9-26N	(48)
		AUH	 6283 600 115			
	BCQ, AUH	 6284 600 573				

































































LT 28-46 II Pritsche / Flatbed (2DX0FE) 04.96 - 07.06

2.3	06.96 - 07.06	AGL	 3000 826 901 ⊗ 3082 268 031 ⊗ 1878 994 001 ⊙ 3151 248 031	240 26 M240 240TB KZIS-0		
			 6283 600 115			
			 6284 600 573			

		CODE				
--	--	------	--	---	---	---









VOLKSWAGEN







LT 28-46 II Pritsche / Flatbed (2DX0FE) 04.96 - 07.06





2.5 SDI	09.96 - 07.06	AGX	 3000 845 801  3082 639 402  1878 988 102  3151 248 031	240 26 MF240 240TB KZIS-0		
			 1863 869 005	24	Nadellager / Needle Bearing	(49)
			 6283 600 115			
			 6284 600 573			
2.5 TDI, 61 kW	05.01 - 07.06	BBE	 3000 951 104  3082 600 522  1878 988 102  3151 248 031	240 26 M240 240TB KZIS-0		
			 1863 869 005	24	Nadellager / Needle Bearing	(49)
			 6283 600 115			
			 6284 600 573			
2.5 TDI, 66 kW	05.99 - 07.06	APA	 3000 845 101  3082 308 043  1878 988 102  3151 248 031	240 26 MF240 240TB KZIS-0		
			 1863 869 005	24	Nadellager / Needle Bearing	(49)
			 6283 600 115			
			 6284 600 573			
2.5 TDI, 70 kW	05.01 - 07.06	BBF	 3000 951 104  3082 600 522  1878 988 102  3151 248 031	240 26 M240 240TB KZIS-0		
			 1863 869 005	24	Nadellager / Needle Bearing	(49)
			 6283 600 115			
			 6284 600 573			
2.5 TDI, 75 kW	06.96 - 08.99	AHD	 3000 828 601  3082 308 043  1864 528 442  3151 248 031	240 26 MF240 240B KZIS-0	->Mot. 047 378 für / for: LT 28/35	(69)
			 3000 845 101  3082 308 043  1878 988 102  3151 248 031	240 26 MF240 240TB KZIS-0	Mot. 047 379-> für / for: LT 28/35	(69)
			 3000 845 101  3082 308 043  1878 988 102  3151 248 031	240 26 MF240 240TB KZIS-0	für / for: LT 46	(69)
			 1863 869 005	24	Nadellager / Needle Bearing	(49)
			 6283 600 115			
			 6284 600 573			
			 6284 600 573			
2.5 TDI, 80 kW	05.99 - 07.06	ANJ	 3000 951 710  3082 600 509  1878 988 102  3151 248 031	240 26 MF240 240TB KZIS-0	->Mot. 052609	
			 3000 951 104  3082 600 522  1878 988 102  3151 248 031	240 26 M240 240TB KZIS-0	Mot. 052610->	
			 3000 951 104  3082 600 522  1878 988 102  3151 248 031	240 26 M240 240TB KZIS-0		
		AVR	 3000 951 104  3082 600 522  1878 988 102  3151 248 031	240 26 M240 240TB KZIS-0		
		AVR, ANJ	 3151 248 031	KZIS-0		
		 1863 869 005	24	Nadellager / Needle Bearing	(49)	
		 6283 600 115				
 6284 600 573						

		CODE				
--	--	------	--	---	---	---

































VOLKSWAGEN

LT 28-46 II Pritsche / Flatbed (2DX0FE) 04.96 - 07.06							
2.8 TDI, 92 kW 2.8 TDI, 96 kW	07.97-01.02 01.99-07.06	ATA, AGK		3000 845 001 ⊗ 3082 919 001 ⊗ 1864 528 442 ⊙ 3151 248 031	240 26 MF240 240B KZIS-0		
				1863 869 005	24	Nadellager / Needle Bearing	(49)
				6283 600 115			
				6284 600 573			
2.8 TDI, 116 kW	04.02-07.06	AUH, BCQ		3000 951 107 ■	240 26	XTend ->Chass. 2D-2-036 000 Nabenprofil / Hub Profile: 26,5x28,9-26N nur in Verbindung mit / only in connection with: 062 105 266 F	
				3000 951 107 ■	240 26	XTend Chass. 2D-2-036 001-> Nabenprofil / Hub Profile: 26,5x28,9-26N	(48) (101)
		AUH		6283 600 115			
		BCQ, AUH		6284 600 573			

LT 40-55 I Kasten / Box (291-512) 04.75 - 06.96							
2.4 2.4 4WD	12.82-07.92 12.82-07.92	DL		3000 055 006 ▲ ⊗ 3082 190 031 ⊗ 1861 897 034 ⊙ 3151 193 041	228 23 M228 228TB KZIS-0		
				1863 869 002	24	Nadellager / Needle Bearing	(49)
				3074 003 343 <small>LHD</small>		08.1989->	
2.4 i	01.93-06.96	1E		3000 055 006 ▲ ⊗ 3082 190 031 ⊗ 1861 897 034 ⊙ 3151 193 041	228 23 M228 228TB KZIS-0		
				1863 869 002	24	Nadellager / Needle Bearing	(49)
				3074 003 343 <small>LHD</small>		->12.1995	
2.4 D, 51 kW 2.4 D, 55 kW 2.4 D 4WD 2.4 TD, 68 kW 2.4 TD, 70 kW 2.4 TD, 75 kW 2.4 TD 4WD	07.90-05.96 01.79-07.92 01.79-03.86 08.88-08.92 06.92-05.96 02.86-08.92 08.78-07.92	DW, ACL, 1S, ACT, DV, CP, 1G		3000 055 005 ⊗ 3082 190 031 ⊗ 1878 004 776 ⊙ 3151 193 041	228 23 M228 220VTPB KZIS-0		





















LT 40-55 I Pritsche / Flatbed (293-909) 04.75 - 06.96							
2.4 i	03.94-06.96	1E		3000 055 006 ▲ ⊗ 3082 190 031 ⊗ 1861 897 034 ⊙ 3151 193 041	228 23 M228 228TB KZIS-0		
				1863 869 002	24	Nadellager / Needle Bearing	(49)
				3074 003 343 <small>LHD</small>		->12.1995	
2.4 D, 51 kW 2.4 D, 55 kW 2.4 TD, 70 kW 2.4 TD, 75 kW	08.90-06.96 12.78-02.91 08.92-06.96 12.82-09.93	ACL, DW, 1S, ACT, DV, CP		3000 055 005 ⊗ 3082 190 031 ⊗ 1878 004 776 ⊙ 3151 193 041	228 23 M228 220VTPB KZIS-0		

VOLVO















F 7		08.78 - 12.85						
F 7	08.78 - 12.85	KF115B	 1882 325 134	380 G380	->Chass. 2162			
			 1878 000 961	380 10 380GTZ	Getr. / GBox: R52			
			 3151 824 005	KZA-4	Getr. / GBox: R52			
			 3400 037 032  3482 021 031  1878 000 961  3151 824 005	380 10 GM380 380GTZ KZA-4	->Chass. 2162			
		KF214C	 1888 019 445 #	350 GF2/350	Chass. 2163->	Getr. / GBox: R52		
			 1878 001 083 ▽	350 10 350GTZ	Getr. / GBox: R52	enthält eine Kupplungsscheibe / This part number includes one clutch disc	(67)	
			 3151 600 533	KZA-4	Getr. / GBox: R52	Lose Kupplungsscheibe / Loose clutch disc	(41)	
			 1859 170 204	350 GF2/350	Getr. / GBox: R52	In 1888 enthalten / Contained in 1888	(31)	
	KF214F	 1800 106 033  1882 250 143  1878 001 080  1878 001 082  3151 106 041  1874 000 098	350 10 GF2/350 350GTZ 350GTZ KZI-5	Getr. / GBox: R/SR62	ohne Zwischenring / without intermediate ring	(106)		
		 1888 019 542 #	350 GF2/350	Getr. / GBox: R/SR62	enthält eine Kupplungsscheibe / This part number includes one clutch disc	(67)		
		 1878 001 082 ▽	350 10 350GTZ	Getr. / GBox: R/SR62	Lose Kupplungsscheibe / Loose clutch disc	(41)		
		 3151 106 041	KZI-5	Getr. / GBox: R/SR62				
		 1859 170 204	350 GF2/350	Getr. / GBox: R/SR62	In 1888 enthalten / Contained in 1888	(31)		
	F 10		08.77 - 12.94					
	Mot. TD 100	01.77 -	KF215L	 1888 015 515 #	380 10 GF2/380	Getr. / GBox: MR62	enthält eine Kupplungsscheibe / This part number includes one clutch disc	(67)
 1878 000 968 ▽				380 10 380GTZ	Getr. / GBox: MR62	Lose Kupplungsscheibe / Loose clutch disc	(41)	
 3151 106 041				KZI-5	Getr. / GBox: MR62			
 1882 280 213				380 GF2/380	Getr. / GBox: MR62	In 1888 enthalten / Contained in 1888	(31)	
 1859 212 000				380 GF2/380	Getr. / GBox: MR62	In 1888 enthalten / Contained in 1888	(31)	
 1878 000 965 △				380 10 380GTZ	Getr. / GBox: MR62	In 1888 enthalten / Contained in 1888	(31)	
KF215K			 1882 280 140	380 GF2/380	Getr. / GBox: MR62B			
			 1859 212 000	380 GF2/380	Getr. / GBox: MR62B			
			 1878 000 965 △	380 10 380GTZ	Getr. / GBox: MR62B			
			 1878 000 968 ▽	380 10 380GTZ	Getr. / GBox: MR62B			
			 3151 106 041	KZI-5	Getr. / GBox: MR62B			

		CODE					
--	--	------	--	--	---	---	---

VOLVO

F 10		08.77 - 12.94					
Mot. TD 100, 101	01.77 -	KF214F, H		1800 106 033 ⊕ 1882 250 143 ⊕ 1878 001 080 ⊕ 1878 001 082 ⊕ 3151 106 041 ⊕ 1874 000 098	350 10 GF2/350 350GTZ 350GTZ KZI-5	Getr. / GBox: R/SR62 ohne Zwischenring / without intermediate ring	(106)
				1888 019 542 #	350 GF2/350	Getr. / GBox: R/SR62 enthält eine Kupplungsscheibe / This part number includes one clutch disc	(67)
				1878 001 082 ▽	350 10 350GTZ	Getr. / GBox: R/SR62	
				3151 106 041	KZI-5	Getr. / GBox: R/SR62	
				1859 170 204	350 GF2/350	Getr. / GBox: R/SR62 In 1888 enthalten / Contained in 1888	(31)
		KF116B		3482 119 032	430 GMF430	Getr. / GBox: R/SR62	
				1878 003 242	420 10 420GTZ	Getr. / GBox: R/SR62	
	3151 105 141		KZI-5	Getr. / GBox: R/SR62			
Mot. TD 101, 102, 103	01.83 -	KFD214A		3400 031 033 ⊕ ⊕ 3483 014 132 ⊕ 1878 001 080 ⊕ 1878 001 082 ⊕ 3474 012 000	350 10 GMFZ2/350 350GTZ 350GTZ	Getr. / GBox: R/SR1400, 1700 ohne Zwischenring / without intermediate ring	(106)
				3488 013 138 ⊕	350 GMFZ2/350	Getr. / GBox: R/SR1400, 1700 enthält eine Kupplungsscheibe / This part number includes one clutch disc	(67)
				1878 001 082 ▽	350 10 350GTZ	Getr. / GBox: R/SR1400, 1700 Lose Kupplungsscheibe / Loose clutch disc	(41)
				3482 056 031	350 GMFZ2/350	Getr. / GBox: R/SR1400, 1700 In 3483/3488 enthalten / Contained in 3483, 3488	(32)
				3459 000 009	350 GMFZ2/350	Getr. / GBox: R/SR1400, 1700	
		KFD117B, C		3400 106 031 ⊕ ⊕ 3483 034 032 ⊕ 1862 530 231	430 10 MFZ430 430WGTZ	Getr. / GBox: R/SR1400, 1700	
				3400 040 032 ●⊕ ⊕ 3483 034 032 ⊕ 1878 004 456	430 10 MFZ430 430GVZ	Getr. / GBox: R/SR1400, 1700	
	3482 123 235		430 MFZ430	Getr. / GBox: R/SR1400, 1700 In 3483/3488 enthalten / Contained in 3483, 3488	(32)		
F 12		08.77 - 12.94					
Mot. TD 120	01.77 -	KF215K		1882 280 140	380 GF2/380	Getr. / GBox: MR62B	
				1859 212 000	380 GF2/380	Getr. / GBox: MR62B	
				1878 000 965 △	380 10 380GTZ	Getr. / GBox: MR62B	
				1878 000 968 ▽	380 10 380GTZ	Getr. / GBox: MR62B	
				3151 106 041	KZI-5	Getr. / GBox: MR62B	

VOLVO

F 12		08.77 - 12.94					
Mot. TD 120, 121	01.77-	KF215D, G	 3400 116 501 #  3482 026 332  1878 006 117  1878 006 035  3151 106 041  1874 000 098	380 10 GTF380 380GTZ 380GTZ KZI-5	Getr. / GBox: R/SR70,71 ohne Zwischenring / without intermediate ring	(106)	
			 1861 996 137 ▽#	380 10 380GVZ	Getr. / GBox: R/SR70,71 Lose Kupplungsscheibe / Loose clutch disc	(41)	
			 3151 106 041	KZI-5	Getr. / GBox: R/SR70,71		
			 3459 004 108	380 GTF2/380	Getr. / GBox: R/SR70,71 In 3488 enthalten / Contained in 3488	(33)	
		KF215F	 1888 015 515 #	380 10 GF2/380	Getr. / GBox: SR62 Getr. / GBox: R/SR70 enthält eine Kupplungsscheibe / This part number includes one clutch disc	(67)	
			 1878 000 968 ▽	380 10 380GTZ	Getr. / GBox: SR62 Getr. / GBox: R/SR70 Lose Kupplungsscheibe / Loose clutch disc	(41)	
			 3151 106 041	KZI-5	Getr. / GBox: SR62		
			 1882 280 213	380 GF2/380	Getr. / GBox: SR62 Getr. / GBox: R/SR70 In 1888 enthalten / Contained in 1888	(31)	
			 1859 212 000	380 GF2/380	Getr. / GBox: SR62 Getr. / GBox: R/SR70 In 1888 enthalten / Contained in 1888	(31)	
			 1878 000 965 △	380 10 380GTZ	Getr. / GBox: SR62 Getr. / GBox: R/SR70 In 1888 enthalten / Contained in 1888	(31)	

































VOLVO























F 12		08.77 - 12.94				
Mot. TD 121, 122, 123	01.83-	KFD214A	3400 031 033 ⊕ 3483 014 132 1878 001 080 1878 001 082 3474 012 000	350 10 GMFZ2/350 350GTZ 350GTZ	Getr. / GBox: R/SR1400, 1700 ohne Zwischenring / without intermediate ring	(106)
			3488 013 138 ⊕	350 GMFZ2/350	Getr. / GBox: R/SR1400, 1700 enthält eine Kupplungsscheibe / This part number includes one clutch disc	(67)
			1878 001 082 ▽	350 10 350GTZ	Getr. / GBox: R/SR1400, 1700 Lose Kupplungsscheibe / Loose clutch disc	(41)
			3482 056 031	350 GMFZ2/350	Getr. / GBox: R/SR1400, 1700 In 3483/3488 enthalten / Contained in 3483, 3488	(32)
			3459 000 009	350 GMFZ2/350	Getr. / GBox: R/SR1400, 1700 In 3483/3488 enthalten / Contained in 3483, 3488	(32)
			3100 026 432 3151 000 154 3180 001 008	KZIZ-5 KZISZ-5	Getr. / GBox: R/SR1400, 1700 Beinhaltet Ausrücker und Montagesatz / Contains releaser and fitting kit für Membranfederinnendurchmesser 100mm / for diaphragm spring inside diameter 100mm	(9) (78)
		KFD215A	3400 030 033 #⊕ 3483 017 031 1878 006 117 1878 006 035 3474 012 001	380 10 GMFZ2/380 380GTZ 380GTZ	Getr. / GBox: R/SR1400, 1700 ohne Zwischenring / without intermediate ring	(106)
			3482 059 031	380 GMFZ2/380	Getr. / GBox: R/SR1400, 1700 In 3483/3488 enthalten / Contained in 3483, 3488	(32)
			3459 010 101	380 GMFZ2/380	Getr. / GBox: R/SR1400, 1700 In 3483/3488 enthalten / Contained in 3483, 3488	(32)
			3100 026 432 3151 000 154 3180 001 008	KZIZ-5 KZISZ-5	Getr. / GBox: R/SR1400, 1700 Beinhaltet Ausrücker und Montagesatz / Contains releaser and fitting kit für Membranfederinnendurchmesser 100mm / for diaphragm spring inside diameter 100mm	(9) (78)
			3488 019 032 ⊕ 3483 027 332 3459 017 031 1862 248 033 3100 026 432	380 GMFZ2/380 GMFZ2/380 380GVZ KZIZ-5	Getr. / GBox: R/SR1400, 1700 enthält eine Kupplungsscheibe / This part number includes one clutch disc	(67)
			1862 415 031 ▽	380 10 380WGVZ	Getr. / GBox: R/SR1400, 1700 Lose Kupplungsscheibe / Loose clutch disc	(41)
			3483 027 332 ⊕	380 GMFZ2/380	Getr. / GBox: R/SR1400, 1700 In 3483/3488 enthalten / Contained in 3483, 3488	(32)
			3482 111 032	380 GMFZ2/380	Getr. / GBox: R/SR1400, 1700 In 3483/3488 enthalten / Contained in 3483, 3488	(32)
3459 017 031	380 GMFZ2/380	Getr. / GBox: R/SR1400, 1700 In 3488 enthalten / Contained in 3488	(33)			
1862 248 033 △	380 8 380GVZ	Getr. / GBox: R/SR1400, 1700 In 3488 enthalten / Contained in 3488	(33)			
Mot. TD 122, 123	01.87-	KFD117D	3400 043 032 ⊕ 3483 034 033 1878 634 026	430 10 MFZ430 430WGTZ	Getr. / GBox: R/SR1400, 1700	
			3482 123 234	430 MFZ430	Getr. / GBox: R/SR1400, 1700 In 3483/3488 enthalten / Contained in 3483, 3488	(32)
F 12/360	01.88 - 12.90	KFD117D	3400 700 426 ⊕ 3488 019 031 1862 415 031	380 10 GMFZ2/380 380WGVZ	Getr. / GBox: R/SR1400, 1700	
F 12/360	10.90 - 12.94	KFD217D	3400 043 032 ⊕ 3483 034 033 1878 634 026	430 10 MFZ430 430WGTZ	Getr. / GBox: R/SR1400, 1700	
F 12/360	12.90 - 12.94					
F 12/360	01.91 - 12.94					
F 12/370	08.77 - 12.86					
F 12/400	01.88 - 12.90					
F 12/400	12.90 - 12.94					
F 12/400,F 12/410	01.88 - 12.94					
F 12/400,F 12/410	12.90 - 12.94					

		CODE				
--	--	------	--	---	---	---

VOLVO







F 16		10.87 - 12.94				
Mot. TD 162, 163	01.87-	KFD216A	 3400 116 301  3482 071 131  2878 087 241 x  3100 026 432  3474 012 003	400 10 GMFZ2/400 400GTZ KZIZ-5	->Chass. 382112 Getr. / GBox: SR2000 ohne Zwischenring / without intermediate ring	(106)
			 3488 016 031	400 GMFZ2/ 400GTZ	->Chass. 382112 Getr. / GBox: SR2000 enthält eine Kupplungsscheibe / This part number includes one clutch disc	(67)
			 1878 087 241	400 10 400GTZ	->Chass. 382112 Getr. / GBox: SR2000 Lose Kupplungsscheibe / Loose clutch disc	(41)
			 3459 012 131	400 GMFZ2/400	->Chass. 382112 Getr. / GBox: SR2000 In 3483/3488 enthalten / Contained in 3483, 3488	(32)
			 3100 026 432  3151 000 154  3180 001 008	KZIZ-5 KZISZ-5	->Chass. 382112 Getr. / GBox: SR2000 Beinhaltet Ausrücker und Montagesatz / Contains releaser and fitting kit für Membranfederinnendurchmesser 100mm / for diaphragm spring inside diameter 100mm	(9) (78)
Mot. TD 162, 163		KFD216A	 3488 018 031 ⊕	400 GMFZ2/400	Chass. 382113-> Getr. / GBox: SR2000 enthält eine Kupplungsscheibe / This part number includes one clutch disc	(67)
			 1878 002 458 ▽	400 10 400WGTZ	Chass. 382113-> Getr. / GBox: SR2000 Lose Kupplungsscheibe / Loose clutch disc	(41)
			 3482 110 031	400 GMFZ2/400	Chass. 382113-> Getr. / GBox: SR2000 In 3488 enthalten / Contained in 3488	(33)
			 3459 016 031	400 GMFZ2/400	Chass. 382113-> Getr. / GBox: SR2000 In 3488 enthalten / Contained in 3488	(33)
			 1878 002 460 △	400 10 400GTZ	Chass. 382113-> Getr. / GBox: SR2000 In 3483/3488 enthalten / Contained in 3483, 3488	(32)
			 3100 026 432  3151 000 154  3180 001 008	KZIZ-5 KZISZ-5	Chass. 382113-> Getr. / GBox: SR2000 Beinhaltet Ausrücker und Montagesatz / Contains releaser and fitting kit für Membranfederinnendurchmesser 100mm / for diaphragm spring inside diameter 100mm	(9) (78)
F 86						
F 86			 1882 325 134	380 G380	Mot. TD 70 B, E Getr. / GBox: R 51	
			 3151 824 005	KZA-4	Mot. TD 70 B, E Getr. / GBox: R 51	
F 86 über 32 t Gesamtgewicht / from 32t total weight			 1800 125 001  1882 250 143  1878 001 079  1878 001 083  3151 600 533  1874 000 098	350 10 GF2/350 350GTZ 350GTZ KZA-4	Mot. TD 70, E, EF ohne Zwischenring / without intermediate ring	(106)
			 1888 019 445 #	350 GF2/350	Mot. TD 70, E, EF enthält eine Kupplungsscheibe / This part number includes one clutch disc	(67)
			 1878 001 083	350 10 350GTZ	Mot. TD 70, E, EF Lose Kupplungsscheibe / Loose clutch disc	(41)
			 3151 600 533	KZA-4	Mot. TD 70, E, EF	
			 1859 170 204	350 GF2/350	Mot. TD 70, E, EF In 1888 enthalten / Contained in 1888	(31)







VOLVO







F 88							
F 88		<u>1878 000 967</u> ▾	380 10 380GTZ	Mot. TD 100 A Getr. / GBox: MR61 Lose Kupplungsscheibe / Loose clutch disc	(41)		
		<u>3151 106 041</u>	KZI-5	Mot. TD 100 A Getr. / GBox: MR61			
		1882 280 213	380 GF2/380	Mot. TD 100 A Getr. / GBox: MR61 In 1888 enthalten / Contained in 1888	(31)		
		1859 212 000	380 GF2/380	Mot. TD 100 A Getr. / GBox: MR61 In 1888 enthalten / Contained in 1888	(31)		
		1878 000 964 △	380 10 380GTZ	Mot. TD 100 A Getr. / GBox: MR61 In 1888 enthalten / Contained in 1888	(31)		
		1888 019 445 #	350 GF2/350	Mot. TD 100, B Getr. / GBox: R 61, SR 61 enthält eine Kupplungsscheibe / This part number includes one clutch disc	(67)		
		<u>1878 001 083</u> ▾	350 10 350GTZ	Mot. TD 100, B Getr. / GBox: R 61, SR 61 Lose Kupplungsscheibe / Loose clutch disc	(41)		
		<u>3151 106 041</u>	KZI-5	Mot. TD 100, B Getr. / GBox: R 61, SR 61			
		1882 250 143	350 GF2/350	Mot. TD 100, B Getr. / GBox: R 61, SR 61 In 1888 enthalten / Contained in 1888	(31)		
		1859 170 204	350 GF2/350	Mot. TD 100, B Getr. / GBox: R 61, SR 61 In 1888 enthalten / Contained in 1888	(31)		
		1878 001 079 △	350 10 350GTZ	Mot. TD 100, B Getr. / GBox: R 61, SR 61 In 1888 enthalten / Contained in 1888	(31)		
		1800 125 601 # ● 1882 226 533 ● 1878 006 951 ● 3151 105 141	420 G420 420GTZ KZI-5	Mot. T 100 A, B; TD 100 A			
	F 88 6x2 LHD		<u>1878 000 967</u> ▾	380 10 380GTZ	Chass. 33995 - Chass. 46790 Mot. TD 100 A Getr. / GBox: R61, SR61 Lose Kupplungsscheibe / Loose clutch disc	(41)	
			<u>3151 106 041</u>	KZI-5	Chass. 33995 - Chass. 46790 Mot. TD 100 A Getr. / GBox: R61, SR61		
		1882 280 213	380 GF2/380	Chass. 33995 - Chass. 46790 Mot. TD 100 A Getr. / GBox: R61, SR61 In 1888 enthalten / Contained in 1888	(31)		
		1859 212 000	380 GF2/380	Chass. 33995 - Chass. 46790 Mot. TD 100 A Getr. / GBox: R61, SR61 In 1888 enthalten / Contained in 1888	(31)		
		1878 000 964 △	380 10 380GTZ	Chass. 33995 - Chass. 46790 Mot. TD 100 A Getr. / GBox: R61, SR61 In 1888 enthalten / Contained in 1888	(31)		
		1888 019 445 #	350 GF2/350	Chass. 46791-> für / for: 6x2, 6x4 RHD Mot. TD 100 A enthält eine Kupplungsscheibe / This part number includes one clutch disc	(69)	(67)	
		<u>1878 001 083</u> ▾	350 10 350GTZ	Chass. 46791-> für / for: 6x2, 6x4 RHD Mot. TD 100 A Lose Kupplungsscheibe / Loose clutch disc	(69)	(41)	
		<u>3151 106 041</u>	KZI-5	Chass. 46791-> für / for: 6x2, 6x4 RHD Mot. TD 100 A	(69)		
		1882 250 143	350 GF2/350	Chass. 46791-> für / for: 6x2, 6x4 RHD Mot. TD 100 A In 1888 enthalten / Contained in 1888	(69)	(31)	
		1859 170 204	350 GF2/350	Chass. 46791-> für / for: 6x2, 6x4 RHD Mot. TD 100 A In 1888 enthalten / Contained in 1888	(69)	(31)	
		1878 001 079 △	350 10 350GTZ	Chass. 46791-> für / for: 6x2, 6x4 RHD	(69)		

		CODE				
--	--	------	--	---	---	---

VOLVO























F 88						
F 88 6x2,6x4 RHD		<u>1878 000 967</u> ▾	380 10 380GTZ	Chass. 33995 - Chass. 40395 Chass. 42121 - Chass. 46790 Mot. TD 100 A Getr. / GBox: R61, SR61 Lose Kupplungsscheibe / Loose clutch disc	(41)	
		<u>3151 106 041</u>	KZI-5	Chass. 33995 - Chass. 40395 Chass. 42121 - Chass. 46790 Mot. TD 100 A Getr. / GBox: R61, SR61		
		1882 280 213	380 GF2/380	Chass. 33995 - Chass. 40395 Chass. 42121 - Chass. 46790 Mot. TD 100 A Getr. / GBox: R61, SR61 In 1888 enthalten / Contained in 1888	(31)	
		1859 212 000	380 GF2/380	Chass. 33995 - Chass. 40395 Chass. 42121 - Chass. 46790 Mot. TD 100 A Getr. / GBox: R61, SR61 In 1888 enthalten / Contained in 1888	(31)	
		1878 000 964 △	380 10 380GTZ	Chass. 33995 - Chass. 40395 Chass. 42121 - Chass. 46790 Mot. TD 100 A Getr. / GBox: R61, SR61 In 1888 enthalten / Contained in 1888	(31)	
F 88 T		1800 125 601 # ⊗ 1882 226 533 ⊗ 1878 006 951 ◊ 3151 105 141	420 G420 420GTZ KZI-5	Chass. 254 - Chass. 269 Chass. 271 - Chass. 298 Chass. 329-> Mot. T 100 A, B; TD 100 A		

F 89						
F 89		1800 125 601 # ⊗ 1882 226 533 ⊗ 1878 006 951 ◊ 3151 105 141	420 G420 420GTZ KZI-5	Mot. TD 110, 120 A		
		<u>1878 000 967</u> ▾	380 10 380GTZ	Mot. TD 120 A Lose Kupplungsscheibe / Loose clutch disc	(41)	
		<u>3151 106 041</u>	KZI-5	Mot. TD 120 A		
		1882 280 213	380 GF2/380	Mot. TD 120 A In 1888 enthalten / Contained in 1888	(31)	
		1859 212 000	380 GF2/380	Mot. TD 120 A In 1888 enthalten / Contained in 1888	(31)	
		1878 000 964 △	380 10 380GTZ	Mot. TD 120 A In 1888 enthalten / Contained in 1888	(31)	





















FB - Serie						
FB 86		1882 325 134	380 G380	Mot. TD 70 B, E Getr. / GBox: R 51		
		3151 824 005	KZA-4	Mot. TD 70 B, E Getr. / GBox: R 51		
FB 86 über 32 t Gesamtgewicht / from 32t total weight		1800 125 001 ⊗ 1882 250 143 ⊗ 1878 001 079 ⊗ 1878 001 083 ◊ 3151 600 533 ⊖ 1874 000 098	350 10 GF2/350 350GTZ 350GTZ KZA-4	Mot. TD 70, E, EF ohne Zwischenring / without intermediate ring	(106)	
		<u>1888 019 445</u> #	350 GF2/350	Mot. TD 70, E, EF enthält eine Kupplungsscheibe / This part number includes one clutch disc	(67)	
		<u>1878 001 083</u> ▾	350 10 350GTZ	Mot. TD 70, E, EF Lose Kupplungsscheibe / Loose clutch disc	(41)	
		<u>3151 600 533</u>	KZA-4	Mot. TD 70, E, EF		
		1859 170 204	350 GF2/350	Mot. TD 70, E, EF In 1888 enthalten / Contained in 1888	(31)	

VOLVO

FB - Serie

FB 88			1888 019 445 #	350 GF2/350	Mot. TD 100, B Getr. / GBox: R 61, SR 61 enthält eine Kupplungsscheibe / This part number includes one clutch disc (67)
			1878 001 083 ▾	350 10 350GTZ	Mot. TD 100, B Getr. / GBox: R 61, SR 61 Lose Kupplungsscheibe / Loose clutch disc (41)
			3151 106 041	KZI-5	Mot. TD 100, B Getr. / GBox: R 61, SR 61
			1882 250 143	350 GF2/350	Mot. TD 100, B Getr. / GBox: R 61, SR 61 In 1888 enthalten / Contained in 1888 (31)
			1859 170 204	350 GF2/350	Mot. TD 100, B Getr. / GBox: R 61, SR 61 In 1888 enthalten / Contained in 1888 (31)
			1878 001 079 △	350 10 350GTZ	Mot. TD 100, B Getr. / GBox: R 61, SR 61 In 1888 enthalten / Contained in 1888 (31)
				1800 125 601 #  1882 226 533  1878 006 951  3151 105 141	420 G420 420GTZ KZI-5
FB 88 T			1800 125 601 #  1882 226 533  1878 006 951  3151 105 141	420 G420 420GTZ KZI-5	Mot. T 100A, B ;TD 100A Getr. / GBox: R 61, SR 61
FB 89			1800 125 601 #  1882 226 533  1878 006 951  3151 105 141	420 G420 420GTZ KZI-5	Mot. TD 110, 120 A
			1878 000 967 ▾	380 10 380GTZ	Mot. TD 120 A Lose Kupplungsscheibe / Loose clutch disc (41)
			3151 106 041	KZI-5	Mot. TD 120 A
			1882 280 213	380 GF2/380	Mot. TD 120 A In 1888 enthalten / Contained in 1888 (31)
			1859 212 000	380 GF2/380	Mot. TD 120 A In 1888 enthalten / Contained in 1888 (31)
		1878 000 964 △	380 10 380GTZ	Mot. TD 120 A In 1888 enthalten / Contained in 1888 (31)	

FE 05.06 -

FE 240-18	05.06-			3400 710 060  3482 001 307  1878 003 867  6482 000 155	430 24 MF430 430WGTZ PHIS-6/38	Getr. / GBox: AT 2412 D
FE 240-18	05.06-			1863 869 039	52	
FE 240-22	05.06-					
FE 240-26	05.06-					
FE 240-26	05.06-	CS39A-O		3400 700 466   3482 634 003  1878 634 034  3151 000 752	395 10 MF395 395WGTZ KZIS-4	Getr. / GBox: ZTO 1006 / ZTO 1109
FE 260-18	05.06-					
FE 260-26	05.06-					
FE 280-18	05.06-					
FE 280-22	05.06-					
FE 280-26	05.06-					
FE 300-18	05.06-					
FE 300-26	05.06-					
FE 340-18	05.06-					
FE 340-26	05.06-					
FE 320-18	05.06-			3400 710 060  3482 001 307  1878 003 867  6482 000 155	430 24 MF430 430WGTZ PHIS-6/38	Getr. / GBox: AT 2412 D
FE 320-22	05.06-			1863 869 039	52	
FE 320-26	05.06-	CS39A-O		3400 700 490   3482 634 005  1878 634 038  3151 000 809	395 10 MF395 395WGTZ KZIS-4	Getr. / GBox: ZTO 1006 / ZTO 1109









VOLVO













FE II		05.12 -				
FE 240-18	05.12-		3400 710 067 3482 001 307 1878 006 584 6482 000 155	430 24 MF430 430WGTZ PHIS-6/38	Getr. / GBox: AT 2412 F	
FE 240-26	05.12-					
FE 260-18	05.12-					
FE 260-26	05.12-		1863 869 039	52		
FE 280-18	05.12-	CS39A-O	3400 700 466	395 10 MF395 395WGTZ KZIS-4	Getr. / GBox: ZTO 1006 / ZTO 1109	
FE 280-26	05.12-		3482 634 003 1878 634 034 3151 000 752			
FE 250-18	05.12-		3400 700 466	395 10 MF395 395WGTZ KZIS-4	Getr. / GBox: 6S 1000	
FE 250-26	05.12-		3482 634 003 1878 634 034 3151 000 752			
FE 280-18	05.12-					
FE 280-26	05.12-			3400 700 628	395 10 MF395 395WGTZ KZIS-4	Getr. / GBox: 6AS 1000 TO
FE 320-18	05.12-		3482 634 003 1878 007 939 3151 000 752			
FE 320-26	05.12-		1863 869 039	52		
			3189 600 045		Getr. / GBox: 6AS 800 / 1000 TO Getr. / GBox: ZF 6S/6AS-800/1000	
FE 280-26	05.12-		3400 700 628	395 10 MF395 395WGTZ KZIS-4	Getr. / GBox: 6AS 1000 TO	
FE 300-18	05.12-		3482 634 003 1878 007 939 3151 000 752			
			1863 869 039	52		
			3189 600 045		Getr. / GBox: 6AS 800 / 1000 TO Getr. / GBox: ZF 6S/6AS-800/1000	
		CS39A-O	3400 700 466	395 10 MF395 395WGTZ KZIS-4	Getr. / GBox: 6S 1000	
			3482 634 003 1878 634 034 3151 000 752			
FE 300-26	05.12-		3400 710 060	430 24 MF430 430WGTZ PHIS-6/38	Getr. / GBox: AT 2412 D	
			3482 001 307 1878 003 867 6482 000 155			
			1863 869 039	52		
			3189 600 045		Getr. / GBox: 6AS 800 / 1000 TO Getr. / GBox: ZF 6S/6AS-800/1000	
		CS39A-O	3400 700 466	395 10 MF395 395WGTZ KZIS-4	Getr. / GBox: ZTO 1006 / ZTO 1109	
			3482 634 003 1878 634 034 3151 000 752			
FE 320-18	05.12-		3400 700 466	395 10 MF395 395WGTZ KZIS-4	Getr. / GBox: ZTO 1006 / 6S 1000	
			3482 634 003 1878 634 034 3151 000 752			
				3400 700 628	395 10 MF395 395WGTZ KZIS-4	Getr. / GBox: 6AS 1000 TO
			3482 634 003 1878 007 939 3151 000 752			
			1863 869 039	52		
			3189 600 045		Getr. / GBox: 6AS 800 / 1000 TO Getr. / GBox: ZF 6S/6AS-800/1000	
FE 340-18	05.12-		3400 710 060	430 24 MF430 430WGTZ PHIS-6/38	Getr. / GBox: AT 2412 D	
			3482 001 307 1878 003 867 6482 000 155			
			1863 869 039	52		
		CS39A-O	3400 700 466	395 10 MF395 395WGTZ KZIS-4	Getr. / GBox: 6S 1000	
			3482 634 003 1878 634 034 3151 000 752			
FE 340-26	05.12-		3400 710 060	430 24 MF430 430WGTZ PHIS-6/38	Getr. / GBox: AT 2412 D	
			3482 001 307 1878 003 867 6482 000 155			
			1863 869 039	52		
		CS39A-O	3400 700 466	395 10 MF395 395WGTZ KZIS-4	Getr. / GBox: ZTO 1006 / ZTO 1109	
			3482 634 003 1878 634 034 3151 000 752			

		CODE				
--	--	------	--	---	---	---

VOLVO















FE 6							
Mot. TD 61	01.85-	KB114B		3400 116 201 # ⊕ 3482 909 001 ⊕ 1878 076 031 ⊕ 3151 600 535	350 10 MF350 350GTB KZA-4	Getr. / GBox: S5-35	
		KB114C		3400 116 101 # ⊕ 3482 909 001 ⊕ 1862 974 002 ⊕ 3151 600 534	350 10 MF350 350CPB KZA-4	Getr. / GBox: S5-65	
		KB115C		3400 037 031 ⊕ 3482 021 031 ⊕ 1878 000 961 ⊕ 3151 600 533	380 10 GM380 380GTZ KZA-4	Getr. / GBox: S5-65	

FE 7							
Mot. TD 71, 73	01.85-	KFD117A		3400 035 032 #⊕ ⊕ 3483 034 032 ⊕ 1861 988 034	430 10 MFZ430 430GVZ	Getr. / GBox: R52B	
				3482 123 235	430 MFZ430	Getr. / GBox: R52B In 3483/3488 enthalten / Contained in 3483, 3488	(32)
		KFD117B		3400 040 032 ⊕ ⊕ 3483 034 032 ⊕ 1878 004 456	430 10 MFZ430 430GVZ	Getr. / GBox: R1000	
				3482 123 235	430 MFZ430	Getr. / GBox: R1000 In 3483/3488 enthalten / Contained in 3483, 3488	(32)

FH 09.05 -							
400	09.05-	CS43B-O/OR		3400 700 463 ⊕ ⊕ 3483 000 348 ⊕ 1878 006 129	430 24 MFZ430 430WGTZ	Mot. D13A400, D13B400 Getr. / GBox: VT2214B, VT2514B Getr. / GBox: VTO2214B, VTO2514B Euro 5 / Euro 5	(17)
				1863 869 037	72	Mot. D13A400, D13B400 Getr. / GBox: VT2214B, VT2514B Getr. / GBox: VTO2214B, VTO2514B	
				3400 700 618 ●⊕ ⊕ 3482 001 308 ⊕ 1878 007 046	430 24 MF430 430WGTZ	Mot. D13A400, D13B400 Getr. / GBox: AT2412C, AT2512C, Getr. / GBox: ATO2512C Euro 6 / Euro 6	(18)
				3400 700 478 ⊕ ⊕ 3483 000 382 ⊕ 1878 006 129	430 24 MFZ430 430WGTZ	Mot. D13A400, D13B400 Getr. / GBox: VT2009B Euro 5 / Euro 5	(17)
				1863 869 037	72	Mot. D13A400, D13B400 Getr. / GBox: VT2009B	
		CD38B-O		3400 700 348 ⊕ ⊕ 3488 019 032 ⊕ 1878 001 216	380 24 GMFZ2/380 380WGVZ	Mot. D13A400, D13B400	
				1863 869 037	72	Mot. D13A400, D13B400	
		CD40B-O, CL39D-C		3400 700 360 ⊕ ⊕ 3488 000 159 ⊕ 1878 003 768	400 24 MFZ2/400X 400WGTZ	Mot. D13A400, D13B400 für Fahrzeuge mit Zweis Scheibenkupplung / for vehicles with double disc clutch	(77)
				3189 600 061			
		420	01.09-			3400 700 600 ⊕ ⊕ 3483 000 348 ⊕ 1878 007 046	430 24 MFZ430 430WGTZ
	3400 710 064 ⊕ 3482 001 310 ⊕ 1878 007 170 ⊕ 6482 000 155				430 24 MF430 430WGTZ PHIS-6/38	Mot. D13C Getr. / GBox: AT 2412/E / AT 2612/E Getr. / GBox: ATO 2612/E Euro 6 / Euro 6	(18)
CD40B-O				3400 700 629 ⊕ ⊕ 3488 000 373 ⊕ 1878 007 366	400 24 MFZ2/400X 400WGTZ	Getr. / GBox: VT 2214B / VTO 2214B Getr. / GBox: VT 2514B / VTO 2514B Getr. / GBox: VT 2814B / VTO 2814B für Fahrzeuge mit Zweis Scheibenkupplung / for vehicles with double disc clutch mit Zwischenring / with intermediate ring	(77) (94)























		CODE				
--	--	------	--	---	---	---

VOLVO

FH		09.05 -					
440	09.05-	CS43B-O/OR	 3400 700 463 ⊕ ⊗ 3483 000 348 ⊗ 1878 006 129	430 24 MFZ430 430WGTZ	Mot. D13A440, D13B440 Getr. / GBox: VT2214B, VT2514B Getr. / GBox: VTO2214B, VTO2514B Euro 5 / Euro 5	(17)	
440	09.05-		 3400 710 061 # ⊗ 3482 000 553 ⊗ 1878 007 046 ⚡ 6482 000 155	430 24 MF430 430WGTZ PHIS-6/38	Mot. D13A440, D13B440 Getr. / GBox: AT2412C, AT2512C Getr. / GBox: ATO2512C Euro 5 / Euro 5	(17)	
440	09.05-		 3400 710 066 ● ⊗ 3482 001 308 ⊗ 1878 007 046 ⚡ 6482 000 155	430 24 MF430 430WGTZ PHIS-6/38	Mot. D13A440, D13B440 Getr. / GBox: AT2412C, AT2512C Getr. / GBox: ATO2512C Euro 6 / Euro 6	(18)	
440	09.06 - 12.11		 1863 869 037	72	Mot. D13A440, D13B440 Getr. / GBox: AT2412C, AT2512C Getr. / GBox: ATO2512C		
		CD38B-O	 3400 700 348 ⊕ ⊗ 3488 019 032 ⊗ 1878 001 216	380 24 GMFZ2/380 380WGVZ	Mot. D13A440, D13B440 für Fahrzeuge mit Zweischeibenkupplung / for vehicles with double disc clutch	(77)	
			 1863 869 037	72	Mot. D13A440, D13B440 für Fahrzeuge mit Zweischeibenkupplung / for vehicles with double disc clutch	(77)	
		CD40B-O, CL39D-C	 3400 700 360 ⊕ ⊗ 3488 000 159 ⊗ 1878 003 768	400 24 MFZ2/400X 400WGTZ	Mot. D13A440, D13B440 für Fahrzeuge mit Zweischeibenkupplung / for vehicles with double disc clutch	(77)	
			 1863 869 037	72	Mot. D13A440, D13B440 für Fahrzeuge mit Zweischeibenkupplung / for vehicles with double disc clutch	(77)	
			 3189 600 061				
460	01.09-		 3400 700 600 ⊕ ⊗ 3483 000 348 ⊗ 1878 007 046	430 24 MFZ430 430WGTZ	Mot. D13C Getr. / GBox: VT 2514B / VTO 2514B Getr. / GBox: VT 2814B / VTO 2814B Euro 6 / Euro 6	(18)	
460	01.12-		 3400 710 064 ⊗ 3482 001 310 ⊗ 1878 007 170 ⚡ 6482 000 155	430 24 MF430 430WGTZ PHIS-6/38	Mot. D13C Getr. / GBox: AT 2412/E / AT 2612/E Getr. / GBox: ATO 2612/E Euro 6 / Euro 6	(18)	
460	05.12-		CD40B-O	 3400 700 629 ⊕ ⊗ 3488 000 373 ⊗ 1878 007 366	400 24 MFZ2/400X 400WGTZ	Getr. / GBox: VT 2214B / VTO 2214B Getr. / GBox: VT 2514B / VTO 2514B Getr. / GBox: VT 2814B / VTO 2814B für Fahrzeuge mit Zweischeibenkupplung / for vehicles with double disc clutch mit Zwischenring / with intermediate ring	(77) (94)
460			 3400 700 600 ⊕ ⊗ 3483 000 348 ⊗ 1878 007 046	430 24 MFZ430 430WGTZ	Mot. D13K Getr. / GBox: VT 2814B / VTO 2814B Euro 6 / Euro 6	(18)	
			 3400 710 064 ⊗ 3482 001 310 ⊗ 1878 007 170 ⚡ 6482 000 155	430 24 MF430 430WGTZ PHIS-6/38	Mot. D13K Getr. / GBox: AT 2412/E / AT 2612/E Getr. / GBox: ATO 2612/E Euro 6 / Euro 6	(18)	











		CODE				
--	--	------	--	---	---	---















































VOLVO

FH		09.05 -					
480 480	09.05- 09.06 - 12.11	CS43B-O/OR		3400 700 463 ⊕ 3483 000 348 1878 006 129	430 24 MFZ430 430WGTZ	Mot. D13A480 Getr. / GBox: VT2214B, VT2514B Getr. / GBox: VTO2214B, VTO2514B Euro 5 / Euro 5	(17)
				3400 710 061 # 3482 000 553 1878 007 046 6482 000 155	430 24 MF430 430WGTZ PHIS-6/38	Mot. D13A480 Getr. / GBox: AT2412C, AT2512C Getr. / GBox: ATO2512C Euro 5 / Euro 5	(17)
				3400 710 066 ● 3482 001 308 1878 007 046 6482 000 155	430 24 MF430 430WGTZ PHIS-6/38	Mot. D13A480 Getr. / GBox: AT2412C, AT2512C Getr. / GBox: ATO2512C Euro 6 / Euro 6	(18)
				1863 869 037	72	Mot. D13A480 Getr. / GBox: AT2412C, AT2512C Getr. / GBox: ATO2512C	
	CD38B-O		3400 700 348 ⊕ 3488 019 032 1878 001 216	380 24 GMFZ2/380 380WGVZ	Mot. D13A480 für Fahrzeuge mit Zweischeibenkupplung / for vehicles with double disc clutch	(77)	
			1863 869 037	72	Mot. D13A480 für Fahrzeuge mit Zweischeibenkupplung / for vehicles with double disc clutch	(77)	
	CD40B-O, CL39D-C		3400 700 360 ⊕ 3488 000 159 1878 003 768	400 24 MFZ2/400X 400WGTZ	Mot. D13A480 für Fahrzeuge mit Zweischeibenkupplung / for vehicles with double disc clutch	(77)	
			1863 869 037	72	Mot. D13A480 für Fahrzeuge mit Zweischeibenkupplung / for vehicles with double disc clutch	(77)	
				3189 600 061			
	500 500 500	09.05- 09.05- 09.07-	CD40B-O		3400 700 629 ⊕ 3488 000 373 1878 007 366	400 24 MFZ2/400X 400WGTZ	Getr. / GBox: VT 2214B / VTO 2214B Getr. / GBox: VT 2514B / VTO 2514B Getr. / GBox: VT 2814B / VTO 2814B für Fahrzeuge mit Zweischeibenkupplung / for vehicles with double disc clutch mit Zwischenring / with intermediate ring
500 500	01.09- 01.09-			3400 700 600 ⊕ 3483 000 348 1878 007 046	430 24 MFZ430 430WGTZ	Mot. D13C Getr. / GBox: VT 2514B / VTO 2514B Getr. / GBox: VT 2814B / VTO 2814B Euro 6 / Euro 6	(18)
				3400 710 064 3482 001 310 1878 007 170 6482 000 155	430 24 MF430 430WGTZ PHIS-6/38	Mot. D13C Getr. / GBox: AT2612/E / ATO2612/E Euro 6 / Euro 6	(18)
	CD40B-O		3400 700 629 ⊕ 3488 000 373 1878 007 366	400 24 MFZ2/400X 400WGTZ	Getr. / GBox: VT 2214B / VTO 2214B Getr. / GBox: VT 2514B / VTO 2514B Getr. / GBox: VT 2814B / VTO 2814B für Fahrzeuge mit Zweischeibenkupplung / for vehicles with double disc clutch mit Zwischenring / with intermediate ring	(77) (94)	
520	09.05-	CS43B-O/OR		3400 700 463 ⊕ 3483 000 348 1878 006 129	430 24 MFZ430 430WGTZ	Mot. D13A520 Getr. / GBox: VT2214B, VT2514B Getr. / GBox: VTO2214B, VTO2514B Euro 5 / Euro 5	(17)
				3400 710 061 # 3482 000 553 1878 007 046 6482 000 155	430 24 MF430 430WGTZ PHIS-6/38	Mot. D13A520 Getr. / GBox: AT2412C, AT2512C Getr. / GBox: ATO2512C Euro 5 / Euro 5	(17)
				3400 710 066 ● 3482 001 308 1878 007 046 6482 000 155	430 24 MF430 430WGTZ PHIS-6/38	Mot. D13A520 Getr. / GBox: AT2412C, AT2512C Getr. / GBox: ATO2512C Euro 6 / Euro 6	(18)
				1863 869 037	72	Mot. D13A520 Getr. / GBox: AT2412C, AT2512C Getr. / GBox: ATO2512C	
	CD38B-O		3400 700 348 ⊕ 3488 019 032 1878 001 216	380 24 GMFZ2/380 380WGVZ	Mot. D13A520 für Fahrzeuge mit Zweischeibenkupplung / for vehicles with double disc clutch	(77)	
			1863 869 037	72	Mot. D13A520 für Fahrzeuge mit Zweischeibenkupplung / for vehicles with double disc clutch	(77)	
	CD40B-O, CL39D-C		3400 700 360 ⊕ 3488 000 159 1878 003 768	400 24 MFZ2/400X 400WGTZ	Mot. D13A520 für Fahrzeuge mit Zweischeibenkupplung / for vehicles with double disc clutch	(77)	
			1863 869 037	72	Mot. D13A520 für Fahrzeuge mit Zweischeibenkupplung / for vehicles with double disc clutch	(77)	
				3189 600 061			

		CODE				
--	--	------	--	---	---	---







VOLVO







FH		09.05 -				
540	01.09-		 3400 700 600 ⊕  3483 000 348  1878 007 046	430 24 MFZ430 430WGTZ	Mot. D13C Getr. / GBox: VT 2814B / VTO 2814B Euro 6 / Euro 6	(18)
			 3400 710 064  3482 001 310  1878 007 170  6482 000 155	430 24 MF430 430WGTZ PHIS-6/38	Mot. D13C Getr. / GBox: AT2612/E / ATO2612/E Euro 6 / Euro 6	(18)
	CD40B-O	 3400 700 629 ⊕  3488 000 373  1878 007 366	400 24 MFZ2/400X 400WGTZ	Getr. / GBox: VT 2214B / VTO 2214B Getr. / GBox: VT 2514B / VTO 2514B Getr. / GBox: VT 2814B / VTO 2814B für Fahrzeuge mit Zweischeibenkupplung / for vehicles with double disc clutch mit Zwischenring / with intermediate ring	(77)	

FH II		01.12 -				
420 420	01.12- 05.12-		 3400 710 064  3482 001 310  1878 007 170  6482 000 155	430 24 MF430 430WGTZ PHIS-6/38	Getr. / GBox: AT 2412/E Getr. / GBox: AT 2612/E Getr. / GBox: ATO 2612/E	
			 3400 700 600 ⊕  3483 000 348  1878 007 046	430 24 MFZ430 430WGTZ	Getr. / GBox: VT 2214B / VTO 2214B Getr. / GBox: VT 2514B / VTO 2514B Getr. / GBox: VT 2814B / VTO 2814B	
	CD40B-O	 3400 700 629 ⊕  3488 000 373  1878 007 366	400 24 MFZ2/400X 400WGTZ	Getr. / GBox: VT 2214B / VTO 2214B Getr. / GBox: VT 2514B / VTO 2514B Getr. / GBox: VT 2814B / VTO 2814B für Fahrzeuge mit Zweischeibenkupplung / for vehicles with double disc clutch mit Zwischenring / with intermediate ring	(77)	
420 460	05.12- 05.12-		 3400 710 064  3482 001 310  1878 007 170  6482 000 155	430 24 MF430 430WGTZ PHIS-6/38	Getr. / GBox: AT 24112F / AT 2612F Getr. / GBox: ATO 2612F	
			 3400 700 600 ⊕  3483 000 348  1878 007 046	430 24 MFZ430 430WGTZ	Getr. / GBox: VT 2214B / VTO 2214B Getr. / GBox: VT 2514B / VTO 2514B	
		 3189 600 061		Getr. / GBox: VT 2214B / VTO 2214B Getr. / GBox: VT 2514B / VTO 2514B		
460 460	01.12- 05.12-		 3400 710 064  3482 001 310  1878 007 170  6482 000 155	430 24 MF430 430WGTZ PHIS-6/38	Getr. / GBox: AT 2412/E Getr. / GBox: AT 2612/E Getr. / GBox: ATO 2612/E	
			 3400 700 600 ⊕  3483 000 348  1878 007 046	430 24 MFZ430 430WGTZ	Getr. / GBox: VT 2514B / VTO 2514B Getr. / GBox: VT 2814B / VTO 2814B	
	CD40B-O	 3400 700 629 ⊕  3488 000 373  1878 007 366	400 24 MFZ2/400X 400WGTZ	Getr. / GBox: VT 2514B / VTO 2514B Getr. / GBox: VT 2814B / VTO 2814B für Fahrzeuge mit Zweischeibenkupplung / for vehicles with double disc clutch mit Zwischenring / with intermediate ring	(77)	
500 500 500 500	01.12- 01.12- 05.12- 09.12-		 3400 710 064  3482 001 310  1878 007 170  6482 000 155	430 24 MF430 430WGTZ PHIS-6/38	Getr. / GBox: AT 2612/E Getr. / GBox: ATO 2612/E	
			 3400 700 600 ⊕  3483 000 348  1878 007 046	430 24 MFZ430 430WGTZ	Getr. / GBox: VT 2514B / VTO 2514B Getr. / GBox: VT 2814B / VTO 2814B	
	CD40B-O	 3400 700 629 ⊕  3488 000 373  1878 007 366	400 24 MFZ2/400X 400WGTZ	Getr. / GBox: VT 2514B / VTO 2514B Getr. / GBox: VT 2814B / VTO 2814B für Fahrzeuge mit Zweischeibenkupplung / for vehicles with double disc clutch mit Zwischenring / with intermediate ring	(77)	
500	05.12-		 3400 710 064  3482 001 310  1878 007 170  6482 000 155	430 24 MF430 430WGTZ PHIS-6/38	Getr. / GBox: AT 2612F / ATO 2612F	
			 3400 700 600 ⊕  3483 000 348  1878 007 046	430 24 MFZ430 430WGTZ	Getr. / GBox: VT 2214B / VTO 2214B	
		 3189 600 061		Getr. / GBox: VT 2214B / VTO 2214B		

		CODE		 Parameter		
--	--	------	--	---	---	---













VOLVO

FH II		01.12 -						
540 540	01.12- 05.12-			3400 710 064 ⊕ 3482 001 310 ⊕ 1878 007 170 ⊕ 6482 000 155	430 24 MF430 430WGTZ PHIS-6/38	Getr. / GBox: AT 2612/E Getr. / GBox: ATO 2612/E		
					3400 700 600 ⊕ ⊕ 3483 000 348 ⊕ 1878 007 046	430 24 MFZ430 430WGTZ	Getr. / GBox: VT 2814B / VTO 2814B	
		CD40B-O		3400 700 629 ⊕ ⊕ 3488 000 373 ⊕ 1878 007 366	400 24 MFZ2/400X 400WGTZ	Getr. / GBox: VT 2814B / VTO 2814B für Fahrzeuge mit Zweis Scheibenkupplung / for vehicles with double disc clutch mit Zwischenring / with intermediate ring	(77) (94)	
540	05.12-			3400 710 064 ⊕ 3482 001 310 ⊕ 1878 007 170 ⊕ 6482 000 155	430 24 MF430 430WGTZ PHIS-6/38	Getr. / GBox: AT 2612F / ATO 2612F		
					3400 700 600 ⊕ ⊕ 3483 000 348 ⊕ 1878 007 046	430 24 MFZ430 430WGTZ	Getr. / GBox: VT2814B / VTO2814B	
					3189 600 061		Getr. / GBox: VT2814B / VTO2814B	

FH 12		08.93 -						
Mot. D 12 A	01.93-	CL43S-0		3400 043 032 ⊕ ⊕ 3483 034 033 ⊕ 1878 634 026	430 10 MFZ430 430WGTZ	Getr. / GBox: R/SR1700,1900		
					3482 123 234	430 MFZ430	Getr. / GBox: R/SR1700,1900 In 3483/3488 enthalten / Contained in 3483, 3488	(32)
		CL38D-0		3400 700 426 ⊕ ⊕ 3488 019 031 ⊕ 1862 415 031	380 10 GMFZ2/380 380WGVZ	Getr. / GBox: R/SR1700,1900		
					3400 700 325 ⊕ ⊕ 3483 027 231 ⊕ 1862 248 033 1862 415 031	380 10 GMFZ2/380 380GVZ 380WGVZ	Getr. / GBox: R/SR1700,1900 ohne Zwischenring / without intermediate ring	(106)
					3482 111 031	380 GMFZ2/380	Getr. / GBox: R/SR1700,1900 In 3483/3488 enthalten / Contained in 3483, 3488	(32)
					3459 017 031	380 GMFZ2/380	Getr. / GBox: R/SR1700,1900 In 3488 enthalten / Contained in 3488	(33)

		CODE				
--	--	------	--	---	---	---

VOLVO

FH 12		08.93 -					
FH 12/340 FH 12/340 FH 12/380	08.93- 01.95- 08.93-	CL38D-O		3400 700 426 ⊕ ⊗ 3488 019 031 ⊗ 1862 415 031	380 10 GMFZ2/380 380WGVZ	Mot. D12A Getr. / GBox: R/SR1700/1900	
				3400 700 325 ⊕ ⊗ 3483 027 231 ⊗ 1862 248 033 1862 415 031	380 10 GMFZ2/380 380GVZ 380WGVZ	Mot. D12A Getr. / GBox: R/SR1700/1900 ohne Zwischenring / without intermediate ring	(106)
				3482 111 031	380 GMFZ2/380	Mot. D12A Getr. / GBox: R/SR1700/1900 In 3483/3488 enthalten / Contained in 3483, 3488	(32)
				3459 017 031	380 GMFZ2/380	Mot. D12A Getr. / GBox: R/SR1700/1900 In 3488 enthalten / Contained in 3488	(33)
				3400 700 427 ⊕ ⊗ 3488 019 032 ⊗ 1862 415 031	380 10 GMFZ2/380 380WGVZ	Mot. D12C Getr. / GBox: R/SR1700/1900	
				3400 700 326 ⊕ ⊗ 3483 027 332 ⊗ 1862 248 033 1862 415 031	380 10 GMFZ2/380 380GVZ 380WGVZ	Mot. D12C Getr. / GBox: R/SR1700/1900 ohne Zwischenring / without intermediate ring	(106)
				3482 111 032	380 GMFZ2/380	Mot. D12C Getr. / GBox: R/SR1700/1900 In 3483/3488 enthalten / Contained in 3483, 3488	(32)
				3459 017 031	380 GMFZ2/380	Mot. D12C Getr. / GBox: R/SR1700/1900 In 3488 enthalten / Contained in 3488	(33)
		CL43S-O		3400 127 101 ⊕ ⊗ 3483 034 034 ⊗ 1878 634 026	430 10 MFZ430 430WGTZ	Mot. D12C Getr. / GBox: VT2014, VT2014OD	
				3482 123 234	430 MFZ430	Mot. D12C Getr. / GBox: VT2014, VT2014OD In 3483/3488 enthalten / Contained in 3483, 3488	(32)
				3400 043 032 ⊕ ⊗ 3483 034 033 ⊗ 1878 634 026	430 10 MFZ430 430WGTZ	Mot. D12A,C Getr. / GBox: R/SR1700/1900	
				3482 123 234	430 MFZ430	Mot. D12A,C Getr. / GBox: R/SR1700/1900 In 3483/3488 enthalten / Contained in 3483, 3488	(32)
				3189 600 061			



CODE



SACHS

Parameter

















VOLVO

















FH 12		08.93 -					
FH 12/380	08.93-	CD38B-O		3400 700 348 ⊕ ⊗ 3488 019 032 ⊗ 1878 001 216	380 24 GMFZ2/380 380WGVZ	Mot. D12D380 Getr. / GBox: VT2009B	
FH 12/380	01.95-						
FH 12/380	03.98 - 09.03	CL39D-C		3400 700 360 ⊕ ⊗ 3488 000 159 ⊗ 1878 003 768	400 24 MFZ2/400X 400WGTZ		
FH 12/380	03.98 - 09.03						
FH 12/380	12.01 - 08.06	CD40B-O		3400 700 422 ⊕ ⊗ 3488 000 024 ⊗ 1878 000 300	400 24 MFZ2/400X 400WGTZ	Mot. D12D380 Getr. / GBox: VT2214B, VTO2214B mit Zwischenring / with intermediate ring	(94)
				3400 700 423 ⊕ ⊗ 3483 034 135 ⊗ 1878 000 300 1878 000 635	400 24 MFZ2/400X 400WGTZ 400GTZ	Mot. D12D380 Getr. / GBox: VT2214B, VTO2214B ohne Zwischenring / without intermediate ring	(106)
		CL38D-O		3400 700 426 ⊕ ⊗ 3488 019 031 ⊗ 1862 415 031	380 10 GMFZ2/380 380WGVZ	Mot. D12A Getr. / GBox: R/SR1700/1900	
				3400 700 325 ⊕ ⊗ 3483 027 231 ⊗ 1862 248 033 1862 415 031	380 10 GMFZ2/380 380GVZ 380WGVZ	Mot. D12A Getr. / GBox: R/SR1700/1900 ohne Zwischenring / without intermediate ring	(106)
				3400 700 427 ⊕ ⊗ 3488 019 032 ⊗ 1862 415 031	380 10 GMFZ2/380 380WGVZ	Mot. D12C Getr. / GBox: R/SR1700/1900	
				3400 700 326 ⊕ ⊗ 3483 027 332 ⊗ 1862 248 033 1862 415 031	380 10 GMFZ2/380 380GVZ 380WGVZ	Mot. D12C Getr. / GBox: R/SR1700/1900 ohne Zwischenring / without intermediate ring	(106)
		CS43B-O		3400 700 350 ⊕ ⊗ 3483 034 042 ⊗ 1878 000 634	430 24 MFZ430 430WGTZ	Mot. D12D380 Getr. / GBox: VT2412B	
		CL43S-O		3400 127 101 ⊕ ⊗ 3483 034 034 ⊗ 1878 634 026	430 10 MFZ430 430WGTZ	Mot. D12C Getr. / GBox: VT2014, VT2014OD	
				3400 043 032 ⊕ ⊗ 3483 034 033 ⊗ 1878 634 026	430 10 MFZ430 430WGTZ	Mot. D12A,C Getr. / GBox: R/SR1700/1900	
		CS43B-O, CS43B-OR		3400 700 343 ⊕ ⊗ 3483 034 034 ⊗ 1878 000 634	430 24 MFZ430 430WGTZ	Mot. D12D380 Getr. / GBox: VT2214B, VTO2214B	
				3400 700 342 ⊕ ⊗ 3483 034 033 ⊗ 1878 000 634	430 24 MFZ430 430WGTZ	Mot. D12D380 Getr. / GBox: VT2009B	
				3189 600 061			

		CODE				
--	--	------	--	---	---	---

VOLVO













FH 12		08.93 -					
FH 12/420	08.93-	CD38B-O	 3400 700 348 ⊕ ⊗ 3488 019 032 ⊗ 1878 001 216	380 24 GMFZ2/380 380WGVZ	Mot. D12D420 Getr. / GBox: VT2009B		
FH 12/420	01.95-						
FH 12/420	05.99-09.03	CL39D-C	 3400 700 360 ⊕ ⊗ 3488 000 159 ⊗ 1878 003 768	400 24 MFZ2/400X 400WGTZ			
FH 12/420	10.03-08.06						
		CD40B-O	 3400 700 422 ⊕ ⊗ 3488 000 024 ⊗ 1878 000 300	400 24 MFZ2/400X 400WGTZ	Mot. D12D420 Getr. / GBox: VT2214B, VTO2214B mit Zwischenring / with intermediate ring	(94)	
			 3400 700 423 ⊕ ⊗ 3483 034 135 ⊗ 1878 000 300 ⊗ 1878 000 635	400 24 MFZ2/400X 400WGTZ 400GTZ	Mot. D12D420 Getr. / GBox: VT2214B, VTO2214B ohne Zwischenring / without intermediate ring	(106)	
		CL38D-O	 3400 700 426 ⊕ ⊗ 3488 019 031 ⊗ 1862 415 031	380 10 GMFZ2/380 380WGVZ	Mot. D12A Getr. / GBox: R/SR1700/1900		
			 3400 700 325 ⊕ ⊗ 3483 027 231 ⊗ 1862 248 033 ⊗ 1862 415 031	380 10 GMFZ2/380 380GVZ 380WGVZ	Mot. D12A Getr. / GBox: R/SR1700/1900 ohne Zwischenring / without intermediate ring	(106)	
			 3400 700 427 ⊕ ⊗ 3488 019 032 ⊗ 1862 415 031	380 10 GMFZ2/380 380WGVZ	Mot. D12C Getr. / GBox: R/SR1700/1900		
			 3400 700 326 ⊕ ⊗ 3483 027 332 ⊗ 1862 248 033 ⊗ 1862 415 031	380 10 GMFZ2/380 380GVZ 380WGVZ	Mot. D12C Getr. / GBox: R/SR1700/1900 ohne Zwischenring / without intermediate ring	(106)	
		CS43B-O	 3400 700 350 ⊕ ⊗ 3483 034 042 ⊗ 1878 000 634	430 24 MFZ430 430WGTZ	Mot. D12D420 Getr. / GBox: VT2412B		
		CL43S-O	 3400 127 101 ⊕ ⊗ 3483 034 034 ⊗ 1878 634 026	430 10 MFZ430 430WGTZ	Mot. D12C Getr. / GBox: VT2014, VT2014OD		
			 3400 043 032 ⊕ ⊗ 3483 034 033 ⊗ 1878 634 026	430 10 MFZ430 430WGTZ	Mot. D12A,C Getr. / GBox: R/SR1700/1900		
		CS43B-O, CS43B-OR	 3400 700 343 ⊕ ⊗ 3483 034 034 ⊗ 1878 000 634	430 24 MFZ430 430WGTZ	Mot. D12D420 Getr. / GBox: VT2214B, VTO2214B		
			 3400 700 342 ⊕ ⊗ 3483 034 033 ⊗ 1878 000 634	430 24 MFZ430 430WGTZ	Mot. D12D420 Getr. / GBox: VT2009B		
			 3189 600 061				

VOLVO

FH 12		08.93 -						
FH 12/460 FH 12/460	08.98- 10.03-08.06	CL39D-C	 3400 700 360 ⊕ ⊗ 3488 000 159 ⊗ 1878 003 768	400 24 MFZ2/400X 400WGTZ				
		CD40B-O	 3400 700 422 ⊕ ⊗ 3488 000 024 ⊗ 1878 000 300	400 24 MFZ2/400X 400WGTZ	Mot. D12D460 Getr. / GBox: VT2514B, VTO2514B mit Zwischenring / with intermediate ring	(94)		
			 3400 700 423 ⊕ ⊗ 3483 034 135 ⊗ 1878 000 300 ⊗ 1878 000 635	400 24 MFZ2/400X 400WGTZ 400GTZ	Mot. D12D460 Getr. / GBox: VT2514B, VTO2514B ohne Zwischenring / without intermediate ring	(106)		
			 3459 018 004	400 MFZ2/400X	Mot. D12D460 Getr. / GBox: VT2514B, VTO2514B In 3488 enthalten / Contained in 3488	(33)		
		CL40D-O	 3400 700 406 ⊕ ⊗ 3488 022 253 ⊗ 1878 002 437	400 10 MFZ2/400X 400WGTZ	Mot. D12C460 mit Zwischenring / with intermediate ring	(94)		
		CS43B-O	 3400 700 351 ⊕ ⊗ 3483 034 043 ⊗ 1878 006 129	430 24 MFZ430 430WGTZ	Mot. D12D460 Getr. / GBox: VT2412B Euro 5 / Euro 5	(17)		
			 3400 700 357 ⊕ ⊗ 3483 034 035 ⊗ 1878 006 129	430 24 MFZ430 430WGTZ	Mot. D12D460 Getr. / GBox: VT2514B Euro 5 / Euro 5	(17)		
		CL43S-O	 3400 700 401 ⊕ ⊗ 3483 034 035 ⊗ 1878 032 331	430 10 MFZ430 430WGTZ	Mot. D12C460 Getr. / GBox: VT2514			
			 3400 127 101 ⊕ ⊗ 3483 034 034 ⊗ 1878 634 026	430 10 MFZ430 430WGTZ	Mot. D12C Getr. / GBox: VT2014, VT2014OD			
			 3482 123 234	430 MFZ430	Mot. D12C Getr. / GBox: VT2014, VT2014OD In 3483/3488 enthalten / Contained in 3483, 3488	(32)		
				 3189 600 061				
		FH 12/500	09.01 -	CL39D-C	 3400 700 360 ⊕ ⊗ 3488 000 159 ⊗ 1878 003 768	400 24 MFZ2/400X 400WGTZ		
CD40B-O	 3400 700 422 ⊕ ⊗ 3488 000 024 ⊗ 1878 000 300			400 24 MFZ2/400X 400WGTZ	Mot. D12D500 Getr. / GBox: VT2514B, VTO2514B mit Zwischenring / with intermediate ring	(94)		
	 3400 700 423 ⊕ ⊗ 3483 034 135 ⊗ 1878 000 300 ⊗ 1878 000 635			400 24 MFZ2/400X 400WGTZ 400GTZ	Mot. D12D500 Getr. / GBox: VT2514B, VTO2514B ohne Zwischenring / without intermediate ring	(106)		
	 3459 018 004			400 MFZ2/400X	Mot. D12D500 Getr. / GBox: VT2514B, VTO2514B In 3488 enthalten / Contained in 3488	(33)		
CS43B-O	 3400 700 351 ⊕ ⊗ 3483 034 043 ⊗ 1878 006 129			430 24 MFZ430 430WGTZ	Mot. D12D500 Getr. / GBox: VT2412B Euro 5 / Euro 5	(17)		

		CODE				
--	--	------	--	---	---	---

VOLVO























FH 16		08.93 -					
FH 16/470	08.93-12.99	CL40D-O		3488 018 031 ⊕	400 GMFZ2/400	->Chass. A291151 ->Chass. B21584 ->Chass. D120646 Mot. D16A470,D16B470 enthält eine Kupplungsscheibe / This part number includes one clutch disc	(67)
FH 16/470 4x2	08.93-			1878 002 458 ▽	400 10 400WGTZ	->Chass. A291151 ->Chass. B21584 ->Chass. D120646 Mot. D16A470,D16B470 Lose Kupplungsscheibe / Loose clutch disc	(41)
FH 16/470 6x2	08.93-			3482 110 031	400 GMFZ2/400	->Chass. A291151 ->Chass. B21584 ->Chass. D120646 Mot. D16A470,D16B470 In 3488 enthalten / Contained in 3488	(33)
FH 16/470 6x2	01.95-			3459 016 031	400 GMFZ2/400	->Chass. A291151 ->Chass. B21584 ->Chass. D120646 Mot. D16A470,D16B470 In 3488 enthalten / Contained in 3488	(33)
FH 16/470 6x2/2/4	08.93-			1878 002 460 △	400 10 400GTZ	->Chass. A291151 ->Chass. B21584 ->Chass. D120646 Mot. D16A470,D16B470 In 3483/3488 enthalten / Contained in 3483, 3488	(32)
FH 16/470 6x4	08.93-			3400 700 406 ⊕ ⊕ 3488 022 253 ⊕ 1878 002 437	400 10 MFZ2/400X 400WGTZ	Chass. A291152-> Chass. B21585-> Chass. D120647-> Mot. D16A470,D16B470 mit Zwischenring / with intermediate ring	(94)
				3459 018 004	400 MFZ2/400X	Chass. A291152-> Chass. B21585-> Chass. D120647-> Mot. D16A470,D16B470 In 3488 enthalten / Contained in 3488	(33)
				3400 700 407 ⊕ ⊕ 3483 034 135 ⊕ 1878 002 437 1878 002 442	400 10 MFZ2/400X 400WGTZ 400GTZ	Chass. A291152-> Chass. B21585-> Chass. D120647-> Mot. D16A470,D16B470 ohne Zwischenring / without intermediate ring	(106)
				3488 018 031 ⊕	400 GMFZ2/400	Chass. C750800-> Mot. D16A470,D16B470 Länderausführung: Groß Britannien / Country-spec. model: Great Britain enthält eine Kupplungsscheibe / This part number includes one clutch disc	(42) (67)
				1878 002 458 ▽	400 10 400WGTZ	Chass. C750800-> Mot. D16A470,D16B470 Länderausführung: Groß Britannien / Country-spec. model: Great Britain Lose Kupplungsscheibe / Loose clutch disc	(42) (41)
				3482 110 031	400 GMFZ2/400	Chass. C750800-> Mot. D16A470,D16B470 Länderausführung: Groß Britannien / Country-spec. model: Great Britain In 3488 enthalten / Contained in 3488	(42) (33)
				3459 016 031	400 GMFZ2/400	Chass. C750800-> Mot. D16A470,D16B470 Länderausführung: Groß Britannien / Country-spec. model: Great Britain In 3488 enthalten / Contained in 3488	(42) (33)
				1878 002 460 △	400 10 400GTZ	Chass. C750800-> Mot. D16A470,D16B470 Länderausführung: Groß Britannien / Country-spec. model: Great Britain In 3483/3488 enthalten / Contained in 3483, 3488	(42) (32)

VOLVO





FH 16		08.93 -					
FH 16/520 FH 16/520	08.93-12.02	CL40D-O	 3488 018 031 ⊕	400 GMFZ2/400	->Chass. A291151 ->Chass. B21584 ->Chass. D120646 Mot. D16A520,D16B520 enthält eine Kupplungsscheibe / This part number includes one clutch disc	(67)	
	01.95-		 1878 002 458 ▽	400 10 400WGTZ	->Chass. A291151 ->Chass. B21584 ->Chass. D120646 Mot. D16A520,D16B520 Lose Kupplungsscheibe / Loose clutch disc	(41)	
			 3482 110 031	400 GMFZ2/400	->Chass. A291151 ->Chass. B21584 ->Chass. D120646 Mot. D16A520,D16B520 In 3488 enthalten / Contained in 3488	(33)	
			 3459 016 031	400 GMFZ2/400	->Chass. A291151 ->Chass. B21584 ->Chass. D120646 Mot. D16A520,D16B520 In 3488 enthalten / Contained in 3488	(33)	
			 1878 002 460 △	400 10 400GTZ	->Chass. A291151 ->Chass. B21584 ->Chass. D120646 Mot. D16A520,D16B520 In 3483/3488 enthalten / Contained in 3483, 3488	(32)	
			 3400 700 406 ⊕  3488 022 253  1878 002 437	400 10 MFZ2/400X 400WGTZ	Chass. A291152 -> Chass. B21585 -> Chass. D120647 -> Mot. D16A520,D16B520 mit Zwischenring / with intermediate ring	(94)	
			 3459 018 004	400 MFZ2/400X	Chass. A291152 -> Chass. B21585 -> Chass. D120647 -> Mot. D16A520,D16B520 In 3488 enthalten / Contained in 3488	(33)	
			 3400 700 407 ⊕  3483 034 135  1878 002 437 1878 002 442	400 10 MFZ2/400X 400WGTZ 400GTZ	Chass. A291152 -> Chass. B21585 -> Chass. D120647 -> Mot. D16A520,D16B520 ohne Zwischenring / without intermediate ring	(106)	
			 3488 018 031 ⊕	400 GMFZ2/400	Chass. C750800 -> Mot. D16A520,D16B520 Länderausführung: Groß Britannien / Country-spec. model: Great Britain enthält eine Kupplungsscheibe / This part number includes one clutch disc	(42) (67)	
			 1878 002 458 ▽	400 10 400WGTZ	Chass. C750800 -> Mot. D16A520,D16B520 Länderausführung: Groß Britannien / Country-spec. model: Great Britain Lose Kupplungsscheibe / Loose clutch disc	(42) (41)	
			 3482 110 031	400 GMFZ2/400	Chass. C750800 -> Mot. D16A520,D16B520 Länderausführung: Groß Britannien / Country-spec. model: Great Britain In 3488 enthalten / Contained in 3488	(42) (33)	
			 3459 016 031	400 GMFZ2/400	Chass. C750800 -> Mot. D16A520,D16B520 Länderausführung: Groß Britannien / Country-spec. model: Great Britain In 3488 enthalten / Contained in 3488	(42) (33)	
			 1878 002 460 △	400 10 400GTZ	Chass. C750800 -> Mot. D16A520,D16B520 Länderausführung: Groß Britannien / Country-spec. model: Great Britain In 3483/3488 enthalten / Contained in 3483, 3488	(42) (32)	



		CODE				
--	--	------	--	---	---	---

VOLVO

FH 16		08.93 -					
FH 16/540	01.09-	CD40B-O		3400 700 360 ⊕ ⊗ 3488 000 159 ⊗ 1878 003 768	400 24 MFZ2/400X 400WGTZ	für / for: Abgas Japannorm 2004 Mot. D16E540, D16C550 Getr. / GBox: VT2814B, VTO2814B	(69)
FH 16/540, FH 16/550	01.03-			3400 700 422 ⊕ ⊗ 3488 000 024 ⊗ 1878 000 300	400 24 MFZ2/400X 400WGTZ	Mot. D16E540, D16C550 Getr. / GBox: VT2814B, VTO2814B mit Zwischenring / with intermediate ring	(94)
FH 16/540, FH 16/550	08.07-			1863 869 037	72	Mot. D16E540, D16C550 Getr. / GBox: VT2814B, VTO2814B	
FH 16/550	01.03-		CS43B-O		3400 710 063 ■	430 24	Mot. D16E540, D16C550 Getr. / GBox: AT2812C, ATO3112C mit automatischer Nachstellung / with automatic adjustment
FH 16/550	05.05-			6594 000 120	430 430Z	Mot. D16E540, D16C550 Getr. / GBox: AT2812C, ATO3112C nur in Verbindung mit / only in connection with: OE.Nr. 975154	(101)
				1863 869 037	72	Mot. D16E540, D16C550 Getr. / GBox: AT2812C, ATO3112C	
FH 16/540, FH 16/550	01.03-			3400 710 068 ⊗ 3482 001 447 ⊗ 1878 007 169 ⚡ 6482 000 155	430WGTZ PHIS-6/38	Mot. D16G Getr. / GBox: AT2812/D / ATO3112/D Euro 6 / Euro 6 für Motoren ohne Zweimassenschwungrad / for engines without dual-mass flywheel	(18) (81)
FH 16/550	09.05-						
FH 16/600	09.06-						
FH 16/600	01.09-						
FH 16/580	09.06-	CD40B-O		3400 700 360 ⊕ ⊗ 3488 000 159 ⊗ 1878 003 768	400 24 MFZ2/400X 400WGTZ	für / for: Abgas Japannorm 2004 Mot. D16E580 Getr. / GBox: VT2814B, VTO2814B	(69)
FH 16/580	01.09-			3400 700 422 ⊕ ⊗ 3488 000 024 ⊗ 1878 000 300	400 24 MFZ2/400X 400WGTZ	Mot. D16E580 Getr. / GBox: VT2814B, VTO2814B mit Zwischenring / with intermediate ring	(94)
				1863 869 037	72	Mot. D16E580 Getr. / GBox: VT2814B, VTO2814B	
			CS43B-O		3400 710 063 ■	430 24	Mot. D16E580 Getr. / GBox: AT2812C, ATO3112C mit automatischer Nachstellung / with automatic adjustment
				6594 000 120	430 430Z	Mot. D16E580 Getr. / GBox: AT2812C, ATO3112C nur in Verbindung mit / only in connection with: OE.Nr. 975154	(101)
				1863 869 037	72	Mot. D16E580 Getr. / GBox: AT2812C, ATO3112C	
FH 16/610	09.05-	CD40B-O		3400 700 360 ⊕ ⊗ 3488 000 159 ⊗ 1878 003 768	400 24 MFZ2/400X 400WGTZ	für / for: Abgas Japannorm 2004 Mot. D16C610 Getr. / GBox: VT2814B, VTO2814B	(69)
FH 16/610	01.03-			3400 700 422 ⊕ ⊗ 3488 000 024 ⊗ 1878 000 300	400 24 MFZ2/400X 400WGTZ	Mot. D16C610 Getr. / GBox: VT2814B, VTO2814B mit Zwischenring / with intermediate ring	(94)
FH 16/610	08.07-			1863 869 037	72	Mot. D16C610 Getr. / GBox: VT2814B, VTO2814B	
			CS43B-O		3400 710 063 ■	430 24	Mot. D16C610 Getr. / GBox: AT2812C, ATO3112C mit automatischer Nachstellung / with automatic adjustment
				6594 000 120	430 430Z	Mot. D16C610 Getr. / GBox: AT2812C, ATO3112C nur in Verbindung mit / only in connection with: OE.Nr. 975154	(101)
				1863 869 037	72	Mot. D16C610 Getr. / GBox: AT2812C, ATO3112C	
FH 16/660	09.06-	CS43B-O		3400 710 063 ■	430 24	Mot. D16E660 Getr. / GBox: AT2812C, ATO3112C mit automatischer Nachstellung / with automatic adjustment	(95)
FH 16/660	01.07-			6594 000 120	430 430Z	Mot. D16E660 Getr. / GBox: AT2812C, ATO3112C nur in Verbindung mit / only in connection with: OE.Nr. 975154	(101)
FH 16/660	01.09-			1863 869 037	72	Mot. D16E660 Getr. / GBox: AT2812C, ATO3112C	
FH 16/700	01.09-			3400 710 065 ⊗ 3482 001 309 ⊗ 1878 007 169 ⚡ 6482 000 155	430 24 MF430 430WGTZ PHIS-6/38	Mot. D16G Getr. / GBox: ATO 3112/D Euro 6 / Euro 6 für Motoren ohne Zweimassenschwungrad / for engines without dual-mass flywheel	(18) (81)

VOLVO

FH 16 II		04.09 -					
FH 16/540, FH 16/550 FH 16/550 FH 16/600	05.12- 03.14- 05.12-			3400 710 068 ⊕ 3482 001 447 ⊕ 1878 007 169 🔍 6482 000 155	430WGTZ PHIS-6/38	Mot. D16G Getr. / GBox: AT2812/D / ATO3112/D Euro 6 / Euro 6 für Motoren ohne Zweimassenschwungrad / for engines without dual-mass flywheel	(18) (81)
FH 16/540, FH 16/550 FH 16/650 FH 16/700	05.12- 03.14- 05.12-			3400 710 068 ⊕ 3482 001 447 ⊕ 1878 007 169 🔍 6482 000 155	430WGTZ PHIS-6/38	Mot. D16G Getr. / GBox: ATO 3112/D Euro 6 / Euro 6 für Motoren ohne Zweimassenschwungrad / for engines without dual-mass flywheel	(18) (81)
FH 16/650 FH 16/750	03.14- 03.14-			3400 700 640 ⊕ 3482 001 447 ⊕ 1878 007 169	430WGTZ		
				3400 710 068 ⊕ 3482 001 447 ⊕ 1878 007 169 🔍 6482 000 155	430WGTZ PHIS-6/38		
FH 16/750 FH 16/750 FH 16/750 FH 16/750	05.12- 05.12- 05.12- 11.13-			3400 710 065 ⊕ 3482 001 309 ⊕ 1878 007 169 🔍 6482 000 155	430 24 MF430 430WGTZ PHIS-6/38	Mot. D16G Getr. / GBox: ATO 3112/D Euro 6 / Euro 6 für Motoren ohne Zweimassenschwungrad / for engines without dual-mass flywheel	(18) (81)

FH 565 / NH 565							
FH 565 / NH 565		CL40D-O		3400 700 406 ⊕ ⊕ 3488 022 253 ⊕ 1878 002 437	400 10 MFZ2/400X 400WGTZ	mit Zwischenring / with intermediate ring	(94)
				3400 700 407 ●⊕ ⊕ 3483 034 135 ⊕ 1878 002 437 ⊕ 1878 002 442	400 10 MFZ2/400X 400WGTZ 400GTZ	ohne Zwischenring / without intermediate ring	(106)
				3459 018 004	400 MFZ2/400X	In 3488 enthalten / Contained in 3488	(33)



CODE



SACHS









Parameter

































VOLVO

FL		03.00 -					
FL 180-10	03.00-	KB114E/F	⊕	3482 602 005	350	Chass. 1921636 - Chass. 1921928 Chass. 2921849 - Chass. 2929187 Chass. B265000-> Chass. S921941->	
FL 180-11	03.00-						
FL 180-12	03.00-						
FL 180-13	03.00-						
FL 180-14	03.00-	KB114G	⊕	1878 600 557	350 10	Chass. 1921636 - Chass. 1921928 Chass. 2921849 - Chass. 2929187 Chass. B265000-> Chass. S921941->	
FL 180-15	03.00-						
FL 180-16	03.00-						
FL 180-17	03.00-						
FL 180-18	03.00-	KB114G	⊕	3482 602 006	350	Chass. 1921636 - Chass. 1921928 Chass. 2921849 - Chass. 2929187 Chass. B265000-> Chass. S921941->	
FL 180-7,5	03.00-						
FL 180-8	03.00-						
FL 180-9	03.00-						
FL 220-10	03.00-	KB115	⊕	1878 600 557	350 10	Chass. 1921636 - Chass. 1921928 Chass. 2921849 - Chass. 2929187 Chass. B265000-> Chass. S921941->	
FL 220-11	03.00-						
FL 220-12	03.00-						
FL 220-13	03.00-						
FL 220-14	03.00-	KB115	⊕	3482 602 002	380 M380	Chass. 1921636 - Chass. 1921928 Chass. 2921849 - Chass. 2929187 Chass. B265000-> Chass. S921941->	
FL 220-15	03.00-						
FL 220-16	03.00-						
FL 220-17	03.00-						
FL 220-18	03.00-	KB115A	⊕	1878 000 961	380 10 380GTZ	Chass. 1921636 - Chass. 1921928 Chass. 2921849 - Chass. 2929187 Chass. B265000-> Chass. S921941->	
FL 220-7,5	03.00-						
FL 220-8	03.00-						
FL 220-9	03.00-						
FL 250-10	03.00-	KB115A	⊕	3482 602 003	380	Chass. 1921636 - Chass. 1921928 Chass. 2921849 - Chass. 2929187 Chass. B265000-> Chass. S921941->	
FL 250-11	03.00-						
FL 250-12	03.00-						
FL 250-13	03.00-						
FL 250-14	03.00-	KB115A	⊕	1878 000 961	380 10 380GTZ	Chass. 1921636 - Chass. 1921928 Chass. 2921849 - Chass. 2929187 Chass. B265000-> Chass. S921941->	
FL 250-15	03.00-						
FL 250-16	03.00-						
FL 250-17	03.00-						
FL 250-18	03.00-	KB115A	⊕	3482 602 003	380	Chass. 1921636 - Chass. 1921928 Chass. 2921849 - Chass. 2929187 Chass. B265000-> Chass. S921941->	
FL 250-7,5	03.00-						
FL 250-8	03.00-						
FL 250-9	03.00-						

VOLVO

FL 6		09.85 - 03.00					
FL 180	06.00-	KB114E/F		3482 602 005	350	Chass. 1921636 - Chass. 1921928 Chass. 2921849 - Chass. 2929187 Chass. B265000-> Chass. S921941->	
FL 205G	06.00-			1878 600 557	350 10	Chass. 1921636 - Chass. 1921928 Chass. 2921849 - Chass. 2929187 Chass. B265000-> Chass. S921941->	
FL 220	06.00-	KB114G		3482 602 006	350	Chass. 1921636 - Chass. 1921928 Chass. 2921849 - Chass. 2929187 Chass. B265000-> Chass. S921941->	
FL 250	06.00-			1878 600 557	350 10	Chass. 1921636 - Chass. 1921928 Chass. 2921849 - Chass. 2929187 Chass. B265000-> Chass. S921941->	
		KB115		3482 602 002	380 M380	Chass. 1921636 - Chass. 1921928 Chass. 2921849 - Chass. 2929187 Chass. B265000-> Chass. S921941->	
				1878 000 961	380 10 380GTZ	Chass. 1921636 - Chass. 1921928 Chass. 2921849 - Chass. 2929187 Chass. B265000-> Chass. S921941->	
		KB115A		3482 602 003	380	Chass. 1921636 - Chass. 1921928 Chass. 2921849 - Chass. 2929187 Chass. B265000-> Chass. S921941->	
				1878 000 961	380 10 380GTZ	Chass. 1921636 - Chass. 1921928 Chass. 2921849 - Chass. 2929187 Chass. B265000-> Chass. S921941->	

VOLVO

FL 6		09.85 - 03.00				
FL 608	10.85 - 12.99	KB113C	 3400 116 001	330 10	->Chass. 495167	
FL 608	01.91 - 12.99		 3482 905 001	MF330	->Chass. B166079	
FL 608	01.91 - 12.99		 1862 973 002	330CPB	->Chass. 1920500	
FL 608	01.91 - 12.99		 3151 600 533	KZA-4		
FL 608	01.93 - 12.99	KB114C	 3400 116 101 #	350 10	->Chass. 495167	
FL 610	09.85 - 11.94		 3482 909 001	MF350	->Chass. B166079	
FL 611	09.85 - 11.94		 1862 974 002	350CPB	->Chass. 1920500	
FL 611	09.85 - 03.00		 3151 600 534	KZA-4		
FL 611	09.85 - 03.00		 3482 909 001 #	350	Chass. B166080 - Chass. B264999	
FL 611	12.94 - 03.00			MF350	Chass. 1920501 - Chass. 1920635	
FL 612	09.85 - 12.99		 3151 600 534	KZA-4	Chass. B166080 - Chass. B264999	
FL 612	11.91 - 12.99				Chass. 1920501 - Chass. 1920635	
FL 612	12.95 - 12.99	KB114B/D	 3400 116 201 #	350 10	->Chass. 495167	
FL 612	12.95 - 12.99		 3482 909 001	MF350	->Chass. B166079	
FL 614	09.85 - 03.00		 1878 076 031	350GTB	->Chass. 1920500	
FL 614	09.85 - 03.00		 3151 600 535	KZA-4	Getr. / GBox: S5-35	
FL 614	09.85 - 03.00	KB114B	 3482 909 001 #	350	Chass. B166080 - Chass. B264999	
FL 614	12.95 - 03.00				MF350	Chass. 1920501 - Chass. 1920635
FL 614	09.85 - 03.00		 1878 600 563	350 10	Chass. B166080 - Chass. B264999	
FL 614	12.95 - 03.00				Chass. 1920501 - Chass. 1920635	
FL 614	09.85 - 03.00		 3151 600 534	KZA-4	Chass. B166080 - Chass. B264999	
FL 614	12.95 - 03.00				Chass. 1920501 - Chass. 1920635	
FL 614	12.95 - 03.00	KB114D	 3482 602 008	350	Chass. B166080 - Chass. B264999	
FL 615	11.91 - 03.00		 1878 600 563	350 10	Chass. B166080 - Chass. B264999	
FL 615	11.91 - 03.00					
FL 615	12.95 - 03.00		 3151 600 534	KZA-4	Chass. B166080 - Chass. B264999	
FL 615	12.95 - 03.00	KB115, KV115B	 3400 037 031	380 10	->Chass. 495167	
FL 615	12.95 - 03.00		 3482 021 031	GM380	->Chass. B166079	
FL 615	12.95 - 03.00		 1878 000 961	380GTZ	->Chass. 1920500	
			 3151 600 533	KZA-4		
		KB115	 3482 602 002	380	Chass. B166080 - Chass. B264999	
			 1878 000 961	380 10	Chass. B166080 - Chass. B264999	
				M380	Chass. 1920501 - Chass. 1920635	
				380GTZ	Chass. B166080 - Chass. B264999	
			 3151 600 533	KZA-4	Chass. 1920501 - Chass. 1920635	
					Chass. B166080 - Chass. B264999	
		KB115A	 3482 602 003	380	Chass. B166080 - Chass. B264999	
			 1878 000 961	380 10	Chass. B166080 - Chass. B264999	
				380GTZ	Chass. 1920501 - Chass. 1920635	
				KZA-4	Chass. B166080 - Chass. B264999	
			 3151 600 533		Chass. 1920501 - Chass. 1920635	



CODE



SACHS

Parameter

















VOLVO















FL 6		09.85 - 03.00						
FL 616	11.96-05.00	KB114B	3482 909 001 #	350	Chass. B166080 - Chass. B264999			
FL 617	11.96-05.00			MF350	Chass. 1920501 - Chass. 1920635			
FL 618	11.91-03.00		1878 600 563	350 10	Chass. B166080 - Chass. B264999			
FL 618	11.91-03.00				Chass. 1920501 - Chass. 1920635			
FL 618	12.95-03.00	KB114C	3151 600 534	KZA-4	Chass. B166080 - Chass. B264999			
FL 618	12.95-03.00				Chass. 1920501 - Chass. 1920635			
FL 618	12.95-03.00		3400 116 101 #	350 10	->Chass. 495167			
FL 619	09.85-11.94			MF350	->Chass. B166079			
FL 626	11.96-05.00		350CPB	->Chass. 1920500				
			1862 974 002	KZA-4				
			3151 600 534					
		KB114D	3482 909 001 #	350	Chass. B166080 - Chass. B264999			
				MF350	Chass. 1920501 - Chass. 1920635			
				KZA-4	Chass. B166080 - Chass. B264999			
			3151 600 534		Chass. 1920501 - Chass. 1920635			
		KB115	3482 602 008	350	Chass. B166080 - Chass. B264999			
				1878 600 563	350 10	Chass. B166080 - Chass. B264999		
				3151 600 534	KZA-4	Chass. B166080 - Chass. B264999		
		KB115	3482 602 002	380	->Chass. 495167			
				M380	->Chass. B166079			
					->Chass. 1920500			
				1878 000 961	380 10	->Chass. 495167		
					380GTZ	->Chass. B166079		
					->Chass. 1920500			
				3151 600 533	KZA-4	->Chass. 495167		
					->Chass. B166079			
					->Chass. 1920500			
			3151 824 005	KZA-4	->Chass. 495167			
					->Chass. B166079			
					->Chass. 1920500			
					Getr. / GBox: R1100,S6-65			
					Getr. / GBox: T700,ST700			
			3482 602 002	380	Chass. B166080 - Chass. B264999			
			M380	Chass. 1920501 - Chass. 1920635				
			1878 000 961	380 10	Chass. B166080 - Chass. B264999			
				380GTZ	Chass. 1920501 - Chass. 1920635			
			3151 600 533	KZA-4	Chass. B166080 - Chass. B264999			
					Chass. 1920501 - Chass. 1920635			
		KB115A	3482 602 003	380	->Chass. 495167			
						->Chass. B166079		
						->Chass. 1920500		
				1878 000 961	380 10	->Chass. 495167		
					380GTZ	->Chass. B166079		
						->Chass. 1920500		
			3151 600 533	KZA-4	->Chass. 495167			
					->Chass. B166079			
					->Chass. 1920500			
			3482 602 003	380	Chass. B166080 - Chass. B264999			
					Chass. 1920501 - Chass. 1920635			
			1878 000 961	380 10	Chass. B166080 - Chass. B264999			
				380GTZ	Chass. 1920501 - Chass. 1920635			
			3151 600 533	KZA-4	Chass. B166080 - Chass. B264999			
					Chass. 1920501 - Chass. 1920635			
		KV115B	3400 037 031	380 10	->Chass. 495167			
				3482 021 031	GM380	->Chass. B166079		
			1878 000 961	380GTZ	->Chass. 1920500			
			3151 600 533	KZA-4	Getr. / GBox: R1100,S6-65			
					Getr. / GBox: T700,ST700			
			3400 037 032	380 10	->Chass. 495167			
			3482 021 031	GM380	->Chass. B166079			
			1878 000 961	380GTZ	->Chass. 1920500			
			3151 824 005	KZA-4	->Chass. 1920500			
					Getr. / GBox: R52B			

		CODE					
--	--	------	--	--	---	---	---

VOLVO





















FL 7		09.85 - 09.98					
Mot. TD 71, 73	01.85-	KFD117A	 3400 040 032 ⊕ ⊗ 3483 034 032 ⊗ 1878 004 456	430 10 MFZ430 430GVZ	-> Chass. 900816 Getr. / GBox: R/SR1400,1700		
			 3482 123 235	430 MFZ430	-> Chass. 900816 Getr. / GBox: R1000,R/SR,1400,1700 In 3483/3488 enthalten / Contained in 3483, 3488	(32)	
			 1862 349 031	400 10 400GVZ	-> Chass. 900816 Getr. / GBox: R1000,R/SR,1400,1700		
			 3400 035 032 #⊕ ⊗ 3483 034 032 ⊗ 1861 988 034	430 10 MFZ430 430GVZ	Getr. / GBox: R52B		
			 3482 123 235	430 MFZ430	Getr. / GBox: R52B In 3483/3488 enthalten / Contained in 3483, 3488	(32)	
			KFD117A, B	 3482 123 235	430 MFZ430	Getr. / GBox: R/SR62 In 3483/3488 enthalten / Contained in 3483, 3488	(32)
			KFD214A	 3400 031 033 ⊕ ⊗ 3483 014 132 ⊗ 1878 001 080 1878 001 082 ⊖ 3474 012 000	350 10 GMFZ2/350 350GTZ 350GTZ	Getr. / GBox: R/SR,1400 ohne Zwischenring / without intermediate ring	(106)
				 3488 013 138 ⊕	350 GMFZ2/350	Getr. / GBox: R/SR,1400 enthält eine Kupplungsscheibe / This part number includes one clutch disc	(67)
				 1878 001 082 ▽	350 10 350GTZ	Getr. / GBox: R/SR,1400	
				 3482 056 031	350 GMFZ2/350	Getr. / GBox: R/SR,1400 In 3483/3488 enthalten / Contained in 3483, 3488	(32)
	 3459 000 009	350 GMFZ2/350		Getr. / GBox: R/SR,1400 In 3483/3488 enthalten / Contained in 3483, 3488	(32)		
Mot. TD 71, 73 FL 7/230 FL 7/260	09.85 - 09.98 11.91 - 09.98	KFD116A	 3400 700 301 #⊕ ⊗ 3483 022 031 ⊗ 1862 349 031	400 10 MFZ400X 400GVZ	Chass. 358958-> Getr. / GBox: R1000,R/SR,1400,1700		
			 3482 101 032	400 MFZ400X	Chass. 358958-> Getr. / GBox: R1000,R/SR,1400,1700 In 3483/3488 enthalten / Contained in 3483, 3488	(32)	
FL 7/290	10.93 - 09.98		 3400 700 301 #⊕ ⊗ 3483 022 031 ⊗ 1862 349 031	400 10 MFZ400X 400GVZ			







VOLVO

FL 10		09.85 - 09.98				
Mot. TD 101, 102, 103	01.85-	KFD214A	 3400 031 033 ⊕ ⊗ 3483 014 132 ⊗ 1878 001 080 ⊗ 1878 001 082 ⊗ 3474 012 000	350 10 GMFZ2/350 350GTZ 350GTZ	Getr. / GBox: R/SR1400,1700 ohne Zwischenring / without intermediate ring	(106)
			 3488 013 138 ⊕	350 GMFZ2/350	Getr. / GBox: R/SR1400,1700 enthält eine Kupplungsscheibe / This part number includes one clutch disc	(67)
			 1878 001 082 ▽	350 10 350GTZ	Getr. / GBox: R/SR1400,1700 Lose Kupplungsscheibe / Loose clutch disc	(41)
			 3482 056 031	350 GMFZ2/350	Getr. / GBox: R/SR1400,1700 In 3483/3488 enthalten / Contained in 3483, 3488	(32)
			 3459 000 009	350 GMFZ2/350	Getr. / GBox: R/SR1400,1700 In 3483/3488 enthalten / Contained in 3483, 3488	(32)
			 3400 032 033 #⊕ ⊗ 3483 014 131 ⊗ 1878 001 080 ⊗ 1878 001 082 ⊗ 3474 012 000	350 10 GMFZ2/350 350GTZ 350GTZ	Getr. / GBox: SR62 ohne Zwischenring / without intermediate ring	(106)
			 1878 001 082 ▽	350 10 350GTZ	Getr. / GBox: SR62 Lose Kupplungsscheibe / Loose clutch disc	(41)
			 3482 056 031	350 GMFZ2/350	Getr. / GBox: SR62 In 3483/3488 enthalten / Contained in 3483, 3488	(32)
			 3459 000 009	350 GMFZ2/350	Getr. / GBox: SR62 In 3483/3488 enthalten / Contained in 3483, 3488	(32)
		KFD116B	 3400 700 301 #⊕ ⊗ 3483 022 031 ⊗ 1862 349 031	400 10 MFZ400X 400GVZ	Getr. / GBox: R/SR1400/1700	
			 3482 101 032	400 MFZ400X	Getr. / GBox: R/SR1400/1700 In 3483/3488 enthalten / Contained in 3483, 3488	(32)
		KFD117B	 3482 123 235	430 MFZ430	Getr. / GBox: R/SR62 In 3483/3488 enthalten / Contained in 3483, 3488	(32)
		KFD117B, C	 3400 106 031 ⊕ ⊗ 3483 034 032 ⊗ 1862 530 231	430 10 MFZ430 430WGTZ	Getr. / GBox: R/SR1400,1700	
			 3400 040 032 ●⊕ ⊗ 3483 034 032 ⊗ 1878 004 456	430 10 MFZ430 430GVZ	Getr. / GBox: R/SR1400,1700	
			 3482 123 235	430 MFZ430	Getr. / GBox: R/SR1400,1700 In 3483/3488 enthalten / Contained in 3483, 3488	(32)







		CODE				
--	--	------	--	---	---	---























VOLVO

FL 10		09.85 - 09.98					
FL 10/260	01.85 - 12.89	KFD116B		3400 700 301 #⊕ ⊕ 3483 022 031 ⊕ 1862 349 031	400 10 MFZ400X 400GVZ	Getr. / GBox: R/SR1400/1700	
FL 10/280	09.85 - 12.90			3482 101 032	400 MFZ400X	Getr. / GBox: R/SR1400/1700 In 3483/3488 enthalten / Contained in 3483, 3488	(32)
FL 10/285	01.90 - 12.95			3482 123 235	430 MFZ430	Getr. / GBox: R/SR62 In 3483/3488 enthalten / Contained in 3483, 3488	(32)
FL 10/290	01.88 - 12.89			3400 040 032 ⊕ ⊕ 3483 034 032 ⊕ 1878 004 456	430 10 MFZ430 430GVZ	Getr. / GBox: R/SR1400/1700	
FL 10/320	01.90 - 12.95	KFD117B		3482 123 235	430 MFZ430	Getr. / GBox: R/SR1400/1700 In 3483/3488 enthalten / Contained in 3483, 3488	(32)
FL 10/320	12.95 - 09.98			3482 123 235	430 MFZ430	Getr. / GBox: R/SR1400/1700 In 3483/3488 enthalten / Contained in 3483, 3488	(32)
FL 10/360	12.95 - 09.98			3400 040 032 ⊕ ⊕ 3483 034 032 ⊕ 1878 004 456	430 10 MFZ430 430GVZ	Getr. / GBox: R/SR1400/1700	
FL 10H/320	12.95 - 09.98	KFD117C, H		3482 123 235	430 MFZ430	Getr. / GBox: R/SR1400/1700 In 3483/3488 enthalten / Contained in 3483, 3488	(32)
FL 10H/360	12.95 - 09.98			3400 040 032 ⊕ ⊕ 3483 034 032 ⊕ 1878 004 456	430 10 MFZ430 430GVZ	Getr. / GBox: R/SR1400/1700	
				3400 106 031 ●⊕ ⊕ 3483 034 032 ⊕ 1862 530 231	430 10 MFZ430 430WGTZ	Getr. / GBox: R/SR1400/1700	
		KFD214A		3482 123 235	430 MFZ430	Getr. / GBox: R/SR1400/1700 In 3483/3488 enthalten / Contained in 3483, 3488	(32)
				3400 032 033 #⊕ ⊕ 3483 014 131 ⊕ 1878 001 080 ⊕ 1878 001 082 ⊕ 3474 012 000	350 10 GMFZ2/350 350GTZ 350GTZ	Getr. / GBox: R/SR62 ohne Zwischenring / without intermediate ring	(106)
				1878 001 082 ▽	350 10 350GTZ	Getr. / GBox: R/SR62 Lose Kupplungsscheibe / Loose clutch disc	(41)
				3482 056 031	350 GMFZ2/350	Getr. / GBox: R/SR62 In 3483/3488 enthalten / Contained in 3483, 3488	(32)
				3459 000 009	350 GMFZ2/350	Getr. / GBox: R/SR62 In 3488 enthalten / Contained in 3488	(33)
				3400 031 033 ⊕ ⊕ 3483 014 132 ⊕ 1878 001 080 ⊕ 1878 001 082 ⊕ 3474 012 000	350 10 GMFZ2/350 350GTZ 350GTZ	Getr. / GBox: R/SR1400/1700 ohne Zwischenring / without intermediate ring	(106)
				3488 013 138 ⊕	350 GMFZ2/350	Getr. / GBox: R/SR1400/1700 enthält eine Kupplungsscheibe / This part number includes one clutch disc	(67)
				1878 001 082 ▽	350 10 350GTZ	Getr. / GBox: R/SR1400/1700 Lose Kupplungsscheibe / Loose clutch disc	(41)
				3482 056 031	350 GMFZ2/350	Getr. / GBox: R/SR1400/1700 In 3483/3488 enthalten / Contained in 3483, 3488	(32)
				3459 000 009	350 GMFZ2/350	Getr. / GBox: R/SR1400/1700 In 3483/3488 enthalten / Contained in 3483, 3488	(32)

FL 12		09.95 - 09.98					
Mot. D 12 A	01.95 -	CL43S-O		3400 043 032 ⊕ ⊕ 3483 034 033 ⊕ 1878 634 026	430 10 MFZ430 430WGTZ	Getr. / GBox: R/SR1700,1900	
FL 12/380	09.95 - 09.98			3482 123 234	430 MFZ430	Getr. / GBox: R/SR1700,1900 In 3483/3488 enthalten / Contained in 3483, 3488	(32)
FL 12/420	09.95 - 09.98			3400 700 426 ⊕ ⊕ 3488 019 031 ⊕ 1862 415 031	380 10 GMFZ2/380 380WGVZ	Getr. / GBox: R/SR1700,1900	
FL 12H/380	09.95 - 09.98			3400 700 325 ⊕ ⊕ 3483 027 231 ⊕ 1862 248 033 ⊕ 1862 415 031	380 10 GMFZ2/380 380GVZ 380WGVZ	Getr. / GBox: R/SR1700,1900 ohne Zwischenring / without intermediate ring	(106)
FL 12H/420	09.95 - 09.98	CL38D-O		3482 111 031	380 GMFZ2/380	Getr. / GBox: R/SR1700,1900 In 3483/3488 enthalten / Contained in 3483, 3488	(32)
				3459 017 031	380 GMFZ2/380	Getr. / GBox: R/SR1700,1900 In 3488 enthalten / Contained in 3488	(33)













































VOLVO

FL II		05.06 -			
FL 240-12	05.06-		3400 700 466	395 10	Getr. / GBox: ZTO1006, ZTO1109
FL 240-14	06.09-		 3482 634 003	MF395	
FL 240-14	06.09-		 1878 634 034	395WGTZ	Getr. / GBox: ATO1056
FL 240-15	05.06-		 3151 000 752	KZIS-4	
FL 240-16	05.06-		1863 869 039	52	
FL 240-16	05.06-				
FL 240-16	06.09-				
FL 240-18	05.06-				
FL 260-12	06.09-				
FL 260-14	06.09-				
FL 260-15	06.09-				
FL 260-16	06.09-				
FL 260-18	06.09-				
FL 280-12	05.06-				
FL 280-14	06.09-				
FL 280-15	05.06-				
FL 280-16	05.06-				
FL 280-18	05.06-				
FL 290-12	06.09-				
FL 290-14	06.09-				
FL 290-16	06.09-				
FL 290-18	06.09-				





























FL III		05.13 -					
FL 210-10	05.13-		3400 700 627	395 10	Getr. / GBox: 6AS 800TO Getr. / GBox: 6AS 1000TO Getr. / GBox: 6S 800, 6S 1000TO		
FL 210-12	05.13-		 3482 634 003	MF395			
FL 210-14	05.13-		 1878 007 934	395WGTZ	Getr. / GBox: 6AS 800TO Getr. / GBox: 6AS 1000TO Getr. / GBox: 6S 800, 6S 1000TO		
FL 210-16	05.13-		 3151 000 752	KZIS-4			
FL 240-10	05.13-		1863 869 039	52	Getr. / GBox: ZF 6S/6AS-800/1000		
FL 240-12	05.13-						
FL 240-14	05.13-						
FL 240-16	05.13-						
FL 240-12	05.13-		3400 710 060	430 24	Getr. / GBox: AT 2412 D		
FL 240-14	05.13-		 3482 001 307	MF430			
FL 240-15	05.13-		 1878 003 867	430WGTZ			
FL 240-16	05.13-		 6482 000 155	PHIS-6/38			
FL 240-18	05.13-		1863 869 039	52	Getr. / GBox: ZTO 1006 / ZTO 1109		
FL 260-12	05.13-						
FL 260-14	05.13-						
FL 260-15	05.13-						
FL 260-16	05.13-						
FL 260-18	05.13-						
FL 280-12	05.13-						
FL 280-14	05.13-						
FL 280-16	05.13-						
FL 280-18	05.13-						
FL 290-12	05.13-						
FL 290-14	05.13-						
FL 290-16	05.13-						
FL 290-18	05.13-						
FL 250-12	05.13-			3400 700 466		395 10	Getr. / GBox: ZF6S 1000 TO
FL 250-14	05.13-			 3482 634 003		MF395	
FL 250-16	05.13-			 1878 634 034		395WGTZ	Getr. / GBox: ZF6AS 1000 TO
FL 250-18	05.13-			 3151 000 752		KZIS-4	
FL 280-12	05.13-		3400 700 628	395 10	Getr. / GBox: ZF6S 1000 TO Getr. / GBox: ZF6AS 1000 TO		
FL 280-14	05.13-		 3482 634 003	MF395			
FL 280-16	05.13-		 1878 007 939	395WGTZ			
FL 280-18	05.13-		 3151 000 752	KZIS-4			
FL 280-16	06.16-		1863 869 039	52	Getr. / GBox: ZF6S 1000 TO Getr. / GBox: ZF6AS 1000 TO		
FL 280-18	05.13-		 3151 000 752				

		CODE				
--	--	------	--	---	---	---

VOLVO



























FLC		09.96 - 09.00					
FLC 140	09.96-09.00	KB112		3482 008 244	310 MF310		
				1878 021 731	310 10 310WGTZ		
				3182 998 501	HHIS-3	ohne Sensor / without sensor Füllmedium: Bremsflüssigkeit / Fill Medium: Brake Fluid Immer erneuern / Renew everytime	(105) (25) (30)
FM		09.05 -					
FM 420	06.16-			3400 710 064  3482 001 310  1878 007 170  6482 000 155	430 24 MF430 430WGTZ PHIS-6/38	Getr. / GBox: AT 24112F / AT 2612F Getr. / GBox: ATO 2612F	
FM 460	06.16-			3400 700 600 ⊕  3483 000 348  1878 007 046	430 24 MFZ430 430WGTZ	Getr. / GBox: VT2214B / VTO 2214B Getr. / GBox: VT2514B / VTO 2514B	
FM 420	04.12-			3189 600 061		Getr. / GBox: VT2214B / VTO 2214B Getr. / GBox: VT2514B / VTO 2514B	
FM 460	04.12-			3400 710 064  3482 001 310  1878 007 170  6482 000 155	430 24 MF430 430WGTZ PHIS-6/38	Getr. / GBox: AT 2612F / ATO 2612F	
FM 500	06.16-			3400 700 600 ⊕  3483 000 348  1878 007 046	430 24 MFZ430 430WGTZ	Getr. / GBox: VT2214B / VTO 2214B	
FM 500	04.12-			3189 600 061		Getr. / GBox: VT2214B / VTO 2214B	
FM 370	06.16-			3483 000 382 ⊕	430 MFZ430	Getr. / GBox: VT 2009B	
FM 330	06.16-			1878 007 046	430 24 430WGTZ	Getr. / GBox: VT 2009B	
FM 410	06.16-			3100 026 434 ◦ 3151 000 163 ◎ 3180 000 009	KZIZ-5 KZISZ-5	Getr. / GBox: VT 2009B Beinhaltet Ausrücker und Montagesatz / Contains releaser and fitting kit In 3483/3488 enthalten / Contained in 3483, 3488	(9) (32)
				3189 600 061		Getr. / GBox: VT 2009B	
				3400 700 600 ⊕  3483 000 348  1878 007 046	430 24 MFZ430 430WGTZ	Getr. / GBox: VT2214B / VTO 2214B	
				3189 600 061		Getr. / GBox: VT2214B / VTO 2214B	
FM 450	06.16-			3400 700 600 ⊕  3483 000 348  1878 007 046	430 24 MFZ430 430WGTZ	Getr. / GBox: VT2214B / VTO 2214B Getr. / GBox: VT2514B / VTO 2514B	
FM 450	09.05-			3189 600 061		Getr. / GBox: VT2214B / VTO 2214B Getr. / GBox: VT2514B / VTO 2514B	
FM 300	09.05-			3400 710 060  3482 001 307  1878 003 867  6482 000 155	430 24 MF430 430WGTZ PHIS-6/38	Mot. D9A300, D9B300 Getr. / GBox: AT2412C, AT2512C	
				1863 869 037	72	Mot. D9A300, D9B300 Getr. / GBox: AT2412C, AT2512C	
				3400 700 471 ⊕  3483 034 034  1878 001 215	430 24 MFZ430 430WGTZ	Mot. D9A300, D9B300 Getr. / GBox: VT2214B, VTO2214B	
				1863 869 037	72	Mot. D9A300, D9B300 Getr. / GBox: VT2214B, VTO2214B	
				3400 700 472 ⊕  3483 034 033  1878 005 284	430 24 MFZ430 430WGTZ	Mot. D9A300, D9B300 Getr. / GBox: VT2009B	
				1863 869 037	72	Mot. D9A300, D9B300 Getr. / GBox: VT2009B	
				3189 600 061			

VOLVO





















FM	09.05 -					
FM 300 FM 330	09.05- 04.12-		 3400 710 060 ⊕ 3482 001 307 ⊕ 1878 003 867 ⊕ 6482 000 155	430 24 MF430 430WGTZ PHIS-6/38	Mot. D9B300 Getr. / GBox: AT2412C, AT2512C	
			 1863 869 037	72	Mot. D9B300 Getr. / GBox: AT2412C, AT2512C	
			 3400 700 471 ⊕ ⊕ 3483 034 034 ⊕ 1878 001 215	430 24 MFZ430 430WGTZ	Mot. D9B300 Getr. / GBox: VT2214B, VTO2214B	
			 1863 869 037	72	Mot. D9B300 Getr. / GBox: VT2214B, VTO2214B	
			 3400 700 472 ⊕ ⊕ 3483 034 033 ⊕ 1878 005 284	430 24 MFZ430 430WGTZ	Mot. D9B300 Getr. / GBox: VT2009B	
			 1863 869 037	72	Mot. D9B300 Getr. / GBox: VT2009B	
			 3189 600 061			
FM 330 FM 330	09.05 - 09.05 -	CD38B-O	 3400 700 348 ⊕ ⊕ 3488 019 032 ⊕ 1878 001 216	380 24 GMFZ2/380 380WGVZ	Mot. D11C330	
		CD40B-O	 3400 700 360 ⊕ ⊕ 3488 000 159 ⊕ 1878 003 768	400 24 MFZ2/400X 400WGTZ	Mot. D11C330 Getr. / GBox: VT2214B, VT2514B Getr. / GBox: VTO2214B, VTO2514B	
		CS43B-O	 3400 700 358 ⊖ ⊕ 3482 001 307 ⊕ 1878 003 867	430 24 MF430 430WGTZ PHIS-6/38	Mot. D11C330 Getr. / GBox: AT2412D, AT2612D Getr. / GBox: ATO2612D	
			 6482 000 155		Mot. D11C330 Getr. / GBox: AT2412D, AT2612D Getr. / GBox: ATO2612D	
		CS43B-OR	 3400 700 478 ⊕ ⊕ 3483 000 382 ⊕ 1878 006 129	430 24 MFZ430 430WGTZ	Mot. D11C330 Getr. / GBox: VT2009B Euro 5 / Euro 5	(17)
			 3400 700 463 ⊕ ⊕ 3483 000 348 ⊕ 1878 006 129	430 24 MFZ430 430WGTZ	Mot. D11C330 Getr. / GBox: VT2214B, VT2514B Getr. / GBox: VTO2214B, VTO2514B Euro 5 / Euro 5	(17)
 3189 600 061						
FM 340	09.05 -		 3400 710 060 ⊕ 3482 001 307 ⊕ 1878 003 867 ⊕ 6482 000 155	430 24 MF430 430WGTZ PHIS-6/38	Mot. D9B340 Getr. / GBox: AT2412C, AT2512C	
			 1863 869 037	72	Mot. D9B340 Getr. / GBox: AT2412C, AT2512C	
			 3400 700 343 ⊕ ⊕ 3483 034 034 ⊕ 1878 000 634	430 24 MFZ430 430WGTZ	Mot. D9B340 Getr. / GBox: VT2214B, VTO2214B	
			 1863 869 037	72	Mot. D9B340 Getr. / GBox: VT2214B, VTO2214B	
			 3400 700 342 ⊕ ⊕ 3483 034 033 ⊕ 1878 000 634	430 24 MFZ430 430WGTZ	Mot. D9B340 Getr. / GBox: VT2009B	
			 1863 869 037	72	Mot. D9B340 Getr. / GBox: VT2009B	
			 3189 600 061			
FM 340	09.05 -		 3400 710 060 ⊕ 3482 001 307 ⊕ 1878 003 867 ⊕ 6482 000 155	430 24 MF430 430WGTZ PHIS-6/38	Mot. D9A340, D9B340 Getr. / GBox: AT2412C, AT2512C	
			 1863 869 037	72	Mot. D9A340, D9B340 Getr. / GBox: AT2412C, AT2512C	
			 3400 700 343 ⊕ ⊕ 3483 034 034 ⊕ 1878 000 634	430 24 MFZ430 430WGTZ	Mot. D9A340, D9B340 Getr. / GBox: VT2214B, VTO2214B	
			 1863 869 037	72	Mot. D9A340, D9B340 Getr. / GBox: VT2214B, VTO2214B	
			 3400 700 342 ⊕ ⊕ 3483 034 033 ⊕ 1878 000 634	430 24 MFZ430 430WGTZ	Mot. D9A340, D9B340 Getr. / GBox: VT2009B	
			 1863 869 037	72	Mot. D9A340, D9B340 Getr. / GBox: VT2009B	
			 3189 600 061			

		CODE				
--	--	------	--	---	---	---

VOLVO

























FM		09.05 -					
FM 360 FM 360	09.05- 11.05-	CS43B-O	 1878 006 129	430 24 430WGTZ	Mot. D13A360, D13B360 Getr. / GBox: VT2009B Euro 5 / Euro 5	(17)	
			 3100 026 434 • 3151 000 163 ◎ 3180 000 009	KZIZ-5 KZISZ-5	Mot. D13A360, D13B360 Getr. / GBox: VT2009B Beinhaltet Ausrücker und Montagesatz / Contains releaser and fitting kit In 3483/3488 enthalten / Contained in 3483, 3488	(9) (32)	
	CS43B-OR	 1878 006 129	430 24 430WGTZ	Mot. D13A360, D13B360 Getr. / GBox: VT2009B Euro 5 / Euro 5	(17)		
		 3100 026 434 • 3151 000 163 ◎ 3180 000 009	KZIZ-5 KZISZ-5	Mot. D13A360, D13B360 Getr. / GBox: VT2009B Beinhaltet Ausrücker und Montagesatz / Contains releaser and fitting kit In 3483/3488 enthalten / Contained in 3483, 3488	(9) (32)		
	CS43B-O/OR		 3400 700 463 ⊕ ◎ 3483 000 348 ● 1878 006 129	430 24 MFZ430 430WGTZ	Mot. D13A360, D13B360 Getr. / GBox: VT2214B, VT2514B Getr. / GBox: VTO2214B, VTO2514B Euro 5 / Euro 5	(17)	
			 3400 710 061 # ◎ 3482 000 553 ● 1878 007 046 ▼ 6482 000 155	430 24 MF430 430WGTZ PHIS-6/38	Mot. D13A360, D13B360 Getr. / GBox: AT2412C, AT2512C Getr. / GBox: ATO2512C Euro 5 / Euro 5	(17)	
			 3400 710 066 ● ◎ 3482 001 308 ● 1878 007 046 ▼ 6482 000 155	430 24 MF430 430WGTZ PHIS-6/38	Mot. D13A360, D13B360 Getr. / GBox: AT2412C, AT2512C Getr. / GBox: ATO2512C Euro 6 / Euro 6	(18)	
			 3400 700 478 ⊕ ◎ 3483 000 382 ● 1878 006 129	430 24 MFZ430 430WGTZ	Mot. D13A360, D13B360 Getr. / GBox: VT2009B Euro 5 / Euro 5	(17)	
	CD38B-O		 3400 700 348 ⊕ ◎ 3488 019 032 ● 1878 001 216	380 24 GMFZ2/380 380WGVZ	Mot. D13A360, D13B360		
			 3483 027 332 ⊕	380 GMFZ2/380	Mot. D13A360, D13B360 In 3483/3488 enthalten / Contained in 3483, 3488	(32)	
			 3482 111 031	380 GMFZ2/380	Mot. D13A360, D13B360 In 3483/3488 enthalten / Contained in 3483, 3488	(32)	
			 3459 017 031	380 GMFZ2/380	Mot. D13A360, D13B360 In 3488 enthalten / Contained in 3488	(33)	
			 1862 248 033 △	380 8 380GVZ	Mot. D13A360, D13B360 In 3488 enthalten / Contained in 3488	(33)	
	CD40B-O		 3400 700 360 ⊕ ◎ 3488 000 159 ● 1878 003 768	400 24 MFZ2/400X 400WGTZ	Mot. D13A360, D13B360		
			 3483 034 135 ⊕	400 MFZ2/400X	Mot. D13A360, D13B360 In 3488 enthalten / Contained in 3488	(33)	
			 3459 018 004	400 MFZ2/400X	Mot. D13A360, D13B360 In 3488 enthalten / Contained in 3488	(33)	
	FM 370 FM 370 FM 370 FM 370 FM 370 FM 370 FM 370 FM 370	09.05- 09.05-	CD38B-O	 3400 700 348 ⊕ ◎ 3488 019 032 ● 1878 001 216	380 24 GMFZ2/380 380WGVZ	Mot. D11C370	
				06.08- 06.08-	CD40B-O	 3400 700 360 ⊕ ◎ 3488 000 159 ● 1878 003 768	400 24 MFZ2/400X 400WGTZ
03.12- 03.12-		CS43B-O	 3400 700 358 ⊖ ◎ 3482 001 307 ● 1878 003 867			430 24 MF430 430WGTZ	Mot. D11C370 Getr. / GBox: AT2412D, AT2612D Getr. / GBox: ATO2612D
			04.12- 01.14-	CS43B-OR	 6482 000 155	PHIS-6/38	Mot. D11C370 Getr. / GBox: AT2412D, AT2612D Getr. / GBox: ATO2612D
 3400 700 478 ⊕ ◎ 3483 000 382 ● 1878 006 129		430 24 MFZ430 430WGTZ			Mot. D11C370 Getr. / GBox: VT2009B Euro 5 / Euro 5	(17)	
 3400 700 463 ⊕ ◎ 3483 000 348 ● 1878 006 129		430 24 MFZ430 430WGTZ	Mot. D11C370 Getr. / GBox: VT2214B, VT2514B Getr. / GBox: VTO2214B, VTO2514B Euro 5 / Euro 5	(17)			
 3189 600 061							

VOLVO















FM	09.05 -					
FM 380	09.05-		 3400 710 060 ⊕ 3482 001 307 ⊕ 1878 003 867 ⊕ 6482 000 155	430 24 MF430 430WGTZ PHIS-6/38	Mot. D9B380 Getr. / GBox: AT2412C,AT2512C	
			 1863 869 037	72	Mot. D9B380 Getr. / GBox: AT2412C,AT2512C	
			 3400 700 343 ⊕ ⊕ 3483 034 034 ⊕ 1878 000 634	430 24 MFZ430 430WGTZ	Mot. D9B380 Getr. / GBox: VT2214B,VTO2214B	
			 1863 869 037	72	Mot. D9B380 Getr. / GBox: VT2214B,VTO2214B	
			 3400 700 342 ⊕ ⊕ 3483 034 033 ⊕ 1878 000 634	430 24 MFZ430 430WGTZ	Mot. D9B380 Getr. / GBox: VT2009B	
			 1863 869 037	72	Mot. D9B380 Getr. / GBox: VT2009B	
			 3189 600 061			
FM 380 FM 380 FM 390 FM 420 FM 460 FM 500	01.14- 04.12- 06.08- 04.12- 04.12- 04.12-	CD40B-O	 3400 700 629 ⊕ ⊕ 3488 000 373 ⊕ 1878 007 366	400 24 MFZ2/400X 400WGTZ	Getr. / GBox: VT 2214B / VTO 2214B Getr. / GBox: VT 2514B / VTO 2514B Getr. / GBox: VT 2814B / VTO 2814B für Fahrzeuge mit Zweis Scheibenkupplung / for vehicles with double disc clutch mit Zwischenring / with intermediate ring	(77) (94)
FM 380	09.05-	CD38B-O	 3400 700 348 ⊕ ⊕ 3488 019 032 ⊕ 1878 001 216	380 24 GMFZ2/380 380WGVZ	Mot. D13C380	
			 1863 869 037	72	Mot. D13C380	
		CD40B-O	 3400 700 360 ⊕ ⊕ 3488 000 159 ⊕ 1878 003 768	400 24 MFZ2/400X 400WGTZ	Mot. D13C380 Getr. / GBox: VT2214B, VT2514B Getr. / GBox: VTO2214B, VTO2514B	
			 1863 869 037	72	Mot. D13C380 Getr. / GBox: VT2214B, VT2514B Getr. / GBox: VTO2214B, VTO2514B	
			 3400 700 629 ⊕ ⊕ 3488 000 373 ⊕ 1878 007 366	400 24 MFZ2/400X 400WGTZ	Getr. / GBox: VT 2214B / VTO 2214B Getr. / GBox: VT 2514B / VTO 2514B Getr. / GBox: VT 2814B / VTO 2814B für Fahrzeuge mit Zweis Scheibenkupplung / for vehicles with double disc clutch mit Zwischenring / with intermediate ring	(77) (94)
		CS43B-O	 3400 700 618 ● ⊕ 3482 001 308 ⊕ 1878 007 046	430 24 MF430 430WGTZ	Mot. D13C380 Getr. / GBox: AT2412D, AT2612D Getr. / GBox: ATO2612D Euro 6 / Euro 6	(18)
			 6482 000 155	PHIS-6/38	Mot. D13C380 Getr. / GBox: AT2412D, AT2612D Getr. / GBox: ATO2612D	
			 1863 869 037	72	Mot. D13C380 Getr. / GBox: AT2412D, AT2612D Getr. / GBox: ATO2612D	
		CS43B-OR	 3400 700 478 ⊕ ⊕ 3483 000 382 ⊕ 1878 006 129	430 24 MFZ430 430WGTZ	Mot. D13C380 Getr. / GBox: VT2009B Euro 5 / Euro 5	(17)
			 1863 869 037	72	Mot. D13C380 Getr. / GBox: VT2009B	
			 3400 700 463 ⊕ ⊕ 3483 000 348 ⊕ 1878 006 129	430 24 MFZ430 430WGTZ	Mot. D13C380 Getr. / GBox: VT2214B, VT2514B Getr. / GBox: VTO2214B, VTO2514B Euro 5 / Euro 5	(17)
			 1863 869 037	72	Mot. D13C380 Getr. / GBox: VT2214B, VT2514B Getr. / GBox: VTO2214B, VTO2514B	
		 3189 600 061				

		CODE				
--	--	------	--	---	---	---

VOLVO











































FM		09.05 -						
FM 400	09.05-	CS43B-O	 1878 006 129	430 24 430WGTZ	Mot. D13A400, D13B400 Getr. / GBox: VT2009B Euro 5 / Euro 5	(17)		
			 3100 026 434 • 3151 000 163 ◎ 3180 000 009	KZIZ-5 KZISZ-5	Mot. D13A400, D13B400 Getr. / GBox: VT2009B Beinhaltet Ausrücker und Montagesatz / Contains releaser and fitting kit In 3483/3488 enthalten / Contained in 3483, 3488	(9) (32)		
		CS43B-OR	 1878 006 129	430 24 430WGTZ	Mot. D13A400, D13B400 Getr. / GBox: VT2009B Euro 5 / Euro 5	(17)		
			 3100 026 434 • 3151 000 163 ◎ 3180 000 009	KZIZ-5 KZISZ-5	Mot. D13A400, D13B400 Getr. / GBox: VT2009B Beinhaltet Ausrücker und Montagesatz / Contains releaser and fitting kit In 3483/3488 enthalten / Contained in 3483, 3488	(9) (32)		
		CS43B-O/OR	 3400 700 463 ⊕ ◎ 3483 000 348 ● 1878 006 129	430 24 MFZ430 430WGTZ	Mot. D13A400, D13B400 Getr. / GBox: VT2214B, VT2514B Getr. / GBox: VTO2214B, VTO2514B Euro 5 / Euro 5	(17)		
			 3400 710 061 # ◎ 3482 000 553 ● 1878 007 046 ▼ 6482 000 155	430 24 MF430 430WGTZ PHIS-6/38	Mot. D13A400, D13B400 Getr. / GBox: AT2412C, AT2512C Getr. / GBox: ATO2512C Euro 5 / Euro 5	(17)		
			 3400 710 066 ● ◎ 3482 001 308 ● 1878 007 046 ▼ 6482 000 155	430 24 MF430 430WGTZ PHIS-6/38	Mot. D13A400, D13B400 Getr. / GBox: AT2412C, AT2512C Getr. / GBox: ATO2512C Euro 6 / Euro 6	(18)		
			 3400 700 478 ⊕ ◎ 3483 000 382 ● 1878 006 129	430 24 MFZ430 430WGTZ	Mot. D13A400, D13B400 Getr. / GBox: VT2009B Euro 5 / Euro 5	(17)		
		CD38B-O	 3400 700 348 ⊕ ◎ 3488 019 032 ● 1878 001 216	380 24 GMFZ2/380 380WGVZ	Mot. D13A400, D13B400			
			 3483 027 332 ⊕	380 GMFZ2/380	Mot. D13A400, D13B400 In 3483/3488 enthalten / Contained in 3483, 3488	(32)		
			 3482 111 031	380 GMFZ2/380	Mot. D13A400, D13B400 In 3483/3488 enthalten / Contained in 3483, 3488	(32)		
			 3459 017 031	380 GMFZ2/380	Mot. D13A400, D13B400 In 3488 enthalten / Contained in 3488	(33)		
			 1862 248 033 △	380 8 380GVZ	Mot. D13A400, D13B400 In 3488 enthalten / Contained in 3488	(33)		
		CD40B-O	 3400 700 360 ⊕ ◎ 3488 000 159 ● 1878 003 768	400 24 MFZ2/400X 400WGTZ	Mot. D13A400, D13B400			
			 3483 034 135 ⊕	400 MFZ2/400X	Mot. D13A400, D13B400 In 3488 enthalten / Contained in 3488	(33)		
			 3459 018 004	400 MFZ2/400X	Mot. D13A400, D13B400 In 3488 enthalten / Contained in 3488	(33)		
			 1863 869 037	72				
			 3189 600 061					
		FM 410 FM 410 FM 410	09.05- 09.05- 04.12-	CD38B-O	 3400 700 348 ⊕ ◎ 3488 019 032 ● 1878 001 216	380 24 GMFZ2/380 380WGVZ	Mot. D11C410	
				CD40B-O	 3400 700 360 ⊕ ◎ 3488 000 159 ● 1878 003 768	400 24 MFZ2/400X 400WGTZ	Mot. D11C410 Getr. / GBox: VT2214B, VT2514B Getr. / GBox: VTO2214B, VTO2514B	
CS43B-O	 3400 700 358 ⊖ ◎ 3482 001 307 ● 1878 003 867			430 24 MF430 430WGTZ	Mot. D11C410 Getr. / GBox: AT2412D, AT2612D Getr. / GBox: ATO2612D			
	 6482 000 155			PHIS-6/38	Mot. D11C410 Getr. / GBox: AT2412D, AT2612D Getr. / GBox: ATO2612D			
CS43B-OR	 3400 700 478 ⊕ ◎ 3483 000 382 ● 1878 006 129			430 24 MFZ430 430WGTZ	Mot. D11C410 Getr. / GBox: VT2009B Euro 5 / Euro 5	(17)		
	 3400 700 463 ⊕ ◎ 3483 000 348 ● 1878 006 129			430 24 MFZ430 430WGTZ	Mot. D11C410 Getr. / GBox: VT2214B, VT2514B Getr. / GBox: VTO2214B, VTO2514B Euro 5 / Euro 5	(17)		
		 3189 600 061						

VOLVO















FM		09.05 -						
FM 420 FM 420	09.05 - 09.05 -	CD38B-O	 3400 700 348 ⊕ ⊗ 3488 019 032 ⊗ 1878 001 216	380 24 GMFZ2/380 380WGVZ	Mot. D13C420			
			 1863 869 037	72	Mot. D13C420			
	CD40B-O	 3400 700 360 ⊕ ⊗ 3488 000 159 ⊗ 1878 003 768	400 24 MFZ2/400X 400WGTZ	Mot. D13C420 Getr. / GBox: VT2214B, VT2514B Getr. / GBox: VTO2214B, VTO2514B				
		 1863 869 037	72	Mot. D13C420 Getr. / GBox: VT2214B, VT2514B Getr. / GBox: VTO2214B, VTO2514B				
		 3400 700 629 ⊕ ⊗ 3488 000 373 ⊗ 1878 007 366	400 24 MFZ2/400X 400WGTZ	Getr. / GBox: VT 2214B / VTO 2214B Getr. / GBox: VT 2514B / VTO 2514B Getr. / GBox: VT 2814B / VTO 2814B für Fahrzeuge mit Zweis Scheibenkupplung / for vehicles with double disc clutch mit Zwischenring / with intermediate ring	(77)	(94)		
	CS43B-O	 3400 700 618 ● ⊕ ⊗ 3482 001 308 ⊗ 1878 007 046	430 24 MF430 430WGTZ	Mot. D13C420 Getr. / GBox: AT2412D, AT2612D Getr. / GBox: ATO2612D Euro 6 / Euro 6		(18)		
		 6482 000 155	PHIS-6/38	Mot. D13C420 Getr. / GBox: AT2412D, AT2612D Getr. / GBox: ATO2612D				
		 1863 869 037	72	Mot. D13C420 Getr. / GBox: AT2412D, AT2612D Getr. / GBox: ATO2612D				
	CS43B-OR	 3400 700 478 ⊕ ⊗ 3483 000 382 ⊗ 1878 006 129	430 24 MFZ430 430WGTZ	Mot. D13C420 Getr. / GBox: VT2009B Euro 5 / Euro 5		(17)		
		 1863 869 037	72	Mot. D13C420 Getr. / GBox: VT2009B				
		 3400 700 463 ⊕ ⊗ 3483 000 348 ⊗ 1878 006 129	430 24 MFZ430 430WGTZ	Mot. D13C420 Getr. / GBox: VT2214B, VT2514B Getr. / GBox: VTO2214B, VTO2514B Euro 5 / Euro 5		(17)		
		 1863 869 037	72	Mot. D13C420 Getr. / GBox: VT2214B, VT2514B Getr. / GBox: VTO2214B, VTO2514B				
	FM 420			 3400 700 600 ⊕ ⊗ 3483 000 348 ⊗ 1878 007 046	430 24 MFZ430 430WGTZ	Mot. D13K Getr. / GBox: VT 2214B / VTO 2214B Getr. / GBox: VT 2514B / VTO 2514B Euro 6 / Euro 6		(18)
				 3400 710 064 ⊗ 3482 001 310 ⊗ 1878 007 170  6482 000 155	430 24 MF430 430WGTZ PHIS-6/38	Mot. D13K Getr. / GBox: AT2412/E / AT2612/E, Getr. / GBox: ATO 2612/E Euro 6 / Euro 6		(18)

		CODE				
--	--	------	--	---	---	---

VOLVO























FM		09.05 -					
FM 440 FM 440 FM 440	09.05- 09.05- 09.06-02.12	CS43B-O/OR	 3400 700 463 ⊕  3483 000 348  1878 006 129	430 24 MFZ430 430WGTZ	Mot. D13A440, D13B440 Getr. / GBox: VT2214B, VT2514B Getr. / GBox: VTO2214B, VTO2514B Euro 5 / Euro 5	(17)	
			 3400 710 061 #  3482 000 553  1878 007 046  6482 000 155	430 24 MF430 430WGTZ PHIS-6/38	Mot. D13A440, D13B440 Getr. / GBox: AT2412C, AT2512C Getr. / GBox: ATO2512C Euro 5 / Euro 5	(17)	
			 3400 710 066 ●  3482 001 308  1878 007 046  6482 000 155	430 24 MF430 430WGTZ PHIS-6/38	Mot. D13A440, D13B440 Getr. / GBox: AT2412C, AT2512C Getr. / GBox: ATO2512C Euro 6 / Euro 6	(18)	
	CD38B-O		 3400 700 348 ⊕  3488 019 032  1878 001 216	380 24 GMFZ2/380 380WGVZ	Mot. D13A440, D13B440		
			 3483 027 332 ⊕	380 GMFZ2/380	Mot. D13A440, D13B440 In 3483/3488 enthalten / Contained in 3483, 3488	(32)	
			 3482 111 031	380 GMFZ2/380	Mot. D13A440, D13B440 In 3483/3488 enthalten / Contained in 3483, 3488	(32)	
			 1862 248 033 △	380 8 380GVZ	Mot. D13A440, D13B440 In 3488 enthalten / Contained in 3488	(33)	
			 3459 017 031	380 GMFZ2/380	Mot. D13A440, D13B440 In 3488 enthalten / Contained in 3488	(33)	
	CD40B-O		 3400 700 360 ⊕  3488 000 159  1878 003 768	400 24 MFZ2/400X 400WGTZ	Mot. D13A440, D13B440		
			 3483 034 135 ⊕	400 MFZ2/400X	Mot. D13A440, D13B440 In 3488 enthalten / Contained in 3488	(33)	
			 3459 018 004	400 MFZ2/400X	Mot. D13A440, D13B440 In 3488 enthalten / Contained in 3488	(33)	
			 1863 869 037	72			
			 3189 600 061				
	FM 450 FM 450 FM 450	09.05- 09.05- 04.12-	CD38B-O	 3400 700 348 ⊕  3488 019 032  1878 001 216	380 24 GMFZ2/380 380WGVZ	Mot. D11C450	
			CD40B-O	 3400 700 360 ⊕  3488 000 159  1878 003 768	400 24 MFZ2/400X 400WGTZ	Mot. D11C450 Getr. / GBox: VT2214B, VT2514B Getr. / GBox: VTO2214B, VTO2514B	
CS43B-O		 3400 700 618 ●⊕  3482 001 308  1878 007 046	430 24 MF430 430WGTZ	Mot. D11C450 Getr. / GBox: AT2412D, AT2612D Getr. / GBox: ATO2612D Euro 6 / Euro 6	(18)		
		 6482 000 155	PHIS-6/38	Mot. D11C450 Getr. / GBox: AT2412D, AT2612D Getr. / GBox: ATO2612D			
CS43B-OR		 3400 700 478 ⊕  3483 000 382  1878 006 129	430 24 MFZ430 430WGTZ	Mot. D11C450 Getr. / GBox: VT2009B Euro 5 / Euro 5	(17)		
		 3400 700 463 ⊕  3483 000 348  1878 006 129	430 24 MFZ430 430WGTZ	Mot. D11C450 Getr. / GBox: VT2214B, VT2514B Getr. / GBox: VTO2214B, VTO2514B Euro 5 / Euro 5	(17)		
		 3189 600 061					

VOLVO



























FM		09.05 -						
FM 460 FM 460 FM 460 FM 460	09.05-	CD38B-O		3400 700 348 ⊕ ⊗ 3488 019 032 ⊗ 1878 001 216	380 24 GMFZ2/380 380WGVZ	Mot. D13C460		
	09.05-			1863 869 037	72	Mot. D13C460		
	05.09-	CD40B-O		3400 700 360 ⊕ ⊗ 3488 000 159 ⊗ 1878 003 768	400 24 MFZ2/400X 400WGTZ	Mot. D13C460 Getr. / GBox: VT2214B, VT2514B Getr. / GBox: VTO2214B, VTO2514B		
	05.09-			1863 869 037	72	Mot. D13C460 Getr. / GBox: VT2214B, VT2514B Getr. / GBox: VTO2214B, VTO2514B		
				3400 700 629 ⊕ ⊗ 3488 000 373 ⊗ 1878 007 366	400 24 MFZ2/400X 400WGTZ	Getr. / GBox: VT 2214B / VTO 2214B Getr. / GBox: VT 2514B / VTO 2514B Getr. / GBox: VT 2814B / VTO 2814B für Fahrzeuge mit Zweis Scheibenkupplung / for vehicles with double disc clutch mit Zwischenring / with intermediate ring	(77) (94)	
			CS43B-O		3400 700 618 ●⊕ ⊗ 3482 001 308 ⊗ 1878 007 046	430 24 MF430 430WGTZ	Mot. D13C460 Getr. / GBox: AT2412D, AT2612D Getr. / GBox: ATO2612D Euro 6 / Euro 6	(18)
				6482 000 155	PHIS-6/38	Mot. D13C460 Getr. / GBox: AT2412D, AT2612D Getr. / GBox: ATO2612D		
				1863 869 037	72	Mot. D13C460 Getr. / GBox: AT2412D, AT2612D Getr. / GBox: ATO2612D		
			CS43B-OR		3400 700 478 ⊕ ⊗ 3483 000 382 ⊗ 1878 006 129	430 24 MFZ430 430WGTZ	Mot. D13C460 Getr. / GBox: VT2009B Euro 5 / Euro 5	(17)
				1863 869 037	72	Mot. D13C460 Getr. / GBox: VT2009B		
				3400 700 463 ⊕ ⊗ 3483 000 348 ⊗ 1878 006 129	430 24 MFZ430 430WGTZ	Mot. D13C460 Getr. / GBox: VT2214B, VT2514B Getr. / GBox: VTO2214B, VTO2514B Euro 5 / Euro 5	(17)	
				1863 869 037	72	Mot. D13C460 Getr. / GBox: VT2214B, VT2514B Getr. / GBox: VTO2214B, VTO2514B		
				3189 600 061				
FM 460				3400 700 600 ⊕ ⊗ 3483 000 348 ⊗ 1878 007 046	430 24 MFZ430 430WGTZ	Mot. D13K Getr. / GBox: VT 2814B / VTO 2814B Euro 6 / Euro 6	(18)	
				3400 710 064 ⊗ 3482 001 310 ⊗ 1878 007 170 ⊗ 6482 000 155	430 24 MF430 430WGTZ PHIS-6/38	Mot. D13K Getr. / GBox: AT 2412/E / AT 2612/E Getr. / GBox: ATO 2612/E Euro 6 / Euro 6	(18)	

		CODE					
--	--	------	--	--	---	---	---

VOLVO



FM		09.05 -					
FM 480 FM 480	09.05- 09.06 - 02.12	CS43B-O/OR	 3400 700 463 ⊕ ⊗ 3483 000 348 ⊗ 1878 006 129	430 24 MFZ430 430WGTZ	Mot. D13A480 Getr. / GBox: VT2214B, VT2514B Getr. / GBox: VTO2214B, VTO2514B Euro 5 / Euro 5	(17)	
			 3400 710 061 # ⊗ 3482 000 553 ⊗ 1878 007 046 ⚡ 6482 000 155	430 24 MF430 430WGTZ PHIS-6/38	Mot. D13A480 Getr. / GBox: AT2412C, AT2512C Getr. / GBox: ATO2512C Euro 5 / Euro 5	(17)	
			 3400 710 066 ● ⊗ 3482 001 308 ⊗ 1878 007 046 ⚡ 6482 000 155	430 24 MF430 430WGTZ PHIS-6/38	Mot. D13A480 Getr. / GBox: AT2412C, AT2512C Getr. / GBox: ATO2512C Euro 6 / Euro 6	(18)	
		CD38B-O	 3400 700 348 ⊕ ⊗ 3488 019 032 ⊗ 1878 001 216	380 24 GMFZ2/380 380WGVZ	Mot. D13A480		
			 3483 027 332 ⊕	380 GMFZ2/380	Mot. D13A480 In 3483/3488 enthalten / Contained in 3483, 3488	(32)	
			 3482 111 031	380 GMFZ2/380	Mot. D13A480 In 3483/3488 enthalten / Contained in 3483, 3488	(32)	
			 1862 248 033 △	380 8 380GVZ	Mot. D13A480 In 3488 enthalten / Contained in 3488	(33)	
			 3459 017 031	380 GMFZ2/380	Mot. D13A480 In 3488 enthalten / Contained in 3488	(33)	
		CD40B-O	 3400 700 360 ⊕ ⊗ 3488 000 159 ⊗ 1878 003 768	400 24 MFZ2/400X 400WGTZ	Mot. D13A480		
	 3483 034 135 ⊕		400 MFZ2/400X	Mot. D13A480 In 3488 enthalten / Contained in 3488	(33)		
	 3459 018 004		400 MFZ2/400X	Mot. D13A480 In 3488 enthalten / Contained in 3488	(33)		
		 1863 869 037	72				
		 3189 600 061					
	FM 500	09.05 -	CD38B-O	 3400 700 348 ⊕ ⊗ 3488 019 032 ⊗ 1878 001 216	380 24 GMFZ2/380 380WGVZ	Mot. D13C500	
				 1863 869 037	72	Mot. D13C500	
			CD40B-O	 3400 700 360 ⊕ ⊗ 3488 000 159 ⊗ 1878 003 768	400 24 MFZ2/400X 400WGTZ	Mot. D13C500 Getr. / GBox: VT2214B, VT2514B Getr. / GBox: VTO2214B, VTO2514B	
				 1863 869 037	72	Mot. D13C500 Getr. / GBox: VT2214B, VT2514B Getr. / GBox: VTO2214B, VTO2514B	
				 3400 700 629 ⊕ ⊗ 3488 000 373 ⊗ 1878 007 366	400 24 MFZ2/400X 400WGTZ	Mot. D13C500 Getr. / GBox: VT 2214B / VTO 2214B Getr. / GBox: VT 2514B / VTO 2514B Getr. / GBox: VT 2814B / VTO 2814B für Fahrzeuge mit Zweischeibenkupplung / for vehicles with double disc clutch mit Zwischenring / with intermediate ring	(77) (94)
CS43B-O			 3400 700 618 ● ⊗ 3482 001 308 ⊗ 1878 007 046	430 24 MF430 430WGTZ	Mot. D13C500 Getr. / GBox: AT2412D, AT2612D Getr. / GBox: ATO2612D Euro 6 / Euro 6	(18)	
			 6482 000 155	PHIS-6/38	Mot. D13C500 Getr. / GBox: AT2412D, AT2612D Getr. / GBox: ATO2612D		
			 1863 869 037	72	Mot. D13C500 Getr. / GBox: AT2412D, AT2612D Getr. / GBox: ATO2612D		
CS43B-OR			 3400 700 478 ⊕ ⊗ 3483 000 382 ⊗ 1878 006 129	430 24 MFZ430 430WGTZ	Mot. D13C500 Getr. / GBox: VT2009B Euro 5 / Euro 5	(17)	
			1863 869 037	72	Mot. D13C500 Getr. / GBox: VT2009B		
			3400 700 463 ⊕ ⊗ 3483 000 348 ⊗ 1878 006 129	430 24 MFZ430 430WGTZ	Mot. D13C500 Getr. / GBox: VT2214B, VT2514B Getr. / GBox: VTO2214B, VTO2514B Euro 5 / Euro 5	(17)	
			1863 869 037	72	Mot. D13C500 Getr. / GBox: VT2214B, VT2514B Getr. / GBox: VTO2214B, VTO2514B		
			3189 600 061				











VOLVO



FM	09.05 -					
FM 500	09.05-	CD38B-O	 3400 700 348 ⊕ ⊗ 3488 019 032 ⊗ 1878 001 216	380 24 GMFZ2/380 380WGVZ	Mot. D13B500,D13C500	
			 1863 869 037	72	Mot. D13B500,D13C500	
		CD40B-O	 3400 700 360 ⊕ ⊗ 3488 000 159 ⊗ 1878 003 768	400 24 MFZ2/400X 400WGTZ	Mot. D13B500,D13C500 Getr. / GBox: VT2214B, VT2514B Getr. / GBox: VTO2214B, VTO2514B	
			 1863 869 037	72	Mot. D13B500,D13C500 Getr. / GBox: VT2214B, VT2514B Getr. / GBox: VTO2214B, VTO2514B	
			 3400 700 629 ⊕ ⊗ 3488 000 373 ⊗ 1878 007 366	400 24 MFZ2/400X 400WGTZ	Getr. / GBox: VT 2214B / VTO 2214B Getr. / GBox: VT 2514B / VTO 2514B Getr. / GBox: VT 2814B / VTO 2814B für Fahrzeuge mit Zweis Scheibenkupplung / for vehicles with double disc clutch mit Zwischenring / with intermediate ring	(77) (94)
		CS43B-O	 3400 700 618 ●⊖ ⊗ 3482 001 308 ⊗ 1878 007 046	430 24 MF430 430WGTZ	Mot. D13B500,D13C500 Getr. / GBox: AT2412D, AT2612D Getr. / GBox: ATO2612D Euro 6 / Euro 6	(18)
			 6482 000 155	PHIS-6/38	Mot. D13B500,D13C500 Getr. / GBox: AT2412D, AT2612D Getr. / GBox: ATO2612D	
			 1863 869 037	72	Mot. D13B500,D13C500 Getr. / GBox: AT2412D, AT2612D Getr. / GBox: ATO2612D	
		CS43B-OR	 3400 700 478 ⊕ ⊗ 3483 000 382 ⊗ 1878 006 129	430 24 MFZ430 430WGTZ	Mot. D13B500,D13C500 Getr. / GBox: VT2009B Euro 5 / Euro 5	(17)
			 1863 869 037	72	Mot. D13B500,D13C500 Getr. / GBox: VT2009B	
			 3400 700 463 ⊕ ⊗ 3483 000 348 ⊗ 1878 006 129	430 24 MFZ430 430WGTZ	Mot. D13B500,D13C500 Getr. / GBox: VT2214B, VT2514B Getr. / GBox: VTO2214B, VTO2514B Euro 5 / Euro 5	(17)
			 1863 869 037	72	Mot. D13B500,D13C500 Getr. / GBox: VT2214B, VT2514B Getr. / GBox: VTO2214B, VTO2514B	
			 3189 600 061			
		FM 500			 3400 700 600 ⊕ ⊗ 3483 000 348 ⊗ 1878 007 046	430 24 MFZ430 430WGTZ
 3400 710 064 ⊗ 3482 001 310 ⊗ 1878 007 170 ⊗ 6482 000 155	430 24 MF430 430WGTZ PHIS-6/38				Mot. D13K Getr. / GBox: AT 2612/E /ATO 2612E Euro 6 / Euro 6	(18)
FM 520	01.08-	CS43B-O/OR	 3400 700 463 ⊕ ⊗ 3483 000 348 ⊗ 1878 006 129	430 24 MFZ430 430WGTZ	Getr. / GBox: VT2214B, VT2514B Getr. / GBox: VTO2214B, VTO2514B Euro 5 / Euro 5	(17)
			 3400 700 618 ●⊖ ⊗ 3482 001 308 ⊗ 1878 007 046	430 24 MF430 430WGTZ	Getr. / GBox: AT2412C, AT2512C Getr. / GBox: ATO2512C Euro 6 / Euro 6	(18)
			 6482 000 155	PHIS-6/38	Getr. / GBox: AT2412C, AT2512C Getr. / GBox: ATO2512C	
		CD38B-O	 3400 700 348 ⊕ ⊗ 3488 019 032 ⊗ 1878 001 216	380 24 GMFZ2/380 380WGVZ		
			 3483 027 332 ⊕	380 GMFZ2/380	In 3483/3488 enthalten / Contained in 3483, 3488	(32)
			 3482 111 031	380 GMFZ2/380	In 3483/3488 enthalten / Contained in 3483, 3488	(32)
			 1862 248 033 △	380 8 380GVZ	In 3488 enthalten / Contained in 3488	(33)
			 3459 017 031	380 GMFZ2/380	In 3488 enthalten / Contained in 3488	(33)
			 3400 700 360 ⊕ ⊗ 3488 000 159 ⊗ 1878 003 768	400 24 MFZ2/400X 400WGTZ		
		CD40B-O	 3483 034 135 ⊕	400 MFZ2/400X	In 3488 enthalten / Contained in 3488	(33)
			 3459 018 004	400 MFZ2/400X	In 3488 enthalten / Contained in 3488	(33)
			 3189 600 061			

		CODE				
--	--	------	--	---	---	---











































VOLVO

FM 7		08.98 - 12.01						
FM 7/250	08.98 - 12.01	CL43S-0		3400 127 101 ⊕ ⊗ 3483 034 034 ⊗ 1878 634 026	430 10 MFZ430 430WGTZ	Getr. / GBox: VT2014,2514		
FM 7/290	08.98 - 12.01			3400 127 201 ⊕ ⊗ 3483 034 033 ⊗ 1862 530 231	430 10 MFZ430 430WGTZ	Getr. / GBox: R/SR1400		
					3482 123 234	430 MFZ430	Getr. / GBox: R/SR1400 Getr. / GBox: VT2014,2514 In 3483/3488 enthalten / Contained in 3483, 3488	(32)
					3189 600 061			

FM 9		12.01 - 09.05						
FM 9/260	12.01 - 09.05	CS43B-O/OR		3483 034 033 ⊕	430 MFZ430	Getr. / GBox: VT1708B,VT2009B		
FM 9/300	12.01 - 09.05				3483 034 034 ⊕	430 MFZ430	Getr. / GBox: VT2214B,VTO2214B	
					3483 034 042 ⊕	430 MFZ430	Getr. / GBox: VT2412B	
					1878 001 215	430 24 430WGTZ	Getr. / GBox: VT2412B Getr. / GBox: VT2214B,VTO2214B Getr. / GBox: VT1708B,VT2009B	
					3482 123 234	430 MFZ430	Getr. / GBox: VT2214B,VTO2214B Getr. / GBox: VT1708B,VT2009B Getr. / GBox: VT2412B In 3483/3488 enthalten / Contained in 3483, 3488	(32)
FM 9/260	12.01 - 09.05			3400 700 471 ⊕ ⊗ 3483 034 034 ⊗ 1878 001 215	430 24 MFZ430 430WGTZ	Getr. / GBox: VT2214B / VTO2214B Getr. / GBox: VT2514B		
FM 9/300	12.01 - 09.05							
FM 9/300	12.01 - 09.05							
FM 9/340	12.01 - 09.05	CS43B-O/OR		3400 700 342 ⊕ ⊗ 3483 034 033 ⊗ 1878 000 634	430 24 MFZ430 430WGTZ	Getr. / GBox: VT1708B,VT2009B		
FM 9/380	12.01 - 09.05				3482 123 234	430 MFZ430	Getr. / GBox: VT1708B,VT2009B In 3483/3488 enthalten / Contained in 3483, 3488	(32)
					3400 700 343 ⊕ ⊗ 3483 034 034 ⊗ 1878 000 634	430 24 MFZ430 430WGTZ	Getr. / GBox: VT2214B,VTO2214B	
					3482 123 234	430 MFZ430	Getr. / GBox: VT2214B,VTO2214B In 3483/3488 enthalten / Contained in 3483, 3488	(32)





















FM 10		09.98 - 12.01						
FM 10/320	04.99 - 12.01	CL43S-O/OR		3400 127 201 ⊕ ⊗ 3483 034 033 ⊗ 1862 530 231	430 10 MFZ430 430WGTZ	Getr. / GBox: S/SR1400/1700		
FM 10/320	04.99 - 12.01							
FM 10/360	04.99 - 12.01				3482 123 234	430 MFZ430	Getr. / GBox: S/SR1400/1700 In 3483/3488 enthalten / Contained in 3483, 3488	(32)

VOLVO





















FM 12	08.98 - 09.05						
FM 12/340 FM 12/340 FM 12H/340	08.98 - 09.05	CD38B-O	 3400 700 348 ⊕  3488 019 032  1878 001 216	380 24 GMFZ2/380 380WGVZ	Mot. D12D340 Getr. / GBox: VT2009B		
	02.00 - 09.03		 3483 027 332 ⊕ GMFZ2/380	380 GMFZ2/380	Mot. D12D340 Getr. / GBox: VT2009B In 3483/3488 enthalten / Contained in 3483, 3488	(32)	
	08.98 - 09.05		 3482 111 032	380 GMFZ2/380	Mot. D12D340 Getr. / GBox: VT2009B In 3483/3488 enthalten / Contained in 3483, 3488	(32)	
			 3459 017 031	380 GMFZ2/380	Mot. D12D340 Getr. / GBox: VT2009B In 3488 enthalten / Contained in 3488	(33)	
			 1862 248 033 △	380 8 380GVZ	Mot. D12D340 Getr. / GBox: VT2009B In 3488 enthalten / Contained in 3488	(33)	
			CL39D-C	 3400 700 360 ⊕  3488 000 159  1878 003 768	400 24 MFZ2/400X 400WGTZ		
			CD40B-O	 3400 700 422 ⊕  3488 000 024  1878 000 300	400 24 MFZ2/400X 400WGTZ	Mot. D12D340 Getr. / GBox: VT2214B, VTO2214B mit Zwischenring / with intermediate ring	(94)
				 3400 700 423 ⊕  3483 034 135  1878 000 300  1878 000 635	400 24 MFZ2/400X 400WGTZ	Mot. D12D340 Getr. / GBox: VT2214B, VTO2214B ohne Zwischenring / without intermediate ring	(106)
				 3459 018 004	400 MFZ2/400X	Mot. D12D340 Getr. / GBox: VT2214B, VTO2214B In 3488 enthalten / Contained in 3488	(33)
			CL38D-O	 3400 700 427 ⊕  3488 019 032  1862 415 031	380 10 GMFZ2/380 380WGVZ	Mot. D12C340	
				 3400 700 326 ⊕  3483 027 332  1862 248 033  1862 415 031	380 10 GMFZ2/380 380GVZ 380WGVZ	Mot. D12C340 ohne Zwischenring / without intermediate ring	(106)
				 3482 111 032	380 GMFZ2/380	Mot. D12C340 In 3483/3488 enthalten / Contained in 3483, 3488	(32)
				 3459 017 031	380 GMFZ2/380	Mot. D12C340 In 3488 enthalten / Contained in 3488	(33)
			CL40D-O	 3400 700 406 ⊕  3488 022 253  1878 002 437	400 10 MFZ2/400X 400WGTZ	Mot. D12C340 mit Zwischenring / with intermediate ring	(94)
			CL43S-O	 3400 127 101 ⊕  3483 034 034  1878 634 026	430 10 MFZ430 430WGTZ	Mot. D12C340 Getr. / GBox: VT2014, VT2014OD	
				 3482 123 234	430 MFZ430	Mot. D12C340 Getr. / GBox: VT2014, VT2014OD In 3483/3488 enthalten / Contained in 3483, 3488	(32)
				 3400 043 032 ⊕  3483 034 033  1878 634 026	430 10 MFZ430 430WGTZ	Mot. D12C340 Getr. / GBox: R/SR1700, 1900	
				 3482 123 234	430 MFZ430	Mot. D12C340 Getr. / GBox: R/SR1700, 1900 In 3483/3488 enthalten / Contained in 3483, 3488	(32)
			CS43B-O	 3400 700 350 ⊕  3483 034 042  1878 000 634	430 24 MFZ430 430WGTZ	Mot. D12D340 Getr. / GBox: VT2412B	
				 3482 123 234	430 MFZ430	Mot. D12D340 Getr. / GBox: VT2412B In 3483/3488 enthalten / Contained in 3483, 3488	(32)

		CODE				
--	--	------	--	---	---	---

VOLVO























FM 12		08.98 - 09.05					
FM 12/380 FM 12H/380	08.98 - 09.05 08.98 - 09.05	CD38B-O	 3400 700 348 ⊕ ⊗ 3488 019 032 ⊗ 1878 001 216	380 24 GMFZ2/380 380WGVZ	Mot. D12D380 Getr. / GBox: VT2009B		
			 3483 027 332 ⊕	380 GMFZ2/380	Mot. D12D380 Getr. / GBox: VT2009B In 3483/3488 enthalten / Contained in 3483, 3488	(32)	
			 3482 111 032	380 GMFZ2/380	Mot. D12D380 Getr. / GBox: VT2009B In 3483/3488 enthalten / Contained in 3483, 3488	(32)	
			 3459 017 031	380 GMFZ2/380	Mot. D12D380 Getr. / GBox: VT2009B In 3488 enthalten / Contained in 3488	(33)	
			 1862 248 033 △	380 8 380GVZ	Mot. D12D380 Getr. / GBox: VT2009B In 3488 enthalten / Contained in 3488	(33)	
		CL39D-C	 3400 700 360 ⊕ ⊗ 3488 000 159 ⊗ 1878 003 768	400 24 MFZ2/400X 400WGTZ			
		CD40B-O	 3400 700 422 ⊕ ⊗ 3488 000 024 ⊗ 1878 000 300	400 24 MFZ2/400X 400WGTZ	Mot. D12D380 Getr. / GBox: VT2214B, VTO2214B mit Zwischenring / with intermediate ring	(94)	
	 3400 700 423 ⊕ ⊗ 3483 034 135 ⊗ 1878 000 300 ⊗ 1878 000 635		400 24 MFZ2/400X 400WGTZ	Mot. D12D380 Getr. / GBox: VT2214B, VTO2214B ohne Zwischenring / without intermediate ring	(106)		
	 3459 018 004		400 MFZ2/400X	Mot. D12D380 Getr. / GBox: VT2214B, VTO2214B In 3488 enthalten / Contained in 3488	(33)		
		CL38D-O	 3400 700 427 ⊕ ⊗ 3488 019 032 ⊗ 1862 415 031	380 10 GMFZ2/380 380WGVZ	Mot. D12C380		
	 3400 700 326 ⊕ ⊗ 3483 027 332 ⊗ 1862 248 033 ⊗ 1862 415 031		380 10 GMFZ2/380 380GVZ 380WGVZ	Mot. D12C380 ohne Zwischenring / without intermediate ring	(106)		
	 3482 111 032		380 GMFZ2/380	Mot. D12C380 In 3483/3488 enthalten / Contained in 3483, 3488	(32)		
	 3459 017 031		380 GMFZ2/380	Mot. D12C380 In 3488 enthalten / Contained in 3488	(33)		
		CL40D-O	 3400 700 406 ⊕ ⊗ 3488 022 253 ⊗ 1878 002 437	400 10 MFZ2/400X 400WGTZ	Mot. D12C380 mit Zwischenring / with intermediate ring	(94)	
		CL43S-O	 3400 127 101 ⊕ ⊗ 3483 034 034 ⊗ 1878 634 026	430 10 MFZ430 430WGTZ	Mot. D12C380 Getr. / GBox: VT2014, VT2014OD		
	 3482 123 234		430 MFZ430	Mot. D12C380 Getr. / GBox: VT2014, VT2014OD In 3483/3488 enthalten / Contained in 3483, 3488	(32)		
	 3400 043 032 ⊕ ⊗ 3483 034 033 ⊗ 1878 634 026		430 10 MFZ430 430WGTZ	Mot. D12C380 Getr. / GBox: R/SR1700, 1900			
	 3482 123 234		430 MFZ430	Mot. D12C380 Getr. / GBox: R/SR1700, 1900 In 3483/3488 enthalten / Contained in 3483, 3488	(32)		
		CS43B-O	 3400 700 350 ⊕ ⊗ 3483 034 042 ⊗ 1878 000 634	430 24 MFZ430 430WGTZ	Mot. D12D380 Getr. / GBox: VT2412B		
	 3482 123 234		430 MFZ430	Mot. D12D380 Getr. / GBox: VT2412B In 3483/3488 enthalten / Contained in 3483, 3488	(32)		

VOLVO



















FM 12		08.98 - 09.05					
FM 12/420 FM 12/420 FM 12H/420	08.98 - 09.05	CD38B-O	 3400 700 348 ⊕ ⊗ 3488 019 032 ⊗ 1878 001 216	380 24 GMFZ2/380 380WGVZ	Mot. D12D420 Getr. / GBox: VT2009B		
	03.00 - 09.03		 3483 027 332 ⊕	380 GMFZ2/380	Mot. D12D420 Getr. / GBox: VT2009B In 3483/3488 enthalten / Contained in 3483, 3488	(32)	
	08.98 - 09.05		 3482 111 032	380 GMFZ2/380	Mot. D12D420 Getr. / GBox: VT2009B In 3483/3488 enthalten / Contained in 3483, 3488	(32)	
			 3459 017 031	380 GMFZ2/380	Mot. D12D420 Getr. / GBox: VT2009B In 3488 enthalten / Contained in 3488	(33)	
			 1862 248 033 △	380 8 380GVZ	Mot. D12D420 Getr. / GBox: VT2009B In 3488 enthalten / Contained in 3488	(33)	
		CL39D-C	 3400 700 360 ⊕ ⊗ 3488 000 159 ⊗ 1878 003 768	400 24 MFZ2/400X 400WGTZ			
		CD40B-O	 3400 700 422 ⊕ ⊗ 3488 000 024 ⊗ 1878 000 300	400 24 MFZ2/400X 400WGTZ	Mot. D12D420 Getr. / GBox: VT2214B, VTO2214B mit Zwischenring / with intermediate ring	(94)	
			 3400 700 423 ⊕ ⊗ 3483 034 135 ⊗ 1878 000 300 1878 000 635	400 24 MFZ2/400X 400WGTZ 400GTZ	Mot. D12D420 Getr. / GBox: VT2214B, VTO2214B ohne Zwischenring / without intermediate ring	(106)	
			 3459 018 004	400 MFZ2/400X	Mot. D12D420 Getr. / GBox: VT2214B, VTO2214B In 3488 enthalten / Contained in 3488	(33)	
		CL38D-O	 3400 700 427 ⊕ ⊗ 3488 019 032 ⊗ 1862 415 031	380 10 GMFZ2/380 380WGVZ	Mot. D12C420		
			 3400 700 326 ⊕ ⊗ 3483 027 332 ⊗ 1862 248 033 1862 415 031	380 10 GMFZ2/380 380GVZ 380WGVZ	Mot. D12C420 ohne Zwischenring / without intermediate ring	(106)	
			 3482 111 032	380 GMFZ2/380	Mot. D12C420 In 3483/3488 enthalten / Contained in 3483, 3488	(32)	
			 3459 017 031	380 GMFZ2/380	Mot. D12C420 In 3488 enthalten / Contained in 3488	(33)	
		CL40D-O	 3400 700 406 ⊕ ⊗ 3488 022 253 ⊗ 1878 002 437	400 10 MFZ2/400X 400WGTZ	Mot. D12C420 mit Zwischenring / with intermediate ring	(94)	
		CL43S-O	 3400 127 101 ⊕ ⊗ 3483 034 034 ⊗ 1878 634 026	430 10 MFZ430 430WGTZ	Mot. D12C420 Getr. / GBox: VT2014, VT2014OD		
			 3482 123 234	430 MFZ430	Mot. D12C420 Getr. / GBox: VT2014, VT2014OD In 3483/3488 enthalten / Contained in 3483, 3488	(32)	
			 3400 043 032 ⊕ ⊗ 3483 034 033 ⊗ 1878 634 026	430 10 MFZ430 430WGTZ	Mot. D12C420 Getr. / GBox: R/SR1700, 1900		
			 3482 123 234	430 MFZ430	Mot. D12C420 Getr. / GBox: R/SR1700, 1900 In 3483/3488 enthalten / Contained in 3483, 3488	(32)	
		CS43B-O	 3400 700 350 ⊕ ⊗ 3483 034 042 ⊗ 1878 000 634	430 24 MFZ430 430WGTZ	Mot. D12D420 Getr. / GBox: VT2412B		
			 3482 123 234	430 MFZ430	Mot. D12D420 Getr. / GBox: VT2412B In 3483/3488 enthalten / Contained in 3483, 3488	(32)	

		CODE				
--	--	------	--	---	---	---

VOLVO























FM 12		08.98 - 09.05					
FM 12/460	08.98 - 09.05	CD38B-O	 3400 700 348 ⊕ ⊗ 3488 019 032 ⊗ 1878 001 216	380 24 GMFZ2/380 380WGVZ	Mot. D12D460 Getr. / GBox: VT2009B		
FM 12/460 4x2	01.03-		 3483 027 332 ⊕	380 GMFZ2/380	Mot. D12D460 Getr. / GBox: VT2009B In 3483/3488 enthalten / Contained in 3483, 3488	(32)	
FM 12/460 6x2	01.03-		 3482 111 032	380 GMFZ2/380	Mot. D12D460 Getr. / GBox: VT2009B In 3483/3488 enthalten / Contained in 3483, 3488	(32)	
FM 12/460 6x4	01.03-		 3459 017 031	380 GMFZ2/380	Mot. D12D460 Getr. / GBox: VT2009B In 3488 enthalten / Contained in 3488	(33)	
FM 12/460 8x2/4	01.03-		 1862 248 033 △	380 8 380GVZ	Mot. D12D460 Getr. / GBox: VT2009B In 3488 enthalten / Contained in 3488	(33)	
FM 12/460 8x4/4	01.03-						
		CL39D-C	 3400 700 360 ⊕ ⊗ 3488 000 159 ⊗ 1878 003 768	400 24 MFZ2/400X 400WGTZ			
		CD40B-O	 3400 700 422 ⊕ ⊗ 3488 000 024 ⊗ 1878 000 300	400 24 MFZ2/400X 400WGTZ	Mot. D12D460 Getr. / GBox: VT2214B, VTO2214B mit Zwischenring / with intermediate ring	(94)	
			 3400 700 423 ⊕ ⊗ 3483 034 135 ⊗ 1878 000 300 1878 000 635	400 24 MFZ2/400X 400WGTZ 400GTZ	Mot. D12D460 Getr. / GBox: VT2214B, VTO2214B ohne Zwischenring / without intermediate ring	(106)	
			 3459 018 004	400 MFZ2/400X	Mot. D12D460 Getr. / GBox: VT2214B, VTO2214B In 3488 enthalten / Contained in 3488	(33)	
		CL38D-O	 3400 700 427 ⊕ ⊗ 3488 019 032 ⊗ 1862 415 031	380 10 GMFZ2/380 380WGVZ	Mot. D12C460		
			 3400 700 326 ⊕ ⊗ 3483 027 332 ⊗ 1862 248 033 1862 415 031	380 10 GMFZ2/380 380GVZ 380WGVZ	Mot. D12C460 ohne Zwischenring / without intermediate ring	(106)	
			 3482 111 032	380 GMFZ2/380	Mot. D12C460 In 3483/3488 enthalten / Contained in 3483, 3488	(32)	
			 3459 017 031	380 GMFZ2/380	Mot. D12C460 In 3488 enthalten / Contained in 3488	(33)	
		CL40D-O	 3400 700 406 ⊕ ⊗ 3488 022 253 ⊗ 1878 002 437	400 10 MFZ2/400X 400WGTZ	Mot. D12C460 mit Zwischenring / with intermediate ring	(94)	
		CL43S-O	 3400 127 101 ⊕ ⊗ 3483 034 034 ⊗ 1878 634 026	430 10 MFZ430 430WGTZ	Mot. D12C460 Getr. / GBox: VT2014, VT2014OD		
			 3482 123 234	430 MFZ430	Mot. D12C460 Getr. / GBox: VT2014, VT2014OD In 3483/3488 enthalten / Contained in 3483, 3488	(32)	
			 3400 043 032 ⊕ ⊗ 3483 034 033 ⊗ 1878 634 026	430 10 MFZ430 430WGTZ	Mot. D12C460 Getr. / GBox: R/SR1700, 1900		
			 3482 123 234	430 MFZ430	Mot. D12C460 Getr. / GBox: R/SR1700, 1900 In 3483/3488 enthalten / Contained in 3483, 3488	(32)	
		CS43B-O	 3400 700 351 ⊕ ⊗ 3483 034 043 ⊗ 1878 006 129	430 24 MFZ430 430WGTZ	Mot. D12D460 Getr. / GBox: VT2412B Euro 5 / Euro 5	(17)	
		CS43B-O/OR	 3400 700 342 ⊕ ⊗ 3483 034 033 ⊗ 1878 000 634	430 24 MFZ430 430WGTZ	Mot. D12D460 Getr. / GBox: VT2009B		
			 3482 123 234	430 MFZ430	Mot. D12D460 Getr. / GBox: VT2009B In 3483/3488 enthalten / Contained in 3483, 3488	(32)	
			 3400 700 343 ⊕ ⊗ 3483 034 034 ⊗ 1878 000 634	430 24 MFZ430 430WGTZ	Mot. D12D460 Getr. / GBox: VT2214B, VTO2214B		
			 3482 123 234	430 MFZ430	Mot. D12D460 Getr. / GBox: VT2214B, VTO2214B In 3483/3488 enthalten / Contained in 3483, 3488	(32)	

VOLVO

FMX		04.10 -				
330	04.10 -	CD38B-O	 3400 700 348 ⊕ ⊗ 3488 019 032 ⊗ 1878 001 216	380 24 GMFZ2/380 380WGVZ	Mot. D11C330	
			 1863 869 037	72	Mot. D11C330	
		CD40B-O	 3400 700 360 ⊕ ⊗ 3488 000 159 ⊗ 1878 003 768	400 24 MFZ2/400X 400WGTZ	Mot. D11C330 Getr. / GBox: VT2214B, VT2514B Getr. / GBox: VTO2214B, VTO2514B	
			 1863 869 037	72	Mot. D11C330 Getr. / GBox: VT2214B, VT2514B Getr. / GBox: VTO2214B, VTO2514B	
		CS43B-O	 3400 700 358 ⊖ ⊗ 3482 001 307 ⊗ 1878 003 867	430 24 MF430 430WGTZ	Mot. D11C330 Getr. / GBox: AT2412D, AT2612D Getr. / GBox: ATO2612D	
			 6482 000 155	PHIS-6/38	Mot. D11C330 Getr. / GBox: AT2412D, AT2612D Getr. / GBox: ATO2612D	
			 1863 869 037	72	Mot. D11C330 Getr. / GBox: AT2412D, AT2612D Getr. / GBox: ATO2612D	
		CS43B-OR	 3400 700 478 ⊕ ⊗ 3483 000 382 ⊗ 1878 006 129	430 24 MFZ430 430WGTZ	Mot. D11C330 Getr. / GBox: VT2009B Euro 5 / Euro 5	(17)
			 1863 869 037	72	Mot. D11C330 Getr. / GBox: VT2009B	
			 3400 700 463 ⊕ ⊗ 3483 000 348 ⊗ 1878 006 129	430 24 MFZ430 430WGTZ	Mot. D11C330 Getr. / GBox: VT2214B, VT2514B Getr. / GBox: VTO2214B, VTO2514B Euro 5 / Euro 5	(17)
			 1863 869 037	72	Mot. D11C330 Getr. / GBox: VT2214B, VT2514B Getr. / GBox: VTO2214B, VTO2514B	
				 3189 600 061		
370 410 430	04.10 -	 3483 000 382 ⊕	430 MFZ430	Getr. / GBox: VT 2009B		
	04.10 -	 1878 007 046	430 24 430WGTZ	Getr. / GBox: VT 2009B		
	04.10 -	 3100 026 434 ⊗ 3151 000 163 ⊗ 3180 000 009	KZIZ-5 KZISZ-5	Getr. / GBox: VT 2009B Beinhaltet Ausrücker und Montagesatz / Contains releaser and fitting kit In 3483/3488 enthalten / Contained in 3483, 3488	(9) (32)	
		 3189 600 061		Getr. / GBox: VT 2009B		
		 3400 700 600 ⊕ ⊗ 3483 000 348 ⊗ 1878 007 046	430 24 MFZ430 430WGTZ	Getr. / GBox: VT2214B / VTO 2214B		
		 3189 600 061		Getr. / GBox: VT2214B / VTO 2214B		























		CODE				
--	--	------	--	---	---	---

VOLVO

FMX		04.10 -					
380 380 380	04.10- 01.11- 01.12-	CD38B-O	 3400 700 348 ⊕ ⊗ 3488 019 032 ⊗ 1878 001 216	380 24 GMFZ2/380 380WGVZ	Mot. D13C380		
			 1863 869 037	72	Mot. D13C380		
		CD40B-O	 3400 700 360 ⊕ ⊗ 3488 000 159 ⊗ 1878 003 768	400 24 MFZ2/400X 400WGTZ	Mot. D13C380 Getr. / GBox: VT2214B, VT2514B Getr. / GBox: VTO2214B, VTO2514B		
			 1863 869 037	72	Mot. D13C380 Getr. / GBox: VT2214B, VT2514B Getr. / GBox: VTO2214B, VTO2514B		
			 3400 700 629 ⊕ ⊗ 3488 000 373 ⊗ 1878 007 366	400 24 MFZ2/400X 400WGTZ	Getr. / GBox: VT 2214B / VTO 2214B Getr. / GBox: VT 2514B / VTO 2514B Getr. / GBox: VT 2814B / VTO 2814B für Fahrzeuge mit Zweischeibenkupplung / for vehicles with double disc clutch mit Zwischenring / with intermediate ring	(77) (94)	
		CS43B-O	 3400 700 618 ●⊕ ⊗ 3482 001 308 ⊗ 1878 007 046	430 24 MF430 430WGTZ	Mot. D13C380 Getr. / GBox: AT2412D, AT2612D Getr. / GBox: ATO2612D Euro 6 / Euro 6	(18)	
			 6482 000 155	PHIS-6/38	Mot. D13C380 Getr. / GBox: AT2412D, AT2612D Getr. / GBox: ATO2612D		
			 1863 869 037	72	Mot. D13C380 Getr. / GBox: AT2412D, AT2612D Getr. / GBox: ATO2612D		
		CS43B-OR	 3400 700 478 ⊕ ⊗ 3483 000 382 ⊗ 1878 006 129	430 24 MFZ430 430WGTZ	Mot. D13C380 Getr. / GBox: VT2009B Euro 5 / Euro 5	(17)	
			 1863 869 037	72	Mot. D13C380 Getr. / GBox: VT2009B		
			 3400 700 463 ⊕ ⊗ 3483 000 348 ⊗ 1878 006 129	430 24 MFZ430 430WGTZ	Mot. D13C380 Getr. / GBox: VTO2214B, VTO2514B Getr. / GBox: VT2214B, VT2514B Euro 5 / Euro 5	(17)	
			 1863 869 037	72	Mot. D13C380 Getr. / GBox: VT2214B, VT2514B Getr. / GBox: VTO2214B, VTO2514B		
		 3189 600 061					
380 420 460 500	04.10- 04.10- 04.10- 04.10-	CD40B-O	 3400 700 629 ⊕ ⊗ 3488 000 373 ⊗ 1878 007 366	400 24 MFZ2/400X 400WGTZ	Getr. / GBox: VT 2214B / VTO 2214B Getr. / GBox: VT 2514B / VTO 2514B Getr. / GBox: VT 2814B / VTO 2814B für Fahrzeuge mit Zweischeibenkupplung / for vehicles with double disc clutch mit Zwischenring / with intermediate ring	(77) (94)	
400 400	04.10- 01.11-12.11	CS43B-O/OR	 3400 700 463 ⊕ ⊗ 3483 000 348 ⊗ 1878 006 129	430 24 MFZ430 430WGTZ	Mot. D13A400, D13B400 Getr. / GBox: VT2214B, VT2514B Getr. / GBox: VTO2214B, VTO2514B Euro 5 / Euro 5	(17)	
			 1863 869 037	72	Mot. D13A400, D13B400 Getr. / GBox: VT2214B, VT2514B Getr. / GBox: VTO2214B, VTO2514B		
			 3400 700 618 ●⊕ ⊗ 3482 001 308 ⊗ 1878 007 046	430 24 MF430 430WGTZ	Mot. D13A400, D13B400 Getr. / GBox: AT2412C, AT2512C, Getr. / GBox: ATO2512C Euro 6 / Euro 6	(18)	
			 3400 700 478 ⊕ ⊗ 3483 000 382 ⊗ 1878 006 129	430 24 MFZ430 430WGTZ	Mot. D13A400, D13B400 Getr. / GBox: VT2009B Euro 5 / Euro 5	(17)	
			 1863 869 037	72	Mot. D13A400, D13B400 Getr. / GBox: VT2009B		
		CD38B-O	 3400 700 348 ⊕ ⊗ 3488 019 032 ⊗ 1878 001 216	380 24 GMFZ2/380 380WGVZ	Mot. D13A400, D13B400		
			 1863 869 037	72	Mot. D13A400, D13B400		
		CD40B-O, CL39D-C		 3400 700 360 ⊕ ⊗ 3488 000 159 ⊗ 1878 003 768	400 24 MFZ2/400X 400WGTZ	Mot. D13A400, D13B400 für Fahrzeuge mit Zweischeibenkupplung / for vehicles with double disc clutch	(77)
				 3189 600 061			







		CODE				
--	--	------	--	---	---	---

















VOLVO



FMX		04.10 -					
420	01.11-			3400 710 064 ⊕ 3482 001 310 ⊕ 1878 007 170 Ⓜ 6482 000 155	430 24 MF430 430WGTZ PHIS-6/38	Getr. / GBox: AT 24112F / AT 2612F Getr. / GBox: ATO 2612F	
420	01.12-						
460	04.10-						
460	01.11-			3400 700 600 ⊕ ⊕ 3483 000 348 ⊕ 1878 007 046	430 24 MFZ430 430WGTZ	Getr. / GBox: VT2214B / VTO 2214B Getr. / GBox: VT2514B / VTO 2514B	
460	01.12-			3189 600 061		Getr. / GBox: VT2214B / VTO 2214B Getr. / GBox: VT2514B / VTO 2514B	
440	04.10-	CS43B-O/OR		3400 700 463 ⊕ ⊕ 3483 000 348 ⊕ 1878 006 129	430 24 MFZ430 430WGTZ	Mot. D13A440, D13B440 Getr. / GBox: VT2214B, VT2514B Getr. / GBox: VTO2214B, VTO2514B Euro 5 / Euro 5	(17)
440	04.10-			3400 710 061 # ⊕ 3482 000 553 ⊕ 1878 007 046 Ⓜ 6482 000 155	430 24 MF430 430WGTZ PHIS-6/38	Mot. D13A440, D13B440 Getr. / GBox: AT2412C, AT2512C Getr. / GBox: ATO2512C Euro 5 / Euro 5	(17)
440	01.11 - 12.11			3400 710 066 ● ⊕ 3482 001 308 ⊕ 1878 007 046 Ⓜ 6482 000 155	430 24 MF430 430WGTZ PHIS-6/38	Mot. D13A440, D13B440 Getr. / GBox: AT2412C, AT2512C Getr. / GBox: ATO2512C Euro 6 / Euro 6	(18)
				1863 869 037	72	Mot. D13A440, D13B440 Getr. / GBox: AT2412C, AT2512C Getr. / GBox: ATO2512C	
		CD38B-O		3400 700 348 ⊕ ⊕ 3488 019 032 ⊕ 1878 001 216	380 24 GMFZ2/380 380WGVZ	Mot. D13A440, D13B440 für Fahrzeuge mit Zweischeibenkupplung / for vehicles with double disc clutch	(77)
				1863 869 037	72	Mot. D13A440, D13B440 für Fahrzeuge mit Zweischeibenkupplung / for vehicles with double disc clutch	(77)
		CD40B-O, CL39D-C		3400 700 360 ⊕ ⊕ 3488 000 159 ⊕ 1878 003 768	400 24 MFZ2/400X 400WGTZ	Mot. D13A440, D13B440 für Fahrzeuge mit Zweischeibenkupplung / for vehicles with double disc clutch	(77)
				1863 869 037	72	Mot. D13A440, D13B440 für Fahrzeuge mit Zweischeibenkupplung / for vehicles with double disc clutch	(77)
				3189 600 061			
450	04.10-			3400 700 600 ⊕ ⊕ 3483 000 348 ⊕ 1878 007 046	430 24 MFZ430 430WGTZ	Getr. / GBox: VT2214B / VTO 2214B Getr. / GBox: VT2514B / VTO 2514B	
				3189 600 061		Getr. / GBox: VT2214B / VTO 2214B Getr. / GBox: VT2514B / VTO 2514B	
480	04.10-	CS43B-O/OR		3400 700 463 ⊕ ⊕ 3483 000 348 ⊕ 1878 006 129	430 24 MFZ430 430WGTZ	Mot. D13A480 Getr. / GBox: VT2214B, VT2514B Getr. / GBox: VTO2214B, VTO2514B Euro 5 / Euro 5	(17)
480	01.11 - 12.11			3400 710 061 # ⊕ 3482 000 553 ⊕ 1878 007 046 Ⓜ 6482 000 155	430 24 MF430 430WGTZ PHIS-6/38	Mot. D13A480 Getr. / GBox: AT2412C, AT2512C Getr. / GBox: ATO2512C Euro 5 / Euro 5	(17)
				3400 710 066 ● ⊕ 3482 001 308 ⊕ 1878 007 046 Ⓜ 6482 000 155	430 24 MF430 430WGTZ PHIS-6/38	Mot. D13A480 Getr. / GBox: AT2412C, AT2512C Getr. / GBox: ATO2512C Euro 6 / Euro 6	(18)
				1863 869 037	72	Mot. D13A480 Getr. / GBox: AT2412C, AT2512C Getr. / GBox: ATO2512C	
		CD38B-O		3400 700 348 ⊕ ⊕ 3488 019 032 ⊕ 1878 001 216	380 24 GMFZ2/380 380WGVZ	Mot. D13A480 für Fahrzeuge mit Zweischeibenkupplung / for vehicles with double disc clutch	(77)
				1863 869 037	72	Mot. D13A480 für Fahrzeuge mit Zweischeibenkupplung / for vehicles with double disc clutch	(77)
		CD40B-O, CL39D-C		3400 700 360 ⊕ ⊕ 3488 000 159 ⊕ 1878 003 768	400 24 MFZ2/400X 400WGTZ	Mot. D13A480 für Fahrzeuge mit Zweischeibenkupplung / for vehicles with double disc clutch	(77)
				1863 869 037	72	Mot. D13A480 für Fahrzeuge mit Zweischeibenkupplung / for vehicles with double disc clutch	(77)
				3189 600 061			

		CODE				
--	--	------	--	---	---	---

VOLVO





FMX		04.10 -					
500	01.11-			3400 710 064 ⊕ 3482 001 310 ⊕ 1878 007 170 ⊕ 6482 000 155	430 24 MF430 430WGTZ PHIS-6/38	Getr. / GBox: AT 2612F / ATO 2612F	
500	01.12-			3400 700 600 ⊕ ⊕ 3483 000 348 ⊕ 1878 007 046	430 24 MFZ430 430WGTZ	Getr. / GBox: VT2214B / VTO 2214B	
				3189 600 061		Getr. / GBox: VT2214B / VTO 2214B	
540	04.10-			3400 710 064 ⊕ 3482 001 310 ⊕ 1878 007 170 ⊕ 6482 000 155	430 24 MF430 430WGTZ PHIS-6/38	Getr. / GBox: AT 2612F / ATO 2612F	
540	01.11-			3400 700 600 ⊕ ⊕ 3483 000 348 ⊕ 1878 007 046	430 24 MFZ430 430WGTZ	Getr. / GBox: VT2814B / VTO2814B	
				3189 600 061		Getr. / GBox: VT2814B / VTO2814B	

FMX II		04.12 -					
330	04.12-			3483 000 382 ⊕	430 MFZ430	Getr. / GBox: VT 2009B	
330	09.13-			1878 007 046	430 24 430WGTZ	Getr. / GBox: VT 2009B	
330	06.16-						
370	09.13-			3100 026 434 ⊕ 3151 000 163 ⊕ 3180 000 009	KZIZ-5 KZISZ-5	Getr. / GBox: VT 2009B Beinhaltet Ausrücker und Montagesatz / Contains releaser and fitting kit	(9)
370	06.16-					In 3483/3488 enthalten / Contained in 3483, 3488	(32)
380	04.12-						
410	09.13-			3189 600 061		Getr. / GBox: VT 2009B	
410	06.16-			3400 700 600 ⊕ ⊕ 3483 000 348 ⊕ 1878 007 046	430 24 MFZ430 430WGTZ	Getr. / GBox: VT2214B / VTO 2214B	
				3189 600 061		Getr. / GBox: VT2214B / VTO 2214B	
420	09.13-			3400 710 064 ⊕ 3482 001 310 ⊕ 1878 007 170 ⊕ 6482 000 155	430 24 MF430 430WGTZ PHIS-6/38	Getr. / GBox: AT 24112F / AT 2612F Getr. / GBox: ATO 2612F	
420	06.16-						
460	09.13-			3400 700 600 ⊕ ⊕ 3483 000 348 ⊕ 1878 007 046	430 24 MFZ430 430WGTZ	Getr. / GBox: VT2214B / VTO 2214B Getr. / GBox: VT2514B / VTO 2514B	
460	06.16-			3189 600 061		Getr. / GBox: VT2214B / VTO 2214B Getr. / GBox: VT2514B / VTO 2514B	
450	09.13-			3400 700 600 ⊕ ⊕ 3483 000 348 ⊕ 1878 007 046	430 24 MFZ430 430WGTZ	Getr. / GBox: VT2214B / VTO 2214B Getr. / GBox: VT2514B / VTO 2514B	
450	06.16-			3189 600 061		Getr. / GBox: VT2214B / VTO 2214B Getr. / GBox: VT2514B / VTO 2514B	
500	09.13-			3400 710 064 ⊕ 3482 001 310 ⊕ 1878 007 170 ⊕ 6482 000 155	430 24 MF430 430WGTZ PHIS-6/38	Getr. / GBox: AT 2612F / ATO 2612F	
500	06.16-			3400 700 600 ⊕ ⊕ 3483 000 348 ⊕ 1878 007 046	430 24 MFZ430 430WGTZ	Getr. / GBox: VT2214B / VTO 2214B	
				3189 600 061		Getr. / GBox: VT2214B / VTO 2214B	
540	09.13-			3400 710 064 ⊕ 3482 001 310 ⊕ 1878 007 170 ⊕ 6482 000 155	430 24 MF430 430WGTZ PHIS-6/38	Getr. / GBox: AT 2612F / ATO 2612F	
540	09.13-			3400 700 600 ⊕ ⊕ 3483 000 348 ⊕ 1878 007 046	430 24 MFZ430 430WGTZ	Getr. / GBox: VT2814B / VTO2814B	
540	06.16-			3189 600 061		Getr. / GBox: VT2814B / VTO2814B	





















FS 7		11.91 - 03.96					
Mot. TD 71, 73	01.85-	KFD116A		3400 700 301 #⊕ ⊕ 3483 022 031 ⊕ 1862 349 031	400 10 MFZ400X 400GVZ		
				3482 101 032	400 MFZ400X	In 3483/3488 enthalten / Contained in 3483, 3488	(32)

		CODE				
--	--	------	--	---	---	---

VOLVO

FS 7		11.91 - 03.96				
FS 7	01.90 - 12.96	KFD116A, B	 3400 700 301 #  3483 022 031  1862 349 031	400 10 MFZ400X 400GVZ	Getr. / GBox: R1000,SR1400	
FS 718/230	09.94 - 03.96		 3482 101 032	400 MFZ400X	Getr. / GBox: R1000,SR1400 In 3483/3488 enthalten / Contained in 3483, 3488	(32)
FS 718/260	09.94 - 03.96		KFD116C	 3482 101 032	400 MFZ400X	Getr. / GBox: R800















G - Serie

G 88			 1878 000 967 ▽	380 10 380GTZ	Mot. TD 100 A Getr. / GBox: MR61 Lose Kupplungsscheibe / Loose clutch disc	(41)
			 3151 106 041	KZI-5	Mot. TD 100 A Getr. / GBox: MR61	
			 1882 280 213	380 GF2/380	Mot. TD 100 A Getr. / GBox: MR61 In 1888 enthalten / Contained in 1888	(31)
			 1859 212 000	380 GF2/380	Mot. TD 100 A Getr. / GBox: MR61 In 1888 enthalten / Contained in 1888	(31)
			 1878 000 964 △	380 10 380GTZ	Mot. TD 100 A Getr. / GBox: MR61 In 1888 enthalten / Contained in 1888	(31)
			 1800 125 601 #  1882 226 533  1878 006 951  3151 105 141	420 G420 420GTZ KZI-5	Mot. T 100A, B ;TD 100A Getr. / GBox: R 61, SR 61	
G 88 6x2 LHD			 1878 000 967 ▽	380 10 380GTZ	Chass. 33995 - Chass. 46790 Mot. TD 100 A Getr. / GBox: R61, SR61 Lose Kupplungsscheibe / Loose clutch disc	(41)
			 3151 106 041	KZI-5	Chass. 33995 - Chass. 46790 Mot. TD 100 A Getr. / GBox: R61, SR61	
			 1882 280 213	380 GF2/380	Chass. 33995 - Chass. 46790 Mot. TD 100 A Getr. / GBox: R61, SR61 In 1888 enthalten / Contained in 1888	(31)
			 1859 212 000	380 GF2/380	Chass. 33995 - Chass. 46790 Mot. TD 100 A Getr. / GBox: R61, SR61 In 1888 enthalten / Contained in 1888	(31)
			 1878 000 964 △	380 10 380GTZ	Chass. 33995 - Chass. 46790 Mot. TD 100 A Getr. / GBox: R61, SR61 In 1888 enthalten / Contained in 1888	(31)
			 1888 019 445 #	350 GF2/350	Chass. 46791-> für / for: 6x2,6x4 RHD Mot. TD 100 A enthält eine Kupplungsscheibe / This part number includes one clutch disc	(69)
			 1878 001 083 ▽	350 10 350GTZ	Chass. 46791-> für / for: 6x2,6x4 RHD Mot. TD 100 A Lose Kupplungsscheibe / Loose clutch disc	(41)
			 3151 106 041	KZI-5	Chass. 46791-> für / for: 6x2,6x4 RHD Mot. TD 100 A	(69)
			 1882 250 143	350 GF2/350	Chass. 46791-> für / for: 6x2,6x4 RHD Mot. TD 100 A In 1888 enthalten / Contained in 1888	(31)
			 1859 170 204	350 GF2/350	Chass. 46791-> für / for: 6x2,6x4 RHD Mot. TD 100 A In 1888 enthalten / Contained in 1888	(31)
			 1878 001 079 △	350 10 350GTZ	Chass. 46791-> für / for: 6x2,6x4 RHD Mot. TD 100 A In 1888 enthalten / Contained in 1888	(31)



















		CODE				
--	--	------	--	---	---	---

VOLVO







































G - Serie

G 88 6x2,6x4 RHD			 1878 000 967 ▽	380 10 380GTZ	Chass. 33995 - Chass. 40395 Chass. 42121 - Chass. 46790 Mot. TD 100 A Getr. / GBox: R61, SR61 Lose Kupplungsscheibe / Loose clutch disc	(41)
			 3151 106 041	KZI-5	Chass. 33995 - Chass. 40395 Chass. 42121 - Chass. 46790 Mot. TD 100 A Getr. / GBox: R61, SR61	
			 1882 280 213	380 GF2/380	Chass. 33995 - Chass. 40395 Chass. 42121 - Chass. 46790 Mot. TD 100 A Getr. / GBox: R61, SR61 In 1888 enthalten / Contained in 1888	(31)
			 1859 212 000	380 GF2/380	Chass. 33995 - Chass. 40395 Chass. 42121 - Chass. 46790 Mot. TD 100 A Getr. / GBox: R61, SR61 In 1888 enthalten / Contained in 1888	(31)
			 1878 000 964 △	380 10 380GTZ	Chass. 33995 - Chass. 40395 Chass. 42121 - Chass. 46790 Mot. TD 100 A Getr. / GBox: R61, SR61 In 1888 enthalten / Contained in 1888	(31)
G 89			 1800 125 601 #  1882 226 533  1878 006 951  3151 105 141	420 G420 420GTZ KZI-5	Mot. TD 110, 120 A	
			 1878 000 967 ▽	380 10 380GTZ	Mot. TD 120 A Lose Kupplungsscheibe / Loose clutch disc	(41)
			 3151 106 041	KZI-5	Mot. TD 120 A	
			 1882 280 213	380 GF2/380	Mot. TD 120 A In 1888 enthalten / Contained in 1888	(31)
			 1859 212 000	380 GF2/380	Mot. TD 120 A In 1888 enthalten / Contained in 1888	(31)
			 1878 000 964 △	380 10 380GTZ	Mot. TD 120 A In 1888 enthalten / Contained in 1888	(31)

N 7 01.70 - 09.80

























Mot. TD 70	01.73 -	KF115B, KV115B	 3400 037 032  3482 021 031  1878 000 961  3151 824 005	380 10 GM380 380GTZ KZA-4	Getr. / GBox: R52, R52B		
			KF214C	 1888 019 445 #	350 GF2/350	Getr. / GBox: R51, 52, R52B enthält eine Kupplungsscheibe / This part number includes one clutch disc	(67)
				 1878 001 083 ▽	350 10 350GTZ	Getr. / GBox: R51, 52, R52B Lose Kupplungsscheibe / Loose clutch disc	(41)
		 3151 600 533		KZA-4	Getr. / GBox: R51, 52, R52B		
		KF214F	 1859 170 204	350 GF2/350	Getr. / GBox: R51, 52, R52B In 1888 enthalten / Contained in 1888	(31)	
			 1800 106 033  1882 250 143  1878 001 080  1878 001 082  3151 106 041  1874 000 098	350 10 GF2/350 350GTZ 350GTZ KZI-5	Getr. / GBox: SR62 ohne Zwischenring / without intermediate ring	(106)	
			 1888 019 542 #	350 GF2/350	Getr. / GBox: SR62 enthält eine Kupplungsscheibe / This part number includes one clutch disc	(67)	
			 1878 001 082 ▽	350 10 350GTZ	Getr. / GBox: SR62 Lose Kupplungsscheibe / Loose clutch disc	(41)	
			 3151 106 041	KZI-5	Getr. / GBox: SR62		
			 1859 170 204	350 GF2/350	Getr. / GBox: SR62 In 1888 enthalten / Contained in 1888	(31)	
		KF115	 1882 325 134	380 G380	Getr. / GBox: R51		

VOLVO







































N 10		01.73 - 12.89						
Mot. TD 100	01.73-12.83	KF116	 1800 125 601 #  1882 226 533  1878 006 951  3151 105 141	420 G420 420GTZ KZI-5	Getr. / GBox: R/SR61			
		KF214E	 1888 019 445 #	350 GF2/350	Getr. / GBox: R/SR61 enthält eine Kupplungsscheibe / This part number includes one clutch disc (67)			
			 1878 001 083 ▽	350 10 350GTZ	Getr. / GBox: R/SR61 Lose Kupplungsscheibe / Loose clutch disc (41)			
			 3151 106 041	KZI-5	Getr. / GBox: R/SR61			
			 1882 250 143	350 GF2/350	Getr. / GBox: R/SR61 In 1888 enthalten / Contained in 1888 (31)			
			 1859 170 204	350 GF2/350	Getr. / GBox: R/SR61 In 1888 enthalten / Contained in 1888 (31)			
			 1878 001 079 △	350 10 350GTZ	Getr. / GBox: R/SR61 In 1888 enthalten / Contained in 1888 (31)			
		KF215B	 1878 000 967 ▽	380 10 380GTZ	Getr. / GBox: MR61 Lose Kupplungsscheibe / Loose clutch disc (41)			
			 3151 106 041	KZI-5	Getr. / GBox: MR61			
			 1882 280 213	380 GF2/380	Getr. / GBox: MR61 In 1888 enthalten / Contained in 1888 (31)			
			 1859 212 000	380 GF2/380	Getr. / GBox: MR61 In 1888 enthalten / Contained in 1888 (31)			
			 1878 000 964 △	380 10 380GTZ	Getr. / GBox: MR61 In 1888 enthalten / Contained in 1888 (31)			
		Mot. TD 100	01.73-	KF215L	 1888 015 515 #	380 10 GF2/380	Getr. / GBox: MR62 enthält eine Kupplungsscheibe / This part number includes one clutch disc (67)	
					 1878 000 968 ▽	380 10 380GTZ	Getr. / GBox: MR62 Lose Kupplungsscheibe / Loose clutch disc (41)	
 3151 106 041	KZI-5				Getr. / GBox: MR62			
 1882 280 213	380 GF2/380				Getr. / GBox: MR62 In 1888 enthalten / Contained in 1888 (31)			
 1859 212 000	380 GF2/380				Getr. / GBox: MR62 In 1888 enthalten / Contained in 1888 (31)			
Mot. TD 100, 101, 102	01.73-	KF214F, H	 1800 106 033  1882 250 143  1878 001 080  1878 001 082  3151 106 041  1874 000 098	350 10 GF2/350 350GTZ 350GTZ KZI-5	Getr. / GBox: R/SR62 ohne Zwischenring / without intermediate ring (106)			
			 1888 019 542 #	350 GF2/350	Getr. / GBox: R/SR62 enthält eine Kupplungsscheibe / This part number includes one clutch disc (67)			
			 1878 001 082 ▽	350 10 350GTZ	Getr. / GBox: R/SR62 Lose Kupplungsscheibe / Loose clutch disc (41)			
			 3151 106 041	KZI-5	Getr. / GBox: R/SR62			
			 1859 170 204	350 GF2/350	Getr. / GBox: R/SR62 In 1888 enthalten / Contained in 1888 (31)			
		KF116B	 3482 119 032	430 GMF430	Getr. / GBox: R/SR62			
			 1878 003 242	420 10 420GTZ	Getr. / GBox: R/SR62			
			 3151 105 141	KZI-5	Getr. / GBox: R/SR62			
			Mot. TD 100, 101, 102	01.77-	KF215K	 1882 280 140	380 GF2/380	Getr. / GBox: MR62B
						 1859 212 000	380 GF2/380	Getr. / GBox: MR62B
 1878 000 965 △	380 10 380GTZ	Getr. / GBox: MR62B						
 1878 000 968 ▽	380 10 380GTZ	Getr. / GBox: MR62B						
 3151 106 041	KZI-5	Getr. / GBox: MR62B						





		CODE				
--	--	------	--	---	---	---













VOLVO

N 10		01.73 - 12.89				
Mot. TD 101, 102	01.80-	KFD117B, C	 3400 106 031 ⊕ ⊕ 3483 034 032 ⊕ 1862 530 231	430 10 MFZ430 430WGTZ	Getr. / GBox: R/SR1400, 1700	
			 3400 040 032 ●⊕ ⊕ 3483 034 032 ⊕ 1878 004 456	430 10 MFZ430 430GVZ	Getr. / GBox: R/SR1400, 1700	
			 3482 123 235	430 MFZ430	Getr. / GBox: R/SR1400, 1700 In 3483/3488 enthalten / Contained in 3483, 3488	(32)
Mot. TD 101, 102	01.86-	KFD214A	 3400 031 033 ⊕ ⊕ 3483 014 132 ⊕ 1878 001 080 ⊕ 1878 001 082 ⊕ 3474 012 000	350 10 GMFZ2/350 350GTZ 350GTZ	Getr. / GBox: R/SR1400, 1700 ohne Zwischenring / without intermediate ring	(106)
			 3488 013 138 ⊕	350 GMFZ2/350	Getr. / GBox: R/SR1400, 1700 enthält eine Kupplungsscheibe / This part number includes one clutch disc	(67)
			 1878 001 082 ▽	350 10 350GTZ	Getr. / GBox: R/SR1400, 1700 Lose Kupplungsscheibe / Loose clutch disc	(41)
			 3482 056 031	350 GMFZ2/350	Getr. / GBox: R/SR1400, 1700 In 3483/3488 enthalten / Contained in 3483, 3488	(32)
			 3459 000 009	350 GMFZ2/350	Getr. / GBox: R/SR1400, 1700 In 3483/3488 enthalten / Contained in 3483, 3488	(32)
N 12						
Mot. TD 120	01.73-12.83	KF215B	 1878 000 967 ▽	380 10 380GTZ	Getr. / GBox: R/SR61, MR61B Lose Kupplungsscheibe / Loose clutch disc	(41)
			 3151 106 041	KZI-5	Getr. / GBox: R/SR61, MR61B	
			 1882 280 213	380 GF2/380	Getr. / GBox: R/SR61, MR61B In 1888 enthalten / Contained in 1888	(31)
			 1859 212 000	380 GF2/380	Getr. / GBox: R/SR61, MR61B In 1888 enthalten / Contained in 1888	(31)
			 1878 000 964 △	380 10 380GTZ	Getr. / GBox: R/SR61, MR61B In 1888 enthalten / Contained in 1888	(31)
Mot. TD 120, 121	01.73-	KF215K	 1882 280 140	380 GF2/380	Getr. / GBox: MR62B	
			 1859 212 000	380 GF2/380	Getr. / GBox: MR62B	
			 1878 000 965 △	380 10 380GTZ	Getr. / GBox: MR62B	
			 1878 000 968 ▽	380 10 380GTZ	Getr. / GBox: MR62B	
			 3151 106 041	KZI-5	Getr. / GBox: MR62B	
Mot. TD 120, 121, 122	01.73-	KF215F	 1888 015 515 #	380 10 GF2/380	Getr. / GBox: R/SR62 Getr. / GBox: R/SR70 enthält eine Kupplungsscheibe / This part number includes one clutch disc	(67)
			 1878 000 968 ▽	380 10 380GTZ	Getr. / GBox: R/SR62 Getr. / GBox: R/SR70 Lose Kupplungsscheibe / Loose clutch disc	(41)
			 3151 106 041	KZI-5	Getr. / GBox: R/SR62	
			 1882 280 213	380 GF2/380	Getr. / GBox: R/SR62 Getr. / GBox: R/SR70 In 1888 enthalten / Contained in 1888	(31)
			 1859 212 000	380 GF2/380	Getr. / GBox: R/SR70 Getr. / GBox: R/SR62 In 1888 enthalten / Contained in 1888	(31)
			 1878 000 965 △	380 10 380GTZ	Getr. / GBox: R/SR62 Getr. / GBox: R/SR70 In 1888 enthalten / Contained in 1888	(31)

VOLVO





N 12						
Mot. TD 121, 122	01.83-	KF215D, G	 3400 116 501 #  3482 026 332  1878 006 117  1878 006 035  3151 106 041  1874 000 098	380 10 GTF380 380GTZ 380GTZ KZI-5	Getr. / GBox: R/SR70,71 ohne Zwischenring / without intermediate ring	(106)
			 1861 996 137 ▽#	380 10 380GVZ	Getr. / GBox: R/SR70,71 Lose Kupplungsscheibe / Loose clutch disc	(41)
			 3151 106 041	KZI-5	Getr. / GBox: R/SR70,71	
			 3459 004 108	380 GTF2/380	Getr. / GBox: R/SR70,71 In 3488 enthalten / Contained in 3488	(33)
Mot. TD 121, 122	01.86-	KFD214A	 3400 031 033 ⊕  3483 014 132  1878 001 080  1878 001 082  3474 012 000	350 10 GMFZ2/350 350GTZ 350GTZ	Getr. / GBox: R/SR1400, 1700 ohne Zwischenring / without intermediate ring	(106)
			 3488 013 138 ⊕	350 GMFZ2/350	Getr. / GBox: R/SR1400, 1700 enthält eine Kupplungsscheibe / This part number includes one clutch disc	(67)
			 1878 001 082 ▽	350 10 350GTZ	Getr. / GBox: R/SR1400, 1700 Lose Kupplungsscheibe / Loose clutch disc	(41)
			 3482 056 031	350 GMFZ2/350	Getr. / GBox: R/SR1400, 1700 In 3483/3488 enthalten / Contained in 3483, 3488	(32)
			 3459 000 009	350 GMFZ2/350	Getr. / GBox: R/SR1400, 1700 In 3483/3488 enthalten / Contained in 3483, 3488	(32)
			 3400 030 033 #⊕  3483 017 031  1878 006 117  1878 006 035  3474 012 001	380 10 GMFZ2/380 380GTZ 380GTZ	Getr. / GBox: R/SR1400, 1700 ohne Zwischenring / without intermediate ring	(106)
		 3482 059 031	380 GMFZ2/380	Getr. / GBox: R/SR1400, 1700 In 3483/3488 enthalten / Contained in 3483, 3488	(32)	
		 3459 010 101	380 GMFZ2/380	Getr. / GBox: R/SR1400, 1700		
		 3400 700 427 ⊕  3488 019 032  1862 415 031	380 10 GMFZ2/380 380WGVZ	Getr. / GBox: R/SR1400, 1700		
		 3400 700 326 ⊕  3483 027 332  1862 248 033  1862 415 031	380 10 GMFZ2/380 380GVZ 380WGVZ	Getr. / GBox: R/SR1400, 1700 ohne Zwischenring / without intermediate ring	(106)	
		 3482 111 032	380 GMFZ2/380	Getr. / GBox: R/SR1400, 1700 In 3483/3488 enthalten / Contained in 3483, 3488	(32)	
		 3459 017 031	380 GMFZ2/380	Getr. / GBox: R/SR1400, 1700 In 3488 enthalten / Contained in 3488	(33)	
KFD215A	 1800 125 601 #  1882 226 533  1878 006 951  3151 105 141	420 G420 420GTZ KZI-5	Mot. TD100, D100, B nicht für / not for: 3 Achsen/Axes	(96)		





















N 88						
N 88			 1800 125 601 #  1882 226 533  1878 006 951  3151 105 141	420 G420 420GTZ KZI-5	Mot. TD100, D100, B nicht für / not for: 3 Achsen/Axes	(96)





NB - Serie						
NB 86 bis 32 t Gesamtgewicht / to 32t total weight			 1882 325 134	380 G380	Mot. TD 70	
			 3151 824 005	KZA-4	Mot. TD 70	
NB 86 über 32 t Gesamtgewicht / from 32t total weight			 1800 125 001  1882 250 143  1878 001 079  1878 001 083  3151 600 533  1874 000 098	350 10 GF2/350 350GTZ 350GTZ KZA-4	Mot. TD 70, E, EF ohne Zwischenring / without intermediate ring	(106)
			 1888 019 445 #	350 GF2/350	Mot. TD 70, E, EF enthält eine Kupplungsscheibe / This part number includes one clutch disc	(67)
			 1878 001 083 ▽	350 10 350GTZ	Mot. TD 70, E, EF Lose Kupplungsscheibe / Loose clutch disc	(41)
			 3151 600 533	KZA-4	Mot. TD 70, E, EF	
			 1859 170 204	350	Mot. TD 70, E, EF In 1888 enthalten / Contained in 1888	(31)









		CODE				
--	--	------	--	---	---	---

VOLVO









NB - Serie							
NB 88				1800 125 601 #  1882 226 533  1878 006 951  3151 105 141	420 G420 420GTZ KZI-5	Mot. TD100, D100, B nicht für / not for: 3 Achsen/Axes	(96)

NH 12 01.98 -							
NH 12	05.99 -	CD40B-O		3400 700 422 ⊕  3488 000 024  1878 000 300	400 24 MFZ2/400X 400WGTZ	für Fahrzeuge mit Zweischeibenkupplung / for vehicles with double disc clutch mit Zwischenring / with intermediate ring	(77)
NH 12/380	05.99 -	CL43S-O, CL43S-OR		3400 043 032 ⊕  3483 034 033  1878 634 026	430 10 MFZ430 430WGTZ		(94)
NH 12/420		CS43B-O		3400 700 350 ⊕  3483 034 042  1878 000 634	430 24 MFZ430 430WGTZ	Getr. / GBox: VT2412B max. übertragbares Motormoment [Nm] / max. transmittable engine torque [Nm]: 2040	(87)
				3400 700 351 ⊕  3483 034 043  1878 006 129	430 24 MFZ430 430WGTZ	Getr. / GBox: VT2412B Euro 5 / Euro 5 max. übertragbares Motormoment [Nm] / max. transmittable engine torque [Nm]: 2400	(17) (87)
		CS43B-O, CS43B-OR		3400 700 343 ⊕  3483 034 034  1878 000 634	430 24 MFZ430 430WGTZ	Getr. / GBox: VT2214B/VTO2214B Getr. / GBox: VT2514B/VTO2514B max. übertragbares Motormoment [Nm] / max. transmittable engine torque [Nm]: 2040	(87)
				3400 700 357 ⊕  3483 034 035  1878 006 129	430 24 MFZ430 430WGTZ	Getr. / GBox: VT2214B/VTO2214B Getr. / GBox: VT2514B/VTO2514B Euro 5 / Euro 5 max. übertragbares Motormoment [Nm] / max. transmittable engine torque [Nm]: 2250	(17) (87)
				3400 700 342 ⊕  3483 034 033  1878 000 634	430 24 MFZ430 430WGTZ	Getr. / GBox: SR1400/SR1700/SR1900	



NL 10 S							
Mot. TD 101, 102, 103	01.91 -	KFD117C		3400 106 031 ⊕  3483 034 032  1862 530 231	430 10 MFZ430 430WGTZ	Getr. / GBox: R/SR1400, 1700	
				3482 123 235	430 MFZ430	Getr. / GBox: R/SR1400, 1700 In 3483/3488 enthalten / Contained in 3483, 3488	(32)

NL 12 S							
Mot. TD 121, 122, 123	01.86 -	KFD214A		3400 031 033 ⊕  3483 014 132  1878 001 080  1878 001 082  3474 012 000	350 10 GMFZ2/350 350GTZ 350GTZ	Getr. / GBox: R/SR1400, 1700 ohne Zwischenring / without intermediate ring	(106)
				3488 013 138 ⊕	350 GMFZ2/350	Getr. / GBox: R/SR1400, 1700 enthält eine Kupplungsscheibe / This part number includes one clutch disc	(67)
				1878 001 082 ▽	350 10 350GTZ	Getr. / GBox: R/SR1400, 1700 Lose Kupplungsscheibe / Loose clutch disc	(41)
				3482 056 031	350 GMFZ2/350	Getr. / GBox: R/SR1400, 1700 In 3483/3488 enthalten / Contained in 3483, 3488	(32)
				3459 000 009	350 GMFZ2/350	Getr. / GBox: R/SR1400, 1700 In 3483/3488 enthalten / Contained in 3483, 3488	(32)

VOLVO







NL 12 S							
Mot. TD 121, 122, 123	01.91-	KFD215A		3400 030 033 #⊕ ⊕ 3483 017 031 ⊕ 1878 006 117 ⊕ 1878 006 035 ⊕ 3474 012 001	380 10 GMFZ2/380 380GTZ 380GTZ	Getr. / GBox: R/SR1400, 1700 ohne Zwischenring / without intermediate ring	(106)
				3482 059 031	380 GMFZ2/380	Getr. / GBox: R/SR1400, 1700 In 3483/3488 enthalten / Contained in 3483, 3488	(32)
				3459 010 101	380 GMFZ2/380	Getr. / GBox: R/SR1400, 1700	
				3400 700 427 ⊕ ⊕ 3488 019 032 ⊕ 1862 415 031	380 10 GMFZ2/380 380WGVZ	Getr. / GBox: R/SR1400, 1700	
				3400 700 326 ⊕ ⊕ 3483 027 332 ⊕ 1862 248 033 ⊕ 1862 415 031	380 10 GMFZ2/380 380GVZ 380WGVZ	Getr. / GBox: R/SR1400, 1700 ohne Zwischenring / without intermediate ring	(106)
				3482 111 032	380 GMFZ2/380	Getr. / GBox: R/SR1400, 1700 In 3483/3488 enthalten / Contained in 3483, 3488	(32)
				3459 017 031	380 GMFZ2/380	Getr. / GBox: R/SR1400, 1700 In 3488 enthalten / Contained in 3488	(33)
V..							
VM 260 4x2				3483 000 238 ⊕	395 GMFZ395		
				1878 002 218	395 10 395WGTZ		

VOLVO PENTA

Benzinmotor							
230A				1866 032 231	287 26 287/ 133NTP	max. übertragbares Motormoment [Nm] / max. transmittable engine torque [Nm]: 425	(87)
230B							
250A							
250B							
251A							
AQ115A							
AQ115B							
AQ120B							
AQ125A							
AQ125B							
AQ130A							
AQ130B							
AQ130C							
AQ130D							
AQ131A							
AQ131B							
AQ131C							
AQ131D							
AQ140A							
AQ145A							
AQ145B							
AQ151A							
AQ151B							
AQ151C							
AQ171A							
AQ171C							
BB115A							
BB115B							
BB115C							
BB140A							
MB20A							
MB20B							
MB20C							
AQ165A				1866 018 131	287 26 287/ 133NTP	max. übertragbares Motormoment [Nm] / max. transmittable engine torque [Nm]: 425	(87)
AQ170A							
AQ170B							
AQ170C							
AQD21A							
BB165A							
BB170A							
BB170B							
BB170C							



		CODE				
--	--	------	--	---	---	---

VOLVO PENTA





Dieselmotor						
AD31A AD31B AD31D AD31XD AQAD30A AQAD31A MD30A MD31A TAMD30A TAMD31A TAMD31B TAMD31D TMD30A TMD31A TMD31B TMD31D			 1866 032 231	287 26 287/ 133NTP	max. übertragbares Motormoment [Nm] / max. transmittable engine torque [Nm]: 425	(87)
AD41A AD41B AD41D AQAD41A D41A D41B D41D KAD42A KAD42B TAMD41A TAMD41B TMD41A TMD41B			 1866 118 001	287 26 287/ 159NGS	max. übertragbares Motormoment [Nm] / max. transmittable engine torque [Nm]: 820	(87)
AQAD40A AQAD40B MD40A TAMD40A TAMD40B TMD40A TMD40B TMD40C			 1866 032 231	287 26 287/ 133NTP	max. übertragbares Motormoment [Nm] / max. transmittable engine torque [Nm]: 425	(87)
			 1866 018 131	287 26 287/ 133NTP	max. übertragbares Motormoment [Nm] / max. transmittable engine torque [Nm]: 425	(87)
AQD21B AQD40A MD21B			 1866 018 131	287 26 287/ 133NTP	max. übertragbares Motormoment [Nm] / max. transmittable engine torque [Nm]: 425	(87)
D3-190			 1866 000 140	275 26 275/ 188NWGT P	max. übertragbares Motormoment [Nm] / max. transmittable engine torque [Nm]: 800	(87)

		CODE				
--	--	------	--	---	---	---



VOLVO PENTA

Dieselmotor							
D4-210A-A				1866 000 239	314 26 314/ 212NWGT P	max. übertragbares Motormoment [Nm] / max. transmittable engine torque [Nm]: 1500	(87)
D4-210A-B							
D4-225A-B							
D4-225A-C							
D4-260A-A							
D4-260A-B							
D4-260A-C							
D4-300A-A							
D4-300A-C							
D6-280A-A							
D6-280A-B							
D6-310A-A							
D6-310A-B							
D6-330A-B							
D6-350A-A							
D6-350A-B							
D6-370A-B							
DPH-A							
DPH-B							
DPR-A							
DPR-B							
DP-D				1866 118 001	287 26 287/ 159NGS	max. übertragbares Motormoment [Nm] / max. transmittable engine torque [Nm]: 820	(87)
DP-D1							
DP-D2							
DP-E				1866 032 231	287 26 287/ 133NTP	max. übertragbares Motormoment [Nm] / max. transmittable engine torque [Nm]: 425	(87)
DP-G							
DPX							



YaMZ

LKW							
LKW				3482 000 419	362 MF362	Getr. / GBox: ZF 6S-850	
				1878 002 071	362 10 362GTZ	Getr. / GBox: ZF 6S-850	
				3151 000 419	KZIS-4	Getr. / GBox: ZF 6S-850	
				3482 083 032	430 MFZ430	Getr. / GBox: ZF 6S-850	
				1878 085 641	430 10 430GTZ	Getr. / GBox: ZF 6S-850	

YAROVIT









































Yarovit							
4443		DeutzBF6M101 5C		3482 083 032	430 MFZ430	Getr. / GBox: ZF 16 S 221	
				1878 080 037	430 10 430WGTZ	Getr. / GBox: ZF 16 S 221	
				3151 000 034	KZISZ-5	Getr. / GBox: ZF 16 S 221	

ZIL

LKW							
LKW				3482 083 032	430 MFZ430		
				3151 000 034	KZISZ-5		



		CODE				
---	--	------	--	---	---	---

BOVA









Futura		09.84 -		
FHD 10-340 FHD 12-340	DAFWS242M	 3482 119 031	430 GMF430	
		 1878 003 269	420 10 420GTZ	
		 3151 182 233	KZI-5	
FHD 12-370	WS268M	 3400 121 101  3482 119 031  1878 002 878  3151 182 233	430 10 GMF430 420GTZ KZI-5	Getr. / GBox: ZF S6-1600
FHD 14-430 XE Magnum FHD 15-430 XE Magnum	DAFXE315C1	 3482 083 032	430 MFZ430	Getr. / GBox: ZF 8S-180
		 1878 080 037	430 10 430WGTZ	Getr. / GBox: ZF 8S-180
		 3151 000 157	KZISZ-5	Getr. / GBox: ZF 8S-180
FHX 12-370	DAFWS268L, MAND2866LOH	 3482 083 032	430 MFZ430	Getr. / GBox: ZF S8-180
		 3151 000 034	KZISZ-5	Getr. / GBox: ZF S8-180
FLD 12-300	DAFRS222L	 3482 119 032	430 GMF430	
		 1878 027 231	400 10 400GTZ	
		 3151 182 233	KZI-5	
FUTURA	DAFDHS825	 3400 124 701  3482 017 034  1878 000 105  3151 000 395	380 10 GMF380 380GTZ KZIS-4	->Chass. 3412
	DAFDKT1160	 3400 700 305  3482 118 031  1878 002 706  3151 000 515	430 10 GMF430 420GTZ KZIS-4	->Chass. 3597
	DAFDKT, DKV, DKX1160	 3482 119 032	430 GMF430	Chass. 3598->
		 1878 002 706	420 10 420GTZ	Chass. 3598->
		 3151 000 395	KZIS-4	Chass. 3598->
	DBOM422	 3482 124 534	430 GMF430	
		 1882 301 239 ●	420 GF420	
		 1878 002 706	420 10 420GTZ	
	DBOM422A	 3482 124 522	430 GMF430	
		 1878 002 706	420 10 420GTZ	
		 3151 000 375	KZIS-4	
	DBOM442	 3482 124 522	430 GMF430	
		 1878 002 706	420 10 420GTZ	
	DBOM442A	 3482 083 113	430 MFZ430	
		 1878 080 037	430 10 430WGTZ	
		 3151 217 001	KZIS-5	
MAND2866LOH	 3482 119 031	430 GMF430		
	 1878 080 037	430 10 430WGTZ		
	 3151 273 601	KZI-4,5		

		CODE				
---	--	------	--	---	---	---



















DAF

Bus						
SB 4000				3482 083 032	430 MFZ430	
				1878 080 037	430 10 430WGTZ	
				3151 000 335	KZIS-5	

MB						
MB 200 DKTL MB 2000 DKTL		DKTL1160		1878 001 138	420 10 420GTZ	
				3151 000 515	KZIS-4	
MB 230		LT210/615		3482 119 032	430 GMF430	
				1878 003 657	420 10 420WGTZ	
				3151 000 515	KZIS-4	













SB 01.74 -						
SB 1600 DF SB 1600 DS SB 1600 DT				1882 110 542 ▲	350 GF350	Getr. / GBox: AK/S 5-35-2
				1878 001 071	350 10 350GTZ	Getr. / GBox: AK/S 5-35-2
SB 1602 DF SB 1602 DS				1882 110 542 ▲	350 GF350	
				1878 001 071	350 10 350GTZ	
SB 1602 DT SB 1605		DH/DU/DHB825		1878 000 105	380 10 380GTZ	
SB 3000		DKZ/DKX1160		3482 119 032	430 GMF430	
				1878 003 657	420 10 420WGTZ	
				3151 000 515	KZIS-4	

DRÖGMÖLLER



280 - 440							
E 280 E 290 E 300 E 310 E 320		OM422, A		1800 125 301	420 10 GF420	Getr. / GBox: ZF	
				1882 301 239	420GTZ		
				1878 002 706	KZIS-4		
				3151 000 375			
				3482 124 534	430 GMF430	Getr. / GBox: ZF	
E 330		OM422, A		1878 003 657 ●	420 10 420WGTZ	Getr. / GBox: ZF	
				3151 000 375	KZIS-4	Getr. / GBox: ZF	
			OM442A		1800 125 301	420 10 GF420	
					1882 301 239	420GTZ	
					1878 002 706	KZIS-4	
				3151 000 375			
				3482 124 534	430 GMF430		
			1878 003 657 ●	420 10 420WGTZ			
			3151 000 375	KZIS-4			
			1888 055 041	380 GF2/380	enthält eine Kupplungsscheibe / This part number includes one clutch disc (67)		
		1878 006 055 ▽	380 10 380GT	Lose Kupplungsscheibe / Loose clutch disc (41)			
		1882 349 003	380 GF2/380	In 1888 enthalten / Contained in 1888 (31)			
		1859 250 100	380 GF2/380	In 1888 enthalten / Contained in 1888 (31)			
		1862 138 032 △#	380 10 380GSZ	In 1888 enthalten / Contained in 1888 (31)			

		CODE			 Parameter		
---	--	------	--	--	---	---	---

DRÖGMÖLLER





280 - 440									
E 420 E 430 E 440	OM422, A		1800 125 301	420 10					
			1882 301 239	GF420					
			1878 002 706	420GTZ					
			3151 000 375	KZIS-4					
				3482 124 534	430				
				1878 003 657 ●	420 10				
					420WGTZ				
				3151 000 375	KZIS-4				
		OM442LA		1888 042 009	380	enthält eine Kupplungsscheibe / This part number includes one clutch disc	(67)		
				1878 000 968 ▽	380 10	Lose Kupplungsscheibe / Loose clutch disc	(41)		
				3151 108 031		KZI-4,5			
				1882 341 001	380	GF2/380	In 1888 enthalten / Contained in 1888	(31)	
			1859 250 102	380	GF2/380	In 1888 enthalten / Contained in 1888	(31)		
			1878 000 968 △	380 10	380GTZ	In 1888 enthalten / Contained in 1888	(31)		





ENASA

5036 - 6420							
5036		9156/12		1878 003 276	420 10		
					420GTZ		
5117		9100/56		1861 902 032 #	380 10		
					380GTD		
5123		9220/2		1878 003 276	420 10		
					420GTZ		

EVOBUS

Motor - Daimler							
Motor / Engine		OM457LA		6594 000 079	430	Getr. / GBox: 8 S 180; 10 AS 2301 Getr. / GBox: GO 190/210 für OE-Nummer / for OE number 457 030 13 05 enthält Schwungradbefestigungsschrauben / includes bolt for flywheel mounting	(83) (66)

NF 315...							
NF 315		OM447		3400 700 451	430 10		
					3482 081 231	MFZ430	
					1878 080 031	430WGTZ	
					3151 000 157	KZISZ-5	

S 12 - S 15								
S 12		520GK		1881 041 656 #	380			
				3151 000 395	G380			
					KZIS-4			
S 12 L		520GK		1882 325 134	380			
				3151 000 395	G380			
					KZIS-4			
S 14		520GK		1881 041 656 #	380			
				3151 000 395	G380			
						KZIS-4		
				+6R1215EF-K, 6R1215F-K		1881 041 656 #	380	Getr. / GBox: S 6-70-3
				3151 000 395	G380	Getr. / GBox: S 6-70-3		
					KZIS-4			

		CODE				
---	--	------	--	---	---	---

EVOBUS

S 12 - S 15

S 15		520GK	 1881 041 656 #	380 G380	
			 3151 000 395	KZIS-4	
		6R1215EF-K	 1881 041 656 #	380 G380	Getr. / GBox: S 6-70-3
			 3151 000 395	KZIS-4	Getr. / GBox: S 6-70-3
		GR1215GK	 1882 325 134	380 G380	Getr. / GBox: S 6-80
			 3151 000 395	KZIS-4	Getr. / GBox: S 6-80

S 80...

S 80		551-14K+552	 1881 039 531 #	350 G350	Getr. / GBox: S 8-45/2
			 3151 000 395	KZIS-4	Getr. / GBox: S 5-35/2 Getr. / GBox: S 8-45/2
		551-13K	 1881 039 531 #	350 G350	Getr. / GBox: S 8-45-2
			 3151 000 395	KZIS-4	Getr. / GBox: S 8-45-2
		DBOM352A	 1882 252 333	310 GFX310	
			 1861 303 248	310 10 310GSB	

S 100...

S 100	01.78 -	562-18K	 1881 039 531 #	350 G350	Getr. / GBox: ZF S 6-60
			 3151 000 395	KZIS-4	Getr. / GBox: ZF S 6-60
S 100		561-16K	 1881 039 531 #	350 G350	Getr. / GBox: S 8-45/2
			 3151 000 395	KZIS-4	Getr. / GBox: S 8-45/2

S 110...



S 110	01.78 -	562-18K	 1881 039 531 #	350 G350	Getr. / GBox: ZF S 6-60
			 3151 000 395	KZIS-4	Getr. / GBox: ZF S 6-60
S 110		561-16K	 1881 039 531 #	350 G350	Getr. / GBox: S 8-35-2 Getr. / GBox: S 8-45/2
			 3151 000 395	KZIS-4	Getr. / GBox: S 8-35-2 Getr. / GBox: S 8-45/2























S 120...





S 120	01.78 -	562-18K	 1881 039 531 #	350 G350	Getr. / GBox: ZF S 6-60
			 3151 000 395	KZIS-4	Getr. / GBox: ZF S 6-60
S 120		561-16K	 1881 039 531 #	350 G350	Getr. / GBox: S 8-45/2
			 3151 000 395	KZIS-4	Getr. / GBox: S 8-45/2
		523-18K	 1881 041 656 #	380 G380	Getr. / GBox: S 8-45/2
			 3151 000 395	KZIS-4	Getr. / GBox: S 8-45/2
		524-20K	 1881 041 656 #	380 G380	Getr. / GBox: S 8-45/2
			 3151 000 395	KZIS-4	Getr. / GBox: S 8-45/2
			 1882 325 134	380 G380	Getr. / GBox: S 6-80
			 3151 000 395	KZIS-4	Getr. / GBox: S 6-80
S 125		520GK	 1882 325 134	380 G380	
			 3151 000 395	KZIS-4	
		6R1215EF-K	 1881 041 656 #	380 G380	Getr. / GBox: S 4-60
			 3151 000 395	KZIS-4	Getr. / GBox: S 4-60

		CODE				
---	--	------	--	---	---	---

EVOBUS

S 120...						
S 128 DT 90				3482 083 113	430 MFZ430	Getr. / GBox: S 8-180
				1878 080 037	430 10 430WGTZ	Getr. / GBox: S 8-180
				3151 000 615	KZISZ-5	Getr. / GBox: S 8-180











S 130...							
S 130	01.67 -	523-20K		1881 041 656 #	380 G380	Getr. / GBox: S 6-70-3	
				3151 000 395	KZIS-4	Getr. / GBox: S 6-70-3	
	532-21K		1882 325 134	380 G380	Getr. / GBox: S 6-80		
			3151 000 395	KZIS-4	Getr. / GBox: S 6-80		
S 130	01.78 -	562-18K		1881 039 531 #	350 G350	Getr. / GBox: ZF S 6-60	
				3151 000 395	KZIS-4	Getr. / GBox: ZF S 6-60	
S 130		523-18K		1881 041 656 #	380 G380	Getr. / GBox: S 8-45/2	
				3151 000 395	KZIS-4	Getr. / GBox: S 8-45/2	
	524-20K		1881 041 656 #	380 G380	Getr. / GBox: S 8-45/2		
			3151 000 395	KZIS-4	Getr. / GBox: S 8-45/2		
			524-20K		1882 325 134	380 G380	Getr. / GBox: S 6-80
					3151 000 395	KZIS-4	Getr. / GBox: S 6-80
	524-24K				1882 325 134	380 G380	Getr. / GBox: S 6-80 + GV 80
					3151 000 395	KZIS-4	Getr. / GBox: S 6-80 + GV 80
	561-16K				1881 039 531 #	350 G350	Getr. / GBox: S 8-45/2
					3151 000 395	KZIS-4	Getr. / GBox: S 8-45/2
	OM407H				3482 124 534	430 GMF430	
					1882 301 239 ●	420 GF420	
					1878 003 657	420 10 420WGTZ	
					3151 027 102	KZI4,5	
S 130 S		OM407H+MAN-D2566		1882 302 131	380 GF380	Getr. / GBox: S 6-80 + S 4-90	
				1878 001 152	380 10 380WGTZ	Getr. / GBox: S 6-80 + S 4-90	
				3151 027 102	KZI4,5	Getr. / GBox: S 6-80 + S 4-90	

S 140...							
S 140	01.78 -	562-18K		1881 039 531 #	350 G350	Getr. / GBox: ZF S 6-60	
				3151 000 395	KZIS-4	Getr. / GBox: ZF S 6-60	
S 140		524-20K		1881 041 656 #	380 G380	Getr. / GBox: S 8-45/2	
				3151 000 395	KZIS-4	Getr. / GBox: S 8-45/2	
			524-20K		1882 325 134	380 G380	Getr. / GBox: S 6-80
					3151 000 395	KZIS-4	Getr. / GBox: S 6-80
	524-24K				1882 325 134	380 G380	Getr. / GBox: S 6-80 + GV 80
					3151 000 395	KZIS-4	Getr. / GBox: S 6-80 + GV 80















		CODE				
---	--	------	--	---	---	---

EVOBUS







S 140...

S 140 , ES		OM407H		3482 124 534	430 GMF430	
				1882 301 239 ●	420 GF420	
				1878 003 657	420 10 420WGTZ	
				3151 027 102	KZI4,5	
S 140 ES		D2566DHU		3482 124 534	430 GMF430	Getr. / GBox: S 6-80
				1882 301 239 ●	420 GF420	Getr. / GBox: S 6-80
				1878 003 657	420 10 420WGTZ	Getr. / GBox: S 6-80
				3151 027 102	KZI4,5	Getr. / GBox: S 6-80
		OM407H+MAN-D2566		1882 302 131	380 GF380	Getr. / GBox: S 6-80 + S 4-90
				1878 001 152	380 10 380WGTZ	Getr. / GBox: S 6-80 + S 4-90
				3151 027 102	KZI4,5	Getr. / GBox: S 6-80 + S 4-90

S 150...

S 150	01.67 -	523-20K		1881 041 656 #	380 G380	Getr. / GBox: S 6-70-3
				3151 000 395	KZIS-4	Getr. / GBox: S 6-70-3
S 150	01.78 -	562-18K		1881 039 531 #	350 G350	Getr. / GBox: ZF S 6-60
				3151 000 395	KZIS-4	Getr. / GBox: ZF S 6-60
S 150		523-18K		1881 041 656 #	380 G380	Getr. / GBox: S 8-45/2
				3151 000 395	KZIS-4	Getr. / GBox: S 8-45/2
		524-20K		1881 041 656 #	380 G380	Getr. / GBox: S 8-45/2
				1882 325 134	380 G380	Getr. / GBox: S 6-80
		524-24K		1882 325 134	380 G380	Getr. / GBox: S 6-80 Getr. / GBox: S 8-45/2
				3151 000 395	KZIS-4	Getr. / GBox: S 6-80 + GV 80
		532-21K		1882 325 134	380 G380	Getr. / GBox: S 6-80
				3151 000 395	KZIS-4	Getr. / GBox: S 6-80
		561-16K		1881 039 531 #	350 G350	Getr. / GBox: S 8-45/2
				3151 000 395	KZIS-4	Getr. / GBox: S 8-45/2













S 200...

S 200		OM442A		1882 342 134	420 GF420X	
				1878 005 486	420 10 420WGTZ	
				3151 027 133	KZI4,5	
S 200 Fahrzeug / Vehicle -20		OM403		3482 124 534	430 GMF430	
				1882 301 239 ●	420 GF420	
				1878 003 320	420 10 420GTZ	
				3151 000 515	KZIS-4	

















		CODE				
---	--	------	--	---	---	---

EVOBUS

S 200...

S 200 Fahrzeug / Vehicle 21-		OM403	 3482 124 534	430 GMF430	
			 1882 301 239 ●	420 GF420	
			 1878 002 706	420 10 420GTZ	
			 3151 027 102	KZI4,5	
S 208		OM352A	 3482 012 211	330 GMF330	Getr. / GBox: S 6-65
			 1861 571 110 #	330 10 330GSZ	Getr. / GBox: S 6-65
			 3151 099 101	KZI-4	Getr. / GBox: S 6-65
S 208 H		OM352A	 3482 012 211	330 GMF330	Getr. / GBox: S 6-36
			 1861 874 032	330 10 330WGSZ	Getr. / GBox: S 6-36
			 3151 099 101	KZI-4	Getr. / GBox: S 6-36
S 209 , H		OM401	 1882 302 131	380 GF380	Getr. / GBox: S 6-65
			 1878 001 152	380 10 380WGTZ	Getr. / GBox: S 6-65
			 3151 027 102	KZI4,5	Getr. / GBox: S 6-65

S 210...

S 210 H		OM421A	 3482 012 211	330 GMF330	Getr. / GBox: S 6-65
			 1861 571 110 #	330 10 330GSZ	Getr. / GBox: S 6-65
			 3151 099 101	KZI-4	Getr. / GBox: S 6-65
S 210 H/HD		OM421A	 3482 124 534	430 GMF430	Getr. / GBox: S 6-90
			 1882 301 239 ●	420 GF420	Getr. / GBox: S 6-90
			 1878 003 657	420 10 420WGTZ	Getr. / GBox: S 6-90
			 3151 027 102	KZI4,5	Getr. / GBox: S 6-90
S 211 , H S 214		OM401	 1882 302 131	380 GF380	Getr. / GBox: S 6-65
			 1878 001 152	380 10 380WGTZ	Getr. / GBox: S 6-65
			 3151 027 102	KZI4,5	Getr. / GBox: S 6-65
S 211 H		OM421	 1882 302 131	380 GF380	Getr. / GBox: S 6-65
			 1878 001 152	380 10 380WGTZ	Getr. / GBox: S 6-65
S 211 H/HD S 213 H/HD, RL		OM422	 3482 124 534	430 GMF430	Getr. / GBox: S 6-90
			 1882 301 239 ●	420 GF420	Getr. / GBox: S 6-90
			 1878 003 657	420 10 420WGTZ	Getr. / GBox: S 6-90
			 3151 027 102	KZI4,5	Getr. / GBox: S 6-90



CODE



SACHS

Parameter



EVOBUS

S 210...						
S 212	OM401	1882 302 131	380 GF380	Getr. / GBox: S 6-65		
		1878 001 152	380 10 380WGTZ	Getr. / GBox: S 6-65		
		3151 027 102	KZI4,5	Getr. / GBox: S 6-65		
	OM402	1882 302 131	380 GF380	Getr. / GBox: S 6-80		
		1878 001 152	380 10 380WGTZ	Getr. / GBox: S 6-80		
		3151 027 102	KZI4,5	Getr. / GBox: S 6-80		
	OM403	3482 124 534	430 GMF430	Getr. / GBox: S 6-90		
		1882 301 239 ●	420 GF420	Getr. / GBox: S 6-90		
		1878 003 657	420 10 420WGTZ	Getr. / GBox: S 6-90		
		3151 027 102	KZI4,5	Getr. / GBox: S 6-90		
	S 213 S 215	OM401	1882 302 131	380 GF380	Getr. / GBox: S 6-65	
			1878 001 152	380 10 380WGTZ	Getr. / GBox: S 6-65	
3151 027 102			KZI4,5	Getr. / GBox: S 6-65		
OM402		1882 302 131	380 GF380	Getr. / GBox: S 6-80		
		1878 001 152	380 10 380WGTZ	Getr. / GBox: S 6-80		
		3151 027 102	KZI4,5	Getr. / GBox: S 6-80		
S 213 H/HD S 215 H/HD	OM422A	1882 342 134	420 GF420X	Getr. / GBox: S 4-120GP, S 6-150C		
		1878 003 657	420 10 420WGTZ	Getr. / GBox: S 4-120GP, S 6-150C		
		3151 027 102	KZI4,5	Getr. / GBox: S 4-120GP, S 6-150C		
S 213 HD, HR	OM403	3482 124 534	430 GMF430	Getr. / GBox: S 6-90		
		1882 301 239 ●	420 GF420	Getr. / GBox: S 6-90		
		1878 003 657	420 10 420WGTZ	Getr. / GBox: S 6-90		
		3151 027 102	KZI4,5	Getr. / GBox: S 6-90		
S 214 HD	MAND2866KOH	1882 342 134	420 GF420X	Getr. / GBox: S 6-150C		
		1861 911 232	420 10 420WGVZ	Getr. / GBox: S 6-150C		
		3151 027 102	KZI4,5	Getr. / GBox: S 6-150C		
	OM422A	1882 342 134	420 GF420X	Getr. / GBox: S 4-120GP, S 6-150C		
		1878 003 657	420 10 420WGTZ	Getr. / GBox: S 4-120GP, S 6-150C		
		3151 027 102	KZI4,5	Getr. / GBox: S 4-120GP, S 6-150C		
S 215 , UL	OM422, 447	3482 124 534	430 GMF430	Getr. / GBox: S 6-90,S 6-150C		
		1882 301 239 ●	420 GF420	Getr. / GBox: S 6-90,S 6-150C		
		1878 003 657	420 10 420WGTZ	Getr. / GBox: S 6-90,S 6-150C		
		3151 027 102	KZI4,5	Getr. / GBox: S 6-90,S 6-150C		



CODE



SACHS

Parameter





















EVOBUS

S 210...					
S 215 H/HD, RL	OM422, 442	3482 124 534	430 GMF430	Getr. / GBox: S 6-90	
		1882 301 239 ●	420 GF420	Getr. / GBox: S 6-90	
		1878 003 657	420 10 420WGTZ	Getr. / GBox: S 6-90	
		3151 027 102	KZI4,5	Getr. / GBox: S 6-90	
S 215 HD	MAND2866KOH	1882 342 134	420 GF420X	Getr. / GBox: S 6-150C	
		1861 911 232	420 10 420WGVZ	Getr. / GBox: S 6-150C	
		3151 027 102	KZI4,5	Getr. / GBox: S 6-150C	
	MAND2866LOH	1882 342 134	420 GF420X	Getr. / GBox: S 6-150C	
		1878 003 657	420 10 420WGTZ	Getr. / GBox: S 6-150C	
		3151 027 102	KZI4,5	Getr. / GBox: S 6-150C	
	OM442A	1882 342 134	420 GF420X	Getr. / GBox: S 8-180	
		1878 005 486	420 10 420WGTZ	Getr. / GBox: S 8-180	
		3151 027 133	KZI4,5	Getr. / GBox: S 8-180	
S 215 HD, HR	OM401	3482 081 233	430 MFZ430	Getr. / GBox: S 6-85	
		1878 080 031	430 10 430WGTZ	Getr. / GBox: S 6-85	
		3151 000 278	KZISZ-5	Getr. / GBox: S 6-85	
	OM403	3482 124 534	430 GMF430	Getr. / GBox: S 6-90	
		1882 301 239 ●	420 GF420	Getr. / GBox: S 6-90	
		1878 003 657	420 10 420WGTZ	Getr. / GBox: S 6-90	
		3151 027 102	KZI4,5	Getr. / GBox: S 6-90	
			3189 600 059		
S 215 HR	OM441LA	3482 083 032	430 MFZ430	Getr. / GBox: S 8-180	
		1878 080 033	430 10 430WGTZ	Getr. / GBox: S 8-180	
		3151 000 615	KZISZ-5	Getr. / GBox: S 8-180	
S 215 RL	OM401LA	3482 081 233	430 MFZ430	Getr. / GBox: S 6-85	
		1878 080 031	430 10 430WGTZ	Getr. / GBox: S 6-85	
		3151 000 278	KZISZ-5	Getr. / GBox: S 6-85	
			3189 600 059		
S 215 UL	D2865LOH	3482 124 549	430 GMF430	Getr. / GBox: S 6-85	
		1882 342 135 ●#	420 GF420X	Getr. / GBox: S 6-85 Nur bei Altteil-Rückgabe lieferbar (Reparatur; Werk Bielefeld) / Please return old unit for repair (plant Bielefeld)	(51)
		1878 065 131 #	420 10 420WGTZ	Getr. / GBox: S 6-85	
		3151 027 133	KZI4,5	Getr. / GBox: S 6-85	
	OM447	3482 124 534	430 GMF430	Getr. / GBox: S 6-85	
		1882 301 239 ●	420 GF420	Getr. / GBox: S 6-85	
		1878 003 657	420 10 420WGTZ	Getr. / GBox: S 6-85	
		3151 027 133	KZI4,5	Getr. / GBox: S 6-85	





		CODE				
---	--	------	--	---	---	---

EOBUS

S 210...

















S 215 UL/SL		OM407H, HA/427H, HA	 3482 124 534	430 GMF430	Getr. / GBox: S 4-90, S 5-80 Getr. / GBox: S 6-80, S 6-150 C	
			 1882 301 239 ●	420 GF420	Getr. / GBox: S 4-90, S 5-80 Getr. / GBox: S 6-80, S 6-150 C	
			 1878 003 657	420 10 420WGTZ	Getr. / GBox: S 4-90, S 5-80 Getr. / GBox: S 6-80, S 6-150 C	
			 3151 027 102	KZI4,5	Getr. / GBox: S 4-90, S 5-80 Getr. / GBox: S 6-80, S 6-150 C	
S 216 HDS		MAND2866KOH	 1882 342 134	420 GF420X	Getr. / GBox: S 6-150C	
			 1861 911 232	420 10 420WGVZ	Getr. / GBox: S 6-150C	
			 3151 027 102	KZI4,5	Getr. / GBox: S 6-150C	
		OM422A	 1882 342 134	420 GF420X	Getr. / GBox: S 4-120GP, S 6-150C	
			 1878 003 657	420 10 420WGTZ	Getr. / GBox: S 4-120GP, S 6-150C	
			 3151 027 102	KZI4,5	Getr. / GBox: S 4-120GP, S 6-150C	
			 1882 342 134	420 GF420X	Getr. / GBox: S 8-180	
			 1878 005 486	420 10 420WGTZ	Getr. / GBox: S 8-180	
			 3151 027 133	KZI4,5	Getr. / GBox: S 8-180	
		OM422LA	 1888 042 009	380 GF2/380	Getr. / GBox: S 4-150GP, S 6-150C enthält eine Kupplungsscheibe / This part number includes one clutch disc	(67)
			 1878 000 968 ▽	380 10 380GTZ	Getr. / GBox: S 4-150GP, S 6-150C Lose Kupplungsscheibe / Loose clutch disc	(41)
			 3151 108 031	KZI-4,5	Getr. / GBox: S 8-180	
			 1882 341 001	380 GF2/380	Getr. / GBox: S 4-150GP, S 6-150C In 1888 enthalten / Contained in 1888	(31)
			 1859 250 102	380 GF2/380	Getr. / GBox: S 4-150GP, S 6-150C In 1888 enthalten / Contained in 1888	(31)
			 1878 000 968 △	380 10 380GTZ	Getr. / GBox: S 4-150GP, S 6-150C In 1888 enthalten / Contained in 1888	(31)



S 220...

















S 221 UL		OM447	 3482 124 534	430 GMF430		
			 1882 301 239 ●	420 GF420		
			 1878 003 657	420 10 420WGTZ		
			 3151 027 102	KZI4,5		

		CODE				
---	--	------	--	---	---	---

EVOBUS

S 220...						
S 228 DT	OM422LA		1888 042 009	380 GF2/380	Getr. / GBox: S 4-150GP, S 6-150C enthält eine Kupplungsscheibe / This part number includes one clutch disc	(67)
			1878 000 968 ▽	380 10 380GTZ	Getr. / GBox: S 4-150GP, S 6-150C Lose Kupplungsscheibe / Loose clutch disc	(41)
			3151 108 031	KZI-4,5	Getr. / GBox: S 4-150GP, S 6-150C	
			1882 341 001	380 GF2/380	Getr. / GBox: S 4-150GP, S 6-150C In 1888 enthalten / Contained in 1888	(31)
			1859 250 102	380 GF2/380	Getr. / GBox: S 4-150GP, S 6-150C In 1888 enthalten / Contained in 1888	(31)
			1878 000 968 △	380 10 380GTZ	Getr. / GBox: S 4-150GP, S 6-150C In 1888 enthalten / Contained in 1888	(31)
	OM442LA		3482 081 233	430 MFZ430	Getr. / GBox: S 8-180	
			1878 080 037	430 10 430WGTZ	Getr. / GBox: S 8-180	
			3151 000 157	KZISZ-5	Getr. / GBox: S 8-180	
			3488 017 410	400 MFZ2/400X	Getr. / GBox: S 8-180 enthält eine Kupplungsscheibe / This part number includes one clutch disc	(67)
			1878 634 022 ▽#	400 10 400GVZ	Getr. / GBox: S 8-180	
			1878 005 805 ▽	400 10 400GTZ	Getr. / GBox: S 8-180	
			3151 000 157	KZISZ-5	Getr. / GBox: S 8-180	
			1878 005 805 △	400 10 400GTZ	Getr. / GBox: S 8-180	
			1878 634 023 △	400 10 400GVZ	Getr. / GBox: S 8-180	
						

S 300...						
S 309	OM441LA		3482 081 232	430 MFZ430		
			1878 085 742	430 10 430WGTZ		
			3151 000 615	KZISZ-5		

S 310...						
S 312 HD, HDH	OM401LA, 422		3482 081 232	430 MFZ430		
			1878 085 742	430 10 430WGTZ		
			3151 000 615	KZISZ-5		
	OM402LA, 442A, LA		3482 083 032	430 MFZ430		
			1878 002 734	430 10 430WGTZ		
			3151 000 615	KZISZ-5		
			3400 700 498 ☹  3482 083 032  1878 080 034	430 10 MFZ430 430WGTZ	Bei Geräuschproblemen / In case of noise problems	(8)
	OM441LA		3482 083 113	430 MFZ430		
			1878 002 734	430 10 430WGTZ		
			1878 080 034	430 10 430WGTZ	Bei Geräuschproblemen / In case of noise problems	(8)
		3151 000 615	KZISZ-5			
S 315	OM447		3482 124 534	430 GMF430		
			1878 003 657	420 10 420WGTZ		
			3151 027 102	KZI4,5		



CODE



SACHS

Parameter





















EVOBUS



S 310...							
S 315 GT	OM442LA	3400 127 801 3482 081 233 1878 002 734 3151 000 157	430 10 MFZ430 430WGTZ KZISZ-5				
		3400 700 349 3482 081 233 1878 080 034 3151 000 157	430 10 MFZ430 430WGTZ KZISZ-5	Bei Geräuschproblemen / In case of noise problems	(8)		
S 315 GT-HD	D2866LUH, OM441LA, OM447hLA	3482 081 233	430 MFZ430	Getr. / GBox: ZF S6-85			
		1878 080 031	430 10 430WGTZ	Getr. / GBox: ZF S6-85			
		3151 000 157	KZISZ-5	Getr. / GBox: ZF S6-85			
	D2866LUH, OM441, 442LA, 447hLA	3482 081 233	430 MFZ430	Getr. / GBox: ZF S6-150 Getr. / GBox: ZF S8-180 Getr. / GBox: ZF S6-1600			
		1878 080 037	430 10 430WGTZ	Getr. / GBox: ZF S6-150 Getr. / GBox: ZF S8-180 Getr. / GBox: ZF S6-1600			
		3151 000 157	KZISZ-5	Getr. / GBox: ZF S6-150 Getr. / GBox: ZF S8-180 Getr. / GBox: ZF S6-1600			
	OM441, 442LA, 447hLA	3482 081 233	430 MFZ430	Getr. / GBox: GO 4			
		1878 080 037	430 10 430WGTZ	Getr. / GBox: GO 4			
		3151 000 547	KZISZ-5	Getr. / GBox: GO 4			
	OM442LA	3482 081 233	430 MFZ430	Getr. / GBox: GO 4 mit Retarder VR 115E / with retarder VR 115E	(90)		
		1878 080 037	430 10 430WGTZ	Getr. / GBox: GO 4 mit Retarder VR 115E / with retarder VR 115E	(90)		
		3151 000 547	KZISZ-5	Getr. / GBox: GO 4 mit Retarder VR 115E / with retarder VR 115E	(90)		
S 315 HD, HDH	OM401LA, 422	3482 081 232	430 MFZ430				
		1878 085 742	430 10 430WGTZ				
		3151 000 615	KZISZ-5				
	OM402LA, 442A	3482 083 032	430 MFZ430				
		1878 002 734	430 10 430WGTZ				
		3151 000 615	KZISZ-5				
		3400 700 498 3482 083 032 1878 080 034	430 10 MFZ430 430WGTZ	Bei Geräuschproblemen / In case of noise problems	(8)		
	OM441LA	3482 083 113	430 MFZ430				
		1878 002 734	430 10 430WGTZ				
		1878 080 034	430 10 430WGTZ	Bei Geräuschproblemen / In case of noise problems	(8)		
		3151 000 615	KZISZ-5				
	OM442LA	3482 081 233	430 MFZ430				
		1878 080 037	430 10 430WGTZ				
		3151 000 157	KZISZ-5				
	S 315 NF S 317 ÜL S 319 UL	OM457HLA	3400 700 509	430 10	XTend Nabenprofil / Hub Profile: 41,1x50,8-10N Nur zusammen verbauen / Only install together	(48) (53)	







		CODE				
---	--	------	--	---	---	---

EVOBUS

S 310...						
S 315 UL		OM441, 447HLA		3400 700 451 ⊗ 3482 081 231 ⊗ 1878 080 031 ⊙ 3151 000 157	430 10 MFZ430 430WGTZ KZISZ-5	
			MAND2866LUH		3482 081 233	430 MFZ430
				1878 080 033	430 10 430WGTZ	
			3151 000 157	KZISZ-5		
S 316 HDS S 317 HDH		OM442LA		3482 083 032	430 MFZ430	
				1878 002 734	430 10 430WGTZ	
				3151 000 615	KZISZ-5	
				3400 700 498 ◐ ⊗ 3482 083 032 ⊗ 1878 080 034	430 10 MFZ430 430WGTZ	Bei Geräuschproblemen / In case of noise problems (8)
S 319 NF		447HLA, D2866LUH, OM441LA		3482 081 233	430 MFZ430	
				1878 080 031	430 10 430WGTZ	Getr. / GBox: ZF 6S-85
				1878 080 033	430 10 430WGTZ	Getr. / GBox: S6-1600/S6-150 Getr. / GBox: S8-180
				3151 000 157	KZISZ-5	

S 320...						
S 328 DT		OM442LA		3488 017 410	400 MFZ2/400X	Getr. / GBox: S 8-180 enthält eine Kupplungsscheibe / This part number includes one clutch disc (67)
				1878 005 805 ▽	400 10 400GTZ	Getr. / GBox: S 8-180
				1878 634 022 ▽#	400 10 400GVZ	Getr. / GBox: S 8-180
				3151 000 157	KZISZ-5	Getr. / GBox: S 8-180
				1878 634 023 △	400 10 400GVZ	Getr. / GBox: S 8-180
				1878 005 805 △	400 10 400GTZ	Getr. / GBox: S 8-180

SG 175...						
SG 175		520GK		1882 325 134	380 G380	
				3151 000 395	KZIS-4	

SG 180...						
SG 180		MAND2566DHU		3482 124 534	430 GMF430	Getr. / GBox: S 6-80
				1882 301 239 ●	420 GF420	Getr. / GBox: S 6-80
		MAND2566DHU , OM407H		1878 003 657	420 10 420WGTZ	Getr. / GBox: S 6-80
				3151 027 102	KZI4,5	Getr. / GBox: S 6-80
				1882 302 131	380 GF380	Getr. / GBox: S 6-80 + S 4-90
		OM407H+MAN- D2566		1878 001 152	380 10 380WGTZ	Getr. / GBox: S 6-80 + S 4-90
				3151 027 102	KZI4,5	Getr. / GBox: S 6-80 + S 4-90



CODE



SACHS

Parameter



IKARUS

100 - 542

250 255	D2156HM6U	3482 124 541	430 GMF430	Getr. / GBox: 5-G	
		1882 330 032 ●#	420 GF420	Getr. / GBox: 5-G	
		1861 206 211 #	420 10 420GS	Getr. / GBox: 5-G	
		3482 124 531	430 GMF430	Getr. / GBox: 6-G	
		1882 316 035 ●#	420 GF420	Getr. / GBox: 6-G	
		1878 001 138	420 10 420GTZ	Getr. / GBox: 6-G	
		3151 000 515	KZIS-4	Getr. / GBox: 6-G	
		1863 009 100	GR-5	Getr. / GBox: 5-G mit Anlauftring / with thrust ring	(88)
280 256		3482 124 541	430 GMF430	Getr. / GBox: 5-G	
		1882 330 032 ●#	420 GF420	Getr. / GBox: 5-G	
		1861 206 211 #	420 10 420GS	Getr. / GBox: 5-G	
		3482 124 531	430 GMF430	Getr. / GBox: 6-G	
		1882 316 035 ●#	420 GF420	Getr. / GBox: 6-G	
		1878 001 138	420 10 420GTZ	Getr. / GBox: 6-G	
		3151 000 515	KZIS-4	Getr. / GBox: 6-G	
		1863 009 100	GR-5	Getr. / GBox: 5-G mit Anlauftring / with thrust ring	(88)
266		3482 124 541	430 GMF430	Getr. / GBox: 5-G	
		1882 330 032 ●#	420 GF420	Getr. / GBox: 5-G	
		1861 206 211 #	420 10 420GS	Getr. / GBox: 5-G	
		1882 316 035 #	420 GF420	Getr. / GBox: 6-G	
		1878 001 138	420 10 420GTZ	Getr. / GBox: 6-G	
		3151 000 515	KZIS-4	Getr. / GBox: 6-G	
		1863 009 100	GR-5	Getr. / GBox: 5-G mit Anlauftring / with thrust ring	(88)
		521 (VW)		3000 055 005	228 23 M228 220VTPB KZIS-0
3082 190 031					
1878 004 776					
3151 193 041					
542	OM364	3482 055 132	310 MFZ310		
		1861 303 248	310 10 310GSB		
		3151 170 131	KZIZ-3		























IK 212

IK 212		1881 039 532 #	350 G350KR		
		1878 005 367	350 10 350WGTZ		

		CODE				
---	--	------	--	---	---	---

IRISBUS





ARES

Ares				3482 083 252	430 MFZ430	Getr. / GBox: B8 TBV	
				1878 020 241	430 20 430WGTZ	Getr. / GBox: B8 TBV	
				3151 250 231	KZISZ-5	Getr. / GBox: B8 TBV	
				3482 083 252	430 MFZ430	Getr. / GBox: ZF 6S-85 Getr. / GBox: ZF 8S-180	
				3400 700 493  3482 083 252  1878 004 832	430 10 MFZ430 430WGTZ	-> 10.2001 Getr. / GBox: ZF 8S-180 Produktionsnummer bis / Production number to: CAM 15K1	(56)
				1878 026 241	430 10 430WGTZ	Getr. / GBox: ZF 6S-85	
				3151 250 231	KZISZ-5	Getr. / GBox: ZF 6S-85 Getr. / GBox: ZF 8S-180	
				3482 083 252	430 MFZ430	Getr. / GBox: ZF 10AS2301	
				3400 700 493  3482 083 252  1878 004 832	430 10 MFZ430 430WGTZ	-> 10.2001 Getr. / GBox: ZF 10AS2301 Produktionsnummer bis / Production number to: CAM 15K1	(56)
				3151 000 144	KZISZ-5	Getr. / GBox: ZF 10AS2301 für Ausrückgabel mit Nocken / for release fork with cams	(70)
		DCI11, MIDR062356		3482 083 252	430 MFZ430	Getr. / GBox: ZF 6S-1600	
				3400 700 493  3482 083 252  1878 004 832	430 10 MFZ430 430WGTZ	-> 10.2001 Getr. / GBox: ZF 6S-1600 Produktionsnummer bis / Production number to: CAM 15K1	(56)
				3151 250 231	KZISZ-5	Getr. / GBox: ZF 6S-1600	
		F2B		3482 078 134	400 MFZ400	Getr. / GBox: 6S-1600	
				1878 032 032	400 10 400WGTZ	Getr. / GBox: 6S-1600	
			3151 000 157	KZISZ-5	Getr. / GBox: 6S-1600		

ARWAY 01.05 -

10.6M, 12M, 12.8M	06.06 -	F2BE3681B		3400 700 633	430 10	Nabenprofil / Hub Profile: 2" -10N	(48)
10.6M, 12M, 12.8M	06.06 -						

AXER 10.03 - 01.07

C956				3400 700 328  3482 078 134  1878 032 032  3151 000 157	400 10 MFZ400 400WGTZ KZISZ-5		
-------------	--	--	---	--	---	--	--

CROSSWAY 06.06 -

10.6m, 12m, 12.8m	06.06 -	F2BE0682		3400 700 497  3482 078 132  1878 634 034  3151 250 231	400 10 MFZ400 395WGTZ KZISZ-5	Getr. / GBox: 6S 1600	
10.6m, 12m, 12.8m	06.06 -						
12m, 12.8m	06.06 -						
10.6m, 12m, 12.8m	06.06 -	F4AE0682, F4AE0682L, F4AE3882A		3400 700 497  3482 078 132  1878 634 034  3151 250 231	400 10 MFZ400 395WGTZ KZISZ-5	Getr. / GBox: 6S 1200	





DOMINO 10.03 -



HD	06.06 -			3482 000 573	430 MFZ430	Getr. / GBox: AS-Tronic	
HD, HDH	06.06 -			1878 000 298	430 10 430GTZ/E	Getr. / GBox: AS-Tronic	
				3151 000 493	KZISZ-5	Getr. / GBox: AS-Tronic für Ausrückgabel mit Rollen / for release fork with rollers	(71)
				3189 600 004		Getr. / GBox: ZF AS Tronic Rollenausführung / roller version	(58)











		CODE				
---	--	------	--	---	---	---



IRISBUS

EVADYS		10.03 -				
H 12m, 12.8m	10.03-		3400 700 633	430 10	Nabenprofil / Hub Profile: 2" -10N	(48)
HD 12m	10.03-					

ILIADE							
Iliade				3400 123 401 ⊗ 3482 083 252 ⊗ 1878 020 241 ⊙ 3151 250 231	430 20 MFZ430 430WGTZ KZISZ-5	06.1997-> Getr. / GBox: B9,B8 170R5 TBV	
				3400 700 409 ⊗ 3482 083 252 ⊗ 1878 026 241 ⊙ 3151 250 231	430 10 MFZ430 430WGTZ KZISZ-5	09.1997-> Getr. / GBox: ZF S6-85	
				3400 700 330 ⊗ 3482 083 252 ⊗ 1878 004 832 ⊙ 3151 250 231	430 10 MFZ430 430WGTZ KZISZ-5	10.1997-> Getr. / GBox: ZF S8-180 Produktionsnummer ab / Production number from: CAM 12KV	(55)
				3482 083 252	430 MFZ430	Getr. / GBox: ZF 6S-1600	
				3151 250 231	KZISZ-5	Getr. / GBox: ZF 6S-1600	

KAROSA		01.99 -				
MIHR 062045				3482 083 044	430 MFZ430	
				1878 026 241	430 10 430WGTZ	
				3100 008 106 ⊙ 3151 234 132 ⊙ 3180 000 009	KZISZ-5 KZISZ-5	Beinhaltet Ausrücker und Montagesatz / Contains releaser and fitting kit

MAGELYS		08.08 - 12.13					
Magelys	01.07-	Cursor9		6594 000 211	430 430Z	Getr. / GBox: 12 AS 2001 Getr. / GBox: 6 S 1911 Euro 6 / Euro 6	(18)
				3482 000 573	430 MFZ430	Getr. / GBox: 12 AS 2001 Getr. / GBox: 6 S 1911 Euro 6 / Euro 6	(18)
				1878 054 933	430 10 430GTZ	Getr. / GBox: 12 AS 2001 Getr. / GBox: 6 S 1911 Euro 6 / Euro 6	(18)
				3151 001 084	KZISZ-5	Getr. / GBox: 6 S 1911 Euro 6 / Euro 6	(18)
				3151 000 493	KZISZ-5	Getr. / GBox: 12 AS 2001 Euro 6 / Euro 6 für Ausrückgabel mit Rollen / for release fork with rollers	(18) (71)
				3189 600 004		Getr. / GBox: ZF AS Tronic Rollenausführung / roller version	(58)
HD HD	08.08 - 12.13 08.08 - 12.13			6594 000 171	430 430Z	für Motoren mit Zweimassenschwungrad / for engines with dual-mass flywheel	(80)
				3482 000 573	430 MFZ430	Getr. / GBox: AS-Tronic	
				1878 000 298	430 10 430GTZ/E	Getr. / GBox: AS-Tronic	
				3151 000 493	KZISZ-5	Getr. / GBox: AS-Tronic für Ausrückgabel mit Rollen / for release fork with rollers	(71)
				3189 600 004		Getr. / GBox: ZF AS Tronic Rollenausführung / roller version	(58)

MIDIRIDER							
Bus		F2BE0682		3400 700 497 ⊗ 3482 078 132 ⊗ 1878 634 034 ⊙ 3151 250 231	400 10 MFZ400 395WGTZ KZISZ-5	Getr. / GBox: 6S 1600	
		F4AE0682, F4AE0682L, F4AE3882A		3400 700 497 ⊗ 3482 078 132 ⊗ 1878 634 034 ⊙ 3151 250 231	400 10 MFZ400 395WGTZ KZISZ-5	Getr. / GBox: 6S 1200	





		CODE				
---	--	------	--	---	---	---

IRISBUS

OBRADORE 01.99 -

Obradore		MIDR062045M1 MIDR062045M4 1, MIDR062056A4 1		3400 123 401 ⊗ 3482 083 252 ⊗ 1878 020 241 ⊙ 3151 250 231	430 20 MFZ430 430WGTZ KZISZ-5	Getr. / GBox: B9/B8L	
		MIDR062045M4 1, MIDR062056A4 1, MIDR062345A4 1		3482 083 252	430 MFZ430	Getr. / GBox: ZF S8-180	
				1878 022 841	430 10 430GTZ	Getr. / GBox: ZF S8-180	
				3151 250 231	KZISZ-5	Getr. / GBox: ZF S8-180	

RECREO 10.03 - 01.07

C 935		MIHR062045A/4 1		3400 116 901 ⊗ 3482 083 044 ⊗ 1878 026 241 ⊙ 3100 008 106	430 10 MFZ430 430WGTZ KZISZ-5	Getr. / GBox: 5P 115	
C 955				3400 700 328 ⊗ 3482 078 134 ⊗ 1878 032 032 ⊙ 3151 000 157	400 10 MFZ400 400WGTZ KZISZ-5		
12m, 12.8m	10.03-01.07	F2BE0682		3400 700 497 ⊗ 3482 078 132 ⊗ 1878 634 034 ⊙ 3151 250 231	400 10 MFZ400 395WGTZ KZISZ-5	Getr. / GBox: 6S 1600	
		F4AE0682, F4AE0682L, F4AE3882A		3400 700 497 ⊗ 3482 078 132 ⊗ 1878 634 034 ⊙ 3151 250 231	400 10 MFZ400 395WGTZ KZISZ-5	Getr. / GBox: 6S 1200	

TRACER 01.99 -

332		MIHR062045		3400 700 341 # ⊗ 3482 083 044 ⊗ 1878 049 041 ⊙ 3100 008 106	430 16 MFZ430 430WGTZ KZISZ-5	Getr. / GBox: G406	
-----	--	------------	---	---	---	--------------------	--

IVECO

A 55... - A 90...

A 55-10				1878 600 841	280 10 280CTB	->08.1983	
				1878 600 841	280 10 280CTB	09.1983->	

Bus

Midirider 27				3482 123 839	395 MF395	YAHE00A1 / YAHE00AD	
				1878 000 036	395 10 395WGTZ	YAHE00A1 / YAHE00AD	
				3151 000 419	KZIS-4	YAHE00A1 / YAHE00AD	

Eurorider

31 35 35 A		F2BE0682A, F2BE0682F		3482 083 113	430 MFZ430	Getr. / GBox: S6-1600	
				1878 002 825	430 10 430WGTZ	Getr. / GBox: S6-1600	
				3151 000 144	KZISZ-5	Getr. / GBox: S6-1600 für Ausrückgabel mit Nocken / for release fork with cams	(70)
				3496 006 000		Getr. / GBox: S6-1600 langer Bügel / long handle	(86)

Leoncino







Leoncino AL 5				1878 600 841	280 10 280CTB		
---------------	--	--	---	---------------------	-------------------------	--	--

		CODE				
---	--	------	--	---	---	---



IVECO

Lupetto						
Lupetto AL 5				1878 600 841	280 10 280CTB	

M 2000						
M 2000	01.77 -	8210		3400 119 001 3482 085 033 1878 001 138 1874 015 200	420 10 MF420 420GTZ	enthält Druckplattenbefestigungsschrauben / includes bolt for pressure plate mounting (65)







MAGELYS 07.11 -						
Magelys Pro	07.11 -	Cursor9		6594 000 211	430 430Z	Getr. / GBox: 12 AS 2001 Getr. / GBox: 6 S 1911 Euro 6 / Euro 6 (18)
				3482 000 573	430 MFZ430	Getr. / GBox: 12 AS 2001 Getr. / GBox: 6 S 1911 Euro 6 / Euro 6 (18)
				1878 054 933	430 10 430GTZ	Getr. / GBox: 12 AS 2001 Getr. / GBox: 6 S 1911 Euro 6 / Euro 6 (18)
				3151 001 084	KZISZ-5	Getr. / GBox: 6 S 1911 Euro 6 / Euro 6 (18)
				3151 000 493	KZISZ-5	Getr. / GBox: 12 AS 2001 Euro 6 / Euro 6 für Ausrückgabel mit Rollen / for release fork with rollers (18) (71)
				3189 600 004		Getr. / GBox: ZF AS Tronic Rollenausführung / roller version (58)

Tigrotto						
Tigrotto AL 5				1878 600 841	280 10 280CTB	

Zeta 01.79 - 12.92						
A 60-10	11.79 - 06.88	8340.05.200, 8340.04.040		1878 600 841	280 10 280CTB	
A 70-12	01.83 - 01.85					
A 60-9	09.88 - 12.92	8060.05.285, 8060.05.246, 8040.05.203, 8040.05.200		3482 911 001	270 MF270	Je nach Kundenwunsch mit unterschiedlicher Kupplung / Equipped with different clutch according to customer requirement (35)
A 70-14	05.88 - 12.92			1862 811 001	270 10 270CTB	Je nach Kundenwunsch mit unterschiedlicher Kupplung / Equipped with different clutch according to customer requirement (35)



50...						
50 AL -000378				1878 600 834	250 10 250CB	
50 AL 000379-						

300...						
300 PC				1861 572 431	420 10 420/210GS	



315...						
315-13				3482 008 033	310 MF310	
				1861 653 132	310 10 310WGSZ	
				3151 199 001	KZIS-3	
315 .8/17 315 /17		8060		3482 012 238	330 GMF330	
				1861 874 032	330 10 330WGSZ	
				3151 199 001	KZIS-3	

















		CODE				
---	--	------	--	---	---	---



IVECO

316...						
316-13				3482 008 033	310 MF310	
				1861 653 132	310 10 310WGSZ	
				3151 199 001	KZIS-3	

329...						
329 A, B				1878 600 841	280 10 280CTB	

331...						
331 A 001003-				1882 325 134	380 G380	
				1878 000 957	380 10 380GTZ	



370...						
370-10 /20 370-10 /25 370-11 /25 370-12 /25 370-12 /26		8260		3400 119 001  3482 085 033 1878 001 138 1874 015 200	420 10 MF420 420GTZ	->Chass. 006654 enthält Druckplattenbefestigungsschrauben / includes bolt for pressure plate mounting (65)
				3151 098 031	KZI-4,5	->Chass. 006654
				3482 125 131	420 MF420	Chass. 006655-> enthält Druckplattenbefestigungsschrauben / includes bolt for pressure plate mounting (65)
				3151 114 031	KZI-4,5	Chass. 006655->
370-10 /24 370-12 /24 370-12 /25 L		8210, 8220		3482 125 131	420 MF420	enthält Druckplattenbefestigungsschrauben / includes bolt for pressure plate mounting (65)
				1878 001 138	420 10 420GTZ	
				3151 098 031	KZI-4,5	
370-12 /26 (Unic)		8210		3400 119 001  3482 085 033 1878 001 138 1874 015 200	420 10 MF420 420GTZ	enthält Druckplattenbefestigungsschrauben / includes bolt for pressure plate mounting (65)
370-12 /30		8210		3400 042 031  3482 125 131 1878 002 955 1874 015 200	420 10 MF420 420GTZ	enthält Druckplattenbefestigungsschrauben / includes bolt for pressure plate mounting (65)
				3151 098 031	KZI-4,5	
370-12 /35		8260, 8280		3400 042 031  3482 125 131 1878 002 955 1874 015 200	420 10 MF420 420GTZ	Getr. / GBox: Fiat, ZF enthält Druckplattenbefestigungsschrauben / includes bolt for pressure plate mounting (65)
				3151 127 031	KZI-4,5	Getr. / GBox: Fiat, ZF
370-S24 370-S25L 370-S30 370-S35 370-SE.27				3151 207 031	KZIS-4	

380...						
380.29 380.35 380.38	01.95 -	8460		3482 083 118	430 MFZ430	
	01.95 -			1878 085 741	430 10 430WGTZ	
	01.95 -			3151 000 144	KZISZ-5	für Ausrückgabel mit Nocken / for release fork with cams (70)

409...						
409 B				1882 325 134	380 G380	
				1878 000 957	380 10 380GTZ	

		CODE				
---	--	------	--	---	---	---



IVECO

418...						
418 A/AC/AL	05.78-			1882 325 134	380 G380	
				1878 000 957	380 10 380GTZ	



KAMAZ

5 01.69 -						
5297-15		740.31-240		3400 700 345 3482 083 118 1878 000 206 3151 000 034	430 10 MFZ430 430GTZ KZISZ-5	Getr. / GBox: KAMA3-141 Getr. / GBox: KAMA3-142



KAVZ

AURORA 01.06 -						
4235	01.08-	ISBe150		3482 000 419	362 MF362	
				1878 002 599	362 10 362GTZ	
				3151 000 419	KZIS-4	

KING LONG



XMQ 08.10 -						
XMQ6900	08.10-	CumminsISLe4225B		3482 000 464	395 MF395	Getr. / GBox: ZF 6S 950
				1878 000 294	395 10 395WGTZ	Getr. / GBox: ZF 6S 950
				3151 000 395	KZIS-4	Getr. / GBox: ZF 6S 950

LAZ

BUS						
Bus		Cummins		3482 083 118	430 MFZ430	Getr. / GBox: ZF-6S 700/1000/1701
				1878 080 031	430 10 430WGTZ	Getr. / GBox: ZF-6S 700/1000/1701
				3151 000 157	KZISZ-5	Getr. / GBox: ZF-6S 700/1000/1701

MAGIRUS-DEUTZ



O 3500...						
O 3500 O 3500 V 6		F6L614		1861 034 147 #	350 10	









Saturn I - III						
Saturn I (O3500H) Saturn II /II IS Saturn III /LS/MS				1881 039 532 #	350 G350KR	
				1878 001 074	350 10 350GTZ	
				1863 600 125	GR-3	mit Anlaufring / with thrust ring (88)



110...						
110 E 6				1863 600 125	GR-3	mit Anlaufring / with thrust ring (88)









		CODE				
---	--	------	--	---	---	---







MAGIRUS-DEUTZ

130...						
130 L 81 130 R 81		F6L913		3482 008 033	310 MF310	
				1861 653 132	310 10 310WGSZ	
				3151 199 001	KZIS-3	

150...						
150 E 100				1881 039 532 #	350 G350KR	
				1878 005 367	350 10 350WGTZ	
150 R/L 10 150 S 10		F6L312		1881 039 532 #	350 G350KR	
				1878 005 367	350 10 350WGTZ	
150 R/L 10, 12				1881 039 532 #	350 G350KR	
				1878 001 074	350 10 350GTZ	
				1863 600 125	GR-3	mit Anlauftring / with thrust ring
150 S 11 M		F6L413		1881 041 656 #	380 G380	
				1861 351 342 #	380 10 380WGSZ	





























160...						
160 L 81 160 R 81				3482 012 211	330 GMF330	
				1861 874 032	330 10 330WGSZ	
				3151 199 001	KZIS-3	

170...						
170 E 100 170 TR 100 (Version 2547212)		F6L413		1881 039 532 #	350 G350KR	
				1878 005 367	350 10 350WGTZ	
				1863 600 125	GR-3	mit Anlauftring / with thrust ring
170 L 100 170 R 100 170 TR 100				1881 039 532 #	350 G350KR	
				1878 005 367	350 10 350WGTZ	
				1863 600 125	GR-3	mit Anlauftring / with thrust ring
170 SH 110		F6L413		1881 041 656 #	380 G380	
				1861 351 342 #	380 10 380WGSZ	

200...						
200 E 12 200 R/L		F8L312		1881 041 656 #	380 G380	
				1861 351 342 #	380 10 380WGSZ	
200 E 110				1882 325 134	380 G380	
				1861 351 342 #	380 10 380WGSZ	
				1863 101 100 ▲	GR-4	mit Anlauftring / with thrust ring
200 LS /RS 12		F8L312, F8L413		1881 041 656 #	380 G380	
				1861 351 342 #	380 10 380WGSZ	

		CODE				
---	--	------	--	---	---	---

MAGIRUS-DEUTZ

200...						
200 SH 110		1881 041 656 #	380 G380			
		1861 351 342 #	380 10 380WGSZ			
220...						
226 L 117		3482 124 532	430 GMF430		Getr. / GBox: S 4-90	
		1878 001 154 #	420 10 420WGTZ		Getr. / GBox: S 4-90	
		3151 000 515	KZIS-4		Getr. / GBox: S 4-90	
230...						
230 E 100 230 E 110		1882 325 134	380 G380			
		1861 351 342 #	380 10 380WGSZ			
		3151 000 395	KZIS-4			
230 E 100 (Version 2547021)		1881 039 532 #	350 G350KR			
		1878 005 367	350 10 350WGTZ			
		1863 600 125	GR-3		mit Anlauftring / with thrust ring	(88)
230 E 113 (Version 2547018) 230 L 120 230 T 117		1882 325 134	380 G380			
		1861 351 342 #	380 10 380WGSZ			
230 E 113 (Version 42246020/42/71) 230 E 117 230 T 117 (Version 42246022)		1882 325 134	380 G380			
		1878 001 152	380 10 380WGTZ			
		3151 000 515	KZIS-4			
230 E 113 (Version 42246069)		1882 325 139	380 G380			
		1878 001 152	380 10 380WGTZ			
		3151 000 515	KZIS-4			
230 E 113 (Version 42246073)		3482 124 531	430 GMF430			
		1882 316 035 ●#	420 GF420			
		1878 001 154 #	420 10 420WGTZ			
		1878 003 657 ●	420 10 420WGTZ			
		3151 000 515	KZIS-4			
230 E 120		1882 325 134	380 G380			
		1861 351 342 #	380 10 380WGSZ			
		1863 101 100 ▲	GR-4		mit Anlauftring / with thrust ring	(88)
230 EV 110 230 EV 120		1882 325 134	380 G380			
		1878 001 152	380 10 380WGTZ			
		3151 000 395	KZIS-4			



CODE



SACHS

Parameter



MAGIRUS-DEUTZ

230...







230 L 117			1882 325 134	380 G380	Getr. / GBox: S 6-70/3 Getr. / GBox: S 6-65		
			1861 351 342 #	380 10 380WGSZ	Getr. / GBox: S 6-70/3		
			1878 001 152	380 10 380WGTZ	Getr. / GBox: S 6-65		
			3151 199 001	KZIS-3	Getr. / GBox: S 6-70/3 Getr. / GBox: S 6-65		
			F8L413F	3482 124 532	430 GMF430	Getr. / GBox: S 6-65	
				1878 001 154 #	420 10 420WGTZ	Getr. / GBox: S 6-65	
				3151 000 515	KZIS-4	Getr. / GBox: S 6-65	
230 R 100 230 R 120 230 TR 100 230 TR 120		F8L413	1882 325 134	380 G380			
			1861 351 342 #	380 10 380WGSZ			
			1863 101 100 ▲	GR-4	mit Anlauftring / with thrust ring	(88)	
230 SH 110			1882 325 134	380 G380	Getr. / GBox: S 6-70/3		
			1861 351 342 #	380 10 380WGSZ	Getr. / GBox: S 6-70/3		
			3151 199 001	KZIS-3	Getr. / GBox: S 6-70/3		
			F8L914	1882 325 139	380 G380		
				1878 000 957	380 10 380GTZ		





260...



260 E 113 (Version 42246065/70)			1882 325 139	380 G380			
			1878 001 152	380 10 380WGTZ			
			3151 000 515	KZIS-4			
260 E 113 (Version 42246068) 260 T 117			1882 325 134	380 G380			
			1878 001 152	380 10 380WGTZ			
			3151 000 515	KZIS-4			
260 E 113 (Version 42246073/79)			3482 124 531	430 GMF430			
			1882 316 035 ●#	420 GF420			
			1878 001 154 #	420 10 420WGTZ			
			1878 003 657 ●	420 10 420WGTZ			
			3151 000 515	KZIS-4			
260 L 117			1882 325 134	380 G380	Getr. / GBox: S 6-65		
			1878 001 152	380 10 380WGTZ	Getr. / GBox: S 6-65		
			3151 199 001	KZIS-3	Getr. / GBox: S 6-65		
			F8L413F	3482 124 532	430 GMF430	Getr. / GBox: S 6-65	
				1878 001 154 #	420 10 420WGTZ	Getr. / GBox: S 6-65	
				3151 000 515	KZIS-4	Getr. / GBox: S 6-65	

		CODE				
---	--	------	--	---	---	---

MAGIRUS-DEUTZ



260...						
260 R 106 260 R 119				3482 124 531	430 GMF430	
				1882 316 035 ●#	420 GF420	
				1878 003 657	420 10 420WGTZ	
				3151 000 515	KZIS-4	
260 SH 110		F8L413F		3482 124 532	430 GMF430	Getr. / GBox: S 6-65
				1878 001 154 #	420 10 420WGTZ	Getr. / GBox: S 6-65
				3151 000 515	KZIS-4	Getr. / GBox: S 6-65







280...						
280 E 113				3482 124 531	430 GMF430	
				1882 316 035 ●#	420 GF420	
				1878 001 154 #	420 10 420WGTZ	
				1878 003 657 ●	420 10 420WGTZ	
				3151 000 515	KZIS-4	

2000						
2000		F8L413F		3482 124 532	430 GMF430	Getr. / GBox: S 6-65
				1878 001 152	380 10 380WGTZ	Getr. / GBox: S 6-65
				3151 000 515	KZIS-4	Getr. / GBox: S 6-65

MAN

EL 01.93 - 01.01						
EL 202,EL 222 A12	01.93 - 06.97	D0826LUH03, D0826LUH12, D2866LUH22, D0826LUH, D0826LUH05		3482 086 132	400 MFZ400X	A12
EL 202,EL 262 A12	04.94 - 06.97			1862 364 133	400 10 400WGVZ	A12
EL 262 A12	07.98 -			3151 000 034	KZISZ-5	A12
				3189 600 020		Getr. / GBox: ZF Ecosplit-3





EM 08.87 -						
EM 192 469	10.93 - 06.97	D0826LOH15, D0826LOH06		3482 060 132	350 MF350	
EM 223 469	08.87 -			1878 000 841 #	350 10 350WGTZ	
				3151 199 001	KZIS-3	











G 10.79 - 08.88						
8.136 FOC 563	03.82 - 07.88	D0226		3400 124 201 #	280 28 MFZ280	Fahrzeug kann mit unterschiedlichen Kupplungsgrößen ausgerüstet sein / vehicle can be mounted with different clutch sizes (22)
9.136 FOC 563	03.82 - 07.88			3482 032 331 1861 841 132 3151 600 541	280GTPZ KZIZ-2	
				3400 125 801 3482 102 031 1862 219 031 3151 600 541	310 28 MFZ310 310GTPD KZIZ-2	Fahrzeug kann mit unterschiedlichen Kupplungsgrößen ausgerüstet sein / vehicle can be mounted with different clutch sizes (22)
				3482 060 132	350 MF350	Fahrzeug kann mit unterschiedlichen Kupplungsgrößen ausgerüstet sein / vehicle can be mounted with different clutch sizes (22)
				1861 777 037	350 10 350GTD	
				3151 199 001	KZIS-3	



		CODE				
---	--	------	--	---	---	---

MAN

G 90		09.87 - 05.95				
8.150 FOC L05	07.88 - 10.93	D0826F, GF	 3400 125 801 ⊗ 3482 102 031 ⊗ 1862 219 031 ⊙ 3151 600 541	310 28 MFZ310 310GTPD KZIZ-2	L02,03,05	
8.170 FOC L05	02.89 - 10.93					
9.150 FOC L05	07.88 - 10.93					
9.170 FOC L05	02.89 - 10.93					





HOCL						
14.280 HOCL A67	08.02 - 12.14	D0836LOH40, D0836LOH51, D0836LOH55	 3482 000 361	430 MFZ430		
14.280 HOCL A67	08.02 - 12.14		 1878 080 034	430 10 430WGTZ		
			 3151 000 034	KZISZ-5		
18.310 HOCL/R A51	01.92 -	D2866LOH25, D2866LOH27	 3400 122 301 ⊗ 3482 083 032 ⊗ 1878 080 034 ⊙ 3151 000 034	430 10 MFZ430 430WGTZ KZISZ-5		
			3400 700 403 ⊗ 3482 000 361 ⊗ 1878 004 832 ⊙ 3151 000 144	430 10 MFZ430 430WGTZ KZISZ-5	für Ausrückgabel mit Nocken / for release fork with cams	(70)
			3400 700 381 ⊗ 3482 000 361 ⊗ 1878 080 037 ⊙ 3151 000 493	430 10 MFZ430 430WGTZ KZISZ-5	für Ausrückgabel mit Rollen / for release fork with rollers	(71)



















































L 2000		10.93 -				
8.150 FOC,8.150 FOCL L50 L51	02.95 -	D0824	 3400 700 322 ⊗ 3482 093 032 ⊗ 1862 438 032	330 10 MFZ330 330WTB	L50,51 Je nach Kundenwunsch mit unterschiedlicher Kupplung / Equipped with different clutch according to customer requirement	(35)
			 3400 121 801 ⊗ 3482 120 031 ⊗ 1878 044 631	362 10 MFZ362 362GTZ	L50,51 Je nach Kundenwunsch mit unterschiedlicher Kupplung / Equipped with different clutch according to customer requirement	(35)
			 3182 005 231	HHISZ-3	L50,51 Füllmedium: Bremsflüssigkeit / Fill Medium: Brake Fluid Immer erneuern / Renew everytime	(25) (30)
			 3400 710 001 ⊗ 3482 120 031 ⊗ 1878 044 631 ⊙ 3182 005 231	362 10 MFZ362 362GTZ HHISZ-3	L50,51	
8.220 FOC,8.220 FOCL L52 L53	04.95 -	D0826	 3482 060 132	350 MF350	L53	
10.220 FOC,10.220 FOCL L53 L52	02.95 -		 1878 001 145	350 10 350WGTZ	L53	
			 3151 199 001	KZIS-3	L53	
10.150 FOC L50	02.95 - 01.96	D0824LFO	 3400 121 801 ⊗ 3482 120 031 ⊗ 1878 044 631	362 10 MFZ362 362GTZ	Je nach Kundenwunsch mit unterschiedlicher Kupplung / Equipped with different clutch according to customer requirement	(35)
			 3182 005 231	HHISZ-3	Füllmedium: Bremsflüssigkeit / Fill Medium: Brake Fluid Immer erneuern / Renew everytime	(25) (30)
			 3400 710 001 ⊗ 3482 120 031 ⊗ 1878 044 631 ⊙ 3182 005 231	362 10 MFZ362 362GTZ HHISZ-3		

LION S CITY		03.96 -				
A 22	10.09 -	D2066LUH46	 3400 700 380 ⊗ 3482 000 361 ⊗ 1878 080 037 ⊙ 3151 000 034	430 10 MFZ430 430WGTZ KZISZ-5	Getr. / GBox: ZF 6S-1901	
			3400 700 381 ⊗ 3482 000 361 ⊗ 1878 080 037 ⊙ 3151 000 493	430 10 MFZ430 430WGTZ KZISZ-5	Getr. / GBox: ZF AS-Tronic für Ausrückgabel mit Rollen / for release fork with rollers	(71)
			 3189 600 004		Getr. / GBox: ZF Ecosplit-3 Getr. / GBox: ZF AS Tronic Rollenausführung / roller version	(58)
			3189 600 020		Getr. / GBox: ZF Ecosplit-3	

		CODE				
---	--	------	--	---	---	---

MAN













LION S CITY		03.96 -				
A 35	10.09-	D0836LOH60,		3400 700 362	430 10	
A 35	10.09-	D0836LOH61		 3482 083 032	MFZ430	
A35				 1878 080 033	430WGTZ	
A 66	02.09-			 3151 000 034	KZISZ-5	
A 66	02.09-			3189 600 020		Getr. / GBox: ZF Ecosplit-3

LION S COACH		09.95 -				
FRH 352,RH 353	09.95-	D2866LOH26		3400 700 362	430 10	Getr. / GBox: ZF S8-180
A13				 3482 083 032	MFZ430	
				 1878 080 033	430WGTZ	
				 3151 000 034	KZISZ-5	
				3189 600 020		Getr. / GBox: ZF Ecosplit-3
FRH 402,RH 403	09.95-	D2866LOH23		3400 122 301	430 10	Getr. / GBox: ZF S8-180
A13				 3482 083 032	MFZ430	
				 1878 080 034	430WGTZ	
				 3151 000 034	KZISZ-5	
				3189 600 020		Getr. / GBox: ZF Ecosplit-3
RH 352	05.96-	D2866LOH		3400 122 301	430 10	Getr. / GBox: ZF 8S-180
A13				 3482 083 032	MFZ430	Länderausführung: Türkei / Country-spec. model: (43)
RH 422	05.96-			 1878 080 034	430WGTZ	Turkey
A13				 3151 000 034	KZISZ-5	
				3189 600 020		Getr. / GBox: ZF Ecosplit-3
RH 402	05.96-	D2866LOH,		3400 122 301	430 10	Getr. / GBox: ZF 8S-180
A13		Euro2/3		 3482 083 032	MFZ430	Länderausführung: Türkei / Country-spec. model: (43)
				 1878 080 034	430WGTZ	Turkey
				 3151 000 034	KZISZ-5	
				3189 600 020		Getr. / GBox: ZF Ecosplit-3
RH 403	09.98-	D2866LOH23		3400 122 301	430 10	Getr. / GBox: ZF 8S-180
A32				 3482 083 032	MFZ430	A32 (43)
				 1878 080 034	430WGTZ	Länderausführung: Türkei / Country-spec. model: Turkey
				 3151 000 034	KZISZ-5	
				3189 600 020		Getr. / GBox: ZF Ecosplit-3
RH 463, RHC 464	01.00-	D2876LOH		3400 122 301	430 10	Getr. / GBox: ZF 8S-180
R08 A32				 3482 083 032	MFZ430	A32 (43)
				 1878 080 034	430WGTZ	Länderausführung: Türkei / Country-spec. model: Turkey
				 3151 000 034	KZISZ-5	
		D2876LOH3		3482 083 032	430	Getr. / GBox: ZF 8S-180
					MFZ430	R07,R08
				1878 080 037	430 10	Getr. / GBox: ZF 8S-180
					430WGTZ	R07,R08
				3151 000 034	430 10	Getr. / GBox: ZF 8S-180
					KZISZ-5	R07,R08
				3400 700 511 	430 10	XTend
						Getr. / GBox: ZF 8S-180
						R07,R08
						Nabenprofil / Hub Profile: 41,1x50,8-10N (48)
						Nur zusammen verbauen / Only install together (53)
				3400 700 505 	430 10	XTend
						Getr. / GBox: ZF 8S-180
						R07,R08
						Nabenprofil / Hub Profile: 41,1x50,8-10N (48)
						Nur zusammen verbauen / Only install together (53)
				6594 000 124	430	Getr. / GBox: ZF 8S-180
					430Z	R07,R08
						enthält Schwungradbefestigungsschrauben / includes bolt for flywheel mounting (66)
				3400 700 404	430 10	Getr. / GBox: AS-Tronic
				 3482 000 246	MFZ430	R07,R08
				 1878 002 139	430WGTZ	für Ausrückgabel mit Nocken / for release fork with cams (70)
				 3151 000 144	KZISZ-5	
				3400 700 445	430 10	Getr. / GBox: AS-Tronic
				 3482 000 246	MFZ430	R07,R08
				 1878 002 139	430WGTZ	für Ausrückgabel mit Rollen / for release fork with rollers (71)
				 3151 000 493	KZISZ-5	
				3400 700 459 HD	430 10	Getr. / GBox: AS-Tronic
				 3482 000 246	MFZ430	R07,R08
				 1878 004 104	430WGTZ	für Ausrückgabel mit Rollen / for release fork with rollers (71)
				 3151 000 493	KZISZ-5	
		D2876LOH01,		3189 600 020		Getr. / GBox: ZF Ecosplit-3
		D2876LOH03,		3189 600 004		Getr. / GBox: ZF AS Tronic
		D2876LOH02				Rollenausführung / roller version (58)



























		CODE				
---	--	------	--	---	---	---

MAN

LION S COACH 09.95 -

RHC 414 R07	06.02 -	D2866LOH34	 3400 122 301  3482 083 032  1878 080 034  3151 000 034	430 10 MFZ430 430WGTZ KZISZ-5	Getr. / GBox: ZF 8S-180 R07,R08	
			 3400 700 512 	430 10	XTend Getr. / GBox: ZF 8S-180 R07,R08 Nabenprofil / Hub Profile: 41,1x50,8-10N Nur zusammen verbauen / Only install together	(48) (53)
			 3400 700 507 	430 10	XTend Getr. / GBox: ZF 8S-180 R07,R08 Nabenprofil / Hub Profile: 41,1x50,8-10N Nur zusammen verbauen / Only install together	(48) (53)
			 6594 000 124	430 430Z	Getr. / GBox: ZF 8S-180 R07,R08 enthält Schwungradbefestigungsschrauben / includes bolt for flywheel mounting	(66)
			 3482 000 361	430 MFZ430	Getr. / GBox: AS-Tronic R07,R08	
			 1878 080 034	430 10 430WGTZ	Getr. / GBox: AS-Tronic R07,R08	
			 3151 000 144	KZISZ-5	Getr. / GBox: AS-Tronic R07,R08 für Ausrückgabel mit Nocken / for release fork with cams	(70)
			 3189 600 020		Getr. / GBox: ZF Ecosplit-3	























LION S STAR 03.91 -

FRH 322 A03		D2865, 2866LOH	 3482 062 035	430 GMFZ430	01.1991-> Getr. / GBox: ZF6S-85	
			 1878 061 841	430 10 430WGTZ	01.1991-> Getr. / GBox: ZF6S-85	
			 3151 000 034	KZISZ-5	01.1991-> Getr. / GBox: ZF6S-85	
			 3482 083 032	430 MFZ430	01.1991-> Getr. / GBox: ZF8S-180	
			 1878 085 641	430 10 430GTZ	01.1991-> Getr. / GBox: ZF6S-180	
			 3151 000 034	KZISZ-5	01.1991-> Getr. / GBox: ZF8S-180	
		D2876LOH	 6594 000 124	430 430Z	Getr. / GBox: 8 S 180 + Int. für OE-Nummer / for OE number 51.02301.6044 enthält Schwungradbefestigungsschrauben / includes bolt for flywheel mounting	(83) (66)
 3189 600 020		Getr. / GBox: ZF Ecosplit-3				
FRH 352,RH 353 A03	09.95 -	D2866LOH26	 3400 122 301  3482 083 032  1878 080 034  3151 000 034	430 10 MFZ430 430WGTZ KZISZ-5	Getr. / GBox: ZF 8S-180	
			 3482 083 032	430 MFZ430	Getr. / GBox: ZF 8S-180 Getr. / GBox: ZF 6S-85	
			 1878 080 031	430 10 430WGTZ	Getr. / GBox: ZF 6S-85	
			 3151 000 034	KZISZ-5	Getr. / GBox: ZF 8S-180 Getr. / GBox: ZF 6S-85	
			 3189 600 020		Getr. / GBox: ZF Ecosplit-3	
FRH 402 A03	04.91 - 09.92	D2865LOH, D2866LOH, D2876LOH01	 3400 122 301  3482 083 032  1878 080 034  3151 000 034	430 10 MFZ430 430WGTZ KZISZ-5	Getr. / GBox: ZF 8S-180	
			 3189 600 020		Getr. / GBox: ZF Ecosplit-3	
FRH 402,RH 403 A03	09.95 -	D2866LOH23	 3400 122 301  3482 083 032  1878 080 034  3151 000 034	430 10 MFZ430 430WGTZ KZISZ-5	Getr. / GBox: ZF 8S-180	
			 3189 600 020		Getr. / GBox: ZF Ecosplit-3	













		CODE				
---	--	------	--	---	---	---

MAN

LION S STAR 03.91 -

FRH 422 A03	01.93 - 09.96	D2865, 2866LOH		3482 083 032	430 MFZ430	Getr. / GBox: ZF8S-180	
				1878 085 641	430 10 430GTZ	Getr. / GBox: ZF8S-180	
				3151 000 034	KZISZ-5	Getr. / GBox: ZF8S-180	
				3482 062 035	430 GMFZ430	Getr. / GBox: ZF6S-85	
				1878 061 841	430 10 430WGTZ	Getr. / GBox: ZF6S-85	
				3151 000 034	KZISZ-5	Getr. / GBox: ZF6S-85	
		D2876LOH		6594 000 124	430 430Z	Getr. / GBox: 8 S 180 + Int. für OE-Nummer / for OE number 51.02301.6044 enthält Schwungradbefestigungsschrauben / includes bolt for flywheel mounting	(83) (66)
D2866LOH20		3189 600 020		Getr. / GBox: ZF Ecosplit-3			
FRH 462 A03	04.91 -	D2865LOH, D2866LOH, D2876LOH01		3400 122 301	430 10 MFZ430 430WGTZ	Getr. / GBox: ZF 8S-180	
				3482 083 032 1878 080 034 3151 000 034	KZISZ-5	Getr. / GBox: ZF Ecosplit-3	
				3189 600 020		Getr. / GBox: ZF Ecosplit-3	
RH 414, RHS 414 R03 RH 464, RHS 464 R03	01.02 -	D2876LOH03, D2866LOH34		3400 700 404	430 10 MFZ430	Getr. / GBox: AS-Tronic R03	
	01.02 -			3482 000 246 1878 002 139 3151 000 144	430WGTZ KZISZ-5	für Ausrückgabel mit Nocken / for release fork with cams	(70)
				3400 700 445	430 10 MFZ430	Getr. / GBox: AS-Tronic R03	
				3482 000 246 1878 002 139 3151 000 493	430WGTZ KZISZ-5	für Ausrückgabel mit Rollen / for release fork with rollers	(71)
				3400 700 459 HD	430 10 MFZ430	Getr. / GBox: AS-Tronic R03	
				3482 000 246 1878 004 104 3151 000 493	430WGTZ KZISZ-5	für Ausrückgabel mit Rollen / for release fork with rollers	(71)
				3189 600 004		Getr. / GBox: ZF AS Tronic Rollenausführung / roller version	(58)
RH 464, RHS 464 R02	03.00 -	D2876LOH03		6594 000 124	430 430Z	Getr. / GBox: ZF 8S-180 Getr. / GBox: ZF AS-Tronic enthält Schwungradbefestigungsschrauben / includes bolt for flywheel mounting	(66)
				3482 083 032	430 MFZ430	Getr. / GBox: ZF 8S-180 Getr. / GBox: ZF AS-Tronic	
				1878 085 641	430 10 430GTZ	Getr. / GBox: ZF 8S-180 Getr. / GBox: ZF AS-Tronic	
				3151 000 157	KZISZ-5	Getr. / GBox: ZF 8S-180 Getr. / GBox: ZF AS-Tronic	

















N 03.02 -

N 4516 Centro-E 486	03.02 -	D2866LUH23		3482 083 032	430 MFZ430	Getr. / GBox: ZF S6-85	
				1878 080 031	430 10 430WGTZ	Getr. / GBox: ZF S6-85	
				3151 000 034	KZISZ-5	Getr. / GBox: ZF S6-85	
				3400 700 510 	430 10	XTend Getr. / GBox: ZF S6-85 Nabenprofil / Hub Profile: 38,2x44,5-10N Nur zusammen verbauen / Only install together	(48) (53)
				3189 600 020		Getr. / GBox: ZF Ecosplit-3	
N 4516 Centro-E 486	03.02 -	D2866LUH24		3482 083 032	430 MFZ430	Getr. / GBox: ZF S6-85	
				1878 080 031	430 10 430WGTZ	Getr. / GBox: ZF S6-85	
				3151 000 034	KZISZ-5	Getr. / GBox: ZF S6-85	
				3400 700 510 	430 10	XTend Getr. / GBox: ZF S6-85 Nabenprofil / Hub Profile: 38,2x44,5-10N Nur zusammen verbauen / Only install together	(48) (53)
				3189 600 020		Getr. / GBox: ZF Ecosplit-3	









		CODE				
---	--	------	--	---	---	---

MAN





NL 09.88 -

NL 202, NL 222, NL 223 A21 A10	08.92 -	D0836LUH02		3482 083 032	430 MFZ430	Getr. / GBox: S 6-85 für OE-Nummer / for OE number 81.30305.0193 A20, A21	(83)
				1878 080 031	430 10 430WGTZ	Getr. / GBox: S 6-85 für OE-Nummer / for OE number 81.30301.0497 A20, A21	(83)
				3151 000 034	KZISZ-5	Getr. / GBox: S 6-85 für OE-Nummer / for OE number 81.30550.0094 A20, A21	(83)
		D0826LUH03, D0826LUH12		3189 600 020		Getr. / GBox: ZF Ecosplit-3	
NL 202, NL 262, NL 263 A21 A10	04.91 -	D0836LUH02		3482 083 032	430 MFZ430	Getr. / GBox: S 6-85 für OE-Nummer / for OE number 81.30305.0193 A20, A21	(83)
				1878 080 031	430 10 430WGTZ	Getr. / GBox: S 6-85 für OE-Nummer / for OE number 81.30301.0497 A20, A21	(83)
				3151 000 034	KZISZ-5	Getr. / GBox: S 6-85 für OE-Nummer / for OE number 81.30550.0094 A20, A21	(83)
		D2866LUH23		3482 062 035	430 GMFZ430	Getr. / GBox: S 6-85 für OE-Nummer / for OE number 81.30305.0189 A20, A21	(83)
D0826LUH		3189 600 020		Getr. / GBox: ZF Ecosplit-3			
NL 223 A21	01.96 -	D2865LUH		3482 083 032	430 MFZ430		
NL 263 A21	01.96 -			1878 080 031	430 10 430WGTZ		
NL 313 A21	01.96 -			3151 000 034	KZISZ-5		
				3189 600 020		Getr. / GBox: ZF Ecosplit-3	
NL 262, NL 263 A10 A21 NL 313 A22 A21	07.98 - 07.98 -	D2866LUH23		3482 062 035	430 GMFZ430	Getr. / GBox: S 6-85 für OE-Nummer / for OE number 81.30305.0189 A20, A21	(83)
				1878 080 031	430 10 430WGTZ	Getr. / GBox: S 6-85 für OE-Nummer / for OE number 81.30301.0497 A20, A21	(83)
				3151 000 034	KZISZ-5	Getr. / GBox: S 6-85 für OE-Nummer / for OE number 81.30550.0094 A20, A21	(83)
		D2866LUH26, D2866LUH22		3189 600 020		Getr. / GBox: ZF Ecosplit-3	

NM 08.87 -































NM 152 469 NM 182, NM 192 469 NM 223 469	05.90 - 10.93	D0826LOH01, D0826LOH15, D0826OH02		3482 060 132	350 MF350		
	05.90 - 03.97			1878 000 841 #	350 10 350WGTZ		
	08.87 -			3151 199 001	KZIS-3		
NM 222, NM 223 A53	02.96 -	D0826LUH12, D0826LOH15		3482 060 132	350 MF350	Getr. / GBox: ZF S6-36/6S-890	
				1878 000 841 #	350 10 350WGTZ	Getr. / GBox: ZF S6-36/6S-890	
				3151 199 001	KZIS-3	Getr. / GBox: ZF S6-36/6S-890	
				3482 060 132	350 MF350	Getr. / GBox: Eaton 4106	
				1878 001 145	350 10 350WGTZ	Getr. / GBox: Eaton 4106	
				3151 199 001	KZIS-3	Getr. / GBox: Eaton 4106	

NÜ 03.96 -

NÜ 223 A20	09.96 -	D0826LUH12		3482 086 132	400 MFZ400X		
				1878 000 650	400 10 400WGVZ		
				3151 000 034	KZISZ-5		
				3189 600 020		Getr. / GBox: ZF Ecosplit-3	











		CODE				
---	--	------	--	---	---	---







MAN









NÜ		03.96 -					
NÜ 263 A20	07.98 -	D0826LUH13	 3482 086 132	400 MFZ400X	A20		
			 1878 000 650	400 10 400WGVZ	A20		
			 3151 000 034	KZISZ-5	A20		
			 3189 600 020		Getr. / GBox: ZF Ecosplit-3		
NÜ 263 A20	09.96 - 07.98	D2865LUH09	 3482 086 132	400 MFZ400X	A20		
			 1878 000 650	400 10 400WGVZ	A20		
			 3151 000 034	KZISZ-5	A20		
			 3189 600 020		Getr. / GBox: ZF Ecosplit-3		
NÜ 263	07.98 -	D2866LUH22	 3482 083 032	430 MFZ430	A20		
			 1878 080 031	430 10 430WGTZ	A20		
			 3151 000 034	KZISZ-5	A20		
			 3400 700 510 	430 10	XTend A20 Nabenprofil / Hub Profile: 38,2x44,5-10N Nur zusammen verbauen / Only install together	(48) (53)	
			 3189 600 020		Getr. / GBox: ZF Ecosplit-3		
NÜ 313 A20	07.98 -	D2866LUH26	 3482 083 032	430 MFZ430	A20		
			 1878 080 031	430 10 430WGTZ	A20		
			 3151 000 034	KZISZ-5	A20		
			 3400 700 510 	430 10	XTend A20 Nabenprofil / Hub Profile: 38,2x44,5-10N Nur zusammen verbauen / Only install together	(48) (53)	
			 3189 600 020		Getr. / GBox: ZF Ecosplit-3		
NÜ 313 15M A25	07.98 -	D2866LUH26	 3482 083 032	430 MFZ430			
			 1878 080 031	430 10 430WGTZ			
			 3151 000 034	KZISZ-5			
			 3400 700 510 	430 10	XTend Nabenprofil / Hub Profile: 38,2x44,5-10N Nur zusammen verbauen / Only install together	(48) (53)	
			 3189 600 020		Getr. / GBox: ZF Ecosplit-3		
NÜ 353 15M A25	07.98 -	D2866LUH21	 3400 700 362	430 10			
			 3482 083 032	MFZ430			
			 1878 080 033	430WGTZ			
			 3151 000 034	KZISZ-5			
			 3189 600 020		Getr. / GBox: ZF Ecosplit-3		

		CODE				
---	--	------	--	---	---	---

MAN

































R 05.85 - 01.93						
R 292, FR 292, FRH 292 882 880	05.85 - 01.93	D2866TUH/290, D2866TOH/310	 1882 342 134	420 GF420X	880	
			 1878 003 657	420 10 420WGTZ	880	
			 3151 000 395	KZIS-4	880	
			 3482 124 549	430 GMF430	882	
			 1878 086 741	420 10 430WGTZ	882	
			 3151 000 395	KZIS-4	882	
			 1882 342 134	420 GF420X	882 je nach Ausführung, mit unterschiedlicher Kupplung / depending on version, with different clutch	(85)
			 1878 003 657	420 10 420WGTZ	882 je nach Ausführung, mit unterschiedlicher Kupplung / depending on version, with different clutch	(85)
FRH 362 882	05.85 - 12.92	D2866KUH/360	 1882 342 134	420 GF420X		
			 1878 003 657	420 10 420WGTZ		
			 3151 000 395	KZIS-4		

SG 09.72 -						
SG 220 297		D2556	 3482 124 541	430 GMF430		
			 3482 006 036 ●#	420 GTF420		
			 1882 330 032 ●#	420 GF420		
			 1878 001 154 #	420 10 420WGTZ		
			 3151 000 395	KZIS-4	mit Dauerschmierung / with constant lubrication	(89)
			 3151 000 515	KZIS-4	mit Schmierrohranschluss / with lubrication pipe connection	(91)

SL 06.72 - 04.87						
SL 200		D2555	 1882 302 131	380 GF380	192	
			 1878 001 152	380 10 380WGTZ	192	
			 3151 000 395	KZIS-4	192 mit Dauerschmierung / with constant lubrication	(89)
			 3151 000 515	KZIS-4	192 mit Schmierrohranschluss / with lubrication pipe connection	(91)
			 3482 124 534	430 GMF430	192	
		D2556	 1882 301 239 ●	420 GF420	192	
			 1878 001 154 #	420 10 420WGTZ	192	
			 3151 000 395	KZIS-4	192 mit Dauerschmierung / with constant lubrication	(89)
			 3151 000 515	KZIS-4	192 mit Schmierrohranschluss / with lubrication pipe connection	(91)

		CODE				
---	--	------	--	---	---	---





















MAN

SL II		04.84 - 05.96				
SL 202 791	06.84 - 04.93	D2566UH, D2866UH/240	 3482 124 550	430 GMF430	->06.1991 791	
SL 202 791	06.84 - 04.94		 3482 006 036 ●#	420 GTF420	->06.1991 791	
			 1878 001 154 #	420 10 420WGTZ	->06.1991 791	
			 3151 000 395	KZIS-4	->06.1991 791	
			 3482 124 550	430 GMF430	Sonderausführung / Special design	(60)
			 3482 006 036 ●#	420 GTF420	Sonderausführung / Special design	(60)
			 1878 002 706	420 10 420GTZ	Sonderausführung / Special design	(60)
			 3482 085 034	420 MF420	07.1991-> 791	
			 1878 001 154 #	420 10 420WGTZ	07.1991-> 791	
			 3151 000 395	KZIS-4	07.1991-> 791	
SM		08.87 -				
SM 152 469	11.87 - 04.94	D0826LOH01, D0826OH02	 3482 060 132	350 MF350		
SM 182,SM 192 469	11.87 - 02.95		 1878 000 841 #	350 10 350WGTZ		
			 3151 199 001	KZIS-3		
SR		02.75 - 08.94				
SR 240 596 595 197 289	10.75 - 06.83	D2566MUH/240	 3482 124 534	430 GMF430	Länderausführung: Türkei / Country-spec. model: Turkey	(43)
			 1882 301 239 ●	420 GF420	Länderausführung: Türkei / Country-spec. model: Turkey	(43)
			 1878 001 154 #	420 10 420WGTZ	Länderausführung: Türkei / Country-spec. model: Turkey	(43)
			 3151 000 515	KZIS-4	Länderausführung: Türkei / Country-spec. model: Turkey	(43)
			 3482 124 550	430 GMF430	197	
			 3482 006 036 ●#	420 GTF420	197	
			 1878 001 154 #	420 10 420WGTZ	197	
			 3151 000 395	KZIS-4	197 mit Dauerschmierung / with constant lubrication	(89)
			 3151 000 515	KZIS-4	197 mit Schmierrohranschluss / with lubrication pipe connection	(91)
SR 280,SR 280 H 595 288 289 596	01.77 - 11.86	D2566MTUH	 3482 124 550	430 GMF430	197	
			 3482 006 036 ●#	420 GTF420	197	
			 1878 003 657	420 10 420WGTZ	197	
			 3151 000 515	KZIS-4	197	
			 3482 124 550	430 GMF430	288	
			 3482 006 036 ●#	420 GTF420	288	
			 1878 003 657	420 10 420WGTZ	288	
			 3151 000 515	KZIS-4	288	
SR 281 SR 321 H 288	03.82 - 11.86	D2566MKUH/320	 1882 342 134	420 GF420X		
			 1861 911 232	420 10 420WGVZ		
			 3151 000 395	KZIS-4		











		CODE				
---	--	------	--	---	---	---

MAN

SR 02.75 - 08.94



































SR 292 880 882	-07.90	D2866TUH	 1882 342 134	420 GF420X		
			 1878 002 706	420 10 420GTZ		
			 3151 000 395	KZIS-4		
SR 292 880 882	08.90 -	D2866TUH	 3482 124 549	430 GMF430		
			 1882 342 135 ●#	420 GF420X	Nur bei Altteil-Rückgabe lieferbar (Reparatur; Werk Bielefeld) / Please return old unit for repair (plant Bielefeld)	(51)
			 1878 086 741	420 10 430WGTZ		
			 3151 000 395	KZIS-4		
SR 332 H 882	-07.90	D2866LUH	 1882 342 134	420 GF420X		
			 1878 002 706	420 10 420GTZ		
			 3151 000 395	KZIS-4		
SR 332 H 882	08.90 -	D2866LUH	 3482 124 549	430 GMF430		
			 1882 342 135 ●#	420 GF420X	Nur bei Altteil-Rückgabe lieferbar (Reparatur; Werk Bielefeld) / Please return old unit for repair (plant Bielefeld)	(51)
			 1878 086 741	420 10 430WGTZ		
			 3151 000 395	KZIS-4		
SR 361 SR 362 H 882	08.90 -	D2866KUH	 3482 124 549	430 GMF430		
			 1882 342 135 ●#	420 GF420X	Nur bei Altteil-Rückgabe lieferbar (Reparatur; Werk Bielefeld) / Please return old unit for repair (plant Bielefeld)	(51)
			 1878 086 741	420 10 430WGTZ		
			 3151 000 395	KZIS-4		
SR 362 H 882	-07.90	D2866KUH	 1882 342 134	420 GF420X		
			 1878 002 706	420 10 420GTZ		
			 3151 000 395	KZIS-4		

SÜ 10.75 -

SÜ 18.223 (Türkei) A72	05.99 -	D2866LUH26	 3400 700 362	430 10 MFZ430		
			 3482 083 032	430WGTZ		
SÜ 18.253 (Türkei) A72	05.99 -	D0826LOH	 1878 080 033	KZISZ-5		
			 3151 000 034			
SÜ 18.263 (Türkei) A72	05.99 -	D0826LOH	 3482 086 132	400 MFZ400X		
			 1878 000 650	400 10 400WGVZ		
SÜ 18.313 (Türkei) A72	05.99 -	D2866LUH26, D0826LOH	 3151 000 034	KZISZ-5		
			 3189 600 020		Getr. / GBox: ZF Ecosplit-3	
SÜ 210			 1878 634 039 ▲	420 10 420WGTZ		
			 1863 009 100	GR-5	mit Anlauftring / with thrust ring	(88)

		CODE				
---	--	------	--	---	---	---

























MAN

SÜ		10.75 -				
SÜ 224 193		D2555	 1882 302 131	380 GF380		
			 1878 001 152	380 10 380WGTZ		
			 3151 000 395	KZIS-4	mit Dauerschmierung / with constant lubrication	(89)
			 3151 000 515	KZIS-4	mit Schmierrohranschluss / with lubrication pipe connection	(91)
			 3482 124 541	430 GMF430		
		D2556	 3482 006 036 ●#	420 GTF420		
			 1882 330 032 ●#	420 GF420		
			 1878 001 154 #	420 10 420WGTZ		
			 3151 000 395	KZIS-4	mit Dauerschmierung / with constant lubrication	(89)
			 3151 000 515	KZIS-4	mit Schmierrohranschluss / with lubrication pipe connection	(91)
SÜ 230 SÜ 240	01.72 -	D2556	 3482 124 541	430 GMF430		
			 3482 006 036 ●#	420 GTF420		
			 1882 330 032 ●#	420 GF420		
			 1878 001 154 #	420 10 420WGTZ		
			 3151 000 395	KZIS-4	mit Dauerschmierung / with constant lubrication	(89)
SÜ 240 789 193 SÜ 240 789 193	05.80 - 09.89	D2566	 3482 124 550	430 GMF430	789	
			 3482 006 036 #	420 GTF420	789	
			 1878 001 154 #	420 10 420WGTZ	789	
			 3151 000 515	KZIS-4	789 mit Schmierrohranschluss / with lubrication pipe connection	(91)
			 3151 000 395	KZIS-4	789 mit Dauerschmierung / with constant lubrication	(89)
	D2566MUH	 3482 124 541	430 GMF430	193		
		 1882 330 032 ●#	420 GF420	193		
		 1878 001 154 #	420 10 420WGTZ	193		
		 3151 000 395	KZIS-4	193		
		SÜ 240 789 SÜ 240 789	01.86 - 09.89	D2866TOH/290, D2866UH/240	 3482 006 036 #	420 GTF420
01.86 - 09.89	 1878 003 657		420 10 420WGTZ			
	 3151 000 395		KZIS-4			
SÜ 240 789	11.82 - 01.86	D2566	 3482 006 036 #	420 GTF420	789	
			 3482 124 550	430 GMF430	789	
			 1878 001 154 #	420 10 420WGTZ	789	
			 3151 000 395	KZIS-4	789 mit Dauerschmierung / with constant lubrication	(89)
			 3151 000 515	KZIS-4	789 mit Schmierrohranschluss / with lubrication pipe connection	(91)
SÜ 242 888	01.87 - 04.93	D2866UH/240	 3482 085 034	420 MF420		
			 1878 001 154 #	420 10 420WGTZ		
			 3151 000 395	KZIS-4		











		CODE				
---	--	------	--	---	---	---

MAN

SÜ 10.75 -

































SÜ 242 888	01.87 -	D2866TUH	 1882 342 134	420 GF420X		
			 1878 002 706	420 10 420GTZ		
			 3151 000 395	KZIS-4		
SÜ 272 888	04.93 - 05.95	D2865LUH02	 3482 085 034	420 MF420		
			 1878 001 154 #	420 10 420WGTZ		
			 3151 000 395	KZIS-4		
			 3482 006 036 #	420 GTF420	je nach Ausführung, mit unterschiedlicher Kupplung / depending on version, with different clutch	(85)
			 1878 001 154 #	420 10 420WGTZ	je nach Ausführung, mit unterschiedlicher Kupplung / depending on version, with different clutch	(85)
			 3151 000 395	KZIS-4	je nach Ausführung, mit unterschiedlicher Kupplung / depending on version, with different clutch	(85)
			 3482 083 032	430 MFZ430	Leistung [kW] / Engine Output [kW]: 191	(40)
			 1878 080 031	430 10 430WGTZ	Leistung [kW] / Engine Output [kW]: 191	(40)
			 3151 000 034	KZISZ-5	Leistung [kW] / Engine Output [kW]: 191	(40)
			 3189 600 020		Getr. / GBox: ZF Ecosplit-3	
SÜ 280 789	01.82 - 12.92	D2566	 3482 124 550	430 GMF430		
			 3482 006 036 ●#	420 GTF420		
			 1878 002 706	420 10 420GTZ		
			 3151 000 395	KZIS-4	mit Dauerschmierung / with constant lubrication	(89)
			 3151 000 515	KZIS-4	mit Schmierrohranschluss / with lubrication pipe connection	(91)
SÜ 292 888 SÜ 322 888	04.92 - 04.93	D2866TOH/310, D2865LUH08	 1882 342 135 #	420 GF420X	Getr. / GBox: ZF S6-90 Nur bei Alteil-Rückgabe lieferbar (Reparatur; Werk Bielefeld) / Please return old unit for repair (plant Bielefeld)	(51)
	05.95 - 06.97		 1878 065 131 #	420 10 420WGTZ	Getr. / GBox: ZF S6-90	
			 3151 000 395	KZIS-4	Getr. / GBox: ZF S6-90	
			 1882 342 134	420 GF420X		
			 1878 003 657	420 10 420WGTZ		
			 3151 000 395	KZIS-4		

ÜL 09.89 -

ÜL 242 893 ÜL 272 893	- 06.91	D2865LUH	 3482 083 032	430 MFZ430		
			 1878 080 031	430 10 430WGTZ		
			 3151 000 034	KZISZ-5		
			 3189 600 020		Getr. / GBox: ZF Ecosplit-3	
ÜL 242 893	09.89 - 03.93	D2866UH	 3482 124 550	430 GMF430	->06.1991 893	
			 3482 006 036 #	420 GTF420	->06.1991 893	
			 1878 001 154 #	420 10 420WGTZ	->06.1991 893	
			 3151 000 395	KZIS-4	->06.1991 893	
			 3482 085 034	420 MF420	07.1991-> 893	
			 1878 001 154 #	420 10 420WGTZ	07.1991-> 893	
			 3151 000 395	KZIS-4	07.1991-> 893	

		CODE				
---	--	------	--	---	---	---

















MAN

ÜL		09.89 -						
ÜL 272 893	03.93-	D2866LUH	 3482 085 034	420 MF420				
			 1878 001 154 #	420 10 420WGTZ				
			 3151 000 395	KZIS-4				
ÜL 272 893	03.93-	D2865LUH05, D2865LUH02	 3482 083 032	430 MFZ430				
			 1878 080 031	430 10 430WGTZ				
			 3151 000 034	KZISZ-5				
			 3189 600 020		Getr. / GBox: ZF Ecosplit-3			
ÜL 292 893	09.89 - 03.93	D2866TUH	 1882 342 134	420 GF420X	893			
			 1878 003 657	420 10 420WGTZ	893			
			 3151 000 395	KZIS-4	893			
ÜL 312, ÜL 322 893	04.92 - 09.96	D2865LUH	 1882 342 134	420 GF420X	893			
			 1878 003 657	420 10 420WGTZ	893			
			 3151 000 395	KZIS-4	893			
			 3482 083 032	430 MFZ430	893			
			 1878 080 031	430 10 430WGTZ	893			
			 3151 000 034	KZISZ-5	893			
ÜL 313 A01 ÜL 353 A01	09.96 - 06.97 -	D2866LUH	 3482 083 032	430 MFZ430				
			 1878 085 641	430 10 430GTZ				
			 3151 000 034	KZISZ-5				
			 3482 083 032	430 MFZ430	für Fahrzeuge mit Retarder / for vehicles with retarder	(75)		
			 1878 080 031	430 10 430WGTZ	für Fahrzeuge mit Retarder / for vehicles with retarder	(75)		
			 3151 000 034	KZISZ-5	für Fahrzeuge mit Retarder / for vehicles with retarder	(75)		
	D2866LOH28, D2866LUH25			 3482 083 032	430 MFZ430	Getr. / GBox: S 6-1600 für OE-Nummer / for OE number 81.30305.0193 A01, A04	(83)	
				 1878 080 034	430 10 430WGTZ	Getr. / GBox: S 6-1600 für OE-Nummer / for OE number 81.30301.0500 A01, A04	(83)	
				 3151 000 034	KZISZ-5	Getr. / GBox: S 6-1600 für OE-Nummer / for OE number 81.30550.0094 A01, A04	(83)	
	D2866LUH24			 3482 083 032	430 MFZ430	Getr. / GBox: S 6-1600 für OE-Nummer / for OE number 81.30305.0193 A01, A04	(83)	
				 1878 080 033	430 10 430WGTZ	Getr. / GBox: S 6-1600 für OE-Nummer / for OE number 81.30301.0499 A01, A04	(83)	
				 3151 000 034	KZISZ-5	Getr. / GBox: S 6-1600 für OE-Nummer / for OE number 81.30550.0094 A01, A04	(83)	
	D2866LUH30			 3482 083 032	430 MFZ430	Getr. / GBox: 8 S-180 für OE-Nummer / for OE number 81.30305.0193 A04	(83)	
				 1878 080 037	430 10 430WGTZ	Getr. / GBox: 8 S-180 für OE-Nummer / for OE number 81.30301.0503 A04	(83)	
				 3151 000 034	KZISZ-5	Getr. / GBox: 8 S-180 für OE-Nummer / for OE number 81.30550.0094 A04	(83)	
	D2866LUH21, D2866LUH26, D2866LUH20			 3189 600 020		Getr. / GBox: ZF Ecosplit-3		





















		CODE				
---	--	------	--	---	---	---

MAN



10 ...

10.136 HOCL,HOGR 469				3482 060 132	350 MF350	
10.150 HOCL,HOGR 469				1878 000 841 #	350 10 350WGTZ	
10.180 HOCL,HOGR 469				3151 199 001	KZIS-3	
10.150 752		D0826OH		3482 060 132	350 MF350	
				1878 001 145	350 10 350WGTZ	
				3151 199 001	KZIS-3	
10.180 752		D0826TOH		3482 060 132	350 MF350	
				1878 001 145	350 10 350WGTZ	
				3151 199 001	KZIS-3	
10.180	01.87 - 12.92	D0826TOH		3400 125 501  3482 060 132  1878 001 077  3151 199 001	350 10 MF350 350GTZ KZIS-3	
10.190 752		D0826LOH		3482 060 132	350 MF350	
10.220 752				1878 001 145	350 10 350WGTZ	
10.230 752				3151 199 001	KZIS-3	

11 ...











11.150 752		D0826OH		3482 060 132	350 MF350	
				1878 001 145	350 10 350WGTZ	
				3151 199 001	KZIS-3	
11.150	01.93 -	D0826OH		3400 125 501  3482 060 132  1878 001 077  3151 199 001	350 10 MF350 350GTZ KZIS-3	
11.180 752		D0826TOH		3482 060 132	350 MF350	
				1878 001 145	350 10 350WGTZ	
				3151 199 001	KZIS-3	
11.180	01.93 -	D0826TOH		3400 125 501  3482 060 132  1878 001 077  3151 199 001	350 10 MF350 350GTZ KZIS-3	
11.190 11.192 11.230 HOCL/R	01.93 - 01.91 - 12.92 01.93 -	D0826LOHO		3400 125 501  3482 060 132  1878 001 077  3151 199 001	350 10 MF350 350GTZ KZIS-3	
11.192 HOCL,HOGR 469				3482 060 132	350 MF350	
				1878 000 841 #	350 10 350WGTZ	
				3151 199 001	KZIS-3	





12 ...















12.220 HOCL/R-SR A77	02.02 -	D0836LOH		3482 060 132	350 MF350	Getr. / GBox: ZF S6-36 Getr. / GBox: ZF 6S-890
				1878 000 841 #	350 10 350WGTZ	Getr. / GBox: ZF S6-36 Getr. / GBox: ZF 6S-890
				3151 199 001	KZIS-3	Getr. / GBox: ZF S6-36 Getr. / GBox: ZF 6S-890



































		CODE				
---	--	------	--	---	---	---

MAN

13 ...						
13.210 HOCL/R A53 13.230 HOCL/R A53	07.94 - 07.94 -	D0826LUH		3482 060 132	350 MF350	Getr. / GBox: ZFS6-39, 6S-890
				1878 001 145	350 10 350WGTZ	->07.2001 Getr. / GBox: ZFS6-39, 6S-890
				1878 000 841 #	350 10 350WGTZ	08.2001-> Getr. / GBox: ZFS6-39, 6S-890
				3151 199 001	KZIS-3	Getr. / GBox: ZFS6-39, 6S-890
13.220 HOCL/R A53	07.94 -	D0826LOH, D0836LOH		3482 060 132	350 MF350	Getr. / GBox: ZFS6-39, 6S-890
				1878 001 145	350 10 350WGTZ	->07.2001 Getr. / GBox: ZFS6-39, 6S-890
				1878 000 841 #	350 10 350WGTZ	08.2001-> Getr. / GBox: ZFS6-39, 6S-890
				3151 199 001	KZIS-3	Getr. / GBox: ZFS6-39, 6S-890
13.220 HOCL-SKD A52	02.01 -	D0826LOH15		3482 060 132	350 MF350	Getr. / GBox: ZF S6-36, 6S-890
				1878 000 841 #	350 10 350WGTZ	Getr. / GBox: ZF S6-36, 6S-890
				3151 199 001	KZIS-3	Getr. / GBox: ZF S6-36, 6S-890









14 ...						
14.280 HOCL/R A67 A83	04.01 -	D0836LOH		3482 083 032	430 MFZ430	Getr. / GBox: ZF S6-85 A67
				1878 080 031	430 10 430WGTZ	Getr. / GBox: ZF S6-85 A67
				3151 000 034	KZISZ-5	Getr. / GBox: ZF S6-85 A67
		D0836LOH02		3400 700 362 3482 083 032 1878 080 033 3151 000 034	430 10 MFZ430 430WGTZ KZISZ-5	Getr. / GBox: ZF S6-1600 A83
D0836LOH02, D0836LOH		3189 600 020		Getr. / GBox: ZF Ecosplit-3		

























16 ...						
16.240 753		D2866OH		1882 342 134	420 GF420X	
				1878 003 657	420 10 420WGTZ	
				3151 000 395	KZIS-4	
16.240 HOC 471	01.79 - 08.96	D2866OH		1882 302 131	380 GF380	Getr. / GBox: ZF S6-80
				1878 001 152	380 10 380WGTZ	Getr. / GBox: ZF S6-80
				3151 000 395	KZIS-4	Getr. / GBox: ZF S6-80
16.240 HOCL/R 470 16.280 HOCL/R 470	02.79 - 08.96	D2866OH		1882 302 131	380 GF380	
				1878 001 152	380 10 380WGTZ	
	02.79 - 08.96		3151 000 395	KZIS-4		
16.240 HOCL/R 754	04.89 -	D2866OH		3482 124 534	430 GMF430	->06.1995
				1878 003 657	420 10 420WGTZ	->06.1995
				3151 000 395	KZIS-4	->06.1995
				3400 700 310 3482 078 133 1862 364 133 3151 000 034	400 10 MFZ400 400WGVZ KZISZ-5	07.1995-> Nabenprofil / Hub Profile: 1 3/4"-10N
				3189 600 020		Getr. / GBox: ZF Ecosplit-3

























16 ...						
16.280 HOC 471	01.79 - 08.96			1882 302 131	380 GF380	Getr. / GBox: ZF S6-80
				1878 001 152	380 10 380WGTZ	Getr. / GBox: ZF S6-80
				3151 000 395	KZIS-4	Getr. / GBox: ZF S6-80
				3482 124 534	430 GMF430	Getr. / GBox: ZF S6-90
				1878 003 657	420 10 420WGTZ	Getr. / GBox: ZF S6-90
				3151 000 395	KZIS-4	Getr. / GBox: ZF S6-90
16.290 753		D2866TOH		3482 083 032	430 MFZ430	
				1878 080 031	430 10 430WGTZ	
				3151 000 034	KZISZ-5	
				3189 600 020		Getr. / GBox: ZF Ecosplit-3
16.290 HOC 471	01.79 - 08.96	D2866TOH		3482 124 534	430 GMF430	->07.1990
				1882 342 134	420 GF420X	08.1990->
				1878 003 657	420 10 420WGTZ	
				3151 000 395	KZIS-4	
16.290 HOCL/R 470	02.79 - 08.96	D2866TOH		3482 124 534	430 GMF430	->07.1990 Getr. / GBox: S 6-90
				1882 301 239 ●	420 GF420	->07.1990 Getr. / GBox: S 6-90
				1878 003 657	420 10 420WGTZ	->07.1990 Getr. / GBox: S 6-90
				1882 342 134	420 GF420X	08.1990-> Getr. / GBox: S 6-90
				1878 003 657	420 10 420WGTZ	08.1990-> Getr. / GBox: S 6-90
				3151 000 395	KZIS-4	Getr. / GBox: S 6-90
16.290 HOCL/R 754	04.89 -	D2866TOH		3482 124 516	430 GMF430	->06.1995
				1882 342 134 ●	420 GF420X	->06.1995
				1878 003 657	420 10 420WGTZ	->06.1995
				3151 000 395	KZIS-4	->06.1995
				3482 083 032	430 MFZ430	07.1995->
				1878 080 031	430 10 430WGTZ	07.1995->
				3151 000 034	KZISZ-5	07.1995->
				3189 600 020		Getr. / GBox: ZF Ecosplit-3
16.360 HOCL/R 470	02.79 - 08.96	D2866LXOH		1882 342 134	420 GF420X	->07.1990 Getr. / GBox: S6-150
				1861 911 232	420 10 420WGVZ	->07.1990 Getr. / GBox: S6-150
				3151 000 395	KZIS-4	->07.1990 Getr. / GBox: S6-150
				3482 124 549	430 GMF430	08.1990-> Getr. / GBox: S6-150
				1882 342 135 ●#	420 GF420X	08.1990-> Getr. / GBox: S6-150 Nur bei Altteil-Rückgabe lieferbar (Reparatur; Werk Bielefeld) / Please return old unit for repair (plant Bielefeld)
				1878 086 741	420 10 430WGTZ	08.1990-> Getr. / GBox: S6-150
				3151 000 395	KZIS-4	08.1990-> Getr. / GBox: S6-150

		CODE				
---	--	------	--	---	---	---

MAN





























16 ...							
16.370 HOCL/R 754	04.89-	D2866LOH		3482 124 549	430 GMF430		
				1882 342 135 ●#	420 GF420X	Nur bei Altteil-Rückgabe lieferbar (Reparatur; Werk Bielefeld) / Please return old unit for repair (plant Bielefeld)	(51)
				1878 086 741	420 10 430WGTZ		
				3151 000 395	KZIS-4		
16.372 HOCL/R 470	02.79 - 08.96	D2866LOH		3482 124 549	430 GMF430	Getr. / GBox: S6-150	
				1882 342 135 ●#	420 GF420X	Getr. / GBox: S6-150 Nur bei Altteil-Rückgabe lieferbar (Reparatur; Werk Bielefeld) / Please return old unit for repair (plant Bielefeld)	(51)
				1878 086 741	420 10 430WGTZ	Getr. / GBox: S6-150	
				3151 000 395	KZIS-4	Getr. / GBox: S6-150	

18 ...							
18.220 HOCL-SKD 18.230 HOCL-SKD 18.250 HOCL-SKD				3482 086 132	400 MFZ400X		
				1862 364 133	400 10 400WGVZ		
				3151 000 034	KZISZ-5		
				3189 600 020		Getr. / GBox: ZF Ecosplit-3	
18.310 HOCL/R A51 A82	01.92-	D2866LOH		3400 700 362 ⊗ 3482 083 032 ⊗ 1878 080 033 ⊗ 3151 000 034	430 10 MFZ430 430WGTZ KZISZ-5	Getr. / GBox: ZF S6-1600	
				3400 700 506 ●#	430 10	XTend Getr. / GBox: ZF S6-1600 Nabenprofil / Hub Profile: 41,1x50,8-10N Nur zusammen verbauen / Only install together	(48) (53)
				3482 083 032	430 MFZ430	Getr. / GBox: ZF S6-85 Getr. / GBox: ZF S6-1600	
				1878 080 031	430 10 430WGTZ	Getr. / GBox: ZF S6-85	
				3151 000 034	KZISZ-5	Getr. / GBox: ZF S6-85 Getr. / GBox: ZF S6-1600	
		D2876LOH03		3482 083 032	430 MFZ430	Getr. / GBox: G0-210	
				1878 080 037	430 10 430WGTZ	Getr. / GBox: G0-210	
				3151 000 335	KZIZ-5	Getr. / GBox: G0-210	
				3189 600 020		Getr. / GBox: ZF Ecosplit-3	
				3400 700 362 ⊗ 3482 083 032 ⊗ 1878 080 033 ⊗ 3151 000 034	430 10 MFZ430 430WGTZ KZISZ-5	Getr. / GBox: ZF S6-1600	
D2876LOH03, D2866LOH		3400 700 506 ●#	430 10	XTend Getr. / GBox: ZF S6-1600 Nabenprofil / Hub Profile: 41,1x50,8-10N Nur zusammen verbauen / Only install together	(48) (53)		
		3482 083 032	430 MFZ430	Getr. / GBox: ZF S6-85 Getr. / GBox: ZF S6-1600			
		1878 080 031	430 10 430WGTZ	Getr. / GBox: ZF S6-85			
		3151 000 034	KZISZ-5	Getr. / GBox: ZF S6-85 Getr. / GBox: ZF S6-1600			
		3189 600 020		Getr. / GBox: ZF Ecosplit-3			
18.310 HOCL/R-SKD A55	01.95-	D2866LOH		3400 700 362 ⊗ 3482 083 032 ⊗ 1878 080 033 ⊗ 3151 000 034	430 10 MFZ430 430WGTZ KZISZ-5	Getr. / GBox: ZF S6-1600	
				3400 700 506 ●#	430 10	XTend Getr. / GBox: ZF S6-1600 Nabenprofil / Hub Profile: 41,1x50,8-10N Nur zusammen verbauen / Only install together	(48) (53)
				3482 083 032	430 MFZ430	Getr. / GBox: ZF S6-85 Getr. / GBox: ZF S6-1600	
				1878 080 031	430 10 430WGTZ	Getr. / GBox: ZF S6-85	
				3151 000 034	KZISZ-5	Getr. / GBox: ZF S6-85 Getr. / GBox: ZF S6-1600	
D2866LOH25		3189 600 020		Getr. / GBox: ZF Ecosplit-3			

18 ...							
18.313 HOCL/R-SKD A55	01.95-	D2866LOH27		3400 700 506 	430 10	XTend Getr. / GBox: ZF S6-1600 Nabenprofil / Hub Profile: 41,1x50,8-10N Nur zusammen verbauen / Only install together	(48) (53)
				3400 700 362 ⊗ 3482 083 032 ⊗ 1878 080 033 ⊙ 3151 000 034	430 10 MFZ430 430WGTZ KZISZ-5	Getr. / GBox: ZF S6-1600	
				3189 600 020		Getr. / GBox: ZF Ecosplit-3	
							
18.350 HOCL/R A82 A51 18.370 HOCL/R A51	01.92-	D2866LOH		3400 700 506 	430 10	XTend Getr. / GBox: ZF S6-1600 Nabenprofil / Hub Profile: 41,1x50,8-10N Nur zusammen verbauen / Only install together	(48) (53)
				3400 700 362 ⊗ 3482 083 032 ⊗ 1878 080 033 ⊙ 3151 000 034	430 10 MFZ430 430WGTZ KZISZ-5	Getr. / GBox: ZF S6-1600	
	01.92-	D2876LOH03		3482 083 032	430 MFZ430	Getr. / GBox: G0-210	
				1878 080 037	430 10 430WGTZ	Getr. / GBox: G0-210	
				3151 000 335	KZISZ-5	Getr. / GBox: G0-210	
	3189 600 020		Getr. / GBox: ZF Ecosplit-3				
18.350 HOCL/R-SKD A55	01.95-	D2866LOH26		3400 122 301 ⊗ 3482 083 032 ⊗ 1878 080 034 ⊙ 3151 000 034	430 10 MFZ430 430WGTZ KZISZ-5	Getr. / GBox: ZF 8S-180	
				3400 700 507 	430 10	XTend Getr. / GBox: ZF 8S-180 Nabenprofil / Hub Profile: 41,1x50,8-10N Nur zusammen verbauen / Only install together	(48) (53)
				3400 700 362 ⊗ 3482 083 032 ⊗ 1878 080 033 ⊙ 3151 000 034	430 10 MFZ430 430WGTZ KZISZ-5	Getr. / GBox: ZF S6-1600	
				3400 700 506 	430 10	XTend Getr. / GBox: ZF S6-1600 Nabenprofil / Hub Profile: 41,1x50,8-10N Nur zusammen verbauen / Only install together	(48) (53)
				3189 600 020		Getr. / GBox: ZF Ecosplit-3	
18.360 HOCL/R A82	06.02-	D2866LOH28, D2866LOH33		3400 700 362 ⊗ 3482 083 032 ⊗ 1878 080 033 ⊙ 3151 000 034	430 10 MFZ430 430WGTZ KZISZ-5	Getr. / GBox: ZF S6-1600	
				3189 600 020		Getr. / GBox: ZF Ecosplit-3	
18.370 HOCL/R-SKD A55	01.95-	D2866LOH		3400 700 507 	430 10	XTend Getr. / GBox: ZF S6-180 Nabenprofil / Hub Profile: 41,1x50,8-10N Nur zusammen verbauen / Only install together	(48) (53)
				3400 122 301 ⊗ 3482 083 032 ⊗ 1878 080 034 ⊙ 3151 000 034	430 10 MFZ430 430WGTZ KZISZ-5	Getr. / GBox: ZF S6-180	
				3189 600 020		Getr. / GBox: ZF Ecosplit-3	











		CODE				
---	--	------	--	---	---	---













MAN

18 ...							
18.400 HOCL/R A82 A51	01.92-	D2866LOH		3400 700 507 	430 10	XTend Getr. / GBox: ZF 8S-180 Nabenprofil / Hub Profile: 41,1x50,8-10N Nur zusammen verbauen / Only install together (48) (53)	
				3400 122 301 ⊗ 3482 083 032 ⊗ 1878 080 034 ⊙ 3151 000 034	430 10 MFZ430 430WGTZ KZISZ-5	Getr. / GBox: ZF 8S-180	
				3400 700 362 ⊗ 3482 083 032 ⊗ 1878 080 033 ⊙ 3151 000 034	430 10 MFZ430 430WGTZ KZISZ-5	Getr. / GBox: ZF S6-1600	
		D2876LOH03		3482 083 032	430 MFZ430	Getr. / GBox: G0-210	
				1878 080 037	430 10 430WGTZ	Getr. / GBox: G0-210	
				3151 000 335	KZIZ-5	Getr. / GBox: G0-210	
		D2876LOH03, D2866LOH		3189 600 020		Getr. / GBox: ZF Ecosplit-3	
18.400 HOCL/R-SKD A55	01.95-	D2866LOH23		3400 700 507 	430 10	XTend Getr. / GBox: 8S-180 Nabenprofil / Hub Profile: 41,1x50,8-10N Nur zusammen verbauen / Only install together (48) (53)	
				3400 122 301 ⊗ 3482 083 032 ⊗ 1878 080 034 ⊙ 3151 000 034	430 10 MFZ430 430WGTZ KZISZ-5	Getr. / GBox: 8S-180	
				3189 600 020		Getr. / GBox: ZF Ecosplit-3	
		D2876LOH03, D2866LOH		3189 600 020		Getr. / GBox: ZF Ecosplit-3	
18.410 HOCL/R A82	06.02-	D2866LOH34, D2866LOH29		3400 122 301 ⊗ 3482 083 032 ⊗ 1878 080 034 ⊙ 3151 000 034	430 10 MFZ430 430WGTZ KZISZ-5	Getr. / GBox: ZF 8S-180	
				3189 600 020		Getr. / GBox: ZF Ecosplit-3	
18.420 HOCL/R A51	01.92-	D2866LOH		3400 700 507 	430 10	XTend Getr. / GBox: ZF 8S-180 Nabenprofil / Hub Profile: 41,1x50,8-10N Nur zusammen verbauen / Only install together (48) (53)	
				3400 700 512 	430 10	XTend Getr. / GBox: ZF 8S-180 Nabenprofil / Hub Profile: 41,1x50,8-10N Nur zusammen verbauen / Only install together (48) (53)	
				3400 122 301 ⊗ 3482 083 032 ⊗ 1878 080 034 ⊙ 3151 000 034	430 10 MFZ430 430WGTZ KZISZ-5	Getr. / GBox: ZF 8S-180	
		D2876LOH03		3482 083 032	430 MFZ430	Getr. / GBox: G0-210	
				1878 080 037	430 10 430WGTZ	Getr. / GBox: G0-210	
				3151 000 335	KZIZ-5	Getr. / GBox: G0-210	
		D2876LOH03, D2866LOH		3189 600 020		Getr. / GBox: ZF Ecosplit-3	
18.420 HOCL/R-SKD A55	01.95-	D2866LOH20		3400 700 507 	430 10	XTend Getr. / GBox: ZF 8S-180 Nabenprofil / Hub Profile: 41,1x50,8-10N Nur zusammen verbauen / Only install together (48) (53)	
				3400 122 301 ⊗ 3482 083 032 ⊗ 1878 080 034 ⊙ 3151 000 034	430 10 MFZ430 430WGTZ KZISZ-5	Getr. / GBox: ZF 8S-180	
				3189 600 020		Getr. / GBox: ZF Ecosplit-3	
		D2876LOH03, D2866LOH		3189 600 020		Getr. / GBox: ZF Ecosplit-3	











		CODE				
---	--	------	--	---	---	---

MAN

18 ...							
18.460 HOCL/R A51	01.92-	D2876LOH		3482 083 032	430 MFZ430	Getr. / GBox: ZF 8S-180	
				1878 080 037	430 10 430WGTZ	Getr. / GBox: ZF 8S-180	
				3151 000 034	KZISZ-5	Getr. / GBox: ZF 8S-180	
				3400 700 505 	430 10	XTend Getr. / GBox: ZF 8S-180 Nabenprofil / Hub Profile: 41,1x50,8-10N Nur zusammen verbauen / Only install together	(48) (53)
				3400 700 511 	430 10	XTend Getr. / GBox: ZF 8S-180 Nabenprofil / Hub Profile: 41,1x50,8-10N Nur zusammen verbauen / Only install together	(48) (53)
				3482 083 032	430 MFZ430	Getr. / GBox: G0-210	
				1878 080 037	430 10 430WGTZ	Getr. / GBox: G0-210	
				3151 000 335	KZISZ-5	Getr. / GBox: G0-210	
				3189 600 020		Getr. / GBox: ZF Ecosplit-3	

24 ...							
24.350 HOCLN A54	01.97-	D2866LOH26		3400 700 507 	430 10	XTend Getr. / GBox: ZF 8S-180 Nabenprofil / Hub Profile: 41,1x50,8-10N Nur zusammen verbauen / Only install together	(48) (53)
				3400 122 301 3482 083 032 1878 080 034 3151 000 034	430 10 MFZ430 430WGTZ KZISZ-5	Getr. / GBox: ZF 8S-180	
				3189 600 020		Getr. / GBox: ZF Ecosplit-3	
				3400 700 507 	430 10	XTend Getr. / GBox: ZF 8S-180 Nabenprofil / Hub Profile: 41,1x50,8-10N Nur zusammen verbauen / Only install together	(48) (53)
24.400 HOCLN A54	01.97-	D2866LOH23		3400 700 507 	430 10	XTend Getr. / GBox: ZF 8S-180 Nabenprofil / Hub Profile: 41,1x50,8-10N Nur zusammen verbauen / Only install together	(48) (53)
				3400 122 301 3482 083 032 1878 080 034 3151 000 034	430 10 MFZ430 430WGTZ KZISZ-5	Getr. / GBox: ZF 8S-180	
				3189 600 020		Getr. / GBox: ZF Ecosplit-3	
				3400 700 507 	430 10	XTend Getr. / GBox: ZF 8S-180 Nabenprofil / Hub Profile: 41,1x50,8-10N Nur zusammen verbauen / Only install together	(48) (53)













530						
530 HOR				1863 600 125	GR-3	mit Anlauftring / with thrust ring (88)



535						
535				1881 039 532 #	350 G350KR	Länderausführung: Türkei / Country-spec. model: Turkey (43)
				1878 001 144	350 10 350WGTZ	Länderausführung: Türkei / Country-spec. model: Turkey (43)
				1878 001 147 #	350 10 350WGTZ	Länderausführung: Türkei / Country-spec. model: Turkey (43)
				3151 000 395	KZIS-4	Länderausführung: Türkei / Country-spec. model: Turkey (43)
535 HO	-04.72			1881 039 532 #	350 G350KR	
				1878 001 074	350 10 350GTZ	
				1863 600 125	GR-3	mit Anlauftring / with thrust ring (88)
535 HO	05.72-			1881 039 532 #	350 G350KR	
				1878 005 367	350 10 350WGTZ	
				1863 600 125	GR-3	mit Anlauftring / with thrust ring (88)

		CODE				
---	--	------	--	---	---	---









MAN

630						
630				1861 034 147 #	350 10	

750						
750 HO				1861 470 234	380 10 380GSZ	Getr. / GBox: S5-35
750 HO				3482 124 534	430 GMF430	
				1882 301 239 ●	420 GF420	
				1861 206 211 #	420 10 420GS	
				1863 009 100	GR-5	mit Anlauftring / with thrust ring
750 HO,SÜ,R,Ü (Daimler Chrysler Motor) / 750 HO,SÜ,R,Ü (Daimler Chrysler Engine)				3482 124 541	430 GMF430	
				1882 330 032 ●#	420 GF420	
				1878 634 039 ▲	420 10 420WGTZ	
				1863 009 100	GR-5	mit Anlauftring / with thrust ring
750 SL	09.72 -			3482 124 534	430 GMF430	
				1882 301 239 ●	420 GF420	
				1878 634 039 ▲	420 10 420WGTZ	
				1863 009 100	GR-5	mit Anlauftring / with thrust ring
750 SL	-08.72			3482 124 534	430 GMF430	
				1882 301 239 ●	420 GF420	
				1863 009 100	GR-5	mit Anlauftring / with thrust ring
750 SL				3151 000 395	KZIS-4	







890							
890 UG,UO				3482 124 534	430 GMF430		
				1882 301 239 ●	420 GF420		
				1861 206 211 #	420 10 420GS		
				1863 009 100	GR-5	mit Anlauftring / with thrust ring	(88)

MAZ







































Bus						
103-070		DCOM906		3482 083 032	430 MFZ430	Getr. / GBox: ZF 6S-85
				1878 080 031	430 10 430WGTZ	Getr. / GBox: ZF 6S-85
				3151 000 157	KZISZ-5	Getr. / GBox: ZF 6S-85
		DeutzBF6M101 3EC		3482 083 032	430 MFZ430	Getr. / GBox: ZF 6S-85
				1878 080 031	430 10 430WGTZ	Getr. / GBox: ZF 6S-85
				3151 000 157	KZISZ-5	Getr. / GBox: ZF 6S-85
152-050		MAND2866LOH		3482 083 032	430 MFZ430	Getr. / GBox: ZF 6S-1600
				1878 080 031	430 10 430WGTZ	Getr. / GBox: ZF 6S-1600
				3151 000 157	KZISZ-5	Getr. / GBox: ZF 6S-1600

		CODE				
---	--	------	--	---	---	---

MERCEDES-BENZ

100 Bus (631)		02.88 - 04.96				
D	12.90 - 12.94	OM616.963, OM616	 3000 424 002  3082 191 032  1862 375 031  3151 198 031	228 23 M228 228LPB KZIS-0		
D (631.333, 631.343, 631.334, 631.344), 53 kW	02.88 - 05.92		 3074 600 205		->10.1991 Hüllenlänge [mm] / Sleeve Length [mm]: 980 Länge [mm] / Length [mm]: 1450	(29) (45)
D (631.333, 631.343, 631.334, 631.344), 55 kW	12.90 - 02.96		 6283 600 113		Chass. 099541->	
			 6284 600 111			

































SPRINTER 2-t Bus (901, 902) 01.95 - 05.06

214 NGT	04.00 - 05.06	M111.984	 3000 990 218  	240 26	->Chass. A920787 ->Chass. R636764 Nabenprofil / Hub Profile: 26,5x29-26N für Schwungradtiefe [mm] / for flywheel depth [mm]: 8	(48) (84)
			 3000 990 252  	240 26	Nabenprofil / Hub Profile: 26,5x29-26N für Schwungradtiefe [mm] / for flywheel depth [mm]: 12 Nur zusammen verbauen / Only install together	(48) (84) (53)
			 3182 654 192 	HHAS-1	Immer erneuern / Renew everytime	(30)
			 3182 997 802	HHAS-1	Schaltgetriebe sequentiell / Sequential Manual Transmission mit Sensor / with sensor Füllmedium: Mineralöl / Fill Medium: Mineral Oil Immer erneuern / Renew everytime	(59) (92) (26) (30)
214	02.95 - 05.06	M111.979	 3000 826 901  3082 268 031  1878 994 001  3151 248 031	240 26 M240 240TB KZIS-0		
			 1863 869 010	35	Kugellager / Ball Bearing	(38)
			 6283 600 115			
			 6284 600 573			
		M111.984	 3000 990 218  	240 26	->Chass. A920787 ->Chass. R636764 Nabenprofil / Hub Profile: 26,5x29-26N für Schwungradtiefe [mm] / for flywheel depth [mm]: 8	(48) (84)
			 3000 990 252  	240 26	Nabenprofil / Hub Profile: 26,5x29-26N für Schwungradtiefe [mm] / for flywheel depth [mm]: 12 Nur zusammen verbauen / Only install together	(48) (84) (53)
			 3182 654 192 	HHAS-1	Immer erneuern / Renew everytime	(30)
			 3182 997 802	HHAS-1	Schaltgetriebe sequentiell / Sequential Manual Transmission mit Sensor / with sensor Füllmedium: Mineralöl / Fill Medium: Mineral Oil Immer erneuern / Renew everytime	(59) (92) (26) (30)
208 CDI	04.00 - 05.06	OM611.981/987, OM612.981	 2290 601 011  	240 26	ZMS Modul XTend plus CSC Montageart: nicht vormontiert / Mounting Type: not pre-mounted Beinhaltet ZMS, Kupplungsdruckplatte, Kupplungsscheibe und CSC / Contains twin-mass flywheel, clutch cover assembly, clutch disc and CSC enthält Schwungradbefestigungsschrauben / includes bolt for flywheel mounting	(46) (11) (66)
211 CDI	04.00 - 05.06		 3000 990 218  	240 26	->Chass. A920787 ->Chass. R636764 Nabenprofil / Hub Profile: 26,5x29-26N für Schwungradtiefe [mm] / for flywheel depth [mm]: 8	(48) (84)
213 CDI	04.00 - 05.06		 3000 990 252  	240 26	Nabenprofil / Hub Profile: 26,5x29-26N für Schwungradtiefe [mm] / for flywheel depth [mm]: 12 Nur zusammen verbauen / Only install together	(48) (84) (53)
216 CDI	04.00 - 05.06		 3182 997 802	HHAS-1	Schaltgetriebe sequentiell / Sequential Manual Transmission mit Sensor / with sensor Füllmedium: Mineralöl / Fill Medium: Mineral Oil Immer erneuern / Renew everytime	(59) (92) (26) (30)
			 3182 654 192 	HHAS-1	Immer erneuern / Renew everytime	(30)
			 1863 869 012	28	Nadellager / Needle Bearing	(49)
		OM612.981, OM611.981,	 6284 600 573			











		CODE					
---	--	------	--	--	---	---	---

MERCEDES-BENZ

SPRINTER 2-t Bus (901, 902) 01.95 - 05.06



























208 D	02.95 - 04.00	OM601.943	 2290 601 007  2294 000 767  3082 267 233  1864 503 231  3151 248 031	228 26 M228X 228B KZIS-0	ZMS Modul Montageart: nicht vormontiert / Mounting Type: not pre-mounted Beinhaltet ZMS, Kupplungsdruckplatte, Kupplungsscheibe und Ausrücker / Contains twin-mass flywheel, clutch cover assembly, clutch disc and releaser enthält Schwungradbefestigungsschrauben / includes bolt for flywheel mounting	(46) (10) (66)
			 3000 726 001  3082 267 233  1864 503 231  3151 248 031	228 26 M228X 228B KZIS-0		
			 1863 869 010	35	Kugellager / Ball Bearing	(38)
			 6283 600 115			
210 D	03.97 - 04.00	OM602LA	 3000 951 785  3082 269 031  1878 600 501  3151 248 031	250 26 M250 250CD KZIS-0		
			 3000 725 001 ●  3082 269 031  1864 504 031  3151 248 031	250 26 M250 250B KZIS-0		
			 2294 000 525	250	enthält Schwungradbefestigungsschrauben / includes bolt for flywheel mounting	(66)
		OM602.980	 1863 869 010	35	Kugellager / Ball Bearing	(38)
			 6283 600 115			
212 D	02.95 - 04.00	OM602LA	 3000 951 785  3082 269 031  1878 600 501  3151 248 031	250 26 M250 250CD KZIS-0		
			 3000 725 001 ●  3082 269 031  1864 504 031  3151 248 031	250 26 M250 250B KZIS-0		
			 2294 000 525	250	enthält Schwungradbefestigungsschrauben / includes bolt for flywheel mounting	(66)
		OM602.980	 1863 869 010	35	Kugellager / Ball Bearing	(38)

SPRINTER 3-t Bus (903) 01.95 - 05.06

314 NGT	04.00 - 05.06	M111.984	 3000 990 218  	240 26	->Chass. A920787 ->Chass. R636764 Nabenprofil / Hub Profile: 26,5x29-26N für Schwungradtiefe [mm] / for flywheel depth [mm]: 8	(48) (84)
			 3000 990 252  	240 26	Nabenprofil / Hub Profile: 26,5x29-26N für Schwungradtiefe [mm] / for flywheel depth [mm]: 12 Nur zusammen verbauen / Only install together	(48) (84) (53)
			 3182 654 192 	HHAS-1	Immer erneuern / Renew everytime	(30)
			 3182 997 802	HHAS-1	Schaltgetriebe sequentiell / Sequential Manual Transmission mit Sensor / with sensor Füllmedium: Mineralöl / Fill Medium: Mineral Oil Immer erneuern / Renew everytime	(59) (92) (26) (30)
			 6284 600 573			





























		CODE				
---	--	------	--	---	---	---

MERCEDES-BENZ

SPRINTER 3-t Bus (903) 01.95 - 05.06						
314 314 4x4	02.95 - 05.06 08.02 - 05.06	M111.979	 3000 826 901 ⊗ 3082 268 031 ⊗ 1878 994 001 ⊙ 3151 248 031	240 26 M240 240TB KZIS-0		
			 1863 869 010	35	Kugellager / Ball Bearing	(38)
		M111.984	 3000 990 218 	240 26	->Chass. A920787 ->Chass. R636764 Nabenprofil / Hub Profile: 26,5x29-26N für Schwungradtiefe [mm] / for flywheel depth [mm]: 8	(48) (84)
	 3000 990 252 		240 26	Nabenprofil / Hub Profile: 26,5x29-26N für Schwungradtiefe [mm] / for flywheel depth [mm]: 12 Nur zusammen verbauen / Only install together	(48) (84) (53)	
	 3182 654 192 		HHAS-1	Immer erneuern / Renew everytime	(30)	
	 3182 997 802		HHAS-1	Schaltgetriebe sequentiell / Sequential Manual Transmission mit Sensor / with sensor Füllmedium: Mineralöl / Fill Medium: Mineral Oil Immer erneuern / Renew everytime	(59) (92) (26) (30)	
	 6283 600 115					
	 6284 600 573					
308 CDI 311 CDI 311 CDI 4x4 313 CDI 313 CDI 4x4 316 CDI 316 CDI 4x4	04.00 - 05.06 04.00 - 05.06	OM611.981/987, OM612.981	 2290 601 011 	240 26	ZMS Modul XTend plus CSC Montageart: nicht vormontiert / Mounting Type: not pre-mounted Beinhaltet ZMS, Kupplungsdruckplatte, Kupplungsscheibe und CSC / Contains twin-mass flywheel, clutch cover assembly, clutch disc and CSC enthält Schwungradbefestigungsschrauben / includes bolt for flywheel mounting	(46) (11) (66)
			 3000 990 218 	240 26	->Chass. A920787 ->Chass. R636764 Nabenprofil / Hub Profile: 26,5x29-26N für Schwungradtiefe [mm] / for flywheel depth [mm]: 8	(48) (84)
	 3000 990 252 	240 26	Nabenprofil / Hub Profile: 26,5x29-26N für Schwungradtiefe [mm] / for flywheel depth [mm]: 12 Nur zusammen verbauen / Only install together	(48) (84) (53)		
	 3182 997 802	HHAS-1	Schaltgetriebe sequentiell / Sequential Manual Transmission mit Sensor / with sensor Füllmedium: Mineralöl / Fill Medium: Mineral Oil Immer erneuern / Renew everytime	(59) (92) (26) (30)		
	 3182 654 192 	HHAS-1	Immer erneuern / Renew everytime	(30)		
	 1863 869 012		Nadellager / Needle Bearing	(49)		
	 6284 600 573					
		OM611.981, OM612.981, OM611.987				
308 D	02.95 - 04.00	OM601.943	 2290 601 007 ⊗ 2294 000 767 ⊗ 3082 267 233 ⊗ 1864 503 231 ⊙ 3151 248 031	228 26 M228X 228B KZIS-0	ZMS Modul Montageart: nicht vormontiert / Mounting Type: not pre-mounted Beinhaltet ZMS, Kupplungsdruckplatte, Kupplungsscheibe und Ausrücker / Contains twin-mass flywheel, clutch cover assembly, clutch disc and releaser enthält Schwungradbefestigungsschrauben / includes bolt for flywheel mounting	(46) (10) (66)
			 3000 726 001 ⊗ 3082 267 233 ⊗ 1864 503 231 ⊙ 3151 248 031	228 26 M228X 228B KZIS-0		
			 1863 869 010	35	Kugellager / Ball Bearing	(38)
			 6283 600 115			

		CODE					
---	--	------	--	--	---	---	---

































MERCEDES-BENZ

SPRINTER 3-t Bus (903) 01.95 - 05.06										
310 D 4x4 312 D 2.9 312 D 2.9 4x4	05.97 - 08.02	OM602LA		3000 951 785 ⊗ 3082 269 031 ⊗ 1878 600 501 ⊙ 3151 248 031	250 26 M250 250CD KZIS-0					
	02.95 - 04.00			3000 725 001 ● ⊗ 3082 269 031 ⊗ 1864 504 031 ⊙ 3151 248 031	250 26 M250 250B KZIS-0					
	05.97 - 08.02			2294 000 525	250	enthält Schwungradbefestigungsschrauben / includes bolt for flywheel mounting		(66)		
		OM602.980		1863 869 010	35	Kugellager / Ball Bearing		(38)		
				6283 600 115						
SPRINTER 4-t Bus (904) 02.96 - 05.06										
414	02.96 - 05.06	M111.979		3000 826 901 ⊗ 3082 268 031 ⊗ 1878 994 001 ⊙ 3151 248 031	240 26 M240 240TB KZIS-0					
				3000 951 785 ⊗ 3082 269 031 ⊗ 1878 600 501 ⊙ 3151 248 031	250 26 M250 250CD KZIS-0	für / for: SA 504097/03 für / for: SA 504096/03 für Motoren ohne Zweimassenschwungrad / for engines without dual-mass flywheel		(69) (69) (81)		
				1863 869 010	35	Kugellager / Ball Bearing		(38)		
				6283 600 115						
		M111.984		3000 990 218 	240 26	->Chass. A920787 ->Chass. R636764 Nabenprofil / Hub Profile: 26,5x29-26N für Schwungradtiefe [mm] / for flywheel depth [mm]: 8		(48) (84)		
			3000 990 252 	240 26	Nabenprofil / Hub Profile: 26,5x29-26N für Schwungradtiefe [mm] / for flywheel depth [mm]: 12 Nur zusammen verbauen / Only install together		(48) (84) (53)			
			3182 654 192 	HHAS-1	Immer erneuern / Renew everytime		(30)			
			3182 997 802	HHAS-1	Schaltgetriebe sequentiell / Sequential Manual Transmission mit Sensor / with sensor Füllmedium: Mineralöl / Fill Medium: Mineral Oil Immer erneuern / Renew everytime		(59) (92) (26) (30)			
	408 CDI 411 CDI 413 CDI 416 CDI		04.00 - 05.06	OM611.981/987, OM612.981		2290 601 011 	240 26	ZMS Modul XTend plus CSC Montageart: nicht vormontiert / Mounting Type: not pre-mounted Beinhaltet ZMS, Kupplungsdruckplatte, Kupplungsscheibe und CSC / Contains twin-mass flywheel, clutch cover assembly, clutch disc and CSC enthält Schwungradbefestigungsschrauben / includes bolt for flywheel mounting		(46) (11) (66)
						3000 990 218 	240 26	->Chass. A920787 ->Chass. R636764 Nabenprofil / Hub Profile: 26,5x29-26N für Schwungradtiefe [mm] / for flywheel depth [mm]: 8		(48) (84)
		3000 990 252 			240 26	Nabenprofil / Hub Profile: 26,5x29-26N für Schwungradtiefe [mm] / for flywheel depth [mm]: 12 Nur zusammen verbauen / Only install together		(48) (84) (53)		
		3182 997 802			HHAS-1	Schaltgetriebe sequentiell / Sequential Manual Transmission mit Sensor / with sensor Füllmedium: Mineralöl / Fill Medium: Mineral Oil Immer erneuern / Renew everytime		(59) (92) (26) (30)		
				3182 654 192 	HHAS-1	Immer erneuern / Renew everytime		(30)		
				1863 869 012	28	Nadellager / Needle Bearing		(49)		
SPRINTER 3-t Bus (906) 06.06 -										
216 (906.713)	09.08 -	M271.951		3000 990 144 	240 26					
				6284 605 004						

		CODE				
---	--	------	--	---	---	---

MERCEDES-BENZ

SPRINTER 3-t Bus (906) 06.06 -









































210 CDI (906.711, 906.713)	03.09 - 12.13	OM651.955		3000 990 287 	240		
				2294 000 994 	240	enthält Schwungradbefestigungsschrauben / includes bolt for flyweel mounting	(66)
				6284 605 004 			
		OM651		2290 601 081 	240 26	ZMS Modul XTend plus CSC Montageart: nicht vormontiert / Mounting Type: not pre-mounted Beinhaltet ZMS, Kupplungsdruckplatte, Kupplungsscheibe und CSC / Contains twin-mass flywheel, clutch cover assembly, clutch disc and CSC enthält Schwungradbefestigungsschrauben / includes bolt for flyweel mounting	(46) (11) (66)
211 CDI (906.711, 906.713) 215 CDI (906.711, 906.713)	06.06 - 12.09 06.06 - 12.09	OM646.990, OM646.989, OM646.986, OM646.985		3000 990 144  3000 951 188 3182 654 192	240 26 HHAS-1		
				2290 601 018 	240 26	ZMS Modul XTend plus CSC Montageart: nicht vormontiert / Mounting Type: not pre-mounted Beinhaltet ZMS, Kupplungsdruckplatte, Kupplungsscheibe und CSC / Contains twin-mass flywheel, clutch cover assembly, clutch disc and CSC enthält Schwungradbefestigungsschrauben / includes bolt for flyweel mounting	(46) (11) (66)
				6284 605 004 			
				3182 654 192 	HHAS-1		
213 CDI (906.711, 906.713)	06.06 - 05.16	OM651.956, OM651.955		3000 990 144  3000 951 188 3182 654 192	240 26 HHAS-1	Chass. S 559085->	
				3182 654 192 	HHAS-1	Chass. S 559085-> Immer erneuern / Renew everytime	(30)
216 CDI (906.711, 906.713)	06.06 -	OM646		3000 990 144  3000 951 188 3182 654 192	240 26 HHAS-1		
				2290 601 018 	240 26	ZMS Modul XTend plus CSC Montageart: nicht vormontiert / Mounting Type: not pre-mounted Beinhaltet ZMS, Kupplungsdruckplatte, Kupplungsscheibe und CSC / Contains twin-mass flywheel, clutch cover assembly, clutch disc and CSC enthält Schwungradbefestigungsschrauben / includes bolt for flyweel mounting	(46) (11) (66)
				6284 605 004 			
		OM651		3000 990 287  2290 601 081 	240 240 26	ZMS Modul XTend plus CSC Montageart: nicht vormontiert / Mounting Type: not pre-mounted Beinhaltet ZMS, Kupplungsdruckplatte, Kupplungsscheibe und CSC / Contains twin-mass flywheel, clutch cover assembly, clutch disc and CSC enthält Schwungradbefestigungsschrauben / includes bolt for flyweel mounting	(46) (11) (66)
				2294 000 994 	240	enthält Schwungradbefestigungsschrauben / includes bolt for flyweel mounting	(66)
				6284 605 004 			

SPRINTER 3,5-t Bus (906) 06.06 -

316 (906.733, 906.735) 316 NGT (906.733, 906.735)	09.08 - 09.08 -	M271.951		3000 990 144  3000 951 188 3182 654 192	240 26 HHAS-1		
				6284 605 004 			
316 LGT	09.08 -	M271.951		3000 990 144  3000 951 188 3182 654 192	240 26 HHAS-1		





















		CODE				
---	--	------	--	---	---	---













MERCEDES-BENZ

SPRINTER 3,5-t Bus (906) 06.06 -						
310 CDI (906.731, 906.733, 906.735)	03.09 - 12.13	OM646		3000 990 144   3000 951 188  3182 654 192	240 26 HHAS-1	
311 CDI (906.731, 906.733, 906.735)	06.06 - 12.09			2290 601 018   3000 951 188  2294 000 835  3182 654 192	240 26 HHAS-1	ZMS Modul XTend plus CSC Montageart: nicht vormontiert / Mounting Type: not pre-mounted (46) Beinhaltet ZMS, Kupplungsdruckplatte, Kupplungsscheibe und CSC / Contains twin-mass flywheel, clutch cover assembly, clutch disc and CSC (11) enthält Schwungradbefestigungsschrauben / includes bolt for flywheel mounting (66)
311 CDI 4x4 (906.731, 906.733, 906.735)	02.08 - 12.09					
313 CDI (906.731, 906.733, 906.735)	08.11 - 05.16					
313 CDI 4x4 (906.731, 906.733, 906.735)	08.11 - 05.16					
315 CDI (906.731, 906.733, 906.735)	06.06 - 12.09			6284 605 004 		
315 CDI 4x4 (906.731, 906.733, 906.735)	02.08 - 12.09	OM651		3000 990 287  2290 601 081 	240 240 26	ZMS Modul XTend plus CSC Montageart: nicht vormontiert / Mounting Type: not pre-mounted (46) Beinhaltet ZMS, Kupplungsdruckplatte, Kupplungsscheibe und CSC / Contains twin-mass flywheel, clutch cover assembly, clutch disc and CSC (11) enthält Schwungradbefestigungsschrauben / includes bolt for flywheel mounting (66)
				2294 000 994 	240	enthält Schwungradbefestigungsschrauben / includes bolt for flywheel mounting (66)
				6284 605 004 		
316 CDI (906.731, 906.733, 906.735)	08.11 -	OM651.957, OM651.955		3000 990 287  2290 601 081 	240 240 26	ZMS Modul XTend plus CSC Montageart: nicht vormontiert / Mounting Type: not pre-mounted (46) Beinhaltet ZMS, Kupplungsdruckplatte, Kupplungsscheibe und CSC / Contains twin-mass flywheel, clutch cover assembly, clutch disc and CSC (11) enthält Schwungradbefestigungsschrauben / includes bolt for flywheel mounting (66)
316 CDI 4x4 (906.731, 906.733, 906.735)	08.11 -					
318 CDI (906.731, 906.733, 906.735)	02.08 - 12.09	OM642.993, OM642.896, OM642.992, OM642.898		3000 990 195   3000 951 824  3182 654 192	260 26 HHAS-1	
318 CDI 4x4 (906.731, 906.733, 906.735)	02.08 - 12.09					
319 CDI / BlueTEC (906.731, 906.733, 906.735)	03.09 -			6284 605 004		
319 CDI / BlueTEC 4x4 (906.731, 906.733, 906.735)	03.09 -	OM642.896, OM642.992, OM642.898		3000 990 195   3000 951 824  3182 654 192	260 26 HHAS-1	
T2/LN1 Bus 07.87 - 12.92						
O 609 D (672.072, 672.073)	07.87 - 12.92	OM364		3482 054 131	280 MFZ280	672.072-073
				1861 919 134	280 10 280GTZ	672.072-073
				3151 170 131	KZIZ-3	672.072-073
O 611 D (672.372, 672.373)	07.87 - 12.92	OM364		3482 055 132	310 MFZ310	672.372-373
				1861 303 248	310 10 310GSB	672.372-373
				3151 170 131	KZIZ-3	672.372-373
O 614 D (672.375, 672.376)	07.87 - 12.92	OM354, OM364		3482 055 132	310 MFZ310	670.313
				1861 303 248	310 10 310GSB	670.313
				3151 170 131	KZIZ-3	670.313
		OM364		3482 055 132	310 MFZ310	672.375-376
				1861 303 248	310 10 310GSB	672.375-376
				3151 170 131	KZIZ-3	672.375-376

		CODE				
---	--	------	--	---	---	---



























MERCEDES-BENZ

VARIO Bus		09.96 -				
O 812 (670.373, 670.674) O 814 (670.373, 670.374)	09.96 - 12.10	OM602LADE	 3000 725 001	250 26		
			 3082 269 031	M250		
			 1864 504 031	250B		
		 3151 248 031	KZIS-0			
		 3000 951 785 ●	250 26			
		 3082 269 031	M250			
 1878 600 501	250CD					
 3151 248 031	KZIS-0					
			 2294 000 525	250	enthält Schwungradbefestigungsschrauben / includes bolt for flyweel mounting	(66)
		OM904LA	 3400 127 701 ☹	362 18		
			 3482 000 462	MF362		
			 1878 052 842	362WGTB		
			 3400 700 484 ☹	362 18		
 3482 000 462	MF362					
 1878 006 757	362WGTB					
 3151 000 396	KZIS-4					
O 815 (670.373, 670.374)	09.96 - 12.10	OM904.923	 3400 127 701 ☹	362 18	für / for: Medio 815	(69)
			 3482 000 462	MF362		
 1878 052 842	362WGTB					
 3151 000 396	KZIS-4					
					für / for: Medio 815	(69)

VITO Bus (W639)		09.03 -				
109 CDI, 65 kW	09.03 -	OM646DE22LA	 3000 970 079 ☹	240 26	XTend 639.701/703/705 Torsionsgefederte Kupplungsscheibe / torsion damper clutch disc	(61)
			 2294 000 834	240	639.701/703/705 enthält Schwungradbefestigungsschrauben / includes bolt for flyweel mounting	(66)
			 3182 654 192 (M)	HHAS-1	Getr. / GBox: 716.652 (SG-S370) Getr. / GBox: 716.680 (TSG-360) 639.701/703/705 Immer erneuern / Renew everytime	(30)
			3182 654 216	HHAS-1	Getr. Nr. / GBox No.: ->011 088 ->10.2003 Getr. / GBox: 716.637 (SG-S250) 639.701/703/705 Immer erneuern / Renew everytime	(30)
			3182 654 192 (M)	HHAS-1	Getr. Nr. / GBox No.: 011 088->10.2003-> Getr. / GBox: 716.637 (SG-S250) 639.701/703/705 Immer erneuern / Renew everytime	(30)
			 6284 605 008			
109 CDI 4x4 109 CDI, 70 kW	09.07 - 09.06 -	OM646DE22LA	 3000 970 079 ☹	240 26	XTend 639.701/703/705/711/713 Torsionsgefederte Kupplungsscheibe / torsion damper clutch disc	(61)
			 2294 000 834	240	639.701/703/705/711/713 enthält Schwungradbefestigungsschrauben / includes bolt for flyweel mounting	(66)
			 3182 654 192 (M)	HHAS-1	639.701/703/705/711/713 Immer erneuern / Renew everytime	(30)
		 6284 605 008				
110 CDI	09.10 -	OM651.940	 3000 990 287 (M) ☹	240		
			 2294 000 994 (M)	240	enthält Schwungradbefestigungsschrauben / includes bolt for flyweel mounting	(66)
			 6284 605 008 (M)			
		 2290 601 081 (M)	240 26	ZMS Modul XTend plus CSC Montageart: nicht vormontiert / Mounting Type: not pre-mounted Beinhaltet ZMS, Kupplungsdruckplatte, Kupplungsscheibe und CSC / Contains twin-mass flywheel, clutch cover assembly, clutch disc and CSC enthält Schwungradbefestigungsschrauben / includes bolt for flyweel mounting	(46) (11) (66)	









		CODE					
---	--	------	--	--	---	---	---





MERCEDES-BENZ













VITO Bus (W639)		09.03 -						
111 CDI	09.03-	OM646DE22LA		3000 951 112 	240 26	XTend ->Chass. 152223 ->05.2005 Getr. / GBox: 716.652 (SG-S370) 639.701/703/705/711/713 Nabenprofil / Hub Profile: 26,6x28,9-26N	(48)	
				3000 970 079 	240 26	XTend ->Chass. 152223 ->05.2005 Getr. / GBox: 716.652 (SG-S370) 639.701/703/705/711/713 Torsionsgefederte Kupplungsscheibe / torsion damper clutch disc	(61)	
				3000 951 112 	240 26	XTend Chass. 152224-> 05.2005-> 639.701/703/705/711/713 Nabenprofil / Hub Profile: 26,6x28,9-26N	(48)	
				3000 970 079 	240 26	XTend Chass. 152224-> 05.2005-> 639.701/703/705/711/713 Torsionsgefederte Kupplungsscheibe / torsion damper clutch disc	(61)	
				2294 000 834	240	639.701/703/705/711/713 enthält Schwungradbefestigungsschrauben / includes bolt for flywheel mounting	(66)	
				3182 654 192 	HHAS-1	Getr. / GBox: 716.652 (SG-S370) Getr. / GBox: 716.680 (TSG-360) 639.701/703/705/711/713 Immer erneuern / Renew everytime	(30)	
				3182 654 216	HHAS-1	Getr. Nr. / GBox No.: ->011 088 ->10.2003 Getr. / GBox: 716.637 (SG-S250) 639.701/703/705/711/713 Immer erneuern / Renew everytime	(30)	
				3182 654 192 	HHAS-1	Getr. Nr. / GBox No.: 011 089-> 10.2003-> Getr. / GBox: 716.637 (SG-S250) 639.701/703/705/711/713 Immer erneuern / Renew everytime	(30)	
				OM646.982		6284 605 008		
			111 CDI 4x4 111 CDI (639.701)	09.07 - 09.07 -	OM646DE22LA		3000 970 079 	240 26
	3000 951 112 	240 26				XTend 639.701/703/705/711/713 Nabenprofil / Hub Profile: 26,6x28,9-26N	(48)	
	2294 000 834	240				639.701/703/705/711/713 enthält Schwungradbefestigungsschrauben / includes bolt for flywheel mounting	(66)	
	3182 654 192 	HHAS-1				639.701/703/705/711/713 Immer erneuern / Renew everytime	(30)	
	OM646.980, OM646.982					6284 605 008		
113 CDI 116 CDI	09.10 - 09.10 -	OM651.940		3000 990 287 	240			
				6284 605 008 				
		OM651		2290 601 081 	240 26	ZMS Modul XTend plus CSC Montageart: nicht vormontiert / Mounting Type: not pre-mounted Beinhaltet ZMS, Kupplungsdruckplatte, Kupplungsscheibe und CSC / Contains twin-mass flywheel, clutch cover assembly, clutch disc and CSC enthält Schwungradbefestigungsschrauben / includes bolt for flywheel mounting	(46) (11) (66)	
			OM651DE22LA		2294 000 994 	240	639.701/703/705/711/713 enthält Schwungradbefestigungsschrauben / includes bolt for flywheel mounting	(66)

		CODE				
---	--	------	--	---	---	---

MERCEDES-BENZ

VITO Bus (W639)		09.03 -					
115 CDI 115 CDI 4x4	09.03 -	OM646DE22LA		3000 970 079 	240 26	XTend 639.701/703/705/711/713 Torsionsgefederte Kupplungsscheibe / torsion damper clutch disc	(61)
	09.07 -			3000 951 112 	240 26	XTend 639.701/703/705/711/713 Nabenprofil / Hub Profile: 26,6x28,9-26N	(48)
				2294 000 834	240	639.701/703/705/711/713 enthält Schwungradbefestigungsschrauben / includes bolt for flywheel mounting	(66)
				3182 654 192 	HHAS-1	Getr. / GBox: 716.652 (SG-S370) Getr. / GBox: 716.680 (TSG-370) 639.701/703/705/711/713 Immer erneuern / Renew everytime	(30)
				3182 654 216	HHAS-1	Getr. Nr. / GBox No.: ->011 088 ->10.2003 Getr. / GBox: 716.637 (SG-S250) 639.701/703/705/711/713 Immer erneuern / Renew everytime	(30)
				3182 654 192 	HHAS-1	Getr. Nr. / GBox No.: 011 089->10.2003-> Getr. / GBox: 716.637 (SG-S250) 639.701/703/705/711/713 Immer erneuern / Renew everytime	(30)
				OM646.980, OM646.982		6284 605 008	







VITO Tourer (W447)		10.14 -					
109 CDI / 109 BlueTEC (447.701, 447.703, 447.705) 111 CDI / 111 BlueTEC (447.701, 447.703, 447.705)	10.14 -	OM622.951		3000 950 932 	240 26	XTend Nabenprofil / Hub Profile: 26,60x28,89-26N	(48)
	10.14 -						
114 CDI / 114 BlueTEC (447.701, 447.703, 447.705) 114 CDI / 114 BlueTEC 4x4 (447.701, 447.703, 447.705) 116 CDI / 116 BlueTEC (447.701, 447.703, 447.705) 116 CDI / 116 BlueTEC 4x4 (447.701, 447.703, 447.705) 119 BlueTEC (447.701, 447.703, 447.705) 119 CDI / 119 BlueTEC 4x4 (447.701, 447.703, 447.705)	10.14 -	OM651.950		3182 654 192 	HHAS-1	Immer erneuern / Renew everytime	(30)
	07.15 -						
	10.14 -						
	07.15 -						
	10.14 -						
12.14 -							

Fahrgestell / Chassis							
O 500 M 382.175/176 382.186 1725 382.186 1728 382.175 1732 382.176				3482 081 231	430		
				1878 080 033	430 10		
				3151 000 529	KZIS-4		
				3151 000 497	KZISZ-5		
O 500 R 634.001 1632 634.001		OM926LA		3482 081 231	430		
				1878 080 033	430 10		
				3151 000 529	KZIS-4		
				3151 000 497	KZISZ-5		
O 500 RS / 1836 634.011 O 500 RS / 2036 634.061 O 500 RS / 2242 634.071				3483 030 032 	430		
				1878 080 037	430 10	je nach Ausführung, mit unterschiedlicher Kupplung / depending on version, with different clutch	(85)
				1878 634 027	430 10	je nach Ausführung, mit unterschiedlicher Kupplung / depending on version, with different clutch	(85)







		CODE				
---	--	------	--	---	---	---

MERCEDES-BENZ

811

LPO 811 318.065-067	10.69-02.73	OM352	 1882 317 131 #	280 HVB280	Mot. 393781-> 318.065-067		
			 1861 919 134	280 10 280GTZ	Mot. 393781-> 318.065-067		
			 3151 095 043	KZI-3	->Chass. 4282707 Mot. 393781-> 318.065-067		
					3151 033 031	KZI-3	Chass. 4282708 - Mot. 678174 318.065-067
					3151 044 031	KZI-3	Mot. 678175-> 318.065-067
			 1882 252 331	GFX310	310	->Chass. 922885 318.065-067	
					1882 305 131	310 GFX310	Chass. 922886 - Mot. 393780 318.065-067
			 1861 303 248	310 10 310GSB	->Mot. 393780 318.065-067		
			 3151 095 043	KZI-3	Chass. 922886 - Mot. 393780 318.065-067		

813

LPO 813 318.065-067	10.69-	OM352	 1882 317 131 #	280 HVB280	Mot. 393781-> 318.065-067		
			 1861 919 134	280 10 280GTZ	Mot. 393781-> 318.065-067		
			 3151 095 043	KZI-3	->Chass. 4282707 Mot. 393781-> 318.065-067		
					3151 033 031	KZI-3	Chass. 4282708 - Mot. 678174 318.065-067
					3151 044 031	KZI-3	Mot. 678175-> 318.065-067
			 1882 252 331	GFX310	310	->Chass. 922885 318.065-067	
					1882 305 131	310 GFX310	Chass. 922886 - Mot. 393780 318.065-067
			 1861 303 248	310 10 310GSB	->Mot. 393780 318.065-067		
			 3151 095 043	KZI-3	Chass. 922886 - Mot. 393780 318.065-067		

O 301

09.85 - 12.87

O 301 697.001	06.86-05.87	OM366	 3400 122 401	310 10 MF310	697.001
O 301 697.006	02.86-05.87	OM366A	 3482 008 038	310WGSZ	697.006
			 1861 964 034	KZI-3	
			 3151 044 031	KZI-3	
O 301 697.006	02.86-05.87	OM366A	 3482 012 240	330 GMF330	697.006
			 1861 963 033	330 10 330WGSZ	697.006
			 3151 044 031	KZI-3	697.006



CODE



SACHS

Parameter



MERCEDES-BENZ









O 302

01.64 - 11.75























O 302 NKWID gekürzt 302.276 302.236 302.274 302.224 302.269 302.255 302.250 302.286 302.295 302.242 302.248 302.254 302.281 302.297 302.284 302.211 302.243 302.246 302.252 302.203 302.212 302.219 302.226 302.283 302.296 302.216 302.245 302.261 302.240 302.244 302.215 302.206 302.201/202 302.268 302.271 302.213 302.265 302.270 302.221 302.214 302.275 302.285 302.230 302.292 302.241 302.233		OM352	1882 201 132	295 GF295	302.280-281/284-285/290-291/295/264-265/268 /269-270-271/274-275/221/224-225/230-231/234 /235/240-241/244-245/250-251/254-255/261/201 /203/206/208/211/214-215/220	
			1861 279 133	295 10 295GTZ	302.221/224-225/230-231/234-235/240-241/244 /245/250-251/254-255/261/201/203/206/208/211 /214-215/220/280-281/284-285/290-291/295/264 /265/268-269-270-271/274-275	
			3151 095 043	KZI-3	302.221/224-225/230-231/234-235/240-241/244 /245/250-251/254-255/261/201/203/206/208/211 /214-215/220/280-281/284-285/290-291/295/264 /265/268-269-270-271/274-275	
			1882 252 331	310 GFX310	Chass. 005442 - Chass. 025406 302.280-281/284-285/290-291/295/264-265/268 /269-270-271/274-275/221/224-225/230-231/234 /235/240-241/244-245/250-251/254-255/261/201 /203/206/208/211/214-215/220	
			1882 305 131	310 GFX310	Chass. 025407-> 302.221/224-225/230-231/234-235/240-241/244 /245/250-251/254-255/261/201/203/206/208/211 /214-215/220/280-281/284-285/290-291/295/264 /265/268-269-270-271/274-275	
			1861 303 248	310 10 310GSB	Chass. 005442-> /214-215/220/280-281/284-285/290-291/295/264 /265/268-269-270-271/274-275 302.221/224-225/230-231/234-235/240-241/244 /245/250-251/254-255/261/201/203/206/208/211	
			3151 095 043	KZI-3	Chass. 005442-> 302.221/224-225/230-231/234-235/240-241/244 /245/250-251/254-255/261/201/203/206/208/211 /214-215/220/280-281/284-285/290-291/295/264 /265/268-269-270-271/274-275	
		OM360	1882 234 433	350 GF350	Chass. 002235-> /292-293/296/298-299 302.233/236/242-243/246/252/256/262/272/276 /282-283/202/207/212-213/216/222/226/232/286	
			1878 001 074	350 10 350GTZ	302.233/236/242-243/246/252/256/262/272/276 /282-283/202/207/212-213/216/222/226/232/286 /292-293/296/298-299	
			3151 094 041	KZI-4	302.233/236/242-243/246/252/256/262/272/276 /282-283/202/207/212-213/216/222/226/232/286 /292-293/296/298-299	
			1882 234 433	350 GF350	Chass. 797910-> 302.230-231/234-235/240-241/244-245/250-251 /254-255/261/201/203/206/208/220-221/224-225 /285/290-291/294-295/264-265/270/274-275/280 /281/284 Sonderausführung / Special design (60)	
			1878 001 074	350 10 350GTZ	302.240-241/244-245/261/264-265/280-281/284 /285/291/294-295/211/214-215/225/230-231/234 /235/290/270/274-275/250-251/254-255/201/203 /206/208/220-221/224 Sonderausführung / Special design (60)	
			3151 094 041	KZI-4	302.230-231/234-235/240-241/244-245/250-251 /254-255/261/201/203/206/208/220-221/224-225 /264-265/280-281/284-285/291/294-295/211/214 /215/290/270/274-275 Sonderausführung / Special design (60)	
		OM327	1882 234 433	350 GF350		
1878 001 074	350 10 350GTZ					
3151 094 041	KZI-4					
1882 234 433	350 GF350		Sonderausführung / Special design (60)			
1878 001 074	350 10 350GTZ		Sonderausführung / Special design (60)			
3151 094 041	KZI-4		Sonderausführung / Special design (60)			
O 302 302.221 302.225 302.230 302.294 302.280 302.284 302.234 302.285 302.235 302.244/245 302.268 302.255 302.261 302.251 302.271 302.281 302.231 302.241 302.265 302.240 302.290 302.295	11.64 - 11.75	OM352.993, OM352.980	1882 201 132	295 GF295	-> Chass. 005 441	
			1882 252 331	310 GFX310	Chass. 005 442->	
			1861 303 248	310 10 310GSB	Chass. 005 442->	

		CODE				
---	--	------	--	---	---	---

MERCEDES-BENZ























O 302		01.64 - 11.75					
O 302 373.023 302.279 373.073 373.083 302.299 302.298 O 302 373.024 373.073 302.279 302.298 373.023 373.083 302.299 O 302 302.296 373.083 373.074 373.073 373.084	05.69 - 12.74	OM360.916, OM360.984, OM360.986, OM360.980, OM360.981, OM360.985, OM360.979		1882 234 433	350 GF350		
	05.69 - 12.74			1878 001 074	350 10 350GTZ		
	05.69 - 12.74						
O 302 Sonderausführung 302.281 302.214 302.295 302.244 302.230 302.225 302.250 302.255 302.294 302.220 302.235 302.231 302.241 302.265 302.270 302.261 302.264 302.251 302.201 302.280 302.203 302.211 302.291 302.245 302.275 302.290 302.234 302.240 302.206 302.208 302.215 302.221 302.224 302.254 302.274 302.284/285		OM327		1882 234 433	350 GF350	Sonderausführung / Special design (60)	
					1878 001 074	350 10 350GTZ	Sonderausführung / Special design (60)
					3151 094 041	KZI-4	Sonderausführung / Special design (60)
			OM360		1882 234 433	350 GF350	Chass. 797910-> 302.230-231/234-235/240-241/244-245/250-251 /254-255/261/201/203/206/208/220-221/224-225 /285/290-291/294-295/264-265/270/274-275/280 /281/284 Sonderausführung / Special design (60)
					1878 001 074	350 10 350GTZ	302.240-241/244-245/261/264-265/280-281/284 /285/291/294-295/211/214-215/225/230-231/234 /235/290/270/274-275/250-251/254-255/201/203 /206/208/220-221/224 Sonderausführung / Special design (60)
					3151 094 041	KZI-4	302.230-231/234-235/240-241/244-245/250-251 /254-255/261/201/203/206/208/220-221/224-225 /264-265/280-281/284-285/291/294-295/211/214 /215/290/270/274-275 Sonderausführung / Special design (60)

MERCEDES-BENZ





















O 303		10.74 - 09.92			
O 303 NKWID gekurzt 301.342 301.515 300.210 301.353 301.365 301.375 600.415 301.314/315 301.345 301.364 301.523 301.534 300.290 300.414 300.494 301.323 301.362 301.393 600.414 600.485 301.335 301.514 600.494 300.495 301.384 301.373 301.343 300.415 301.535 301.325 301.334 600.290 600.210 301.385 301.525 300.484/485 300.435 301.524 301.513 301.374 301.305 301.312 301.533 600.484 301.394/395		OM421	 3482 124 534 430 GMF430	300.210/290	
		 1882 301 239 ● 420 GF420	300.210/290		
		 1878 003 657 420 10 420WGTZ	300.210/290		
		 3151 126 031 KZI-4,5	300.210/290		
		OM422	 3482 124 534 430 GMF430	301.334-335/342-343-344-345/353/362/364-365 /373-374-375/384-385/305/312-313-314-315/323 /324-325/525/533-534-535/393-394-395/513-514 /515/523-524	
		 1882 301 239 ● 420 GF420	301.334-335/342-343-344-345/353/362/364-365 /373-374-375/384-385/305/312-313-314-315/323 /324-325/525/533-534-535/393-394-395/513-514 /515/523-524		
		 1878 003 657 420 10 420WGTZ	301.334-335/342-343-344-345/353/362/364-365 /373-374-375/384-385/305/312-313-314-315/323 /324-325/525/533-534-535/393-394-395/513-514 /515/523-524		
		 3151 000 375 KZIS-4	-> Chass. 039682 301.334-335/342-343-344-345/353/362/364-365 /373-374-375/384-385/305/312-313-314-315/323 /324-325/525/533-534-535/393-394-395/513-514 /515/523-524		
		 3151 126 031 KZI-4,5	Chass. 39683-> 301.334-335/342-343-344-345/353/362/364-365 /373-374-375/384-385/305/312-313-314-315/323 /324-325/525/533-534-535/393-394-395/513-514 /515/523-524		
		 1882 342 134 420 GF420X	300.414-415/435/484-485/494-495		
		 3151 000 375 KZIS-4	-> Chass. 036733 300.414-415/435/484-485/494-495		
		 3151 126 031 KZI-4,5	Chass. 036734-> 300.414-415/435/484-485/494-495		
		OM441	 3482 081 232 430 MFZ430	600.210/290	
		 1878 080 033 430 10 430WGTZ	600.210/290		
		 3151 000 547 KZISZ-5	600.210/290 für Ausrückgabel mit Rollen / for release fork with rollers	(71)	
		OM442	 3482 081 231 430 MFZ430	600.414-415/484-485/494-495	
		 1878 080 037 430 10 430WGTZ	600.414-415/484-485/494-495		
		 3151 000 547 KZISZ-5	600.414-415/484-485/494-495 für Ausrückgabel mit Rollen / for release fork with rollers	(71)	
			 3189 600 060		
		O 303 301.100 301.110 301.102 301.106 301.124/125 301.105 301.126 301.103 301.112 301.121 301.130 301.101 301.104 301.160 301.120 301.122/123 O 303 301.111 301.131 301.161 O 303 301.113/114 301.133 301.135 301.162/163 301.112 301.164 301.116 301.132 301.136 301.166 301.115 301.134 301.165	10.74 - 06.83	OM401	 1882 311 131 # 350 GF350
			 1878 001 144 350 10 350WGTZ	301.130-136/160-166/100-106/110-116/120-126	
10.74 - 06.83			 1878 001 147 # 350 10 350WGTZ	301.130-136/160-166/100-106/110-116/120-126	
10.74 - 06.83			 3151 043 031 KZI-4,5	301.130-136/160-166/100-106/110-116/120-126	

		CODE				
---	--	------	--	---	---	---

MERCEDES-BENZ

O 303		10.74 - 09.92						
O 303 300.114 300.121 300.133 300.142 300.511 300.531 600.109 300.111 300.122 300.521 600.161 600.111 300.115 300.141 600.131 600.151 300.112 300.130 600.110 300.161/162 O 303 300.111 300.140 300.190 600.111 300.120 300.510 600.150 300.112 300.520 600.190 300.114 300.160 600.109 300.115 300.130 300.133 300.170 300.530 600.110 600.160	01.80-01.89	OM421		1882 302 131	380 GF380	-> Chass. 053213 300.133/139-140/142-143-144-145/159-160 /162-165/519/529/109/112/114-115/123-124-125 /130/110-111/121/141/161/170/190/510-511/520 /521/530-531		
		01.80-09.92			1878 001 152	380 10 380WGTZ	-> Chass. 053213 300.133/139-140/142-143-144-145/159-160 /162-165/519/529/109/112/114-115/123-124-125 /130/110-111/121/141/161/170/190/510-511/520 /521/530-531	
					3151 000 375	KZIS-4	300.110-111/121/141/161/170/190/510-511/520 /521/530-531/333/139-140/142-143-144-145/159 /160/162-165/519/529/109/112/114-115/123-124 /125/130	
					3151 126 031	KZI-4,5	Chass. 040653 - Chass. 053213 300.110-111/121/141/154/161/170/190/510-511 /520-521/530-531	
					3482 124 541	430 GMF430	Chass. 053214-> 300.133/139-140/142-143-144-145/159-160 /162-165/519/529/109/112/114-115/123-124-125 /130/110-111/121/141/154/161/170/190/510-511 /520-521/530-531	
					1882 301 238 ●#	420 GF420	Chass. 053214-> 300.133/139-140/142-143-144-145/159-160 /162-165/519/529/109/112/114-115/123-124-125 /130/110-111/121/141/154/161/170/190/510-511 /520-521/530-531	
					1878 003 657	420 10 420WGTZ	Chass. 053214-> 300.133/139-140/142-143-144-145/159-160 /162-165/519/529/109/112/114-115/123-124-125 /130/110-111/121/141/154/161/170/190/510-511 /520-521/530-531	
					3151 000 375	KZIS-4	Chass. 053214-> 300.133/139-140/142-143-144-145/159-160 /162-165/519/529/109/112/114-115/123-124-125 /130	
					3151 126 031	KZI-4,5	Chass. 053214-> 300.110-111/121/141/154/161/170/190/510-511 /520-521/530-531	
			OM441		3400 123 001  3482 081 232  1878 080 031  3151 000 549	430 10 MFZ430 430WGTZ KZISZ-5	600.110-111/134/150/153/160-161/190	
		OM441.909, OM421.908, OM441.911, OM441.908		3189 600 060				
O 303 300.111/112 300.119 300.159 300.109 300.114 300.139 600.159 300.110 300.115 300.133 300.519 300.130 600.109 300.529	01.80-09.92	OM421		1882 302 131	380 GF380	-> Chass. 053213 300.133/139-140/142-143-144-145/159-160 /162-165/519/529/109/112/114-115/123-124-125 /130		
				1878 001 152	380 10 380WGTZ	-> Chass. 053213 300.133/139-140/142-143-144-145/159-160 /162-165/519/529/109/112/114-115/123-124-125 /130		
				3151 000 375	KZIS-4	-> Chass. 053213 300.133/139-140/142-143-144-145/159-160 /162-165/519/529/109/112/114-115/123-124-125 /130		
				3482 124 541	430 GMF430	Chass. 053214-> 300.133/139-140/142-143-144-145/159-160 /162-165/519/529/109/112/114-115/123-124-125 /130		
				1882 301 238 ●#	420 GF420	Chass. 053214-> 300.133/139-140/142-143-144-145/159-160 /162-165/519/529/109/112/114-115/123-124-125 /130		
				1878 003 657	420 10 420WGTZ	Chass. 053214-> 300.133/139-140/142-143-144-145/159-160 /162-165/519/529/109/112/114-115/123-124-125 /130		
				3151 000 375	KZIS-4	Chass. 053214-> 300.133/139-140/142-143-144-145/159-160 /162-165/519/529/109/112/114-115/123-124-125 /130		
			OM421.908, OM441.911		3189 600 060			





























MERCEDES-BENZ

O 303		10.74 - 09.92					
O 303 300.124 300.144 300.143 300.163 600.111 600.134 300.112 300.154 600.110 600.153 300.115 300.145 300.164 600.109 300.125 300.111 300.114 300.123 300.130 300.133 300.165	01.80 - 09.92	OM421		1882 302 131	380 GF380	-> Chass. 053213 300.110-111/121/141/154/161/170/190/510-511 /520-521/530-531/133/139-140/142-143-144-145 /159-160/162-165/519/529/109/112/114-115/123 /124-125/130	
				1878 001 152	380 10 380WGTZ	-> Chass. 053213 300.133/139-140/142-143-144-145/159-160 /162-165/519/529/109/112/114-115/123-124-125 /130/110-111/121/141/154/161/170/190/510-511 /520-521/530-531	
				3151 000 375	KZIS-4	-> Chass. 053213 300.133/139-140/142-143-144-145/159-160 /162-165/519/529/109/112/114-115/123-124-125 /130	
				3151 126 031	KZI-4,5	Chass. 040653 - Chass. 053213 300.110-111/121/141/154/161/170/190/510-511 /520-521/530-531	
				3482 124 541	430 GMF430	Chass. 053214-> 300.133/139-140/142-143-144-145/159-160 /162-165/519/529/109/112/114-115/123-124-125 /130/110-111/121/141/154/161/170/190/510-511 /520-521/530-531	
				1882 301 238 ●#	420 GF420	Chass. 053214-> 300.133/139-140/142-143-144-145/159-160 /162-165/519/529/109/112/114-115/123-124-125 /130/110-111/121/141/154/161/170/190/510-511 /520-521/530-531	
				1878 003 657	420 10 420WGTZ	Chass. 053214-> 300.133/139-140/142-143-144-145/159-160 /162-165/519/529/109/112/114-115/123-124-125 /130/110-111/121/141/154/161/170/190/510-511 /520-521/530-531	
				3151 000 375	KZIS-4	Chass. 053214-> 300.133/139-140/142-143-144-145/159-160 /162-165/519/529/109/112/114-115/123-124-125 /130	
				3151 126 031	KZI-4,5	Chass. 053214-> 300.110-111/121/141/154/161/170/190/510-511 /520-521/530-531	
		OM441		3400 123 001 ● 3482 081 232 ● 1878 080 031 ● 3151 000 549	430 10 MFZ430 430WGTZ KZISZ-5	600.110-111/134/150/153/160-161/190	
		OM441.909, OM421.908, OM441.911, OM441.908		3189 600 060			
O 303 300.210 300.290 O 303 300.312 314 300.342 300.335 300.322 300.315 300.305 300.323-325 300.334	11.85 - 04.89	OM421.951, OM422.917, OM442.908, OM441.950		1882 301 239	420 GF420		
	01.80 - 09.87			1878 003 657	420 10 420WGTZ		
				3151 126 031	KZI-4,5		
O 303 301.214/215 301.234/235 301.263 301.206 301.233 301.265 301.275 301.205 301.224 301.226 301.266 301.213 301.245 301.273 301.204 301.264 301.203 301.216 301.223 301.225 301.236 301.274	03.75 - 06.83	OM402		1882 302 131	380 GF380	301.233-236/245/263-266/273-275/203-206 /213-216/223-226	
				1878 001 152	380 10 380WGTZ	301.233-236/245/263-266/273-275/203-206 /213-216/223-226	
				3151 000 375	KZIS-4	301.233-236/245/263-266/273-275/203-206 /213-216/223-226	
			OM402.907		3189 600 060		
O 303 600.210 600.290	12.87 - 09.92	OM441.953, OM441.950		3482 081 232	430 MFZ430		
				1878 080 033	430 10 430WGTZ		
				3151 000 547	KZISZ-5		

		CODE				
---	--	------	--	---	---	---

MERCEDES-BENZ





O 303 10.74 - 09.92















O 303 300.335 300.373 300.305 300.314 300.323 300.345 300.364 300.395 300.515 300.524 300.344 300.363 300.365 300.394 300.312/313 300.315 300.324 300.374 300.385 300.384 300.393 300.514 300.534/535 300.325 300.362 300.533 373.195 300.343 300.513 300.334 300.342 300.375 300.523 300.525	01.80 - 09.87	OM422	 3482 124 534	430 GMF430	300.305/315/325/335/345/365/375/385/395/515 /525/535
			 1882 301 239 ●	420 GF420	300.305/315/325/335/345/365/375/385/395/515 /525/535
			 1878 003 657	420 10 420WGTZ	300.305/315/325/335/345/365/375/385/395/515 /525/535
			 3151 000 375	KZIS-4	-> Chass. 039682 300.305/315/325/335/345/365/375/385/395/515 /525/535
			 3151 126 031	KZI-4,5	Chass. 039683-> 300.305/315/325/335/345/365/375/385/395/515 /525/535
			 3482 124 534	430 GMF430	Chass. 039683-> 300.515
			 1882 301 239 ●	420 GF420	Chass. 039683-> 300.515
			 1878 003 657	420 10 420WGTZ	Chass. 039683-> 300.515
			 3151 126 031	KZI-4,5	Chass. 039683-> 300.515
		OM422.917, OM422.908	 3189 600 060		
O 303 600.335 600.363-365 600.385 600.325 600.353 600.355 600.394 600.315 600.354 600.384 600.313/314 600.375 600.393 600.395	09.87 - 09.92	OM442	 3400 124 101	430 10 MFZ430	600.375/384-385/393-395/313-315/325/335 /353-355/363-365
			 3482 081 232	430WGTZ	
			 1878 005 668	KZISZ-5	
			 3151 000 549		
O 303 301.305 301.314 301.364 301.374 301.335 301.334 301.304 301.315 301.375 301.324/325 301.365	07.75 - 06.83	OM403	 3482 124 534	430 GMF430	301.304-305/314-315/324-325/334-335/364-365 /374-375
			 1882 301 239 ●	420 GF420	301.304-305/314-315/324-325/334-335/364-365 /374-375
			 1878 003 657	420 10 420WGTZ	301.304-305/314-315/324-325/334-335/364-365 /374-375
			 3151 000 375	KZIS-4	301.304-305/314-315/324-325/334-335/364-365 /374-375
		OM403.918	 3189 600 060		
O 303 300.495 300.415 300.485 300.484 300.414 300.435 300.494	08.80 - 09.87	OM422.963, OM422.951	 1882 342 134	420 GF420X	
			 1878 003 657	420 10 420WGTZ	
			 3151 000 375	KZIS-4	-> Chass. 036733
			 3151 126 031	KZI-4,5	Chass. 036734->
			 3189 600 060		
O 303 600.484/485 600.414 600.494/495 600.415	09.87 - 09.92	OM442.961, OM442.960, OM442.955, OM442.954	 3400 128 001	430 10 MFZ430	
			 3482 081 231	430WGTZ	
			 1878 080 037	KZISZ-5	
			 3151 000 547		

O 305 09.67 - 05.87

O 305 307.000 305.210 307.001 305.220 305.211		OM407	 1882 330 032 #	420 GF420	307.000-001	
			 1878 001 136	420 10 420GTZ	307.000-001	
			 3151 000 375	KZIS-4	307.000-001	
			OM360	 1861 470 234	380 10 380GSZ	Chass. 002085-> 305.210-211/220
				 3189 600 060		



















MERCEDES-BENZ

O 305		09.67 - 05.87				
O 305 G 307.101 307.100	02.78-05.87	OM407.910, OM407.913,		1882 330 032 #	420 GF420	
O 305 G 307.101 307.100	02.79-05.87	OM407.905, OM407.909,		1878 001 136	420 10 420GTZ	
O 305 ST 307.001 307.050 307.000 307.055	04.73-07.77	OM407.908, OM407.951,		3151 000 375	KZIS-4	
O 305 ST 305.210	01.70-05.73	OM407.955, OM407.919,		3189 600 060		
O 305 ST 307.000/001	11.76-05.87	OM407.917, OM407.911,				
O 305 ST 307.000/001	04.73-07.77	OM407.914				
O 305 ST 307.000/001	11.76-05.87					
O 305 ST 307.000/001	02.79-05.87					
O 305 VÖV		OM360		1861 470 234	380 10 380GSZ	

O 307		04.73 - 12.87				
O 307 307.051 307.055 307.050		OM407		1882 330 032 #	420 GF420	->Chass. 000051 307.050-051/055
				1878 001 136	420 10 420GTZ	->Chass. 000051 307.050-051/055
				3151 000 375	KZIS-4	->Chass. 000051 307.050-051/055
				1882 302 131	380 GF380	Chass. 000052 - Chass. 004702 307.050-051/055
				1878 000 105	380 10 380GTZ	Chass. 000052 - Chass. 004702 307.050-051/055
				3151 000 375	KZIS-4	Chass. 000052 - Chass. 004702 307.050-051/055
				3482 124 541	430 GMF430	Chass. 004703-> 307.050-051/055
				1882 301 238 ●#	420 GF420	Chass. 004703-> 307.050-051/055
				1878 001 136	420 10 420GTZ	Chass. 004703-> 307.050-051/055
				3151 000 375	KZIS-4	Chass. 004703-> 307.050-051/055
				3189 600 060		
O 307 307.055 307.001 307.050	04.73-07.77	OM407.918, OM407.905,		1882 330 032 #	420 GF420	
O 307 307.050 307.055	11.76-07.87	OM407.916, OM407.915,		1878 001 136	420 10 420GTZ	
O 307 307.050 307.055 307.051	04.73-07.77	OM407.955, OM407.911,		3151 000 375	KZIS-4	
O 307 307.050/051 307.055	04.73-07.77	OM407.907		3189 600 060		
O 307 307.000 307.051	11.76-08.87					

MERCEDES-BENZ



O 309 01.68 - 02.89

O 309 D 309.172/173 309.191 309.181/182 309.171 309.183 309.190 O 309 D 323.386 323.389 323.382 O 309 D 602.487 602.467 602.471/472 602.477 602.476 602.461/462 602.466		OM615, 616, 621	 3082 121 031	228 M228	Chass. 018154->	
			 1878 634 052	228 10 228GSB	Chass. 018154 - Chass. 556499 309.181-183/191	
			 3151 000 206	KZIS-1	Chass. 028345 - Chass. 556499 309.181-183/191/170-173/190	
			 3151 000 206	KZIS-1	Chass. 556500-> 309.170-191	
		OM314	 1800 125 201	250 10 HBX250	Mot. 678175-> 309.370-371-372/382-383/390-391	
			 1882 205 234	250 HBX250		
			 1882 205 234	250 HBX250		
			 1882 600 122 ●	250 HBX250		
			 1861 291 136	250 10 250GTZ	309.370-371-372/382-383/390-391	
			 1878 634 082 ●	250 10 250GTZ	309.370-371-372/382-383/390-391	
			 3151 095 043	KZI-3	->Chass. 018153 LHD ->Chass. 018729 RHD 309.370-371-372/382-383/390-391	
			 3151 033 031	KZI-3	Chass. 018154 - Mot. 678174 Chass. 018729-> 309.370-371-372/382-383/390-391	
			 3151 033 031	KZI-3	->Mot. 410747 310.383/389	
			 3151 044 031	KZI-3	Mot. 410748-> 310.383/389	
		OM353	 1882 317 131 #	280 HVB280	313.382/386/389	
			 1861 632 032	280 10 280W2GSZ	->Chass. 346882 313.382/386/389	
			 1861 919 134	280 10 280GTZ	Chass. 346883-> 313.382/386/389	
			 3151 044 031	KZI-3	313.382/386/389	
			 1863 869 010	35	Kugellager / Ball Bearing	(38)

O 311

O 311			 1860 062 037 #	280 10 280Z		
--------------	--	--	--	----------------	--	--

O 317 09.58 - 02.76

O 317 317.226 317.206-209 317.230-236 317.240-248 317.201-204 317.228 317.224 317.214-222		OM326, 346	 1881 041 656 #	380 G380	->Mot. 053185 317.226/228/230-236/240-248/201-204/206-209 /214-222/224 nicht für Motornummer / not for engine number: 050162-163	(98)
			 1878 000 104	380 10 380GTZ	317.226/228/230-236/240-248/201-204/206-209 /214-222/224 nicht für Motornummer / not for engine number: 050162-163	(98)
			 3151 000 529	KZIS-4	317.226/228/230-236/240-248/201-204/206-209 /214-222/224	



O 319



O 319 B		OM121	 1881 059 208	200 KS200	->Chass. 004861	
			 1861 123 236	200 10 200PE	->Chass. 004861	
O 319 D		OM621, 636	 1881 059 208	200 KS200		
			 1861 123 236	200 10 200PE		

		CODE				
---	--	------	--	---	---	---







MERCEDES-BENZ









O 320						
O 320				1881 039 532 #	350 G350KR	->Chass. 3500318
				1861 034 147 #	350 10	->Chass. 3500318

O 321						
O 321 H,HL		OM321, 322		1861 919 134	280 10 280GTZ	
				1860 062 037 #	280 10 280Z	Sonderausführung / Special design (60)
O 321 H,HL Sonderausführung		OM321, 322		1860 062 037 #	280 10 280Z	Sonderausführung / Special design (60)

O 322						
O 322				1861 919 134	280 10 280GTZ	
O 322 Sonderausführung				1860 062 037 #	280 10 280Z	































O 330 01.90 -						
O 330 600.345	01.90 -	OM442		3400 124 101 ⊗ 3482 081 232 ⊗ 1878 005 668 ⊙ 3151 000 549	430 10 MFZ430 430WGTZ KZISZ-5	600.345
O 330 600.445	01.90 -					

O 340 01.91 - 06.95						
O 340 600.342 600.344	01.91 - 06.95	OM441.994, OM441.995		3482 081 231	430 MFZ430	
				1878 080 033	430 10 430WGTZ	
				3151 000 547	KZISZ-5	
O 340 600.442	01.91 -	OM402.984		3482 081 231	430 MFZ430	600.442
				1878 080 037	430 10 430WGTZ	600.442
				3151 000 547	KZISZ-5	600.442
Tourismo 600.442	08.92 - 08.95	OM402.984, OM402.995		3400 128 001 ⊗ 3482 081 231 ⊗ 1878 080 037 ⊙ 3151 000 547	430 10 MFZ430 430WGTZ KZISZ-5	

O 345 (CONECTO) 11.01 -						
O 345, Euro 1 671.005		OM447HA		3482 081 232	430 MFZ430	
				1878 080 033	430 10 430WGTZ	
				3151 000 547	KZISZ-5	
O 345, Euro 2 671.000		OM449HLA		3482 081 232	430 MFZ430	
				1878 080 033	430 10 430WGTZ	
				3151 000 547	KZISZ-5	
O 345, Euro 2 671.010		OM447HLA		3482 081 232	430 MFZ430	
				1878 080 033	430 10 430WGTZ	
				3151 000 547	KZISZ-5	









		CODE				
---	--	------	--	---	---	---







MERCEDES-BENZ









O 345 (CONECTO) 11.01 -							
CONECTO C, H, M, UE 671.021 671.030 671.042 671.020 671.015 CONECTO C, H, UE 671.015 671.020 671.030 671.042 CONECTO C, H, M, UE 671.020/021 671.030 671.015 671.042 CONECTO C, H, M, UE 671.020/021 671.942 671.030 671.015	11.01-	OM906		3482 081 231	430 MFZ430		
	11.01-			1878 080 033	430 10 430WGTZ		
	11.01-	OM457		3482 081 232	430 MFZ430		
	11.01-			1878 080 034	430 10 430WGTZ		
				3151 000 547	KZISZ-5	für OE-Nummer / for OE number 002 250 08 15 (83) für OE-Nummer / for OE number 001 250 88 15 (83)	
			OM906.960, OM457.942		3151 000 278	KZISZ-5	für OE-Nummer / for OE number 001 250 98 15 (83) für OE-Nummer / for OE number 001 250 86 15 (83)
					3151 000 335	KZISZ-5	für OE-Nummer / for OE number 002 250 44 15 (83)
				3189 600 059			
O 350 (TOURISMO) 09.94 -							
Tourismo RHD 632.037 632.036 632.038 632.035		OM457		3482 000 852	430 MFZ430	632.036/038	
				1878 005 541	430 10 430WGTZ	632.036/038	
				3151 000 335	KZISZ-5	632.036/038	
O 350 613.385 613.355		OM441LA		3482 081 231	430 MFZ430	613.355/385	
				1878 080 033	430 10 430WGTZ	613.355/385	
				3151 000 278	KZISZ-5	613.355/385	
				3482 081 231	430 MFZ430	613.355/385 Länderausführung: Türkei / Country-spec. model: Turkey (43)	
				3151 000 547	KZISZ-5	613.355/385 Länderausführung: Türkei / Country-spec. model: Turkey (43)	
				3189 600 059			
O 350 613.455 613.485		OM402LA		3400 122 601	430 10 MFZ430	613.455/485	
				3482 081 231 1878 080 037 3151 000 278	430 10 430WGTZ KZISZ-5		
				3400 128 001 3482 081 231 1878 080 037 3151 000 547	430 10 MFZ430 430WGTZ KZISZ-5	Länderausführung: Türkei / Country-spec. model: Turkey (43)	
				3189 600 059			
Tourismo 613.455	08.95-	OM446.938		3482 081 231	430 MFZ430		
				1878 080 034	430 10 430WGTZ	für / for: SA504902-02 (69)	
				1878 080 037	430 10 430WGTZ	->Chass. 1038/99, 07.02.00 für / for: SA504902-02 (69)	
				3151 000 547	KZISZ-5	für / for: SA504901-02 (69)	
				3151 000 157	KZISZ-5	für / for: SA504901-03 (69) für / for: SA504901-04 (69)	
Tourismo RHD, SHD 613.358 613.388	09.03-	OM457.944		3482 081 233	430 MFZ430		
				1878 080 034	430 10 430WGTZ		
				3151 000 335	KZISZ-5		
				6594 000 079	430 430Z	für / for: SA 522019-03 (69) für / for: SA 522019-08 (69) für / for: SA 522019-15 (69) enthält Schwungradbefestigungsschrauben / includes bolt for flywheel mounting (66)	
				1863 869 028		für / for: SA 522019-03 (69) für / for: SA 522019-08 (69) für / for: SA 522019-15 (69)	

		CODE				
---	--	------	--	---	---	---

MERCEDES-BENZ

































O 350 (TOURISMO)		09.94 -						
Tourismo RHD, SHD 613.388 613.358	09.03-	OM457.944		3482 081 233	430 MFZ430			
				1878 080 034	430 10 430WGTZ			
				3151 000 335	KZIZ-5			
				6594 000 079	430 430Z	enthält Schwungradbefestigungsschrauben / includes bolt for flyweel mounting	(66)	
				1863 869 028				
Tourismo 15 RHD 632.036	01.03-	OM457.952, OM542.966, OM457.941, OM457.961, OM542.948, OM457.965, OM457.944, OM457.953		3400 700 509 	430 10 XTend Nabenprofil / Hub Profile: 41,1x50,8-10N Nur zusammen verbauen / Only install together		(48)	
Tourismo 15 RHD 632.036	01.03-			1863 869 028				(53)
Tourismo 15 RHD 632.036	01.03-							
Tourismo 15 RHD 632.036	01.03-							
Tourismo 15 RHD 632.006	01.03-							
Tourismo 15 SHD	01.03-							
Tourismo 15 SHD	01.03-							
Tourismo 16 RHD 632.038	01.03-							
Tourismo 16 RHD 632.035 632.038	01.03-							
Tourismo 16 RHD 632.035	01.03-							
Tourismo 16 RHD 632.035	01.03-							
Tourismo 16 RHD 632.035	01.03-							
Tourismo 16 RHD 632.035	01.03-							
Tourismo 16 RHD 632.035	01.03-							
Tourismo 17 RHD	01.03-							
Tourismo 17 RHD	01.03-							
Tourismo 17 RHD	01.03-							

O 402		10.85 - 12.91					
O 402 697.051	02.86 - 12.91	OM366		3400 122 401  3482 008 038  1861 964 034  3151 044 031	310 10 MF310 310WGSZ KZI-3	697.051	
O 402 697.056	02.86 - 12.91	OM366A		3482 012 240	330 GMF330	697.056	
				1861 963 033	330 10 330WGSZ	697.056	
				3151 044 031	KZI-3	697.056	















O 403		01.95 - 12.06					
O 403 613.355 613.385		OM441LA		3400 128 001  3482 081 231  1878 080 037  3151 000 547	430 10 MFZ430 430WGTZ KZISZ-5	Länderausführung: Türkei / Country-spec. model: Turkey	(43)
				3482 081 231	430 MFZ430	Länderausführung: Türkei / Country-spec. model: Turkey	(43)
		OM402LA		1878 080 037	430 10 430WGTZ	Länderausführung: Türkei / Country-spec. model: Turkey	(43)
				3151 000 157	KZISZ-5	Länderausführung: Türkei / Country-spec. model: Turkey	(43)
O 403 - RHD E3 613.385 613.355		OM457LA		6594 000 079	430 430Z	für OE-Nummer / for OE number 457 030 13 05 enthält Schwungradbefestigungsschrauben / includes bolt for flyweel mounting	(83) (66)

		CODE				
---	--	------	--	---	---	---

MERCEDES-BENZ

O 404		09.91 - 10.99				
O 404 356.113 618.335 356.133 356.163 356.153 356.123 618.000 356.143		OM441LA	 3400 123 001  3482 081 232  1878 080 031  3151 000 549	430 10 MFZ430 430WGTZ KZISZ-5	356.113/123/133/143/153/163	
			 3482 081 233	430 MFZ430	618.335	
			 1878 002 735	430 10 430GTZ	618.335	
			 3151 000 157	KZISZ-5	618.335	
			 3482 081 232	430 MFZ430	618.000	
			 1878 080 033	430 10 430WGTZ	618.000	
			 3151 000 547	KZISZ-5	618.000 für Ausrückgabel mit Rollen / for release fork with rollers	(71)
O 404 356.030	09.91 - 01.92	OM441	 3482 081 232	430 MFZ430	356.030	
O 404 356.030	09.91 - 01.92		 1878 080 031	430 10 430WGTZ	356.030	
			 3151 000 547	KZISZ-5	356.030	
O 404 356.225 356.235	09.91 - 01.92	OM442	 3400 124 101  3482 081 232  1878 005 668  3151 000 549	430 10 MFZ430 430WGTZ KZISZ-5	356.225/235/255	
O 404 356.235 356.225	09.91 - 01.92					
O 404 356.130 356.110 356.120 356.150 356.140 356.160	09.91 - 10.99	OM401LA	 3482 081 232	430 MFZ430	356.140/145/150/155/160/165/110/115/120/125 /130/135 614.115	
	09.91 - 10.99		 1878 080 033	430 10 430WGTZ	356.140/145/150/155/160/165/110/115/120/125 /130/135 614.115	
			 3151 000 547	KZISZ-5	356.140/145/150/155/160/165/110/115/120/125 /130/135 614.115 für Ausrückgabel mit Rollen / for release fork with rollers	(71)
O 404 356.100 356.110 356.120 356.150 356.155 356.160 356.130 356.140 356.170	09.91 - 10.99	OM401LA	 3482 081 232	430 MFZ430		
	09.91 - 10.99		 1878 080 033	430 10 430WGTZ		
			 3151 000 547	KZISZ-5	für Ausrückgabel mit Rollen / for release fork with rollers	(71)
O 404 356.105 356.333 614.315 356.323 614.313 356.363 618.133 356.353 614.345 618.103 618.113 618.123	09.91 - 10.99	OM441LA	 3400 124 101  3482 081 232  1878 005 668  3151 000 549	430 10 MFZ430 430WGTZ KZISZ-5	->Chass. 069374 356.323	
			 1878 080 033	430 10 430WGTZ	Chass. 069375-> 356.323	
			 3482 081 231	430 MFZ430	356.353/355/363/365/385/395/313/315/325/333 /335/345 614.313/315/345 356.323/343	
			 1878 080 033	430 10 430WGTZ	356.353/355/363/365/385/395/313/315/325/333 /335/345 614.313/315/345 356.323/343	
			 3151 000 547	KZISZ-5	356.353/355/363/365/385/395/313/315/325/333 /335/345 614.313/315/345	
			 3151 000 157 ●	KZISZ-5	356.345/353/355/363/365/385/395/313/315/323 /325/333/335/343 614.313/315/345	

MERCEDES-BENZ

O 404		09.91 - 10.99					
O 404 356.105 356.113 356.305 356.395 356.405 356.343 356.375 614.345 618.105 618.123 618.113 618.115 356.315 356.355 356.335 356.353 356.303 356.325 614.313 618.135 614.315 356.313 356.385 356.345 356.365 356.323 356.363 356.373 618.205 618.125 356.415 618.133 618.145 618.203	09.91 - 10.99	OM441LA		3482 081 231	430 MFZ430	356.353/355/363/365/385/395/313/315/325/333 /335/345 614.313/315/345 356.323/343	
				1878 080 033	430 10 430WGTZ	356.353/355/363/365/385/395/313/315/325/333 /335/345 614.313/315/345 356.323/343	
				3151 000 547	KZISZ-5	356.353/355/363/365/385/395/313/315/325/333 /335/345 614.313/315/345	
				3151 000 157 ●	KZISZ-5	356.345/353/355/363/365/385/395/313/315/323 /325/333/335/343 614.313/315/345 Sonderausführung / Special design	(60)
				3482 081 231	430 MFZ430	618.105/125	
				1878 080 034	430 10 430WGTZ	618.105/125	
				3151 000 547	KZISZ-5	618.105/125	
O 404 614.428 618.233 618.203 618.223 618.213	09.94 - 10.99	OM446.938		3482 081 231	430 MFZ430		
				1878 080 037	430 10 430WGTZ		
				3151 000 547	KZISZ-5		
O 404 356.465 356.495 356.313 356.405 356.443 356.485 614.313 356.425 356.343 614.415 356.435 356.455 614.428 356.373 356.323 356.363 356.445 356.353 356.415 614.435 614.445 614.115	09.91 - 10.99	OM402LA		3400 128 001	430 10 MFZ430		
				3482 081 231	430WGTZ		
				1878 080 037	KZISZ-5		
				3151 000 547	KZISZ-5		



CODE



SACHS

Parameter













MERCEDES-BENZ

O 405		09.84 -			
O 405 612.312 612.514 612.522-525 357.432 357.580 357.424 612.512 357.486 357.400 357.410 357.442 357.480 357.484 357.402 612.400-402 357.422 612.323 357.444 357.404 357.406 357.434 357.440 357.415 612.322 612.420 357.430 357.420 612.410-413 612.110 612.116		OM447	3482 124 522 430 GMF430	612.110/116	
			1882 342 134 ● 420 GF420X	612.110/116	
			1878 003 657 420 10 420WGTZ	612.110/116	
			3151 126 031 KZI-4,5	612.110/116	
		OM427, 447	3482 124 522 430 GMF430 Sonderausführung / Special design	(60)	
			1882 342 134 ● 420 GF420X Sonderausführung / Special design	(60)	
			1862 211 031 # 420 10 420WGSZ Sonderausführung / Special design	(60)	
			3151 126 031 KZI-4,5 Sonderausführung / Special design	(60)	
			3482 124 522 430 GMF430 Getr. / GBox: DB 3/60-S4 Sonderausführung / Special design	(60)	
			1882 342 134 ● 420 GF420X Getr. / GBox: DB 3/60-S4 Sonderausführung / Special design	(60)	
			1878 001 136 420 10 420GTZ Getr. / GBox: DB 3/60-S4 Sonderausführung / Special design	(60)	
			3151 000 375 KZIS-4 Getr. / GBox: DB 3/60-S4 Sonderausführung / Special design	(60)	
			3482 124 522 430 GMF430 Getr. / GBox: ZF S4-90 Sonderausführung / Special design	(60)	
			1882 342 134 ● 420 GF420X Getr. / GBox: ZF S4-90 Sonderausführung / Special design	(60)	
			1862 211 031 # 420 10 420WGSZ Getr. / GBox: ZF S4-90 Sonderausführung / Special design	(60)	
			3151 000 375 KZIS-4 Getr. / GBox: ZF S4-90 Sonderausführung / Special design	(60)	
			3482 124 522 430 GMF430 Sonderausführung / Special design	(60)	
			1882 342 134 ● 420 GF420X Sonderausführung / Special design	(60)	
			3151 126 031 KZI-4,5 Sonderausführung / Special design	(60)	
			O 405 G, O 405 GN, O 405 GTD 357.210 357.250 612.512 357.552 357.550 612.312 612.514 357.532 357.200/201 357.530	11.85 -	OM427.911, OM447.907
1882 342 134 ● 420 GF420X	357.200-201				
1878 003 662 420 10 420WGTZ	357.200-201				
3151 126 031 KZI-4,5	357.200-201				





		CODE				
---	--	------	--	---	---	---

MERCEDES-BENZ

O 405 09.84 -

























O 405 ST, O 405 N 357.000 357.401 357.422 357.425 357.450/451 612.401 357.400 612.400 357.410 357.420 612.000 612.402 612.001 612.407 357.001/002 357.424 357.454/455 612.403 357.402 357.404 O 405 ST 357.001 357.000 357.011 357.010	12.84 - 11.85 -	OM447.905, OM447.950, OM427.905, OM447.951, OM447.970, OM447.973, OM427.950, OM447.911, OM447.914, OM447.913	 3482 124 522	430 GMF430	für OE-Nummer / for OE number 004 250 00 04 für OE-Nummer / for OE number 005 250 19 04 357.000-001	(83) (83)			
			 1882 342 134 ●	420 GF420X	357.000-001				
			 1862 211 031 #	420 10 420WGSZ	für OE-Nummer / for OE number 015 250 33 03 für OE-Nummer / for OE number 012 250 33 03 für OE-Nummer / for OE number 008 250 95 03 357.000-001	(83) (83) (83)			
			1878 001 136	420 10 420GTZ	für OE-Nummer / for OE number 005 250 97 03 für OE-Nummer / for OE number 007 250 13 03 für OE-Nummer / for OE number 007 250 12 03 357.000-001	(83) (83) (83)			
			1878 003 662	420 10 420WGTZ	für OE-Nummer / for OE number 019 250 37 03 357.000-001	(83)			
			 3151 000 375	KZIS-4	für OE-Nummer / for OE number 000 250 74 15 für OE-Nummer / for OE number 000 250 77 15 357.000-001	(83) (83)			
			3151 126 031	KZI-4,5	für OE-Nummer / for OE number 000 250 76 15 357.000-001	(83)			
			 3189 600 060						
			O 405 ST, O 405 N 357.000 612.616 612.412/413 357.005 357.464/465 612.411 612.417 357.404 357.430 357.460/461 612.405 612.011 357.004 357.436 357.466 612.010 612.410 612.416 357.406 357.200 357.432 357.434 357.438 612.418 357.001 357.415 357.435	11.85 -	OM447.908, OM447.910, OM447.906, OM447.996, OM427.911, OM447.956, OM447.957, OM447.907, OM427.910, OM447.974, OM447.971	 3482 124 522	430 GMF430	für OE-Nummer / for OE number 004 250 00 04 für OE-Nummer / for OE number 005 250 19 04 357.000-001/004-005 612.010-011	(83) (83)
						 1882 342 134 ●	420 GF420X	357.000-001/004-005 612.010-011	
 1862 211 031 #	420 10 420WGSZ	für OE-Nummer / for OE number 015 250 33 03 für OE-Nummer / for OE number 012 250 33 03 für OE-Nummer / for OE number 008 250 95 03 357.000-001/004-005				(83) (83) (83)			
1878 003 662	420 10 420WGTZ	für OE-Nummer / for OE number 019 250 37 03 357.000-001/004-005 612.010-011				(83)			
1878 001 136	420 10 420GTZ	für OE-Nummer / for OE number 007 250 13 03 für OE-Nummer / for OE number 007 250 12 03 für OE-Nummer / for OE number 005 250 97 03 357.000-001				(83) (83) (83)			
 3151 126 031	KZI-4,5	für OE-Nummer / for OE number 000 250 76 15 357.000-001/004-005 612.010-011				(83)			
3151 000 375	KZIS-4	für OE-Nummer / for OE number 000 250 74 15 für OE-Nummer / for OE number 000 250 77 15 357.000-001				(83) (83)			
 3189 600 060									

O 407 03.87 - 11.01

O 407 357.100 357.110		OM447	 3482 124 522	430 GMF430	357.100/110	
			 1882 342 134 ●	420 GF420X	357.100/110	
			 1862 211 031 #	420 10 420WGSZ	357.100/110	
			 3151 126 031	KZI-4,5	357.100/110	
			 3482 124 534	430 GMF430	357.110 Sonderausführung / Special design	(60)
			 1882 301 239 ●	420 GF420	357.110 Sonderausführung / Special design	(60)
			 1862 211 031 #	420 10 420WGSZ	357.110 Sonderausführung / Special design	(60)
			 3151 126 031	KZI-4,5	357.110 Sonderausführung / Special design	(60)





















		CODE				
---	--	------	--	---	---	---

MERCEDES-BENZ

O 407		03.87 - 11.01					
O 407 357.100 612.110 357.110 612.116	03.87 - 11.01	OM447.906, OM447.908		3482 124 522	430 GMF430	für OE-Nummer / for OE number 005 250 19 04 für OE-Nummer / for OE number 004 250 00 04 357.100/110	(83) (83)
				1882 342 134	420 GF420X	357.100/110	
				1878 003 662	420 10 420WGTZ	für OE-Nummer / for OE number 015 250 33 03 für OE-Nummer / for OE number 012 250 33 03 für OE-Nummer / for OE number 008 250 95 03 für OE-Nummer / for OE number 007 250 12 03 357.100/110	(83) (83) (83) (83)
				3151 126 031	KZI-4,5	für OE-Nummer / for OE number 000 250 76 15 357.100/110	(83)
		OM447.990		3482 124 522	430 GMF430	612.110/116	
				1882 342 134	420 GF420X	612.110/116	
				1878 003 662	420 10 420WGTZ	für OE-Nummer / for OE number 019 250 36 03 für OE-Nummer / for OE number 015 250 37 03 für OE-Nummer / for OE number 005 250 97 03 612.110/116	(83) (83) (83)
				1878 001 136	420 10 420GTZ	für OE-Nummer / for OE number 007 250 13 03 612.110/116	(83)
				1878 002 706	420 10 420GTZ	für OE-Nummer / for OE number 007 250 43 03 für OE-Nummer / for OE number 007 250 42 03 612.110/116	(83) (83)
				3151 126 031	KZI-4,5	612.110/116	
O 407 357.120 612.120 357.130 612.126	11.91 - 11.01	OM447.991, OM447.985		3482 124 522	430 GMF430		
				1882 342 134	420 GF420X		
				1878 003 657	420 10 420WGTZ	nicht für / not for: TELMA-Bremse	(96)
				1878 002 706	420 10 420GTZ	für / for: TELMA-Bremse	(69)
				3151 126 031	KZI-4,5		
O 408		09.89 - 12.98					
O 408 612.216 357.160 357.150	01.91 - 12.98	OM447.908, OM447.912		3482 124 522	430 GMF430	für OE-Nummer / for OE number 005 250 19 04 für OE-Nummer / for OE number 004 250 00 04 357.150/160	(83) (83)
				1882 342 134	420 GF420X	357.150/160	
				1878 003 662	420 10 420WGTZ	für OE-Nummer / for OE number 015 250 33 03 für OE-Nummer / for OE number 012 250 33 03 für OE-Nummer / for OE number 008 250 95 03 für OE-Nummer / for OE number 007 250 12 03 357.150/160	(83) (83) (83) (83)
				3151 126 031	KZI-4,5	für OE-Nummer / for OE number 000 250 76 15 357.150/160	(83)
		OM447.992		3482 124 522	430 GMF430	612.216	
				1882 342 134	420 GF420X	612.216	
				1878 003 662	420 10 420WGTZ	für OE-Nummer / for OE number 019 250 36 03 für OE-Nummer / for OE number 015 250 37 03 für OE-Nummer / for OE number 005 250 97 03 612.216	(83) (83) (83)
				1878 001 136	420 10 420GTZ	für OE-Nummer / for OE number 007 250 13 03 612.216	(83)
				1878 002 706	420 10 420GTZ	für OE-Nummer / for OE number 007 250 43 03 für OE-Nummer / for OE number 007 250 42 03 612.216	(83) (83)
				3151 126 031	KZI-4,5	612.216	























		CODE				
---	--	------	--	---	---	---

MERCEDES-BENZ

O 408		09.89 - 12.98				
O 408 612.226 357.180 357.170	08.92 - 12.98	OM447.987, OM447.993	 3482 124 522	430 GMF430		
			1882 342 134 ●	420 GF420X		
			 1878 003 657	420 10 420WGTZ	nicht für / not for: TELMA-Bremse	(96)
			1878 002 706	420 10 420GTZ	für / for: TELMA-Bremse	(69)
			 3151 126 031	KZI-4,5		
O 408 357.180 612.216 612.226 357.160 357.150		OM447	 3482 124 522	430 GMF430	357.150/160/180	
			1882 342 134 ●	420 GF420X	357.150/160/180	
			 1862 211 031 #	420 10 420WGSZ	357.150/160/180	
			 3151 126 031	KZI-4,5	357.150/160/180	
			 3482 124 522	430 GMF430	612.216	
			1882 342 134 ●	420 GF420X	612.216	
			 1878 003 657	420 10 420WGTZ	612.216	
			 3151 126 031	KZI-4,5	612.216	
			 3482 124 522	430 GMF430	612.226	
			1882 342 134 ●	420 GF420X	612.226	
			 3151 126 031	KZI-4,5	612.226	
			O 500 (Touro)		01.00 -	
Touro 634.203 Touro 634.203	10.01 -	OM457	 3400 700 509 ■	430 10	XTend Nabenprofil / Hub Profile: 41,1x50,8-10N Nur zusammen verbauen / Only install together	(48) (53)
	10.01 -	OM457.944	 6594 000 079	430 430Z	für / for: SA522019-08/15 enthält Schwungradbefestigungsschrauben / includes bolt for flyweel mounting	(69) (66)
O 510 (TOURINO)		10.03 -				
TOURINO 444.200 444.203 TOURINO 444.203 444.200 TOURINO 444.303 444.300	10.03 -	OM906.962, OM926.939, OM906.961	 3482 000 463	395 MF395		
	10.03 -		 1878 003 784	395 18 395WGTZ		
	10.03 -		 3151 000 396	KZIS-4		
			 1863 869 040		nur als Ersatz für angegebene OE-Nr. / only for the listed OE-Numbers	(100)
O 530 (CITARO)		01.98 -				
Citaro		OM457HLA	 6594 000 079	430 430Z	für OE-Nummer / for OE number 457 030 13 05 enthält Schwungradbefestigungsschrauben / includes bolt for flyweel mounting	(83) (66)
Citaro N 628.143 628.147/148 628.100 628.145 628.101	01.99 -	OM909.921, OM906.930, OM909.901, OM906.960	 3482 081 232	430 MFZ430	->Chass. 099808 628.143/145/148	
			3482 081 231	430 MFZ430	Chass. 099809-> 628.143/145/148	
		OM457	 1878 080 033	430 10 430WGTZ	628.143/145/148	
		OM906	 1878 080 033	430 10 430WGTZ	628.143/145/148	















		CODE				
---	--	------	--	---	---	---













MERCEDES-BENZ

O 530 (CITARO)		01.98 -					
Citaro N 628.000/001	01.98 -	OM906.931, OM909.911, OM909.900		3482 081 232	430 MFZ430	für / for: SA 504903-03 628.000	(69)
				1878 080 033	430 10 430WGTZ	für / for: SA 504902-07 628.000	(69)
				3151 000 335	KZIZ-5	für / for: SA 504901-04 für / for: SA 504905-06/07 für / for: SA 504905-08/09 628.000	(69) (69) (69)
				3151 000 547	KZISZ-5	für / for: SA 504901-02 für / for: SA 504905-05 628.000	(69) (69)
				3151 000 278	KZISZ-5	für / for: SA 504901-05 628.000	(69)
				3482 081 232	430 MFZ430	->Chass. 099808 für / for: SA 504903-03 628.001	(69)
				3482 081 231	430 MFZ430	Chass. 099809-> für / for: SA 504903-04 628.001	(69)
				1878 080 033	430 10 430WGTZ	für / for: SA 504902-06 628.001	(69)
				1878 080 037	430 10 430WGTZ	für / for: SA 504902-04 628.001	(69)
				3151 000 335	KZIZ-5	für / for: SA 504901-04 für / for: SA 504905-06/07 für / for: SA 504905-08/09 628.001	(69) (69) (69)
				3151 000 547	KZISZ-5	für / for: SA 504901-02 für / for: SA 504905-05 628.001	(69) (69)
				3151 000 278	KZISZ-5	für / for: SA 504901-05 628.001	(69)
				6284 605 064		Füllmedium: Bremsflüssigkeit / Fill Medium: Brake Fluid	(25)
				3189 600 059			
Citaro N 628.045 628.050 628.043 628.040	04.99 -	OM906.962, OM906.963		3482 081 232	430 MFZ430	->Chass. 099808 628.043/045	
				3482 081 231	430 MFZ430	Chass. 099809-> 628.043/045	
		OM457		1878 080 033	430 10 430WGTZ	628.043/045	
		OM906		1878 080 033	430 10 430WGTZ	628.043/045	
Citaro N 628.045 628.050 628.001 628.043 628.040 628.447 628.047/048 628.002 628.000	01.98 -	OM909.921, OM906.930, OM909.901, OM906.960, OM906.961		3482 081 232	430 MFZ430	->Chass. 099808 628.043/045/047-048	
				3482 081 231	430 MFZ430	Chass. 099809-> 628.043/045/047-048	
				6284 605 064		Füllmedium: Bremsflüssigkeit / Fill Medium: Brake Fluid	(25)
		OM457		1878 080 033	430 10 430WGTZ	628.043/045/047-048	
		OM906		1878 080 033	430 10 430WGTZ	628.043/045/047-048	

		CODE				
---	--	------	--	---	---	---









MERCEDES-BENZ





O 530 (CITARO)		01.98 -					
Citaro N, Citaro MUE 628.083 628.085 628.447 628.040 628.087 628.001 628.080 628.000	01.98-	OM457.934, OM457.959, OM457.950, OM457.949, OM457.973, OM457.942	 3482 081 232	430 MFZ430	für / for: SA 504903-03 628.000	(69)	
			 1878 080 033	430 10 430WGTZ	für / for: SA 504902-07 628.000	(69)	
			 3151 000 335	KZIZ-5	für / for: SA 504901-04 für / for: SA 504905-06/07 für / for: SA 504905-08/09 628.000	(69) (69) (69)	
			 3151 000 547	KZISZ-5	für / for: SA 504901-02 für / for: SA 504905-05 628.000	(69) (69)	
			 3151 000 278	KZISZ-5	für / for: SA 504901-05 628.000	(69)	
			 3482 081 232	430 MFZ430	-> Chass. 099808 für / for: SA 504903-03 628.001	(69)	
			 3482 081 231	430 MFZ430	Chass. 099809-> für / for: SA 504903-04 628.001	(69)	
			 1878 080 033	430 10 430WGTZ	für / for: SA 504902-06 628.001	(69)	
			 1878 080 037	430 10 430WGTZ	für / for: SA 504902-04 628.001	(69)	
			 3151 000 335	KZIZ-5	für / for: SA 504901-04 für / for: SA 504905-06/07 für / for: SA 504905-08/09 628.001	(69) (69) (69)	
			 3151 000 547	KZISZ-5	für / for: SA 504901-02 für / for: SA 504905-05 628.001	(69) (69)	
			 3151 000 278	KZISZ-5	für / for: SA 504901-05 628.001	(69)	
			 3189 600 059				
			OM906	 1878 080 033	430 10 430WGTZ	628.001	
			OM457.934/942	 1863 869 028		für / for: SA 522019-03/08/15 628.000/001	(69)











O 550 (INTEGRO)		09.96 -					
O 550		OM447HLA, OM457HLA	 3400 700 451	430 10 MFZ430	Getr. / GBox: ZF 6F-85		
			 3482 081 231	430WGTZ			
			 1878 080 031	KZISZ-5			
			 3151 000 157				
		OM441LA	 3482 081 233	430 MFZ430	Getr. / GBox: G04/160		
			 1878 080 033	430 10 430WGTZ			
			 3151 000 547	KZISZ-5			
Integro L	01.06 -	OM457HLA	 3400 700 509 	430 10	XTend Nabenprofil / Hub Profile: 41,1x50,8-10N Nur zusammen verbauen / Only install together	(48)	
Integro L 633.004			 6594 000 079	430 430Z		für / for: SA522019-08/15	(53)
Integro L 633.004			 1863 869 028			enthält Schwungradbefestigungsschrauben / includes bolt for flywheel mounting	(69) (66)
Integro M	01.06 -	OM457.952	 1863 869 040		nur als Ersatz für angegebene OE-Nr. / only for the listed OE-Numbers	(100)	
Integro 12M							

		CODE				
---	--	------	--	---	---	---

MERCEDES-BENZ































O 550 (INTEGRO)		09.96 -					
Integro, Integro M 633.001/002 Integro, Integro M 633.001/002	01.06 -	OM457LA		3482 000 852	430 MFZ430	je nach Ausführung, mit unterschiedlicher Kupplung / depending on version, with different clutch	(85)
	01.06 -			1878 005 541	430 10 430WGTZ	je nach Ausführung, mit unterschiedlicher Kupplung / depending on version, with different clutch	(85)
				3151 000 335	KZIZ-5	je nach Ausführung, mit unterschiedlicher Kupplung / depending on version, with different clutch	(85)
				3400 700 509 	430 10	XTend Nabenprofil / Hub Profile: 41,1x50,8-10N je nach Ausführung, mit unterschiedlicher Kupplung / depending on version, with different clutch Nur zusammen verbauen / Only install together	(48) (85) (53)
				6594 000 079	430 430Z	für / for: SA522019-08/15 enthält Schwungradbefestigungsschrauben / includes bolt for flywheel mounting	(69) (66)
				1863 869 028			
		1863 869 040		nur als Ersatz für angegebene OE-Nr. / only for the listed OE-Numbers	(100)		
		OM457.964, OM457.952, OM457.965					

INTOURO		01.05 -					
Intouro, Intouro E, Intouro M, Intouro ME 633.252 633.052 633.051 633.251 Intouro, Intouro E, Intouro M, Intouro ME 633.251 633.052 633.051 633.252 Intouro, Intouro E, Intouro M, Intouro ME 633.251 633.051/052 633.252 Intouro, Intouro E, Intouro M, Intouro ME 633.051/052 633.252 633.251	01.05 -	OM926.939, OM457.965		3482 000 463	395 MF395		
	01.05 -			1878 006 173	395 18 395WGTZ		
				3151 000 396	KZIS-4		
				1863 869 040		nur als Ersatz für angegebene OE-Nr. / only for the listed OE-Numbers	(100)
	01.05 -	OM457		1863 869 028			

O 580 (TRAVEGO)		10.99 -					
Travego 629.015 632.006 632.010 632.012 632.007 632.005				3400 700 509 	430 10	XTend Nabenprofil / Hub Profile: 41,1x50,8-10N Nur zusammen verbauen / Only install together	(48) (53)
				6594 000 079	430 430Z	für / for: SA 522019-15 enthält Schwungradbefestigungsschrauben / includes bolt for flywheel mounting	(69) (66)
				1863 869 028			
Travego		OM470		3400 700 537 	430 18	XTend 632.400 Nabenprofil / Hub Profile: 45x50-18N Nur zusammen verbauen / Only install together	(48) (53)
				6594 000 218	430	632.400	
				3151 001 082 	KZISZ-5	632.400	
				1863 869 028			







































		CODE				
---	--	------	--	---	---	---

MERCEDES-BENZ

O 580 (TRAVEGO)		10.99 -					
Travego L	01.05-	OM457LA	 3400 700 509 	430 10	XTend 632.246 Nabenprofil / Hub Profile: 41,1x50,8-10N Nur zusammen verbauen / Only install together	(48) (53)	
			 6594 000 079	430 430Z	für / for: SA 522019-15 632.246 enthält Schwungradbefestigungsschrauben / includes bolt for flywheel mounting	(66)	
			 1863 869 028		632.246		
		OM470/471		3400 700 537 	430 18	XTend 632.450 Nabenprofil / Hub Profile: 45x50-18N Nur zusammen verbauen / Only install together	(48) (53)
					3400 700 531 	430 18	XTend Getr. / GBox: Powershift 632.450 Nabenprofil / Hub Profile: 45x50-18N Nur zusammen verbauen / Only install together
				3400 710 071 	430 18	Getr. / GBox: Powershift 632.450 Nabenprofil / Hub Profile: 45x50-18N mit automatischer Nachstellung / with automatic adjustment Nur zusammen verbauen / Only install together	(48) (95) (53)
				 3151 001 082 		KZISZ-5 632.450	
		OM470	 6594 000 218	430	632.450		
		OM471	 6594 000 219	430	632.450		
		Travego M	01.05-	OM457LA	 3400 700 509 	430 10	XTend 632.246 Nabenprofil / Hub Profile: 41,1x50,8-10N Nur zusammen verbauen / Only install together
 6594 000 079	430 430Z				für / for: SA 522019-15 632.246 enthält Schwungradbefestigungsschrauben / includes bolt for flywheel mounting	(66)	
 1863 869 028					632.246		
OM470/471				3400 700 537 	430 18	XTend 632.430 Nabenprofil / Hub Profile: 45x50-18N Nur zusammen verbauen / Only install together	(48) (53)
					3400 700 531 	430 18	XTend Getr. / GBox: Powershift 632.430 Nabenprofil / Hub Profile: 45x50-18N Nur zusammen verbauen / Only install together
				3400 710 071 	430 18	Getr. / GBox: Powershift 632.430 Nabenprofil / Hub Profile: 45x50-18N mit automatischer Nachstellung / with automatic adjustment Nur zusammen verbauen / Only install together	(48) (95) (53)
				 3151 001 082 		KZISZ-5 632.430	
OM470	 6594 000 218			430	632.430		
OM471	 6594 000 219			430	632.430		
O 580-15 RH/RHD 629.001 632.006 632.010 629.011 O 580-15 RH/RHD 629.011 629.001 O 580-15 RHD 629.001 632.010 629.011	10.99-			OM457.940, OM457.936, OM457.961, OM457.938, OM457.944, OM457.953	 3482 081 233	430	629.001/011 je nach Ausführung, mit unterschiedlicher Kupplung / depending on version, with different clutch
	10.99-	 1878 080 034	430 10 430WGTZ		629.001/011 je nach Ausführung, mit unterschiedlicher Kupplung / depending on version, with different clutch	(85)	
	10.99-	 3151 000 335			KZIZ-5 629.001/011 je nach Ausführung, mit unterschiedlicher Kupplung / depending on version, with different clutch	(85)	
		 3400 700 509 	430 10		XTend 629.001 Nabenprofil / Hub Profile: 41,1x50,8-10N je nach Ausführung, mit unterschiedlicher Kupplung / depending on version, with different clutch Nur zusammen verbauen / Only install together	(48) (85) (53)	
		OM502	 1878 080 037		430 10 430WGTZ	629.011	
		OM457HLA,	 6594 000 079		430	für OE-Nummer / for OE number 457 030 13 05	(83)



		CODE				
---	--	------	--	---	---	---





MERCEDES-BENZ



O 580 (TRAVEGO)		10.99 -					
O 580-16 RHD 629.015		OM457.944	 3400 700 509 ■	430 10	XTend Nabenprofil / Hub Profile: 41,1x50,8-10N Nur zusammen verbauen / Only install together	(48) (53)	
			 1863 869 028				
O 580-16 RHD 629.015		OM457	 6594 000 079	430 430Z	für / for: SA 522019-08/15 enthält Schwungradbefestigungsschrauben / includes bolt for flywheel mounting	(69) (66)	
			 1863 869 028				
O 580-16 RHD 629.015		OM542.948	 3400 700 509 ■	430 10	XTend Nabenprofil / Hub Profile: 41,1x50,8-10N Nur zusammen verbauen / Only install together	(48) (53)	
			 1863 869 028				
O 580-16 RHD, O 580-17 RHD 629.012 632.005 632.007 O 580-17 RHD 632.012 629.012 O 580-17 RHD 629.012 632.012 632.007 632.005	10.99 -	OM542.966, OM542.948, OM457.944	 3482 081 233	430	629.012		
	10.99 -		 3151 000 335	MFZ430 KZIZ-5	629.012		
	10.99 -		 1878 080 034	430 10 430WGTZ	629.012		
			 1878 080 037	430 10 430WGTZ	629.012		
			 6594 000 079	430 430Z	für OE-Nummer / for OE number 457 030 13 05 enthält Schwungradbefestigungsschrauben / includes bolt for flywheel mounting	(83) (66)	
O 608							
LPO 608 314.087 314.085/086	10.69 - 10.77	OM314	 1800 125 201	250 10	Mot. 410748-> 314.051-060/062-063/072/085-087		
			 1882 205 234	HBX250			
			 1861 291 136	250GTZ			
			 3151 095 043	KZI-3	->Chass. 4282707 314.051-060/062-063/072/085-087		
			 3151 033 031	KZI-3	Chass. 4282708 - Mot. 410747 314.051-060/062-063/072/085-087		
O 709							
LPO 709 314.085 314.087 314.086	11.77 - 12.84	OM314	 1800 125 201	250 10	Mot. 678175-> 314.072/077/085-086-087		
			 1882 205 234	HBX250			
			 1861 291 136	250GTZ			
			 3151 095 043	KZI-3	->Chass. 4282707 314.072/077/085-086-087		
			 3151 033 031	KZI-3	Chass. 4282708 - Mot. 678174 314.072/077/085-086-087		
O 812							
O 812 D Vario 670.373/374	01.96 -	OM602LADE	 3000 725 001	250 26			
			 3082 269 031	M250			
			 1864 504 031	250B			
			 3000 951 785 ●	250 26			
			 3082 269 031	M250			
			 1878 600 501	250CD			
			 2294 000 525	250	enthält Schwungradbefestigungsschrauben / includes bolt for flywheel mounting	(66)	
		OM904LA	 3400 127 701 ☉	362 18			
	 3482 000 462		MF362				
	 1878 052 842		362WGTB				
			 3400 700 484 ☉	362 18			
			 3482 000 462	MF362			
			 1878 006 757	362WGTB			
			 3151 000 396	KZIS-4			
O 814							
O 814, O 814 L 674.079 674.277/278	01.84 - 12.98	OM364LA	 3482 008 038	310	674.079/277-278		
			 1862 299 032	MF310			
			 3151 044 031	310 10 310WGSZ	674.079/277-278		
				KZI-3	674.079/277-278		

		CODE				
---	--	------	--	---	---	---





MERCEDES-BENZ







O 814						
814 O, 814 LO 674.272/273 674.072/073	01.84 - 12.98	OM366		3400 122 401 ⊗ 3482 008 038 ⊗ 1861 964 034 ⊙ 3151 044 031	310 10 MF310 310WGSZ KZI-3	674.072-073/272-273
				3400 124 301 ⊗ 3482 012 211 ⊗ 1861 963 033 ⊙ 3151 044 031	330 10 GMF330 330WGSZ KZI-3	674.072-073/079/277-278

O 817						
817 LO 676.464	03.96 - 12.98	OM904LA		3400 121 401 ⊗ 3482 000 462 ⊗ 1878 052 842 ⊙ 3151 000 374	362 18 MF362 362WGVB KZIS-4	676.464
				1878 001 939 HD●	362 18 362WGVB	676.464
817 O, 817 LO 676.263 676.063 676.264	01.84 - 12.98	OM366A		3482 012 240	330 GMF330	676.063/263-264
				1861 963 033	330 10 330WGSZ	676.063/263-264
				3151 044 031	KZI-3	676.063/263-264

O 914						
O 914 674.077		OM366		3400 122 401 ⊗ 3482 008 038 ⊗ 1861 964 034 ⊙ 3151 044 031	310 10 MF310 310WGSZ KZI-3	674.077
				3400 124 301 ⊗ 3482 012 211 ⊗ 1861 963 033 ⊙ 3151 044 031	330 10 GMF330 330WGSZ KZI-3	674.077 Sonderausführung / Special design

O 1114						
O 1114 ,O 1114 L 675.273/274 675.074 675.073	01.84 - 12.98	OM366		3400 122 401 ⊗ 3482 008 038 ⊗ 1861 964 034 ⊙ 3151 044 031	310 10 MF310 310WGSZ KZI-3	675.073-074/273-274

O 1117						
1117 LO 676.476	03.96 - 12.98	OM904LA		3400 121 401 ⊗ 3482 000 462 ⊗ 1878 052 842 ⊙ 3151 000 374	362 18 MF362 362WGVB KZIS-4	676.476
				1878 001 939 HD●	362 18 362WGVB	676.476
1117 O,1117 LO 676.074 676.273 676.276 676.073 676.274	01.84 - 12.98	OM366.971, OM356.949, OM357.919		3482 000 953	350 GMF350X	676.073-074/273-274/276
				1878 001 144	350 10 350WGTZ	676.073-074/273-274/276
				3151 000 374	KZIS-4	676.073-074/273-274/276

O 1120						
1120 O,1120 LO 677.273 677.276 677.074 677.274 677.073 677.275	01.84 - 12.98	OM366LA		3482 000 953	350 GMF350X	676.073-074/273-274 677.073-074/273-274
				1878 001 070	350 10 350GTZ	676.073-074/273-274 677.073-074/273-274
				3151 000 374	KZIS-4	676.073-074/273-274 677.073-074/273-274
				1882 166 737	380 GF380	677.276
				1878 000 105	380 10 380GTZ	677.276
				3151 000 374	KZIS-4	677.276

O 3500						
O 3500 ,S				1860 062 037 #	280 10 280Z	





























		CODE				
---	--	------	--	---	---	---

MERCEDES-BENZ





























O 5500						
O 5500				1861 034 147 #	350 10	

O 6600						
O 6600				1881 039 532 #	350 G350KR	Chass. 0154/54->
				1861 034 147 #	350 10	

OF Series 01.83 -

OF 1113 358.082 358.080				1882 305 131	310 GFX310	358.080/082
				1861 303 248	310 10 310GSB	358.080/082
				3151 095 043	KZI-3	358.080/082
OF 1113 (358)				1861 632 032	280 10 280W2GSZ	
OF 1113 B				1882 252 331	310 GFX310	
				1861 303 248	310 10 310GSB	
OF 1313 352.068/069		OM352		1882 252 331	310 GFX310	->Chass. 922885 352.068-069
				1882 305 131	310 GFX310	Chass. 922886-> 352.068-069
				1861 303 248	310 10 310GSB	352.068-069
				3151 095 043	KZI-3	352.068-069
				1882 201 132	295 GF295	
				1861 279 133	295 10 295GTZ	
OF 1317 352.088/089		OM327, 360		1882 234 433	350 GF350	Chass. 797910-> 352.088-089
				1878 001 074	350 10 350GTZ	352.088-089
				3151 094 041	KZI-4	352.088-089
OF 1413 352.067		OM352		1882 252 331	310 GFX310	->Chass. 922885 352.067
				1882 305 131	310 GFX310	Chass. 922886-> 352.067
				1861 303 248	310 10 310GSB	352.067
				3151 095 043	KZI-3	352.067
OF 1417 352.097		OM360		1878 001 074	350 10 350GTZ	->Chass. 797909 352.097
				3151 094 041	KZI-4	->Chass. 797909 352.097
		OM327, 360		1882 234 433	350 GF350	Chass. 797910-> 352.097
				1878 001 074	350 10 350GTZ	Chass. 797910-> 352.097
				3151 094 041	KZI-4	Chass. 797910-> 352.097
OF 1617 355.098		OM360		1882 234 433	350 GF350	Chass. 797910->
				1878 001 074	350 10 350GTZ	
				3151 094 041	KZI-4	
OF 1621 355.099		OM360A		1882 166 737	380 GF380	355.099
				1861 470 234	380 10 380GSZ	355.099
				3151 090 131	KZI-4.5	355.099

MERCEDES-BENZ

OH-Serie							
OH 1416 396.341		OM366A		3400 125 001 ⊗ 3482 000 953 ⊗ 1878 001 070 ⊙ 3151 000 374	350 10 GMF350X 350GTZ KZIS-4	396.341	
OH 1417 396.346		OM366		3482 000 953	350 GMF350X	396.346	
				1878 001 070	350 10 350GTZ	396.346	
				3482 000 953 ●	350 GMF350X	396.346 Nur zusammen verbauen / Only install together	(53)
				1878 001 144 ●	350 10 350WGTZ	396.346 Nur zusammen verbauen / Only install together	(53)
				3151 000 374	KZIS-4	396.346	
		OM366A		3482 000 953	350 GMF350X	396.346	
				1878 001 070	350 10 350GTZ	396.346	
				3151 000 374	KZIS-4	396.346	
OH 1622 ,L 396.458 396.356 396.456 396.358		OM421		1882 302 131	380 GF380	->Chass. 6 901320 ->Chass. 5 418584 396.356/358/456/458	
				1861 923 032 #	380 10 380WGSZ	->Chass. 6 901320 ->Chass. 5 418584 396.356/358/456/458	
				3482 124 541	430 GMF430	Chass. 6 901321-> Chass. 5 418585-> 396.356/358/456/458	
				1882 301 238 ●#	420 GF420	Chass. 6 901321-> Chass. 5 418585-> 396.356/358/456/458	
				1878 003 657	420 10 420WGTZ	Chass. 6 901321-> Chass. 5 418585-> 396.356/358/456/458	
				3151 126 031	KZI-4,5	396.356/358/456/458	
OH 1625 ,L 396.476 396.378 396.376 396.478		OM422		3482 124 534	430 GMF430	396.376/378/476/478	
				1882 301 239 ●	420 GF420	396.376/378/476/478	
				1878 003 657	420 10 420WGTZ	396.376/378/476/478	
				3151 126 031	KZI-4,5	396.376/378/476/478	
OH 1627 L 396.473 396.471		OM422		3400 124 101 ⊗ 3482 081 232 ⊗ 1878 005 668 ⊙ 3151 000 549	430 10 MFZ430 430WGTZ KZISZ-5	396.471/473	
OH 1628 ,L 396.388 396.488 396.386 396.486		OM422		3482 124 534	430 GMF430	396.386/388/486/488	
				1882 301 239 ●	420 GF420	396.386/388/486/488	
				1878 003 657	420 10 420WGTZ	396.386/388/486/488	
				3151 126 031	KZI-4,5	396.386/388/486/488	
OH 1634 L 396.483		OM442A		3400 122 601 ⊗ 3482 081 231 ⊗ 1878 080 037 ⊙ 3151 000 278	430 10 MFZ430 430WGTZ KZISZ-5	->Chass. Z 902592 ->Chass. K 017131 396.483	
				3482 081 231	430 MFZ430	Chass. Z 902593-> Chass. K 017132-> 396.483	
				1878 080 037	430 10 430WGTZ	Chass. Z 902593-> Chass. K 017132-> 396.483	
				3151 000 547	KZISZ-5	Chass. Z 902593-> Chass. K 017132-> 396.483	
			3189 600 059				



















		CODE				
---	--	------	--	---	---	---

MERCEDES-BENZ

OP 311 - OP 330						
OP 311				1860 062 037 #	280 10 280Z	
OP 312				1861 919 134	280 10 280GTZ	
OP 315 OP 330				1881 039 532 #	350 G350KR	
				1861 034 147 #	350 10	

NEOPLAN































Centroliner 10.98 -						
Centroliner N 4426/3L		D2866LOH, 265kw, D2866LOH, 301kw		6594 000 124	430 430Z	enthält Schwungradbefestigungsschrauben / includes bolt for flywheel mounting (66)
				3482 083 032	430 MFZ430	
				1878 085 641	430 10 430GTZ	
				3151 000 157	KZISZ-5	

Cityliner 04.73 -						
Cityliner		DAFDKT1160		3482 124 550	430 GMF430	
				3482 006 036 ●#	420 GTF420	
		MAND2538MTA		3482 124 534	430 GMF430	
				1882 301 239 ●	420 GF420	
				1878 001 138	420 10 420GTZ	
		MAND2866LXO H		1882 342 134	420 GF420X	
				1878 003 657	420 10 420WGTZ	
				3151 119 001	KZI-4,5	
		OM402LA		1888 055 247	380 GF2/380	enthält eine Kupplungsscheibe / This part number includes one clutch disc (67)
				1862 123 131 ▽	380 10 380GV	Lose Kupplungsscheibe / Loose clutch disc (41)
				3151 186 001	KZI-4,5	
				1882 349 003	380 GF2/380	In 1888 enthalten / Contained in 1888 (31)
				1859 250 100	380 GF2/380	In 1888 enthalten / Contained in 1888 (31)
				1862 122 132 △	380 10 380GVZ	In 1888 enthalten / Contained in 1888 (31)
Cityliner N 1116		D2866LOH, 301kw, D2876LOH, 338kw		6594 000 124	430 430Z	Getr. / GBox: ZF 8S-180 Getr. / GBox: ZF AS-Tronic enthält Schwungradbefestigungsschrauben / includes bolt for flywheel mounting (66)
				3482 083 032	430 MFZ430	Getr. / GBox: ZF 8S-180 Getr. / GBox: ZF AS-Tronic
				1878 085 641	430 10 430GTZ	Getr. / GBox: ZF 8S-180 Getr. / GBox: ZF AS-Tronic
				3151 000 157	KZISZ-5	Getr. / GBox: ZF 8S-180 Getr. / GBox: ZF AS-Tronic





		CODE				
---	--	------	--	---	---	---

NEOPLAN

Cityliner 04.73 -

N 1216 HD N 1217 HD N 1218 HD	09.06 -	D2066LOH07/0 8/10/28, D2066LUH09/2 4/34		3400 700 505 ■	430 10	XTend Getr. / GBox: ZF 6S Nabenprofil / Hub Profile: 41,1x50,8-10N Nur zusammen verbauen / Only install together	(48) (53)
		D2066LOH07/0 8/10/28, D2066LUH09/2 4/34, D2676LOH10/2 6		3400 700 511 ■	430 10	XTend Getr. / GBox: GO 210-6 Nabenprofil / Hub Profile: 41,1x50,8-10N Nur zusammen verbauen / Only install together	(48) (53)
		D2066LOH07/0 8/10, D2066LOH28/3 2, D2676LOH10/2 6/30		3482 083 032	430 MFZ430	Getr. / GBox: GO 210-6	
				1878 080 037	430 10 430WGTZ	Getr. / GBox: GO 210-6	
				3151 000 335	KZISZ-5	Getr. / GBox: GO 210-6	
		D2066LOH07/0 8/10, D2066LOH28/3 2, D2066LUH09/2 4/34/53, D2676LOH10/2 6/30		3400 700 381  3482 000 361  1878 080 037  3151 000 493	430 10 MFZ430 430WGTZ KZISZ-5	Getr. / GBox: AS-Tronic für Ausrückgabel mit Rollen / for release fork with rollers	(71)
				3482 000 361	430 MFZ430	Getr. / GBox: AS-Tronic für Ausrückgabel mit Nocken / for release fork with cams	(70)
				1878 080 037	430 10 430WGTZ	Getr. / GBox: AS-Tronic für Ausrückgabel mit Nocken / for release fork with cams	(70)
				3151 000 144	KZISZ-5	Getr. / GBox: AS-Tronic für Ausrückgabel mit Nocken / for release fork with cams	(70)
		D2066LOH07/0 8/28, D2676LOH26		6594 000 121	430 430Z	Getr. / GBox: GO 210-6	
		D2066LOH07/2 8		6594 000 121	430 430Z	Getr. / GBox: ZF 6S	
		D2066LOH03		1863 869 038			
				3189 600 004		Getr. / GBox: ZF AS Tronic Rollenausführung / roller version	(58)
		N 1216 HDC	09.06 -	D2066LUH03/0 4/10, D2066LUH14/1 5/09, D2676LOH01/1 0		3400 700 509 ■	430 10
				3400 700 510 ■	430 10	XTend Getr. / GBox: ZF 6S-85 Nabenprofil / Hub Profile: 38,2x44,5-10N Nur zusammen verbauen / Only install together	(48) (53)
				3400 700 403  3482 000 361  1878 004 832  3151 000 144	430 10 MFZ430 430WGTZ KZISZ-5	Getr. / GBox: AS-Tronic für Ausrückgabel mit Nocken / for release fork with cams	(70)
				3400 700 450  3482 000 361  1878 004 832  3151 000 493	430 10 MFZ430 430WGTZ KZISZ-5	Getr. / GBox: AS-Tronic für Ausrückgabel mit Rollen / for release fork with rollers	(71)
D2676LOH02				3400 700 459 HD  3482 000 246  1878 004 104  3151 000 493	430 10 MFZ430 430WGTZ KZISZ-5	Getr. / GBox: AS-Tronic für Ausrückgabel mit Rollen / for release fork with rollers	(71)
D2066LOH04				3189 600 004		Getr. / GBox: ZF AS Tronic Rollenausführung / roller version	(58)

Clubstar

Clubstar		OM366		3400 122 401  3482 008 038  1861 964 034  3151 044 031	310 10 MF310 310WGSZ KZI-3		
----------	--	-------	---	--	--	--	--









Euroliner 07.97 -

N 3312 K / U N 3313 U		OM501LA		6594 000 080	430 430Z	Getr. / GBox: ZF 6S-1600 enthält Schwungradbefestigungsschrauben / includes bolt for flywheel mounting	(66)
				3482 083 032	430 MFZ430	Getr. / GBox: ZF 6S-1600	
				1878 085 641	430 10 430GTZ	Getr. / GBox: ZF 6S-1600	
				3151 000 157	KZISZ-5	Getr. / GBox: ZF 6S-1600	

















		CODE					
---	--	------	--	--	---	---	---

NEOPLAN

Euroliner 07.97 -

N 3316 KL, N 3316 ÜL	D2866LUH25, 265kw		6594 000 124	430 430Z	Getr. / GBox: ZF 6S-1600 Getr. / GBox: ZF AS-Tronic enthält Schwungradbefestigungsschrauben / includes bolt for flywheel mounting (66)	
				3482 083 032	430 MFZ430	Getr. / GBox: ZF 6S-1600 Getr. / GBox: ZF AS-Tronic
				1878 085 641	430 10 430GTZ	Getr. / GBox: ZF 6S-1600 Getr. / GBox: ZF AS-Tronic
				3151 000 157	KZISZ-5	Getr. / GBox: ZF 6S-1600 Getr. / GBox: ZF AS-Tronic
N 3316 Ü, N 3316 K	D2866LUH30, 301kw		6594 000 124	430 430Z	Getr. / GBox: ZF 8S-180 Getr. / GBox: ZF AS-Tronic enthält Schwungradbefestigungsschrauben / includes bolt for flywheel mounting (66)	
				3482 083 032	430 MFZ430	Getr. / GBox: ZF 8S-180 Getr. / GBox: ZF AS-Tronic
				1878 085 641	430 10 430GTZ	Getr. / GBox: ZF 8S-180 Getr. / GBox: ZF AS-Tronic
				3151 000 157	KZISZ-5	Getr. / GBox: ZF 8S-180 Getr. / GBox: ZF AS-Tronic











Jetliner 09.73 - 09.93

Jetliner	DAFDKT1160		3482 124 550	430 GMF430			
				3482 006 036 ●#	420 GTF420		
				MAND2538MTA	3482 124 534	430 GMF430	
						1882 301 239 ●	420 GF420
N 209 Jetliner N 212 Jetliner	D2066LOH07/0 8/10, D2066LOH28/3 2, D2066LUH09/2 4/34/53, D2676LOH10/2 6/30		3400 700 381	430 10 MFZ430	Getr. / GBox: AS-Tronic für Ausrückgabel mit Rollen / for release fork with rollers (71)		
				3482 000 361	430 MFZ430	Getr. / GBox: AS-Tronic für Ausrückgabel mit Nocken / for release fork with cams (70)	
				1878 080 037	430 10 430WGTZ	Getr. / GBox: AS-Tronic für Ausrückgabel mit Nocken / for release fork with cams (70)	
				3151 000 493	KZISZ-5	Getr. / GBox: AS-Tronic für Ausrückgabel mit Nocken / for release fork with cams (70)	
	D2066LOH06/1 2/27/31, D2066LUH07/0 8/22/23, D2066LUH32/3 3/47/48, D2066LUH51/5 2		3482 000 361	430 MFZ430	Getr. / GBox: AS-Tronic für Ausrückgabel mit Rollen / for release fork with rollers (71)		
				1878 080 034	430 10 430WGTZ	Getr. / GBox: AS-Tronic für Ausrückgabel mit Rollen / for release fork with rollers (71)	
				3151 000 493	KZISZ-5	Getr. / GBox: AS-Tronic für Ausrückgabel mit Rollen / for release fork with rollers (71)	
				3482 000 361	430 MFZ430	Getr. / GBox: AS-Tronic für Ausrückgabel mit Nocken / for release fork with cams (70)	
				1878 080 034	430 10 430WGTZ	Getr. / GBox: AS-Tronic für Ausrückgabel mit Nocken / for release fork with cams (70)	
				3151 000 144	KZISZ-5	Getr. / GBox: AS-Tronic für Ausrückgabel mit Nocken / for release fork with cams (70)	
				1863 869 038			
		3189 600 004		Getr. / GBox: ZF AS Tronic Rollenausführung / roller version (58)			



















		CODE					
---	--	------	--	--	---	---	---

NEOPLAN

Megaliner 01.93 -











Megaliner	DAFDKT1160		3482 124 550	430 GMF430			
			3482 006 036 ●#	420 GTF420			
		MAND2866LXO H		1882 342 134	420 GF420X		
				1878 003 657	420 10 420WGTZ		
				3151 119 001	KZI-4,5		
		OM442LA		3488 017 410	400 MFZ2/400X	enthält eine Kupplungsscheibe / This part number includes one clutch disc	(67)
			1878 005 805 ▽	400 10 400GTZ			
			1878 634 022 ▽#	400 10 400GVZ			
			3151 000 157	KZISZ-5			
			1878 005 805 △	400 10 400GTZ			
			1878 634 023 △	400 10 400GVZ			



















Motoren

Motor / Engine - DAF	DKA1160		1861 206 211 #	420 10 420GS			
		DKT1160		3482 124 550	430 GMF430		
				3482 006 036 ●#	420 GTF420		
Motor / Engine - Daimler Chrysler	OM402		1882 302 131	380 GF380	Je nach Kundenwunsch mit unterschiedlicher Kupplung / Equipped with different clutch according to customer requirement	(35)	
			1878 001 152	380 10 380WGTZ			
			3482 124 534	430 GMF430	Je nach Kundenwunsch mit unterschiedlicher Kupplung / Equipped with different clutch according to customer requirement	(35)	
			1882 301 239 ●	420 GF420	Je nach Kundenwunsch mit unterschiedlicher Kupplung / Equipped with different clutch according to customer requirement	(35)	
			1878 002 706	420 10 420GTZ			
	OM407		3482 124 541	430 GMF430			
			1882 301 238 ●#	420 GF420			
			1878 001 136	420 10 420GTZ			
	OM421		1882 302 131	380 GF380			
			1878 000 105	380 10 380GTZ			
			1878 001 152 ●	380 10 380WGTZ			
	OM457HLA		6594 000 079	430 430Z	Getr. / GBox: 8 S 180; 10 AS 2301 Getr. / GBox: GO 190/210 für OE-Nummer / for OE number 457 030 13 05 enthält Schwungradbefestigungsschrauben / includes bolt for flywheel mounting	(83) (66)	
OM501LA, OM502LA		6594 000 080	430 430Z	Getr. / GBox: 8 S 180; 10 AS 2301 für OE-Nummer / for OE number 541 030 03 05 enthält Schwungradbefestigungsschrauben / includes bolt for flywheel mounting	(83) (66)		
Motor / Engine - Henschel	561-17, 562-18		1881 039 531 #	350 G350			
	523-23		1861 206 211 #	420 10 420GS			

		CODE				
---	--	------	--	---	---	---

NEOPLAN

Motoren						
Motor / Engine - MAN	D2530MH, D2538MTH		3482 124 534	430 GMF430		
			1882 301 239 ●	420 GF420		
			1878 002 706	420 10 420GTZ		
	D2538MH		1882 302 131	380 GF380		
			1878 001 152	380 10 380WGTZ		
	D2566MTH		3482 124 550	430 GMF430		
			3482 006 036 ●#	420 GTF420		
			1878 002 706	420 10 420GTZ		
			1878 003 657 ●	420 10 420WGTZ		
	D2866LOH24, D2866LOH25, D2866LOH28, D2866LOH29, D2866LUH, D2876LOH, D2876LOH02, D2876LUH		6594 000 124	430 430Z	Getr. / GBox: 8 S 180; 10 AS 2301 für OE-Nummer / for OE number 11068877 enthält Schwungradbefestigungsschrauben / includes bolt for flywheel mounting	(83) (66)

N 113 - N 116						
N 113	OM402LA, 442LA		3400 700 379 ● 3482 083 032 ● 1878 004 832 ◦ 3151 000 157	430 10 MFZ430 430WGTZ KZISZ-5		
			3482 083 118	430 MFZ430		
			1878 004 832	430 10 430WGTZ		
N 116	OM403		1800 125 301 ● 1882 301 239 ● 1878 002 706 ◦ 3151 000 375	420 10 GF420 420GTZ KZIS-4		
			3482 124 534	430 GMF430		
			1878 003 657	420 10 420WGTZ		
			3151 000 375	KZIS-4		
			1882 342 134	420 GF420X		
N 116	OM403		3482 124 516	430 GMF430		
			1878 002 706	420 10 420GTZ		
			1878 003 657 ●	420 10 420WGTZ		
N 116	OM402LA, 442LA		3400 700 379 ● 3482 083 032 ● 1878 004 832 ◦ 3151 000 157	430 10 MFZ430 430WGTZ KZISZ-5		
N 116	OM442LA		3488 017 410	400 MFZ2/400X	enthält eine Kupplungsscheibe / This part number includes one clutch disc	(67)
			1878 005 805 ▽	400 10 400GTZ		
			1878 634 022 ▽#	400 10 400GVZ		
			3151 000 157	KZISZ-5		
			1878 005 805 △	400 10 400GTZ		
			1878 634 023 △	400 10 400GVZ		



CODE



SACHS

Parameter



NEOPLAN

N 113 - N 116

N 116	BF6M1015C, D2876LOH01, MAND2866LOH 23		3400 700 379 ⊗ 3482 083 032 ⊗ 1878 004 832 ⊙ 3151 000 157	430 10 MFZ430 430WGTZ KZISZ-5			
	DAFDKA1160V		1861 206 211 #	420 10 420GS			
	HS6R1315-524- 24		1861 206 211 #	420 10 420GS			
	OM422			1800 125 301 ⊗ 1882 301 239 ⊗ 1878 002 706 ⊙ 3151 000 375	420 10 GF420 420GTZ KZIS-4		
				3482 124 534	430 GMF430		
				1878 003 657	420 10 420WGTZ		
				3151 000 375	KZIS-4		
	OM442A			3482 119 031	430 GMF430		
				3482 018 132 ●#	420 GMF420		
				1878 086 941	420 10 420WGTZ		
				3151 202 002	KZI-4,5		
	MAND2566MTH			3482 124 534	430 GMF430		
				1882 301 239 ●	420 GF420		
				1878 001 138	420 10 420GTZ		













N 117 - N 120

N 117 N 120	OM403		1800 125 301 ⊗ 1882 301 239 ⊗ 1878 002 706 ⊙ 3151 000 375	420 10 GF420 420GTZ KZIS-4		
			3482 124 534	430 GMF430		
			1878 003 657	420 10 420WGTZ		
			3151 000 375	KZIS-4		
N 117 N 120	OM403		3482 124 516	430 GMF430		
			1878 002 706	420 10 420GTZ		
			1878 003 657 ●	420 10 420WGTZ		
N 117 N 118	OM442LA		3400 700 379 ⊗ 3482 083 032 ⊗ 1878 004 832 ⊙ 3151 000 157	430 10 MFZ430 430WGTZ KZISZ-5		
			3488 017 410	400 MFZ2/400X	enthält eine Kupplungsscheibe / This part number includes one clutch disc	(67)
N 117 N 118	OM442LA		1878 005 805 ▽	400 10 400GTZ		
			1878 634 022 ▽#	400 10 400GVZ		
			3151 000 157	KZISZ-5		
			1878 005 805 △	400 10 400GTZ		
			1878 634 023 △	400 10 400GVZ		















		CODE				
---	--	------	--	---	---	---

NEOPLAN

N 117 - N 120















N 117		D2876LOH01, MAND2866LOH 23		3400 700 379 ⊗ 3482 083 032 ⊗ 1878 004 832 ⊙ 3151 000 157	430 10 MFZ430 430WGTZ KZISZ-5		
		OM422A		1882 342 134	420 GF420X		
				1878 003 657	420 10 420WGTZ		
		OM442A		3482 119 031	430 GMF430		
				3482 018 132 ●#	420 GMF420		
				1878 086 941	420 10 420WGTZ		
				3151 202 002	KZI-4,5		
		N 118		D2876LOH01, MAND2866LOH 23		3400 700 379 ⊗ 3482 083 032 ⊗ 1878 004 832 ⊙ 3151 000 157	430 10 MFZ430 430WGTZ KZISZ-5
OM442A				3482 119 031	430 GMF430		
				3482 018 132 ●#	420 GMF420		
				1878 086 941	420 10 420WGTZ		
				3151 202 002	KZI-4,5		

N 121 - N 128





N 121 N 122		OM403		1800 125 301 ⊗ 1882 301 239 ⊗ 1878 002 706 ⊙ 3151 000 375	420 10 GF420 420GTZ KZIS-4		
				3482 124 534	430 GMF430		
				1878 003 657	420 10 420WGTZ		
				3151 000 375	KZIS-4		
N 121 N 122		OM403		3482 124 516	430 GMF430		
				1878 002 706	420 10 420GTZ		
				1878 003 657 ●	420 10 420WGTZ		
N 122		OM442LA		3400 700 379 ⊗ 3482 083 032 ⊗ 1878 004 832 ⊙ 3151 000 157	430 10 MFZ430 430WGTZ KZISZ-5		
N 122		OM442LA		3488 017 410	400 MFZ2/400X	enthält eine Kupplungsscheibe / This part number includes one clutch disc	(67)
				1878 005 805 ▽	400 10 400GTZ		
				1878 634 022 ▽#	400 10 400GVZ		
				3151 000 157	KZISZ-5		
				1878 634 023 △	400 10 400GVZ		
				1878 005 805 △	400 10 400GTZ		

NEOPLAN



N 121 - N 128

N 122	BF6M1015C, D2876LOH01, MAND2866LOH 23		3400 700 379  3482 083 032  1878 004 832  3151 000 157	430 10 MFZ430 430WGTZ KZISZ-5				
	DAFDKA1160V		1861 206 211 #	420 10 420GS				
	HS6R1315-524- 24		1861 206 211 #	420 10 420GS				
	OM423			3482 124 516	430 GMF430			
					1878 002 706	420 10 420GTZ		
					1878 003 657 ●	420 10 420WGTZ		
	OM442			1888 055 247	380 GF2/380	enthält eine Kupplungsscheibe / This part number includes one clutch disc	(67)	
					1862 123 131 ▽	380 10 380GV	Lose Kupplungsscheibe / Loose clutch disc	(41)
					3151 186 001	KZI-4,5		
					1882 349 003	380 GF2/380	In 1888 enthalten / Contained in 1888	(31)
					1859 250 100	380 GF2/380	In 1888 enthalten / Contained in 1888	(31)
				1862 122 132 △	380 10 380GVZ	In 1888 enthalten / Contained in 1888	(31)	

N 138 - N 140

N 138		OM403		3482 124 516	430 GMF430		
					1878 002 706	420 10 420GTZ	
					1878 003 657 ●	420 10 420WGTZ	
N 138		OM404		1882 342 134	420 GF420X		
					1878 003 657	420 10 420WGTZ	

N 202 - N 209

N 202		MAN0226MC		3482 060 233	350 MF350	
					1861 777 037	350 10 350GTD



CODE



SACHS

Parameter



NEOPLAN

N 202 - N 209

N 208	MAND0226MC	3482 060 233	350 MF350		
		1861 777 037	350 10 350GTD		
		3151 199 001	KZIS-3		
	OM366LA	3482 000 463	395 MF395		
		1862 506 131	395 10 395WGTZ		
		3151 202 002	KZI-4,5		
	OM352	1882 252 331	310 GFX310		
		1861 303 248	310 10 310GSB		
	OM366	3482 002 234	350 GMF350X		
		1878 001 077	350 10 350GTZ		
		3151 068 101	KZI-3		
	MAND0826LOH 17, 18	3482 000 463	395 MF395		
		1862 506 131	395 10 395WGTZ		
		3151 000 419	KZIS-4		
	N 209	OM401	1882 311 131 #	350 GF350	Je nach Kundenwunsch mit unterschiedlicher Kupplung / Equipped with different clutch according to customer requirement
1878 001 070			350 10 350GTZ		
3482 124 534			430 GMF430	Je nach Kundenwunsch mit unterschiedlicher Kupplung / Equipped with different clutch according to customer requirement	(35)
1882 301 239 ●			420 GF420	Je nach Kundenwunsch mit unterschiedlicher Kupplung / Equipped with different clutch according to customer requirement	(35)
1878 002 706			420 10 420GTZ		
OM422		1800 125 301	420 10 GF420		
		1882 301 239	420GTZ		
		1878 002 706	KZIS-4		
		3151 000 375			
3482 124 534	430 GMF430				
1878 003 657	420 10 420WGTZ				
3151 000 375	KZIS-4				

N 210 - N 213

N 210	OM352	1882 252 331	310 GFX310		
		1861 303 248	310 10 310GSB		



CODE



SACHS

Parameter



NEOPLAN

N 210 - N 213

N 210		N 213				
N 212	HS6R1112-562-18	1881 039 531 #	350 G350			
		1878 001 074	350 10 350GTZ			
	OM352	1882 252 331	310 GFX310			
		1861 303 248	310 10 310GSB			
	OM401	1882 311 131 #	350 GF350	Je nach Kundenwunsch mit unterschiedlicher Kupplung / Equipped with different clutch according to customer requirement	(35)	
		1878 001 070	350 10 350GTZ			
		3482 124 534	430 GMF430	Je nach Kundenwunsch mit unterschiedlicher Kupplung / Equipped with different clutch according to customer requirement	(35)	
		1882 301 239 ●	420 GF420	Je nach Kundenwunsch mit unterschiedlicher Kupplung / Equipped with different clutch according to customer requirement	(35)	
		1878 002 706	420 10 420GTZ			
	OM422	1800 125 301	420 10 GF420			
		1882 301 239	420GTZ			
		1878 002 706	KZIS-4			
		3482 124 534	430 GMF430			
		1878 003 657	420 10 420WGTZ			
	OM441LA	3482 083 118	430 MFZ430			
		1878 004 832	430 10 430WGTZ			
		3151 000 375	KZIS-4			
	N 213	HS6R1112-562-18	1881 039 531 #	350 G350		
			1878 001 074	350 10 350GTZ		
		OM401	1882 311 131 #	350 GF350	Je nach Kundenwunsch mit unterschiedlicher Kupplung / Equipped with different clutch according to customer requirement	(35)
1878 001 070			350 10 350GTZ			
3482 124 534			430 GMF430	Je nach Kundenwunsch mit unterschiedlicher Kupplung / Equipped with different clutch according to customer requirement	(35)	
1882 301 239 ●			420 GF420	Je nach Kundenwunsch mit unterschiedlicher Kupplung / Equipped with different clutch according to customer requirement	(35)	
1878 002 706			420 10 420GTZ			
OM422		1800 125 301	420 10 GF420			
		1882 301 239	420GTZ			
		1878 002 706	KZIS-4			
		3482 124 534	430 GMF430			
		1878 003 657	420 10 420WGTZ			
OM441LA		3482 083 118	430 MFZ430			
		1878 004 832	430 10 430WGTZ			
		3151 000 375	KZIS-5			



CODE



SACHS

Parameter

i



NEOPLAN

N 214 - N 216

N 214	OM422	1800 125 301 1882 301 239 1878 002 706 3151 000 375	420 10 GF420 420GTZ KZIS-4			
		3482 124 534	430 GMF430			
		1878 003 657	420 10 420WGTZ			
		3151 000 375	KZIS-4			
N 214	OM403	1800 125 301 1882 301 239 1878 002 706 3151 000 375	420 10 GF420 420GTZ KZIS-4			
		3482 124 534	430 GMF430			
		1878 003 657	420 10 420WGTZ			
		3151 000 375	KZIS-4			
	OM422A	1882 342 134	420 GF420X			
N 214	DAFDKA1160V	1861 206 211 #	420 10 420GS			
	HS6R1112-562-18	1881 039 531 #	350 G350			
		1878 001 074	350 10 350GTZ			
	D2876LOH01, MAND2866LOH 23	3400 700 379 3482 083 032 1878 004 832 3151 000 157	430 10 MFZ430 430WGTZ KZISZ-5			
		MAND2866LOH 26	3482 062 035	430 GMFZ430		
			1878 080 034	430 10 430WGTZ		
	3151 000 157		KZISZ-5			
	OM441LA	3482 083 118	430 MFZ430			
		1878 004 832	430 10 430WGTZ			
		3151 000 157	KZISZ-5			
OM442LA	3482 083 032	430 MFZ430				
	1878 004 832	430 10 430WGTZ				
	3151 000 157	KZISZ-5				
N 216	OM422	1800 125 301 1882 301 239 1878 002 706 3151 000 375	420 10 GF420 420GTZ KZIS-4			
		3482 124 534	430 GMF430			
		1878 003 657	420 10 420WGTZ			
		3151 000 375	KZIS-4			



CODE



SACHS

Parameter

i



NEOPLAN

N 214 - N 216

N 216	OM422	1800 125 301 1882 301 239 1878 002 706 3151 000 375	420 10 GF420 420GTZ KZIS-4		
		3482 124 534 ●	430 GMF430		
		1878 003 657 ●	420 10 420WGTZ		
		3151 000 375	KZIS-4		
	OM403	3482 124 516	430 GMF430		
		1878 002 706	420 10 420GTZ		
		1878 003 657 ●	420 10 420WGTZ		
OM422A	1882 342 134	420 GF420X			

N 216	OM402LA	3400 700 379 3482 083 032 1878 004 832 3151 000 157	430 10 MFZ430 430WGTZ KZISZ-5		
-------	---------	--	--	--	--

































N 216	DAFDKA1160V	1861 206 211 #	420 10 420GS		
	HS6R1315-524-24	1861 206 211 #	420 10 420GS		
	MAND2566MTH	3482 124 534	430 GMF430		
		1882 301 239 ●	420 GF420		
		1878 001 138	420 10 420GTZ		
	D2876LOH01, MAND2866LOH 23	3400 700 379 3482 083 032 1878 004 832 3151 000 157	430 10 MFZ430 430WGTZ KZISZ-5		
	MAND2866LOH 26	3482 062 035	430 GMFZ430		
		1878 080 034	430 10 430WGTZ		
		3151 000 157	KZISZ-5		
	F10L413	3482 124 534	430 GMF430		
		1882 301 239 ●	420 GF420		
		1878 003 320	420 10 420GTZ		
	OM441LA	3482 083 118	430 MFZ430		
		1878 004 832	430 10 430WGTZ		
		3151 000 157	KZISZ-5		
OM442LA	3482 083 032	430 MFZ430			
	1878 004 832	430 10 430WGTZ			
	3151 000 157	KZISZ-5			

N 218 - N 220

N 218	OM422	1800 125 301 1882 301 239 1878 002 706 3151 000 375	420 10 GF420 420GTZ KZIS-4		
		3482 124 534	430 GMF430		
		1878 003 657	420 10 420WGTZ		
		3151 000 375	KZIS-4		

		CODE				
---	--	------	--	---	---	---

NEOPLAN

N 218 - N 220						
N 218 N 220		OM403	 1800 125 301	420 10		
			 1882 301 239	GF420		
			 1878 002 706	420GTZ		
			 3151 000 375	KZIS-4		
		 3482 124 534	430			
				GMF430		
			 1878 003 657	420 10		
				420WGTZ		
			 3151 000 375	KZIS-4		
		OM422A	 1882 342 134	420		
				GF420X		
N 218 N 220		OM403	 3482 124 516	430		
				GMF430		
			 1878 002 706	420 10		
			 1878 003 657 ●	420 10		
				420WGTZ		
N 218		HS6R1315-524-24	 1861 206 211 #	420 10		
				420GS		
N 312 - N 314						
N 312		HS6R1112-562-18	 1881 039 531 #	350		
				G350		
			 1878 001 074	350 10		
				350GTZ		
		OM352	 1882 252 331	310		
				GFX310		
			 1861 303 248	310 10		
		310GSB				
OM441LA	 3482 083 118	430				
		MFZ430				
	 1878 004 832	430 10				
		430WGTZ				
	 3151 000 157	KZISZ-5				
N 313		OM401	 1882 311 131 #	350	Je nach Kundenwunsch mit unterschiedlicher Kupplung / Equipped with different clutch according to customer requirement	(35)
				GF350		
			 1878 001 070	350 10		
				350GTZ		
			 3482 124 534	430	Je nach Kundenwunsch mit unterschiedlicher Kupplung / Equipped with different clutch according to customer requirement	(35)
	GMF430					
 1882 301 239 ●	420	Je nach Kundenwunsch mit unterschiedlicher Kupplung / Equipped with different clutch according to customer requirement	(35)			
	GF420					
	 1878 002 706	420 10				
		420GTZ				
N 313	HS6R1112-562-18		 1881 039 531 #	350		
				G350		
		 1878 001 074	350 10			
			350GTZ			
	OM422	 1800 125 301	420 10			
		 1882 301 239	GF420			
 1878 002 706		420GTZ				
 3151 000 375		KZIS-4				
	 3482 124 534	430				
		GMF430				
	 1878 003 657	420 10				
		420WGTZ				
	 3151 000 375	KZIS-4				



CODE



Parameter



NEOPLAN

N 312 - N 314

N 314	DAFDKA1160V		1861 206 211 #	420 10 420GS	
	HS6R1112-562-18		1881 039 531 #	350 G350	
			1878 001 074	350 10 350GTZ	
	D2866LUH20, 21, MAND2866LOH 25, 26		3482 062 035	430 GMFZ430	
			1878 080 034	430 10 430WGTZ	
			3151 000 157	KZISZ-5	
	OM441LA		3482 083 118	430 MFZ430	
			1878 004 832	430 10 430WGTZ	
			3151 000 157	KZISZ-5	
	OM442LA		3400 700 379 ⊗ 3482 083 032 ⊗ 1878 004 832 ⊙ 3151 000 157	430 10 MFZ430 430WGTZ KZISZ-5	
	OM447hLA		3482 083 118	430 MFZ430	
			1878 085 742	430 10 430WGTZ	
		3151 000 157	KZISZ-5		
N 314	OM422		1800 125 301 ⊗ 1882 301 239 ⊗ 1878 002 706 ⊙ 3151 000 375	420 10 GF420 420GTZ KZIS-4	
			3482 124 534	430 GMF430	
			1878 003 657	420 10 420WGTZ	
			3151 000 375	KZIS-4	
N 314	OM403		1800 125 301 ⊗ 1882 301 239 ⊗ 1878 002 706 ⊙ 3151 000 375	420 10 GF420 420GTZ KZIS-4	
			3482 124 534	430 GMF430	
			1878 003 657	420 10 420WGTZ	
			3151 000 375	KZIS-4	
	OM422A		1882 342 134	420 GF420X	



CODE



SACHS

Parameter



NEOPLAN























N 316 - N 318

N 316	DAFDKA1160V		1861 206 211 #	420 10 420GS	
	HS6R1315-524-24		1861 206 211 #	420 10 420GS	
	DBOM401LA, MAND2865LUH 05		3482 083 118	430 MFZ430	
			1878 085 742	430 10 430WGTZ	
	MAND2865LOH , LUH07		3482 083 118	430 MFZ430	
			1878 004 832	430 10 430WGTZ	
			3151 000 157	KZISZ-5	
	D2866LOH25, 26, D2866LUH20, 21, D2876LUH01		3482 062 035	430 GMFZ430	
			1878 080 034	430 10 430WGTZ	
			3151 000 157	KZISZ-5	
	D2876LOH01, MAND2866LOH 23		3400 700 379	430 10 MFZ430	
			3482 083 032	430WGTZ	
			1878 004 832	KZISZ-5	
			3151 000 157		
	OM441LA		3482 083 118	430 MFZ430	
			1878 004 832	430 10 430WGTZ	
		3151 000 157	KZISZ-5		
OM442		1800 125 301	420 10 GF420		
		1882 301 239	420GTZ		
		1878 002 706	KZIS-4		
	3151 000 375				
	3482 124 534 ●	430 GMF430			
OM447HLA		3482 083 118	430 MFZ430		
		1878 085 742	430 10 430WGTZ		
		3151 000 157	KZISZ-5		
N 316	OM422		1800 125 301	420 10 GF420	
			1882 301 239	420GTZ	
			1878 002 706	KZIS-4	
			3151 000 375		
	3482 124 534	430 GMF430			
	1878 003 657	420 10 420WGTZ			
	3151 000 375	KZIS-4			
N 316	OM403		1800 125 301	420 10 GF420	
			1882 301 239	420GTZ	
			1878 002 706	KZIS-4	
			3151 000 375		
			3482 124 534	430 GMF430	
	1878 003 657	420 10 420WGTZ			
	3151 000 375	KZIS-4			
N 316 N 318	OM422A		1882 342 134	420 GF420X	
			3400 700 379	430 10 MFZ430	
	3482 083 032	430WGTZ			
	1878 004 832	KZISZ-5			
	3151 000 157				













		CODE					
---	--	------	--	--	---	---	---

NEOPLAN

N 316 - N 318

N 316 N 318	OM442LA	 3488 017 410	400 MFZ2/400X	enthält eine Kupplungsscheibe / This part number includes one clutch disc	(67)
		 1878 005 805 ▽	400 10 400GTZ		
		 1878 634 022 ▽#	400 10 400GVZ		
		 3151 000 157	KZISZ-5		
		 1878 634 023 △	400 10 400GVZ		
		 1878 005 805 △	400 10 400GTZ		
N 316 L/U	D2866LUH20	 3482 083 032	430 MFZ430	Getr. / GBox: AS-Tronic ZF-Getriebe / ZF Transmission	(62)
		 1878 004 832	430 10 430WGTZ	Getr. / GBox: AS-Tronic ZF-Getriebe / ZF Transmission	(62)
		 3151 000 144	KZISZ-5	Getr. / GBox: AS-Tronic ZF-Getriebe / ZF Transmission für Ausrückgabel mit Nocken / for release fork with cams	(62) (70)
N 318	HS6R1315-524-24	 1861 206 211 #	420 10 420GS		
	D2866LUH20, 21, MAND2866LOH 26	 3482 062 035	430 GMFZ430		
		 1878 080 034	430 10 430WGTZ		
		 3151 000 157	KZISZ-5		
	D2876LOH01, MAND2866LOH 23	 3400 700 379	430 10 MFZ430		
		 3482 083 032	430WGTZ		
		 1878 004 832	KZISZ-5		
		 3151 000 157			
	OM441LA	 3482 083 118	430 MFZ430		
		 1878 004 832	430 10 430WGTZ		
		 3151 000 157	KZISZ-5		
	OM447HLA	 3482 083 118	430 MFZ430		
 1878 085 742		430 10 430WGTZ			
 3151 000 157		KZISZ-5			













N 320 - N 326

N 326	OM403	 1800 125 301	420 10 GF420		
		 1882 301 239	420GTZ		
		 1878 002 706	KZIS-4		
		 3151 000 375			
		 3482 124 534	430 GMF430		
	OM422A	 1878 003 657	420 10 420WGTZ		
		 3151 000 375	KZIS-4		
		 1882 342 134	420 GF420X		
N 326	OM403	 3482 124 516	430 GMF430		
		 1878 002 706	420 10 420GTZ		
		 1878 003 657 ●	420 10 420WGTZ		
N 326	HS6R1315-524-24	 1861 206 211 #	420 10 420GS		

		CODE				
---	--	------	--	---	---	---

NEOPLAN







N 412 - N 416

N 412		HS6R1112-562-18		1881 039 531 #	350 G350		
				1878 001 074	350 10 350GTZ		
		OM352		1882 252 331	310 GFX310		
				1861 303 248	310 10 310GSB		
N 413		HS6R1112-562-18		1881 039 531 #	350 G350		
				1878 001 074	350 10 350GTZ		
N 414		HS6R1112-562-18		1881 039 531 #	350 G350		
				1878 001 074	350 10 350GTZ		
N 416		DAFDKA1160V		1861 206 211 #	420 10 420GS		
		DAFDKCL1160V		3482 124 550	430 GMF430		
				3482 006 036 ●#	420 GTF420		
				3151 000 375	KZIS-4		
		HS6R1315-524-24		1861 206 211 #	420 10 420GS		

N 418 - N 426

N 418		HS6R1315-524-24		1861 206 211 #	420 10 420GS		
N 426							

N 516 - N 526

N 516		OM442LA		3400 700 379 ● 3482 083 032 ● 1878 004 832 ● 3151 000 157	430 10 MFZ430 430WGTZ KZISZ-5		
N 516		OM442LA		3488 017 410	400 MFZ2/400X	enthält eine Kupplungsscheibe / This part number includes one clutch disc	(67)
				1878 005 805 ▽	400 10 400GTZ		
				1878 634 022 ▽#	400 10 400GVZ		
				3151 000 157	KZISZ-5		
				1878 634 023 △ 1878 005 805 △	400 10 400GVZ 400 10 400GTZ		
N 516		D2876LOH01, MAND2866LOH 23		3400 700 379 ● 3482 083 032 ● 1878 004 832 ● 3151 000 157	430 10 MFZ430 430WGTZ KZISZ-5		

N 906 - N 940

N 906 Turbo		OM617		3082 156 031	228 M228	Getr. / GBox: ZF4DS18	
				3151 069 131	KZIS-1	Getr. / GBox: ZF4DS18	
N 907	01.82 -	OM352		3482 012 211	330 GMF330		
				1861 571 236	330 10 330GSZ		
				3151 044 031	KZI-3		





















		CODE				
---	--	------	--	---	---	---

NEOPLAN

N 906 - N 940

N 912 N 922 N 940		OM401		1882 311 131 #	350 GF350	Je nach Kundenwunsch mit unterschiedlicher Kupplung / Equipped with different clutch according to customer requirement	(35)
				1878 001 070	350 10 350GTZ		
				3482 124 534	430 GMF430	Je nach Kundenwunsch mit unterschiedlicher Kupplung / Equipped with different clutch according to customer requirement	(35)
				1882 301 239 ●	420 GF420	Je nach Kundenwunsch mit unterschiedlicher Kupplung / Equipped with different clutch according to customer requirement	(35)
				1878 002 706	420 10 420GTZ		

Skyliner 09.73 -

Skyliner		DAFDKT1160		3482 124 550	430 GMF430		
				3482 006 036 ●#	420 GTF420		
		MAND2538MTA		3482 124 534	430 GMF430		
				1882 301 239 ●	420 GF420		
				1878 001 138	420 10 420GTZ		
		MAND2866LOH , 301kw, MAND2876LOH , 338kw		3482 083 032	430 MFZ430	Getr. / GBox: ZF 8S-180 AS-Tronic	
				1878 085 641	430 10 430GTZ	Getr. / GBox: ZF 8S-180 AS-Tronic	
				3151 000 157	KZISZ-5	Getr. / GBox: ZF 8S-180 AS-Tronic	
		D2676LOH01-04, D2676LOH10/26-28		3482 000 246	430 MFZ430	Getr. / GBox: ZF 12 AS	
				1878 004 104 HD	430 10 430WGTZ	Getr. / GBox: ZF 12 AS	
				3151 000 144	KZISZ-5	Getr. / GBox: ZF 12 AS für Ausrückgabel mit Nocken / for release fork with cams	(70)
				3151 000 493	KZISZ-5	Getr. / GBox: ZF 12 AS für Ausrückgabel mit Rollen / for release fork with rollers	(71)
				1863 869 038			
				3189 600 004		Getr. / GBox: ZF AS Tronic Rollenausführung / roller version	(58)
		N 1122/3 L N 1122/3 C	03.06 -	D2676LOH04/27/28, D2676LOH31/32		3400 700 459 HD	430 10 MFZ430
	3482 000 246				430 MFZ430	Getr. / GBox: AS Tronic für Ausrückgabel mit Nocken / for release fork with cams	(70)
	1878 004 104 HD				430 10 430WGTZ	Getr. / GBox: AS Tronic für Ausrückgabel mit Nocken / for release fork with cams	(70)
	3151 000 144				KZISZ-5	Getr. / GBox: AS Tronic für Ausrückgabel mit Nocken / for release fork with cams	(70)
	6594 000 121				430 430Z	Getr. / GBox: AS Tronic für Ausrückgabel mit Nocken / for release fork with cams	(70)
D2676				1863 869 038			
				3189 600 004		Getr. / GBox: ZF AS Tronic Rollenausführung / roller version	(58)

















		CODE					
---	--	------	--	--	---	---	---

NEOPLAN

Spaceliner 09.79 - 09.92



































Spaceliner HC		D2866LOH, 301kw, D2876LOH, 338kw		6594 000 124	430 430Z	Getr. / GBox: ZF AS-Tronic enthält Schwungradbefestigungsschrauben / includes bolt for flyweel mounting (66)
				3482 083 032	430 MFZ430	Getr. / GBox: ZF AS-Tronic
				1878 085 641	430 10 430GTZ	Getr. / GBox: ZF AS-Tronic
				3151 000 157	KZISZ-5	Getr. / GBox: ZF AS-Tronic

Starliner 09.96 -

Starliner L N 5217 SHD	02.04 - 02.05 -	D2876LOH		3400 700 459 HD ● 3482 000 246 ● 1878 004 104 ● 3151 000 493	430 10 MFZ430 430WGTZ KZISZ-5	Getr. / GBox: AS-Tronic für Ausrückgabel mit Rollen / for release fork with rollers (71)	
				3151 000 144	KZISZ-5	Getr. / GBox: AS-Tronic für Ausrückgabel mit Nocken / for release fork with cams (70)	
			D2676LOH01/1 0 D2066LOH07/0 8/10, D2066LOH28/3 2, D2066LUH09/2 4/34/53, D2676LOH10/2 6/30		6594 000 121	430 430Z	für OE-Nummer / for OE number 51.02301.6086 (83)
					3482 000 361	430 MFZ430	Getr. / GBox: AS-Tronic
					1878 080 037	430 10 430WGTZ	Getr. / GBox: AS-Tronic
					3151 000 493	KZISZ-5	Getr. / GBox: AS-Tronic für Ausrückgabel mit Rollen / for release fork with rollers (71)
					3151 000 144	KZISZ-5	Getr. / GBox: AS-Tronic für Ausrückgabel mit Nocken / for release fork with cams (70)
					1863 869 038		
			3189 600 004		Getr. / GBox: ZF AS Tronic Rollenausführung / roller version (58)		
	N 516 N 516/3	09.96 - 09.96 -	D2876LOH/Euro 3		6594 000 124	430 430Z	Getr. / GBox: ZF 8S-180 Getr. / GBox: ZF 12 AS 2300 enthält Schwungradbefestigungsschrauben / includes bolt for flyweel mounting (66)
				3482 083 032	430 MFZ430	Getr. / GBox: ZF 8S-180 Getr. / GBox: ZF 12 AS 2300	
				1878 085 641	430 10 430GTZ	Getr. / GBox: ZF 8S-180 Getr. / GBox: ZF 12 AS 2300	
				3151 000 157	KZISZ-5	Getr. / GBox: ZF 8S-180 Getr. / GBox: ZF 12 AS 2300	
N 516 N 516/3	09.02 - 09.02 -	D2866LOH/Euro 3		6594 000 124	430 430Z	Getr. / GBox: ZF 8S-180 Getr. / GBox: ZF 12 AS 2300 enthält Schwungradbefestigungsschrauben / includes bolt for flyweel mounting (66)	
				3482 083 032	430 MFZ430	Getr. / GBox: ZF 8S-180 Getr. / GBox: ZF 12 AS 2300	
				1878 085 641	430 10 430GTZ	Getr. / GBox: ZF 8S-180 Getr. / GBox: ZF 12 AS 2300	
				3151 000 157	KZISZ-5	Getr. / GBox: ZF 8S-180 Getr. / GBox: ZF 12 AS 2300	













		CODE				
---	--	------	--	---	---	---

NEOPLAN

Starliner		09.96 -				
N 2216 SHD N 2216 SHD N 2216 SHD N 2216 SHD N 2216 SHD	01.02- 01.02- 01.02- 01.02-	D2866LOH/LUH	 3482 000 361	430 MFZ430	Getr. / GBox: AS-Tronic	
			 1878 080 034	430 10 430WGTZ	Getr. / GBox: AS-Tronic	
			 3151 000 493	KZISZ-5	Getr. / GBox: AS-Tronic für Ausrückgabel mit Rollen / for release fork with rollers	(71)
			 3151 000 144	KZISZ-5	Getr. / GBox: AS-Tronic für Ausrückgabel mit Nocken / for release fork with cams	(70)
	D2876LOH	 3482 000 361	430 MFZ430	Getr. / GBox: AS-Tronic		
		 1878 004 104 HD	430 10 430WGTZ	Getr. / GBox: AS-Tronic		
		 3151 000 493	KZISZ-5	Getr. / GBox: AS-Tronic für Ausrückgabel mit Rollen / for release fork with rollers	(71)	
		 3151 000 144	KZISZ-5	Getr. / GBox: AS-Tronic für Ausrückgabel mit Nocken / for release fork with cams	(70)	
	D2876LOH02/03	 1878 080 037	430 10 430WGTZ	Getr. / GBox: ZF 8S		
		 3151 000 034	KZISZ-5	Getr. / GBox: ZF 8S		
	D2866LOH29/33/34	 3400 700 507	430 10	XTend Getr. / GBox: ZF 6/8 S Nabenprofil / Hub Profile: 41,1x50,8-10N Nur zusammen verbauen / Only install together	(48) (53)	
	D2066LOH07/08/10, D2066LOH28/32, D2066LUH09/24/34/53, D2676LOH10/26/30	 3400 700 381	430 10 MFZ430	Getr. / GBox: AS-Tronic für Ausrückgabel mit Rollen / for release fork with rollers	(71)	
		 3482 000 361	430 MFZ430	Getr. / GBox: AS-Tronic für Ausrückgabel mit Nocken / for release fork with cams	(70)	
		 1878 080 037	430 10 430WGTZ	Getr. / GBox: AS-Tronic für Ausrückgabel mit Nocken / for release fork with cams	(70)	
		 3151 000 493	KZISZ-5	Getr. / GBox: AS-Tronic für Ausrückgabel mit Rollen / for release fork with rollers	(71)	
	D2066LOH07/08/10, D2066LOH28/32, D2676LOH10/26/30	 3482 000 361	430 MFZ430	Getr. / GBox: AS-Tronic für Ausrückgabel mit Nocken / for release fork with cams	(70)	
 1878 080 037		430 10 430WGTZ	Getr. / GBox: AS-Tronic für Ausrückgabel mit Nocken / for release fork with cams	(70)		
 3151 000 493		KZISZ-5	Getr. / GBox: AS-Tronic für Ausrückgabel mit Rollen / for release fork with rollers	(71)		
D2066LOH07/08/10/28, D2066LUH09/24/34, D2876LOH03/10/26	 3482 083 032	430 MFZ430	Getr. / GBox: GO210-6			
	 1878 080 037	430 10 430WGTZ	Getr. / GBox: GO210-6			
	 3151 000 335	KZISZ-5	Getr. / GBox: GO210-6			
D2066LOH07/08/10/28, D2066LUH09/24/34, D2876LOH03/10/26	 3400 700 511	430 10	XTend Getr. / GBox: GO210-6 Nabenprofil / Hub Profile: 41,1x50,8-10N Nur zusammen verbauen / Only install together	(48) (53)		
	 1863 869 038					
D2876LOH01, D2866LOH28, D2866LOH29, D2866LOH27	 3189 600 004		Getr. / GBox: ZF AS Tronic Rollenausführung / roller version	(58)		
	 3400 700 404	430 10 MFZ430	Getr. / GBox: AS-Tronic für Ausrückgabel mit Nocken / for release fork with cams	(70)		
	 3482 000 246	430 10 MFZ430	Getr. / GBox: AS-Tronic für Ausrückgabel mit Rollen / for release fork with rollers	(71)		
	 3482 000 246	430 10 MFZ430	Getr. / GBox: AS-Tronic für Ausrückgabel mit Rollen / for release fork with rollers	(71)		
N 5218 SHD N 5218 SHD	05.05- 05.05-	D2876LOH21, D2876LOH20	 1878 002 139	430WGTZ KZISZ-5		
			 3151 000 144			
	 3400 700 445	430 10 MFZ430	Getr. / GBox: AS-Tronic für Ausrückgabel mit Rollen / for release fork with rollers	(71)		
	 3482 000 246	430 10 MFZ430	Getr. / GBox: AS-Tronic für Ausrückgabel mit Rollen / for release fork with rollers	(71)		
			 1878 004 104	430WGTZ KZISZ-5		
			 3151 000 493			
			 3189 600 004		Getr. / GBox: ZF AS Tronic Rollenausführung / roller version	(58)

		CODE				
---	--	------	--	---	---	---

NEOPLAN

Tourliner		09.02 -					
N 2216/3SHD Tourliner C	09.05 -	D2066LOH07/0 8/10/28, D2066LUH09/2 4/34, D2676LOH10		3400 700 505 ■	430 10	XTend Getr. / GBox: ZF 6 S Nabenprofil / Hub Profile: 41,1x50,8-10N Nur zusammen verbauen / Only install together	(48) (53)
		D2066LOH07/0 8/10/28, D2066LUH09/2 4/34, D2676LOH10/2 6		3400 700 511 ◐■	430 10	XTend Getr. / GBox: GO 210-6 Nabenprofil / Hub Profile: 41,1x50,8-10N Nur zusammen verbauen / Only install together	(48) (53)
		D2066LOH07/0 8/10, D2066LOH28/3 2, D2066LUH09/2 4/34/53, D2676LOH10/2 6/30		3400 700 381 ⊙ 3482 000 361 ⊙ 1878 080 037 ⊙ 3151 000 493	430 10 MFZ430 430WGTZ KZISZ-5	Getr. / GBox: AS Tronic für Ausrückgabel mit Rollen / for release fork with rollers	(71)
				3482 000 361	430 MFZ430	Getr. / GBox: AS Tronic für Ausrückgabel mit Nocken / for release fork with cams	(70)
				1878 080 037	430 10 430WGTZ	Getr. / GBox: AS Tronic für Ausrückgabel mit Nocken / for release fork with cams	(70)
				3151 000 144	KZISZ-5	Getr. / GBox: AS Tronic für Ausrückgabel mit Nocken / for release fork with cams	(70)
		D2066LOH07/0 8/10, D2066LOH28/3 2, D2676LOH10/2 6/30		3482 083 032	430 MFZ430	Getr. / GBox: GO 210-6	
				1878 080 037	430 10 430WGTZ	Getr. / GBox: GO 210-6	
				3151 000 335	KZIZ-5	Getr. / GBox: GO 210-6	
		D2066LOH07/0 8/28, D2676LOH26		6594 000 121	430 430Z	Getr. / GBox: GO 210-6	
				1863 869 038			
				3189 600 004		Getr. / GBox: ZF AS Tronic Rollenausführung / roller version	(58)



CODE



SACHS

Parameter



NEOPLAN























Tourliner

09.02 -



N 2216 SHD	01.03-	D2866LOH/LUH		3482 000 361	430	Getr. / GBox: AS-Tronic	
N 2216 SHD	06.06-				MFZ430		
N 2216 SHD	01.03-			1878 080 034	430 10	Getr. / GBox: AS-Tronic	
N 2216 SHD	06.06-				430WGTZ		
N 2216 SHDL	06.06-			3151 000 493	KZISZ-5	Getr. / GBox: AS-Tronic für Ausrückgabel mit Rollen / for release fork with rollers	(71)
N 2216 SHDL	06.06-			3151 000 144	KZISZ-5	Getr. / GBox: AS-Tronic für Ausrückgabel mit Nocken / for release fork with cams	(70)
N 2216 SHDL	01.03-						
N 2216 SHDL	01.03-						
		D2876LOH		3482 000 361	430	Getr. / GBox: AS-Tronic	
					MFZ430		
				1878 004 104 HD	430 10	Getr. / GBox: AS-Tronic	
					430WGTZ		
				3151 000 493	KZISZ-5	Getr. / GBox: AS-Tronic für Ausrückgabel mit Rollen / for release fork with rollers	(71)
				3151 000 144	KZISZ-5	Getr. / GBox: AS-Tronic für Ausrückgabel mit Nocken / for release fork with cams	(70)
		D2876LOH02/0 3		1878 080 037	430 10	Getr. / GBox: ZF 8S	
					430WGTZ		
				3151 000 034	KZISZ-5	Getr. / GBox: ZF 8S	
		D2866LOH29/3 3/34		3400 700 507	430 10	XTend Getr. / GBox: ZF 6/8 S Nabenprofil / Hub Profile: 41,1x50,8-10N Nur zusammen verbauen / Only install together	(48) (53)
		D2066LOH07/0 8/10, D2066LOH28/3 2, D2066LUH09/2 4/34/53, D2676LOH10/2 6/30		3400 700 381	430 10	Getr. / GBox: AS-Tronic für Ausrückgabel mit Rollen / for release fork with rollers	(71)
				3482 000 361	MFZ430		
				1878 080 037	430WGTZ		
				3151 000 493	KZISZ-5		
				3482 000 361	430	Getr. / GBox: AS-Tronic für Ausrückgabel mit Nocken / for release fork with cams	(70)
					MFZ430		
				1878 080 037	430 10	Getr. / GBox: AS-Tronic für Ausrückgabel mit Nocken / for release fork with cams	(70)
					430WGTZ		
				3151 000 493	KZISZ-5	Getr. / GBox: AS-Tronic für Ausrückgabel mit Nocken / for release fork with cams	(70)
						für Ausrückgabel mit Rollen / for release fork with rollers	(71)
		D2066LOH07/0 8/10, D2066LOH28/3 2, D2676LOH10/2 6/30		3482 083 032	430	Getr. / GBox: GO210-6	
					MFZ430		
				1878 080 037	430 10	Getr. / GBox: GO210-6	
					430WGTZ		
				3151 000 335	KZISZ-5	Getr. / GBox: GO210-6	
		D2066LOH07/0 8/10/28, D2066LUH09/2 4/34, D2876LOH03/1 0/26		3400 700 511	430 10	XTend Getr. / GBox: GO210-6 Nabenprofil / Hub Profile: 41,1x50,8-10N Nur zusammen verbauen / Only install together	(48) (53)
		D2876LOH03, D2866LOH34, D2066LOH04, D2066LOH03		1863 869 038			
				3189 600 004		Getr. / GBox: ZF AS Tronic Rollenausführung / roller version	(58)

		CODE				
---	--	------	--	---	---	---

NEOPLAN

Trendliner		09.04 -				
13 M N 3516 Ü N 3516 Ü N 3516 Ü N 3516/3 ÜL	09.04 -	D2066LOH07/0 8/10, D2066LOH28/3	 3400 700 381  3482 000 361  1878 080 037  3151 000 493	430 10 MFZ430 430WGTZ KZISZ-5	Getr. / GBox: AS-Tronic für Ausrückgabel mit Rollen / for release fork with rollers	(71)
	09.04 -	D2066LUH09/2 4/34/53	 3482 000 361	430 MFZ430	Getr. / GBox: AS-Tronic	
	09.04 -		 1878 080 037	430 10 430WGTZ	Getr. / GBox: AS-Tronic	
	09.04 -		 3151 000 144	KZISZ-5	Getr. / GBox: AS-Tronic für Ausrückgabel mit Nocken / for release fork with cams	(70)
			 3482 000 361	430 MFZ430	Getr. / GBox: AS-Tronic	
			 1878 080 034	430 10 430WGTZ	Getr. / GBox: AS-Tronic	
			 3151 000 493	KZISZ-5	Getr. / GBox: AS-Tronic für Ausrückgabel mit Rollen / for release fork with rollers	(71)
			 3151 000 144	KZISZ-5	Getr. / GBox: AS-Tronic für Ausrückgabel mit Nocken / for release fork with cams	(70)
			 3400 700 507 	430 10	XTend Getr. / GBox: ZF 6S Nabenprofil / Hub Profile: 41,1x50,8-10N Nur zusammen verbauen / Only install together	(48) (53)
			 3400 700 506 	430 10	XTend Getr. / GBox: ZF 6S Nabenprofil / Hub Profile: 41,1x50,8-10N Nur zusammen verbauen / Only install together	(48) (53)
			 3400 700 505 	430 10	XTend Getr. / GBox: ZF 6S Nabenprofil / Hub Profile: 41,1x50,8-10N Nur zusammen verbauen / Only install together	(48) (53)
			 3400 700 509 	430 10	XTend Getr. / GBox: GO210-6 Nabenprofil / Hub Profile: 41,1x50,8-10N Nur zusammen verbauen / Only install together	(48) (53)
			 3400 700 511 	430 10	XTend Getr. / GBox: GO210-6 Nabenprofil / Hub Profile: 41,1x50,8-10N Nur zusammen verbauen / Only install together	(48) (53)
			 1863 869 038			
			 3189 600 004		Getr. / GBox: ZF AS Tronic Rollenausführung / roller version	(58)

ÖSTERREICHISCHE AUTOMOBILFABRIK (ÖAF)



Omnibus						
Omnibus / deck bus GSR + GS		 3482 124 534	430 GMF430			
		1882 301 239	420 GF420			
		 1878 634 039 ▲	420 10 420WGTZ			
		 1863 009 100	GR-5	mit Anlauftring / with thrust ring		(88)

		CODE				
---	--	------	--	---	---	---























ORION WERKE



W...Serie						
WH 153			 1863 600 125	GR-3	mit Anlauffring / with thrust ring	(88)

PAZ

BUS						
Bus		MMZ	 3482 125 512	362 MF362	Getr. / GBox: ZF-S5-42	
			 1878 001 501	362 10 362GTZ	Getr. / GBox: ZF-S5-42	
			 3151 000 079	KZI-3	Getr. / GBox: ZF-S5-42	

RENAULT TRUCKS

ARES - 03.99							
Ares			 3482 083 252	430 MFZ430	Getr. / GBox: B8 TBV		
			 1878 020 241	430 20 430WGTZ	Getr. / GBox: B8 TBV		
			 3151 250 231	KZISZ-5	Getr. / GBox: B8 TBV		
			 3482 083 252	430 MFZ430	Getr. / GBox: ZF 6S-85 Getr. / GBox: ZF 8S-180		
			 3400 700 493  3482 083 252  1878 004 832	430 10 MFZ430 430WGTZ	->10.2001 Getr. / GBox: ZF 8S-180 Produktionsnummer bis / Production number to: CAM 15K1	(56)	
			 1878 026 241	430 10 430WGTZ	Getr. / GBox: ZF 6S-85		
			 3151 250 231	KZISZ-5	Getr. / GBox: ZF 6S-85 Getr. / GBox: ZF 8S-180		
			 3482 083 252	430 MFZ430	Getr. / GBox: ZF 10AS2301		
			 3400 700 493  3482 083 252  1878 004 832	430 10 MFZ430 430WGTZ	->10.2001 Getr. / GBox: ZF 10AS2301 Produktionsnummer bis / Production number to: CAM 15K1	(56)	
			 3151 000 144	KZISZ-5	Getr. / GBox: ZF 10AS2301 für Ausrückgabel mit Nocken / for release fork with cams	(70)	
			DCI11, MIDR062356	 3400 700 493  3482 083 252  1878 004 832	430 10 MFZ430 430WGTZ	->10.2001 Getr. / GBox: ZF 6S-1600 Produktionsnummer bis / Production number to: CAM 15K1	(56)
				 3482 083 252	430 MFZ430	Getr. / GBox: ZF 6S-1600	
				 3151 250 231	KZISZ-5	Getr. / GBox: ZF 6S-1600	
			F2B	 3482 078 134	400 MFZ400	Getr. / GBox: 6S-1600	
				 1878 032 032	400 10 400WGTZ	Getr. / GBox: 6S-1600	
 3151 000 157	KZISZ-5	Getr. / GBox: 6S-1600					

AXER - 03.99						
C956			 3400 700 328  3482 078 134  1878 032 032  3151 000 157	400 10 MFZ400 400WGTZ KZISZ-5		









E 7						
E 7 C	01.75-	798	 3400 700 339  3482 124 041  1878 001 729  3151 270 341	350 10 MF350 350GTD KZIS-3	Getr. / GBox: ZFS5-35	

		CODE					
---	--	------	--	--	---	---	---

RENAULT TRUCKS





















E 7							
E 7 L, M, N		MAN2156		1882 302 131 HD	380 GF380		
		MAN2356		3482 037 141	380 GM380		

E 53							
Serie E 53	06.71 - 12.79	MAN2356		3482 037 141	380 GM380		

FR 1							
FR 1	04.90 -			3400 116 701 ⊗ 3482 097 141 ⊗ 1878 026 241 ⊙ 3100 008 106	430 10 GMFZ430 430WGTZ KZISZ-5	->09.1992 Getr. / GBox: ZF S6-150	
				3400 116 601 ⊗ 3482 097 141 ⊗ 1878 020 241 ⊙ 3100 008 106	430 20 GMFZ430 430WGTZ KZISZ-5	->09.1992 Getr. / GBox: B9	
		MIDR062045		3400 700 329 ⊗ 3482 083 044 ⊗ 1878 022 841 ⊙ 3100 008 106	430 10 MFZ430 430GTZ KZISZ-5	10.1992-> Getr. / GBox: ZF S8-180	
				3400 116 901 ⊗ 3482 083 044 ⊗ 1878 026 241 ⊙ 3100 008 106	430 10 MFZ430 430WGTZ KZISZ-5	10.1992-> Getr. / GBox: ZF S6-90, S6-85	
		MIDR062045M3		3400 117 202 ⊗ 3482 083 044 ⊗ 1878 020 241 ⊙ 3100 008 106	430 20 MFZ430 430WGTZ KZISZ-5	10.1992-> Getr. / GBox: B8L	
FR 1 E-T-GT	11.92 -	MIDR062045		3400 116 901 ⊗ 3482 083 044 ⊗ 1878 026 241 ⊙ 3100 008 106	430 10 MFZ430 430WGTZ KZISZ-5	Getr. / GBox: ZF S6-90, ZF S6-85	
				3400 700 329 ⊗ 3482 083 044 ⊗ 1878 022 841 ⊙ 3100 008 106	430 10 MFZ430 430GTZ KZISZ-5	Getr. / GBox: ZF S8-180	
				3400 117 202 ⊗ 3482 083 044 ⊗ 1878 020 241 ⊙ 3100 008 106	430 20 MFZ430 430WGTZ KZISZ-5	Getr. / GBox: B9/B8L	





		CODE				
---	--	------	--	---	---	---









RENAULT TRUCKS

ILIADÉ - 03.99							
Iliade	10.96-			3400 117 202 ⊗ 3482 083 044 ⊗ 1878 020 241 ⊙ 3100 008 106	430 20 MFZ430 430WGTZ KZISZ-5	->05.1997 Getr. / GBox: B 8 170R1 TBV	
				3400 123 401 ⊗ 3482 083 252 ⊗ 1878 020 241 ⊙ 3151 250 231	430 20 MFZ430 430WGTZ KZISZ-5	06.1997-> Getr. / GBox: B9,B8 170R5 TBV	
				3400 116 901 ⊗ 3482 083 044 ⊗ 1878 026 241 ⊙ 3100 008 106	430 10 MFZ430 430WGTZ KZISZ-5	->08.1997 Getr. / GBox: ZF S6-85	
				3400 700 409 ⊗ 3482 083 252 ⊗ 1878 026 241 ⊙ 3151 250 231	430 10 MFZ430 430WGTZ KZISZ-5	09.1997-> Getr. / GBox: ZF S6-85	
				3482 083 044	430 MFZ430	->10.1997 Getr. / GBox: ZF S8-180 Produktionsnummer bis / Production number to: CAM 11KV	(56)
				1878 004 832	430 10 430WGTZ	->10.1997 Getr. / GBox: ZF S8-180 Produktionsnummer bis / Production number to: CAM 11KV	(56)
				3100 008 106 ⊙ 3151 234 132 ⊙ 3180 000 009	KZISZ-5 KZISZ-5	->10.1997 Getr. / GBox: ZF S8-180 Produktionsnummer bis / Production number to: CAM 11KV Beinhaltet Ausrücker und Montagesatz / Contains releaser and fitting kit	(56) (9)
				3400 700 330 ⊗ 3482 083 252 ⊗ 1878 004 832 ⊙ 3151 250 231	430 10 MFZ430 430WGTZ KZISZ-5	10.1997-> Getr. / GBox: ZF S8-180 Produktionsnummer ab / Production number from: CAM 12KV	(55)
				3482 083 252	430 MFZ430	Getr. / GBox: ZF 6S-1600	
				3151 250 231	KZISZ-5	Getr. / GBox: ZF 6S-1600	
KAROSA - 03.99							
MIHR 062045				3482 083 044	430 MFZ430		
				1878 026 241	430 10 430WGTZ		
				3100 008 106 ⊙ 3151 234 132 ⊙ 3180 000 009	KZISZ-5 KZISZ-5	Beinhaltet Ausrücker und Montagesatz / Contains releaser and fitting kit	(9)
OBRADORE - 03.99							
Obradore	10.96-	MIDR062045M1 , MIDR062045M4 1, MIDR062056A4 1 MIDR062045M4 1, MIDR062056A4 1, MIDR062345A4 1		3400 123 401 ⊗ 3482 083 252 ⊗ 1878 020 241 ⊙ 3151 250 231	430 20 MFZ430 430WGTZ KZISZ-5	Getr. / GBox: B9/B8L	
				3482 083 252	430 MFZ430	Getr. / GBox: ZF S8-180	
				1878 022 841	430 10 430GTZ	Getr. / GBox: ZF S8-180	
				3151 250 231	KZISZ-5	Getr. / GBox: ZF S8-180	
PR							
8	01.86-			3482 124 041	350 MF350		
				1878 002 075 #	350 16 350GTZ		
				3151 000 285	KZI-4		
RÈCREO - 03.99							
C935	10.96-	MIHR062045A/4 1		3400 116 901 ⊗ 3482 083 044 ⊗ 1878 026 241 ⊙ 3100 008 106	430 10 MFZ430 430WGTZ KZISZ-5	Getr. / GBox: 5P 115	

















		CODE				
---	--	------	--	---	---	---

RENAULT TRUCKS

RÈCREO - 03.99						
C955			 3400 700 328  3482 078 134  1878 032 032  3151 000 157	400 10 MFZ400 400WGTZ KZISZ-5		

TRACER - 03.99						
332		MIHR062045	 3482 097 141	430 GMFZ430	->12.1992 Getr. / GBox: G406	
			 1878 049 041 #	430 16 430WGTZ	->12.1992 Getr. / GBox: G406	
			 3100 008 106  3151 234 132  3180 000 009	KZISZ-5 KZISZ-5	->12.1992 Getr. / GBox: G406 Beinhaltet Ausrücker und Montagesatz / Contains releaser and fitting kit	(9)
			 3400 700 341 #  3482 083 044  1878 049 041  3100 008 106	430 16 MFZ430 430WGTZ KZISZ-5	01.1993-> Getr. / GBox: G406	

SCANIA

Bus						
B 116			 3482 119 034	430 GMF430	Nur zusammen verbauen / Only install together	(53)
			 3482 001 234 ●#	420 GMF420		
			 1878 003 339	420 10 420GTZ	Nur zusammen verbauen / Only install together	(53)
BR 85 BR 86			 3482 124 514 ▲	430 GMF430	Mot. DS8	
			 1878 001 138	420 10 420GTZ	Mot. DS8	
BR 116			 3400 125 901 ●  3482 119 034  1878 003 238	430 22 GMF430 420GTZ	Getr. / GBox: G764 Getr. / GBox: G774	
			 3482 001 234 ●#	420 GMF420	Getr. / GBox: G764 Getr. / GBox: G774	
			 1878 003 339	420 10 420GTZ	Getr. / GBox: G764 Nur zusammen verbauen / Only install together	(53)
BR 140 BR 145			 1878 001 138	420 10 420GTZ	Mot. DS8	
CR 85			 3482 124 514 ▲	430 GMF430	Mot. DS8 Nur zusammen verbauen / Only install together	(53)
			 1878 001 138	420 10 420GTZ	Mot. DS8 Nur zusammen verbauen / Only install together	(53)
K 82			 3482 119 034	430 GMF430		
			 3482 001 234 ●#	420 GMF420		
			 1878 003 339	420 10 420GTZ		



CODE



SACHS

Parameter



























SCANIA

Bus



K94 / L94 / N94 / 114 / 124	01.95-	K402-5	3482 112 031	400 MFZ400X		
			1878 043 231	400 24 400WGVZ		
			3182 009 938	HHISZ-4	Immer erneuern / Renew everytime	(30)
			3180 007 000		Immer erneuern / Renew everytime Montagesatz für Ausrücklager / Fitting kit for releaser	(30) (47)
		K432-8	3400 123 701 ⊕ 3483 020 036 1878 003 066	430 24 MFZ430 430WGTZ		
			3482 083 039	430 MFZ430	In 3483/3488 enthalten / Contained in 3483, 3488	(32)
			3100 008 201 ◊ 3151 000 272 ⊙ 3180 000 009	KZIZ-5 KZISZ-5		
		K432-15	3482 083 039	430 MFZ430		
			1878 063 231 #	430 24 430WGTZ		
			3182 009 938	HHISZ-4	Immer erneuern / Renew everytime	(30)
			3180 007 000		Immer erneuern / Renew everytime Montagesatz für Ausrücklager / Fitting kit for releaser	(30) (47)
		K432-16	3400 122 001 ⊖ 3482 083 150 1878 063 231	430 24 MFZ430 430WGTZ		
			3182 009 938	HHISZ-4	Immer erneuern / Renew everytime	(30)
			3180 007 000		Immer erneuern / Renew everytime Montagesatz für Ausrücklager / Fitting kit for releaser	(30) (47)
		K432-17	3482 083 039	430 MFZ430		
			1878 063 231 #	430 24 430WGTZ		
			3182 009 938	HHISZ-4	Immer erneuern / Renew everytime	(30)
			3180 007 000		Immer erneuern / Renew everytime Montagesatz für Ausrücklager / Fitting kit for releaser	(30) (47)
		K432-18	3482 083 150	430 MFZ430		
			3182 009 938	HHISZ-4	Immer erneuern / Renew everytime	(30)
3180 007 000			Immer erneuern / Renew everytime Montagesatz für Ausrücklager / Fitting kit for releaser	(30) (47)		
K432-30, K432-31, K432-32	3400 700 354 3482 000 251 1878 003 066 ◊ 3151 000 151	430 24 MFZ430 430WGTZ KZISZ-5				
	3400 125 701 3482 119 031 1878 003 269 ◊ 3151 000 395	430 10 GMF430 420GTZ KZIS-4	Mot. DSC11			
	3482 018 132 ●#	420 GMF420	Mot. DSC11			
K 112	3482 118 031	430 GMF430	Mot. DS11			
	1878 003 269	420 10 420GTZ	Mot. DS11			
	3151 000 515	KZIS-4	Mot. DS11			
	3482 124 514 ▲	430 GMF430				
	1878 003 238	420 22 420GTZ				
	3400 125 901 ⊖ 3482 119 034 1878 003 238	430 22 GMF430 420GTZ				
	3482 001 234 ●#	420 GMF420				
	1878 003 339	420 10 420GTZ				

		CODE				
---	--	------	--	---	---	---



SCANIA





























Bus Serie 3		01.89 - 12.97				
K 93 CL K 113 K 113 CLB K 113 CLB L 113 CLB L 113 CLB	01.91 - 12.96	K402-1	 3400 123 501 ⊕ ⊕ 3483 028 031 ⊕ 1862 450 031	400 22 MFZ400X 400GVZ		
	11.90 -		 3482 112 031	400 MFZ400X	In 3483/3488 enthalten / Contained in 3483, 3488	(32)
	07.90 - 12.96		 3100 008 201 ⊕ 3151 000 272 ⊙ 3180 000 009	KZIZ-5 KZISZ-5	Beinhaltet Ausrücker und Montagesatz / Contains releaser and fitting kit In 3483/3488 enthalten / Contained in 3483, 3488	(9)
	01.91 - 12.97	K402-3	 3400 123 601 ⊕ ⊕ 3483 028 031 ⊕ 1878 043 231	400 24 MFZ400X 400WGVZ		
	11.93 - 12.96		 3482 112 031	400 MFZ400X	In 3483/3488 enthalten / Contained in 3483, 3488	(32)
	01.90 - 12.96		 3100 008 201 ⊕ 3151 000 272 ⊙ 3180 000 009	KZIZ-5 KZISZ-5	Beinhaltet Ausrücker und Montagesatz / Contains releaser and fitting kit In 3483/3488 enthalten / Contained in 3483, 3488	(9)
	K422-9		 3400 125 901 ⊖ ⊕ 3482 119 034 ⊕ 1878 003 238	430 22 GMF430 420GTZ		
			 3482 001 234 ●#	420 GMF420		
			K422-12	 3482 119 034	430 GMF430	
	 3482 001 234 ●#	420 GMF420				
	 1878 003 658	420 24 420WGTZ				
	K432-3		 3482 119 034	430 GMF430		
			 3482 001 234 ●#	420 GMF420		
			 1878 005 487	420 22 420WGTZ		
	K432-9		 3482 119 034	430 GMF430		
			 3482 001 234 ●#	420 GMF420		
	K432-10		 3482 083 039	430 MFZ430		
			 1878 063 231 #	430 24 430WGTZ		
			 3100 008 201 ⊕ 3151 000 272 ⊙ 3180 000 009	KZIZ-5 KZISZ-5		
	K432-11, K432-12		 3482 119 034	430 GMF430		
			 3482 001 234 ●#	420 GMF420		
	K432-14		 3482 083 039	430 MFZ430		
			 1878 063 231 #	430 24 430WGTZ		
			 3100 008 201 ⊕ 3151 000 272 ⊙ 3180 000 009	KZIZ-5 KZISZ-5		

SETRA

Serie 300		09.91 - 02.02				
S315GT, S315GT-HD, S315HD, S315HDH 315.032 315.031 317.010 345.000 317.011	09.91 - 02.02	OM446.930, OM446.931	 3482 081 233	430 MFZ430		
			 1878 002 734	430 10 430WGTZ		
			 3151 000 615	KZISZ-5		
S313UL, S315H, S315UL, S315NF	09.91 - 02.02	OM457HLA	 3400 700 509 ■	430 10	XTend für / for: S 315 H Getr. / GBox: GO 190	(69)





















SETRA

Serie 300		09.91 - 02.02			
S317GT-HD, S317HD, S317HDH, S319GT-HD 345.010	09.91 - 02.02	OM442.980	 1882 166 737  1878 000 104  3151 000 529	380 GF380 380 10 380GTZ KZIS-4	

Serie 400		06.01 -			
ComfortClass S 415 GT 632.121 ComfortClass S 415 GT 632.121 ComfortClass S 415 GT, S 416 GT 632.121 632.125	10.03- 10.03- 10.03-	OM457.952, OM457.941, OM457.965	 3482 000 852  1878 005 541  3151 000 335  3400 700 509	430 MFZ430 430 10 430WGTZ KZIZ-5 430 10	je nach Ausführung, mit unterschiedlicher Kupplung / depending on version, with different clutch (85) je nach Ausführung, mit unterschiedlicher Kupplung / depending on version, with different clutch (85) je nach Ausführung, mit unterschiedlicher Kupplung / depending on version, with different clutch (85) XTend Nabenprofil / Hub Profile: 41,1x50,8-10N je nach Ausführung, mit unterschiedlicher Kupplung / depending on version, with different clutch (48) Nur zusammen verbauen / Only install together (85) Nur zusammen verbauen / Only install together (53)
ComfortClass S 415 GT, GT-HD 632.121 632.131 ComfortClass S 415 GT, GT-HD 632.131 632.121	10.03- 10.03-	OM457.952, OM457.941, OM457.965, OM457.961, OM457.944, OM457.953	 3482 000 852  1878 005 541  3151 000 335  3400 700 509  6594 000 079	430 MFZ430 430 10 430WGTZ KZIZ-5 430 10 430 430Z	je nach Ausführung, mit unterschiedlicher Kupplung / depending on version, with different clutch (85) je nach Ausführung, mit unterschiedlicher Kupplung / depending on version, with different clutch (85) je nach Ausführung, mit unterschiedlicher Kupplung / depending on version, with different clutch (85) XTend Nabenprofil / Hub Profile: 41,1x50,8-10N je nach Ausführung, mit unterschiedlicher Kupplung / depending on version, with different clutch (48) Nur zusammen verbauen / Only install together (85) Nur zusammen verbauen / Only install together (53) Fahrzeuge können mit unterschiedlichen Komponenten bestückt sein. / Vehicles may be fitted with different components (23) enthält Schwungradbefestigungsschrauben / includes bolt for flywheel mounting (66)
ComfortClass S 416 GT-HD 632.134 ComfortClass S 416 GT-HD 632.134 ComfortClass S 416 GT-HD 632.134	10.03- 10.03- 10.03-	OM542.966, OM542.948	 3482 000 852  1878 005 541  3151 000 335	430 MFZ430 430 10 430WGTZ KZIZ-5	
ComfortClass S 416 GT-HD 632.134	10.03-	OM457	 3400 700 643  3482 000 851  1878 005 540  3151 000 335	430 10 MFZ430 430WGTZ KZIZ-5	Getr. / GBox: Powershift
		OM5*2	 3482 000 852  1878 005 541  3151 000 335	430 MFZ430 430 10 430WGTZ KZIZ-5	Getr. / GBox: Powershift Getr. / GBox: Powershift Getr. / GBox: Powershift
ComfortClass S 416 GT-HD, ComfortClass S 417 GT-HD 632.133/134 ComfortClass S 416 GT-HD, ComfortClass S 417 GT-HD 632.133/134	10.03- 10.03-	OM457	 3400 700 643  3482 000 851  1878 005 540  3151 000 335	430 10 MFZ430 430WGTZ KZIZ-5	Getr. / GBox: Powershift
		OM5*2	 3482 000 852  1878 005 541  3151 000 335	430 MFZ430 430 10 430WGTZ KZIZ-5	Getr. / GBox: Powershift Getr. / GBox: Powershift Getr. / GBox: Powershift
		OM457.961, OM457.944, OM457.953	 3400 700 509	430 10 XTend Nabenprofil / Hub Profile: 41,1x50,8-10N je nach Ausführung, mit unterschiedlicher Kupplung / depending on version, with different clutch (48) Nur zusammen verbauen / Only install together (85)	(48) (85)
			 6594 000 079	430 430Z	Fahrzeuge können mit unterschiedlichen Komponenten bestückt sein. / Vehicles may be fitted with different components (23) enthält Schwungradbefestigungsschrauben / includes bolt for flywheel mounting (66)

































		CODE				
---	--	------	--	---	---	---

SETRA

Serie 400		06.01 -					
MultiClass S 412 UL 633.100		OM457.952	 3400 700 509 ■	430 10	XTend Getr. / GBox: G0/190/210 Nabenprofil / Hub Profile: 41,1x50,8-10N Nur zusammen verbauen / Only install together	(48) (53)	
MultiClass S 415 UL 633.101			 6594 000 079	430 430Z	für / for: SA522019-08 Getr. / GBox: G0/190/210 enthält Schwungradbefestigungsschrauben / includes bolt for flywheel mounting	(69) (66)	
MultiClass S 417 UL 633.103							
MultiClass S 419 UL 633.104							
S 415 HDH 629.623	01.07 -	OM457LA	 3400 700 643	430 10	für / for: 2200 [Nm] Getr. / GBox: Powershift	(69)	
S 416 HDH 629.625	01.07 -		 3482 000 851  1878 005 540  3151 000 335	MFZ430 430WGTZ KZIZ-5	je nach Ausführung, mit unterschiedlicher Kupplung / depending on version, with different clutch	(85)	
S 417 HDH 629.627	01.07 -		 3482 000 852	430 MFZ430	für / for: 2300 [Nm] Getr. / GBox: Powershift	(69)	
			 1878 005 541	430 10 430WGTZ	je nach Ausführung, mit unterschiedlicher Kupplung / depending on version, with different clutch	(85)	
			 3151 000 335	KZIZ-5	für / for: 2300 [Nm] Getr. / GBox: Powershift	(69)	
			 3400 700 509 ■	430 10	XTend Nabenprofil / Hub Profile: 41,1x50,8-10N je nach Ausführung, mit unterschiedlicher Kupplung / depending on version, with different clutch Nur zusammen verbauen / Only install together	(48) (85) (53)	
TopClass S 411 HD 629.410 629.610	10.01 -	OM541.950,	 3400 700 509 ■	430 10	XTend Nabenprofil / Hub Profile: 41,1x50,8-10N Nur zusammen verbauen / Only install together	(48) (53)	
TopClass S 415 HD 629.411 629.612	10.01 -	OM542.948,					
TopClass S 416 HDH, TopClass S 417 HDH	10.02 -	OM457.961, OM457.944, OM457.953					
TopClass S 411 HD 629.422 629.425 629.625			 6594 000 080	430 430Z	enthält Schwungradbefestigungsschrauben / includes bolt for flywheel mounting	(66)	
TopClass S 411 HD 629.410 629.610	10.01 -	OM541.950	 3400 700 509 ■	430 10	XTend Nabenprofil / Hub Profile: 41,1x50,8-10N Nur zusammen verbauen / Only install together	(48) (53)	
TopClass S 415 HD 629.612 629.411	10.01 -	OM457.944	 3400 700 509 ■	430 10	XTend Getr. / GBox: GO 210 Nabenprofil / Hub Profile: 41,1x50,8-10N Nur zusammen verbauen / Only install together	(48) (53)	
TopClass S 415 HD 629.612 629.411	10.01 -		 3400 700 512 ■	430 10	XTend Getr. / GBox: AS Tronic Nabenprofil / Hub Profile: 41,1x50,8-10N Nur zusammen verbauen / Only install together	(48) (53)	
TopClass S 415 HDH 629.623 629.421	10.01 -		 3151 000 144	KZISZ-5	Getr. / GBox: AS Tronic für Ausrückgabel mit Nocken / for release fork with cams	(70)	
TopClass S 415 HDH 629.421 629.623	10.01 -		 3151 000 493	KZISZ-5	Getr. / GBox: AS Tronic für Ausrückgabel mit Rollen / for release fork with rollers	(71)	
			 1863 869 028				
		OM457.944, OM457.961	 6594 000 079	430 430Z	für / for: SA522019-08/15 enthält Schwungradbefestigungsschrauben / includes bolt for flywheel mounting	(69) (66)	
		OM457.961, OM542.948, OM457.944, OM457.953	 3189 600 004		Getr. / GBox: ZF AS Tronic Rollenausführung / roller version	(58)	







		CODE				
---	--	------	--	---	---	---

SETRA









Serie 400		06.01 -					
TopClass S 415 HDH 629.421 629.623	10.01 -	OM457.961	 3400 700 509 	430 10	XTend Getr. / GBox: GO 210 Nabenprofil / Hub Profile: 41,1x50,8-10N Nur zusammen verbauen / Only install together	(48) (53)	
			 3400 700 512 	430 10	XTend Getr. / GBox: AS Tronic Nabenprofil / Hub Profile: 41,1x50,8-10N Nur zusammen verbauen / Only install together	(48) (53)	
			 3151 000 144	KZISZ-5	Getr. / GBox: AS Tronic für Ausrückgabel mit Nocken / for release fork with cams	(70)	
			 3151 000 493	KZISZ-5	Getr. / GBox: AS Tronic für Ausrückgabel mit Rollen / for release fork with rollers	(71)	
			 1863 869 028				
			 3189 600 004		Getr. / GBox: ZF AS Tronic Rollenausführung / roller version	(58)	
		OM457.944, OM457.961	 6594 000 079	430 430Z	für / for: SA522019-08/15 enthält Schwungradbefestigungsschrauben / includes bolt for flywheel mounting	(69) (66)	
TopClass S 415 HDH 629.623 629.421	10.01 -	OM542.966	 3400 700 509 	430 10	XTend Getr. / GBox: GO 210 Nabenprofil / Hub Profile: 41,1x50,8-10N Nur zusammen verbauen / Only install together	(48) (53)	
			 3400 700 512 	430 10	XTend Getr. / GBox: AS Tronic Nabenprofil / Hub Profile: 41,1x50,8-10N Nur zusammen verbauen / Only install together	(48) (53)	
			 3151 000 144	KZISZ-5	Getr. / GBox: AS Tronic für Ausrückgabel mit Nocken / for release fork with cams	(70)	
			 3151 000 493	KZISZ-5	Getr. / GBox: AS Tronic für Ausrückgabel mit Rollen / for release fork with rollers	(71)	
			 1863 869 028				
			 3189 600 004		Getr. / GBox: ZF AS Tronic Rollenausführung / roller version	(58)	
		OM457.944, OM457.961	 6594 000 079	430 430Z	für / for: SA522019-08/15 enthält Schwungradbefestigungsschrauben / includes bolt for flywheel mounting	(69) (66)	
		OM542.966, OM542.948	 3189 600 004		Getr. / GBox: ZF AS Tronic Rollenausführung / roller version	(58)	
TopClass S 431 DT 410.001 317.011	10.02 -	OM502	 3400 700 509 	430 10	XTend Nabenprofil / Hub Profile: 41,1x50,8-10N Leistung [kW] / Engine Output [kW]: 320 Leistung [kW] / Engine Output [kW]: 350 Nur zusammen verbauen / Only install together	(48) (40) (40) (53)	
			 3400 700 525 	430 10	XTend Nabenprofil / Hub Profile: 41,1x50,8-10N Leistung [kW] / Engine Output [kW]: 370 Nur zusammen verbauen / Only install together	(48) (40) (53)	
			 3151 000 335	KZIZ-5	Leistung [kW] / Engine Output [kW]: 320 Leistung [kW] / Engine Output [kW]: 350 Leistung [kW] / Engine Output [kW]: 370	(40) (40) (40)	
			 1863 869 028				
		OM542.948					
TopClass S 431 DT 410.001	10.02 -	OM502	 3400 700 509 	430 10	XTend Nabenprofil / Hub Profile: 41,1x50,8-10N Leistung [kW] / Engine Output [kW]: 320 Leistung [kW] / Engine Output [kW]: 350 Nur zusammen verbauen / Only install together	(48) (40) (40) (53)	
			 3400 700 525 	430 10	XTend Nabenprofil / Hub Profile: 41,1x50,8-10N Leistung [kW] / Engine Output [kW]: 370 Nur zusammen verbauen / Only install together	(48) (40) (53)	
			 3482 000 852	430 MFZ430	für / for: 2300 [Nm] Getr. / GBox: Powershift	(69)	
		 1878 005 541	430 10 430WGTZ	für / for: 2300 [Nm] Getr. / GBox: Powershift	(69)		
		 3151 000 335	KZIZ-5	für / for: 2300 [Nm] Getr. / GBox: Powershift	(69)		
		 1863 869 028		für / for: SA 505120-01	(69)		
		OM542.948					

		CODE				
---	--	------	--	---	---	---

SETRA



























Series 500		01.12 -			
ComfortClass S 511 HD 410.200	01.14-	OM470.908	 3400 700 548 ■ 430 18	XTend Nabenprofil / Hub Profile: 45x50-18N Nur zusammen verbauen / Only install together	(48) (53)
ComfortClass S 515 HD 410.120	01.14-		 6594 000 218 430		
ComfortClass S 515 HDH 410.120	01.14-				
ComfortClass S 515 MD 410.270	01.14-				
ComfortClass S 515 MD 410.270	01.14-				
ComfortClass S 516 HD 410.250	01.12-				
ComfortClass S 516 HD 410.250	01.13-				
ComfortClass S 516 HDH 410.230	01.14-				
ComfortClass S 516 MD 410.280	01.14-				
ComfortClass S 516 MD 410.280	01.14-				
ComfortClass S 517 HD 410.250	01.14-				
ComfortClass S 519 HD 410.260	01.14-				
ComfortClass S 515 HDH 410.120	01.14-	OM471.902	 3400 710 073 ■ 430 18	Nabenprofil / Hub Profile: 45x50-18N mit automatischer Nachstellung / with automatic adjustment Nur zusammen verbauen / Only install together	(48) (95) (53)
ComfortClass S 517 HD 410.130	01.12-				
ComfortClass S 517 HD 410.130	01.14-		 6594 000 219 430		
ComfortClass S 519 HD 410.260	01.14-				
TopClass S 515 HDH 410.120	01.14-				
ComfortClass S 515 MD 410.270	01.14-	OM936.915	 3400 700 540 ■ 430 18	XTend Nabenprofil / Hub Profile: 45x50-18N Nur zusammen verbauen / Only install together	(48) (53)
TopClass S 515 HDH 410.120	01.14-	OM471.902	 3400 710 073 ■ 430 18	Getr. / GBox: Powershift Nabenprofil / Hub Profile: 45x50-18N mit automatischer Nachstellung / with automatic adjustment Nur zusammen verbauen / Only install together	(48) (95) (53)
TopClass S 516 HDH 410.130	01.13-				
TopClass S 516 HDH 410.130	01.14-		 6594 000 219 430	Getr. / GBox: Powershift	
TopClass S 517 HDH 410.140	01.14-				
TopClass S 517 HDH 410.140	01.14-				

SINOTRUK (CNHTC)







HOWO		07.05 -			
JK6127HQA		WD615.95C	 3482 083 118 430	Getr. / GBox: S6-160 Euro 3 / Euro 3	(15)
			 1878 007 103 430 10	MFZ430 Getr. / GBox: S6-160 Euro 3 / Euro 3	(15)
			 3151 000 157 KZISZ-5	430WGTZ Getr. / GBox: S6-160 Euro 3 / Euro 3	(15)
JK6128H		YC6L330-30	 3482 124 549 430	GMF430 Getr. / GBox: S6-150 Euro 3 / Euro 3	(15)
			 1878 026 241 430 10	430WGTZ Getr. / GBox: S6-150 Euro 3 / Euro 3	(15)
JK6108H		YC6J245-30	 3482 124 550 430	GMF430 Getr. / GBox: S6-150 Euro 3 / Euro 3	(15)
			 1878 026 241 430 10	430WGTZ Getr. / GBox: S6-150 Euro 3 / Euro 3	(15)
JK6128HD		WD615.95C	 3482 083 118 430	MFZ430 Getr. / GBox: HW15706 Euro 3 / Euro 3	(15)
			 1878 007 103 430 10	430WGTZ Getr. / GBox: HW15706 Euro 3 / Euro 3	(15)

		CODE				
---	--	------	--	---	---	---

TAM





Bus						
75 A5,6				1880 083 132 #	280 G280	
120 B3				3482 083 032	430 MFZ430	
				1878 004 832	430 10 430WGTZ	
				3151 000 034	KZISZ-5	
125 A 11T,P 3000 A 3000 3500 AS 3500,D125				1881 039 532 #	350 G350KR	
				1878 001 074	350 10 350GTZ	
190 107M	-04.90			1882 325 134	380 G380	
190 A11	-04.90			1878 001 152	380 10 380WGTZ	
190 A110	05.90-					
190 A94,102,131	-04.90					
260				1800 125 301	420 10 GF420	
				3482 124 534 ●	430 GMF430	
260 A113 260 A116 260 A117 260 A119 260 A120 260 A180 321 A119				1878 003 657	420 10 420WGTZ	
				1882 342 134	420 GF420X	ZF-Getriebe / ZF Transmission (62)
				1878 003 657	420 10 420WGTZ	ZF-Getriebe / ZF Transmission (62)
				3151 126 031	KZI-4,5	ZF-Getriebe / ZF Transmission (62)
				1878 001 074	350 10 350GTZ	
				3482 000 463	395 MF395	
3500 AS 3500 D150				1862 506 131	395 10 395WGTZ	
				3151 000 419	KZIS-4	
				3482 000 463	395 MF395	
TVM Marbus B3 090 TH TVM Marbus B3 090 TL TVM Marbus B3 090 TLL		D0836LOHEuroII		1862 506 131	395 10 395WGTZ	
				3151 000 419	KZIS-4	
				3482 000 463	395 MF395	
TVM Marbus B4 080 TS		D0834LOH02, EuroIII		1862 506 131	395 10 395WGTZ	
				3151 000 419	KZIS-4	
				3482 000 463	395 MF395	





























TEMSA

OPALIN						
Opalin 9		D0836LOH56		3482 000 463	395 MF395	für / for: Euro 3 (69) für / for: Euro 4 (69)
				1862 506 131	395 10 395WGTZ	für / for: Euro 3 (69)
				1878 001 709	395 10 395WGTZ	für / for: Euro 4 (69)
SAFARI						
Safari 13		DAFXE315C1		3482 083 032	430 MFZ430	Getr. / GBox: ZF 8S-180
				1878 080 037	430 10 430WGTZ	Getr. / GBox: ZF 8S-180
				3151 000 157	KZISZ-5	Getr. / GBox: ZF 8S-180

		CODE				
---	--	------	--	---	---	---

































VAN HOOL

A 120						
A 120	MAN		3482 124 541	430 GMF430		
			1882 330 032 ●#	420 GF420		
			1878 001 136	420 10 420GTZ		
			3151 000 515	KZIS-4		
	DAF		1878 001 138	420 10 420GTZ		

8..						
812 813 814 815 A 815 C 815 TL	MAN240/280PS		3482 124 534	430 GMF430		
			1882 301 239 ●	420 GF420		
			1878 002 706	420 10 420GTZ		
			3151 000 515	KZIS-4		
815	DAFDKX1160		1882 342 134	420 GF420X		
			1878 002 706	420 10 420GTZ		
			3151 000 395	KZIS-4		
	DBOM422A		1882 342 134	420 GF420X		
			1878 002 706	420 10 420GTZ		
			3151 000 395	KZIS-4		
	DBOM422LA		3482 124 549	430 GMF430		
			1882 342 135 ●#	420 GF420X	Nur bei Altteil-Rückgabe lieferbar (Reparatur; Werk Bielefeld) / Please return old unit for repair (plant Bielefeld)	(51)
			1878 086 741	420 10 430WGTZ		
			3151 000 395	KZIS-4		
	MAND2866FH		3482 018 132 #	420 GMF420		
			3482 119 031	430 GMF430		
			1878 086 741	420 10 430WGTZ		
			3151 249 001	KZI-5		
	MAND2866KOH		3482 124 549	430 GMF430		
			1882 342 135 ●#	420 GF420X	Nur bei Altteil-Rückgabe lieferbar (Reparatur; Werk Bielefeld) / Please return old unit for repair (plant Bielefeld)	(51)
			1878 086 741	420 10 430WGTZ		
			3151 000 395	KZIS-4		
	MAND2866OH		1882 342 134	420 GF420X		
			3151 000 395	KZIS-4		
MAND2866TOH , LOH		1882 342 134	420 GF420X			
		1878 002 706	420 10 420GTZ			
		3151 000 395	KZIS-4			
815, A 815 C	Fiat		3482 085 033	420 MF420	enthält Druckplattenbefestigungsschrauben / includes bolt for pressure plate mounting	(65)
			1878 001 138	420 10 420GTZ		
815 A	DAF		3400 700 305	430 10		







		CODE				
---	--	------	--	---	---	---











VAN HOOL

8..						
815, A TD 824	Fiat	 3482 085 033	420 MF420	enthält Druckplattenbefestigungsschrauben / includes bolt for pressure plate mounting		(65)
		 1878 002 955	420 10 420GTZ			
		 3151 000 515	KZIS-4			
815 GT	5LF, D2866LOH, MAND2566M TH, D286	 1882 342 134	420 GF420X			
		 1878 002 706	420 10 420GTZ			
		 3151 000 395	KZIS-4			
	DMOM422, A	 1882 342 134	420 GF420X			
		 1878 002 706	420 10 420GTZ			
		 3151 000 395	KZIS-4			
815 TLC	MAND2866LUH 08	 3482 119 031	430 GMF430	Getr. / GBox: ZF6S-85		
		 1878 061 841	430 10 430WGTZ	Getr. / GBox: ZF6S-85		
		 3151 249 001	KZI-5	Getr. / GBox: ZF6S-85		
		 3151 000 034	KZISZ-5	Getr. / GBox: ZF6S-85		
816 (Altano Royal)	MAND2866	 3482 124 549	430 GMF430			
		 1882 342 135 ●#	420 GF420X	Nur bei Altteil-Rückgabe lieferbar (Reparatur; Werk Bielefeld) / Please return old unit for repair (plant Bielefeld)		(51)
		 1878 086 741	420 10 430WGTZ			
		 3151 000 395	KZIS-4			
818	MAND2566MKU H	 1882 342 134	420 GF420X			
		 1878 002 706	420 10 420GTZ			
		 3151 000 395	KZIS-4			
	MAND2866KUH	 3482 124 549	430 GMF430			
		 1882 342 135 ●#	420 GF420X	Nur bei Altteil-Rückgabe lieferbar (Reparatur; Werk Bielefeld) / Please return old unit for repair (plant Bielefeld)		(51)
		 1878 086 741	420 10 430WGTZ			
T 811	MAN	 1882 302 131	380 GF380			
		 1878 001 152	380 10 380WGTZ			
		 3151 000 395	KZIS-4			
T 815 UL	2866LOH07	 3482 119 031	430 GMF430	Getr. / GBox: 6-85 ZF-Getriebe / ZF Transmission		(62)
		 1878 086 741	420 10 430WGTZ	Getr. / GBox: 6-85 ZF-Getriebe / ZF Transmission		(62)
		 3151 249 001	KZI-5	Getr. / GBox: 6-85 ZF-Getriebe / ZF Transmission		(62)
TD 824	OM422LA, D2866KOH,	 3482 124 549	430 GMF430			
		 1882 342 135 ●#	420 GF420X	Nur bei Altteil-Rückgabe lieferbar (Reparatur; Werk Bielefeld) / Please return old unit for repair (plant Bielefeld)		(51)
		 1878 086 741	420 10 430WGTZ			
		 3151 000 395	KZIS-4			



		CODE					
---	--	------	--	--	---	---	---

VAN HOOL



8..							
TD 824 E		DBOM422LA		1882 342 134	420 GF420X		
				1878 002 706	420 10 420GTZ		
				3151 000 395	KZIS-4		
TD 827		D2866LOH		3488 017 333	400 MFZ2/400X	enthält eine Kupplungsscheibe / This part number includes one clutch disc	(67)
				1862 303 031 ▽	400 10 400WGVZ	Lose Kupplungsscheibe / Loose clutch disc	(41)
				3151 000 034	KZISZ-5		
				1862 302 031 △	400 8 400GVZ	In 3483/3488 enthalten / Contained in 3483, 3488	(32)

9..							
915		MAN2866LOH2 3		3482 119 031	430 GMF430	Getr. / GBox: ZF 8S180	
				1878 086 742 #	420 10 420GTZ	Getr. / GBox: ZF 8S180	
				3151 249 001	KZI-5	Getr. / GBox: ZF 8S180	
T 911 Alicron T 915 Acron T 915 Alicron T 916 Altano T 917 Acron T 917 Altano T 917 Astron T 918 Altano		D2866LOH29		3488 000 108 #⊕	400 MFZ2/400X	Getr. / GBox: ZF 8S-180 enthält eine Kupplungsscheibe / This part number includes one clutch disc	(67)
				1878 002 643	400 10 400WGTZ	Getr. / GBox: ZF 8S-180	
TD 924 Astromega TD 927 Astromega		D2876LOH02		3482 000 209	430 MFZ430	Getr. / GBox: ZF 8S-180	
				1878 085 641	430 10 430GTZ	Getr. / GBox: ZF 8S-180	
				3151 000 278	KZISZ-5	Getr. / GBox: ZF 8S-180	
				3488 000 108 ●#⊕	400 MFZ2/400X	Getr. / GBox: ZF 8S-180 für Fahrzeuge mit Zweis Scheibenkupplung / for vehicles with double disc clutch enthält eine Kupplungsscheibe / This part number includes one clutch disc	(77) (67)
				1878 002 643 ●	400 10 400WGTZ	Getr. / GBox: ZF 8S-180 für Fahrzeuge mit Zweis Scheibenkupplung / for vehicles with double disc clutch	(77)
				3189 600 059		Getr. / GBox: ZF 8S-180	

VDL

BUS							
SBR 4000		MX13.375		3400 700 467	430 10 MFZ430	->06.2014 Getr. / GBox: 12 AS 2301 BO Euro 5 / Euro 5	(17)
				3482 000 484 1878 003 767 3151 000 493	430WGTZ KZISZ-5		
				3189 600 004		Getr. / GBox: ZF AS Tronic Rollenausführung / roller version	(58)























VOLKSWAGEN

LT 28-35 Bus (281-363) 04.75 - 06.96							
2.4	12.82-07.92	DL		3000 055 006 ▲ 3082 190 031 1861 897 034 3151 193 041	228 23 M228 228TB KZIS-0		
				1863 869 002	24	Nadellager / Needle Bearing	(49)
				3074 003 343 LHD		08.1989->	



























		CODE					
---	--	------	--	--	---	---	---

VOLKSWAGEN

LT 28-35 I Bus (281-363) 04.75 - 06.96





















2.4 i	08.89-06.96	1E	 3000 055 006 ▲  3082 190 031  1861 897 034  3151 193 041	228 23 M228 228TB KZIS-0			
			 1863 869 002		24	Nadellager / Needle Bearing	(49)
			 3074 003 343 <small>LHD</small>			->12.1995	
2.4 D, 51 kW 2.4 TD, 70 kW	08.89-06.96 09.92-06.96	ACL, 1S, ACT	 3000 055 005  3082 190 031  1878 004 776  3151 193 041	228 23 M228 220VTPB KZIS-0			
			 1863 869 002		24	Nadellager / Needle Bearing	(49)
			 3074 003 343 <small>LHD</small>			->12.1995	
2.4 D, 55 kW	01.79-07.92	DW, CP	 3000 055 005  3082 190 031  1878 004 776  3151 193 041	228 23 M228 220VTPB KZIS-0			
			 1863 869 002		24	Nadellager / Needle Bearing	(49)
		DW	 3074 003 343			08.1989->	
2.4 TD, 68 kW 2.4 TD, 75 kW	08.89-08.92 12.82-07.89	DV, 1G	 3000 055 005  3082 190 031  1878 004 776  3151 193 041	228 23 M228 220VTPB KZIS-0			
			 1863 869 002		24	Nadellager / Needle Bearing	(49)

LT 28-35 II Bus (2DB, 2DE, 2DK) 04.96 - 07.06











2.3	05.96-07.06	AGL	 3000 826 901  3082 268 031  1878 994 001  3151 248 031	240 26 M240 240TB KZIS-0			
			 6283 600 115				
			 6284 600 573				
2.5 SDI	07.96-07.06	AGX	 3000 845 801  3082 639 402  1878 988 102  3151 248 031	240 26 MF240 240TB KZIS-0			
			 1863 869 005		24	Nadellager / Needle Bearing	(49)
			 6283 600 115				
			 6284 600 573				
2.5 TDI, 61 kW 2.5 TDI, 70 kW	05.01-07.06 05.01-07.06	BBF, BBE	 3000 951 104  3082 600 522  1878 988 102  3151 248 031	240 26 M240 240TB KZIS-0			
			 1863 869 005		24	Nadellager / Needle Bearing	(49)
			 6283 600 115				
			 6284 600 573				
2.5 TDI, 66 kW	05.99-07.06	APA	 3000 845 101  3082 308 043  1878 988 102  3151 248 031	240 26 MF240 240TB KZIS-0			
			 1863 869 005		24	Nadellager / Needle Bearing	(49)
			 6283 600 115				
			 6284 600 573				

		CODE					
---	--	------	--	--	---	---	---

VOLKSWAGEN































LT 28-35 II Bus (2DB, 2DE, 2DK) 04.96 - 07.06							
2.5 TDI, 75 kW	05.96 - 08.99	AHD		3000 845 101 ⊗ 3082 308 043 ⊗ 1878 988 102 ⊙ 3151 248 031	240 26 MF240 240TB KZIS-0	für / for: LT 46	(69)
				3000 828 601 ⊗ 3082 308 043 ⊗ 1864 528 442 ⊙ 3151 248 031	240 26 MF240 240B KZIS-0	->Mot. 047 378 für / for: LT 28/35	(69)
				3000 845 101 ⊗ 3082 308 043 ⊗ 1878 988 102 ⊙ 3151 248 031	240 26 MF240 240TB KZIS-0	Mot. 047 379-> für / for: LT 28/35	(69)
				1863 869 005	24	Nadellager / Needle Bearing	(49)
				6283 600 115			
				6284 600 573			
2.5 TDI, 80 kW	05.99 - 07.06	ANJ		3000 951 710 ⊗ 3082 600 509 ⊗ 1878 988 102 ⊙ 3151 248 031	240 26 MF240 240TB KZIS-0	->Mot. 052609	
				3000 951 104 ⊗ 3082 600 522 ⊗ 1878 988 102 ⊙ 3151 248 031	240 26 M240 240TB KZIS-0	Mot. 052610->	
				3000 951 104 ⊗ 3082 600 522 ⊗ 1878 988 102 ⊙ 3151 248 031	240 26 M240 240TB KZIS-0		
		AVR		1863 869 005	24	Nadellager / Needle Bearing	(49)
			6283 600 115				
			6284 600 573				
2.8 TDI, 92 kW	07.97 - 05.03	AGK		3000 845 001 ⊗ 3082 919 001 ⊗ 1864 528 442 ⊙ 3151 248 031	240 26 MF240 240B KZIS-0		
				1863 869 005	24	Nadellager / Needle Bearing	(49)
2.8 TDI, 96 kW	01.99 - 01.02	ATA		3000 845 001 ⊗ 3082 919 001 ⊗ 1864 528 442 ⊙ 3151 248 031	240 26 MF240 240B KZIS-0		
				1863 869 005	24	Nadellager / Needle Bearing	(49)
2.8 TDI, 116 kW	05.01 - 06.06	AUH, BCQ		3000 951 107 ■	240 26	XTend ->Chass. 2D-2-036 000 Nabenprofil / Hub Profile: 26,5x28,9-26N nur in Verbindung mit / only in connection with: 062 105 266 F	(48) (101)
				3000 951 107 ■	240 26	XTend Chass. 2D-2-036 001-> Nabenprofil / Hub Profile: 26,5x28,9-26N	(48)
Volksbus 08.01 - 06.08							
18.310 OT 18.320 EOT 18.320 EOT	09.05 - 09.05 - 09.05 -	6CTAA8.3, ISC320		3483 000 238 ⊕	395 GMFZ395		
				1878 002 218	395 10 395WGTZ		

VOLVO





B 10	01.78 - 12.01						
B 10 B B 10 BLE		KFD117C/D		<u>3483 034 032</u> ⊕	430 MFZ430	-> Chass. 393 Getr. / GBox: G7-EGS Getr. / GBox: G8-EGS	
				<u>1878 634 026</u>	430 10 430WGTZ	-> Chass. 393 Getr. / GBox: G7-EGS Getr. / GBox: G8-EGS	
				3482 123 235	430 MFZ430	-> Chass. 393 Getr. / GBox: G7-EGS Getr. / GBox: G8-EGS In 3483/3488 enthalten / Contained in 3483, 3488	(32)
		KFD117E		3400 043 032 ⊕ ⊗ 3483 034 033 ⊗ 1878 634 026	430 10 MFZ430 430WGTZ	Chass. 394-> Getr. / GBox: G7-EGS Getr. / GBox: G8-EGS	
				3482 123 234	430 MFZ430	Chass. 394-> Getr. / GBox: G7-EGS Getr. / GBox: G8-EGS In 3483/3488 enthalten / Contained in 3483, 3488	(32)
				3483 034 033 HD⊕	430 MFZ430	Getr. / GBox: VT2412B	
		KFD116B		3400 125 601 ⊕ ⊗ 3483 022 032 ⊗ 1878 003 779	400 10 MFZ400X 400WGTZ	-> Chass. 7014 Getr. / GBox: S6-85	
				3482 101 032	400 MFZ400X	-> Chass. 7014 Getr. / GBox: S6-85 In 3483/3488 enthalten / Contained in 3483, 3488	(32)
		KFD117		<u>3483 034 045</u> ⊕	430 MFZ430	Chass. 7015-> Getr. / GBox: S6-85	
				<u>1878 040 334</u>	430 10 430WGTZ	Chass. 7015-> Getr. / GBox: S6-85	
B 10 R	01.78 -			1800 107 133 # ⊗ 1882 226 533 ⊗ 1878 006 951 ◦ 3151 600 534	420 10 G420 420GTZ KZA-4	Mot. THD 100 D, E Getr. / GBox: S6-80 ,	































		CODE				
---	--	------	--	---	---	---

VOLVO

B 10		01.78 - 12.01					
B10M B10M B10M	01.94 -	KFD214A	 1800 107 133 #  1882 226 533  1878 006 951  3151 600 534	420 10 G420 420GTZ KZA-4	Mot. THD 101 G, K Mot. THD 100 D, E Getr. / GBox: S6-80 ,S6-90		
			1800 125 001  1882 250 143  1878 001 079 1878 001 083  3151 600 533  1874 000 098	350 10 GF2/350 350GTZ 350GTZ KZA-4	Chass. 11500 - Chass. 11540 Chass. 11643 - Chass. 27774 Mot. THD 101 G, K Getr. / GBox: S6-90 ohne Zwischenring / without intermediate ring	(106)	
			 1888 019 445 #	350 GF2/350	Chass. 11500 - Chass. 11540 Chass. 11643 - Chass. 27774 Mot. THD 101 G, K Getr. / GBox: S6-90 enthält eine Kupplungsscheibe / This part number includes one clutch disc	(67)	
			 1878 001 083 ▽	350 10 350GTZ	Chass. 11500 - Chass. 11540 Chass. 11643 - Chass. 27774 Mot. THD 101 G, K Getr. / GBox: S6-90 Lose Kupplungsscheibe / Loose clutch disc	(41)	
			 3151 600 533	KZA-4	Chass. 11500 - Chass. 11540 Chass. 11643 - Chass. 27774 Mot. THD 101 G, K Getr. / GBox: S6-90		
			 3400 106 031 ⊕  3483 034 032  1862 530 231	430 10 MFZ430 430WGTZ	->Chass. 25456 Mot. THD 101 G Mot. THD 102 K Getr. / GBox: G7-EGS		
			 3400 040 032 ●⊕  3483 034 032  1878 004 456	430 10 MFZ430 430GVZ	->Chass. 25456 Mot. THD 101 G Mot. THD 102 K Getr. / GBox: G7-EGS		
			 3483 034 032 ⊕	430 MFZ430	Chass. 25457-> Mot. KE Mot. THD 101 G Mot. THD 102 K Getr. / GBox: G7-EGS		
			 1878 634 026	430 10 430WGTZ	Chass. 25457-> Mot. KE Mot. THD 101 G Mot. THD 102 K Getr. / GBox: G7-EGS		
			 3400 031 033 ⊕  3483 014 132  1878 001 080 1878 001 082  3474 012 000	350 10 GMFZ2/350 350GTZ 350GTZ	Chass. 20001 - Chass. 25456 Mot. THD 102 K Getr. / GBox: G7-EGS ohne Zwischenring / without intermediate ring	(106)	
			 3488 013 138 ⊕	350 GMFZ2/350	Chass. 20001 - Chass. 25456 Mot. THD 102 K Getr. / GBox: G7-EGS enthält eine Kupplungsscheibe / This part number includes one clutch disc	(67)	
			 1878 001 082	350 10 350GTZ	Chass. 20001 - Chass. 25456 Mot. THD 102 K Getr. / GBox: G7-EGS		
			KFD116B	 3400 125 601 ⊕  3483 022 032  1878 003 779	400 10 MFZ400X 400WGTZ	->Chass. 52525 Getr. / GBox: S6-85	
			KFD117	 3483 034 045 ⊕	430 MFZ430	Chass. 52526-> Getr. / GBox: S6-85	
				 1878 040 334	430 10 430WGTZ	Chass. 52526-> Getr. / GBox: S6-85	

VOLVO















B11R		09.11 -				
B11R	09.11-			3400 710 064  3482 001 310  1878 007 170  6482 000 155	430 24 MFZ430 430WGTZ PHIS-6/38	Getr. / GBox: AT 2412 E+F
B11R	09.11-					
B11R	09.11-					
B11R	09.11-					
B11R	09.11-					
B11R	09.11-					
B11R	09.13-					
B11R	09.13-					
B11R	09.13-					
B11R	09.13-					

B 12		01.92 -				
B 12	02.06-			3400 700 342 ⊕  3483 034 033  1878 000 634	430 24 MFZ430 430WGTZ	
B 12	02.06-			3400 700 350 ⊕  3483 034 042  1878 000 634	430 24 MFZ430 430WGTZ	
				3400 710 060  3482 001 307  1878 003 867  6482 000 155	430 24 MFZ430 430WGTZ PHIS-6/38	
B 12				3400 125 601 ⊕  3483 022 032  1878 003 779	400 10 MFZ400X 400WGTZ	Mot. TD 73 E
				3482 101 032	400 MFZ400X	Mot. TD 73 E In 3483/3488 enthalten / Contained in 3483, 3488 (32)
B 12	01.92-			3483 034 032 ⊕	430 MFZ430	Mot. TD 122 FH
				1878 634 026	430 10 430WGTZ	Mot. TD 122 FH
B 12	01.92-			3483 034 032 ⊕	430 MFZ430	Mot. TD 122 FH, FL Getr. / GBox: G7-EGS
				1878 634 026	430 10 430WGTZ	Mot. TD 122 FH, FL Getr. / GBox: G7-EGS
				3482 123 235	430 MFZ430	Mot. TD 122 FH, FL Getr. / GBox: G7-EGS In 3483/3488 enthalten / Contained in 3483, 3488 (32)
B 12	01.92-			3483 034 033 ⊕	430 MFZ430	Mot. D12A420
				1878 634 026	430 10 430WGTZ	Mot. D12A420
B 12 M (Chassis)		KFD117E		3400 700 342 ⊕  3483 034 033  1878 000 634	430 24 MFZ430 430WGTZ	Getr. / GBox: EGS-V, EGS-VR
				3482 123 234	430 MFZ430	Getr. / GBox: EGS-V, EGS-VR In 3483/3488 enthalten / Contained in 3483, 3488 (32)
		KFD117F		3483 034 042 ⊕	430 MFZ430	Getr. / GBox: 6S-1600
				1878 634 026	430 10 430WGTZ	Getr. / GBox: 6S-1600
				3482 123 234	430 MFZ430	Getr. / GBox: 6S-1600 In 3483/3488 enthalten / Contained in 3483, 3488 (32)
				3400 700 350 ⊕  3483 034 042  1878 000 634	430 24 MFZ430 430WGTZ	Getr. / GBox: VT2412B
	3482 123 234		430 MFZ430	Getr. / GBox: VT2412B In 3483/3488 enthalten / Contained in 3483, 3488 (32)		

B 51 - B 59						
B 57, BB 57	01.72-			3400 037 031  3482 021 031  1878 000 961  3151 600 533	380 10 GM380 380GTZ KZA-4	->Chass. 9780 Mot. TD 70 E, H, HA Getr. / GBox: S6-65

		CODE				
---	--	------	--	---	---	---

VOLVO

B 51 - B 59						
B 57, BB 57				3482 021 031	380 GM380	Chass. 9781-> Mot. TD 70 E, H, HA Getr. / GBox: S6-65
				1878 000 961	380 10 380GTZ	Chass. 9781-> Mot. TD 70 E, H, HA Getr. / GBox: S6-65
				1882 325 134	380 G380	Chass. 1563-> Mot. TD 70 A, B Getr. / GBox: K 191
				1878 000 961	380 10 380GTZ	Chass. 1563-> Mot. TD 70 A, B Getr. / GBox: K 191
B 58				1800 107 133 # ⊗ 1882 226 533 ⊗ 1878 006 951 ⊙ 3151 600 534	420 10 G420 420GTZ KZA-4	Mot. THD 100 DD Getr. / GBox: ZF S6-80
				1800 125 601 # ⊗ 1882 226 533 ⊗ 1878 006 951 ⊙ 3151 105 141	420 G420 420GTZ KZI-5	Mot. D Mot. HD 100A, L/THD 100A, Getr. / GBox: K 191
B 6 11.91 -						
B 6 / B 6 BLE				3482 909 001 #	350 MF350	Chass. 5000-> Mot. TD 63 E
				1878 076 031	350 10 350GTB	Chass. 5000-> Mot. TD 63 E
				3151 600 534	KZA-4	Chass. 5000-> Mot. TD 63 E
B 6 , F, FA	12.78 -			3400 116 201 # ⊗ 3482 909 001 ⊗ 1878 076 031 ⊙ 3151 600 535	350 10 MF350 350GTB KZA-4	Mot. TD 60
B6R, B6LE B6R, B6LE	11.91 - 11.91 -			3482 909 001 #	350 MF350	
				1878 076 031	350 10 350GTB	
				3151 600 534	KZA-4	
B 609 - B 7000						
B 609 B 610	12.78 - 12.78 -			3400 116 201 # ⊗ 3482 909 001 ⊗ 1878 076 031 ⊙ 3151 600 535	350 10 MF350 350GTB KZA-4	Mot. TD 60
B 7 01.92 -						
B 7				3400 037 031 ⊗ 3482 021 031 ⊗ 1878 000 961 ⊙ 3151 600 533	380 10 GM380 380GTZ KZA-4	Chass. 20000-> Mot. TD 71 G



CODE



SACHS

Parameter



VOLVO

B 7









































01.92 -

B7R / B7R LE

B7R / B7R LE	01.92 -	KFD116B	3400 125 601 ⊕ 3483 022 032 1878 003 779	400 10 MFZ400X 400WGTZ	->Chass. 2163 Getr. / GBox: S6-85		
			3482 101 032	400 MFZ400X	->Chass. 2163 Getr. / GBox: S6-85 In 3483/3488 enthalten / Contained in 3483, 3488	(32)	
			3482 101 032	400 MFZ400X	->Chass. 2163 Getr. / GBox: S6-90		
			1878 003 779	400 10 400WGTZ	->Chass. 2163 Getr. / GBox: S6-90		
			3400 125 601 ⊕ 3483 022 032 1878 003 779	400 10 MFZ400X 400WGTZ	->Chass. 355806 Getr. / GBox: S6-820,S6-1550		
			3482 101 032	400 MFZ400X	->Chass. 355806 Getr. / GBox: S6-820,S6-1550 In 3483/3488 enthalten / Contained in 3483, 3488	(32)	
		KFD117		3483 034 045 ⊕	430 MFZ430	Chass. 2164-> Getr. / GBox: S6-85	
				3482 123 235	430 MFZ430	Chass. 2164-> Getr. / GBox: S6-85 In 3483/3488 enthalten / Contained in 3483, 3488	(32)
				1878 040 334	430 10 430WGTZ	Chass. 2164-> Getr. / GBox: S6-85	
				3483 034 044 ⊕	430 MFZ430	Chass. 2164-> Getr. / GBox: S6-90	
				3482 123 235	430 MFZ430	Chass. 2164-> Getr. / GBox: S6-90 In 3483/3488 enthalten / Contained in 3483, 3488	(32)
				1878 040 334	430 10 430WGTZ	Chass. 2164-> Getr. / GBox: S6-90	
		KFD117C		3482 123 235	430 MFZ430	Chass. 355807-> Getr. / GBox: S6-820,S6-1550	
				1878 003 779	400 10 400WGTZ	Chass. 355807-> Getr. / GBox: S6-820,S6-1550	
				3100 002 549 3151 000 218 3180 001 008	KZIZ-5 KZISZ-5	Chass. 355807-> Getr. / GBox: S6-820,S6-1550	
		KFD117E		3400 127 201 ⊕ 3483 034 033 1862 530 231	430 10 MFZ430 430WGTZ	->Chass. 6485 Getr. / GBox: EGS-V,EGS-VR	
				3483 034 033 ⊕	430 MFZ430	Chass. 6486-> Getr. / GBox: EGS-V,EGS-VR	
				1878 001 215	430 24 430WGTZ	Chass. 6486-> Getr. / GBox: EGS-V,EGS-VR	
				3482 123 234	430 MFZ430	Getr. / GBox: EGS-V,EGS-VR In 3483/3488 enthalten / Contained in 3483, 3488	(32)
				3483 034 045 ⊕	430 MFZ430	Getr. / GBox: 6S-1380BD	
				3482 123 235	430 MFZ430	Getr. / GBox: 6S-1380BD In 3483/3488 enthalten / Contained in 3483, 3488	(32)
B 7	01.98 -	CL43S-0	3400 127 101 ⊕ 3483 034 034 1878 634 026	430 10 MFZ430 430WGTZ	Getr. / GBox: VT2014,2514		
			3400 127 201 ⊕ 3483 034 033 1862 530 231	430 10 MFZ430 430WGTZ	Getr. / GBox: R/SR1400		
			3482 123 234	430 MFZ430	Getr. / GBox: R/SR1400 Getr. / GBox: VT2014,2514 In 3483/3488 enthalten / Contained in 3483, 3488	(32)	
		3189 600 061					

		CODE				
---	--	------	--	---	---	---











VOLVO

B 9		01.02 -					
B 9 M	01.79-		 3400 037 032  3482 021 031  1878 000 961  3151 824 005	380 10 GM380 380GTZ KZA-4	->Chass. 11499 Chass. 11540 - Chass. 11643 Mot. THD 100 D, E Getr. / GBox: S6-65		
			 1800 107 133 #  1882 226 533  1878 006 951  3151 600 534	420 10 G420 420GTZ KZA-4	->Chass. 11499 Mot. THD 100 D, E Getr. / GBox: S6-80		
B 9	09.05-		 3483 034 042 ⊕	430 MFZ430	Getr. / GBox: ZF6S-1600		
B 9	09.05-		 1878 634 026	430 10 430WGTZ	Getr. / GBox: ZF6S-1600		
B 9	09.05-		 3100 026 431  3151 000 154  3180 000 009	KZISZ-5	Getr. / GBox: ZF6S-1600 Beinhaltet Ausrücker und Montagesatz / Contains releaser and fitting kit In 3483/3488 enthalten / Contained in 3483, 3488	(9)	(32)
B 9	09.05-		 3400 700 342 ⊕  3483 034 033  1878 000 634	430 24 MFZ430 430WGTZ	Getr. / GBox: EGS-V / EGS-VR		
B 9	09.05-		 3400 710 060  3482 001 307  1878 003 867  6482 000 155	430 24 MF430 430WGTZ PHIS-6/38	Getr. / GBox: AT2412C		
B 9	09.05-		 1863 869 037	72			
C 10							
C 10 M	01.84-		 1800 125 001  1882 250 143  1878 001 079  1878 001 083  3151 600 533  1874 000 098	350 10 GF2/350 350GTZ 350GTZ KZA-4	Mot. THD 101 G, K Getr. / GBox: S6-90 ohne Zwischenring / without intermediate ring		(106)
			 1888 019 445 #	350 GF2/350	Mot. THD 101 G, K Getr. / GBox: S6-90 enthält eine Kupplungsscheibe / This part number includes one clutch disc		(67)
			 1878 001 083 ▽	350 10 350GTZ	Mot. THD 101 G, K Getr. / GBox: S6-90 Lose Kupplungsscheibe / Loose clutch disc		(41)
			 3151 600 533	KZA-4	Mot. THD 101 G, K Getr. / GBox: S6-90		
			 1859 170 204	350 GF2/350	Mot. THD 101 G, K Getr. / GBox: S6-90 In 1888 enthalten / Contained in 1888		(31)
8500							
8500			 3400 700 342 ⊕  3483 034 033  1878 000 634	430 24 MFZ430 430WGTZ	Getr. / GBox: EGS-VR		
			 3482 123 234	430 MFZ430	Getr. / GBox: EGS-VR In 3483/3488 enthalten / Contained in 3483, 3488		(32)
			 3400 700 350 ⊕  3483 034 042  1878 000 634	430 24 MFZ430 430WGTZ	Getr. / GBox: VT-2412B (I-Shift)		
			 3483 034 042 ⊕	430 MFZ430	Getr. / GBox: ZF 6S-1600		
			 1878 634 026	430 10 430WGTZ	Getr. / GBox: ZF 6S-1600		
			 3482 123 234	430 MFZ430	Getr. / GBox: ZF 6S-1600 Getr. / GBox: VT-2412B (I-Shift) In 3483/3488 enthalten / Contained in 3483, 3488		(32)













		CODE				
---	--	------	--	---	---	---

VOLVO

8700 01.99 -

8700				3400 700 342 ⊕ ⊗ 3483 034 033 ⊗ 1878 000 634	430 24 MFZ430 430WGTZ	Getr. / GBox: EGS-VR	
8700				3482 123 234	430 MFZ430	Getr. / GBox: EGS-VR In 3483/3488 enthalten / Contained in 3483, 3488	(32)
8700				3400 700 350 ⊕ ⊗ 3483 034 042 ⊗ 1878 000 634	430 24 MFZ430 430WGTZ	Getr. / GBox: VT-2412B (I-Shift)	
				3483 034 042 ⊕	430 MFZ430	Getr. / GBox: ZF 6S-1600	
				1878 634 026	430 10 430WGTZ	Getr. / GBox: ZF 6S-1600	
				3482 123 234	430 MFZ430	Getr. / GBox: ZF 6S-1600 Getr. / GBox: VT-2412B (I-Shift) In 3483/3488 enthalten / Contained in 3483, 3488	(32)
8700				3400 127 201 ⊕ ⊗ 3483 034 033 ⊗ 1862 530 231	430 10 MFZ430 430WGTZ	-> Chass. 6485 Getr. / GBox: EGS-VR	
				3483 034 033 ⊕	430 MFZ430	Chass. 6486-> Getr. / GBox: EGS-VR	
				1878 001 215	430 24 430WGTZ	Chass. 6486-> Getr. / GBox: EGS-VR	
				3482 123 234	430 MFZ430	Getr. / GBox: EGS-VR In 3483/3488 enthalten / Contained in 3483, 3488	(32)

















9700 04.01 -

9700	04.01 -			3400 700 342 ⊕ ⊗ 3483 034 033 ⊗ 1878 000 634	430 24 MFZ430 430WGTZ	Getr. / GBox: EGS-VR	
9700	10.01 -			3482 123 234	430 MFZ430	Getr. / GBox: EGS-VR In 3483/3488 enthalten / Contained in 3483, 3488	(32)
9700	04.01 -			3400 700 350 ⊕ ⊗ 3483 034 042 ⊗ 1878 000 634	430 24 MFZ430 430WGTZ	Getr. / GBox: VT-2412B (I-Shift)	
9700	10.01 -			3483 034 042 ⊕	430 MFZ430	Getr. / GBox: ZF 6S-1600	
9700	04.01 -			1878 634 026	430 10 430WGTZ	Getr. / GBox: ZF 6S-1600	
9700	10.01 -			3482 123 234	430 MFZ430	Getr. / GBox: ZF 6S-1600 Getr. / GBox: VT-2412B (I-Shift) In 3483/3488 enthalten / Contained in 3483, 3488	(32)
9700	10.07 -			3400 710 060 ⊗ 3482 001 307 ⊗ 1878 003 867 ⚡ 6482 000 155	430 24 MF430 430WGTZ PHIS-6/38	Mot. DH12E460	
9700	10.07 -			1863 869 037	72	Mot. DH12E460	
9700	01.09 -			3400 710 061 # ⊗ 3482 000 553 ⊗ 1878 007 046 ⚡ 6482 000 155	430 24 MF430 430WGTZ PHIS-6/38	Mot. D12C420 Euro 5 / Euro 5	(17)
9700	01.09 -			3400 710 066 ● ⊗ 3482 001 308 ⊗ 1878 007 046 ⚡ 6482 000 155	430 24 MF430 430WGTZ PHIS-6/38	Mot. D12C420 Euro 6 / Euro 6	(18)
9700	01.09 -			3400 710 061 # ⊗ 3482 000 553 ⊗ 1878 007 046 ⚡ 6482 000 155	430 24 MF430 430WGTZ PHIS-6/38	Mot. D12C460 Euro 5 / Euro 5	(17)
9700	01.09 -			3400 710 066 ● ⊗ 3482 001 308 ⊗ 1878 007 046 ⚡ 6482 000 155	430 24 MF430 430WGTZ PHIS-6/38	Mot. D12C460 Euro 6 / Euro 6	(18)

		CODE				
---	--	------	--	---	---	---



VOLVO

9900 10.01 -

9900 9900	10.01- 10.01-			3400 700 342 ⊕ ⊗ 3483 034 033 ⊙ 1878 000 634	430 24 MFZ430 430WGTZ	Mot. DH12D420 Getr. / GBox: EGS-VR	
				3482 123 234	430 MFZ430	Mot. DH12D420 Getr. / GBox: EGS-VR In 3483/3488 enthalten / Contained in 3483, 3488	(32)
				3482 123 234	430 MFZ430	Mot. DH12D420 Getr. / GBox: VT-2412B (I-Shift) In 3483/3488 enthalten / Contained in 3483, 3488	(32)
				3400 700 350 ⊕ ⊗ 3483 034 042 ⊙ 1878 000 634	430 24 MFZ430 430WGTZ	Mot. DH12D420 Getr. / GBox: VT-2412B (I-Shift)	
				3483 034 033 ⊕	430 MFZ430	Mot. DH12D420 Getr. / GBox: EGS-VR	
				3483 034 042 ⊕	430 MFZ430	Mot. DH12D420 Getr. / GBox: VT-2412B (I-Shift)	
				1878 000 634	430 24 430WGTZ	Mot. DH12D420 Getr. / GBox: VT-2412B (I-Shift) Getr. / GBox: EGS-VR	
				3100 026 431 ⊕ 3151 000 154 ⊙ 3180 000 009	KZISZ-5	Mot. DH12D420 Getr. / GBox: VT-2412B (I-Shift) für Membranfederinnendurchmesser 120mm / for diaphragm spring inside diameter 120mm Beinhaltet Ausrücker und Montagesatz / Contains releaser and fitting kit In 3483/3488 enthalten / Contained in 3483, 3488	(79) (9) (32)
				3100 026 432 ⊕ 3151 000 154 ⊙ 3180 001 008	KZISZ-5 KZISZ-5	Mot. DH12D420 Getr. / GBox: VT-2412B (I-Shift) für Membranfederinnendurchmesser 100mm / for diaphragm spring inside diameter 100mm Beinhaltet Ausrücker und Montagesatz / Contains releaser and fitting kit für Membranfederinnendurchmesser 100mm / for diaphragm spring inside diameter 100mm	(78) (9) (78)
	3100 026 434 ⊕ 3151 000 163 ⊙ 3180 000 009	KZISZ-5 KZISZ-5	Mot. DH12D420 Getr. / GBox: EGS-VR Beinhaltet Ausrücker und Montagesatz / Contains releaser and fitting kit In 3483/3488 enthalten / Contained in 3483, 3488	(9) (32)			
9900 9900	01.09- 01.09-			3400 710 061 # ⊗ 3482 000 553 ⊙ 1878 007 046 ⚡ 6482 000 155	430 24 MF430 430WGTZ PHIS-6/38	Mot. D12C420 Euro 5 / Euro 5	(17)
				3400 710 066 ● ⊗ 3482 001 308 ⊙ 1878 007 046 ⚡ 6482 000 155	430 24 MF430 430WGTZ PHIS-6/38	Mot. D12C420 Euro 6 / Euro 6	(18)
9900 9900	10.07- 10.07-			3400 710 060 ⊗ 3482 001 307 ⊙ 1878 003 867 ⚡ 6482 000 155	430 24 MF430 430WGTZ PHIS-6/38	Mot. DH12E460	
				1863 869 037	72	Mot. DH12E460	
9900 9900	01.09- 01.09-			3400 710 061 # ⊗ 3482 000 553 ⊙ 1878 007 046 ⚡ 6482 000 155	430 24 MF430 430WGTZ PHIS-6/38	Mot. D12C460 Euro 5 / Euro 5	(17)
				3400 710 066 ● ⊗ 3482 001 308 ⊙ 1878 007 046 ⚡ 6482 000 155	430 24 MF430 430WGTZ PHIS-6/38	Mot. D12C460 Euro 6 / Euro 6	(18)

YUTONG

ZK

ZK 6100 HB ZK 6118 HGA		C245-20		3482 124 549	430 GMF430	Getr. / GBox: Qijiang QJ805 Getr. / GBox: Qijiang QJ1205	
				1878 026 241	430 10 430WGTZ	Getr. / GBox: Qijiang QJ805 Getr. / GBox: Qijiang QJ1205	

YUTONG

ZK						
ZK 6120 HA		CumminsC3002 0	 3482 124 549	430 GMF430	Getr. / GBox: ZF S6-90	
			 1878 026 241	430 10 430WGTZ	Getr. / GBox: ZF S6-90	
ZK 6831 HE		EQB210-20	 3482 000 464	395 MF395	Getr. / GBox: Qijiang QJ805	
			 1878 000 294	395 10 395WGTZ	Getr. / GBox: Qijiang QJ805	

Arithmetische Liste / Part number list

Artikelnummer Article No.	Seite Page	Hersteller Manufacturer	Artikelnummer Article No.	Seite Page	Hersteller Manufacturer
1800 106 033	752 753 802 803	VOLVO	1859 250 101	96 593 594 595 597 598 599 600 601 605 607 608 610 611 613 623 624 625 627 628 629 630 631 632 633 637 638 639 640 641 644 648 649 650 651 652 656 658 660 661 662 663 665 668 669	IVECO MERCEDES-BENZ
1800 107 133 #	929 930 932 934	VOLVO	1859 250 102	813 820 821 588 589 607 619 620 625 636 638 640 641 646 653 655 659 660 664 666	DRÖGMÖLLER EVOBUS MERCEDES-BENZ
1800 125 001	756 758 805 930 934	VOLVO	1859 600 001	37 515	FAUN MERCEDES-BENZ
1800 125 201	395 396 398 548 549 550 551 872 886	MERCEDES-BENZ	1860 062 037 #	545 546 550 555 872 873 887 890	MERCEDES-BENZ
1800 125 301	812 813 584 585 587 588 605 606 611 612 615 616 618 619 620 622 635 636 638 645 647 649 652 653 654 656 657 659 666 667 894 895 896 898 899 900 901 902 903 904 905 923	DRÖGMÖLLER MERCEDES-BENZ NEOPLAN	1861 034 147 #	830 (32x40-10N) 258 854 546 547 579 582 583 602 873 888 890 745	MAGIRUS-DEUTZ MAN MERCEDES-BENZ TAM
1800 125 501 #	357 360 361 362 363 364 365 366 367 369 371 372 373 374 375	MAN	1861 123 236	393 396 546 (23x29-10N) 547 548 872	MERCEDES-BENZ
1800 125 601 #	757 758 759 801 802 803 805 806 932	VOLVO	1861 206 211 #	824 854 893 895 897 900 901 902 903 904 905 906 679 722	IKARUS MAN NEOPLAN ÖSTERREICHISCHE AUTOMOBILFABRIK (ÖAF) RENAULT TRUCKS
1805 041 200	545	MERCEDES-BENZ	1861 224 005 #	37 (1 1/8"-10N)	FAUN
1805 042 000	37 515	FAUN MERCEDES-BENZ	1861 279 133	396 398 555 (28x35-10N) 556 559 561 562 564 565 570 573 595 865 888	MERCEDES-BENZ
1850 280 790 #	679 706 707	RENAULT TRUCKS	1861 280 136	38 (18,3x20,4-24N)	FAUN
1850 282 652 ▲	60 134 135 153	IVECO MAGIRUS-DEUTZ	1861 291 136	37 (26x32-10N) 395 396 398 548 549 550 551 872 886	FAUN MERCEDES-BENZ
1850 480 049	5 16 17 41 42 45 46	DAF IVECO	1861 303 248	814 (28x35-10N) 824 149 378 399 400	EVOBUS IKARUS KÄSSBOHRER MERCEDES-BENZ
1859 170 204	752 753 756 757 758 759 801 802 803 805 934	VOLVO			
1859 212 000	357 360 363 374 375 752 753 754 756 757 758 759 801 802 803 804	MAN VOLVO			
1859 212 001	149 150 357 360 361 362 363 364 365 366 367 369 371 372 373	LIEBHERR MAN			
1859 250 100	812 589 605 606 608 609 612 620 621 639 643 653 654	DRÖGMÖLLER MERCEDES-BENZ			

Artikelnummer Article No.	Seite Page	Hersteller Manufacturer	Artikelnummer Article No.	Seite Page	Hersteller Manufacturer
1861 351 342 # (32x40-10N)	156 157 831 832 833	MAGIRUS-DEUTZ	1861 742 032 (1 1/2"-10N)	79 92 93 97 135 136	IVECO
1861 384 334 # (26x32-10N)	511 512 513 514 515 516 517 524 525 526 527 528 530 531	MERCEDES-BENZ		155	MAGIRUS-DEUTZ
1861 470 234 (32x40-10N)	152 156 157 258 351 352 354 854 870 871 888	MAGIRUS-DEUTZ MAN	1861 748 132 (63,6x73,5-6N)	357 360 361 362 363 364 365 366 367 369 371 372 373	MAN
1861 518 031 # (26x32-10N)	511 512 513 514 515 516 524 526 528	MERCEDES-BENZ	1861 749 132 (1 3/4"-10N)	357 360 361 362 363 364 365 366 367 369 371 372 373	MAN
1861 571 110 # (1 3/4"-10N)	817	EVOBUS	1861 777 037 (1 1/2"-10N)	6 7 8 17 155	DAF
1861 571 236 (28x35-10N)	560 561 565 566 571 573 580 581 906	MERCEDES-BENZ NEOPLAN		231 353 355 358 834 897 898	MAGIRUS-DEUTZ MAN NEOPLAN
1861 572 431 (2"-10N)	828	IVECO	1861 777 043 (1 3/4"-10N)	7 8 9 20	DAF
1861 574 132 ▲# (18,3x20,4-24N)	545	MERCEDES-BENZ	1861 840 133 # (26x32-10N)	510 511 516 520 521 522 523 527	MERCEDES-BENZ
1861 577 037 # (1 1/2"-10N)	79 135 154 353 355 689 707 710 724	IVECO MAGIRUS-DEUTZ MAN RENAULT TRUCKS	1861 841 132 (27x29,4-28N)	230 231 834	MAN
1861 577 136 # (1 1/2"-10N)	93 135 155	IVECO MAGIRUS-DEUTZ	1861 874 032 (1 1/2"-10N)	817 828 831	EVOBUS IVECO MAGIRUS-DEUTZ
1861 594 034 # (36x40-20N)	531 532 533 534 540	MERCEDES-BENZ	1861 876 134 # (1 3/4"-10N)	357 360 366 369 371 373	MAN
1861 600 033 # (32x40-10N)	153 154 258 259 745	MAGIRUS-DEUTZ MAN TAM	1861 897 034 (21,9x24,2-23N)	747 748 751 926 927	VOLKSWAGEN
1861 603 034 # (36x40-20N)	529	MERCEDES-BENZ	1861 902 032 # (1 3/4"-10N)	37 813 731 732	ENASA SISU
1861 611 131 # (26x32-10N)	511 512 513 514 515 516 524 526 528	MERCEDES-BENZ	1861 911 232 (1 3/4"-10N)	818 819 820 357 360 361 362 363 364 365 366 367 369 371 372 373 374 375 842 849	EVOBUS MAN
1861 632 032 (28x35-10N)	395 398 872 888	MERCEDES-BENZ	1861 919 134 (28x35-10N)	378 395 396 398 399 400 401 546 549 550 551 552 553 554 555 556 557 558 559 561 562 564 573 860 864 872 873 890	MERCEDES-BENZ
1861 643 134 # (1 3/4"-10N)	94 95 567 568 575 584 586 603 604 605 615 616 617 634 635	IVECO MERCEDES-BENZ	1861 923 032 # (1 3/4"-10N)	889	MERCEDES-BENZ
1861 653 132 (1 1/2"-10N)	828 829 831	IVECO MAGIRUS-DEUTZ	1861 936 142 (23x29-10N)	398 399 400 548	MERCEDES-BENZ
1861 667 034 (36x40-20N)	530 531 532 533 534 538 539 540	MERCEDES-BENZ	1861 956 133 (36x40-20N)	531 534 535 536 537 538 539 540 541	MERCEDES-BENZ
1861 713 133 # (36x40-20N)	531 534 535 536 537 538 539 540 541	MERCEDES-BENZ	1861 963 033 (28x35-10N)	554 555 558 562 563 566 571 572 578 864 875 887	MERCEDES-BENZ
1861 741 042 # (36x40-20N)	514 515 516 517 525 529 530 531 532 533 534 537 538 539 540	MERCEDES-BENZ			

Arithmetische Liste / Part number list

Artikelnummer Article No.	Seite Page	Hersteller Manufacturer	Artikelnummer Article No.	Seite Page	Hersteller Manufacturer						
1861 964 034 (28x35-10N)	554 558 562	MERCEDES-BENZ	1862 304 033 (2"-10N)	96	IVECO MERCEDES-BENZ						
	565 571 573			593 594 595							
	578 580 596			597 598 599							
	864 875 887			600 601 605							
	891			606 607 608							
NEOPLAN		610 611 613									
1861 966 141 # (26x32-10N)	512 514 515	MERCEDES-BENZ		620 623 624							
	516 517 523			625 627 628							
	525 526 527			629 630 631							
	528 530 531			632 633 637							
1861 988 034 (36x44,5-10N)	761 778	VOLVO		638 639 640							
			641 643 644								
1861 992 432 (2"-10N)	131 132 141	IVECO	645 647 648								
	142 145		649 650 651								
	164		652 654 656								
1861 996 137 # (2"-10N)	754 805	VOLVO	658 660 661								
			662 663 665								
1862 088 131 # (26x32-10N)	515 520	MERCEDES-BENZ	668 669								
1862 122 132 (2"-10N)	589 605 608	MERCEDES-BENZ	1862 305 033 (2"-10N)	96	IVECO MERCEDES-BENZ						
	609 621 643			593 594 595							
	655 661 665			597 598 599							
	668			600 601 605							
	890 897			607 608 610							
NEOPLAN		611 613 623									
1862 123 131 (2"-10N)	589 605 608	MERCEDES-BENZ		624 625 627							
	609 621 643			628 629 630							
	655 661 665			631 632 633							
	668			637 638 639							
1862 125 202 # (1 3/4"-10N)	733 734 735	STEYR		640 641 644							
			648 649 650								
			651 652 656								
1862 138 032 # (2"-10N)	812	DRÖGMÖLLER MERCEDES-BENZ	658 660 661								
	589 606 612		662 663 665								
	620 639 653		668 669								
	654 656 657										
	659										
1862 211 031 # (1 3/4"-10N)	878 879 881	MERCEDES-BENZ	1862 310 132 (1 1/2"-10N)	66 69 71	IVECO						
				73 74 76							
1862 219 031 (27x29,4-28N)	231 834 835	MAN		78 79 80							
1862 225 132 # (1 3/4"-10N)	567 568 569	MERCEDES-BENZ		1862 315 101 # (2"-10N)		737 738 739	STEYR				
	574 575 576										
	592 603 621										
	622										
1862 248 033 Δ (88,5x102-8N)	755 765 766	VOLVO				1862 317 031 (1 3/4"-10N)		83 86 87	IVECO		
	767 768 780							88 100 105			
	784 786 788							108 109 116			
	790 791 793		119								
	794 795 796										
	805 807		80 84 86								
			87								
1862 286 031 # (36x40-20N)	535 536 537	MERCEDES-BENZ	1862 317 032 (2"-10N)	204	IVECO						
	540 541 542										
	543										
1862 299 032 (28x35-10N)	399 401 550	MERCEDES-BENZ		1862 349 031 (2"-10N)			778 779 780	MAN VOLVO			
	551 555 886					800 801					
1862 302 031 (88x102,4-8N)	926	VAN HOOL				1862 353 041 ▲ (29x35-10N)	689 709 721		RENAULT TRUCKS		
1862 303 031 (2"-10N)	195 197 198	MAN					1862 364 031 (2"-10N)			722 723 724	MAN
	199 200 201									193 195 196	
	202 203 204									197 198 199	
	205 206 207									200 201 202	
	208 209 210		203 204 205								
	211 212 213		206 207 208								
	214 215 216		209 210 211								
	222 225 226		212 213 214								
			215 216 217								
			218 219 220								
			221 222 223								
			224 225 226								
	227 228 229										
	230 258 374										

Artikelnummer Article No.	Seite Page	Hersteller Manufacturer	Artikelnummer Article No.	Seite Page	Hersteller Manufacturer
1862 364 133 (1 3/4"-10N)	192 195 196 198 199 204 206 207 208 210 216 217 218 219 223 227 374 375 834 848 850	MAN	1862 811 001 (26x32-10N)	60 134 135 828	IVECO
1862 375 031 (23,3x26,3-23N)	377 855	MERCEDES-BENZ	1862 962 002 # (36x40-20N)	533 534 535 536 537 538 539 540 541 542 543	MERCEDES-BENZ
1862 379 031 (50x55-20N)	683 691 692 693 694 696 697 698 701 702 706 713 714 715 716 731	RENAULT TRUCKS	1862 967 001 (23x29-10N)	41 43 44 45 46 47	IVECO
1862 379 032 (2"-10N)	690 691 692 693 694 695 696 697 698 699 700 714 715 716 717 718 719	RENAULT TRUCKS	1862 973 002 (30,9x38,1-10N)	92 776	IVECO VOLVO
1862 380 031 ▽ (88x102-8N)	693 695 717 731	RENAULT TRUCKS SISU	1862 974 002 (1 3/4"-10N)	761 776 777	VOLVO
1862 415 031 ▽ (2"-10N)	755 765 766 767 768 780 793 794 795 796 805 807	VOLVO	1862 977 001 (23x29-10N)	41 42 45 46	IVECO
1862 438 032 (1 1/2"-10N)	232 233 234 235 236 237 240 241 242 245 246 251 252 253 254 835 732 733 734 735 736	MAN STEYR	1863 009 100	37 38 39 824 843 854 912	FAUN IKARUS MAN ÖSTERREICHISCHE AUTOMOBILFABRIK (ÖAF)
1862 450 031 (41x45-22N)	728 918	SCANIA	1863 010 100	152 156 157 547 583 602	MAGIRUS-DEUTZ MERCEDES-BENZ
1862 506 131 (1 3/4" -10N)	164 168 232 236 240 242 243 244 245 246 247 248 249 250 251 257 259 281 294 295 296 297 298 299 376 898 734 735 736 738 923 923	MAN MAZ NEOPLAN STEYR TAM TEMSA	1863 101 100 ▲	831 832 833	MAGIRUS-DEUTZ
1862 530 231 (2"-10N)	753 779 780 792 804 806 930 933 935	VOLVO	1863 600 116	670	NISSAN
1862 538 031 (23x29-10N)	516	MERCEDES-BENZ	1863 600 123	679	ÖSTERREICHISCHE AUTOMOBILFABRIK (ÖAF)
1862 543 031 (2"-10N)	40	HINO	1863 600 125	36 37 99 150 151 152 153 154 155 156 161 830 831 832 258 259 350 853 913	DEMAG FAUN IVECO LIEBHERR MAGIRUS-DEUTZ MAN ORION WERKE
1862 642 001 (24,5x29-10N)	17	DAF	1863 600 128	5 16 17	DAF
1862 718 002 # (26x32-10N)	510 511 520 521 522 523 524 525 529	MERCEDES-BENZ	1863 837 002	514 515 516 517 518 519 521 522 523 524 525 526 528 529 530 531 532 534 535 536 537 538 539 540 541 542 543	MERCEDES-BENZ
			1863 837 003	511 512 514 520 521 522 523 524 525 526 529 531 532	MERCEDES-BENZ
			1863 840 001	510 511 512 513 514 515 516 517 520 521 522 523 524 525 526 527 528 530 531	MERCEDES-BENZ
			1863 855 000	514 515 516 517 518 519 521 523 525 529 530 531 532 534 535	MERCEDES-BENZ

Artikelnummer Article No.	Seite Page	Hersteller Manufacturer	Artikelnummer Article No.	Seite Page	Hersteller Manufacturer
1866 030 102 (64x70-32N)	704	RENAULT TRUCKS	1878 000 206 (1 3/4"-10N)	146 147 148 149 830	KAMAZ
1866 032 231 (31,8x34,3-26N)	807 808 809 810	VOLVO PENTA	1878 000 294 (1 3/4"-10N)	18 19 146 830 937	DAF KAMAZ KING LONG YUTONG
1866 065 001 (41x45-22N)	150 151	LIEBHERR	1878 000 296 (1 3/4"-10N)	21 23 24	DAF
1866 090 001 (54x60-18N)	151	LIEBHERR	1878 000 298 (2"-10N)	825 826	IRISBUS
1866 118 001 (31,8x34,3-26N)	809 810	VOLVO PENTA	1878 000 300 (46x50-24N)	767 768 769 772 793 794 795 796 806	VOLVO
1866 136 001 (31x35-16N)	150 151	LIEBHERR	1878 000 515 (1 1/2"-10N)	5	AVIA
1866 138 101 (31x35-16N)	150 151	LIEBHERR	1878 000 611 (1 1/2"-10N)	62 65 66 67 69 70 72 73 74 75 76 77 79 135 136 709 710 711	IVECO
1866 148 001 (64x70-22N)	151	LIEBHERR	1878 000 615 ▲ (26,48x28,7-26N)	545	RENAULT TRUCKS MERCEDES-BENZ
1866 156 001 (36x40-18N)	150 151	LIEBHERR	1878 000 634 (46x50-24N)	697 699 767 768 783 785 792 793 794 795 796 806 931 934 935 936	RENAULT TRUCKS VOLVO
1866 157 101 (46x50-24N)	151	LIEBHERR	1878 000 635 (85x98-8N)	767 768 769 793 794 795 796	VOLVO
1866 157 103 ▲ (46x50-24N)	150	LIEBHERR	1878 000 650 (1 3/4"-10N)	839 840 843	MAN
1874 000 068	717	RENAULT TRUCKS	1878 000 841 # (1 1/2"-10N)	834 839 842 847 848	MAN
1874 000 098	752 753 754 756 758 802 803 805 930 934	VOLVO	1878 000 957 (1 3/4"-10N)	80 92 93 94 95 97 98 136 137 138 143 829 830 156 157 158 159 160 833 252 253 254 255 256 257 671	IVECO
1874 015 200	95 96 97 99 137 138 139 140 141 142 143 145 828 829 163	IVECO	1878 000 960 (40x45-16N)	680	RENAULT TRUCKS
1878 000 036 (1 1/2"-10N)	18 19 21 827	DAF IVECO	1878 000 961 (1 3/4"-10N)	752 761 774 775 776 777 802 931 932 934	VOLVO
1878 000 104 (36x45-10N)	38 39 143 144 152 157 158 160 161 162 576 582 583 584 585 586 602 603 604 609 610 616 617 619 634 872 720 919	FAUN IVECO MAGIRUS-DEUTZ MERCEDES-BENZ RENAULT TRUCKS SETRA	1878 000 964 (1 3/4"-10N)	149 150 246 247 248 249 255 256 257 354 355 356 357 360 363 372 375 566 582 585 590 591 602 614 635 652 654 657 666	LIEBHERR MAN MERCEDES-BENZ
1878 000 105 (1 3/4"-10N)	811 8 9 10 11 22 812 149 561 563 564 566 567 568 569 572 575 576 577 579 582 583 584 585 586 587 590 591 592 602 603 604 610 615 616 617 618 619 622 634 635 871 887 893	BOVA DAF LIEBHERR MERCEDES-BENZ NEOPLAN			

Arithmetische Liste / Part number list

Artikelnummer Article No.	Seite Page	Hersteller Manufacturer	Artikelnummer Article No.	Seite Page	Hersteller Manufacturer
1878 000 965 (2"-10N)	752 753 754 803 804	VOLVO	1878 001 080 (2"-10N)	752 753 755 778 779 780 802 803 804 805 806 930	VOLVO
1878 000 967 (1 3/4"-10N)	147 149 150 357 360 363 372 374 375 756 757 758 759 801 802 803 804	KAMAZ LIEBHERR MAN VOLVO	1878 001 082 (2"-10N)	752 753 755 778 779 780 802 803 804 805 806 930	VOLVO
1878 000 968 (2"-10N)	813 820 821 588 589 607 612 619 620 625 636 638 640 641 646 653 655 659 660 664 666 752 753 754 803 804	DRÖGMÖLLER EVOBUS MERCEDES-BENZ VOLVO	1878 001 083 (1 3/4"-10N)	752 756 757 758 759 801 802 803 805 930 934	VOLVO
1878 001 070 (1 3/4"-10N)	7 8 9 10 17 79 97 136 149 153 154 155 156 158 160 561 563 564 566 568 571 572 573 574 579 581 582 583 590 591 596 609 614 621 887 889 898 899 902 907	DAF IVECO LIEBHERR MAGIRUS-DEUTZ MERCEDES-BENZ NEOPLAN	1878 001 136 (1 3/4"-10N)	1 603 616 634 635 870 871 878 879 880 893 722 924	ASTRA MERCEDES-BENZ NEOPLAN RENAULT TRUCKS VAN HOOL
1878 001 071 (1 1/2"-10N)	6 7 8 9 17 812	DAF	1878 001 138 (1 3/4"-10N)	17 25 812 824 94 95 97 98 137 138 139 140 141 142 143 144 145 828 829 159 162 163 164 890 892 895 901 907 725 726 916 924	DAF IKARUS IVECO MAGIRUS-DEUTZ NEOPLAN SCANIA VAN HOOL
1878 001 074 (32x40-10N)	37 152 153 154 155 156 830 831 258 853 547 565 571 572 574 576 579 582 583 596 614 618 865 866 888 899 900 902 903 906 678 740 745 923	FAUN MAGIRUS-DEUTZ MAN MERCEDES-BENZ NEOPLAN ÖSTERREICHISCHE AUTOMOBILFABRIK (ÖAF) STEYR TAM	1878 001 144 (1 3/4"-10N)	351 352 353 354 355 356 358 359 361 362 853 555 563 571 573 574 578 581 582 583 590 596 614 867 887 889 720 733 734 735 736 740 742	MAN MERCEDES-BENZ RENAULT TRUCKS STEYR
1878 001 077 (1 1/2"-10N)	155 239 241 252 253 254 255 256 257 351 847 898 733 734	MAGIRUS-DEUTZ MAN NEOPLAN STEYR	1878 001 145 (1 1/2"-10N)	239 241 351 835 839 847 848 707 708 710 711 713 733 734	MAN RENAULT TRUCKS STEYR
1878 001 079 (1 3/4"-10N)	354 355 358 708 756 757 758	MAN RENAULT TRUCKS VOLVO	1878 001 147 # (1 3/4"-10N)	351 352 353 354 355 356 358 359 361 362 853 867 720	MAN MERCEDES-BENZ RENAULT TRUCKS
			1878 001 152 (1 3/4"-10N)	815 816 817 818 823 832 833 834 252 253 254 255 256 257 352 353 354 355 356 358	EVOBUS MAGIRUS-DEUTZ MAN

Artikelnummer Article No.	Seite Page	Hersteller Manufacturer	Artikelnummer Article No.	Seite Page	Hersteller Manufacturer
1878 001 154 # (1 3/4"-10N)	832 833 834 841 842 844 845 846	MAGIRUS-DEUTZ MAN	1878 002 075 # (40x45-16N)	685 708 711 915	RENAULT TRUCKS
1878 001 215 (46x50-24N)	782 783 792 933 935	VOLVO	1878 002 139 (2" -10N)	273 274 275 276 277 278 279 280 285 286 287 288 292 306 307 309 311 317 322 323 324 327 332 333 339 341 344 348 350 836 838 909 744	MAN NEOPLAN STEYR
1878 001 216 (46x50-24N)	761 762 763 767 768 783 784 785 786 787 788 789 790 791 793 794 795 796 797 798 799	VOLVO	1878 002 218 (1 3/4"-10N)	928 807	VOLKSWAGEN VOLVO
1878 001 501 (1 1/2"-10N)	913	PAZ	1878 002 437 (2"-10N)	769 770 771 773 793 794 795 796	VOLVO
1878 001 709 (1 3/4" -10N)	923	TEMSA	1878 002 442 (85x98-8N)	770 771 773	VOLVO
1878 001 713 ▲ (1"-10N)	679 706 707	RENAULT TRUCKS	1878 002 455 (50x55-20N)	698	RENAULT TRUCKS
1878 001 727 (1 1/2" -10N)	709 710	RENAULT TRUCKS	1878 002 458 ▽ (2"-10N)	756 770 771	VOLVO
1878 001 729 (1 1/2"-10N)	685 686 687 688 689 702 707 708 709 710 711 724 913	RENAULT TRUCKS	1878 002 460 △ (2"-10N)	756 770 771	VOLVO
1878 001 939 (36x40-18N)	518 519 543 544 551 555 558 578 887	MERCEDES-BENZ	1878 002 599 (1 1/2"-10N)	146 830	KAMAZ KAVZ
1878 002 019 (45x50-18N)	409 410 412 413 414 415 417 418 420 421 422 423 426 427 428 429 432 433 434 435 436 437 438 439 441 442 443 444 445 446 447 506 508 641	MERCEDES-BENZ	1878 002 642 (1 3/4"-10N)	146	KAMAZ
1878 002 023 (85x96-8N)	170 175 177 181 184 186 191 737 739	MAN STEYR	1878 002 643 (2"-10N)	165 166 167 169 170 171 172 173 174 175 176 177 178 179 180 181 183 184 186 187 188 189 190 191 192 259 261 263 279 282 283 284 285 286 287 288 289 290 291 292 300 301 302 303 304 305 306 307 308 309 310 311 312 313 314 315 316 317 318 319 320 321 322 323 324 325 326 327 328 329 330 331 332 333 334 335 336 337 338 339 340 341 342 343 344 345 346 347 348 349 350	MAN KAMAZ KAVZ MAN
1878 002 024 (45x50-18N)	409 410 412 413 414 415 417 418 420 421 422 423 426 427 428 429 432 433 434 435 436 437 438 439 441 442 443 444 445 446 447 503 506 507	MERCEDES-BENZ			
1878 002 071 (1 3/4"-10N)	20 146 810	DAF KAMAZ YaMZ			
1878 002 072 (23x29-10N)	41 42 43 44 45 46 47 48 49 50	IVECO			

Arithmetische Liste / Part number list

Artikelnummer Article No.	Seite Page	Hersteller Manufacturer	Artikelnummer Article No.	Seite Page	Hersteller Manufacturer	
1878 002 706 (1 3/4" -10N)	811	BOVA	1878 002 955 (1 3/4" -10N)	80 94 95	IVECO	
	14 15 16	DAF		96 97 98		
	25			99 134 137		
	812 813	DRÖGMÖLLER		138 139 140		
	817	EVOBUS		141 142 143		
	38	FAUN		144 145 146		
	160	MAGIRUS-DEUTZ		829		
	360 842 843	MAN		159 160 161	MAGIRUS-DEUTZ	
	845			162 163 164	MAN	
	567 568 569	MERCEDES-BENZ		356 359 365		
	575 576 577			368 370 372	VAN HOOL	
	584 585 587			925	SCANIA	
	588 603 605			1878 003 065 (46x50-24N)	729 730	SCANIA
	606 607 611			1878 003 066 (46x50-24N)	728 729 917	SCANIA
	612 615 616			1878 003 238 (41x45-22N)	725 726 727	SCANIA
	617 618 619				728 916 917	
	620 622 630			1878 003 242 (2" -10N)	753 803	VOLVO
	635 636 638			1878 003 269 (1 3/4" -10N)	811	BOVA
	640 645 646				11 12 14	DAF
	647 649 652				15 16 31	
	653 654 655				32	
	656 657 659			NEOPLAN	592 593 604	MERCEDES-BENZ
	660 664 665				605 618 620	
	666 667 880				622 623 624	
	881				625 627 628	
	893 894 895				629 635 636	
	896 897 898			STEYR	638 639 645	
899 900 901			647 649 652			
902 903 904			653 654 656			
905 907		TAM	657 659			
739 741 742		VAN HOOL	917	SCANIA		
743		MERCEDES-BENZ	1878 003 274 (42x52-10N)	143 145	IVECO	
924 925 926			161 163	MAGIRUS-DEUTZ		
1878 002 731 (45x50-18N)	493 494 496		1878 003 276 (1 3/4" -10N)	37 813	ENASA	
	499 500 503			686 687 703	RENAULT TRUCKS	
	504 508			704		
1878 002 732 (45x50-18N)	412 417 420	MERCEDES-BENZ	1878 003 277 (2" -10N)	37	ENASA	
	426 432 436		1878 003 320 (36x45-10N)	816	EVOBUS	
	441 445 493			588 606 612	MERCEDES-BENZ	
	494 496 499			617 619		
	500 503 504			901	NEOPLAN	
1878 002 734 (2" -10N)	821 822 823	EVOBUS	1878 003 339 (1 3/4" -10N)	725 726 916	SCANIA	
	918	SETRA		917		
1878 002 735 (2" -10N)	595 598 599	MERCEDES-BENZ	1878 003 365 (41x45-22N)	726 727 728	SCANIA	
	600 601 609		1878 003 647 (2" -10N)	23 24 28	DAF	
	613 614 626			29 35		
	630 631 632		1878 003 657 (1 3/4" -10N)	812	DAF	
	633 634 639			812 813	DRÖGMÖLLER	
	640 641 642			815 816 817	EVOBUS	
	643 644 650			818 819 820		
	651 652 660			821 823		
	661 662 663			162 832 833	MAGIRUS-DEUTZ	
	664 668 669			834		
	670 875 876			354 355 356	MAN	
1878 002 825 (2"-10N)	827	IVECO		357 359 360		
1878 002 878 (2" -10N)	1	ASTRA		361 362 363		
	811	BOVA		364 365 366		
	17 25 31	DAF				
	32					
	587 588 589	MERCEDES-BENZ				
	606 607 612					

Artikelnummer Article No.	Seite Page	Hersteller Manufacturer	Artikelnummer Article No.	Seite Page	Hersteller Manufacturer
1878 003 658 (46x50-24N)	728 918	SCANIA	1878 004 132 (2" -10N)	4 99 103 104 105 108 110 111 112 113 115 116 118 119 120 121 122 123 124 126 127 128 129 130	ASTRA IVECO
1878 003 661 (1 3/4" -10N)	96 134 139 142 143 736 737 738 739 742 743	IVECO STEYR	1878 004 133 (2" -10N)	2 40 99 100 101 102 103 104 105 106 108 109 116 117 119 120 122 125 127	ASTRA HINO IVECO
1878 003 662 (2" -10N)	878 879 880 738	MERCEDES-BENZ STEYR	1878 004 232 (36x40-18N)	473 474 476 478 480 482 483 485 486 488 490 491 495 497 498 500 501 505 509	MERCEDES-BENZ
1878 003 767 (2" -10N)	24 28 29 30 35 36 926	DAF VDL	1878 004 456 (2"-10N)	753 761 778 779 780 804 930	VOLVO
1878 003 768 (46x50-24N)	761 762 763 767 768 769 772 783 784 785 786 787 788 789 790 791 793 794 795 796 797 798 799	VOLVO	1878 004 540 (1 3/4"-10N)	292 293 294 295	MAN
1878 003 779 (1 3/4"- 10N)	929 930 931 933	VOLVO	1878 004 573 (2" -10N)	29	DAF
1878 003 780 (46x50-24N)	599 600 601 613 631 641 642 643 644 646 661 662 663 664 669 670	MERCEDES-BENZ	1878 004 581 (1 3/4" -10N)	99 100 103 104 106 107 109 110 112 113 114 117	IVECO
1878 003 784 (36x40-18N)	881	MERCEDES-BENZ	1878 004 582 (2" -10N)	108	IVECO
1878 003 867 (46x50-24N)	692 693 694 716 718 719 759 760 781 782 783 784 785 786 797 931 934 935 936	RENAULT TRUCKS VOLVO	1878 004 584 (1 3/4" -10N)	70 71 74 75 77	IVECO
1878 003 895 (46x50-24N)	730	SCANIA	1878 004 776 (21,8x24,2-23N)	824 747 748 751 927	IKARUS VOLKSWAGEN
1878 003 899 (1 1/2"-10N)	5	BMC	1878 004 832 (2" -10N)	825 826 148 169 170 175 176 177 178 179 180 183 184 185 186 187 188 189 190 191 192 193 194 195 196 197 198 199 201 202 203 205 209 210 212 213 214 215 216 217 218 219 220 221 222 223 224 225 226 227 228 229 230 257 260 261 262 263 264 265	IRISBUS KAMAZ MAN
1878 003 968 (2" -10N)	695 699 700 718 719	RENAULT TRUCKS			
1878 004 094 (1 3/4"-10N)	146	KAMAZ			
1878 004 100 (1 3/4"-10N)	18 60 62 68	DAF IVECO			
1878 004 104 (2" -10N)	273 274 275 276 277 278 279 280 285 286 287 288 291 292 304 305 306 307 308 309 310 311 314 317 322 323 324 327 328 330 332 333 334 335 337 339 340 341 342 344 345 346 348 349 350 836 838 891 907 908	MAN NEOPLAN			

Arithmetische Liste / Part number list

Artikelnummer Article No.	Seite Page	Hersteller Manufacturer	Artikelnummer Article No.	Seite Page	Hersteller Manufacturer
1878 005 187 (26,5x29-26N)	406	MERCEDES-BENZ	1878 006 173 (36x40-18N)	884	MERCEDES-BENZ
1878 005 284 (46x50-24N)	782 783	VOLVO	1878 006 370 (46x50-24N)	730	SCANIA
1878 005 367 (32x40-10N)	38 824 153 156 161 831 832 258 350 351 352 354 355 358 362 853 671 672	FAUN IKARUS MAGIRUS-DEUTZ MAN ÖSTERREICHISCHE AUTOMOBILFABRIK (ÖAF) RENAULT TRUCKS STEYR	1878 006 584 (46x50-24N)	716 717 718 759 760	RENAULT TRUCKS VOLVO
1878 005 411 (2"-10N)	342	MAN	1878 006 637 (36x40-18N)	544	MERCEDES-BENZ
1878 005 486 (2"-10N)	816 819 820	EVOBUS	1878 006 713 (1 3/4"-10N)	294 295	MAN
1878 005 487 (41x45-22N)	728 918	SCANIA	1878 006 757 (36x40-18N)	401 402 403 404 472 473 474 476 477 478 480 482 483 485 486 488 490 491 495 497 498 501 505 509 519 550 554 563 571 861 886	MERCEDES-BENZ
1878 005 540 (2"-10N)	919 920	SETRA	1878 006 847 (1 1/2"-10N)	711 712 713	RENAULT TRUCKS
1878 005 541 (2"-10N)	874 884 919 920 921	MERCEDES-BENZ SETRA	1878 006 848 (1 3/4"-10N)	711	RENAULT TRUCKS
1878 005 599 (1 3/4"-10N)	18 19 20 21 22 29	DAF	1878 006 951 (36x44,5-10N)	757 758 759 801 802 803 805 806 929 930 932 934	VOLVO
1878 005 600 (1 3/4"-10N)	19 20	DAF	1878 007 046 (46x50-24N)	681 682 685 689 695 700 717 718 723 761 762 763 764 765 782 784 785 786 787 788 789 790 791 797 798 799 800 935 936	RENAULT TRUCKS
1878 005 601 (1 1/2"-10N)	18 19 20	DAF	1878 007 072 (45x50-18N)	409 410 414 415 418 422 423 428 429 434 435 436 438 439 444 445 499 500 502 503 504 506 507	RENAULT TRUCKS
1878 005 668 (1 3/4"-10N)	568 569 577 586 592 593 594 604 605 606 608 622 623 624 625 627 628 629 631 637 642 643 647 656 657 659 660 662 663 666 667 668 669 870 873 876 889	MERCEDES-BENZ	1878 007 103 (2"-10N)	922	SINOTRUK (CNHTC)
1878 005 805 (2"-10N)	821 823 599 609 893 894 895 896 905 906	EVOBUS MERCEDES-BENZ NEOPLAN	1878 007 120 (46x50-24N)	730	SCANIA
1878 006 035 (2"-10N)	754 755 805 807	VOLVO	1878 007 123 (46x50-24N)	730	SCANIA
1878 006 055 (2"-10N)	812 589 606 612 620 639 653 654 656 657 659	DRÖGMÖLLER MERCEDES-BENZ	1878 007 124 (46x50-24N)	731	SCANIA
1878 006 101 (45x50-18N)	413 421 427 437 442 446	MERCEDES-BENZ	1878 007 126 (2"-10N)	299 342	MAN
1878 006 117 (2"-10N)	754 755 805 807	VOLVO	1878 007 169 (46x50-24N)	772 773	VOLVO
1878 006 118 (41x45-22N)	727	SCANIA	1878 007 170 (46x50-24N)	681 682 685 689 723 761 762 763 764 765 782 787 789 791	RENAULT TRUCKS
1878 006 129 (46x50-24N)	698 699 761 762 763 769 783 784	RENAULT TRUCKS VOLVO			VOLVO

Artikelnummer Article No.	Seite Page	Hersteller Manufacturer	Artikelnummer Article No.	Seite Page	Hersteller Manufacturer
1878 007 172 (1 3/4")	19 20	DAF	1878 007 934 (1 3/4" -10N)	684 781	RENAULT TRUCKS VOLVO
1878 007 185 (45x50-18N)	413 471	MERCEDES-BENZ	1878 007 939 (1 3/4" -10N)	681 685 760 781	RENAULT TRUCKS VOLVO
1878 007 204 (20x21,9-26N)	377 378	MERCEDES-BENZ	1878 008 030 (2" -10N)	146 147 148	KAMAZ
1878 007 250 (1 3/4"-10N)	60	IVECO	1878 019 001 (1 1/2"-10N)	5	AVIA
1878 007 253 (46x50-24N)	730 731	SCANIA	1878 020 241 (50x55-20N)	824 825 826 827	IRISBUS
1878 007 254 (46x50-24N)	730	SCANIA		680 681 682 683 687 691 692 693 694 695 696 697 698 700 701 702 703 704 705 706 713 714 715 716 719 720 913 914 915	RENAULT TRUCKS
1878 007 278 (1 3/4" -10N)	731	SCANIA	1878 021 731 (1 1/2"-10N)	782	VOLVO
1878 007 279 (1 3/4" -10N)	18 19 21 22	DAF	1878 022 841 (2"-10N)	37 827 139 145 164	ENASA IRISBUS IVECO MAGIRUS-DEUTZ RENAULT TRUCKS
1878 007 339 (1 3/4"-10N)	71 73 74 76 77 78 79 80 83 86	IVECO	1878 023 831 (36x40-18N)	473 474 476 478 480 482 483 484 485 486 488 489 490 491 492 493 494 495 496 497 498 499 500 501 503 504 505 506 509	MERCEDES-BENZ
1878 007 366 (46x50-24N)	761 762 763 764 765 785 787 789 790 791 798	VOLVO	1878 023 931 (36x40-18N)	472 473 474 476 477 478 480 482 483 485 486 488 490 491 493 495 497 498 499 500 501 503 504 505 506 509	MERCEDES-BENZ
1878 007 729 (2" -10N)	176 178 179 180 183 184 185 186 188 189 190 191 192 202 203 214 226 261 262 263 264 265 266 267 268 269 270 271 272 273 274 275 276 277 278 279 282 283 284 285 286 287 288 289 290 291 300 301 302 303 304 305 306 307 308 309 310 311 312 313 314 315 316 317 318 319 320 321 322 323 324 325 326 327 328 329 330 331 332 333 334 335 336 337 338 339 340 341 342 343 344 345 346 347 348 349 350 359 672 673 676 677 678 737 739 740 744 745	MAN	1878 026 241 (1 3/4"-10N)	825 826 827 681 690 691 692 693 694 703 704 713 714 717 913 914 915 922 936 937	IRISBUS RENAULT TRUCKS SINOTRUK (CNHTC) YUTONG
1878 007 732 (36x40-18N)	518 519 520	MERCEDES-BENZ	1878 026 431 (28x35-10N)	378	MERCEDES-BENZ
		ÖSTERREICHISCHE AUTOMOBILFABRIK (ÖAF) STEYR			

Arithmetische Liste / Part number list

Artikelnummer Article No.	Seite Page	Hersteller Manufacturer	Artikelnummer Article No.	Seite Page	Hersteller Manufacturer
1878 027 231 (1 3/4"-10N)	811 21 22 23	BOVA DAF	1878 054 933 (2"-10N)	21 22 23 24 25 26 27 31 32 33 34 826 828 732	DAF IRISBUS IVECO SISU
1878 027 442 (50x55-20N)	680 681 686 687 688 689 703 704 724	RENAULT TRUCKS	1878 054 951 (2"-10N)	87 90 91 92	IVECO
1878 030 841 (21,9x24,3-23N)	670	MULTICAR	1878 061 841 (1 3/4"-10N)	257 837 838 925	MAN VAN HOOL
1878 032 032 (2"-10N)	825 827 80 83 84 87 88 89 99 100 101 102 105 109 113 116 117 119 120 122 125 913 916	IRISBUS IVECO RENAULT TRUCKS	1878 062 944 (41x45-22N)	727 728	SCANIA
1878 032 331 (2"-10N)	715 769	RENAULT TRUCKS VOLVO	1878 063 231 # (46x50-24N)	728 729 917 918	SCANIA
1878 039 631 (1 3/4"-10N)	147 148 709 713	KAMAZ RENAULT TRUCKS	1878 065 131 # (1 3/4"-10N)	819 845	EVOBUS MAN
1878 040 334 (1 3/4"-10N)	929 930 933	VOLVO	1878 074 641 (28x35-10N)	399 400 401	MERCEDES-BENZ
1878 043 231 (46x50-24N)	728 729 917 918	SCANIA	1878 074 841 (1 1/2"-10N)	60 61 62 79	IVECO
1878 044 631 (1 1/2"-10N)	20 168 232 233 234 235 236 237 240 241 242 245 246 251 253 299 835 732 733 734 735 736	DAF MAN STEYR	1878 076 031 (1 1/2"-10N)	761 776 932	VOLVO
1878 049 041 # (40x45-16N)	827 702 916	IRISBUS RENAULT TRUCKS	1878 079 306 (1 3/4"-10N)	60 376	IVECO MAZ
1878 051 801 (46x50-24N)	91 183 184 185 188 190 192 206 207 208 209 210 211 212 213 214 215 216 218 219 220 221 222 224 225 226 649 673 674 675 676 677 682 683 719	IVECO MAN MERCEDES-BENZ ÖSTERREICHISCHE AUTOMOBILFABRIK (ÖAF) RENAULT TRUCKS	1878 079 331 (1 1/2" 10N)	17 18 62 68 75 232 233 238 239 240 242 245 246 248 292 293 294 295 375	DAF IVECO MAN MAZ
1878 052 842 (36x40-18N)	401 402 403 404 472 473 474 476 477 478 480 482 483 485 486 488 490 491 495 497 498 501 505 509 510 518 519 543 544 550 551 554 555 558 563 571 578 861 886 887	MERCEDES-BENZ	1878 080 031 (1 3/4"-10N)	813 819 822 823 830 299 837 838 839 840 845 846 848 849 850 376 854 567 568 569 574 575 576 591 592 597 603 604 610 621 622 626 627 629 868 869 876 883	EVOBUS LAZ MAN MAZ MERCEDES-BENZ
			1878 080 033 (2" -10N)	819 823 836 840 843 846 848 850 851 852 575 577 578 585 597 610 611 621 626 627 629 863 867 869 873 874 876 877 881 882 883	EVOBUS MAN MERCEDES-BENZ
			1878 080 034 (2" -10N)	821 822 823 168 169 177 179 180 181 182 183 184	EVOBUS MAN

Artikelnummer Article No.	Seite Page	Hersteller Manufacturer	Artikelnummer Article No.	Seite Page	Hersteller Manufacturer
1878 080 037 (2" -10N)	811	BOVA	1878 085 742 (1 3/4"-10N)	29	DAF
	812	DAF		821 822	EVOBUS
	815 821 822	EVOBUS		139	IVECO
	147	KAMAZ	903 904 905		NEOPLAN
	262 263 264	MAN	1878 086 741 (1 3/4"-10N)	11 12 13	DAF
	265 266 267			14 15 16	
	268 269 270			31	
	271 272 283			841 843 849	MAN
	284 289 290			850	
	299 300 301		924 925	VAN HOOL	
	302 303 306		1878 086 742 # (2"-10N)	926	VAN HOOL
	307 312 313				
	315 316 317		1878 086 941 (2"-10N)	195 196 197	MAN
	318 319 320			198 199 200	
	321 322 325			201 203 204	
	326 327 329			205 206 207	
	331 332 333			208 209 210	
	336 338 339			211 212 213	
	341 343 344			214 215 216	
	347 348 350			217 218 219	
	835 836 846			220 221 222	
	850 851 852			223 224 225	
	853			226 227 228	
	594 595 598	MERCEDES-BENZ		229 230 258	
	599 600 601			356 357 358	
	607 613 625			362 363 364	
	626 630 631			367 368 369	
	632 633 637			370 371 372	
	639 640 641			374 375	
	642 643 644		895 896	NEOPLAN	
	646 648 649		674 675 676	ÖSTERREICHISCHE AUTOMOBILFABRIK (ÖAF)	
	650 651 652		677 678		
	657 658 659		1878 087 141 ▲ (2"-10N)	624	MERCEDES-BENZ
660 661 662					
663 664 665		1878 087 241 (2"-10N)	756	VOLVO	
666 667 668					
669 863 867		1878 600 501 (26,5x28,9-26N)	379 381 382	MERCEDES-BENZ	
870 873 874			383 384 385		
875 877 882			386 401 402		
883 885 886			403 404 520		
889			856 858 861		
891 892 908	NEOPLAN		886		
909 910 911		1878 600 557 (36,1x44,7-10N)	774 775	VOLVO	
912					
923	TEMSA	1878 600 560 (36x40-18N)	518 519 543	MERCEDES-BENZ	
810	YAROVIT		544		
1878 085 641 (2"-10N)	147 148	KAMAZ	1878 600 563 (31x38,4-10N)	776 777	VOLVO
	837 838 846	MAN			
	890 891 892	NEOPLAN	1878 600 834 (1 1/4"-10N)	59 60 93	IVECO
	907 908			134 146 828	
	926	VAN HOOL		1878 600 841 (1 3/8"-10N)	59 60 93
810	YaMZ	134 135 827			
1878 085 741 (2"-10N)	1 2 3	ASTRA	828 829		
	80 81 82	IVECO	153	MAGIRUS-DEUTZ	
	84 85 86		1878 600 863 (23x26-23N)	5 16 17	DAF
	88 89 90				
	91 92 96		1878 634 014 ▲ (1 3/4"-10N)	587 606 611	MERCEDES-BENZ
	97 98 103			622	
	104 105 107		680 723	RENAULT TRUCKS	
	108 109 110		1878 634 017 ▲ (36x45-10N)	140 141 143	IVECO
	111 112 113			158 160 161	MAGIRUS-DEUTZ
	114 115 118			162 163	
	119 120 121				



Arithmetische Liste / Part number list

Artikelnummer Article No.	Seite Page	Hersteller Manufacturer	Artikelnummer Article No.	Seite Page	Hersteller Manufacturer
1878 634 020 (2"-10N)	144 146	IVECO	1878 654 641 (1 3/8"-10N)	747	VOLKSWAGEN
1878 634 022 # (2"-10N)	821 823 595 599 600 601 609 613 614 626 630 631 632 633 634 639 640 641 642 643 644 648 649 650 651 652 658 660 661 663 664 670 893 894 895 896 905 906	EOBUS MERCEDES-BENZ	1878 988 102 (26,5x28,9-26N)	748 749 750 927 928	VOLKSWAGEN
1878 634 023 (2"-10N)	821 823 893 894 895 896 905 906	EOBUS NEOPLAN	1878 992 401 # (36x40-20N)	518 519 537 541 542	MERCEDES-BENZ
1878 634 026 (2"-10N)	755 765 766 767 768 769 780 792 793 794 795 796 806 929 930 931 933 934 935	VOLVO	1878 994 001 (26,5x28,7-26N)	379 380 381 382 384 385 855 857 858 748 749 927	MERCEDES-BENZ VOLKSWAGEN
1878 634 027 (2"-10N)	569 593 594 598 605 611 623 624 626 629 637 638 647 656 863	MERCEDES-BENZ	1878 997 101 (23x29-10N)	41 43 44 45 46 47 48 60	IVECO
1878 634 034 (1 3/4"-10N)	825 826 827 681 685 711 712 713 714 715 717 759 760 781	IRISBUS RENAULT TRUCKS	1880 083 132 #	99 150 151 152 258 350 351 745 923	IVECO LIEBHERR MAGIRUS-DEUTZ MAN TAM
1878 634 038 (1 3/4"-10N)	759	VOLVO	1880 092 415 #	37 258 259 740	FAUN MAN STEYR
1878 634 039 ▲ (36x45-10N)	352 356 359 362 365 366 368 843 854 671 672 674 912 722	MAN ÖSTERREICHISCHE AUTOMOBILFABRIK (ÖAF) RENAULT TRUCKS	1881 009 201 # 1881 010 139 #	37 258 259 740	FAUN DEMAG LIEBHERR MAGIRUS-DEUTZ
1878 634 050 (26,6x29-26N)	405	MERCEDES-BENZ	1881 039 531 #	814 815 816 893 899 900 902 903 906 740 741	EOBUS NEOPLAN STEYR
1878 634 052 (23x27-10N)	394 395 396 397 545 548 872	MERCEDES-BENZ	1881 039 532 #	37 38 39 824 152 153 154 155 156 161 830 831 832 853 546 547 873 888 890 923	FAUN IKARUS MAGIRUS-DEUTZ MAN MERCEDES-BENZ TAM
1878 634 064 (18,3x20,4-24N)	545	MERCEDES-BENZ	1881 041 656 #	813 814 815 816 37 38 39 831 832 546 547 872	EVOBUS FAUN MAGIRUS-DEUTZ MERCEDES-BENZ
1878 634 065 (23x29-10N)	743	STEYR	1881 059 208	36 393 396 546 547 548 872	DEMAG MERCEDES-BENZ
1878 634 071 (26x32-10N)	516 517 518	MERCEDES-BENZ	1881 065 101	38	FAUN
1878 634 072 (28x35-10N)	740	STEYR	1881 089 002	37	FAUN
1878 634 076 (26x32-10N)	510 511 520 521 522 523 524 525 529 531 532	MERCEDES-BENZ	1881 089 009 ▲	515	MERCEDES-BENZ
1878 634 082 (26x32-10N)	37 395 396 398 548 549 551	FAUN MERCEDES-BENZ	1882 017 131	195 196 197 198 199 200 201 203 204 205 206 207 208 209 210 211 212 213 214 215 216 217 218 219 220 221 222 223 224 225 226 227 228 229 230 258 356 357 358 362 363 364	MAN















Artikelnummer Article No.	Seite Page	Hersteller Manufacturer	Artikelnummer Article No.	Seite Page	Hersteller Manufacturer		
1882 019 133	96	IVECO MERCEDES-BENZ	1882 231 131 #	510 511 516	MERCEDES-BENZ		
	593 594 595			520 521 522			
	597 598 599	523 527					
	600 601 605	1882 234 433	MERCEDES-BENZ	565 571 572	MERCEDES-BENZ		
	607 608 610			574 579 582			
	611 613 623			583 596 614			
	624 625 627		618 865 866	1882 250 143	888	VOLVO	
	628 629 630		752 753 756		757 758 759		
	631 632 633		801 802 803		805 930 934		
	637 638 639		1882 252 331	KÄSSBOHRER MERCEDES-BENZ	149	MERCEDES-BENZ	
	640 641 644				552 553 557		
	648 649 650				565 569 570		
	651 652 656			578 596 864	1882 252 333	865 888	EVOBUS MERCEDES-BENZ
	658 660 661			898 899 902		556 562 565	
662 663 665	906			570 578 596			
668 669	1882 261 013 #			NEOPLAN	156	MAGIRUS-DEUTZ STEYR	
1882 022 101 #					RENAULT TRUCKS		703 704 723
		740 742					357 360 361
	1882 110 513	362 363 364					
1882 110 532 #	MAN	MERCEDES-BENZ ÖSTERREICHISCHE AUTOMOBILFABRIK (ÖAF) RENAULT TRUCKS		365 366 367	MAN		
				258 350 351		369 371 372	
				352 354 355		373	
358 362	1882 280 112	DAF		752 753 803	VOLVO		
546 547			804				
671 672			149 150				
721	1882 280 140	MAN MERCEDES-BENZ	357 360 363	LIEBHERR MAN			
1882 110 542 ▲			DAF		372 374 375		
					7 8 9	752 754 756	
	17 812	757 758 759					
258	1882 280 213	MAN MERCEDES-BENZ	801 802 803	VOLVO			
547 574 576			804				
579 582 583			514 515 516				
602	1882 282 331	MERCEDES-BENZ	517 525 526	MERCEDES-BENZ			
1882 137 307 #			DAF TAM		527 531		
					6 7 17	567 568 569	
	745	575 576 577					
1882 166 737	149	LIEBHERR MERCEDES-BENZ	584 603 615	MERCEDES-BENZ			
	547 563 564		616 634 635				
	568 572 576		868 869 871				
	579 582 583		889				
	584 585 586		893				
	590 591 592		1882 301 238 #		NEOPLAN	811	BOVA DRÖGMÖLLER EVOBUS
	596 602 603					812 813	
	604 609 610					815 816 817	
	616 617 619		1882 301 239		SETRA MERCEDES-BENZ	818 819 820	IVECO
	634 887 888					823	
	919					140 141 143	
	1882 201 132		396 398 555		MERCEDES-BENZ	144 145	MAGIRUS-DEUTZ MAN
			556 559 561			160 161 162	
			562 564 565			354 355 356	
570 573 595		357 359 360					
865 888		361 362 363					
1882 205 234	37	FAUN MERCEDES-BENZ	364 365 366	VOLVO			
	395 396 398		368 369 370				
	548 549 550		371 372 841				
	551 872 886		842 849 854				
1882 209 335 #	351 352 353	MAN		MERCEDES-BENZ			
	354 355 356						
	359 361 362						
1882 226 533	757 758 759	VOLVO		MERCEDES-BENZ			
	801 802 803						
	805 806 929						
	930 932 934						
1882 229 131 #	511 512 513	MERCEDES-BENZ		MERCEDES-BENZ			

Arithmetische Liste / Part number list

Artikelnummer Article No.	Seite Page	Hersteller Manufacturer	Artikelnummer Article No.	Seite Page	Hersteller Manufacturer		
1882 302 131	815 816 817	EVOBUS	1882 325 139	38 39	FAUN		
	818 823			79 80 92		IVECO	
	149			93 94 95			
	352 353 354	97 98 136					
	355 356 358	LIEBHERR MAN		137 138 143	MAGIRUS-DEUTZ		
	359 361 362			152 157 158			
	364 365 367			160 832 833			
	368 370 372			1882 327 003 #		741 742 743	STEYR
	841 844 848			1882 330 032 #		12	DAF
	849			824		158 160 161	IKARUS
	561 566 567			MERCEDES-BENZ		162	MAGIRUS-DEUTZ
	568 569 575	352 354 356			MAN		
	576 577 582	359 362 365					
	583 584 585	366 368 841					
	586 590 591	844 854			MERCEDES-BENZ ÖSTERREICHISCHE AUTOMOBILFABRIK (ÖAF) RENAULT TRUCKS VAN HOOL		
	602 603 604	616 870 871					
	610 615 616	671 672 674					
617 618 619	722	DRÖGMÖLLER					
634 635 868	924		EVOBUS				
869 871 889	NEOPLAN RENAULT TRUCKS VAN HOOL	820 821	MERCEDES-BENZ				
893 894		588 589 607					
720 721 914		612 619 620					
925	625 636 638	640 641 646	653 655 659	660 664 666			
1882 302 132 #	590 591 602	MERCEDES-BENZ	1882 341 001	813	EVOBUS		
1882 302 135 #	568 576 577	MERCEDES-BENZ	820 821	588 589 607			
	585 586 587		612 619 620	625 636 638			
	610 617 622		640 641 646	653 655 659			
1882 304 208	736 737	STEYR	660 664 666	1882 342 134		816 818 819	
1882 305 131	552 553 554	MERCEDES-BENZ	820	357 360 361		MAN	
	556 557 559		362 363 364	365 366 367			
	565 570 578		369 371 372	373 374 375			
	596 864 865		841 842 843	845 846 848		MERCEDES-BENZ	
	888		849	587 588 589			
1882 305 132	559 562 565	MERCEDES-BENZ	587 588 589	606 607 612			
	570 578		606 607 612	618 619 620			
1882 306 136 #	94 95 97	IVECO	624 638 640	645 646 653			
	159	MAGIRUS-DEUTZ	645 646 653	655 659 660			
1882 306 210	143	IVECO	664 666 867	664 666 867			
1882 307 131 ▲	97	IVECO	870 878 879	870 878 879			
	155	MAGIRUS-DEUTZ	880 881	880 881			
1882 311 131 #	867	MERCEDES-BENZ	890 893 894	890 893 894	NEOPLAN		
	898 899 902	NEOPLAN	896 897 900	896 897 900			
	907		901 902 903	901 902 903			
1882 316 035 #	824	IKARUS	904 905	742 743	STEYR		
	94 95 97	IVECO	742 743	923			
	98 143 145		924 925 926	924 925 926			
	159 160 832	MAGIRUS-DEUTZ	1882 342 135 #	819	EVOBUS		
	833 834		843 845 849	850			
1882 317 131 #	395 398 551	MERCEDES-BENZ	850	924 925			
	552 553 554		924 925	357 360 366	MAN		
	557 558 559		1882 346 131 #	369 371 373			
	864 872		369 371 373	587 588 605			
1882 320 131	162	MAGIRUS-DEUTZ			MERCEDES-BENZ		
1882 325 134	813 814 815	EVOBUS					
	816 823						
	138 143 144	IVECO					
	829 830						
	152 156 157	MAGIRUS-DEUTZ					
	158 159 161						
	162 831 832						
	833						
	258 352 354	MAN					
	678 679	ÖSTERREICHISCHE					

Artikelnummer Article No.	Seite Page	Hersteller Manufacturer	Artikelnummer Article No.	Seite Page	Hersteller Manufacturer			
1882 349 003	812	DRÖGMÖLLER MERCEDES-BENZ	1888 067 031 # (310/45x50-24N)	516 517 518	MERCEDES-BENZ			
	589 605 606			529 530 533				
	608 609 612			534 537 538				
	620 621 639			1888 067 042 # (310/41x45-22N)		514 515 516		
	643 653 654					517 525 529		
	655 656 657					530 531 532		
	659 661 665					534 539 540		
	668			1888 600 101 # (225/45x50-24N)		521 523	MERCEDES-BENZ	
	890 897					511 512 513		
	1882 600 122			37		FAUN MERCEDES-BENZ	1888 877 101 # (Ge 280/45x50-24N) (Mo 280/26x32-10N)	514 515 517
395 396 398		523 524 525						
548 549 551		526 527 528						
872		531						
1888 015 346	357 360 361	MAN	1888 877 102 # (280/45x50-24N)	512 514 515	MERCEDES-BENZ			
	362 363 364			516 517 523				
	365 366 367			524 525 526				
	369 371 372			527 528 530				
	373			531				
1888 015 515 # (380/ 2"-10N)	752 754 803 804	VOLVO	1888 877 103 # (280/45x50-24N)	515 516 517	MERCEDES-BENZ			
1888 015 523 #	149 150 372	LIEBHERR MAN		523 525 526				
1888 019 445 #	752 756 757	VOLVO	1888 893 001 # (225/45x50-24N)	510 511 520	MERCEDES-BENZ			
	758 759 801			521 522 523				
	802 803 805			524 525 529				
	930 934			531 532				
1888 019 542 #	752 753 802 803	VOLVO	1888 916 001 # (330/45x50-24N)	518 519	MERCEDES-BENZ			
1888 042 009	813	DRÖGMÖLLER EVOBUS MERCEDES-BENZ	1888 998 201 # (310/45x50-24N)	516 517 518	MERCEDES-BENZ			
	820 821			529 530 534				
	588 589 607			537 538				
	612 619 620			1888 998 902 # (330/45x50-24N)		533 534 535		
	625 636 638					536 537 538		
	640 641 646					539 540 541		
	653 655 659			542 543		1897 375 775	679 689 706	RENAULT TRUCKS
	660 664 666			707 709 721				
	1888 055 041			812		DRÖGMÖLLER MERCEDES-BENZ	2290 601 007	723 724
589 606 612		379 381 382						
620 639 653		383 384 856						
654 656 657		857						
1888 055 247	589 605 608	MERCEDES-BENZ	2290 601 011 	379 380 381	MERCEDES-BENZ			
	609 621 643			383 384 386				
	655 661 665			387 855 857				
	668			858				
	890 897			2290 601 018 		387 388 389	MERCEDES-BENZ	
96	390 391 392							
1888 063 137	593 594 595	IVECO MERCEDES-BENZ	2290 601 081 	393 859 860	MERCEDES-BENZ			
	597 598 599			387 388 389				
	600 601 605			390 391 392				
	606 607 608			393 405 406				
	610 611 613			859 860 861				
	620 623 624			862				
	625 627 628			2294 000 525		379 381 382	MERCEDES-BENZ	
	629 630 631					383 385 386		
	632 633 637			401 402 403		2294 000 767	MERCEDES-BENZ	
	638 639 640			404 856 858				
	641 643 644			861 886				
	645 647 648			379 380 381				
	649 650 651			382 383 384		2294 000 834	MERCEDES-BENZ	
	652 654 656			386 856 857				
	658 660 661			404 405 406				
	662 663 665							

Arithmetische Liste / Part number list

Artikelnummer Article No.	Seite Page	Hersteller Manufacturer	Artikelnummer Article No.	Seite Page	Hersteller Manufacturer
2294 000 835	387 388 389 390 391 392 393 859 860	MERCEDES-BENZ	3000 951 784  (26,5x28,7-26N)	405 406	MERCEDES-BENZ
2294 000 994	387 388 389 390 391 392 393 405 406 859 860 861 862	MERCEDES-BENZ	3000 951 785	379 381 382 383 384 385 386 401 402 403 404 520 856 858 861 886	MERCEDES-BENZ
2294 001 744	406	MERCEDES-BENZ	3000 951 824 (26x29-26N)	388 389 390 391 392 393 860	MERCEDES-BENZ
2294 501 207	746	VOLKSWAGEN	3000 951 841 (26,59x28,92-26N)	746	VOLKSWAGEN
3000 055 005	824 747 748 751 927	IKARUS VOLKSWAGEN	3000 951 876	746 747	VOLKSWAGEN
3000 055 006 ▲	747 748 751 926 927	VOLKSWAGEN	3000 951 932 (26,5x28,7-26N)	746 747	VOLKSWAGEN
3000 297 002	398 399 400	MERCEDES-BENZ	3000 970 079 	404 405 406 407 861 862 863	MERCEDES-BENZ
3000 424 002	377 855	MERCEDES-BENZ	3000 990 101	671	NISSAN
3000 434 001	41 42 45 46	IVECO	3000 990 144 	387 388 389 390 391 392 393 858 859 860	MERCEDES-BENZ
3000 725 001	379 381 382 383 385 386 401 402 403 404 856 858 861 886	MERCEDES-BENZ	3000 990 195 	388 389 390 391 392 393 860	MERCEDES-BENZ
3000 726 001	380 384 405 856 857	MERCEDES-BENZ	3000 990 204	746	VOLKSWAGEN
3000 826 901	379 380 381 382 384 385 855 857 858 748 749 927	MERCEDES-BENZ VOLKSWAGEN	3000 990 217	746 747	VOLKSWAGEN
3000 828 601	749 750 928	VOLKSWAGEN	3000 990 218  (26,5x29-26N)	378 379 380 381 382 383 384 385 386 387 855 856 857 858	MERCEDES-BENZ
3000 840 101	17	DAF	3000 990 246	746 747	VOLKSWAGEN
3000 845 001	749 751 928	VOLKSWAGEN	3000 990 252  (26,5x29-26N)	378 379 380 381 382 383 384 385 386 387 855 856 857 858	MERCEDES-BENZ
3000 845 101	749 750 927 928	VOLKSWAGEN	3000 990 287 	387 388 389 390 391 392 393 405 406 859 860 861 862	MERCEDES-BENZ
3000 845 801	748 750 927	VOLKSWAGEN	3000 990 362	746	VOLKSWAGEN
3000 846 501	406	MERCEDES-BENZ	3000 990 381	377	MERCEDES-BENZ
3000 950 701	17	DAF	3000 990 382	671	NISSAN
3000 950 746 	746	VOLKSWAGEN	3000 990 394	671	NISSAN
3000 950 932  (26,60x28,89-26N)	387 407 863	MERCEDES-BENZ	3000 990 415 	746	VOLKSWAGEN
3000 951 026	41 42 43 44 45 46 47 48 49 50 704 705	IVECO RENAULT TRUCKS	3074 003 343	747 748 751 926 927	VOLKSWAGEN
3000 951 103	671	NISSAN	3074 600 205	377 855	MERCEDES-BENZ
3000 951 104	748 749 750 927 928	VOLKSWAGEN	3082 007 338	743	STEYR
3000 951 107  (26,5x28,9-26N)	749 751 928	VOLKSWAGEN	3082 078 032	545	MERCEDES-BENZ
3000 951 112  (26,6x28,9-26N)	404 405 407 862 863	MERCEDES-BENZ	3082 086 434	747 748	VOLKSWAGEN
3000 951 128 	377 378	MERCEDES-BENZ	3082 121 031	393 394 395 396 397 398 399 400 545 546 548 872	MERCEDES-BENZ
3000 951 188 (26x29-26N)	387 388 389 390 391 392 393 858 859 860	MERCEDES-BENZ	3082 156 031	906	NEOPLAN
3000 951 205	406	MERCEDES-BENZ	3082 157 031	516	MERCEDES-BENZ
3000 951 373  (23,1x28,7-10N)	670	NISSAN	3082 178 132	670	MULTICAR
3000 951 710	749 750 928	VOLKSWAGEN			

Artikelnummer Article No.	Seite Page	Hersteller Manufacturer	Artikelnummer Article No.	Seite Page	Hersteller Manufacturer
3082 190 031	824	IKARUS	3100 026 431	934 936	VOLVO
	747 748 751	VOLKSWAGEN	3100 026 432	755 756 936	VOLVO
	926 927		3100 026 434	782 784 786	VOLVO
3082 191 032	377 855	MERCEDES-BENZ		797 800 936	
3082 267 233	379 380 381	MERCEDES-BENZ	3130 010 100	515	MERCEDES-BENZ
	382 383 384		3151 000 020	378	MERCEDES-BENZ
	405 406 856		3151 000 034	811	BOVA
857		23 24 25		DAF	
3082 268 031	379 380 381	MERCEDES-BENZ		26 27 28	
	382 384 385		29 32 33		
	406 855 857		34 35		
	858		146 147 148	KAMAZ	
	748 749 927	VOLKSWAGEN	149 830		
3082 269 031	379 381 382	MERCEDES-BENZ	168 169 170	MAN	
	383 384 385		175 176 177		
	386 401 402		178 179 180		
	403 404 515		181 182 183		
	516 520 856		184 185 186		
3082 308 043	749 750 927	VOLKSWAGEN	187 188 189		
	928		190 191 192		
	3082 600 509	749 750 928	VOLKSWAGEN	193 194 195	
3082 600 522		748 749 750	VOLKSWAGEN	196 197 198	
		927 928		199 200 201	
3082 600 568	377 378	MERCEDES-BENZ	202 203 204		
3082 639 402	748 750 927	VOLKSWAGEN	205 206 207		
3082 737 001	17	DAF	208 209 210		
3082 919 001	749 751 928	VOLKSWAGEN	211 212 213		
3082 956 001	16 17	DAF	214 215 216		
3082 973 001	17	DAF	217 218 219		
3083 039 031	41 42 43	IVECO	220 221 222		
	44 45 46		223 224 225		
	47 48 49		226 227 228		
	50		229 230 257		
	704 705	RENAULT TRUCKS	258 260 261		
3100 000 003	641	MERCEDES-BENZ	262 263 264		
3100 002 038	96 97 131	IVECO	265 266 267		
	132 133 141		268 269 270		
	142 145		271 272 273		
	164	MAGIRUS-DEUTZ	274 275 276		
3100 002 040	131 132 133	IVECO	277 278 279		
	134 139 140		280 282 283		
	141 142 143		284 285 286		
	145		287 288 289		
	164	MAGIRUS-DEUTZ	290 291 292		
3100 002 549	933	VOLVO	299 300 301		
3100 005 202	730	SCANIA	302 303 304		
3100 008 106	826 827	IRISBUS	305 306 307		
	680 681 682	RENAULT TRUCKS	308 309 310		
	683 686 687		311 312 313		
	688 695 696		314 315 316		
	698 700 701		317 318 319		
	702 703 704		320 321 322		
	705 706 719		323 324 325		
	720 724 914		326 327 328		
	915 916		329 330 331		
	917 918	SCANIA	332 333 334		
3100 008 204	681 682 683	RENAULT TRUCKS	335 336 337		
	696 701 702		338 339 340		
	703 704 705		341 342 343		
	706 724		344 345 346		
3100 023 031	40	HINO	347 348 349		
			350 358 363		
			367 374 375		

Artikelnummer Article No.	Seite Page	Hersteller Manufacturer	Artikelnummer Article No.	Seite Page	Hersteller Manufacturer
3151 000 335	812	DAF	3151 000 396	401 402 403	MERCEDES-BENZ
	850 851 852	MAN		404 472 476	
	853			477 478 480	
	874 875 882	MERCEDES-BENZ		482 483 484	
	883 884 885			485 486 488	
	886			489 490 491	
	891 909 910	NEOPLAN		492 493 494	
	911			495 496 498	
	919 920 921	SETRA		499 503 504	
3151 000 374	551 554 555	MERCEDES-BENZ	519 861 881		
	558 563 564		884 886		
	568 571 572				
	573 574 578		3151 000 397	18 19 20	DAF
	579 581 582		3151 000 404	691 692 693	RENAULT TRUCKS
	583 590 591		694 696 697		
	592 596 609		713 714 715		
	610 614 621		716		
	887 889		3151 000 419	827	IVECO
3151 000 375	811	BOVA	146 147	KAMAZ	
	812 813	DRÖGMÖLLER	830	KAVZ	
	149	LIEBHERR	376	MAZ	
	561 567 568	MERCEDES-BENZ	898	NEOPLAN	
	569 575 576		923	TAM	
	577 582 583		810	YaMZ	
	584 585 586		3151 000 493	1 2 3	ASTRA
	587 588 590		4		
	591 602 603		23 24 28		DAF
	604 605 606		29 30 34		
	610 611 612		35 36		
	615 616 617		40		HINO
	618 619 620		825 826		IRISBUS
	622 634 635		60 80 81		IVECO
	636 638 645		82 84 85		
	647 649 652		86 88 89		
	653 654 656		90 91 92		
	657 659 666		99 100 101		
	667 867 868		102 103 104		
869 870 871		105 106 107			
878 879		108 109 110			
894 895 896	NEOPLAN	111 112 113			
898 899 900		114 115 116			
901 902 903		117 118 119			
904 905 906		120 121 122			
923	TAM	123 124 125			
3151 000 392	604 634	MERCEDES-BENZ	126 127 128		
3151 000 395	811	BOVA	129 130 133		
	7 8 9	DAF	140 142 144		
	10 11 12		828		
	13 14 15		147		KAMAZ
	16 17 18		260 261 262		MAN
	19 20 21		263 264 265		
	22 23 24		266 267 268		
	29 31 32		269 270 271		
	813 814 815	EVOBUS	272 273 274		
	816 823		275 276 277		
	37 38 39	FAUN	278 279 280		
	92 97 136	IVECO	281 282 283		
	143 144		284 285 286		
	830	KING LONG	287 288 289		
	149	LIEBHERR	290 291 292		
	152 154 156	MAGIRUS-DEUTZ	294 295 296		
	157 158 159		297 298 299		
	160 161 162		300 301 302		
			303 304 305		

Arithmetische Liste / Part number list

Artikelnummer Article No.	Seite Page	Hersteller Manufacturer	Artikelnummer Article No.	Seite Page	Hersteller Manufacturer
3151 000 497	863	MERCEDES-BENZ	3151 000 615	815 819 821	EVOBUS
3151 000 515	1	ASTRA		822 823	
	811	BOVA		918	SETRA
	9 11 12	DAF	3151 000 651	18 19 20	DAF
	14 15 16			21 22 29	
	17 25 812			99 100 117	IVECO
	816	EVOBUS	3151 000 750	40	HINO
	824	IKARUS	3151 000 752	681 684 685	RENAULT TRUCKS
	60 62 68	IVECO		711 713 717	
	70 71 74			759 760 781	VOLVO
	75 77 79		3151 000 809	717	RENAULT TRUCKS
	80 94 95			759	VOLVO
	96 97 98		3151 000 958	146 147 148	KAMAZ
	99 136 138			351 352 353	MAN
	139 140 141			354 355 356	
	143 144 145			358 359 361	
	146			362	
	153 155 156	MAGIRUS-DEUTZ		375 376	MAZ
	157 158 159			554	MERCEDES-BENZ
	160 161 162			720	RENAULT TRUCKS
	163 164 832		3151 001 035	700 718 719	RENAULT TRUCKS
	833 834		3151 001 082	884 885	MERCEDES-BENZ
	281 292 293	MAN	3151 001 083	413 471	MERCEDES-BENZ
	294 295 296		3151 001 084	826	IRISBUS
	299 841 842			828	IVECO
	844 845		3151 001 101	731	SCANIA
	917	SCANIA	3151 011 001 ▲	743	STEYR
	737 738 739	STEYR	3151 021 001	515 520	MERCEDES-BENZ
	742 743		3151 027 102	815 816 817	EVOBUS
	924 925	VAN HOOL		818 819 820	
3151 000 529	576 583 584	MERCEDES-BENZ		821 823	
	585 602 603			731 732	SISU
	604 609 610		3151 027 133	816 819 820	EVOBUS
	616 617 634		3151 032 341	225 226	MAN
	863 872		3151 033 031	395 396 398	MERCEDES-BENZ
	919	SETRA		548 549 550	
3151 000 547	822	EVOBUS		551 552 553	
	595 599 600	MERCEDES-BENZ		554 557 558	
	601 609 613			559 560 561	
	614 626 630			562 564 566	
	631 632 633			573 579 580	
	634 639 640			581 864 872	
	641 642 643			886	
	644 648 649		3151 043 031	561 566 574	MERCEDES-BENZ
	650 651 652			582 583 614	
	658 660 661			867	
	663 664 670		3151 044 031	395 396 398	MERCEDES-BENZ
	667 669 670			548 549 550	
	667 669 670			551 552 553	
	873 874 875			554 555 557	
	876 877 882			558 559 560	
	883 889			561 562 563	
3151 000 549	567 568 569	MERCEDES-BENZ		564 565 566	
	574 575 576			571 572 573	
	577 586 591			574 578 579	
	592 593 594			580 581 596	
	597 603 604			618 864 872	
	605 606 608			875 886 887	
	610 621 622			891 906	NEOPLAN
	623 624 625		3151 045 001	36	DEMAG
	626 627 629			37	FAUN
	631 637 642			149	LIEBHERR
	643 647 656				
	657 659 660				

Artikelnummer Article No.	Seite Page	Hersteller Manufacturer	Artikelnummer Article No.	Seite Page	Hersteller Manufacturer			
3151 051 031	529 530 531	MERCEDES-BENZ	3151 110 031	587 588 589	MERCEDES-BENZ			
	532 533 534			606 607 612				
	535 536 537			618 619 620				
	538 539 540			624 638 640				
	541 542			645 646 653				
3151 054 031	137 138 141	IVECO		655 659 660				
3151 065 031	41 42 43	IVECO	3151 111 032	10	DAF MAGIRUS-DEUTZ STEYR			
	44 45 46			156				
	47			741				
3151 067 032	356 357 359	MAN	3151 114 031	92 93 95	IVECO			
	360 361 362			134 137 138				
	363 364 365			139 140 141				
	366 367 368			142 829				
	369 370 371			3151 116 031	571 573 580	MERCEDES-BENZ		
	372 373 374				3151 117 031		144 146	IVECO
	375				3151 119 001		890 893	NEOPLAN
3151 068 101	375	MAZ	3151 123 031	96 97 131	IVECO			
	898	NEOPLAN		132 133 141				
3151 069 032 ▲	516	MERCEDES-BENZ		142 145				
3151 069 131	906	NEOPLAN		164	MAGIRUS-DEUTZ			
3151 071 032	137	IVECO	3151 126 031	567 568 569	MERCEDES-BENZ			
	159			575 576 577				
3151 079 031	566 567 568	MERCEDES-BENZ		585 586 587				
	575 584 590			615 617 622				
	591 603 615			867 868 869				
	616 617			870 878 879				
3151 082 001	736 737 742	STEYR		880 881 889				
	743			923	TAM			
3151 090 131	888	MERCEDES-BENZ	3151 127 031	92 93 137	IVECO			
3151 094 041	565 572 579	MERCEDES-BENZ		138 139 140				
	582 583 596			141 142 829				
	614 865 866			159 160 161		MAGIRUS-DEUTZ		
	888		163 164					
3151 095 043	395 396 398	MERCEDES-BENZ	3151 145 101	37	ENASA			
	546 548 549		3151 156 003	733 734 735	STEYR			
	550 551 552			736				
	553 555 556		3151 166 031	592 593 594	MERCEDES-BENZ			
	557 559 561			595 597 598				
	562 564 565			599 600 601				
	570 573 578			604 605 607				
	595 596 864			608 610 611				
	865 872 886			613 622 623				
	888			624 625 627				
	628 629 630							
	631 632 633							
	637 638 639							
	640 641 644							
	647 648 649							
	650 651 652							
	656 658 660							
	661 662 663							
	665 668 669							
3151 098 031	829	IVECO	3151 170 131	824	IKARUS MERCEDES-BENZ			
	159			399 400 401				
3151 099 101	817	EVOBUS		550 860				
3151 105 141	753 757 758	VOLVO	3151 182 031 ▲	617 624	MERCEDES-BENZ			
	759 801 802			3151 182 233		811	BOVA DAF	
	803 805 806					11 12 14		
	932					15 16 25		
						26 31 32		
	33							
3151 106 041	752 753 754	VOLVO	3151 186 001	890 897	NEOPLAN			
	756 757 758							
	759 801 802							
	803 804 805							
3151 108 031	813	DRÖGMÖLLER						
	820 821		EVOBUS					
	588 589 605	MERCEDES-BENZ						
	606 607 608							
	609 612 619							
	620 621 625							
	636 638 639							
	640 641 643							
	646 653 654							

Arithmetische Liste / Part number list

Artikelnummer Article No.	Seite Page	Hersteller Manufacturer	Artikelnummer Article No.	Seite Page	Hersteller Manufacturer
3151 193 041	824	IKARUS	3151 249 001	924 925 926	VAN HOOL
	747 748 751		VOLKSWAGEN	3151 250 231	824 825 826
	926 927	827		690 691 692	RENAULT TRUCKS
3151 196 031	92 93 96	IVECO	693 694 695	696 697 698	
	99 136		709 713 714	715 716 913	
3151 198 031	377 855	MERCEDES-BENZ	914 915		
3151 199 001	5	AVIA	3151 253 031	164 168 232	MAN
	6 7 8	DAF	236 240 242	243 244 245	
	20		246 247 248	249 250 251	
	79 93 97	IVECO	257 259 281	294 296 297	
	135 136 828		298 299	734 735 736	STEYR
	829		738		
	152 153 154	MAGIRUS-DEUTZ	3151 262 031	165 166 167	MAN
	155 831 832		169 170 171	172 173 174	
	833		175 176 177	178 179 180	
	231 239 241	MAN	181 183 184	186 187 188	
	251 252 253		189 190 191	192 259 261	
	254 255 256		263 279 282	283 284 285	
	257 350 351		286 287 288	289 290 291	
	353 355 358		292 300 301	302 303 304	
	834 835 839		305 306 307	308 309 310	
	842 847 848		311 312 313	314 315 316	
	898	NEOPLAN	317 318 319	320 321 322	
	689 707 710	RENAULT TRUCKS	323 324 325	326 327 328	
	724		329 330 331	332 333 334	
	733 734	STEYR	335 336 337	338 339 340	
3151 202 001	376	MAZ	341 342 343	344 345 346	
3151 202 002	895 896 898	NEOPLAN	347 348 349	350	
3151 204 001	197 199 200	MAN	690 691 692	693 694 695	RENAULT TRUCKS
	201 203 204		696 697 698	699 700 714	
	205 206 207		715 716 717	718 719	
	208 210 213		737 739 744	745	STEYR
	214 215 216				
	217 219 220				
	222 223 224				
	225 229 246				
	247 249 258				
	364 374				
	585 605 606	MERCEDES-BENZ			
	607 618 620				
	627 628 630				
	635 636 639				
	640 645 646				
	647 649 652				
	653 654 655				
	656 657 658				
	659 660 664				
	665 666 667				
	686 687 703	RENAULT TRUCKS			
	704				
3151 205 202	730	SCANIA			
3151 207 031	134 829	IVECO			
3151 208 001	1	ASTRA			
	149 150	LIEBHERR			
3151 217 001	811	BOVA			
	737 738 739	STEYR			
3151 234 132	826	IRISBUS			
	680 688 702	RENAULT TRUCKS			
	914 915 916				
3151 234 231	724	RENAULT TRUCKS			
3151 248 031	379 380 381	MERCEDES-BENZ	3151 263 031	21 22 23	DAF
	382 383 384		25 26 31	148	KAMAZ
	385 386 401		168 169 176	177 178 179	MAN

Artikelnummer Article No.	Seite Page	Hersteller Manufacturer	Artikelnummer Article No.	Seite Page	Hersteller Manufacturer		
3151 270 341	686 687 689	RENAULT TRUCKS	3180 007 000	729 917	SCANIA		
	702 707 708		3182 002 131	MERCEDES-BENZ			
	709 710 711				516 517 518		
	712 713 724				529 530 533		
	913				534 535 536		
3151 270 602	545	MERCEDES-BENZ	537 538 539				
3151 273 601	811	BOVA	540 541 542				
3151 274 131	690 691 692	RENAULT TRUCKS	3182 002 132	515	MERCEDES-BENZ		
	693 694 695		3182 003 131	MERCEDES-BENZ			
	697 698 699				517 518 530		
	700 714 715				533 534 535		
	716 717 718				536 537 538		
719	539 540 541						
3151 278 941	690 691 692	RENAULT TRUCKS	542 543				
3151 600 529	693 694	IVECO	3182 005 231	168 232 233	MAN		
	41 42 43		3182 009 938	SCANIA			
	44 45 46				234 235 236		
	47 48 49				237 240 241		
	50 53 55				242 245 246		
58 59 60	251 252 253	STEYR					
704 705	254 299 835						
3151 600 533	752 756 758		VOLVO	732 733 734	735 736		
	761 776 777			3182 600 101	472 473 474	MERCEDES-BENZ	
	802 805 930	476 477 478					
	931 932 934	480 482 483					
	3151 600 534	761 776 777		VOLVO	484 485 486		
929 930 932		488 489 490					
934		491 492 493					
3151 600 535		761 776 932	VOLVO		494 495 496		
		230 231 834			497 498 499		
	835	500 501 503					
	3151 600 544	60 61 62		IVECO	504 505 506		
		65 66 67			509 510 518		
69 70 71		519 520 543					
72 73 74		544	3182 600 141		MERCEDES-BENZ		
75 76 77		472 473 474					
78 79 80	476 477 478						
709 710 711	480 482 483						
713	485 486 488						
3151 600 548	17	DAF	490 491 495				
3151 600 595	711 712 713	RENAULT TRUCKS	497 498 500				
	714 715		501 505 509				
3151 600 724	17	DAF	544				
3151 600 751	679 706 707	RENAULT TRUCKS	3182 600 142	292 293 294	MAN		
3151 824 001 ▲	135 136	IVECO		295			
3151 824 005	752 756 758	VOLVO	3182 600 166	MERCEDES-BENZ			
	777 802 805						
	934						
3151 870 001	724	ROBUR	473 474 476				
3151 997 201	747	VOLKSWAGEN	478 480 482				
3163 026 100	8 9 10	DAF	483 485 486				
	8		488 490 491				
3180 000 009	826	IRISBUS RENAULT TRUCKS	495 497 498				
	680 688 702		500 501 505				
	724 914 915		509 544				
	916		3182 600 172	473 474 497	MERCEDES-BENZ		
	917 918		500 501 505	509			
782 784 786	SCANIA	3182 600 189	473 474 497	MERCEDES-BENZ			
797 800 934	VOLVO	501 505 509					
3180 001 008	936	HINO IVECO	3182 654 142	671	NISSAN		
	40		3182 654 169	377 378	MERCEDES-BENZ		
	96 97 131		3182 654 192 [®]	378 379 380	MERCEDES-BENZ		
				381 382 383			
				384 385 386			
			387 388 389				

Arithmetische Liste / Part number list

Artikelnummer Article No.	Seite Page	Hersteller Manufacturer	Artikelnummer Article No.	Seite Page	Hersteller Manufacturer
3182 654 203	405 406	MERCEDES-BENZ	3189 600 009	165 166 167	MAN
3182 654 204	377	MERCEDES-BENZ		169 171 172	
3182 654 216	404 405 861 862 863	MERCEDES-BENZ		173 174 175	
3182 997 802	378 379 380 381 382 383 384 385 386 855 856 857 858 746 747	MERCEDES-BENZ VOLKSWAGEN		176 177 178 179 180 183 184 186 187 188 189 190 191 192 259 690 693 695 713 714 715 716	RENAULT TRUCKS
3182 998 501	232 233 238 239 240 242 246 247 472 473 474 476 477 478 480 482 483 484 485 486 488 489 490 491 492 493 494 495 496 497 498 499 500 501 503 504 505 506 509 544 782	MAN MERCEDES-BENZ VOLVO	3189 600 014	183 184 185 188 190 192 206 207 209 210 211 212 213 214 216 218 219 220	MAN
3189 600 004	1 2 3 4 23 24 28 29 30 34 35 36 40 825 826 60 80 81 82 84 85 86 88 89 90 91 92 99 100 101 102 103 104 105 106 107 108 109 110 111 112 113 114 115 116 117 118 119 120 121 122 123 124 125 126 127 128 129 130 133 828 147 260 261 262 263 273 274 275 276 277 278 279 280 281 282 283 284 285 286 287 288 289 290 291 292 294 295 296 297 298 299 300 301 302 303 304 305 306 307 308 310 312 313	ASTRA DAF HINO IRISBUS IVECO KAMAZ MAN	3189 600 020	168 169 170 175 176 177 178 179 180 181 182 183 184 185 186 187 188 189 190 191 192 193 194 195 196 197 198 199 200 201 202 203 204 205 206 207 208 209 210 211 212 213 214 215 216 217 218 219 220 221 222 223 224 225 226 227 228 229 230 257 258 260 261 262 263 264 265 266 267 268 269 270 271 272 273 274 275 276 277 278 279 280 282 283 284 285 286 287 288 289 290 292 299 300 301 302 303 306 307 309 311 312 313 314 315 316 317 318 319 320 321 322 323 324 325 326 327 329 331 332 333 336 338 339 341 343 344 347 348 349 350 358 363 367 374 375 834 835	MAN

Artikelnummer Article No.	Seite Page	Hersteller Manufacturer	Artikelnummer Article No.	Seite Page	Hersteller Manufacturer
3189 600 028	732	SNVI	3189 600 060	561 567 568	MERCEDES-BENZ
3189 600 030	29 30 36	DAF		569 575 576	
3189 600 036	170 175 177	MAN		577 582 583	
	181 184 186			584 585 586	
	189 190 191			587 588 590	
	192 261 263			591 602 603	
	279 282 283			604 605 606	
	284 285 286			610 611 612	
	287 288 289			615 616 617	
	290 291 292			618 619 620	
	300 301 302			622 634 635	
	303 304 305			636 638 645	
	306 307 308			647 649 652	
	309 310 311			653 654 656	
	312 313 314			657 659 666	
	315 316 317			667 867 868	
	318 319 320			869 870 871	
	321 322 323			878 879	
	324 325 326		3189 600 061	761 762 763	VOLVO
	327 328 329			764 765 766	
	330 331 332			767 768 769	
	333 334 335			782 783 784	
	336 337 338			785 786 787	
	339 340 341			788 789 790	
	342 343 344			791 792 796	
	345 346 347			797 798 799	
	348 349 350			800 933	
	737 739 744	STEYR	3400 030 033 #⊕	755 805 807	VOLVO
	745		3400 031 033 ⊕	753 755 778	VOLVO
3189 600 041	292 293 294	MAN		779 780 804	
	295			805 806 930	
3189 600 044	281 294 295	MAN	3400 032 033 #⊕	779 780	VOLVO
	296 299		3400 035 032 #⊕	761 778	VOLVO
3189 600 045	292 293 294	MAN	3400 037 031	761 776 777	VOLVO
	295			931 932	
	681 684 685	RENAULT TRUCKS	3400 037 032	752 777 802	VOLVO
	760 781	VOLVO		934	
3189 600 053	164	MAN	3400 040 032 ⊕	753 761 778	VOLVO
3189 600 056	731	SCANIA		779 780 804	
3189 600 057	409 410 412	MERCEDES-BENZ		930	
	413 414 415		3400 042 031 ⊖	95 96 97	IVECO
	417 418 420			99 137 138	
	421 422 423			139 140 141	
	426 427 428			142 143 145	
	429 432 433			829	
	434 435 436			163	MAGIRUS-DEUTZ
	437 438 439		3400 043 032 ⊕	755 765 766	VOLVO
	441 442 443			767 768 780	
	444 445 446			793 794 795	
	447			796 806 929	
3189 600 058	409 410 412	MERCEDES-BENZ	3400 066 031 #	60 61 62	IVECO
	413 414 415			79	
	417 418 420		3400 068 031	66 69 71	IVECO
	421 422 423			73 74 76	
	426 427 428			78 79 80	
	429 432 433		3400 074 031	71 73 74	IVECO
	434 435 436			76 77 78	
	437 438 439			79 80 83	
	441 442 443			86	
	444 445 446		3400 077 071	80 84 86	IVECO
	447 502 503			87	
	506 507 508		3400 084 031	80 83 84	IVECO
3189 600 059	819	EOBUS		87 88 89	

Arithmetische Liste / Part number list

Artikelnummer Article No.	Seite Page	Hersteller Manufacturer	Artikelnummer Article No.	Seite Page	Hersteller Manufacturer
3400 093 031 ⊕	683 696 698 701 702 706	RENAULT TRUCKS	3400 119 001 ⊖	137 138 141 143 145 828 829	IVECO
3400 106 031 ⊕	753 779 780 804 806 930	VOLVO	3400 121 001	26 31 32 33	DAF
3400 107 031	83 86 87 88 100 105 108 109 116 119	IVECO	3400 121 101	811 25 31 32	BOVA DAF
3400 116 001	776	VOLVO	3400 121 201 ⊖	472 473 474 476 477 478 480 482 483 485 486 488 490 491 493 495 497 498 499 500 501 503 504 505 506 509	MERCEDES-BENZ
3400 116 101 #	761 776 777	VOLVO	3400 121 301 ⊖	473 474 476 478 480 482 483 484 485 486 488 489 490 491 492 493 494 495 496 497 498 499 500 501 503 504 505 506 509	MERCEDES-BENZ
3400 116 201 #	761 776 932	VOLVO	3400 121 401	551 554 555 558 563 571 578 887	MERCEDES-BENZ
3400 116 301	756	VOLVO	3400 121 501 ⊕	409 410 412 413 414 415 417 418 420 421 422 423 426 427 428 429 432 433 434 435 436 437 438 439 441 442 443 444 445 446 447 503 506 507	MERCEDES-BENZ
3400 116 401 #⊖	727	SCANIA	(45x50-18N)		
3400 116 501 #	754 805	VOLVO	3400 121 601	595 599 600 601 609 613 614 626 630 631 632 633 634 639 640 641 642 643 644 648 649 650 651 652 658 660 661 663 664 670	MERCEDES-BENZ
3400 116 601	680 681 682 683 687 700 701 704 719 720 914	RENAULT TRUCKS	3400 121 701	164 168 232 236 240 242 243 244 245 246 247 248 249 250 251 257 259 281 294 296 297 298 299 734 735 736 738	MAN
3400 116 701	681 703 704 914	RENAULT TRUCKS	3400 121 801 ⊖	168 232 233 234 235 236	MAN
3400 116 801	680 681 686 687 703 704 724	RENAULT TRUCKS			
3400 116 901	827 681 914 915	IRISBUS RENAULT TRUCKS			
3400 117 001	682 683 695 696 698 701 702 720	RENAULT TRUCKS			
3400 117 101	681 696 701 702	RENAULT TRUCKS			
3400 117 201	681 682 683 702 703 704 705 706	RENAULT TRUCKS			
3400 117 202	681 682 683 702 703 704 705 706 914 915	RENAULT TRUCKS			
3400 117 301 #	689 707 710 724	RENAULT TRUCKS			
3400 117 532	691 692 693 694 696 697 698 713 714 715 716	RENAULT TRUCKS			
3400 117 631 ▲	698	RENAULT TRUCKS			
3400 117 701	41 43 44 45 46 47 48 60	IVECO			
3400 117 801	1 2 3 80 81 82 84 85 86 88 89 90 91 92 103 104 105 107 108 109 110 111 112 113 114 115 118 119 120 121 122 123 124 125 126 127 128 129 130 133 140 142 144	ASTRA IVECO			
3400 118 901 ⊖	96 143	IVECO			

Artikelnummer Article No.	Seite Page	Hersteller Manufacturer	Artikelnummer Article No.	Seite Page	Hersteller Manufacturer		
3400 121 901	195 197 198	MAN	3400 122 801 ⊕	409 410 414	MERCEDES-BENZ		
	199 200 201			415 418 422			
	202 203 204			423 428 429			
	205 206 207			434 435 436			
	208 209 210			438 439 444			
	211 212 213			445 502 503			
	214 215 216			506 507			
	222 225 226			3400 122 901		598 599 600	MERCEDES-BENZ
	677					601 609 613	
	3400 122 001 ⊖			729 917		SCANIA	614 626 630
3400 122 101	23 24 25	DAF	631 632 633				
	26 27 32		634 639 640				
	33 34		641 642 643				
3400 122 201	169 170 175	MAN	644 650 651				
	176 177 178		652 660 661				
	179 180 183		662 663 664				
	184 185 186		668 669 670				
	187 188 189		3400 123 001	567 568 569	MERCEDES-BENZ		
	190 191 192			574 575 576			
	193 194 195		591 592 597				
	196 197 198		603 604 610				
	199 201 202		621 622 626				
	203 205 209		627 629 868				
	210 212 213		869 876				
	214 215 216		3400 123 101 #	681 696 701	RENAULT TRUCKS		
	217 218 219			702			
	220 221 222		3400 123 201 ▲	682 683 687	RENAULT TRUCKS		
	223 224 225			696 700 701			
	226 227 228		702 703 704				
	229 230 257		719 720				
	358 363 374		3400 123 301 ▲	696 701 702	RENAULT TRUCKS		
	671 672 673			826 827			
	674 675 676		3400 123 401	691 692 693	IRISBUS		
677 678	694 696 697						
731	713 714 716						
	914 915						
	739 740	SINOTRUK (CNHTC)					
		STEYR					
3400 122 301	168 169 177	MAN	3400 123 501 ⊕	728 918	SCANIA		
	179 180 181		3400 123 601 ⊕	728 918	SCANIA		
	182 183 185		3400 123 701 ⊕	728 917	SCANIA		
	186 187 188		3400 123 801 ⊕	728	SCANIA		
	189 190 191		3400 123 901 ⊕	727 728	SCANIA		
	194 196 198		3400 124 001	569 594 598	MERCEDES-BENZ		
	200 217 222			611 624 626			
	223 224 226			629 637 638			
	228 258 367			647 656			
	835 836 837			3400 124 101		568 569 577	MERCEDES-BENZ
	838 851 852		586 592 593				
	853		594 604 605				
	672 673 674		608 622 623				
	675 676 677		624 625 627				
	737 738 739		629 631 637				
	642 643 647						
	656 657 659						
	660 662 663						
	666 667 668						
	669 870 873						
	876 889						
3400 122 401	554 558 562	MERCEDES-BENZ	3400 124 201 #	230 231 834	MAN		
	565 571 573		3400 124 301	554 555 558	MERCEDES-BENZ		
	578 580 596			562 571 887			
	864 875 887		3400 124 501	399 400 401	MERCEDES-BENZ		
	891	NEOPLAN	3400 124 601	13 14 15	DAF		
3400 122 501	593 605 623	MERCEDES-BENZ		16 31			
	637						
3400 122 601	594 595 598	MERCEDES-BENZ					
	599 600 601						

Arithmetische Liste / Part number list

Artikelnummer Article No.	Seite Page	Hersteller Manufacturer	Artikelnummer Article No.	Seite Page	Hersteller Manufacturer
3400 124 701	811	BOVA	3400 127 801	822	EVOBUS
	8 9 10	DAF	3400 128 001	870 873 874	MERCEDES-BENZ
	11 22			875 877	
3400 124 801 (1 3/4"-10N)	7 8 9	DAF	3400 700 301 #⊕	204	MAN
3400 124 901 (1 1/2"-10N)	6 7 8	DAF		778 779 780	VOLVO
3400 125 001	563 564 571	MERCEDES-BENZ		800 801	
	572 573 574		3400 700 302 ☹	245 247 248	MAN
	581 582 583		3400 700 303 ☹	232 233 238	MAN
	590 591 596			239 240 242	
	621 889			245 246 248	
3400 125 201	399 400 401	MERCEDES-BENZ		292 293 294	
3400 125 501	239 241 252	MAN		295	
	253 254 255		3400 700 305	811	BOVA
	256 257 351			14 25	DAF
	847			924	VAN HOOL
	733 734	STEYR	3400 700 307	18	DAF
3400 125 601 ⊕	929 930 931	VOLVO	3400 700 308	18 19 21	DAF
	933		3400 700 310	192 195 196	MAN
3400 125 701	12 15 31	DAF	(1 3/4"-10N)	198 199 204	
	32			206 207 208	
	917	SCANIA		210 216 217	
3400 125 801	231 834 835	MAN		218 219 223	
3400 125 901 ☹	726 727 728	SCANIA		227 374 375	
	916 917 918		3400 700 311	690 691 692	RENAULT TRUCKS
3400 127 101 ⊕	766 767 768	VOLVO		693 694 695	
	769 792 793			696 700 714	
	794 795 796			715 716 718	
	933			719	
3400 127 201 ⊕	792 933 935	VOLVO	3400 700 312	98	IVECO
3400 127 301 #	399 400 401	MERCEDES-BENZ	3400 700 313	87 90 91	IVECO
3400 127 401	260 261 262	MAN		92	
	282 289 290		3400 700 316	21 23 24	DAF
	377	MAZ-MAN	3400 700 318 #	20	DAF
	744 745	STEYR	3400 700 319	21 22 23	DAF
3400 127 601 (2"-10N)	193 195 196	MAN	3400 700 320	18 19	DAF
	197 198 199		3400 700 322 ☹	232 233 234	MAN
	200 201 202			235 236 237	
	203 204 205			240 241 242	
	206 207 208			245 246 251	
	209 210 211			252 253 254	
	212 213 214			835	
	215 216 217			732 733 734	STEYR
	218 219 220			735 736	
	221 222 223		3400 700 323 ☹	729	SCANIA
	224 225 226		3400 700 324 ☹	729	SCANIA
	227 228 229		3400 700 325 ⊕	765 766 767	VOLVO
	230 258 374			768 780	
	375		3400 700 326 ⊕	766 767 768	VOLVO
	674 675 676	ÖSTERREICHISCHE AUTOMOBILFABRIK (ÖAF)		793 794 795	
	677 678			796 805 807	
3400 127 701 ☹	401 402 403	MERCEDES-BENZ	3400 700 327	148	KAMAZ
	404 472 473			176 178 179	MAN
	474 476 477			180 183 184	
	478 480 482			185 186 188	
	483 485 486			189 190 191	
	488 490 491			192 202 203	
	495 497 498			214 226 261	
	501 505 509			262 263 264	
	510 518 519			265 266 267	
	543 550 554			268 269 270	
	861 886			271 272 273	

Artikelnummer Article No.	Seite Page	Hersteller Manufacturer	Artikelnummer Article No.	Seite Page	Hersteller Manufacturer
3400 700 328	825 827 913 915 916	IRISBUS RENAULT TRUCKS	3400 700 357 ⊕	769 806	VOLVO
3400 700 329	703 704 706 914	RENAULT TRUCKS	3400 700 358 ⊖	694 783 784 786 797	RENAULT TRUCKS VOLVO
3400 700 330	826 695 914 915	IRISBUS RENAULT TRUCKS	3400 700 360 ⊕	761 762 763 767 768 769 772 783 784 785 786 787 788 789 790 791 793 794 795 796 797 798 799	VOLVO
3400 700 331	696 697	RENAULT TRUCKS	3400 700 361	24 28 29 35	DAF
3400 700 332	700 714 715 716	RENAULT TRUCKS	3400 700 362	836 840 843 848 850 851 852	MAN
3400 700 333	690 691 692 693 694	RENAULT TRUCKS	3400 700 364	281 294 295 296 297 298 299	MAN
3400 700 334	690 692 693 694 695 700 715 716	RENAULT TRUCKS	3400 700 365	2 99 100 101 102 103 104 105 106 108 109 116 117 119 120 122 127	ASTRA IVECO
3400 700 335 ▲	690	RENAULT TRUCKS	3400 700 366	4 99 103 104 105 108 110 111 113 115 116 118 119 120 121 122 123 124 126 127 128 129 130	ASTRA IVECO
3400 700 336	680 687 688 719 720	RENAULT TRUCKS	3400 700 368	23 24 28 29 35	DAF
3400 700 337	709 713	RENAULT TRUCKS	3400 700 370	730	SCANIA
3400 700 338	707 708	RENAULT TRUCKS	3400 700 372	730	SCANIA
3400 700 339	686 687 689 702 707 708 709 710 711 724 913	RENAULT TRUCKS	3400 700 373	730	SCANIA
3400 700 340	691 692 693 694 696 697	RENAULT TRUCKS	3400 700 374	730	SCANIA
3400 700 341 #	827 702 916	IRISBUS RENAULT TRUCKS	3400 700 375	18	DAF
3400 700 342 ⊕	767 768 783 785 792 793 794 795 796 806 931 934 935 936	VOLVO	3400 700 376	18 19 21 22	DAF
3400 700 343 ⊕	767 768 783 785 792 793 794 795 796 806	VOLVO	3400 700 377	99 100 117	IVECO
3400 700 344	146 147 148	KAMAZ	3400 700 378	2 101 102 104 105 106 108 109 117 119 120 125	ASTRA IVECO
3400 700 345	146 147 148 149 830	KAMAZ	3400 700 379	894 895 896 897 900 901 903 904 905 906	NEOPLAN
3400 700 348 ⊕	761 762 763 767 768 783 784 785 786 787 788 789 790 791 793 794 795 796 797 798 799	VOLVO	3400 700 380	262 263 264 265 266 267 268 269 270 271 272 283 284 289 290 299 300 301 302 303 312 313 315 316	MAN
3400 700 349	822	EVOBUS			
3400 700 350 ⊕	697 699 767 768 793 794 795 806 931 934 935 936	RENAULT TRUCKS VOLVO			
3400 700 351 ⊕	698 699 769 796 806	RENAULT TRUCKS VOLVO			
3400 700 352	729 730	SCANIA			
3400 700 353 #	17 18	DAF			
3400 700 354	917	SCANIA			
3400 700 355 ⊕	409 410 412 413 414 415 417 418 420 421 422 423 426 427 428	MERCEDES-BENZ			

Arithmetische Liste / Part number list

Artikelnummer Article No.	Seite Page	Hersteller Manufacturer	Artikelnummer Article No.	Seite Page	Hersteller Manufacturer
3400 700 381	262 263 264	MAN	3400 700 403	260 261 262	MAN
	265 266 267			263 282 289	
	268 269 270			290 299 300	
	271 272 283			301 302 303	
	284 289 299			306 307 315	
	300 301 302			316 317 318	
	303 306 307			319 320 321	
	312 313 315			322 325 326	
	316 317 318			327 329 331	
	319 320 321			332 333 336	
	322 325 326			338 339 341	
	327 329 331			343 344 347	
	332 333 336			348 350 835	
	338 339 341			377	
	343 344 347			891	
	348 350 835	744 745		MAZ-MAN NEOPLAN STEYR	
891 892 909	3400 700 404	MAN	273 274 275		
910 911 912			276 277 278		
3400 700 382	699	RENAULT TRUCKS	279 280 285		
3400 700 383	40	ISUZU	286 287 288		
(1 1/2" -10N)			292 309 311		
3400 700 384	670	MITSUBISHI	323 324 836		
(14 x 29mm)			838		
3400 700 385	40	ISUZU	909		NEOPLAN
(1 1/2" -10N)			744		STEYR
3400 700 386	670	MITSUBISHI	3400 700 405	20	DAF
(14 x 35mm)			3400 700 406 ⊕	769 770 771	VOLVO
3400 700 387	40	ISUZU	773 793 794		
(1 1/2" -14N)			795 796		
3400 700 388	670	MITSUBISHI	3400 700 407 ⊕	770 771 773	VOLVO
(14 x 29mm)			3400 700 408	691 692 693	RENAULT TRUCKS
3400 700 389	40	ISUZU	694 696 697		
(14 x 36mm)			713 714 715		
3400 700 390	40	ISUZU	716		
(1 1/2" -14N)			3400 700 409	826	IRISBUS
3400 700 391	40	ISUZU	690 691 692		RENAULT TRUCKS
(1 1/2" -14N)			693 694 713		
3400 700 392	40	ISUZU	714 914 915		
(21 x 29)			3400 700 410	691 714 716	RENAULT TRUCKS
3400 700 394	292 293 294	MAN	3400 700 411	575 577 578	MERCEDES-BENZ
	295		585 597 610		
3400 700 395	103 104 106	IVECO	611 621 626		
	107 109 110		627 629		
	112 113 114		3400 700 412	255 256 257	MAN
3400 700 396	281 294 295	MAN	3400 700 414 ⊕	493 494 496	MERCEDES-BENZ
	296 299		500 503 504		
3400 700 397	473 474 476	MERCEDES-BENZ	3400 700 415 ⊕	412 417 420	MERCEDES-BENZ
	478 480 482		426 432 436		
	483 485 486		441 445		
	488 490 491		3400 700 416 ⊕	409 410 414	MERCEDES-BENZ
	495 497 498		415 418 422		
	500 501 505		423 428 429		
	509		434 435 436		
3400 700 398	18	DAF	438 439 444		
3400 700 399	692 693 694	RENAULT TRUCKS	445		
	695 699 717		3400 700 417	573 590 596	MERCEDES-BENZ
	718 719		3400 700 418	96 97	IVECO
3400 700 401 ⊕	715	RENAULT TRUCKS	3400 700 420 ⊖	147	KAMAZ
	769	VOLVO	3400 700 422 ⊕	767 768 769	VOLVO
3400 700 402	273 274 275	MAN	772 793 794		
	276 277 278		795 796 806		
	279 280 285		3400 700 423 ⊕	767 768 769	VOLVO
	286 287 288		793 794 795		
	292 306 307				

Arithmetische Liste / Part number list

Artikelnummer Article No.	Seite Page	Hersteller Manufacturer	Artikelnummer Article No.	Seite Page	Hersteller Manufacturer				
3400 700 426 ⊕	755 765 766	VOLVO	3400 700 449 ■ (1 1/2"-10N)	62 65 66	IVECO				
	767 768 780			67 69 70					
3400 700 427 ⊕	766 767 768	VOLVO		72 73 74					
	793 794 795			75 76 77					
	796 805 807			79					
				709 710 711					
3400 700 428 #	20	DAF		709 710 711		RENAULT TRUCKS			
3400 700 429	41 43 44	IVECO		3400 700 450		260 261 262	MAN		
	45 46 47					282 290			
3400 700 430 ■ (1 1/2"-10N)	65 66 68	IVECO				377		MAZ-MAN NEOPLAN STEYR	
	69 70 71		891						
	73 74 75		744 745						
	78								
3400 700 431 ■ (1 1/2"-10N)	61 62 63	IVECO	3400 700 451		813 823	EVOBUS MERCEDES-BENZ			
	64 65 66				883				
	67 70 71								
3400 700 432 ■ (23x30,55x10N)	43 44 45	IVECO			3400 700 452 ■ (1 1/2"-10N)			63 64 68	IVECO
	47 48 49			72 73 75					
	50 53 55			96 97 131					
	58			132 133 141					
3400 700 433 ■ (23,1x29,2x10N)	48 49 50	IVECO		3400 700 454 ■ (41,1x50,8-10N)			142	IVECO	
	51 52 54						80 81 84		
	56 57						87 88 90		
			91 133 142						
3400 700 435	1 2 3	ASTRA	3400 700 455 ■ (41,1x50,8-10N)			80 81 84	IVECO		
	80 81 82	IVECO				87 88 90			
	84 85 86				91 133 142				
	88 89 90				144				
	91 92 103				3400 700 456 ■ (41,1x50,8-10N)	131 132 133			IVECO
	104 105 107					134 140 141			
	108 109 110			142 143					
	111 112 113			3400 700 457 ■ (41,1x50,8-10N)		131 132 133		IVECO	
	114 115 118					134 140 141			
	119 120 121					142 143			
	122 123 124		3400 700 459 HD			273 274 275	MAN		
	125 126 127					276 277 278			
	128 129 130					279 280 285			
	133 140 142					286 287 288			
	144				291 292 304				
					305 308 309				
		310 311 314							
		323 324 328							
		330 334 335							
		337 340 342							
3400 700 436	60 62 68	IVECO	345 346 349						
3400 700 438	700 718 719	RENAULT TRUCKS	836 838						
3400 700 439	711	RENAULT TRUCKS	891 907 908	NEOPLAN					
3400 700 444 ■ (23x29,2x10N)	42 43 45	IVECO	909	STEYR					
	47 48		744						
	705		RENAULT TRUCKS						
3400 700 445	273 274 275	MAN	3400 700 460 HD	273 274 275	MAN				
	276 277 278			276 277 278					
	279 280 285			279 280 285					
	286 287 288			286 287 288					
	292 836 838			291 292 304					
	909			305 306 307					
	744			308 309 310					
				311 314 317					
	322 323 324								
3400 700 446 ⊕	409 410 414	MERCEDES-BENZ		327 328 330		STEYR			
	415 418 422		332 333 334						
	423 428 429		335 337 339						
	434 435 436		340 341 342						
	438 439 444		344 345 346						
	445 499 500		348 349 350						
	502 503 504		744						
	506 507								
3400 700 447 ■ (23x29-10N)	49 50	IVECO	3400 700 461	4	ASTRA				
3400 700 448 ■ (23x29-10N)	49 50 52	IVECO	111 112 113	IVECO					
	53 55 58		118 119 120						
			121 122 123						

Arithmetische Liste / Part number list

Artikelnummer Article No.	Seite Page	Hersteller Manufacturer	Artikelnummer Article No.	Seite Page	Hersteller Manufacturer
3400 700 462 ■ (41,25x52,1-10N)	104 106 107	IVECO	3400 700 494	342	MAN
	108 109 110		3400 700 495	718	RENAULT TRUCKS
	112 113 114		3400 700 497	825 826 827	IRISBUS
	115		3400 700 498 ☉	821 822 823	EVOBUS
3400 700 463 ⊕	761 762 763	VOLVO	3400 700 504 ■ (41,1x50,8-10N)	21 22 23 24 26 27 34	DAF
	783 784 785		3400 700 505 ■ (41,1x50,8-10N)	836 853 891 910 912	MAN NEOPLAN
	786 787 788		3400 700 506 ■ (41,1x50,8-10N)	850 851 912	MAN NEOPLAN
	789 790 791		3400 700 507 ■ (41,1x50,8-10N)	837 851 852 853 909 911 912	MAN NEOPLAN
	797 798 799		3400 700 509 ■ (41,1x50,8-10N)	822 875 881 883 884 885 886 891 912 918 919 920 921	EVOBUS MERCEDES-BENZ NEOPLAN SETRA
3400 700 464	19 20	DAF	3400 700 510 ■ (38,2x44,5-10N)	838 840 891	MAN NEOPLAN
3400 700 465	19 20	DAF	3400 700 511 ☉■ (41,1x50,8-10N)	836 853 891 909 910 911 912	MAN NEOPLAN
3400 700 466	681 685 713	RENAULT TRUCKS	3400 700 512 ☉■ (41,1x50,8-10N)	837 852 920 921	MAN SETRA
	717 759 760 781	VOLVO	3400 700 514 ☉■ (23x29-10N)	48 49 50 51 52 53 54 55 56 57 58 59	IVECO
3400 700 467	24 29 30	DAF	3400 700 515 ☉■ (23x29-10N)	49 50 52 53 55 58 59	IVECO
	36 926	VDL	3400 700 519 ■ (38,2x44,5-10N)	18 19 21 23 24	DAF
3400 700 468 ⊕	413 421 427 437 442 446	MERCEDES-BENZ	3400 700 520 ■ (38,2x44,5-10N)	23	DAF
3400 700 469	108	IVECO	3400 700 521 ■ (41,1x50,8-10N)	24 28 29 35	DAF
3400 700 470	695 700	RENAULT TRUCKS	3400 700 522 ■ (41,1x50,8-10N)	24 28 29 30 35 36	DAF
3400 700 471 ⊕	782 783 792	VOLVO	3400 700 523 ■ (38,2x44,5-10N)	18 19 21 22	DAF
3400 700 472 ⊕	782 783	VOLVO	3400 700 524 ■ (38,2x44,5-10N)	18 21 22	DAF
3400 700 473	18 19 20	DAF	3400 700 525 ☉■ (41,1x50,8-10N)	921	SETRA
	21 22 29		3400 700 526 ■	39	FREIGHTLINER
3400 700 474 ■ (31,01x38,53-10N)	62 68 75	IVECO	3400 700 527 ■ (30,7x38,4-10N)	18 19 21	DAF
	3400 700 475 ■ (31,02x38,55-10N)		62 68 75	3400 700 529 ☉■ (45x50-18N)	412 417 420 426 433 442 446 453 470 471
3400 700 476	18 19 21 22	DAF	3400 700 530 ☉■ (45x50-18N)	410 415 418 423 430 448 449 457 458 510	MERCEDES-BENZ
3400 700 477 ☉	544	MERCEDES-BENZ	3400 700 531 ☉■ (45x50-18N)	411 415 416 418 419 424 430 431 437 439 440 450	MERCEDES-BENZ
3400 700 478 ⊕	761 783 784	VOLVO			
	785 786 787				
	788 789 790				
	791 797 798				
3400 700 480 ■ (31x38-10N)	711 712	RENAULT TRUCKS			
	3400 700 483 (23,05x30,57x10N)		49 50 51 53 55 56 58 59		
3400 700 484 ☉	401 402 403	MERCEDES-BENZ			
	404 472 473				
	474 476 477				
	478 480 482				
	483 485 486				
	488 490 491				
	495 497 498				
	501 505 509				
	519 550 554				
	563 571 861 886				
3400 700 485 #	690 691 692	RENAULT TRUCKS			
	693 694 695 731		SISU		
3400 700 486	70 71 74	IVECO			
	75 77				
3400 700 487	62 68 75	IVECO			
3400 700 489	34	DAF			
3400 700 490	759	VOLVO			
3400 700 491	730	SCANIA			
3400 700 493	825	IRISBUS			
	913		RENAULT TRUCKS		

Artikelnummer Article No.	Seite Page	Hersteller Manufacturer	Artikelnummer Article No.	Seite Page	Hersteller Manufacturer
3400 700 532 ■ (45x50-18N)	410 415 418	MERCEDES-BENZ	3400 700 604	29	DAF
	423 430 448		3400 700 605	29	DAF
	449 453 457		3400 700 606	60	IVECO
	458 510		3400 700 607	60	IVECO
3400 700 533 ■ (45x50-18N)	411 415 416	MERCEDES-BENZ	3400 700 608	60	IVECO
	418 419 424		3400 700 609	413 471	MERCEDES-BENZ
	430 431 437		3400 700 611	730 731	SCANIA
	439 440 450		3400 700 613	299 342	MAN
	451 453 459		3400 700 614	299 342	MAN
	460 461 462		3400 700 615 ⊕	508	MERCEDES-BENZ
	463 464 471 510		3400 700 617 ⊕	493 494 496 499 503 504 508	MERCEDES-BENZ
3400 700 534 ■ (45x50-18N)	412 417 420	MERCEDES-BENZ	3400 700 618 ⊖	761 785 787 788 789 790 791 798	VOLVO
	426 433 442		3400 700 619	731	SCANIA
	446 453 470 471		3400 700 621	518 519 520	MERCEDES-BENZ
3400 700 535 ■	413 471	MERCEDES-BENZ SISU	3400 700 622	717	RENAULT TRUCKS
3400 700 537 ⊖■ (45x50-18N)	884 885	MERCEDES-BENZ	3400 700 624	731	SCANIA
3400 700 540 ■ (45x50-18N)	922	SETRA	3400 700 625	711 712 713 714 715	RENAULT TRUCKS
3400 700 541 ⊖■ (45x50-18N)	411 416 419	MERCEDES-BENZ	3400 700 626	711 712 713	RENAULT TRUCKS
	425 431 440		3400 700 627	684	RENAULT TRUCKS
	452 454 465			781	VOLVO
	466 467 468 469		3400 700 628	681 685 760 781	RENAULT TRUCKS VOLVO
3400 700 542 ⊖■ (45x50-18N)	411 415 416	MERCEDES-BENZ	3400 700 629 ⊕	761 762 763 764 765 785 787 789 790 791 798	VOLVO
	418 419 424		3400 700 630	706 707	RENAULT TRUCKS
	430 431 437		3400 700 632	705	RENAULT TRUCKS
	439 440 450		3400 700 633	825 826	IRISBUS
	451 453 459		3400 700 636 ■ (36x44,6-10N)	71 75	IVECO
	460 461 462 463 464 471		3400 700 637 ■ (23x29-10N)	55 59	IVECO
3400 700 543 ⊖■ (45x50-18N)	411 416 419	MERCEDES-BENZ	3400 700 638	472 475 479 481 484 487 492	MERCEDES-BENZ
	425 431 440		3400 700 639	408 413 417 421 427 453 455 456 475 479 481 484 489 492	MERCEDES-BENZ
	452 454 465		3400 700 640	773	VOLVO
	466 467 468 469		3400 700 641	176 178 179 180 183 184 185 186 188 189 190 191 192 202 203 214 226 261 262 263 264 265 266 267 268 269 270 271 272 273 274 275 276 277 278 279 282 283 284 285 286 287 288 289 290	MAN
3400 700 544 ■ (45x50-18N)	412 417 420	MERCEDES-BENZ			
	426 433 442				
	446 453 470 471				
3400 700 545	411 416 419	MERCEDES-BENZ			
	425 431 440				
	452 454 465				
	466 467 468 469				
3400 700 546 ⊖■ (36x40-18N)	408 413 417	MERCEDES-BENZ			
	421 427 453				
	455 456 475				
	479 481 484 489 492				
3400 700 548 ■ (45x50-18N)	922	SETRA			
3400 700 600 ⊕	681 682 685	RENAULT TRUCKS			
	689 723				
	761 762 763		VOLVO		
	764 765 782				
	787 789 791				
	797 798 799				
	800				
3400 700 603	19 20	DAF			

Arithmetische Liste / Part number list

Artikelnummer Article No.	Seite Page	Hersteller Manufacturer	Artikelnummer Article No.	Seite Page	Hersteller Manufacturer
3400 700 643	919 920	SETRA	3400 710 011	292 293 294 295	MAN
3400 700 646	52 53 55 56 58 59	IVECO	3400 710 012	473 474 497 500 501 505 509	MERCEDES-BENZ
3400 700 653	51 54 55 56 57 58 59	IVECO	3400 710 013	473 474 497 500 501 505 509	MERCEDES-BENZ
3400 710 001	168 232 233 234 235 236 237 240 241 242 245 246 251 253 299 835 732 733 734 735 736	MAN STEYR	3400 710 014	473 474 476 478 480 482 483 485 486 488 490 491 495 497 498 500 501 505 509	MERCEDES-BENZ
3400 710 002	232 233 238 239 240 242 246	MAN	3400 710 015	473 474 476 478 480 482 483 485 486 488 490 491 495 497 498 500 501 505 509	MERCEDES-BENZ
3400 710 003	247	MAN	3400 710 016	472 473 474 476 477 478 480 482 483 485 486 488 490 491 495 497 498 501 505 509	MERCEDES-BENZ
3400 710 004	729	SCANIA	3400 710 017	473 474 476 478 480 482 483 485 486 488 490 491 495 497 498 500 501 505 509	MERCEDES-BENZ
3400 710 005	472 473 474 476 477 478 480 482 483 485 486 488 490 491 495 497 498 501 505 509	MERCEDES-BENZ	3400 710 060	692 693 716 718 719 759 760 781 782 783 784 785 931 934 935 936	RENAULT TRUCKS VOLVO
3400 710 006	472 473 474 476 477 478 480 482 483 485 486 488 490 491 493 495 497 498 499 500 501 503 504 505 506 509	MERCEDES-BENZ	3400 710 061 #	695 700 717 718 762 763 784 786 788 790 799 935 936	RENAULT TRUCKS VOLVO
3400 710 007	473 474 476 478 480 482 483 484 485 486 488 489 490 491 492 493 494 495 496 497 498 499 500 501 503 504 505 506 509	MERCEDES-BENZ	3400 710 063 ■	772	VOLVO
3400 710 008	472 473 474 476 477 478 480 482 483 485 486 488 490 491 495 497 498 501 505 509 510 518 519 543	MERCEDES-BENZ	3400 710 064	681 682 685 689 723 761 762 763 764 765 782 787 789 791 798 799 800 930 931	RENAULT TRUCKS VOLVO
3400 710 009	472 473 474 476 477 478 480 482 483 485 486 488 490 491 493 495 497 498 499 500 501 503 504 505 506 509	MERCEDES-BENZ	3400 710 065	772 773	VOLVO
3400 710 010	473 474 476	MERCEDES-BENZ	3400 710 066	695 700 717 718 762 763 784 786 788 790 799 935 936	RENAULT TRUCKS VOLVO
			3400 710 067	716 717 718 759 760	RENAULT TRUCKS VOLVO

Artikelnummer Article No.	Seite Page	Hersteller Manufacturer	Artikelnummer Article No.	Seite Page	Hersteller Manufacturer
3400 710 068	772 773	VOLVO	3482 000 209	147	KAMAZ
3400 710 070 ■	410 415 418	MERCEDES-BENZ		732	SISU
(45x50-18N)	423 430 448			926	VAN HOOL
	449 457 458		3482 000 246	273 274 275	MAN
	510			276 277 278	
3400 710 071 ■	411 415 416	MERCEDES-BENZ		279 280 285	
(45x50-18N)	418 419 424			286 287 288	
	430 431 437			291 292 304	
	439 440 450			305 306 307	
	451 459 460			308 309 310	
	461 462 463			311 314 317	
	464 471 510			322 323 324	
	885			327 328 330	
3400 710 072 ■	411 416 419	MERCEDES-BENZ		332 333 334	
(45x50-18N)	425 431 440			335 337 339	
	452 454 465			340 341 342	
	466 467 468			344 345 346	
	469			348 349 350	
3400 710 073 ■	412 417 420	MERCEDES-BENZ		836 838	NEOPLAN
(45x50-18N)	426 433 442			891 907 908	
	446 453 470			909	
	471			699	RENAULT TRUCKS
	922	SETRA		744	STEYR
3400 710 074 #■	411 415 416	MERCEDES-BENZ	3482 000 251	729 917	SCANIA
(45x50-18N)	418 419 424		3482 000 257	729 730 731	SCANIA
	430 431 437		3482 000 270 #	705 709	RENAULT TRUCKS
	439 440 450		3482 000 361	260 261 262	MAN
	451 453 459			263 264 265	
	460 461 462			266 267 268	
	463 464 471			269 270 271	
3400 710 075 ■	411 416 419	MERCEDES-BENZ		272 282 283	
(45x50-18N)	425 431 440			284 289 290	
	452 454 465			299 300 301	
	466 467 468			302 303 306	
	469			307 312 313	
3400 710 076 ■	412 417 420	MERCEDES-BENZ		315 316 317	
(45x50-18N)	426 433 442			318 319 320	
	446 453 470			321 322 325	
	471			326 327 329	
3459 000 009	753 755 778	VOLVO		331 332 333	
	779 780 804			336 338 339	
	805 806			341 343 344	
3459 004 108	727	SCANIA		347 348 350	
	754 805	VOLVO		835 837	
3459 010 101	755 805 807	VOLVO		377	MAZ-MAN
3459 012 131	756	VOLVO		891 892 908	NEOPLAN
3459 016 031	756 770 771	VOLVO		909 910 911	
3459 017 031	755 765 766	VOLVO		912	
	780 784 786			744 745	STEYR
	788 790 791		3482 000 419	17 18 20	DAF
	793 794 795			60 62 68	IVECO
	796 805 807			75	
3459 018 004	697 698	RENAULT TRUCKS		146	KAMAZ
	769 770 771	VOLVO		830	KAVZ
	773 784 786			810	YaMZ
	788 790 791		3482 000 461	5	AVIA
	793 794 795			232 233 238	MAN
	796			239 240 242	
3474 012 000	753 755 778	VOLVO		245 246 248	
	779 780 804			292 293 294	
	805 806 930			295	
3474 012 001	755 805 807	VOLVO	3482 000 462	401 402 403	MERCEDES-BENZ
3474 012 003	756	VOLVO		404 472 473	

Arithmetische Liste / Part number list

Artikelnummer Article No.	Seite Page	Hersteller Manufacturer	Artikelnummer Article No.	Seite Page	Hersteller Manufacturer	
3482 000 463	147 148	KAMAZ MAZ MERCEDES-BENZ	3482 000 573	2	ASTRA IRISBUS IVECO	
	376			825 826		
	473 474 476			99 100 101		
	478 480 482			102 103 104		
	483 484 485			105 106 107		
	486 488 489			108 109 110		
	490 491 492			112 113 114		
	493 494 495			116 117 119		
	496 497 498			120 122 125		
	499 500 501			127 828		
	503 504 505	3482 000 589		730 731	SCANIA	
	506 509 518	3482 000 628		99 100 117	IVECO	
	519 520 544	3482 000 664		292 293 294	MAN	
	881 884			295		
	898	NEOPLAN		3482 000 679	281 294 295	MAN
	923	TAM			296 299	
923	TEMSA		544	MERCEDES-BENZ		
3482 000 464	830	KING LONG MAN MERCEDES-BENZ	3482 000 691	699	RENAULT TRUCKS	
	245 247 248		3482 000 777	40	HINO	
	472 473 474		3482 000 819	342	MAN	
	476 477 478		3482 000 851	919 920	SETRA	
	480 482 483		3482 000 852	874 884	MERCEDES-BENZ	
	485 486 488			919 920 921	SETRA	
	490 491 493		3482 000 859	18 19 20	DAF	
	495 497 498		3482 000 953	9 17	DAF	
	499 500 501			555 561 563	MERCEDES-BENZ	
	503 504 505			564 566 571		
	506 509		572 573 574			
	937	YUTONG	578 579 581			
	3482 000 467	164 168 232	MAN	582 583 590		
		236 240 242		591 596 609		
		243 244 245		614 621 887		
		246 247 248		889		
249 250 251		3482 000 999		730 731	SCANIA	
257 259 281		3482 001 071		711 712 713	RENAULT TRUCKS	
294 296 297		3482 001 145		299 342	MAN	
298 299		3482 001 166		19 20	DAF	
734 735 736		3482 001 171		29	DAF	
738		3482 001 174		60	IVECO	
3482 000 474		5	BMC DAF	3482 001 180	299 342	MAN
		18 19 20		3482 001 184	29	DAF
		21 22 29	IVECO KAMAZ	3482 001 199	717	RENAULT TRUCKS
		60 70 71		3482 001 234 #	725 726 727	SCANIA
		74 75 77			728 916 917	
		146 147			918	
3482 000 484	23 24 28	DAF	3482 001 307	692 693 694	RENAULT TRUCKS	
	29 30 35			716 717 718		
	36	VDL		719	VOLVO	
	926			759 760 781		
3482 000 546	281 294 295	MAN		782 783 784		
	296 297 298			785 786 797		
	299			931 934 935		
3482 000 553	695 700 717	RENAULT TRUCKS		936		
	718	VOLVO	3482 001 308	695 700 717	RENAULT TRUCKS	
	762 763 784			718		
	786 788 790			761 762 763	VOLVO	
	799 935 936			784 785 786		
			787 788 789			
3482 000 572	4	ASTRA IVECO		790 791 798		
	99 103 104			799 935 936		
	105 108 110					
	111 112 113			3482 001 309	772 773	VOLVO
	115 116 118			3482 001 310	681 682 685	RENAULT TRUCKS
	119 120 121					

Artikelnummer Article No.	Seite Page	Hersteller Manufacturer	Artikelnummer Article No.	Seite Page	Hersteller Manufacturer
3482 001 346	731	SCANIA	3482 012 238	828	IVECO
3482 001 447	772 773	VOLVO	3482 012 240	555 558 563	MERCEDES-BENZ
3482 002 234	6 8 9	DAF		566 571 572	
	10			578 864 875	
	79 136	IVECO	3482 017 033	887	
	153 154 155	MAGIRUS-DEUTZ		353 355 356	MAN
	156 158 160			358	
	351 352 353	MAN	3482 017 034	811	BOVA
	354 355 356			8 9 10	DAF
	358 359 362			11 22	
	531 535 536	MERCEDES-BENZ		252 253 254	MAN
	537 538 539			255 256 257	
	540 541		3482 017 035	8 9 10	DAF
	898	NEOPLAN		11	
	689 720	RENAULT TRUCKS		252 253 254	MAN
3482 002 239 #	535 536 537	MERCEDES-BENZ		255 256 257	
	541 542			671	ÖSTERREICHISCHE AUTOMOBILFABRIK (ÖAF)
3482 006 036 #	11	DAF	3482 018 132 #	11 12 14	DAF
	841 842 844	MAN		15 16 25	
	845			31 32	
	890 892 893	NEOPLAN		895 896	NEOPLAN
	894 906 907			917	SCANIA
3482 008 032	511 512 513	MERCEDES-BENZ		924	VAN HOOL
	514 515 524		3482 021 031	731 732	SISU
	525 526 527			752 761 776	VOLVO
	528 529 530			777 802 931	
	531			932 934	
3482 008 033	79 93 135	IVECO	3482 026 332	754 805	VOLVO
	828 829		3482 032 331	230 231 834	MAN
	154 831	MAGIRUS-DEUTZ	3482 033 401	727	SCANIA
	689 707 710	RENAULT TRUCKS	3482 037 141	680 684 686	RENAULT TRUCKS
	724			687 688 702	
3482 008 034 #	6 8	DAF		708 709 711	
3482 008 036 #	93 135	IVECO		721 723 914	
	155	MAGIRUS-DEUTZ	3482 038 031	79 92 93	IVECO
	745	TAM		97 135 136	
3482 008 038	378 529 549	MERCEDES-BENZ		155	MAGIRUS-DEUTZ
	550 551 553		3482 043 134	131 132 139	IVECO
	554 555 557		3482 046 031 #	378 549 550	MERCEDES-BENZ
	558 559 560		3482 051 132 #	568	MERCEDES-BENZ
	561 562 564		3482 054 131	399 400 401	MERCEDES-BENZ
	565 566 571			860	
	573 578 579		3482 055 132	824	IKARUS
	580 581 596			399 400 401	MERCEDES-BENZ
	864 875 886			860	
	887		3482 056 031	753 755 778	VOLVO
	891	NEOPLAN		779 780 804	
3482 008 110	353 355	MAN		805 806	
3482 008 141 #	251 252 253	MAN	3482 059 031	755 805 807	VOLVO
	254		3482 060 132	6 7 8	DAF
3482 008 244	782	VOLVO		9 17 20	
3482 012 211	817	EVOBUS		239 241 252	MAN
	831	MAGIRUS-DEUTZ		253 254 255	
	516 517 518	MERCEDES-BENZ		256 257 351	
	531 532 540			834 835 839	
	554 555 558			842 847 848	
	560 561 562			733 734	STEYR
	565 566 571		3482 060 233	155	MAGIRUS-DEUTZ
	573 580 581			231 353 355	MAN
	887			358	
	906	NEOPLAN		897 898	NEOPLAN
3482 012 237	530 531 532	MERCEDES-BENZ			
	533 534 538				

Arithmetische Liste / Part number list

Artikelnummer Article No.	Seite Page	Hersteller Manufacturer	Artikelnummer Article No.	Seite Page	Hersteller Manufacturer	
3482 062 035	837 838 839	MAN NEOPLAN	3482 081 233	819 821 822	EVOBUS	
	900 901 903			823		
	904 905			595 598 599		
3482 063 101 #	733 734 735	STEYR		600 601 609	MERCEDES-BENZ	
3482 067 102 #	735 736	STEYR		613 614 626		
3482 071 131	756	VOLVO		630 631 632		
3482 078 132	825 826 827	IRISBUS		633 634 639		
3482 078 133	192 193 195	MAN		640 641 642		
	196 197 198		643 644 650			
	199 200 201		651 652 660			
	202 203 204		661 662 663			
	205 206 207		664 668 669			
	208 209 210		670 874 875			
	211 212 213		876 883 885			
	214 215 216		886			
	217 218 219		918	SETRA		
	220 221 222			3482 083 032	1 2 3	ASTRA
	223 224 225				811	BOVA
	226 227 228				23 24 25	DAF
	229 230 258				26 27 32	
	374 375 848				33 34 812	
	674 675 676		ÖSTERREICHISCHE AUTOMOBILFABRIK (ÖAF)		819 821 822	EVOBUS
	677 678				823	
	3482 078 134		825 827	IRISBUS	80 81 82	IVECO
	71 73 74	IVECO	84 85 86			
	76 77 78		88 89 90			
	79 80 83		91 92 103			
	84 86 87		104 105 107			
	88 89 99		108 109 110			
	100 101 102		111 112 113			
	105 108 109		114 115 118			
	113 116 117		119 120 121			
	119 120 122		122 123 124			
	125		125 126 127			
	913 916	RENAULT TRUCKS	128 129 130			
3482 081 231	813 823	EVOBUS	133 140 142			
	569 594 595	MERCEDES-BENZ	144			
	598 599 600		147 148	KAMAZ		
	601 606 607		168 169 170	MAN		
	611 613 624		175 176 177			
	625 626 629		178 179 180			
	630 631 632		181 182 183			
	633 637 638		184 185 186			
	639 640 641		187 188 189			
	642 643 644		190 191 192			
	646 647 648		193 194 195			
	649 650 651		196 197 198			
	652 656 657		199 200 201			
	658 659 660		202 203 205			
	661 662 663		209 210 212			
	664 665 666		213 214 215			
	667 668 669		216 217 218			
	863 867 870		219 220 221			
	873 874 875		222 223 224			
	876 877 881		225 226 227			
	882 883 889		228 229 230			
			257 258 299			
3482 081 232	821 822	EVOBUS	358 363 367			
	567 568 569	MERCEDES-BENZ	374 835 836			
	574 575 576		837 838 839			
	577 578 585		840 843 845			
	586 591 592		846 848 849			
	593 594 597		850 851 852			

Artikelnummer Article No.	Seite Page	Hersteller Manufacturer	Artikelnummer Article No.	Seite Page	Hersteller Manufacturer			
3482 083 034	692 693 694	RENAULT TRUCKS	3482 094 031 #	62 65 66	IVECO			
	695 699 717			67 69 70				
	718 719			72 73 74				
3482 083 039	727 728 729	SCANIA	3482 097 141	75 76 77	RENAULT TRUCKS			
	917 918			79				
3482 083 040	96 97 131	IVECO	3482 101 032	709 710 711	RENAULT TRUCKS			
	132 133 134			680 681 682				
	139 140 141			683 686 687				
	142 143 145			688 700 701				
3482 083 044	164	MAGIRUS-DEUTZ	3482 102 031	703 704 719	RENAULT TRUCKS			
	826 827			720 724 914				
	680 681 682			916				
	683 702 703			778 779 780				
	704 705 706			800 801 929				
3482 083 113	724 914 915	IRISBUS RENAULT TRUCKS	3482 106 031	931 933	VOLVO			
	916			231 834 835				
	5			535 536 537		MERCEDES-BENZ		
	811			540 541 542				
	17			543		MERCEDES-BENZ		
	37			534 535 536				
	814 815 821			537 538 539				
	822			540 541		VOLVO		
	87 90 91			756 770 771				
	92 98 827			765 766 780		VOLVO		
737 738 739	784 786 788							
3482 083 118	829	IVECO KAMAZ LAZ MAZ NEOPLAN SINOTRUK (CNHTC)	3482 110 031	790 791	VOLVO			
	146 147 148			755 766 793				
	149 830			794 795 796				
	830			805 807				
	376 377			3482 111 032		728 729 917		
	894 899 900					918		
	901 902 903			3482 112 031		3482 114 031	148	KAMAZ MAN
	904 905						168 169 176	
	922			177 178 179		VOLVO		
	729 917			180 181 182				
	3482 083 150			824 825 826			IRISBUS	183 184 185
827		186 187 188						
3482 083 252	690 691 692	RENAULT TRUCKS	189 190 191					
	693 694 695		192 202 203					
	696 697 700		214 226 261					
	713 714 715		262 263 264					
	716 913 914		265 266 267					
	915		268 269 270					
	3482 085 033		99 134 137	IVECO	271 272 273			
			138 141 143		274 275 276			
144 145 146		277 278 279						
828 829		282 283 284						
924 925		285 286 287						
3482 085 034	842 844 845	MAN	288 289 290					
	846		291 300 301					
3482 086 132	834 839 840	MAN	302 303 304					
	843 850		305 306 307					
3482 092 031 #	60 61 62	IVECO	308 309 310					
	79		311 312 313					
	709 710		314 315 316					
3482 093 031	66 69 71	RENAULT TRUCKS	317 318 319					
	73 74 76		320 321 322					
	78 79 80		323 324 325					
	232 233 234		326 327 328					
3482 093 032	235 236 237	MAN	329 330 331					
	240 241 242		332 333 334					
	245 246 251		335 336 337					
			338 339 340					

Arithmetische Liste / Part number list

Artikelnummer Article No.	Seite Page	Hersteller Manufacturer	Artikelnummer Article No.	Seite Page	Hersteller Manufacturer	
3482 114 032	21 22 23	DAF	3482 124 516	1	ASTRA IVECO	
	25 26 31			80 94 96		
3482 115 031	709 713	RENAULT TRUCKS		144 146		
3482 118 031	811	BOVA		849	MAN	
	14 15 16	DAF		894 895 896	NEOPLAN	
	25			897 901 902		
	917	SCANIA		905		
	737 738 739	STEYR				
3482 119 031	742 743			3482 124 522	811	BOVA
	924	VAN HOOL		161 163	606 612 618	MAGIRUS-DEUTZ MERCEDES-BENZ
	811	BOVA	638 878 879	880 881		
	11 12 13	DAF	741 742 743	STEYR		
	14 15 16		3482 124 531	824	IKARUS	
25 26 31		94 95 97	98 143 145	IVECO		
32 33		159 160 832	833 834	MAGIRUS-DEUTZ		
895 896	NEOPLAN	3482 124 532	95 96 139	IVECO		
917	SCANIA	145	159 162 163	MAGIRUS-DEUTZ		
924 925 926	VAN HOOL	832 833 834	3482 124 533 #	98 139 140	IVECO	
3482 119 032	811	BOVA	143	160 161 162	MAGIRUS-DEUTZ	
	11 12 14	DAF	163 164			
	15 16 21		3482 124 534	811	BOVA	
	22 23 812		812 813	815 816 817	DRÖGMÖLLER	
753 803	VOLVO	818 819 820	821 823	EVOBUS		
3482 119 034	725 726 727	SCANIA	140 141 143	144	IVECO	
	728 916 917		160 161 162	160 161 162	MAGIRUS-DEUTZ	
	918		354 355 356	357 359 360	MAGIRUS-DEUTZ MAN	
3482 120 031	168 232 233	MAN	361 362 363	364 365 366		
	234 235 236		368 369 370	371 372 841		
	237 240 241		842 848 849	854		
	242 245 246		584 587 588	605 606 611	MERCEDES-BENZ	
	251 253 299		612 615 616	617 618 619		
	835		620 622 635	636 638 645		
	732 733 734	STEYR	647 649 652	653 654 656		
	735 736		657 659 666	667 867 870		
3482 123 234	755 765 766	VOLVO	879 889	890 892 893	NEOPLAN	
	769 780 792		894 895 896	898 899 900		
	793 794 795		901 902 903	904 905 907		
	796 929 931		912		ÖSTERREICHISCHE AUTOMOBILFABRIK (ÖAF)	
3482 123 235	933 934 935		923	TAM		
	936		924	VAN HOOL		
	753 761 778	VOLVO				
	779 780 804					
3482 123 243	806 929 931					
	933					
	936					
3482 123 243	681 696 701	RENAULT TRUCKS				
3482 123 441	702					
	682 683 687	RENAULT TRUCKS				
	695 696 698					
	700 701 702					
	703 704 719					
3482 123 631	720					
	690 691 692	RENAULT TRUCKS				
	693 694 695					
3482 123 839	731	SISU				
	18 19 21	DAF				
	23 24					
3482 124 041	827	IVECO				
	685 686 687	RENAULT TRUCKS				
	689 702 707					
	708 709 710					
	711 724 913					
915						
3482 124 514 ▲	725 726 916	SCANIA				

Artikelnummer Article No.	Seite Page	Hersteller Manufacturer	Artikelnummer Article No.	Seite Page	Hersteller Manufacturer
3482 124 541	12	DAF	3482 911 001	60 134 135	IVECO
	824	IKARUS		828	
	145	IVECO	3482 934 001	747	VOLKSWAGEN
	158 160 161	MAGIRUS-DEUTZ	3482 998 701	41 43 44	IVECO
	162			45 46 47	
	352 354 356	MAN		48 60	
	359 362 365		3483 000 001 ⊕	146	KAMAZ
	366 368 841		3483 000 139 ⊕	409 410 414	MERCEDES-BENZ
	844 854			415 418 422	
	567 568 569	MERCEDES-BENZ		423 428 429	
	575 576 577			434 435 436	
	584 603 615			438 439 444	
	616 634 635			445 493 494	
	868 869 871			496 499 500	
	889			503 504	
	893	NEOPLAN	3483 000 238 ⊕	928	VOLKSWAGEN
	671 672 674	ÖSTERREICHISCHE AUTOMOBILFABRIK (ÖAF)	807		VOLVO
		RENAULT TRUCKS	3483 000 258	409 410 414	MERCEDES-BENZ
722	VAN HOOL	415 418 422			
924		423 428 429			
3482 124 549	819	EVOBUS		434 435 436	
	841 843 849	MAN		438 439 444	
	850			445 493 494	
922	SINOTRUK (CNHTC)	496 499 500		502 503 504	
924 925	VAN HOOL	506 507 508			
936 937	YUTONG	3483 000 259 ⊕	730	SCANIA	
3482 124 550	11	DAF	3483 000 348	681 682 685	RENAULT TRUCKS
	842 844 845	MAN		689 723	
	890 892 893	NEOPLAN		761 762 763	VOLVO
	894 906 907			764 765 782	
	922	SINOTRUK (CNHTC)		783 784 785	
		786 787 788			
		789 790 791			
		797 798 799			
		800			
3482 124 731	729	SCANIA		3483 000 382 ⊕	
3482 125 131	95 96 97	IVECO	784 785 786		
	98 99 134		787 788 789		
	137 138 139		790 791 797		
	140 141 142		798 800		
	143 144 145				
829					
163	MAGIRUS-DEUTZ				
3482 125 512	5	AVIA	3483 000 422	413 421 427	MERCEDES-BENZ
	375 376	MAZ	437 442 446		
	913	PAZ			
3482 602 002	774 775 776	VOLVO	3483 000 461 ⊕	502	MERCEDES-BENZ
	777		3483 000 509 ⊕	91	IVECO
3482 602 003	774 775 776	VOLVO	183 184 185	MAN	
	777		188 190 192		
3482 602 005	774 775	VOLVO	206 207 209		
3482 602 006	774 775	VOLVO	210 211 212		
3482 602 008	776 777	VOLVO	213 214 216		
3482 634 003	681 684 685	RENAULT TRUCKS	218 219 220		
	711 712 713		673 674 675		
	714 715 717		676		
	759 760 781	VOLVO	3483 000 510 ⊕	206 207 208	ÖSTERREICHISCHE AUTOMOBILFABRIK (ÖAF)
3482 634 004	695 700 718	RENAULT TRUCKS	209 210 211	MAN	
	719		212 213 215		
3482 634 005	759	VOLVO	216 219 220		
3482 905 001	92 136	IVECO	221 222 224		
	776	VOLVO	225 226		
3482 907 001	41 43 44	IVECO	649 651 665	MERCEDES-BENZ ÖSTERREICHISCHE AUTOMOBILFABRIK (ÖAF)	
	45 46 47		675 676 677		
3482 909 001 #	761 776 777	VOLVO			

Arithmetische Liste / Part number list

Artikelnummer Article No.	Seite Page	Hersteller Manufacturer	Artikelnummer Article No.	Seite Page	Hersteller Manufacturer
3483 010 137 ⊕	139	IVECO	3483 034 035	715	RENAULT TRUCKS
3483 010 138 ⊕	131 132	IVECO		769 806	VOLVO
3483 014 131	779 780	VOLVO	3483 034 042 ⊕	697 699	RENAULT TRUCKS
3483 014 132	753 755 778	VOLVO		767 768 792	VOLVO
	779 780 804			793 794 795	
	805 806 930			806 931 934	
3483 017 031	755 805 807	VOLVO		935 936	
3483 019 031 #⊕	726 727 728	SCANIA	3483 034 043	698 699	RENAULT TRUCKS
3483 020 033	727 728	SCANIA		769 796 806	VOLVO
3483 020 034 ⊕	139 141 142	IVECO	3483 034 044 ⊕	933	VOLVO
	145		3483 034 045 ⊕	929 930 933	VOLVO
	164	MAGIRUS-DEUTZ	3483 034 135 ⊕	767 768 769	VOLVO
3483 020 035 ⊕	96 97 145	IVECO		770 771 773	
	164	MAGIRUS-DEUTZ		784 786 788	
3483 020 036	728 917	SCANIA		790 791 793	
3483 022 031	204	MAN		794 795 796	
	778 779 780	VOLVO	3488 000 024	767 768 769	VOLVO
	800 801			772 793 794	
3483 022 032	929 930 931	VOLVO		795 796 806	
	933		3488 000 102 ⊕	409 410 412	MERCEDES-BENZ
3483 023 032 ⊕	599 600 601	MERCEDES-BENZ		413 414 415	
	613 631 641			417 418 420	
	642 643 644			421 422 423	
	646 661 662			426 427 428	
	663 664 669			429 432 433	
	670			434 435 436	
3483 024 031 ⊕	728 729	SCANIA		437 438 439	
3483 027 231	765 766 767	VOLVO		441 442 443	
	768 780			444 445 446	
3483 027 332 ⊕	755 766 767	VOLVO		447	
	768 784 786		3488 000 108 #⊕	926	VAN HOOL
	788 790 791		3488 000 122	697 698 699	RENAULT TRUCKS
	793 794 795		3488 000 158	409 410 412	MERCEDES-BENZ
	796 805 807			413 414 415	
3483 028 031	728 918	SCANIA		417 418 420	
3483 030 031 ⊕	493 494 496	MERCEDES-BENZ		421 422 423	
	499 500 503			426 427 428	
	504 508			429 432 433	
3483 030 032 ⊕	409 410 412	MERCEDES-BENZ		434 435 436	
	414 415 417			437 438 439	
	418 420 422			441 442 443	
	423 426 428			444 445 446	
	429 432 434			447 506 508	
	435 436 438			641	
	439 441 444		3488 000 159	761 762 763	VOLVO
	445 502 503			767 768 769	
	506 507 863			772 783 784	
3483 034 032 ⊕	753 761 778	VOLVO		785 786 787	
	779 780 804			788 789 790	
	806 929 930			791 793 794	
	931			795 796 797	
3483 034 033 ⊕	755 765 766	VOLVO		798 799	
	767 768 780		3488 000 366	413 471	MERCEDES-BENZ
	782 783 785		3488 000 373	761 762 763	VOLVO
	792 793 794			764 765 785	
	795 796 806			787 789 790	
	929 931 933			791 798	
	934 935 936		3488 009 634	727	SCANIA
3483 034 034	766 767 768	VOLVO	3488 013 138 ⊕	753 755 778	VOLVO
	769 782 783			779 780 804	
	785 792 793			805 806 930	
	794 795 796		3488 016 031	756	VOLVO
			3488 017 333	195 197 198	MAN

Arithmetische Liste / Part number list

Artikelnummer Article No.	Seite Page	Hersteller Manufacturer	Artikelnummer Article No.	Seite Page	Hersteller Manufacturer
6283 600 539	405 406	MERCEDES-BENZ	6482 000 219	408 413 417	MERCEDES-BENZ
6283 600 557	731	SCANIA		421 427 453	
6284 600 111	377 855	MERCEDES-BENZ		455 456 472	
6284 600 573	379 380 381	MERCEDES-BENZ		475 479 481	
	382 383 384			484 487 489	
	385 386 405			492	
	406 855 856		6594 000 054	48 49 50	IVECO
	857			51 52 53	
	748 749 750	VOLKSWAGEN		54 55 56	
	751 927 928			57 58 59	
6284 600 666	377 378	MERCEDES-BENZ	6594 000 079	813	EVOBUS
6284 600 694	377	MERCEDES-BENZ		874 875 881	MERCEDES-BENZ
6284 600 736	671	NISSAN		883 884 885	
6284 605 004	387 388 389	MERCEDES-BENZ		886	
	390 391 392			893	NEOPLAN
	393 858 859			919 920 921	SETRA
	860		6594 000 080	891 893	NEOPLAN
	746 747	VOLKSWAGEN		920	SETRA
6284 605 008	404 405 406	MERCEDES-BENZ	6594 000 120	772	VOLVO
	407 861 862		6594 000 121	891 907 908	NEOPLAN
	863			910	
6284 605 064	409 410 412	MERCEDES-BENZ	6594 000 124	836 837 838	MAN
	413 414 415			890 892 894	NEOPLAN
	417 418 420			907 908	
	421 422 423		6594 000 171	826	IRISBUS
	426 427 428		6594 000 211	826	IRISBUS
	429 432 433			828	IVECO
	434 435 436		6594 000 218	884 885	MERCEDES-BENZ
	437 438 439			922	SETRA
	441 442 443		6594 000 219	885	MERCEDES-BENZ
	444 445 446			922	SETRA
	447 508 882				
6284 605 065	409 410 412	MERCEDES-BENZ			
	413 414 415				
	417 418 420				
	421 422 423				
	426 427 428				
	429 432 433				
	434 435 436				
	437 438 439				
	441 442 443				
	444 445 446				
	447 508				
6482 000 155	681 682 685	RENAULT TRUCKS			
	689 692 693				
	694 695 700				
	716 717 718				
	719 723				
	759 760 761	VOLVO			
	762 763 764				
	765 772 773				
	781 782 783				
	784 785 786				
	787 788 789				
	790 791 797				
	798 799 800				
	930 931 934				
	935 936				
6482 000 216	299 342	MAN			
6482 000 218	410 411 412	MERCEDES-BENZ			
	413 415 416				
	417 418 419				
	420 423 424				

Vergleichsliste / Cross reference list

Vergleichs-Nr. Compare No.	Artikelnummer Article No.	Vergleichs-Nr. Compare No.	Artikelnummer Article No.	Vergleichs-Nr. Compare No.	Artikelnummer Article No.
ASTRA		BOVA		DAF	
100127	1878 001 070	1155874	3151 000 335	ATRB598	3482 000 859
101647	1878 002 706	187090	3151 000 395	ATRC239	3482 001 166
101648	1878 002 878	187091	3482 119 032	ATRC342	1878 007 172
101649	1878 634 014	193853	3482 083 113	0067894	3151 204 001
101651	3151 208 001	193853	3482 083 118	0078866	3482 119 031
101652	3151 111 032	193854	3151 217 001	0096004	1878 003 276
101653	1805 042 000	193854	3151 217 001	0113365	3151 000 515
104671	1866 030 102	20212049	3482 119 031	0117875R	1882 330 032
112320	1862 305 033	20216212	3151 273 601	0117875R	3482 124 541
112590	1878 001 070	20220944	1878 003 269	0160795	1882 137 307
113100	1878 000 961	20223808	3482 119 032	0165495	1878 001 138
113795	1878 002 878	20223810	3151 182 233	0279810	3151 199 001
114300	3482 083 032	202378	1878 002 706	0286877	3482 060 132
11870	3151 204 001	202379	1878 003 269	0286877R	3482 060 132
122422	3400 117 801	20257128	3482 083 032	0376491	3482 017 034
122442	3400 117 801	20267747	1878 080 037	0376491R	3482 017 034
122531	3482 124 516	20270074	1878 054 933	0514455	3163 030 100
122744	1888 063 137	20270574	1878 080 037	0521458	1878 003 269
122745	3482 125 131	20330503	3151 000 157	0615808	3163 026 100
123102	1862 304 033	20330806	1878 080 037	0615932	3482 017 035
123156	1878 085 741	20330807	1878 080 037	0641350	3482 118 031
123157	3151 000 144	212049	3482 119 031	0660306	3482 000 953
123443	1878 051 801	212053	3151 182 233	0697544	1882 306 210
123762	1878 054 951	216169	3482 119 031	070763	3151 182 031
123762	1878 054 951	216169	3482 119 031	072654	1878 003 269
123762	1878 054 951	216212	3151 273 601	072655	1878 003 269
126 947	3483 000 510	220944	1878 003 269	072656	1878 003 269
151517	1878 054 951	223809	1878 027 231	0740782	1878 003 269
151517	1878 054 951	223810	3151 182 233	0740783	1878 002 706
151525	3482 083 034	223811	1878 002 878	0740784	1878 002 706
154381	3151 208 001	223971	3482 124 522	0740784R	1878 002 706
155873	3482 125 131	234502	1878 054 933	0740787	1878 003 657
20259	3151 111 032	239354	1878 080 034	0740788	1878 003 657
30196	3151 000 515	257128	3482 083 032	0740788R	1878 003 657
55010	1878 002 955	267747	1878 080 037	0740794	1878 001 070
AVIA		267748	1878 080 034	0751952	1878 000 105
402-150031	3482 000 461	270054	1878 002 878	0751953	1861 777 037
402-150101	1878 019 001	270074	1878 054 933	0751954	1861 777 043
402-150102	1878 000 515	270574	1878 080 037	0755079	1878 002 878
431202003	3482 125 512	276261	1878 080 037	078542	1878 003 269
431312002	1878 019 001	30034361	1878 080 037	078544	3482 081 231
442-17050-018-7	1878 000 611	30132605	3151 000 335	078867	1878 054 933
BMC		41154221	3151 000 335	096001	1878 001 070
4K207088	1882 346 131	41376143	1878 027 231	096006	1878 001 138
4K207089	1878 002 955	41689108	1878 054 933	113365	3151 000 515
52RS020389	3482 114 031	512363	1878 003 657	1140537	1878 080 034
52RS020390	1878 080 034	512364	1878 003 657	1140539	3482 081 231
52RS020391	3151 263 031	DAF		1142188	3151 000 335
53RS400002M	3482 083 118	ACHC289	3482 602 008	1154221	3151 000 335
53RS400003M	1878 080 031	ATRA446	1878 600 563	117379	1878 002 706
53RS400004	3151 000 157	ATRB 246	3151 000 397	117405	3482 118 031
53RS400004M	3151 000 157	ATRB 247	3151 000 395	117425	3482 006 036
53RS410961	3482 000 474	ATRB 257	3482 000 419	117425	3482 124 550
53RS410962	1878 003 899	ATRB075	1878 004 100	117875	3482 124 541
53RS410963	3151 000 515	ATRB077	1878 007 279	117875	3482 124 541
54RS410140	3482 000 461	ATRB546	3151 000 397	1204205	3482 083 032
54RS410141	1878 079 331	ATRB560	1878 005 600	1227302	1862 304 033
57RS306250M	3151 000 157	ATRB562	1878 005 599	1227303	1888 063 137
57RS309027M	1878 002 955	ATRB563	3482 000 474	1230549	3482 018 132
		ATRB597	1878 005 601	1230549	3482 119 031
				1230550	3482 119 031

Vergleichsliste / Cross reference list

Vergleichs-Nr. Compare No.	Artikelnummer Article No.	Vergleichs-Nr. Compare No.	Artikelnummer Article No.	Vergleichs-Nr. Compare No.	Artikelnummer Article No.
DAF		DAF		DAF	
1230550	3482 119 031	1348144	1878 001 071	1625970	3400 125 701
1230550R	3482 119 031	1348144R	1878 001 071	1625970R	3400 125 701
1239659	1878 054 933	1348146R	1878 001 070	1625971	3400 700 504
1250710	3151 000 034	1362752	3151 000 034	1625971R	3400 700 504
1251271	1878 027 231	1362759	1878 054 933	1628626	3400 122 101
1261652	3151 000 395	1375593	1878 000 036	1628627	3400 700 504
1267988	3151 199 001	1375593R	1878 000 036	1628627R	3400 700 504
1272114	3482 119 032	1375595	1878 000 294	1634627	3151 000 144
1272115	1878 054 933	1375597	3482 123 839	165495	1878 001 138
1287597	1878 054 933	1376143	1878 027 231	165497	1878 000 105
1287806	3151 182 233	1380002	1878 000 298	166 5428	3482 000 484
1287806	3151 182 233	1380002R	1878 000 298	1663218	1878 003 767
1287898	1878 027 231	1385431	1878 002 071	1663220	1878 004 573
1287898	1878 027 231	1385520	1878 044 631	1663224	1878 003 647
1287898R	1878 027 231	1385520R	1878 044 631	1664346	3151 000 034
1287899	1878 002 878	1385522	1878 054 933	1664358	3151 000 157
1295265	3482 118 031	1385522R	1878 054 933	1685707	1878 003 767
1295265R	3482 118 031	1395695	1878 002 878	1685711	1878 004 573
1303560	1878 054 933	1395695R	1878 002 878	1686642	3151 000 493
1303702	1878 054 951	1395696	1878 054 951	1688219	1878 003 767
1303705	3482 114 032	1395697	1861 777 043	1689108	1878 054 933
1303707	3151 263 031	1395698	1861 777 037	1689109	1878 000 298
1303821	3151 000 395	1395698R	1861 777 037	1689145	1878 080 037
1303975	3151 000 034	1395699	1878 000 105	1689145R	1878 080 037
1304278	1878 002 071	1395699R	1878 000 105	1697725	3151 000 493
1304280	3482 000 419	1395700R	1878 001 152	1700345	1878 004 584
1304280R	3482 000 419	1395703	1878 086 741	1700507	1878 007 279
1307569	1878 044 631	1395703	1878 086 741	1700508R	3482 000 474
1310137	3151 199 001	1395703R	1878 086 741	1702641	3151 000 397
1310896	3482 119 031	1395703R	1878 086 741	1702822R	1878 004 584
1310896R	3482 119 031	1395704R	1878 027 231	1703657	1878 005 600
1310897	3482 119 032	1395705	1878 003 269	1703657R	1878 005 600
1310897R	3482 119 032	1395705R	1878 003 269	1703658R	3482 000 859
1311497	3151 263 031	1395706	1878 003 657	1703739	1878 005 599
13242345	1878 054 933	1400510	1878 079 331	1703739R	1878 005 599
1326842	1878 027 231	1402466	3151 000 397	1703740	3482 000 474
1328793	3496 006 000	1409363	1878 004 100	1703740R	3482 000 474
1329459R	3482 083 032	1409364R	3482 000 419	1703741	1878 005 601
1329549	3482 083 032	1409478	1878 079 331	1703741R	1878 005 601
1329549R	3482 083 032	1409478R	1878 079 331	1705377	1878 007 279
1331326	1878 000 105	1409692	3151 000 651	1706757R	3400 700 368
1334350	3151 182 233	1440715	1878 080 037	1706758R	3400 700 522
1342345	1878 054 933	1447243	1878 000 296	1714245R	3400 122 101
1342345R	1878 054 933	1604165	3189 600 053	1714246R	3400 700 504
1347218	1878 027 231	1606333	3483 000 510	1714247R	3400 700 361
1347696	1878 000 105	160795	1882 137 307	1714248R	3400 122 101
1347696R	1878 000 105	160795	1882 137 307	1714249R	3400 700 521
1348129	1861 777 037	1614294	1878 080 037	1714758R	3400 700 368
1348130	1861 777 043	1615927	3151 000 144	1714759R	3400 700 522
1348131	1878 044 631	1623295	1878 003 647	1714761R	3400 700 467
1348132	1878 002 071	1625963	3400 124 901	1714792R	3400 700 489
1348133	1878 001 152	1625963R	3400 124 901	1735708	3482 114 031
1348136	1878 003 657	1625964	3400 124 701	1736889	3400 700 353
1348137	1878 003 657	1625964R	3400 124 701	1736889R	3400 700 353
1348139	1878 003 276	1625965	3400 700 405	1736890	3400 700 308
1348140	1878 003 269	1625965R	3400 700 405	1736890R	3400 700 308
1348141	1878 086 741	1625966	3400 121 001	1738830	1878 003 647
1348141	1878 086 741	1625967	3400 121 101	1740017	3400 700 307
1348142	1878 002 878	1625967R	3400 121 101	1740017R	3400 700 307
1348142R	1878 002 878	1625968	3400 122 101	1746150	3151 000 493
1348143	1878 003 269	1625968R	3400 122 101	1778732	3400 700 519

Vergleichsliste / Cross reference list

Vergleichs-Nr. Compare No.	Artikelnummer Article No.
DAF	
1778732R	3400 700 519
1780332	3151 000 034
1783192	3189 600 044
1787200	3151 000 651
1789280R	3400 122 101
1789281	3400 700 504
1789281R	3400 700 504
1789294R	3400 122 101
1789295R	3400 122 101
1808123R	3400 700 307
1810168	3151 000 034
1813471	1878 054 933
1813471R	1878 054 933
1813472	1878 080 037
1814035	3400 700 361
1814035R	3400 700 361
1815112R	3400 700 307
1815768R	3400 122 101
1815769R	3400 700 504
1815770R	3400 700 519
1816433R	3400 700 520
1816434R	3400 700 521
1816435R	3400 700 467
1816436R	3400 700 368
1817774R	3400 700 307
1817775	3400 700 527
1817775R	3400 700 527
1818190R	3151 000 395
1818190R	3482 123 839
1818191R	1878 004 100
1818191R	3151 000 397
1818191R	3482 000 419
1818192R	3400 700 375
1818193R	3400 700 523
1818194R	3400 700 376
1818195R	3400 700 524
1818481	3189 600 045
1819446R	3400 700 405
1819447R	3400 700 353
1820661R	3400 700 467
1820662R	3400 700 489
1822487	3151 000 493
1829488R	3400 700 319
1829974R	1878 054 933
1829974R	3151 000 493
1829974R	3482 083 032
1830316	3151 000 493
1834264R	3400 700 319
1836353R	3400 700 316
1837664R	3400 700 520
1837665R	3400 700 524
1843935	3400 700 398
1843935R	3400 700 398
1843936	3400 700 465
1843936R	3400 700 465
1843937	3400 700 464
1843937R	3400 700 464
1843938	3400 700 473
1843938R	1878 005 599
1843938R	3151 000 651
1843938R	3400 700 473

Vergleichs-Nr. Compare No.	Artikelnummer Article No.
DAF	
1843938R	3482 000 474
1843939R	3400 700 476
1846414	1878 004 573
1846414R	1878 004 573
1846416	1878 003 767
1846416R	1878 003 767
1851348R	3400 122 101
1851349R	3400 700 504
1851350R	3400 700 361
1851351R	3400 122 101
1851352R	3400 700 521
1854091	3151 000 157
1858217R	1878 001 071
1858217R	3151 199 001
1858217R	3482 060 132
1858560	3482 001 171
1858562	1878 085 742
1858564	3482 001 184
1860299	3189 600 004
1879929R	1878 079 331
1879929R	3151 000 651
1879929R	3482 000 419
1912687	3151 000 493
1912689	3151 000 034
1916603R	3400 700 353
1935390	3400 122 101
1935391R	3400 700 504
1935392R	3400 700 361
1935393R	3400 122 101
1935394R	3400 700 521
1935396	3400 122 101
1935396R	3400 700 467
1935397R	3400 700 368
1935399R	3400 700 489
1935399R	3482 083 032
19569247	3189 600 030
2005819R	3400 700 603
20330517	3482 000 209
20376130	3182 998 501
252683	1878 001 070
259814	1882 110 542
259814	1882 110 542
266060	3151 000 395
279810	3151 199 001
281305	1878 086 741
281305	1878 086 741
286877	3482 060 132
286878	1861 777 037
291228	3482 018 132
291228	3482 119 031
295427	1861 777 037
299567	1878 003 269
299568	1878 003 269
331815	1878 001 071
360217	1878 003 657
368100	1878 001 071
373895	1878 001 070
376490	1878 000 105
376491	3482 017 034
378012	1878 001 152
387012	1878 001 152

Vergleichs-Nr. Compare No.	Artikelnummer Article No.
DAF	
389380	1878 003 657
500908	1882 110 542
500908	1882 110 542
509247	3482 002 234
514454	3151 199 001
514455	3163 030 100
556931	1878 003 269
558111	1878 000 105
558180	1878 086 741
558180	1878 086 741
615808	3163 026 100
615932	3482 017 035
623212	1878 001 070
632743	1878 001 071
633593	3482 008 034
641350	3482 118 031
644511	1878 634 014
644512	1882 346 131
659078	3482 017 034
659320	3151 199 001
661066	1878 000 105
666432	1878 002 706
669371	1861 923 032
669371	1878 001 152
669372	1878 001 152
679884	3482 119 032
697544	1882 306 210
740195	1878 003 657
740528	1878 086 741
740528	1878 086 741
740781	1878 086 741
740781	1878 086 741
740782	1878 003 269
740783	1878 002 706
740784	1878 002 706
740787	1878 003 657
740788	1878 003 657
740789	1878 000 105
740790	1878 000 105
740791	1878 001 152
740792	1878 001 152
740793	1861 777 043
740794	1878 001 070
740795	1861 777 037
740796	1878 001 071
755079	1878 002 878
890094	1861 777 037
890095	1861 777 043
DEMAG	
0890 351	3151 045 001
180 608 40	3151 199 001
182 231 40	3151 045 001
1949 3312	1878 004 832
244 326 40	1882 301 239
334 014	1881 010 139
334 015	3151 045 001
3630-6894-057	1881 010 139
47230612	3151 000 493
54184712	3482 000 546
650 521	1881 059 208

Vergleichsliste / Cross reference list

Vergleichs-Nr. Compare No.	Artikelnummer Article No.
-------------------------------	------------------------------

DEMAG

672 126	1864 634 026
675 015	1863 010 100
678 528	1881 010 139
678 528 40	1881 010 139

DRÖGMÖLLER

000250200001-00	1888 042 009
000250201001-00	1878 000 968
000250201100	1882 301 239
000250202000-00	1878 002 706
000250250100	1878 003 657
400250100002-00	3151 000 547
400250100003-00	3488 017 432
400250100003-00	3488 017 432
400250100004-00	1878 005 805
400250100004-00	1878 634 022

ENASA

770 240	1878 003 277
770 241	1878 003 276
770 437	3151 145 101
770 571	1861 902 032
773 008	1878 022 841
774 691	3482 081 231
774 692	1878 003 276
774 693	1861 902 032
774106	3482 081 231
774106	3482 083 113
775 594	1878 022 841
775549	1878 022 841
775550	1878 003 276

EVOBUS

000 250 64 15	3151 000 392
000 250 76 15	3151 126 031
001 250 88 15	3151 000 547
002 250 44 15	3151 000 335
002 250 45 15	3151 000 157
002 250 87 04	3482 012 211
003 250 16 15	3151 000 615
003 250 67 15	3151 000 615
003 250 70 04	1882 301 239
004 250 89 04	3482 081 233
005 250 19 04	3482 124 522
005 250 83 04	3482 081 232
005 250 84 04	3482 081 231
007 250 13 03	1878 001 136
007 250 74 03	1878 001 070
011 250 04 03	1878 005 668
012 250 69 03	1878 000 105
015 250 36 03	1878 003 657
016 250 12 03	1878 080 031
017 250 90 03	1878 080 031
018 250 20 03	1878 080 034
018 250 95 03	1878 080 033
018 250 99 03	1878 080 033
019 250 38 03	1878 003 657
019 250 43 03	1878 080 033
019 250 46 03	1878 080 033
020 250 57 03	1878 080 037
023 250 73 03	1878 005 540
023 250 97 03	1878 005 541

Vergleichs-Nr. Compare No.	Artikelnummer Article No.
-------------------------------	------------------------------

EVOBUS

025 250 78 03	1878 005 541
025 250 79 03	1878 005 540
8.383.000.133.0	3130 010 100
8.383.000.246	1878 005 486
8.383.000.246.0	1878 005 486
8.383.067.000	1881 041 656
8.383.067.000	1881 041 656
8.383.121.000	1881 039 531
8.383.130.000	1862 088 131
8.383.131.000	3151 021 001
8.383.145.000	1878 003 320
8.383.146.000	1882 301 239
8.383.146.000 C	1882 301 239
8.383.155.000	1882 252 331
8.383.156.000	1861 303 248
8.383.186.000	3151 027 102
8.383.186.000 D	3151 027 102
8.383.186.000.0	3151 027 102
8.383.189.000	3151 000 515
8.383.192.000	1882 302 131
8.383.192.000 C	1882 302 131
8.383.195.000	1861 923 032
8.383.195.000	1878 001 152
8.383.195.000	1878 001 152
8.383.195.000 C	1878 001 152
8.383.203.000	1878 001 152
8.383.210.000	1861 571 110
8.383.211.000	3482 012 211
8.383.211.000	3482 012 211
8.383.211.000 C	3482 012 211
8.383.211.000 C	3482 012 211
8.383.212.000	3151 099 101
8.383.212.000 D	3151 099 101
8.383.212.000.0	3151 099 101
8.383.219.000	1882 342 134
8.383.219.000	1882 342 134
8.383.219.000 C	1882 342 134
8.383.220.000	1861 571 110
8.383.220.000 C	1861 571 110
8.383.224.000	1888 042 009
8.383.224.000 C	1888 042 009
8.383.225.000	1878 000 968
8.383.225.000 D	1878 000 968
8.383.226.185	3151 108 031
8.383.243.000	1861 911 232
8.383.244.000	1882 342 134
8.383.244.000.2	1882 342 134
8.383.248.000	3151 108 031
8.383.254.000	3482 083 113
8.383.254.000 B	3482 081 231
8.383.261.000	1861 571 110
8.383.261.000.0	1861 571 110
8.383.262.000	1878 000 968
8.383.263.000	1861 911 232
8.383.263.000.0	1861 911 232
8.383.264.000	1888 042 009
8.383.265.000	1878 001 152
8.383.268.000	3482 081 232
8.383.268.000	3482 081 232
8.383.268.000 B	3482 081 232
8.383.269.000	1861 874 032

Vergleichs-Nr. Compare No.	Artikelnummer Article No.
-------------------------------	------------------------------

EVOBUS

8.383.271.000	3151 027 133
8.383.275.000	1861 303 248
8.383.276.000	1878 001 070
8.383.280.000.0	3488 017 432
8.383.281.000	1878 005 805
8.383.281.000	1878 634 022
8.383.292.000	3482 083 032
8.383.295.000	1878 085 742
8.383.299.000	1878 085 742
8.383.310.000	1878 085 742
8.383.319.000	3482 081 232
8.383.321.000	1878 080 033
8.383.321.000 C	1878 080 033
8.383.324.000	1878 065 131
8.383.327.000.2	1882 342 135
8.383.328.000	3482 062 035
8.383.328.000	3482 083 252
8.383.330.000	1878 085 641
8.383.330.000	1878 085 641
8.383.333.000	3151 000 615
8.383.333.000.0	3151 000 615
8.383.334.000	3488 017 410
8.383.334.000.2	3488 017 410
8.383.335.000	1878 005 805
8.383.335.000	1878 634 022
8.383.335.000.0	1878 005 805
8.383.335.000.0	1878 634 022
8.383.335.000.0	3488 017 410
8.383.339.000	3482 083 113
8.383.340.000	3482 083 034
8.383.343.000	3482 081 231
8.383.344.000	3482 081 233
8.389.335.000	1878 005 805
8.389.335.000	1878 634 022

FAUN

0890 351	3151 045 001
0890 642	1882 341 001
0890-141	1880 083 132
0890-209	1881 039 532
0890-261	1878 001 074
0890-269	1880 092 415
0890-271	1881 041 656
0890-273	1863 009 100
0890-275	1882 325 134
0890-303	1881 039 532
0890-308	1881 039 532
0890-331	1881 041 656
0890-360	1882 205 234
0890-364	1882 325 139
0890-374	1878 000 104
0890-427	3163 026 100
0890-580	1888 015 515
0890-589	1882 301 239
0890-591	3151 000 375
0890-601	1878 000 967
0890-655	1882 280 213
3630-6894-057	1881 010 139
4100-430	1880 092 415
8406-404	1878 000 968
8407-424	3163 026 100

Vergleichsliste / Cross reference list

Vergleichs-Nr. Compare No.	Artikelnummer Article No.
-------------------------------	------------------------------

FAUN

8407-439	1878 000 968
8452-295	1882 342 134
8474-442	1878 002 706
99707007818	3482 000 209
99707010805	3151 000 144
99707793317	1878 004 832

HINO

S3121-02600-A	3482 111 031
S3125-05010-A	1862 248 033
S3125-05020-A	1862 543 031
31001-E01701	1862 543 031
31001-E01701	3488 019 133
31001-E0180	3488 019 133
31200-1590A	3488 019 133
31210-E0630	3482 000 777
31210-0178A	3151 000 034
31210-0178A	3482 083 032
31210-2600	3482 111 031
31210-2600A	3482 111 031
31210-3200A	3482 083 032
31217-1130A	3180 001 008
31230-E0010	3151 000 157
31230-E0010A	3151 000 157
31230-E0030	3151 000 034
31230-E0040	3151 000 750
31230-0024A	3151 000 157
31230-1090A	3151 000 750
31230-1091A	3151 000 750
31230-1150A	3151 000 034
31250-E0A80	1878 004 573
31250-E0850	1878 004 133
31250-2010A	1862 248 033
31250-4540	1878 006 035
31250-4540A	1878 006 035
31250-5010A	1862 248 033
31250-5020	1862 543 031
31250-5020A	1862 543 031
31250-6480A	1878 080 037
38185-EV010	3496 006 000

IRISBUS

101652	3151 111 032
104671	1866 030 102
112320	1862 305 033
112590	1878 001 070
113099	1878 001 136
113795	1878 002 878
122531	3482 124 516
122744	1888 063 137
122745	3482 125 131
123102	1862 304 033
123165	1878 032 032
1271902	1863 101 100
154381	3151 208 001
2296059	3400 700 497
30196	3151 000 515
42026898	3151 000 515
42061041	3482 012 238
42537411	3189 600 004
4303058	1878 002 825
500000874	3151 145 101

Vergleichs-Nr. Compare No.	Artikelnummer Article No.
-------------------------------	------------------------------

IRISBUS

500001619	1862 438 032
500397755	3151 000 144
500397756	1878 080 037
5006172137	3400 700 633
5006172148	3151 250 231
5006172148	3400 700 633
500697757	3482 083 032
5010556020	3482 078 134
5010556021	1878 032 032
5010556025	3151 000 157
5010556174	1878 032 032
503138923	3151 000 493
504034992	3151 000 419
504091142	3151 000 144
504118580	3400 700 633
504171014	3482 000 573
5801203461	1878 000 298
5801273688	3151 000 157
5801312751	6594 000 171
5801702427	6594 000 211
5801718344	3482 000 573
5801718344	3482 083 040
5801720105	1878 054 933
775550	1878 003 276
8193332	3100 002 038

ISUZU

ISU888	3400 700 392
ISU890	3400 700 383
ISU891	3400 700 385
ISU892	3400 700 387
ISU894	3400 700 390
ISU921	3400 700 389
ISU922	3400 700 391
ISU923	3400 700 389
1 Jx046 4780	3482 083 118
1 31220 3220	3488 017 333
1 31220 4140	3488 017 447
1-JX046-477-0	1878 080 033
109 820 1190	3151 000 157
1-31240-733-0	1862 303 031
1-31240-905-0	1862 303 031
1-31240-974-0	1878 080 033
1312600260	1862 303 031
1-31310-011-0	3151 000 144
1-31320-012	3400 700 387
1-31320-012	3400 700 390
1-31320-034	3400 700 383
1-31320-034	3400 700 385
8-97031-758	3400 700 392
8-97089-652	3400 700 392
8-97229-239	3400 700 383
8-97229-241	3400 700 383
8-97255-313	3400 700 389
8-97255-313	3400 700 391
8-97259-693	3400 700 389
8-97351-794	3400 700 383
8-97351-794	3400 700 385
8-97351-794	3400 700 387
8-97351-794	3400 700 390
8-97351-794	3400 700 391

Vergleichs-Nr. Compare No.	Artikelnummer Article No.
-------------------------------	------------------------------

ISUZU

8-97367-795	3400 700 387
8-97367-795	3400 700 391
8-97377-149	3400 700 389
8-97389-910	3400 700 392
8-98037-004	3400 700 389
8-98040-093	3400 700 389
8-98164-917	3400 700 387
8-98164-917	3400 700 391
9-00095-040-0	1863 600 128
9-00095-040-1	1863 600 128
94020016	1863 600 128
94024052	1863 600 128

IVECO

K18036	1863 600 125
01260096	1878 001 074
01260402	1864 634 026
01260406	1864 202 035
01260410	1864 347 102
01260463	1863 837 002
01260500	1881 039 532
01260550	1881 009 201
01260603	1880 083 132
01260638	1881 039 532
01261333	1882 325 134
01261631	3082 121 031
01261760	3151 021 001
01261902	1878 000 957
01262142	1880 092 415
01262431	1882 325 134
01266388	1859 600 001
01266392	1863 600 123
01266397	1863 009 100
01266402	1881 010 139
01266448	1881 010 139
01266475	1880 083 132
01266493	1880 092 415
01266503	1881 039 532
01266566	1882 325 134
01266612	1864 202 035
01266638	1861 034 147
01266647	1864 202 035
01271770	1880 083 132
01271852	1881 041 656
01271879	1861 034 147
01271885	1861 600 033
01271887	1863 600 125
01271895	1863 010 100
01271897	1861 600 033
01271900	1863 010 100
01271900/U-E	1863 010 100
01271902/U-E	1863 101 100
01271976	1881 041 656
01271999	1878 000 104
01272016	1881 039 531
01272035	1881 039 532
01272040	1881 039 532
01272042	1881 039 532
01272047	1881 039 532
01272048	1881 039 532
01272055	1882 325 139

Vergleichsliste / Cross reference list

Vergleichs-Nr. Compare No.	Artikelnummer Article No.
IVECO	
01272545	1880 092 415
01278622	1882 325 134
01278624	1878 000 104
01415241810	3151 021 001
01805282	3151 000 144
01903805	1878 600 834
01903813	1878 634 020
01903813	3482 085 033
01903813	3482 085 033
01903815	1878 003 661
01903815	3482 085 033
01903816	1878 000 957
01903816	1882 325 139
01903819	3482 085 033
01903820	3482 905 001
01903821	1862 973 002
01903821	3482 905 001
01903825	1878 600 834
01903830	1850 480 049
01903830	1862 977 001
01903830	3000 434 001
01903831	1861 572 431
01903832	1861 874 032
01903832	3482 012 238
01903833	3400 700 454
01903834	3400 700 457
01903835	3400 700 456
01903836	1878 002 955
01903836	3482 085 033
01903837	1861 992 432
01903837	1878 004 456
01903837	3400 700 454
01903837	3483 010 138
01903838	1878 022 841
01903838	3400 700 457
01903838	3483 010 137
01903841	1862 967 001
01903841	3482 907 001
01903843	3482 038 031
01903844	3482 085 033
01903844	3482 085 033
01903845	1878 002 955
01903845	3482 085 033
01903846	3483 020 034
01903847	1861 653 132
01903847	3482 008 033
01903848	1881 039 532
01903849	1881 039 532
01903850	1878 001 074
01903850	1881 039 532
01903853	1878 634 017
01903853	3482 124 522
01903854	1878 001 070
01903854	1882 307 131
01903855	1878 001 074
01903855	1882 307 131
01903859	1878 634 017
01903859	3482 124 541
01903860	1878 001 070
01903860	3482 002 234
01903862	1878 002 955

Vergleichs-Nr. Compare No.	Artikelnummer Article No.
IVECO	
01903865	1878 002 955
01903866	1878 634 017
01903866	3482 124 534
01903867	1878 634 017
01903867	3482 124 534
01903868	3482 124 534
01903870	1878 634 017
01903870	3482 124 541
01903871	1878 001 152
01903871	1882 325 139
01903872	1878 000 957
01903872	1882 325 134
01903873	1878 000 104
01903873	1882 325 134
01903874	1878 000 957
01903874	1882 325 134
01903875	1882 325 134
01903876	1878 001 152
01903876	1882 325 134
01903877	1878 000 957
01903877	1882 325 134
01903878	1882 325 134
01903879	1878 002 955
01903879	3482 124 532
01903881	1878 002 955
01903881	3482 124 533
01903882	3482 124 533
01903883	1878 003 657
01903883	3482 124 533
01903884	1878 001 138
01903884	3482 124 532
01903885	1878 003 657
01903885	3482 124 532
01903886	1878 002 955
01903886	1882 316 035
01903886	3482 124 531
01903886	3482 124 531
01903887	1878 001 138
01903887	1882 316 035
01903887	3482 124 531
01903887	3482 124 531
01903888	1878 003 657
01903888	1882 316 035
01903888	3482 124 531
01903888	3482 124 531
01903890	1861 874 032
01903890	3482 012 211
01903890	3482 012 211
01903891	3400 042 031
01903892	3400 118 901
01903893	1878 002 706
01903893	3482 124 534
01903894	1861 577 136
01903894	3482 008 036
01903896	3482 038 031
01903897	1878 001 077
01903897	3482 002 234
01903899	1878 002 955
01903899	3151 000 515
01903899	3482 124 516
01903900	1878 000 957

Vergleichs-Nr. Compare No.	Artikelnummer Article No.
IVECO	
01903900	1882 325 139
01903903	3482 008 033
01903907	1862 811 001
01903907	3482 911 001
01903911	1878 002 955
01903911	3482 085 033
01903912	1878 085 742
01903912	3483 020 034
01903913	1850 480 049
01903913	1862 977 001
01903913	3000 434 001
01903914	3400 700 429
01903916	1862 973 002
01903916	3482 905 001
01903921	3483 020 034
01903923	1861 643 134
01903924	1878 002 955
01903924	3482 085 033
01903925	1878 000 957
01903925	1882 325 139
01903927	1861 577 037
01903927	3482 008 033
01903928	1861 577 136
01903928	3482 008 036
01903929	1878 634 017
01903929	3482 124 522
01903930	1878 634 017
01903930	3482 124 541
01903931	1878 634 017
01903931	3482 124 534
01903932	1878 634 017
01903932	3482 124 541
01903934	1861 653 132
01903934	3482 008 033
01903936	1878 001 138
01903936	1882 316 035
01903936	3151 000 515
01903936	3482 124 531
01903936	3482 124 531
01903937	1878 001 138
01903937	3482 124 532
01903938	1878 001 138
01903938	3482 124 533
01903939	1878 001 138
01903940	1878 001 138
01903940	3482 124 534
01903941	1878 001 138
01903942	3400 119 001
01903944	1878 022 841
01903944	3483 020 035
01903946	1878 001 152
01903946	1882 325 134
01903947	1878 001 152
01903947	1882 325 139
01903948	1878 001 074
01903948	1881 039 532
01903949	1878 001 074
01903949	1882 307 131
01903950	1861 351 342
01903950	1882 325 134

Vergleichsliste / Cross reference list

Vergleichs-Nr. Compare No.	Artikelnummer Article No.	Vergleichs-Nr. Compare No.	Artikelnummer Article No.	Vergleichs-Nr. Compare No.	Artikelnummer Article No.
IVECO					
01903952	1861 351 342	01904749	1878 002 072	01904791	3482 124 532
01903952	1882 325 134	01904749	3083 039 031	01904792	1861 572 431
01903953	1878 001 070	01904749	3151 600 529	01904793	3400 042 031
01903953	1882 307 131	01904751	1878 085 741	01904794	3000 434 001
01903954	1878 001 070	01904751	3482 083 032	01904795	3400 700 429
01903954	3482 002 234	01904752	1878 054 951	01904796	1878 032 032
01903955	1881 039 532	01904752	1878 054 951	01904796	3151 000 144
01903956	1878 000 104	01904752	3482 083 032	01904796	3400 084 031
01903956	1882 325 134	01904753	3400 066 031	01904796	3482 078 134
01903957	1878 001 154	01904754	3400 700 449	01904797	3151 600 529
01903957	3482 124 532	01904755	3400 068 031	01904798	3400 117 701
01903958	1878 003 657	01904756	1878 007 339	01905274	3151 600 544
01903958	3482 124 532	01904756	3151 000 144	01905282	3151 000 144
01903959	1878 003 657	01904756	3482 078 132	01905290	3151 600 529
01903959	1882 316 035	01904756	3482 078 134	01905318	3151 065 031
01903959	3482 124 531	01904756	3482 078 134	01905465	3151 196 031
01903959	3482 124 531	01904757	1878 634 020	01905703	3400 117 801
01904700	1878 001 154	01904758	1861 653 132	01905717	3400 700 455
01904700	1882 316 035	01904759	1861 577 037	01905728	3400 042 031
01904700	3482 124 531	01904760	3400 117 701	01905839	1878 003 661
01904700	3482 124 531	01904761	1878 002 955	01905839	3482 085 033
01904701	1861 742 032	01904761	3151 207 031	01905840	1878 054 951
01904701	3482 038 031	01904761	3482 085 033	01905840	1878 054 951
01904702	1878 002 706	01904762	1878 002 955	01905840	3483 020 034
01904702	3482 124 534	01904762	3151 207 031	01908500	3400 700 449
01904703	1878 001 077	01904762	3400 118 901	01908502	3400 066 031
01904703	3482 002 234	01904763	1878 002 955	01908503	3400 700 449
01904704	1861 874 032	01904763	3400 042 031	01908504	3400 700 449
01904704	3482 012 238	01904764	1878 003 661	01908508	1878 085 741
01904705	1861 874 032	01904764	3400 118 901	01908508	3151 000 144
01904705	3482 012 211	01904769	1878 634 020	01908508	3482 083 113
01904705	3482 012 211	01904769	3482 085 033	01908509	3400 066 031
01904710	1862 811 001	01904769	3482 085 033	01908512	3400 074 031
01904710	3482 911 001	01904770	1878 003 274	01908513	3400 107 031
01904711	1878 054 951	01904771	1861 874 032	01908514	3400 077 071
01904711	1878 054 951	01904771	3482 012 238	01908515	3400 084 031
01904712	3400 700 454	01904772	1861 874 032	01908517	3400 700 312
01904713	1878 000 957	01904772	3482 012 211	01908518	1878 054 951
01904713	1882 325 134	01904772	3482 012 211	01908518	1878 054 951
01904714	1878 000 957	01904773	1861 572 431	01908518	3151 000 144
01904714	1882 325 134	01904777	1878 001 154	01908518	3482 083 113
01904715	1878 000 957	01904777	3482 085 033	01908521	3400 700 429
01904715	1882 325 134	01904777	3482 085 033	01908522	3000 434 001
01904716	1878 000 957	01904778	3400 077 071	01908523	3400 117 701
01904716	1882 325 134	01904779	1878 054 951	01908524	1878 085 741
01904717	1878 000 957	01904779	1878 054 951	01908524	3151 000 144
01904717	1882 325 139	01904779	3151 000 144	01908524	3482 083 113
01904718	3400 700 429	01904779	3400 700 455	01908532	3400 700 455
01904719	1861 742 032	01904779	3482 083 032	01908533	3400 117 801
01904719	3482 038 031	01904780	3400 117 801	01908534	3400 700 457
01904725	3400 042 031	01904785	1862 317 031	01908537	3400 068 031
01904728	1878 003 661	01904785	3151 000 144	01908539	3400 077 071
01904728	3400 118 901	01904785	3482 078 134	01908540	3400 084 031
01904729	1878 085 741	01904786	3400 700 418	01908542	3400 077 071
01904729	3483 020 035	01904787	3400 700 454	01908543	3400 700 432
01904730	1878 054 951	01904788	3400 700 457	01908544	3400 117 701
01904730	1878 054 951	01904789	3400 700 456	01908545	1862 811 001
01904730	3483 020 035	01904790	1878 054 951	01908545	3482 911 001
01904733	1878 600 834	01904790	3400 700 454	01908548	3400 117 801
01904734	1878 600 841	01904790	3483 020 035	01908549	3400 084 031
01904735	1878 600 841	01904791	1878 634 020	01908553	3400 700 432

Vergleichsliste / Cross reference list

Vergleichs-Nr. Compare No.	Artikelnummer Article No.
-------------------------------	------------------------------

IVECO

01908558	3400 700 449
01908559	3400 068 031
01908561	3000 951 026
01908574	3400 700 447
02242543	1861 600 033
02337655	3151 021 001
02337656	3151 021 001
02337657	3130 010 100
02440923	1863 101 100
02442308	1882 325 134
02442309	1881 041 656
02442543	1861 600 033
02442544	1861 600 033
02442545	1880 092 415
02442545/U-E	1880 092 415
02442546	1880 092 415
02442557	1878 000 104
02442558	1878 000 104
02442563	1882 325 134
02443133	3151 000 515
02443133/KZ	3151 000 515
02443712	1861 351 342
02474844	1882 261 013
02475334	1878 634 017
02475546	3151 199 001
02475547	3151 199 001
02475629	3151 000 515
02475629/UB	3151 000 515
02476063	3482 060 233
02476073	1882 307 131
02476075	1878 001 074
02476483	3482 124 522
02477136	1878 000 957
02477181	1878 634 017
02477328	1882 307 131
02477896	1878 634 017
02477897	1878 002 955
02477898	1882 325 134
02477900	1878 001 152
02477926	1878 000 957
02477929	1878 000 957
02477930	1878 000 104
02477936	1878 001 074
02478592	1878 001 152
02479048	3151 000 515
02479103	3482 124 534
02479104	3482 124 534
02560550	1881 010 139
02565803	3151 199 001
02984082	3163 026 100
02984082/U-E	3163 026 100
02984096/U-E	1882 280 213
03342363	1863 600 125
03420738/U-E	1805 042 000
03435623	1863 010 100
03457374	1881 065 101
03457374/U-S	1881 065 101
03457375	1881 065 101
03457510	1881 065 101
03471490	1881 010 139
03472373	1863 101 100

Vergleichs-Nr. Compare No.	Artikelnummer Article No.
-------------------------------	------------------------------

IVECO

04370143	1863 837 002
04371490	1881 010 139
04457823	1878 002 955
04459152	3482 124 541
04459728	3482 085 033
04459728	3482 085 033
04459737	3482 002 234
04459737/U-S	3482 002 234
04459822	3482 125 131
04459823	1878 002 955
04459827	1861 577 037
04588700	3482 038 031
04607799	1878 600 834
04623109	1878 600 834
04626605	1882 325 134
04641403	1878 600 834
04679105	1878 600 834
04691736	1878 002 955
04692717	3482 125 131
04695659	1882 325 134
04695660	1882 325 134
04695661	1878 000 957
04699157	3151 054 031
04699160	3482 085 033
04699160	3482 085 033
04699161	1878 001 138
04724654	3151 127 031
04725802	3151 071 032
04727742	3151 098 031
04733573	3482 124 532
04733575	3482 124 533
04738961	1878 001 138
04738961	3482 085 033
04738962	3482 085 033
04739151	1878 001 138
04741461	1878 002 955
04741463	3482 085 033
04741464	1878 001 138
04742136	1861 992 432
04742136	1878 004 456
04742138	3100 002 038
04742138	3151 123 031
04745051	3482 125 131
04747807	3483 020 034
04749155	3482 125 131
04757082	3151 114 031
04757088	3151 000 148
04757090	3483 020 034
04766074	1882 325 139
04766075	1878 000 957
04769116	1878 000 957
04769156	3151 196 031
04770204	1878 634 020
04770205	3151 117 031
04777541	1862 973 002
04779155	3482 125 131
04787274	3151 196 031
04787275	3151 824 001
04795778	3482 085 033
04795778/U-S	3482 085 033
04795778/V-E	3482 085 033

Vergleichs-Nr. Compare No.	Artikelnummer Article No.
-------------------------------	------------------------------

IVECO

04808941	3482 905 001
04826715	1862 310 132
04834868	1862 973 002
04837884	1878 001 138
04838491	3482 125 131
04838491	3482 125 131
04839133	1878 000 957
04846454	3151 196 031
04856715	1862 310 132
04857270	1878 000 957
04859167	1862 973 002
04859168	1861 742 032
04864246	1861 742 032
07137929	3482 125 131
08122735	3100 002 038
08122735	3151 123 031
08122736	3151 000 148
08132550	1878 007 339
08132554	1878 054 951
08132554	1878 054 951
08193331	3100 002 040
08193332	3100 002 038
08438491	3482 125 131
08558284	1878 600 841
08566182	1878 600 834
08566183	1878 600 834
08566186	1878 600 841
08566309	1850 282 652
08568284	1878 600 841
08582397	1878 600 841
08586808	1862 811 001
08586809	3482 911 001
08587332	1862 811 001
08589468	1850 480 049
08597015	1862 811 001
08598464	1862 811 001
08598873	1878 074 841
08600700	1878 600 834
08600701	1878 600 841
08954687	1861 572 431
101652	3151 111 032
112320	1862 305 033
113795	1878 002 878
122531	3482 124 516
122744	1888 063 137
123102	1862 304 033
1271902	1863 101 100
1272047	1881 039 532
154381	3151 208 001
1904773	1861 572 431
1905225	3151 204 001
1905274	3151 600 544
1905469	3151 127 031
1908503	3400 700 449
1908508	3482 083 113
1908518	3482 083 113
1908524	3482 083 113
1908558	3400 700 449
1908559	3400 068 031
20569134	3483 034 042
2991557	3400 042 031

Vergleichsliste / Cross reference list

Vergleichs-Nr. Compare No.	Artikelnummer Article No.	Vergleichs-Nr. Compare No.	Artikelnummer Article No.	Vergleichs-Nr. Compare No.	Artikelnummer Article No.
IVECO		IVECO		IVECO	
2991558	3400 042 031	2996530	3400 700 486	42037964	1861 577 136
2991587	1878 002 955	2996743	3400 117 801	42037967	3482 008 036
2991587	3482 124 516	2996991	3400 700 431	42061041	3482 012 238
2991656	3400 700 444	33/00287	3151 065 031	42061041	3482 012 238
2992012	3400 700 447	4113052	1878 002 825	42061357	1878 001 077
2992026	3400 700 432	42003033	1882 325 134	42061359	3482 002 234
2992027	3151 600 529	42003323	1882 325 139	42061366	3482 124 534
2992215	3400 700 432	42003325	1861 351 342	42061411	1861 874 032
2992383	3400 700 330	42003364	3482 124 534	42061499	3482 008 038
2992474	3400 700 433	42003365	3482 124 531	42061499/U-S	3482 008 038
2992486	1878 002 825	42003368	3482 124 541	42061545	3482 124 541
2992486	3151 000 144	42003396	3151 199 001	42061547	1878 002 706
2992486	3482 083 113	42003397	3151 199 001	42061852	3151 127 031
2992489	3400 700 452	42003402	1861 653 132	42061853	3151 114 031
2992490	3400 700 430	42003473	3151 000 515	42061921	3151 199 001
2992491	3400 700 431	42003474	3151 000 515	42061941	3483 020 035
2992492	3400 700 431	42003545	1878 001 152	42061964	3483 020 034
2992556	3400 700 447	42003637	1878 001 154	42062093	3482 083 040
2992579	3000 951 026	42003658	3151 000 515	42062095	3100 002 038
2992580	3400 700 432	42003731	1882 325 139	42062095	3151 123 031
2992629	3000 951 026	42003732	1882 325 139	42062097	3151 000 148
2992630	3400 700 432	42003733	1882 325 134	42062098	1878 054 951
2992631	3400 117 701	42003734	1881 041 656	42062098	1878 054 951
2994017	3400 700 433	42003736	1882 325 134	42062099	3483 020 035
2994018	3400 700 447	42003737	1882 325 134	42062100	3483 020 034
2994020	3400 700 432	42003852	3482 124 532	42062100	3483 020 034
2994024	3000 951 026	42006023	1861 653 132	42062100/U-S	3483 020 034
2994026	3400 117 701	42014136	3482 124 533	42062100/V-E	3483 020 034
2994027	3400 700 432	42014136	3482 124 533	42062101	3482 124 516
2994034	3400 117 701	42014240	3482 124 532	42062103	1878 054 951
2994035	3000 951 026	42014248	3482 124 532	42062103	1878 054 951
2994036	3400 700 432	42014319	3482 085 033	42062106	3483 020 034
2994037	3400 700 444	42014319	3482 085 033	42062107	3483 020 035
2994040	3400 700 429	42014399	3482 124 531	42062184	1878 022 841
2994069	3400 700 433	42014718	1878 000 957	42062185	1878 085 741
2994119	3400 700 449	42016023	1861 653 132	42062307	1882 325 139
2995559	3400 700 432	42016352	3482 012 211	42062541	1878 003 657
2995703	3000 951 026	42016352	3482 012 211	42062613	1878 001 138
2995704	3400 700 444	42022205	3151 263 031	42062617	3482 085 033
2995705	3400 700 432	42022206	3482 114 031	42062916	1878 054 951
2995706	3400 117 701	42022207	1878 004 832	42062916	1878 054 951
2995724	3400 700 483	42026023	1861 653 132	42062969	3482 043 134
2995776	3400 700 432	42026271	1882 325 139	42062970	3483 010 138
2995777	3400 700 448	42026352	3482 012 211	42062970/U-E	3483 010 138
2995815	3400 700 449	42026352	3482 012 211	42062971	3483 010 137
2996041	3400 700 430	42026354	3482 012 211	42062971/U-E	3483 010 137
2996050	3400 700 430	42026354	3482 012 211	42062971/V-E	3483 010 137
2996059	3400 700 497	42026354/KZ	3482 012 211	42063032/U-S	1882 302 131
2996089	3400 700 432	42026354/KZ	3482 012 211	42063062	3483 010 138
2996090	3400 700 448	42026355	1861 874 032	42063098	3483 010 137
2996101	3400 700 633	42026470	1878 001 152	42063099	1878 085 741
2996299	3400 700 448	42026780	3482 125 131	42063184	3151 000 515
2996321	3400 700 483	42026898	3151 000 515	42064318	1878 054 951
2996358	3400 700 431	42026899	3151 000 515	42064318	1878 054 951
2996516	3400 700 475	42037017	1878 003 657	42064535	1861 643 134
2996517	3400 700 475	42037018	1878 003 657	42064572	1861 992 432
2996523	3400 700 636	42037235	1861 742 032	42064572	1878 004 456
2996525	3400 700 487	42037237	3482 038 031	42064718	1861 992 432
2996526	3400 700 636	42037449	1878 001 152	42064718	1878 004 456
2996528	3400 700 474	42037450	1878 001 152	42066352	3482 012 211
2996529	3400 700 474	42037963	3482 008 036	42066352	3482 012 211

Vergleichsliste / Cross reference list

Vergleichs-Nr. Compare No.	Artikelnummer Article No.	Vergleichs-Nr. Compare No.	Artikelnummer Article No.	Vergleichs-Nr. Compare No.	Artikelnummer Article No.
IVECO		IVECO		IVECO	
42100356	1878 054 951	42102970	1862 317 032	500024666	3151 000 493
42100356	1878 054 951	42103036	3400 117 801	5000305439	3151 000 144
42100535	1878 085 741	42103321	1862 317 031	500054879	3400 700 637
42100536	1878 054 951	42104476	3151 000 144	500055527	3400 700 646
42100536	1878 054 951	42104648	3482 078 134	500055538	3400 700 653
42100537	1878 085 741	42104649	1862 317 032	500055597	3400 700 436
42100538	1861 992 432	42104709	1861 874 032	500055598	3400 700 608
42100538	1878 004 456	42104793	1878 085 741	500055599	3400 700 607
42100566	1878 003 661	42104820	1888 063 137	500055600	3400 700 606
42100567	1878 002 955	42104821	1862 304 033	500059740	3400 042 031
42100571	1878 002 955	42104821	1862 304 033	500059754	1878 002 825
42100576	1878 002 955	42104983	1878 085 741	500059754	3151 000 144
42100579	1878 085 742	42104991	1862 317 031	500059754	3482 083 113
42101773	1878 022 841	42112970	1862 317 032	500059758	3400 700 487
42101774	1861 992 432	42114018	3482 125 131	500059762	3400 084 031
42101774	1878 004 456	42114181	1878 001 138	500059764	3400 700 312
42101943	3482 125 131	42114182	1878 002 955	500059766	3400 117 801
42101943/U-E	3482 125 131	42114261	3482 078 132	500059768	1878 003 767
42101943/U-S	3482 125 131	42114261	3482 078 134	500059768	3151 000 144
42102091	1878 085 741	42114261	3482 078 134	500059768	3482 083 032
42102093	1878 054 951	42114262	3482 078 134	500059770	1878 004 133
42102093	1878 054 951	42114329	3482 085 033	500059770	3151 000 144
42102095	1878 054 951	42114448	1878 032 032	500059770	3482 083 032
42102095	1878 054 951	42114571	3482 078 134	500059772	3400 700 377
42102097	3482 083 032	42114680	1878 085 741	500059774	3400 700 378
42102099	3482 083 032	42114756	3482 078 134	500059776	1878 004 132
42102103	3151 000 144	42114856	3151 000 144	500059776	3151 000 144
42102104	1878 054 951	42159124	1861 777 037	500059776	3482 000 572
42102104	1878 054 951	42489672	3151 032 341	500059778	1878 002 825
42102146	1861 577 136	42532400	3482 124 531	500059778	3151 000 144
42102146	1861 577 136	42532401	3482 124 541	500059778	3400 700 461
42102147	1861 577 037	42532403	3482 124 532	500059778	3482 083 113
42102148	1861 653 132	42532404	3482 124 534	500059780	3400 700 378
42102149	1861 600 033	42532405	3482 124 533	500059786	3400 700 469
42102150	1861 577 136	42532406	3482 124 550	500059788	3400 700 366
42102151	1861 874 032	42532408	3482 124 516	5001844880	3400 700 630
42102151/U-E	1861 874 032	42532409	3482 085 033	5001854041	3189 600 004
42102151/V-E	1861 874 032	42532411	3482 125 131	500292646	1878 054 951
42102151/V-S	1861 874 032	42535597	3483 000 510	500301459	1878 085 741
42102152	1878 001 077	42536129	3483 000 509	500301459EZ	1878 085 741
42102152/U-E	1878 001 077	42536130	3483 000 509	500305439	3151 000 144
42102153	1861 742 032	42536131	3483 000 509	500317617	3151 000 144
42102154	1878 001 074	42536464	1878 051 801	500317671	3151 000 144
42102155	1878 001 070	42537411	3189 600 004	500317871	1878 032 032
42102157	1861 742 032	42543362	3151 000 144	500324215	1878 002 072
42102160	1878 001 152	42548067	1878 054 951	500335045	3400 074 031
42102161	1861 351 342	4255 0296	3981 000 093	500335046	3400 074 031
42102163	1878 000 104	42556650	3151 000 144	500335050	3400 107 031
42102167	1878 007 339	42558126	3189 600 044	500335051	3400 107 031
42102168	1862 317 031	42560978	3189 600 045	500335052	3400 107 031
42102169	1878 003 274	42568861	3189 600 014	500335056	3400 077 071
42102171	1878 001 154	4303053	1878 002 825	500335057	3400 077 071
42102172	1861 643 134	4303053	3151 000 144	500335062	3400 084 031
42102172	1861 643 134	4303053	3482 083 113	500335063	3400 084 031
42102173	1878 002 706	4699160	3482 085 033	500335064	3400 084 031
42102175	1878 634 017	4725802	3151 071 032	500335067	3400 084 031
42102177	1878 085 741	4727742	3151 098 031	500335068	3151 000 144
42102316	3151 207 031	4770205	3151 117 031	500335096	3400 700 313
42102413	1878 001 138	500000874	3151 145 101	500335098	3400 700 312
42102942	3482 083 113	500001619	1862 438 032	500335101	3400 700 312
42102947	3482 083 032	500001619	1862 438 032	500335105	3400 117 801

Vergleichsliste / Cross reference list

Vergleichs-Nr. Compare No.	Artikelnummer Article No.	Vergleichs-Nr. Compare No.	Artikelnummer Article No.	Vergleichs-Nr. Compare No.	Artikelnummer Article No.
IVECO		IVECO		IVECO	
500335106	3400 117 801	504084401	6594 000 054	504285998	3400 700 469
500335107	3400 117 801	504100901	6594 000 120	504286000	3400 700 366
500358237	1878 000 611	504101334	3400 700 514	504294640	3151 000 651
500358239	1862 310 132	504118531	3400 700 515	504336615	1878 003 767
500358295	3400 074 031	504118580	3400 700 633	504336617	1878 085 741
500365787	3400 700 430	504120865	3151 000 144	504336621	1878 004 133
500370064	3400 700 452	504122591	3400 700 432	504385079	3151 000 144
500370077	3400 700 431	504129664	3400 700 646	504385080	3151 000 493
500370082	3400 700 431	504130776	3400 700 430	504389742	3482 000 419
500370084	3400 700 452	504132388	3151 600 529	504389743	3482 000 474
500370316	3400 700 452	504147553	3400 700 430	5107-52-01.04	1881 010 139
500371281	3400 117 801	504148900	3400 700 377	5107520180	3151 045 001
500371282	3400 117 801	504148901	1878 004 133	51575202910	1863 101 100
500371283	3400 117 801	504148901	3151 000 144	5177521851	1863 010 100
500372079	1878 085 741	504148901	3400 700 378	5801550547	1878 032 032
500372081	1878 085 741	504148901	3482 000 573	5801555056	3400 700 436
500372083	1878 085 741	504148902	3400 700 378	5801555058	1878 004 100
500375057	1878 004 133	504148904	3400 700 462	5801558431	1878 004 581
500376219	3400 117 801	504148905	3400 700 461	5801596470	3400 700 653
500392642	3400 700 455	504148906	3400 700 461	5801596474	3400 700 653
500392643	3400 700 455	504149340	1878 004 581	58016 26185	3400 700 606
500392645	1878 054 951	504149343	1878 004 133	58016 26186	3400 700 608
500392646	1878 054 951	504149346	1878 004 582	5801639884	1878 007 250
500392648	1878 054 951	504149351	1878 004 132	5801641006	3400 700 646
500392654	3400 700 455	504149354	1878 004 132	5801689822	3482 001 174
500392828	3400 107 031	504149357	3482 000 628	58017 29653	3400 700 607
500392839	3400 084 031	504149359	3482 000 572	5801702427	6594 000 211
500392840	3400 084 031	504149361	3151 000 651	5801712140	1878 004 132
500392841	3400 084 031	504158912	3151 000 144	5801718344	3482 000 573
500392843	3400 084 031	504171014	3482 000 573	5801718344	3482 083 040
500392868	1878 032 032	504197817	1878 004 133	5801720105	1878 054 933
500392872	1878 032 032	504213751	1878 004 584	5801729658	1878 079 306
500397755	3151 000 144	504213752	3482 000 474	5801738722	1878 004 133
5006021441	3189 600 053	504213753	3151 000 515	61146202	1850 480 049
5006172137	3400 700 633	504213792	3482 000 474	61146225	3482 038 031
5006172148	3151 250 231	504221984	3400 700 378	61146230	1850 480 049
5006172148	3400 700 633	504221985	3400 700 462	61146808	1882 325 134
500697757	3482 083 032	504222037	1878 004 133	61146802	1882 307 131
5010244421	1878 001 145	504222042	3151 000 144	61146805	1881 039 532
503138923	3151 000 493	504225011	3400 700 461	61146812	3482 085 033
50317871	1878 032 032	504225016	1878 004 132	61146812	3482 085 033
504004160	3400 117 801	504225031	3400 700 378	61146815	3482 085 033
504018317	1878 085 741	504225034	1878 004 133	61146818	3482 124 531
504029031	1878 002 825	504225038	3400 700 378	61146822	3482 124 533
504029031	1878 080 034	504225051	3400 700 461	61146825	3482 085 033
504034992	3151 000 419	504229168	3482 000 419	61146834	3482 124 534
504034993	1878 000 036	504229170	1878 079 331	61146842	3483 020 034
504039135	1878 000 036	504229179	3151 000 515	61146844	3483 010 138
504039135	3151 000 419	504229188	3151 000 515	61146846	3483 010 137
504039135	3482 123 839	504229574	1878 004 133	61146848	3483 020 035
50403994	3482 123 839	504237890	3400 700 365	61146862	3483 020 034
50404993	1878 000 036	504237892	3400 700 366	61146864	3482 085 033
504059764	3400 700 433	504237895	3151 000 493	61146866	3483 010 138
504061486	3400 700 433	504241882	6594 000 054	61146868	3483 010 137
504064953	3400 117 801	504256058	1878 004 133	61146870	3483 020 035
504064954	1878 085 741	504256059	1878 004 132	6140160310	1881 065 101
504068259	1878 085 741	504262566	3400 700 514	6141160410	1881 065 101
504068261	3400 117 801	504262569	3400 700 515	61606904	3482 905 001
504068265	3400 117 801	504264336	3400 700 378	61751945	1882 325 134
504073840	1878 002 072	504264337	3400 700 366	624516	1878 003 277
504080319	3400 700 433	504285997	3400 700 365	632100420	3151 000 515

Vergleichsliste / Cross reference list

Vergleichs-Nr. Compare No.	Artikelnummer Article No.
-------------------------------	------------------------------

IVECO

7138962	3482 000 953
7138964	3151 000 374
77028180	1850 480 049
77028185	1862 977 001
77040185	1878 600 834
77097010	1878 600 841
77097510	1878 600 841
77414510	1878 600 834
77414520	1878 600 834
775549	1878 022 841
775550	1878 003 276
775551	1861 902 032
81584007	3482 038 031
81705961	1878 600 841
85000266	3483 034 042
86021252	3482 008 033
86021253	3482 008 033
86021255	3482 038 031
86021261	1861 577 136
8739-44-01.05	1863 600 125
8739-44-01.50	1863 009 100
8739-44-02.11	1805 042 000
8739-44-02.50	1859 600 001
8739-44-05.10	1863 600 123
8739-44-05.30	1863 010 100
8739-44-05.60	1863 009 100
8739-47-06.40	1881 010 139
8739-47-07.10	1880 083 132
8739-47-08.10	1880 083 132
8739-47-10.30	1880 092 415
8739-47-13.10	1881 039 532
8739-47-21.10	1882 325 134
8739-47-24.10	1881 065 101
8739-47-50.30	1864 202 035
8739-47-50.310	1861 034 147
8739-47-50.45	1864 202 035
8739-47-50.540	1864 634 023
8751-52-01.30	1880 083 132
8751-52-11.03	1861 034 147
8751-52-11.35	1861 034 147
8751-52-12.04	1861 600 033
8751-52-12.23	1863 101 100
8751-52-51.35	1878 001 074
8751-52-51.36	1881 039 532
8751-52-51.55	1878 001 074
8751-52-51.64	1881 039 532
8751-52-51.65	1881 039 532
8751-52-51.92	1882 325 134
93160284	3151 032 341
93161755	3496 006 000
93161931	3496 006 000
93162073	3496 006 000
93800282	3151 065 031
93800287	3151 065 031
93801198	1862 977 001
93801199	1850 480 049
93801297	3482 907 001
93801299	1862 967 001
93806524	1862 977 001
93806525	1850 480 049
93806822	3151 065 031

Vergleichs-Nr. Compare No.	Artikelnummer Article No.
-------------------------------	------------------------------

IVECO

93807195	1862 977 001
93807441	1862 977 001
93808387	3151 065 031
93808506	1850 480 049
93808507	1862 967 001
93808508	3482 907 001
93808930	3482 907 001
93809013	3482 907 001
93811556	1862 967 001
93811557	1862 977 001
93812451	3482 998 701
93812486	3083 039 031
93812487	1878 002 072
93812488	3151 600 529
93812489	3083 039 031
93812506	3151 600 529
93812507	1878 997 101
93812508	3482 998 701
93812511	3083 039 031
94459823	1878 002 955
96062916	1878 054 951
96062916	1878 054 951
98400175	3151 600 544
98400707	1878 000 611
98400708	3482 094 031
98400713	3482 094 031
98400715	3151 600 544
98400717	1878 000 611
98400721	3151 600 544
98400724	1862 310 132
98400725	3482 093 031
98400726	3482 093 031
98400727	1862 310 132
98401893	1878 074 841
98401894	3400 066 031
98401896	3482 092 031
98402393	3151 600 544
98403096	3482 092 031
98406605	1878 007 339
98406607	1862 310 132
98417693	1878 000 611
98419240	1878 074 841
98434871	3151 600 544
98435802	1878 054 951
98435802	1878 054 951
98435804	1878 085 741
98435975	1878 054 951
98435975	1878 054 951
98435977	1878 085 741
98436139	1878 032 032
98436141	1878 032 032
98436159	1862 317 032
98436188	3151 000 144
98448583	1878 997 101
98453282	3483 020 034
98453284	3483 020 034
98460675	1878 002 072
98469384	1878 000 611
98469386	1878 000 611
98471635	1878 002 072
98471635	3000 951 026

Vergleichs-Nr. Compare No.	Artikelnummer Article No.
-------------------------------	------------------------------

IVECO

98471635	3083 039 031
98471635	3151 600 529
98471641	3400 117 701
98471686	1878 002 072
98471689	1878 002 072
98471692	1878 997 101
98481323	1878 074 841
98481325	1878 074 841
98481328	1878 074 841
98481328	1878 074 841
98484662	1861 992 432
98484662	1878 004 456
98484664	1878 085 741
98486125	3400 700 449
98486127	3400 700 449
98490360	1878 074 841
98495987	1878 007 339
98495997	1862 317 031
98495998	1862 317 032
98496005	1878 054 951
98496005	1878 054 951
98496006	1878 085 741
98496859	1878 074 841
98496861	1878 000 611
98499254	1862 317 032
98499256	1878 032 032
99430261	1878 007 339
99430262	1862 317 031
99430263	1862 317 032
99430265	1878 032 032
99434788	1862 310 132
99445713	1878 085 741
99445716	1878 054 951
99445716	1878 054 951
99449837	3482 078 134
99453752	1878 085 741
99453753	1878 054 951
99453753	1878 054 951
99463434	1878 054 951
99463435	1878 085 741
99473296	3482 998 701

KÄSSBOHRER

000 250 63 04	1882 201 132
003 250 88 04	3482 124 522
003 250 98 04	3482 008 038
005 250 19 04	3482 124 522
005 250 90 04	1882 342 134
007 250 13 03	1878 001 136
017 250 87 03	1878 080 034
8.383.000.133.0	3130 010 100
8.383.000.246	1878 005 486
8.383.000.246.0	1878 005 486
8.383.022.000	1882 110 532
8.383.067.000	1881 041 656
8.383.067.000	1881 041 656
8.383.121.000	1881 039 531
8.383.130.000	1862 088 131
8.383.130.000	1862 088 131
8.383.131.000	3151 021 001
8.383.145.000	1878 003 320

Vergleichsliste / Cross reference list

Vergleichs-Nr. Compare No.	Artikelnummer Article No.
KÄSSBOHRER	
8.383.146.000	1882 301 239
8.383.146.000 C	1882 301 239
8.383.155.000	1882 252 331
8.383.156.000	1861 303 248
8.383.186.000	3151 027 102
8.383.186.000 D	3151 027 102
8.383.189.000	3151 000 515
8.383.192.000	1882 302 131
8.383.192.000 C	1882 302 131
8.383.195.000	1861 923 032
8.383.195.000	1878 001 152
8.383.195.000	1878 001 152
8.383.195.000 C	1878 001 152
8.383.203.000	1878 001 152
8.383.210.000	1861 571 110
8.383.211.000	3482 012 211
8.383.211.000	3482 012 211
8.383.211.000 C	3482 012 211
8.383.212.000	3151 099 101
8.383.212.000 D	3151 099 101
8.383.219.000	1882 342 134
8.383.219.000	1882 342 134
8.383.219.000 C	1882 342 134
8.383.220.000	1861 571 110
8.383.220.000 C	1861 571 110
8.383.224.000	1888 042 009
8.383.224.000 C	1888 042 009
8.383.225.000	1878 000 968
8.383.225.000 D	1878 000 968
8.383.226.185	3151 108 031
8.383.234.000	3482 006 036
8.383.243.000	1861 911 232
8.383.244.000	1882 342 134
8.383.248.000	3151 108 031
8.383.254.000	3482 083 113
8.383.254.000 B	3482 081 231
8.383.261.000	1861 571 110
8.383.262.000	1878 000 968
8.383.263.000	1861 911 232
8.383.263.000.0	1861 911 232
8.383.263.000.2	1861 911 232
8.383.264.000	1888 042 009
8.383.265.000	1878 001 152
8.383.265.000.2	1878 001 152
8.383.267.000	1878 005 668
8.383.268.000	3482 081 232
8.383.268.000	3482 081 232
8.383.268.000 B	3482 081 232
8.383.269.000	1861 874 032
8.383.271.000	3151 027 133
8.383.275.000	1861 303 248
8.383.275.000.0	1861 303 248
8.383.276.000	1878 001 070
8.383.280.000	3488 017 432
8.383.280.000.0	3488 017 432
8.383.281.000	1878 005 805
8.383.281.000	1878 634 022
8.383.282.000	3151 000 547
8.383.282.000 C	3151 000 547
8.383.286.000	1878 080 037
8.383.292.000	3482 083 032

Vergleichs-Nr. Compare No.	Artikelnummer Article No.
KÄSSBOHRER	
8.383.292.000	3482 083 032
8.383.292.000 B	3482 083 032
8.383.295.000	1878 085 742
8.383.299.000	1878 085 742
8.383.310.000	1878 085 742
8.383.318.000	3482 083 032
8.383.319.000	3482 081 232
8.383.321.000	1878 080 033
8.383.321.000 C	1878 080 033
8.383.324.000	1878 065 131
8.383.327.000	1882 342 135
8.383.327.000.2	1882 342 135
8.383.328.000	3482 062 035
8.383.328.000	3482 083 252
8.383.330.000	1878 085 641
8.383.330.000	1878 085 641
8.383.333.000	3151 000 615
8.383.334.000	3488 017 410
8.383.334.000.2	3488 017 410
8.383.335.000	1878 005 805
8.383.335.000	1878 634 022
8.383.335.000.2	1878 005 805
8.383.335.000.2	1878 634 022
8.383.336.000	1878 080 034
8.383.336.000	1878 080 034
8.383.336.000 C	1878 080 034
8.383.336.000 C	1878 080 034
8.383.339.000	3482 083 113
8.383.340.000	3482 083 034
8.383.343.000	3482 081 231
8.383.344.000	3482 081 233
8.383.350.000	1878 080 034
8.383.350.000	1878 080 034
8.389.335.000	1878 005 805
8.389.335.000	1878 634 022
KING LONG	
216200030	3482 124 549
216200070	3482 083 118
216200110	3482 083 032
216200160	3482 000 463
216200260	3482 124 550
216300030	1878 026 241
216300080	1878 007 103
216300120	1878 004 832
216300160	1878 000 294
216700010	3151 000 157
216700020	3151 000 395
6137Y-F760-1601105	3482 083 113
6137Y-F760-1601110	1878 080 034
6900Y-BK60-1601110	1878 000 294
6900Y-BK60-1601120	3482 000 463
LIEBHERR	
1000-3465	1866 157 101
1001-6633	1866 000 007
1001-6872	1866 157 103
1002-2829	1866 000 021
1010-0069	1866 000 062
1011-6024	1866 000 151
1013-6818	1866 000 007
1022-1026	1866 000 152

Vergleichs-Nr. Compare No.	Artikelnummer Article No.
LIEBHERR	
1022-8100	1866 000 079
1028-8617	1878 004 832
1033-2556	3482 000 546
1049-2338	3151 000 493
1087-3323	3189 600 004
5006-801	1866 136 001
5007-636	1866 138 101
5009-663	1866 156 001
5030-103	1881 010 139
5030-103	3151 045 001
5030-105	1878 000 105
5030-105	1882 302 131
5030-106	1881 010 139
5030-107	1878 000 967
5030-109	1882 234 433
5030-114	1881 010 139
5030-166	1878 000 967
5030-166	3151 000 515
5030-25408	3488 017 447
5031-005	1864 202 035
5031-100	1880 083 132
5031-118	1881 010 139
5031-18308	3482 083 118
5031-18408	3151 000 034
5031-18708	3482 000 209
5031-18808	3482 000 246
5031-301	1881 010 139
5031-316	1882 166 737
5031-316	1882 166 737
5031-317	1878 000 104
5031-319	1878 000 964
5031-32608	3151 208 001
5031-32608	3151 208 001
5031-32708	1861 224 005
5031-328	1881 010 139
5031-32808	1881 010 139
5031-329	3151 045 001
5031-32908	3151 045 001
5031-333	1878 000 967
5031-33308	1878 000 967
5031-335	1878 000 105
5031-33508	1878 000 105
5031-336	1882 302 131
5031-33608	1882 302 131
5031-338	1881 010 139
5031-34208	1878 001 070
5031-343	1878 000 961
5031-35208	1878 002 437
5031-403	1881 010 139
5602-880	1866 065 001
5603-810	1866 090 001
5607-974	1866 000 332
5608-138	1866 000 337
5608-851	1866 148 001
5611-081	1866 148 001
5718-00008	3189 600 004
MAGIRUS-DEUTZ	
K18036	1863 600 125
01260096	1878 001 074
01260500	1881 039 532

Vergleichsliste / Cross reference list

Vergleichs-Nr. Compare No.	Artikelnummer Article No.
-------------------------------	------------------------------

MAGIRUS-DEUTZ

01260603	1880 083 132
01260638	1881 039 532
01261333	1882 325 134
01261902	1878 000 957
01262431	1882 325 134
01266448	1881 010 139
01266475	1880 083 132
01266503	1881 039 532
01266566	1882 325 134
01266638	1861 034 147
0127 1770 /U-E	1880 083 132
0127 2047 /U-E	1881 039 532
01271770	1880 083 132
01271852	1881 041 656
01271879	1861 034 147
01271885	1861 600 033
01271887	1863 600 125
01271897	1861 600 033
01271900/U-E	1863 010 100
01271902/U-E	1863 101 100
01271976	1881 041 656
01271999	1878 000 104
01272035	1881 039 532
01272040	1881 039 532
01272042	1881 039 532
01272047	1881 039 532
01272048	1881 039 532
01278622	1882 325 134
01278624	1878 000 104
01903816	1878 000 957
01903816	1882 325 139
01903836	1878 002 955
01903836	3482 085 033
01903837	1861 992 432
01903837	1878 004 456
01903837	3400 700 454
01903837	3483 010 138
01903838	1878 022 841
01903838	3400 700 457
01903838	3483 010 137
01903843	3482 038 031
01903845	1878 002 955
01903845	3482 085 033
01903846	3483 020 034
01903847	1861 653 132
01903847	3482 008 033
01903848	1881 039 532
01903849	1881 039 532
01903850	1878 001 074
01903850	1881 039 532
01903853	1878 634 017
01903853	3482 124 522
01903854	1878 001 070
01903854	1882 307 131
01903855	1878 001 074
01903855	1882 307 131
01903859	1878 634 017
01903859	3482 124 541
01903860	1878 001 070
01903860	3482 002 234
01903862	1878 002 955

Vergleichs-Nr. Compare No.	Artikelnummer Article No.
-------------------------------	------------------------------

MAGIRUS-DEUTZ

01903865	1878 002 955
01903866	1878 634 017
01903866	3482 124 534
01903867	1878 634 017
01903867	3482 124 534
01903868	3482 124 534
01903870	1878 634 017
01903870	3482 124 541
01903871	1878 001 152
01903871	1882 325 139
01903872	1878 000 957
01903872	1882 325 134
01903873	1878 000 104
01903873	1882 325 134
01903874	1878 000 957
01903874	1882 325 134
01903875	1882 325 134
01903876	1878 001 152
01903876	1882 325 134
01903877	1878 000 957
01903877	1882 325 134
01903878	1882 325 134
01903879	1878 002 955
01903879	3482 124 532
01903881	1878 002 955
01903881	3482 124 533
01903882	3482 124 533
01903883	1878 003 657
01903883	3482 124 533
01903884	1878 001 138
01903884	3482 124 532
01903885	1878 003 657
01903885	3482 124 532
01903886	1878 002 955
01903886	1882 316 035
01903886	3482 124 531
01903886	3482 124 531
01903887	1878 001 138
01903887	1882 316 035
01903887	3482 124 531
01903887	3482 124 531
01903888	1878 003 657
01903888	1882 316 035
01903888	3482 124 531
01903888	3482 124 531
01903890	1861 874 032
01903890	3482 012 211
01903890	3482 012 211
01903891	3400 042 031
01903893	1878 002 706
01903893	3482 124 534
01903894	1861 577 136
01903894	3482 008 036
01903896	3482 038 031
01903897	1878 001 077
01903897	3482 002 234
01903900	1878 000 957
01903900	1882 325 139
01903903	3482 008 033
01903911	1878 002 955
01903911	3482 085 033

Vergleichs-Nr. Compare No.	Artikelnummer Article No.
-------------------------------	------------------------------

MAGIRUS-DEUTZ

01903912	1878 085 742
01903912	3483 020 034
01903921	3483 020 034
01903924	1878 002 955
01903924	3482 085 033
01903924	3482 085 033
01903925	1878 000 957
01903925	1882 325 139
01903927	1861 577 037
01903927	3482 008 033
01903928	1861 577 136
01903928	3482 008 036
01903929	1878 634 017
01903929	3482 124 522
01903930	1878 634 017
01903930	3482 124 541
01903931	1878 634 017
01903931	3482 124 534
01903932	1878 634 017
01903932	3482 124 541
01903934	1861 653 132
01903934	3482 008 033
01903936	1878 001 138
01903936	1882 316 035
01903936	3151 000 515
01903936	3482 124 531
01903936	3482 124 531
01903937	1878 001 138
01903937	3482 124 532
01903938	1878 001 138
01903938	3482 124 533
01903939	1878 001 138
01903940	1878 001 138
01903940	3482 124 534
01903941	1878 001 138
01903944	1878 022 841
01903944	3483 020 035
01903946	1878 001 152
01903946	1882 325 134
01903947	1878 001 152
01903947	1882 325 139
01903948	1878 001 074
01903948	1881 039 532
01903949	1878 001 074
01903949	1882 307 131
01903950	1861 351 342
01903950	1882 325 134
01903952	1861 351 342
01903952	1882 325 134
01903953	1878 001 070
01903953	1882 307 131
01903954	1878 001 070
01903954	3482 002 234
01903955	1881 039 532
01903956	1878 000 104
01903956	1882 325 134
01903957	1878 001 154
01903957	3482 124 532
01903958	1878 003 657
01903958	3482 124 532
01903959	1878 003 657

Vergleichsliste / Cross reference list

Vergleichs-Nr. Compare No.	Artikelnummer Article No.
-------------------------------	------------------------------

MAGIRUS-DEUTZ

01903959	1882 316 035
01903959	3482 124 531
01903959	3482 124 531
01904700	1878 001 154
01904700	1882 316 035
01904700	3482 124 531
01904700	3482 124 531
01904701	1861 742 032
01904701	3482 038 031
01904702	1878 002 706
01904702	3482 124 534
01904703	1878 001 077
01904703	3482 002 234
01904705	1861 874 032
01904705	3482 012 211
01904705	3482 012 211
01904713	1878 000 957
01904713	1882 325 134
01904714	1878 000 957
01904714	1882 325 134
01904715	1878 000 957
01904715	1882 325 134
01904716	1878 000 957
01904716	1882 325 134
01904717	1878 000 957
01904717	1882 325 139
01904719	1861 742 032
01904719	3482 038 031
01904725	3400 042 031
01904729	1878 085 741
01904729	3483 020 035
01904730	1878 054 951
01904730	1878 054 951
01904730	3483 020 035
01904734	1878 600 841
01904735	1878 600 841
01904758	1861 653 132
01904759	1861 577 037
01904761	1878 002 955
01904761	3151 207 031
01904761	3482 085 033
01904762	1878 002 955
01904762	3151 207 031
01904762	3400 118 901
01904763	1878 002 955
01904763	3400 042 031
01904772	1861 874 032
01904772	3482 012 211
01904772	3482 012 211
01904777	1878 001 154
01904777	3482 085 033
01904777	3482 085 033
01904790	1878 054 951
01904790	3400 700 454
01904790	3483 020 035
01904791	1878 634 020
01904791	3482 124 532
01904793	3400 042 031
01905728	3400 042 031
01905840	1878 054 951
01905840	1878 054 951

Vergleichs-Nr. Compare No.	Artikelnummer Article No.
-------------------------------	------------------------------

MAGIRUS-DEUTZ

01905840	3483 020 034
02242543	1861 600 033
02440923	1863 101 100
02442309	1881 041 656
02442543	1861 600 033
02442544	1861 600 033
02442545/U-E	1880 092 415
02442557	1878 000 104
02442558	1878 000 104
02443133	3151 000 515
02443712	1861 351 342
02474844	1882 261 013
02475334	1878 634 017
02475546	3151 199 001
02475547	3151 199 001
02475629	3151 000 515
02476063	3482 060 233
02476073	1882 307 131
02476075	1878 001 074
02476483	3482 124 522
02477136	1878 000 957
02477181	1878 634 017
02477328	1882 307 131
02477896	1878 634 017
02477897	1878 002 955
02477898	1882 325 134
02477926	1878 000 957
02477929	1878 000 957
02477930	1878 000 104
02477936	1878 001 074
02478592	1878 001 152
02479048	3151 000 515
02479103	3482 124 534
02479104	3482 124 534
02560550	1881 010 139
02565803	3151 199 001
02984082/U-E	3163 026 100
03342363	1863 600 125
03435623	1863 010 100
0345 7510 /U-E	1881 065 101
0345 7510 /U-E	1881 065 101
03457374/U-S	1881 065 101
0347 1490 /U-E	1881 010 139
03471490	1881 010 139
03472373	1863 101 100
04371490	1881 010 139
04457823	1878 002 955
04459152	3482 124 541
04459737	3482 002 234
04459822	3482 125 131
04459823	1878 002 955
04459827	1861 577 037
04588700	3482 038 031
04626605	1882 325 134
0469 5660 /U-E	1882 325 134
04691736	1878 002 955
04692717	3482 125 131
04695659	1882 325 134
04695660	1882 325 134
04695661	1878 000 957
04699161	1878 001 138

Vergleichs-Nr. Compare No.	Artikelnummer Article No.
-------------------------------	------------------------------

MAGIRUS-DEUTZ

04724654	3151 127 031
04725802	3151 071 032
04727742	3151 098 031
04733573	3482 124 532
04733575	3482 124 533
04738961	1878 001 138
04738961	3482 085 033
04739151	1878 001 138
04741461	1878 002 955
04741464	1878 001 138
04742136	1861 992 432
04742136	1878 004 456
04742138	3100 002 038
04742138	3151 123 031
04745051	3482 125 131
04747807	3483 020 034
04749155	3482 125 131
04757088	3151 000 148
04757090	3483 020 034
04766075	1878 000 957
04769116	1878 000 957
04779155	3482 125 131
04837884	1878 001 138
04838491	3482 125 131
04839133	1878 000 957
04857270	1878 000 957
07137929	3482 125 131
08122735	3100 002 038
08122735	3151 123 031
08122736	3151 000 148
08193331	3100 002 040
08193332	3100 002 038
08438491	3482 125 131
08558284	1878 600 841
08566186	1878 600 841
08566309	1850 282 652
08568284	1878 600 841
08582397	1878 600 841
08600701	1878 600 841
2991558	3400 042 031
4200 3364 /U-E	1882 301 239
4200 3364 /U-E	3482 124 534
4200 3364 /U-S	1882 301 239
4200 3364 /U-S	3482 124 534
4200 3368 /U-E	3482 124 541
4200 3473 /U-E	3151 000 515
4200 3473 /U-S	3151 000 515
4200 3734 /U-E	1881 041 656
4200 3736 /U-E	1882 325 134
4200 3736 /U-S	1882 325 134
4200 3737 /U-E	1882 325 134
4200 3737 /U-S	1882 325 134
4200 3852 /U-E	3482 124 532
4200 3852 /U-S	3482 124 532
42003033	1882 325 134
42003325	1861 351 342
42003364	3482 124 534
42003365	3482 124 531
42003368	3482 124 541
42003396	3151 199 001
42003397	3151 199 001

Vergleichsliste / Cross reference list

Vergleichs-Nr. Compare No.	Artikelnummer Article No.
MAGIRUS-DEUTZ	
42003402	1861 653 132
42003473	3151 000 515
42003474	3151 000 515
42003545	1878 001 152
42003637	1878 001 154
42003658	3151 000 515
42003734	1881 041 656
42003736	1882 325 134
42003737	1882 325 134
42003852	3482 124 532
42006023	1861 653 132
4201 4248 /U-E	3482 124 532
4201 4399 /U-E	1882 316 035
4201 4399 /U-E	3482 124 531
4201 4399 /U-S	1882 316 035
4201 4399 /U-S	3482 124 531
42014136	3482 124 533
42014240	3482 124 532
42014399	3482 124 531
42014718	1878 000 957
42016023	1861 653 132
42016352	3482 012 211
42016352	3482 012 211
42026023	1861 653 132
42026352	3482 012 211
42026352	3482 012 211
42026354	3482 012 211
42026354	3482 012 211
42026354/KZ	3482 012 211
42026354/KZ	3482 012 211
42026355	1861 874 032
42026470	1878 001 152
42026780	3482 125 131
42026898	3151 000 515
42026899	3151 000 515
4203 7963 /U-E	3482 008 036
4203 7963 /U-S	3482 008 036
42037017	1878 003 657
42037018	1878 003 657
42037235	1861 742 032
42037237	3482 038 031
42037449	1878 001 152
42037450	1878 001 152
42037963	3482 008 036
42037964	1861 577 136
42037967	3482 008 036
4206 1545 /U-E	1882 301 238
4206 1545 /U-E	3482 124 541
4206 1545 /U-S	1882 301 238
4206 1545 /U-S	3482 124 541
4206 2100 /U-E	3483 020 034
4206 2307 /U-E	1882 325 139
4206 2307 /U-S	1882 325 139
42061357	1878 001 077
42061359	3482 002 234
42061366	3482 124 534
42061499/U-S	3482 008 038
42061545	3482 124 541
42061547	1878 002 706
42061852	3151 127 031
42061921	3151 199 001

Vergleichs-Nr. Compare No.	Artikelnummer Article No.
MAGIRUS-DEUTZ	
42061941	3483 020 035
42061964	3483 020 034
42062095	3100 002 038
42062095	3151 123 031
42062097	3151 000 148
42062099	3483 020 035
42062100	3483 020 034
42062106	3483 020 034
42062107	3483 020 035
42062184	1878 022 841
42062541	1878 003 657
42062613	1878 001 138
42063184	3151 000 515
42064572	1861 992 432
42064572	1878 004 456
42064718	1861 992 432
42064718	1878 004 456
42066352	3482 012 211
42066352	3482 012 211
42100538	1861 992 432
42100538	1878 004 456
42100567	1878 002 955
42100571	1878 002 955
42100576	1878 002 955
42101773	1878 022 841
42101774	1861 992 432
42101774	1878 004 456
42101943	3482 125 131
42102146	1861 577 136
42102147	1861 577 037
42102148	1861 653 132
42102149	1861 600 033
42102150	1861 577 136
42102152	1878 001 077
42102153	1861 742 032
42102154	1878 001 074
42102155	1878 001 070
42102157	1861 742 032
42102160	1878 001 152
42102161	1861 351 342
42102163	1878 000 104
42102171	1878 001 154
42102173	1878 002 706
42102175	1878 634 017
42102413	1878 001 138
42114018	3482 125 131
42114181	1878 001 138
42114182	1878 002 955
4248 3478 /U-E	1866 030 102
42532400	3482 124 531
42532401	3482 124 541
42532403	3482 124 532
42532404	3482 124 534
42532405	3482 124 533
42532411	3482 125 131
5107-52-01.04	1881 010 139
5107520180	3151 045 001
51575202910	1863 101 100
5177521851	1863 010 100
61146225	3482 038 031
61146808	1882 325 134

Vergleichs-Nr. Compare No.	Artikelnummer Article No.
MAGIRUS-DEUTZ	
61146802	1882 307 131
61146805	1881 039 532
61146818	3482 124 531
61146822	3482 124 533
61146834	3482 124 534
61146842	3483 020 034
61146848	3483 020 035
61146862	3483 020 034
61146870	3483 020 035
61751945	1882 325 134
77097010	1878 600 841
77097510	1878 600 841
81584007	3482 038 031
81705961	1878 600 841
8602 1252 /U-E	3482 008 033
8602 1252 /U-S	3482 008 033
86021252	3482 008 033
86021253	3482 008 033
86021255	3482 038 031
86021261	1861 577 136
8739-44-01.05	1863 600 125
8739-44-05.30	1863 010 100
8739-47-06.40	1881 010 139
8739-47-07.10	1880 083 132
8739-47-08.10	1880 083 132
8739-47-13.10	1881 039 532
8739-47-21.10	1882 325 134
8739-47-50.310	1861 034 147
8751-52-01.30	1880 083 132
8751-52-11.03	1861 034 147
8751-52-11.35	1861 034 147
8751-52-12.04	1861 600 033
8751-52-51.35	1878 001 074
8751-52-51.36	1881 039 532
8751-52-51.55	1878 001 074
8751-52-51.64	1881 039 532
8751-52-51.65	1881 039 532
8751-52-51.92	1882 325 134
9380 0287 /U-E	3151 065 031
94459823	1878 002 955
98453282	3483 020 034
98453284	3483 020 034
98484662	1861 992 432
98484662	1878 004 456
MAN	
N1.01401-1503	3189 600 053
VA.30000.9434	3400 122 201
VA.30000.9866	3400 127 401
VA.30000.9876	3400 700 402
06.01284.3318	3189 600 020
06.01284.3350	3189 600 004
32.30305.0027	3482 000 819
36.30301.0003	1878 085 742
36.30301.0010	1878 002 706
36.30550.0001	3151 000 144
36.30550.0003	3151 000 157
50.12210.20	6482 000 216
51.02301.6044	6594 000 124
51.02301.6086	6594 000 121
51.02301.9044	6594 000 124

Vergleichsliste / Cross reference list

Vergleichs-Nr. Compare No.	Artikelnummer Article No.
-------------------------------	------------------------------

MAN

51.02301.9086	6594 000 121
51.93410.0029	1863 869 028
51.93410.0029	1863 869 028
51.93410.0143	1863 869 038
51.93410.0149	1863 869 042
64.30500.001	3151 000 151
64.30560-5001	3189 600 053
81.30000.6336	1878 001 144
81.30000.6336	1878 001 147
81.30000.6336	1882 209 335
81.30000.6336	3151 000 958
81.30000.6532	3400 121 701
81.30000.6557	3400 121 901
81.30000.6572	3400 700 404
81.30000.6577	3400 700 402
81.30000.6579	3400 700 403
81.30000.6581	3400 127 401
81.30000.6582	3400 127 401
81.30000.6587	1878 080 031
81.30000.6587	3151 000 034
81.30000.6587	3482 083 032
81.30000.6592	3400 700 404
81.30000.6593	3400 700 402
81.30000.6600	1878 080 031
81.30000.6600	3151 000 034
81.30000.6600	3482 083 032
81.30000.6601	1878 080 033
81.30000.6601	3482 083 032
81.30000.6602	1878 080 034
81.30000.6602	3482 083 032
81.30000.6606	3400 700 403
81.30000.6616	1878 002 643
81.30000.6616	3151 262 031
81.30000.6616	3488 017 447
81.30000.6617	3400 127 401
81.30000.6620	3400 700 460
81.30000.6621	3400 700 402
81.30000.6628	3400 700 403
81.30000.6630	3400 127 401
81.30000.6634	3400 700 402
81.30000.6635	3400 700 460
81.30000.6640	3400 700 506
81.30000.6641	3400 700 512
81.30000.6642	3400 700 511
81.30000.6650	3400 127 401
81.30000.6653	3400 127 401
81.30000.6654	3400 127 401
81.30000.6657	3400 700 403
81.30000.6673	3400 127 401
81.30000.7220	1878 002 643
81.30000.7220	3151 262 031
81.30000.7220	3488 017 447
81.30000.9336	1878 001 144
81.30000.9336	1878 001 147
81.30005.0005	3400 700 412
81.30005.9001	3400 125 801
81.30005.9003	3400 710 001
81.30005.9005	3400 700 412
81.30005.9006	3400 121 701
81.30005.9007	3400 127 601
81.30005.9008	3400 127 601

Vergleichs-Nr. Compare No.	Artikelnummer Article No.
-------------------------------	------------------------------

MAN

81.30005.9009	3400 127 601
81.30005.9010	3400 127 601
81.30005.9012	3400 122 201
81.30005.9013	3400 122 201
81.30005.9016	3400 122 301
81.30005.9018	3400 122 201
81.30005.9019	3400 700 327
81.30005.9020	3400 122 201
81.30005.9021	3400 122 201
81.30005.9022	3400 127 401
81.30005.9023	3400 700 380
81.30005.9024	3400 710 002
81.30005.9025	3400 710 003
81.30005.9026	3400 700 402
81.30005.9027	3400 700 402
81.30005.9028	3400 127 401
81.30005.9029	3400 122 201
81.30005.9032	3400 700 381
81.30005.9033	3400 700 459
81.30005.9034	3400 700 380
81.30005.9035	3400 700 507
81.30005.9036	3400 700 460
81.30005.9037	3400 700 380
81.30005.9038	3400 700 460
81.30005.9039	3400 710 011
81.30300.6002	3496 006 000
81.30300.6003	3496 006 000
81.30301.0001	1878 044 631
81.30301.0031	1861 034 147
81.30301.0038	1861 206 211
81.30301.0046	1861 034 147
81.30301.0059	1861 470 234
81.30301.0060	1861 206 211
81.30301.0088	1878 000 104
81.30301.0097	1878 005 367
81.30301.0099	1878 005 367
81.30301.0104	1878 001 152
81.30301.0111	1878 001 144
81.30301.0111	1878 001 147
81.30301.0114	1878 000 967
81.30301.0116	1878 001 154
81.30301.0117	1878 001 152
81.30301.0121	1878 000 964
81.30301.0126	1878 002 955
81.30301.0128	1878 001 144
81.30301.0128	1878 001 147
81.30301.0134	1878 000 105
81.30301.0135	1878 001 079
81.30301.0149	1878 001 152
81.30301.0150	1878 000 964
81.30301.0151	1878 000 967
81.30301.0152	1878 001 144
81.30301.0152	1878 001 147
81.30301.0153	1878 001 079
81.30301.0155	1878 000 104
81.30301.0161	1878 001 071
81.30301.0163	1878 001 152
81.30301.0166	1878 000 967
81.30301.0169	1878 000 964
81.30301.0170	1861 841 132
81.30301.0171	1861 841 132

Vergleichs-Nr. Compare No.	Artikelnummer Article No.
-------------------------------	------------------------------

MAN

81.30301.0176	1862 219 031
81.30301.0180	1878 001 152
81.30301.0181	1861 749 132
81.30301.0182	1861 749 132
81.30301.0183	1861 748 132
81.30301.0187	1861 206 211
81.30301.0191	1861 911 232
81.30301.0192	1861 911 232
81.30301.0193	1862 219 031
81.30301.0194	1861 841 132
81.30301.0201	1861 911 232
81.30301.0203	1861 777 037
81.30301.0206	1861 876 134
81.30301.0208	1861 911 232
81.30301.0212	1861 777 037
81.30301.0213	1878 002 706
81.30301.0217	1878 004 832
81.30301.0218	1878 004 832
81.30301.0219	1878 004 832
81.30301.0220	1878 004 832
81.30301.0222	1878 004 832
81.30301.0223	1878 004 832
81.30301.0224	1878 004 832
81.30301.0225	1878 004 832
81.30301.0228	1878 001 152
81.30301.0229	1878 001 152
81.30301.0230	1878 001 152
81.30301.0231	1878 001 152
81.30301.0232	1861 911 232
81.30301.0234	1878 000 965
81.30301.0235	1878 000 968
81.30301.0238	1862 364 133
81.30301.0238	1862 364 133
81.30301.0239	1862 364 133
81.30301.0239	1862 364 133
81.30301.0240	1862 364 133
81.30301.0240	1862 364 133
81.30301.0241	1862 364 133
81.30301.0241	1862 364 133
81.30301.0242	1862 364 031
81.30301.0243	1862 364 031
81.30301.0244	1862 364 031
81.30301.0245	1862 364 031
81.30301.0246	1861 911 232
81.30301.0247	1878 001 144
81.30301.0247	1878 001 147
81.30301.0248	1878 001 152
81.30301.0250	1861 911 232
81.30301.0252	1861 841 132
81.30301.0253	1862 219 031
81.30301.0254	1878 086 941
81.30301.0256	1878 004 832
81.30301.0257	1878 004 832
81.30301.0258	1878 004 832
81.30301.0260	1861 841 132
81.30301.0261	1862 219 031
81.30301.0262	1862 219 031
81.30301.0263	1878 000 964
81.30301.0264	1861 748 132
81.30301.0265	1878 002 955
81.30301.0266	1861 749 132

Vergleichsliste / Cross reference list

Vergleichs-Nr. Compare No.	Artikelnummer Article No.	Vergleichs-Nr. Compare No.	Artikelnummer Article No.	Vergleichs-Nr. Compare No.	Artikelnummer Article No.
MAN					
81.30301.0270	1861 876 134	81.30301.0355	1878 080 034	81.30301.0473	1878 002 139
81.30301.0277	1878 001 077	81.30301.0358	1878 061 841	81.30301.0474	1878 000 841
81.30301.0278	1878 001 077	81.30301.0360	1878 004 832	81.30301.0475	1878 044 631
81.30301.0279	1878 001 077	81.30301.0364	1878 080 034	81.30301.0476	1878 080 037
81.30301.0280	1878 001 077	81.30301.0366	1878 004 832	81.30301.0478	1878 002 139
81.30301.0283	1878 000 957	81.30301.0371	1862 364 133	81.30301.0480	1862 506 131
81.30301.0284	1878 000 957	81.30301.0372	1861 841 132	81.30301.0481	1862 506 131
81.30301.0285	1878 000 957	81.30301.0374	1878 003 657	81.30301.0488	1878 002 139
81.30301.0287	1861 577 037	81.30301.0375	1878 001 145	81.30301.0490	1878 079 331
81.30301.0287	1861 577 037	81.30301.0376	1878 080 034	81.30301.0491	1878 079 331
81.30301.0288	1861 777 037	81.30301.0377	1878 080 031	81.30301.0492	1878 079 331
81.30301.0289	1878 004 832	81.30301.0378	1862 506 131	81.30301.0497	1878 080 031
81.30301.0290	1878 001 154	81.30301.0380	1862 438 032	81.30301.0498	1878 080 031
81.30301.0291	1878 002 706	81.30301.0381	1878 080 034	81.30301.0499	1878 080 033
81.30301.0292	1878 086 741	81.30301.0382	1878 080 034	81.30301.0500	1878 080 034
81.30301.0292	1878 086 741	81.30301.0383	1878 004 832	81.30301.0501	1878 004 832
81.30301.0293	1878 001 144	81.30301.0385	1878 080 034	81.30301.0502	1878 004 832
81.30301.0293	1878 001 147	81.30301.0386	1878 080 034	81.30301.0503	1878 080 037
81.30301.0294	1861 777 037	81.30301.0388	1878 080 034	81.30301.0504	1878 634 027
81.30301.0295	1862 364 133	81.30301.0390	1878 004 832	81.30301.0505	1878 634 027
81.30301.0295	1862 364 133	81.30301.0391	1878 004 832	81.30301.0506	1878 080 037
81.30301.0299	1862 303 031	81.30301.0392	1878 002 643	81.30301.0507	1878 080 037
81.30301.0300	1862 302 031	81.30301.0393	1878 044 631	81.30301.0508	1878 002 139
81.30301.0304	1861 034 147	81.30301.0393	1878 044 631	81.30301.0509	1878 080 034
81.30301.0306	1878 005 367	81.30301.0395	1878 044 631	81.30301.0511	1878 634 027
81.30301.0307	1878 001 079	81.30301.0395	1878 044 631	81.30301.0513	1878 004 832
81.30301.0308	1878 000 964	81.30301.0407	1878 004 832	81.30301.0514	1878 080 037
81.30301.0309	1878 000 967	81.30301.0408	1878 004 832	81.30301.0516	1862 506 131
81.30301.0310	1878 001 071	81.30301.0411	1878 079 331	81.30301.0520	1878 079 331
81.30301.0313	1878 000 965	81.30301.0413	1878 080 033	81.30301.0522	1878 002 139
81.30301.0314	1878 000 968	81.30301.0416	1878 002 139	81.30301.0524	1862 506 131
81.30301.0316	1878 086 941	81.30301.0419	1878 004 832	81.30301.0525	1878 002 139
81.30301.0317	1878 086 941	81.30301.0420	1878 080 037	81.30301.0526	1878 002 139
81.30301.0318	1862 364 133	81.30301.0421	1878 080 033	81.30301.0526	1878 002 139
81.30301.0318	1862 364 133	81.30301.0421	1878 080 033	81.30301.0527	1878 002 139
81.30301.0319	1862 364 133	81.30301.0433	1862 506 131	81.30301.0529	1878 079 331
81.30301.0319	1862 364 133	81.30301.0434	1878 002 139	81.30301.0530	1878 002 139
81.30301.0320	1862 364 133	81.30301.0438	1878 080 031	81.30301.0531	1878 002 139
81.30301.0320	1862 364 133	81.30301.0438	1878 080 031	81.30301.0531	1878 002 139
81.30301.0320	1862 364 133	81.30301.0440	1878 080 034	81.30301.0533	1878 080 037
81.30301.0322	1878 004 832	81.30301.0440	1878 080 034	81.30301.0533	1878 080 037
81.30301.0322	1878 004 832	81.30301.0442	1864 510 001	81.30301.0534	1878 080 037
81.30301.0323	1878 004 832	81.30301.0442	1864 510 001	81.30301.0534	1878 080 037
81.30301.0323	1878 004 832	81.30301.0444	1878 051 801	81.30301.0538	1878 002 139
81.30301.0325	1878 004 832	81.30301.0444	1878 051 801	81.30301.0538	1878 002 139
81.30301.0325	1878 004 832	81.30301.0445	1878 002 139	81.30301.0539	1878 002 643
81.30301.0326	1878 004 832	81.30301.0445	1878 002 139	81.30301.0539	1878 002 643
81.30301.0326	1878 004 832	81.30301.0446	1878 002 139	81.30301.0545	1878 080 037
81.30301.0327	1878 004 832	81.30301.0446	1878 002 139	81.30301.0545	1878 080 037
81.30301.0327	1878 004 832	81.30301.0448	1878 002 139	81.30301.0546	1878 080 037
81.30301.0328	1862 364 031	81.30301.0448	1878 002 139	81.30301.0546	1878 080 037
81.30301.0328	1862 364 031	81.30301.0449	1878 079 331	81.30301.0547	1878 080 037
81.30301.0329	1862 364 031	81.30301.0450	1878 079 331	81.30301.0548	1878 080 037
81.30301.0337	1878 000 964	81.30301.0455	1878 000 650	81.30301.0548	1878 080 037
81.30301.0337	1878 000 964	81.30301.0455	1878 000 650	81.30301.0549	1878 080 037
81.30301.0339	1878 001 079	81.30301.0456	1878 080 031	81.30301.0556	1878 079 331
81.30301.0339	1878 001 079	81.30301.0456	1878 080 031	81.30301.0556	1878 079 331
81.30301.0340	1861 600 033	81.30301.0456	1878 080 031	81.30301.0557	1862 506 131
81.30301.0342	1878 001 154	81.30301.0457	1878 080 031	81.30301.0557	1862 506 131
81.30301.0342	1878 001 154	81.30301.0457	1878 080 031	81.30301.0558	1862 506 131
81.30301.0343	1878 002 706	81.30301.0458	1878 080 033	81.30301.0559	1878 080 037
81.30301.0343	1878 002 706	81.30301.0458	1878 080 033	81.30301.0559	1878 080 037
81.30301.0344	1878 086 741	81.30301.0459	1878 080 034	81.30301.0560	1878 004 104
81.30301.0344	1878 086 741	81.30301.0459	1878 080 034	81.30301.0560	1878 004 104
81.30301.0344	1878 086 741	81.30301.0460	1878 080 037	81.30301.0564	1878 004 104
81.30301.0346	1862 364 031	81.30301.0460	1878 080 037	81.30301.0564	1878 004 104
81.30301.0346	1862 364 031	81.30301.0461	1878 001 145	81.30301.0566	1878 002 643
81.30301.0347	1862 364 133	81.30301.0461	1878 001 145	81.30301.0566	1878 002 643
81.30301.0347	1862 364 133	81.30301.0463	1878 080 031	81.30301.0567	1878 080 037
81.30301.0350	1862 438 032	81.30301.0463	1878 080 031	81.30301.0567	1878 080 037
81.30301.0350	1862 438 032	81.30301.0464	1878 004 832	81.30301.0569	1878 004 832
81.30301.0351	1862 364 133	81.30301.0464	1878 004 832	81.30301.0569	1878 004 832
81.30301.0351	1862 364 133	81.30301.0465	1878 080 037	81.30301.0574	1878 004 832
81.30301.0351	1862 364 133	81.30301.0465	1878 080 037	81.30301.0574	1878 004 832
81.30301.0351	1862 364 133	81.30301.0466	1878 002 139	81.30301.0575	1878 002 139
81.30301.0353	1878 080 031	81.30301.0466	1878 002 139	81.30301.0575	1878 002 139
81.30301.0353	1878 080 031	81.30301.0468	1878 079 331	81.30301.0578	1878 004 832
81.30301.0354	1878 085 641	81.30301.0468	1878 079 331	81.30301.0578	1878 004 832
81.30301.0354	1878 085 641	81.30301.0469	1878 079 331	81.30301.0579	1878 080 033
81.30301.0354	1878 085 641	81.30301.0469	1878 079 331	81.30301.0579	1878 080 033
81.30301.0354	1878 085 641	81.30301.0470	1878 079 331	81.30301.0580	1878 006 713
81.30301.0354	1878 085 641	81.30301.0470	1878 079 331	81.30301.0580	1878 006 713

Vergleichsliste / Cross reference list

Vergleichs-Nr. Compare No.	Artikelnummer Article No.
-------------------------------	------------------------------

MAN

81.30301.0582	1878 080 034
81.30301.0583	1878 080 034
81.30301.0588	1878 004 832
81.30301.0589	1878 002 643
81.30301.0590	1878 004 104
81.30301.0591	1878 004 104
81.30301.0593	1878 004 104
81.30301.0595	1878 004 540
81.30301.0596	1878 004 540
81.30301.0598	1878 004 540
81.30301.0601	1862 506 131
81.30301.0611	1878 004 540
81.30301.0612	1878 004 540
81.30301.0613	1878 004 540
81.30301.0617	1878 004 104
81.30301.0622	1878 004 832
81.30301.0623	1878 080 037
81.30301.0624	1878 080 033
81.30301.0625	1878 080 034
81.30301.0626	1878 080 037
81.30301.0627	1878 004 832
81.30301.0628	1878 004 832
81.30301.0630	1878 004 104
81.30301.0632	1878 004 104
81.30301.0634	1878 004 104
81.30301.0636	1878 080 037
81.30301.0647	1878 004 540
81.30301.0648	1878 004 540
81.30301.0664	1878 001 145
81.30301.0665	1878 004 540
81.30301.0666	1878 004 540
81.30301.0669	1878 004 832
81.30301.0671	1878 007 126
81.30301.0672	1878 007 126
81.30301.0677	1878 080 037
81.30301.0679	1878 080 037
81.30301.0688	1878 007 729
81.30301.0689	1878 007 126
81.30301.0992	1878 086 741
81.30301.0992	1878 086 741
81.30301.1001	1861 876 134
81.30301.1002	1878 001 152
81.30301.1008	1878 000 964
81.30301.4485	1878 080 033
81.30301.6007	1878 005 367
81.30301.6012	1878 005 367
81.30301.6099	1878 004 832
81.30301.9001	1861 876 134
81.30301.9002	1878 001 152
81.30301.9007	1878 005 367
81.30301.9008	1878 000 964
81.30301.9012	1878 005 367
81.30301.9031	1861 034 147
81.30301.9038	1861 206 211
81.30301.9046	1861 034 147
81.30301.9059	1861 470 234
81.30301.9060	1861 206 211
81.30301.9088	1878 000 104
81.30301.9097	1878 005 367
81.30301.9099	1878 005 367
81.30301.9104	1878 001 152

Vergleichs-Nr. Compare No.	Artikelnummer Article No.
-------------------------------	------------------------------

MAN

81.30301.9111	1878 001 144
81.30301.9111	1878 001 147
81.30301.9114	1878 000 967
81.30301.9116	1878 001 154
81.30301.9117	1878 001 152
81.30301.9121	1878 000 964
81.30301.9126	1878 002 955
81.30301.9128	1878 001 144
81.30301.9128	1878 001 147
81.30301.9134	1878 000 105
81.30301.9135	1878 001 079
81.30301.9149	1878 001 152
81.30301.9150	1878 000 964
81.30301.9151	1878 000 967
81.30301.9152	1878 001 144
81.30301.9152	1878 001 147
81.30301.9153	1878 001 079
81.30301.9155	1878 000 104
81.30301.9161	1878 001 071
81.30301.9163	1878 001 152
81.30301.9166	1878 000 967
81.30301.9166	3482 083 113
81.30301.9169	1878 000 964
81.30301.9170	1861 841 132
81.30301.9171	1861 841 132
81.30301.9180	1878 001 152
81.30301.9181	1861 749 132
81.30301.9182	1861 749 132
81.30301.9183	1861 748 132
81.30301.9187	1861 206 211
81.30301.9191	1861 911 232
81.30301.9192	1861 911 232
81.30301.9194	1861 841 132
81.30301.9201	1861 911 232
81.30301.9203	1861 777 037
81.30301.9206	1861 876 134
81.30301.9208	1861 911 232
81.30301.9212	1861 777 037
81.30301.9213	1878 002 706
81.30301.9228	1878 001 152
81.30301.9229	1878 001 152
81.30301.9230	1878 001 152
81.30301.9231	1878 001 152
81.30301.9232	1861 911 232
81.30301.9234	1878 000 965
81.30301.9235	1878 000 968
81.30301.9246	1861 911 232
81.30301.9248	1878 001 152
81.30301.9250	1861 911 232
81.30301.9252	1861 841 132
81.30301.9260	1861 841 132
81.30301.9261	1862 219 031
81.30301.9263	1878 000 964
81.30301.9264	1861 748 132
81.30301.9265	1878 002 955
81.30301.9266	1861 749 132
81.30301.9270	1861 876 134
81.30301.9284	1878 000 957
81.30301.9287	1861 577 037
81.30301.9288	1861 777 037
81.30301.9290	1878 001 154

Vergleichs-Nr. Compare No.	Artikelnummer Article No.
-------------------------------	------------------------------

MAN

81.30301.9291	1878 002 706
81.30301.9292	1878 086 741
81.30301.9293	1878 001 144
81.30301.9293	1878 001 147
81.30301.9294	1861 777 037
81.30301.9304	1861 034 147
81.30301.9306	1878 005 367
81.30301.9307	1878 001 079
81.30301.9308	1878 000 964
81.30301.9309	1878 000 967
81.30301.9310	1878 001 071
81.30301.9312	1878 000 967
81.30301.9322	1878 004 832
81.30301.9325	1878 004 832
81.30301.9327	1878 004 832
81.30301.9329	1862 364 031
81.30301.9337	1878 000 964
81.30301.9339	1878 001 079
81.30301.9340	1861 600 033
81.30301.9342	1878 001 154
81.30301.9343	1878 002 706
81.30301.9344	1878 086 741
81.30301.9346	1862 364 031
81.30301.9351	1862 364 133
81.30301.9358	1878 061 841
81.30301.9360	1878 004 832
81.30301.9377	1878 080 031
81.30301.9378	1862 506 131
81.30301.9381	1878 080 034
81.30301.9386	1878 080 034
81.30301.9392	1878 002 643
81.30301.9393	1878 044 631
81.30301.9393	1878 044 631
81.30301.9413	1878 080 033
81.30301.9438	1878 080 031
81.30301.9457	1878 080 031
81.30301.9458	1878 080 033
81.30301.9465	1878 080 037
81.30301.9473	1878 002 139
81.30301.9476	1878 080 037
81.30301.9492	1878 079 331
81.30301.9499	1878 080 033
81.30301.9506	1878 080 037
81.30301.9513	1878 004 832
81.30301.9514	1878 080 037
81.30301.9516	1862 506 131
81.30301.9525	1878 002 139
81.30301.9533	1878 080 037
81.30301.9534	1878 080 037
81.30301.9547	1878 080 037
81.30301.9548	1878 080 037
81.30301.9549	1878 080 037
81.30301.9557	1862 506 131
81.30301.9566	1878 002 643
81.30301.9567	1878 080 037
81.30301.9569	1878 004 832
81.30301.9575	1878 002 139
81.30301.9579	1878 080 033
81.30301.9617	1878 004 104
81.30301.9627	1878 004 832
81.30301.9669	1878 004 832

Vergleichsliste / Cross reference list

Vergleichs-Nr. Compare No.	Artikelnummer Article No.
-------------------------------	------------------------------

MAN

81.30301.9671	1878 007 126
81.30301.9677	1878 080 037
81.30301.9679	1878 080 037
81.30301.9688	1878 007 729
81.30301.9992	1878 086 741
81.30302.0002	1859 212 000
81.30302.9002	1859 212 000
81.30305.0007	1880 083 132
81.30305.0022	1880 092 415
81.30305.0023	1882 110 542
81.30305.0029	1882 261 013
81.30305.0046	1882 302 131
81.30305.0048	3482 124 534
81.30305.0050	1888 015 523
81.30305.0053	1882 302 131
81.30305.0056	1882 209 335
81.30305.0060	1881 039 531
81.30305.0062	3482 006 036
81.30305.0062	3482 124 550
81.30305.0064	1880 092 415
81.30305.0068	3482 006 036
81.30305.0068	3482 124 550
81.30305.0075	1888 015 523
81.30305.0078	3482 124 534
81.30305.0079	1882 302 131
81.30305.0080	1881 041 656
81.30305.0081	1882 110 542
81.30305.0083	1882 330 032
81.30305.0083	3482 124 541
81.30305.0084	1882 301 239
81.30305.0084	3482 124 534
81.30305.0084	3482 124 534
81.30305.0090	3482 060 233
81.30305.0098	3482 032 331
81.30305.0099	3482 032 331
81.30305.0104	3482 102 031
81.30305.0108	1882 280 213
81.30305.0109	3482 006 036
81.30305.0109	3482 006 036
81.30305.0109	3482 124 550
81.30305.0111	3482 124 522
81.30305.0112	3482 008 110
81.30305.0113	1882 342 134
81.30305.0114	1882 346 131
81.30305.0117	1882 342 134
81.30305.0120	3482 017 033
81.30305.0121	3482 060 233
81.30305.0123	1882 346 131
81.30305.0124	1882 342 134
81.30305.0137	1882 342 135
81.30305.0137	3482 124 549
81.30305.0138	3482 083 032
81.30305.0139	3482 083 032
81.30305.0145	3482 006 036
81.30305.0145	3482 124 550
81.30305.0146	1859 212 001
81.30305.0155	3482 078 133
81.30305.0157	1882 017 131
81.30305.0158	3482 083 032
81.30305.0160	3482 102 031
81.30305.0161	3482 008 141

Vergleichs-Nr. Compare No.	Artikelnummer Article No.
-------------------------------	------------------------------

MAN

81.30305.0162	3482 060 132
81.30305.0163	3482 017 035
81.30305.0164	1888 015 346
81.30305.0165	3482 083 032
81.30305.0166	3482 083 113
81.30305.0170	1882 017 131
81.30305.0170	1882 017 131
81.30305.0172	3482 085 034
81.30305.0176	3488 017 333
81.30305.0178	3482 078 133
81.30305.0179	3482 083 032
81.30305.0180	3482 017 034
81.30305.0182	3482 083 032
81.30305.0183	3483 000 510
81.30305.0184	3482 093 032
81.30305.0186	3482 102 031
81.30305.0186	3482 102 031
81.30305.0187	3482 102 031
81.30305.0189	3482 062 035
81.30305.0189	3482 083 252
81.30305.0190	3482 086 132
81.30305.0191	3482 083 032
81.30305.0191	3482 083 032
81.30305.0192	3488 017 333
81.30305.0193	3482 083 032
81.30305.0194	3482 083 032
81.30305.0197	3482 114 031
81.30305.0198	3482 000 467
81.30305.0200	3488 017 447
81.30305.0201	3482 120 031
81.30305.0202	3483 000 509
81.30305.0206	3482 000 461
81.30305.0209	3482 000 461
81.30305.0210	3483 000 510
81.30305.0211	3482 124 534
81.30305.0213	3482 000 361
81.30305.0215	1888 015 346
81.30305.0218	3482 000 361
81.30305.0220	3482 000 361
81.30305.0221	3482 000 246
81.30305.0222	3482 000 209
81.30305.0223	3482 000 464
81.30305.0224	3482 000 461
81.30305.0225	3482 000 467
81.30305.0226	3482 114 031
81.30305.0227	3482 000 546
81.30305.0228	3488 017 447
81.30305.0229	3482 000 246
81.30305.0230	3482 000 361
81.30305.0231	3488 017 447
81.30305.0232	3482 000 461
81.30305.0233	3482 000 467
81.30305.0234	3482 000 546
81.30305.0235	3482 000 664
81.30305.0236	3482 000 679
81.30305.0239	3482 000 246
81.30305.0243	3482 001 180
81.30305.0245	1882 017 131
81.30305.0246	3482 001 145
81.30305.6007	1880 083 132
81.30305.6011	1882 302 131

Vergleichs-Nr. Compare No.	Artikelnummer Article No.
-------------------------------	------------------------------

MAN

81.30305.6014	3482 124 534
81.30305.6024	1882 330 032
81.30305.6024	3482 124 541
81.30305.6028	3482 124 534
81.30305.6053	1888 015 346
81.30305.9007	1880 083 132
81.30305.9046	1882 302 131
81.30305.9048	3482 124 534
81.30305.9050	1888 015 523
81.30305.9053	1882 302 131
81.30305.9056	1882 209 335
81.30305.9062	3482 006 036
81.30305.9062	3482 124 550
81.30305.9064	1880 092 415
81.30305.9068	3482 006 036
81.30305.9068	3482 124 550
81.30305.9075	1888 015 523
81.30305.9078	3482 124 534
81.30305.9079	1882 302 131
81.30305.9084	1882 301 239
81.30305.9084	3482 124 534
81.30305.9084	3482 124 534
81.30305.9090	3482 060 233
81.30305.9098	3482 032 331
81.30305.9099	3482 032 331
81.30305.9104	3482 102 031
81.30305.9109	3482 006 036
81.30305.9109	3482 006 036
81.30305.9109	3482 124 550
81.30305.9111	1882 301 239
81.30305.9112	3482 008 110
81.30305.9113	1882 342 134
81.30305.9115	1888 015 346
81.30305.9123	1882 346 131
81.30305.9124	1882 342 134
81.30305.9137	1882 342 135
81.30305.9146	1859 212 001
81.30305.9155	3482 078 133
81.30305.9161	3482 008 141
81.30305.9164	1888 015 346
81.30305.9178	3482 078 133
81.30305.9180	3482 017 034
81.30305.9187	3482 102 031
81.30305.9191	3482 083 032
81.30305.9193	3482 083 032
81.30305.9194	3482 083 032
81.30305.9198	3482 000 467
81.30305.9200	3488 017 447
81.30305.9201	3482 120 031
81.30305.9206	3482 000 461
81.30305.9218	3482 000 361
81.30305.9219	3482 000 246
81.30305.9220	3482 000 361
81.30305.9221	3482 000 246
81.30305.9223	3482 000 464
81.30305.9226	3482 114 031
81.30305.9229	3482 000 246
81.30305.9232	3482 000 461
81.30305.9233	3482 000 467
81.30305.9235	3482 000 664
81.30305.9236	3482 000 679

Vergleichsliste / Cross reference list

Vergleichs-Nr. Compare No.	Artikelnummer Article No.
-------------------------------	------------------------------

MAN

81.30305.9243	3482 001 180
81.30305.9246	3482 001 145
81.30401.7009	1882 110 532
81.30401.7013	1881 039 532
81.30530.0037	3189 600 004
81.30550.0015	3151 262 031
81.30550.0035	3151 000 515
81.30550.0036	3151 111 032
81.30550.0040	1863 009 100
81.30550.0043	3151 000 958
81.30550.0044	3151 199 001
81.30550.0049	3151 000 515
81.30550.0050	3151 000 395
81.30550.0054	3151 000 958
81.30550.0056	3151 067 032
81.30550.0060	3151 199 001
81.30550.0063	3151 000 034
81.30550.0067	3151 000 034
81.30550.0069	3151 000 395
81.30550.0070	3151 204 001
81.30550.0071	3151 000 034
81.30550.0073	3151 000 034
81.30550.0074	3182 005 231
81.30550.0074	3182 005 231
81.30550.0077	3151 000 034
81.30550.0078	3151 000 395
81.30550.0079	3182 005 231
81.30550.0080	3151 263 031
81.30550.0082	3151 253 031
81.30550.0085	3151 262 031
81.30550.0087	3151 000 034
81.30550.0088	3151 000 034
81.30550.0089	3151 263 031
81.30550.0090	3151 000 615
81.30550.0091	3182 998 501
81.30550.0094	3151 000 034
81.30550.0096	3151 000 144
81.30550.0101	3151 000 144
81.30550.0102	3151 000 144
81.30550.0103	3151 000 034
81.30550.0104	3151 000 144
81.30550.0105	3182 998 501
81.30550.0106	3151 000 034
81.30550.0107	3151 000 034
81.30550.0109	3151 000 034
81.30550.0110	3151 000 034
81.30550.0112	3151 000 515
81.30550.0113	3151 000 335
81.30550.0114	3151 000 144
81.30550.0115	3182 600 142
81.30550.0116	3151 000 034
81.30550.0117	3151 000 335
81.30550.0118	3151 000 493
81.30550.0249	3151 000 493
81.30550.0250	3182 600 142
81.30550.0251	3151 000 493
81.30550.0255	3151 000 493
81.30550.0256	3151 000 157
81.30550.0257	3151 000 157
81.30550.0261	3151 000 515
81.30550.0262	3151 000 395

Vergleichs-Nr. Compare No.	Artikelnummer Article No.
-------------------------------	------------------------------

MAN

81.30550.0264	3151 000 493
81.30550-0270	3151 000 493
81.30550.6013	1863 009 100
81.30550.6021	3151 600 541
81.30550.6022	3151 600 541
81.30550.7004	1863 101 100
81.30560.0070	3189 600 041
81.30560.0073	3189 600 044
81.30560.0074	3189 600 045
81.30560.0075	3189 600 041
81.30560.0076	3189 600 053
81.30560.0077	3189 600 009
81.30560.0077	3189 600 009
81.30560.0077	3189 600 036
81.30560.0079	3189 600 004
81.30560.6022	3189 600 020
81.30716.6101	3182 998 501
81.30716.6105	3182 600 142
81.32404.0002	3189 600 020
81.32411.0005	3189 600 014
81.32412.0002	3151 032 341
81.32412.0003	3151 032 341
81.32412.0006	3151 000 493
81.332.100.017	1878 051 801
81.91001.0604	3189 600 020
81.97640.0015	1805 042 000
81.99164.1328	1861 749 132
81.99164.1329	1861 748 132
81.99164.9328	1861 749 132
81.99164.9329	1861 748 132
82.30005.9001	1800 125 501
82.30005.9003	3400 700 310
82.30005.9004	3400 700 402
82.30005.9005	3400 700 403
82.30005.9006	3400 700 404
82.30301.0045	1878 005 411
82.30305.0027	3482 000 819
82.30305.9027	3482 000 819
85.30001.7388	1878 003 662
85.30001.7390	1878 003 662
85.30001.7391	1878 003 661
85.30001.7392	1878 003 662
85.30001.9049	3482 118 031
88.30301.0009	1878 001 079
88.30301.9009	1878 001 079
88.30302.0002	1859 170 204
88.30302.0005	1859 212 000
88.30304.0003	1882 325 134
88.30305.0001	1881 039 531
88.30305.0002	1881 041 656
88.30305.0003	1882 325 134
88.30305.0012	1882 110 542
88.30305.0012	1882 110 542
88.30305.6006	1882 110 542
88.30305.6006	1882 110 542
88.30305.9002	1881 041 656
88.30305.9003	1882 325 134
88.30305.9018	1880 092 415
88.30305.9064	1880 092 415
88.30305.9203	1882 110 542
88.30305.9203	1882 110 542

Vergleichs-Nr. Compare No.	Artikelnummer Article No.
-------------------------------	------------------------------

MAN

88.30305.9204	1882 110 542
88.30305.9204	1882 110 542
90.39260.01	1861 600 033
90.39260.9.01	1861 600 033
90.39370.01	1861 600 033
90.39370.9.01	1861 600 033
90.43802.10	1880 092 415
90.44562.01	1882 325 134
90.90392.6001	1861 600 033
90.90392.9001	1861 600 033
90.90393.7001	1861 600 033
90.90393.9001	1861 600 033
90.90438.0210	1880 092 415
90.90440.2201	1881 039 531
90.90440.4213	1881 041 656
90.90445.6201	1882 325 134
90.90448.2307	1882 110 542
90.90448.2307	1882 110 542

MERCEDES-BENZ

000 250 00 04	1882 302 131
000 250 01 15	3151 021 001
000 250 03 15	3151 000 206
000 250 04 03	1861 123 236
000 250 05 03	1861 919 134
000 250 05 04	1881 089 009
000 250 06 15	3151 000 206
000 250 07 15	3151 000 206
000 250 09 03	1862 088 131
000 250 09 15	3151 000 206
000 250 11 03	1862 088 131
000 250 12 03	1862 088 131
000 250 14 03	1860 062 037
000 250 14 08	1859 250 100
000 250 15 03	1862 088 131
000 250 16 08	1859 250 102
000 250 17 04	1882 110 542
000 250 17 08	1859 250 101
000 250 17 15	3151 033 031
000 250 19 04	1882 166 737
000 250 19 04	1882 166 737
000 250 19 15	3151 000 375
000 250 21 03	1861 123 236
000 250 21 15	3151 000 206
000 250 22 03	1861 123 236
000 250 25 15	3151 000 375
000 250 31 04	1882 110 532
000 250 31 15	3151 033 031
000 250 32 03	1878 001 074
000 250 32 15	3151 021 001
000 250 33 03	1861 919 134
000 250 35 03	1861 919 134
000 250 36 15	3151 043 031
000 250 37 15	3151 033 031
000 250 38 04	1882 229 131
000 250 38 15	3151 043 031
000 250 39 03	1861 123 236
000 250 40 03	1861 123 236
000 250 40 04	1882 166 737
000 250 40 04	1882 166 737
000 250 40 15	3151 033 031

Vergleichsliste / Cross reference list

Vergleichs-Nr. Compare No.	Artikelnummer Article No.
-------------------------------	------------------------------

MERCEDES-BENZ

000 250 41 03	1861 123 236
000 250 41 04	1881 041 656
000 250 42 15	3151 044 031
000 250 43 04	1882 166 737
000 250 43 04	1882 166 737
000 250 44 15	3151 051 031
000 250 45 03	1861 123 236
000 250 45 04	1882 346 131
000 250 46 04	1882 201 132
000 250 46 15	3151 044 031
000 250 51 15	3151 000 206
000 250 52 04	1882 205 234
000 250 52 15	3151 000 206
000 250 54 15	3151 079 031
000 250 55 15	3151 069 131
000 250 55 15	3151 069 131
000 250 59 15	3151 090 131
000 250 61 03	1861 611 131
000 250 63 03	1861 291 136
000 250 63 04	1882 201 132
000 250 64 04	1882 229 131
000 250 64 15	3151 000 392
000 250 65 04	1881 039 532
000 250 67 04	1882 110 542
000 250 67 15	3151 090 131
000 250 68 15	3151 069 131
000 250 69 15	3151 069 032
000 250 71 04	1882 166 737
000 250 71 04	1882 166 737
000 250 73 15	3151 110 031
000 250 74 04	1882 166 737
000 250 74 04	1882 166 737
000 250 74 15	3151 000 375
000 250 75 15	3151 108 031
000 250 76 15	3151 126 031
000 250 77 15	3151 000 375
000 250 78 04	1882 229 131
000 250 78 15	3151 116 031
000 250 79 04	1882 229 131
000 250 80 15	3151 027 133
000 250 81 04	1882 231 131
000 250 82 03	1861 279 133
000 250 84 03	1861 518 031
000 250 89 03	1861 279 133
000 250 91 03	1878 001 074
000 250 92 03	1878 000 104
000 250 92 15	3151 166 031
000 250 93 03	1861 470 234
000 250 93 04	1882 234 433
000 250 95 15	3151 170 131
000 250 99 03	1861 279 133
000 250 99 04	1882 205 234
000 252 00 05	1864 464 031
000 252 05 22	1866 030 102
000 252 06 46	3496 006 000
000 252 07 05	3000 951 784
000 252 15 11	3000 951 784
000 252 30 05	3000 951 784
000 252 32 05	3000 970 079
000 252 36 11	3000 970 079
000 252 39 11	3000 970 079

Vergleichs-Nr. Compare No.	Artikelnummer Article No.
-------------------------------	------------------------------

MERCEDES-BENZ

000 252 61 05	3000 970 079
000 252 75 05	3000 970 079
000 252 77 05	3000 970 079
000 252 80 05	3000 951 824
000 254 01 94	1805 042 000
000 254 02 20	3151 000 958
000 254 03 20	3182 998 501
000 254 03 94	3130 010 100
000 254 04 20	3182 998 501
000 254 09 07	3189 600 004
000 254 10 08	3189 600 053
000 254 13 08	3182 654 203
000 254 14 08	3182 654 203
000 254 15 08	3182 654 216
000 254 16 08	3182 654 192
000 254 17 08	3182 997 802
000 254 18 08	3182 654 203
000 254 25 08	3182 654 192
000 254 28 08	3182 997 802
000 254 30 08	3151 000 144
000 254 30 20	3182 998 501
000 254 32 08	3151 000 493
000 290 32 12	6284 600 573
000 295 80 07	6283 600 113
000 295 88 07	6283 600 113
000 295 89 07	6283 600 113
000 981 66 27	1863 837 002
000 981 67 25	1863 840 001
000 981 67 27	1863 837 002
000 981 70 25	1863 837 003
000 981 75 25	1863 840 001
000 981 96 27	1863 837 002
000 981 97 27	1863 855 000
001 250 00 03	1861 279 133
001 250 00 04	1882 234 433
001 250 01 04	1882 110 542
001 250 01 15	3151 248 031
001 250 02 03	1878 001 074
001 250 02 15	3151 248 031
001 250 03 04	1882 252 331
001 250 04 04	1882 252 333
001 250 04 15	3151 182 031
001 250 05 03	1861 919 134
001 250 05 15	3151 000 278
001 250 06 03	1861 291 136
001 250 06 15	3151 000 547
001 250 07 04	1882 166 737
001 250 07 04	1882 166 737
001 250 08 04	1882 166 737
001 250 08 04	1882 166 737
001 250 08 15	3151 170 131
001 250 09 15	3151 000 549
001 250 13 01	1862 718 002
001 250 13 01	1878 634 076
001 250 14 15	3151 204 001
001 250 22 15	3151 000 374
001 250 25 15	3151 248 031
001 250 26 03	1861 279 133
001 250 27 03	1878 001 074
001 250 36 03	1861 919 134
001 250 38 03	1861 279 133

Vergleichs-Nr. Compare No.	Artikelnummer Article No.
-------------------------------	------------------------------

MERCEDES-BENZ

001 250 39 03	1861 279 133
001 250 40 03	1861 919 134
001 250 41 04	3082 121 031
001 250 42 04	3082 121 031
001 250 42 04	3082 121 031
001 250 43 04	3082 078 032
001 250 43 15	3182 003 131
001 250 44 15	3182 002 131
001 250 45 15	3151 182 031
001 250 47 15	3151 000 549
001 250 48 03	1861 518 031
001 250 48 15	3151 000 278
001 250 49 03	1861 518 031
001 250 49 15	3151 000 547
001 250 52 04	1882 205 234
001 250 53 04	1882 166 737
001 250 55 03	1878 000 104
001 250 57 03	1878 001 074
001 250 58 03	1878 000 104
001 250 59 03	1861 303 248
001 250 60 03	1861 303 248
001 250 62 15	3151 000 549
001 250 63 15	3151 000 549
001 250 64 15	3151 000 278
001 250 65 15	3151 000 278
001 250 66 15	3151 000 547
001 250 67 03	1878 000 104
001 250 67 15	3151 000 547
001 250 68 04	1882 166 737
001 250 69 03	1861 840 133
001 250 72 15	3151 248 031
001 250 74 04	1882 234 433
001 250 75 04	1882 205 234
001 250 76 03	1861 518 031
001 250 78 04	1882 282 331
001 250 79 15	3151 000 278
001 250 80 15	3151 000 547
001 250 81 15	3151 000 549
001 250 83 03	1878 000 104
001 250 84 15	3151 000 549
001 250 86 03	1861 611 131
001 250 86 15	3151 000 278
001 250 87 04	1882 231 131
001 250 88 15	3151 000 547
001 250 90 04	1882 252 333
001 250 91 15	3151 044 031
001 250 92 15	3151 000 497
001 250 93 15	3151 044 031
001 250 97 01	3400 122 801
001 250 97 03	1878 001 074
001 250 97 15	3151 000 549
001 250 98 15	3151 000 278
001 250 99 15	3151 000 396
001 252 19 05	3000 951 188
001 252 32 05	3000 970 079
001 252 33 05	3000 951 112
001 252 33 05	3000 970 079
001 252 61 05	3000 951 824
001 252 62 05	3000 951 188
001 981 32 27	1863 855 000
001 981 33 27	1863 837 002

Vergleichsliste / Cross reference list

Vergleichs-Nr. Compare No.	Artikelnummer Article No.
-------------------------------	------------------------------

MERCEDES-BENZ

002 250 00 15	3151 000 396
002 250 02 04	3488 000 158
002 250 03 04	3482 124 522
002 250 04 03	1861 303 248
002 250 04 04	3482 124 522
002 250 05 03	1878 000 104
002 250 05 15	3151 248 031
002 250 08 15	3151 000 547
002 250 11 15	3182 002 132
002 250 13 03	1878 001 074
002 250 14 03	1878 001 074
002 250 16 04	1882 282 331
002 250 19 15	3182 998 501
002 250 21 15	3182 998 501
002 250 22 15	3182 998 501
002 250 24 15	3182 600 101
002 250 25 03	1861 384 334
002 250 25 15	3182 600 101
002 250 27 15	3182 998 501
002 250 28 15	3182 600 101
002 250 29 15	3182 998 501
002 250 30 15	3182 600 101
002 250 30 15	3182 600 101
002 250 30 15	3182 998 501
002 250 31 04	1882 302 131
002 250 31 15	3182 998 501
002 250 32 04	1882 301 239
002 250 32 15	3151 000 497
002 250 33 03	1878 003 320
002 250 34 03	1861 303 248
002 250 35 03	1861 291 136
002 250 36 04	1882 302 132
002 250 37 15	3100 000 003
002 250 39 03	1861 303 248
002 250 39 04	1882 302 131
002 250 40 04	1882 302 131
002 250 40 15	3100 000 003
002 250 41 04	1882 301 239
002 250 43 03	1861 840 133
002 250 44 15	3151 000 335
002 250 45 04	1882 346 131
002 250 45 15	3151 000 157
002 250 46 04	3082 121 031
002 250 47 04	3082 121 031
002 250 48 15	3182 003 131
002 250 49 15	3151 000 335
002 250 51 15	3182 998 501
002 250 52 15	3182 600 101
002 250 53 15	3182 600 189
002 250 55 15	3182 600 141
002 250 57 15	3182 600 189
002 250 58 15	3182 600 166
002 250 60 15	3182 600 172
002 250 61 04	1882 305 131
002 250 61 15	3151 000 374
002 250 62 15	3182 600 101
002 250 63 03	1861 470 234
002 250 63 15	3151 000 335
002 250 64 03	1861 470 234
002 250 64 04	1882 305 132
002 250 65 03	1861 470 234

Vergleichs-Nr. Compare No.	Artikelnummer Article No.
-------------------------------	------------------------------

MERCEDES-BENZ

002 250 65 15	3151 000 396
002 250 66 15	3182 998 501
002 250 68 04	1882 311 131
002 250 68 15	3100 000 003
002 250 70 04	3482 008 038
002 250 71 04	3482 008 038
002 250 72 04	3082 121 031
002 250 72 15	3182 600 101
002 250 73 04	3082 121 031
002 250 73 15	3182 600 141
002 250 74 03	1861 291 136
002 250 74 15	3182 600 166
002 250 75 04	3482 000 953
002 250 75 15	3182 600 172
002 250 76 15	3182 600 101
002 250 77 04	1882 346 131
002 250 77 15	3100 000 003
002 250 81 01	1888 893 001
002 250 81 04	3482 124 522
002 250 82 15	3100 000 003
002 250 83 01	1888 877 101
002 250 83 15	3151 000 335
002 250 84 04	1882 317 131
002 250 87 04	3482 012 211
002 250 88 03	1861 303 248
002 250 88 15	3151 000 157
002 250 89 01	1888 893 001
002 250 94 04	1882 252 331
002 250 95 04	1882 252 333
002 250 96 04	1882 305 131
002 250 97 03	1878 000 105
002 250 97 04	1882 305 132
002 250 97 15	3151 000 615
002 250 98 03	1878 000 105
002 250 99 03	1878 002 706
002 250 99 04	1882 301 239
002 250 99 15	3100 000 003
002 295 03 06	6284 605 064
002 295 04 06	6284 605 064
002 295 06 07	6283 600 115
002 295 07 06	6284 605 065
002 295 08 07	6283 600 539
002 295 21 07	6283 600 115
002 295 22 07	6283 600 539
002 981 89 25	1863 869 028
003 250 00 03	1878 002 706
003 250 00 04	1882 301 239
003 250 02 04	3082 078 032
003 250 06 03	1878 000 105
003 250 06 04	3482 008 032
003 250 07 03	1878 001 136
003 250 08 04	3082 078 032
003 250 08 13	6482 000 219
003 250 09 03	1878 000 105
003 250 09 04	1882 301 238
003 250 09 04	3482 124 541
003 250 09 04	3482 124 541
003 250 10 04	1882 205 234
003 250 10 15	6482 000 218
003 250 11 03	1862 718 002
003 250 11 03	1878 634 076

Vergleichs-Nr. Compare No.	Artikelnummer Article No.
-------------------------------	------------------------------

MERCEDES-BENZ

003 250 12 04	1882 317 131
003 250 13 03	1862 718 002
003 250 13 03	1878 634 076
003 250 14 04	1881 041 656
003 250 14 15	3151 000 335
003 250 15 15	3151 000 157
003 250 16 04	1882 234 433
003 250 16 15	3151 000 615
003 250 20 04	1882 166 737
003 250 20 04	1882 166 737
003 250 21 04	1882 166 737
003 250 21 04	1882 166 737
003 250 21 15	6482 000 218
003 250 22 03	1861 611 131
003 250 22 04	1882 166 737
003 250 22 15	3151 000 493
003 250 23 04	1882 311 131
003 250 24 01	1888 877 101
003 250 24 04	1882 302 132
003 250 25 04	1882 302 131
003 250 26 03	1861 966 141
003 250 26 04	1882 301 239
003 250 27 04	1882 302 131
003 250 28 04	1882 302 131
003 250 32 04	1882 330 032
003 250 33 03	1861 279 133
003 250 33 04	1882 301 238
003 250 33 04	3482 124 541
003 250 33 04	3482 124 541
003 250 34 04	1882 110 542
003 250 35 15	6482 000 218
003 250 35 15	6482 000 219
003 250 37 04	3082 121 031
003 250 37 15	3151 001 083
003 250 38 03	1862 088 131
003 250 39 03	1861 840 133
003 250 40 04	3482 012 240
003 250 41 03	1861 518 031
003 250 41 04	1882 301 239
003 250 42 03	1861 384 334
003 250 45 04	3082 156 031
003 250 46 04	3082 156 031
003 250 48 04	3482 002 234
003 250 48 15	3151 000 335
003 250 50 03	1862 718 002
003 250 50 03	1878 634 076
003 250 51 03	1878 000 104
003 250 53 03	1861 966 141
003 250 53 04	1888 042 009
003 250 54 04	3482 012 211
003 250 56 03	1878 001 070
003 250 59 04	3482 012 237
003 250 61 03	1878 634 064
003 250 61 04	1882 342 134
003 250 62 03	1878 001 070
003 250 62 15	3151 000 278
003 250 63 15	3151 000 497
003 250 64 15	3151 000 547
003 250 65 04	3482 008 038
003 250 65 15	3151 000 549
003 250 66 04	3082 121 031

Vergleichsliste / Cross reference list

Vergleichs-Nr. Compare No.	Artikelnummer Article No.
-------------------------------	------------------------------

MERCEDES-BENZ

003 250 67 15	3151 000 615
003 250 68 15	3151 000 157
003 250 69 15	3151 000 335
003 250 70 04	1882 301 239
003 250 70 15	6482 000 218
003 250 70 15	6482 000 219
003 250 71 03	1878 634 014
003 250 71 04	1882 302 135
003 250 73 03	1878 001 136
003 250 73 15	3151 001 082
003 250 74 03	1878 000 105
003 250 74 04	1888 042 009
003 250 75 15	3151 001 083
003 250 77 04	3082 156 031
003 250 78 04	3082 156 031
003 250 79 03	1878 002 706
003 250 79 04	3082 121 031
003 250 80 04	3082 121 031
003 250 80 15	3151 000 493
003 250 82 03	1861 303 248
003 250 83 03	1861 303 248
003 250 83 04	1882 341 001
003 250 84 03	1861 571 236
003 250 84 04	3482 002 234
003 250 85 15	6482 000 219
003 250 86 03	1861 303 248
003 250 86 04	1882 342 134
003 250 86 15	6482 000 218
003 250 88 03	1861 643 134
003 250 88 04	3482 124 522
003 250 88 04	3482 124 522
003 250 89 03	1878 001 136
003 250 90 04	1882 342 134
003 250 91 04	3082 121 031
003 250 92 04	1888 042 009
003 250 93 04	3482 054 131
003 250 94 04	3482 055 132
003 250 95 03	1878 000 964
003 250 96 04	3482 046 031
003 250 98 01	1888 067 042
003 250 98 04	3482 008 038
003 250 99 04	3482 012 240
004 250 00 04	3482 124 522
004 250 05 04	1882 346 131
004 250 05 04	1882 346 131
004 250 07 04	3482 012 237
004 250 11 04	3482 008 038
004 250 14 03	1878 001 136
004 250 19 04	3082 156 031
004 250 20 04	3082 157 031
004 250 23 03	1861 611 131
004 250 23 04	3082 156 031
004 250 23 04	3082 156 031
004 250 24 04	3482 000 953
004 250 26 03	1861 594 034
004 250 27 03	1861 594 034
004 250 28 03	1861 603 034
004 250 29 03	1861 603 034
004 250 30 03	1861 594 034
004 250 31 04	3082 156 031
004 250 34 04	1888 055 247

Vergleichs-Nr. Compare No.	Artikelnummer Article No.
-------------------------------	------------------------------

MERCEDES-BENZ

004 250 35 04	1888 055 247
004 250 36 04	1888 055 247
004 250 40 04	1888 055 041
004 250 41 04	1888 055 041
004 250 42 03	1861 384 334
004 250 44 04	3488 017 432
004 250 45 04	3488 017 432
004 250 45 04	3488 017 432
004 250 46 04	3482 081 231
004 250 47 03	1861 611 131
004 250 47 04	1888 055 041
004 250 49 03	1861 303 248
004 250 51 04	3482 055 132
004 250 52 03	1878 000 964
004 250 54 04	1882 349 003
004 250 55 04	1888 055 041
004 250 56 04	3482 081 232
004 250 58 04	3482 081 232
004 250 60 04	3482 081 232
004 250 61 04	3482 081 231
004 250 63 05	1863 600 123
004 250 66 03	1861 919 134
004 250 69 03	1861 966 141
004 250 70 04	1888 042 009
004 250 71 03	1861 594 034
004 250 71 04	1888 042 009
004 250 72 03	1861 632 032
004 250 72 04	1888 042 009
004 250 73 03	1878 001 070
004 250 73 04	1888 055 041
004 250 79 04	1888 063 137
004 250 80 01	1888 067 042
004 250 80 04	1888 063 137
004 250 81 01	1888 067 042
004 250 83 04	3082 078 032
004 250 86 03	1861 384 334
004 250 87 04	3482 081 231
004 250 88 04	3482 081 232
004 250 88 04	3482 081 232
004 250 89 03	1861 470 234
004 250 89 04	3482 081 233
004 250 90 03	1878 001 074
004 250 91 03	1861 470 234
004 250 91 04	1888 063 137
004 250 92 04	1888 063 137
004 250 93 04	1888 063 137
004 250 96 04	1888 042 009
004 250 97 01	1888 893 001
004 250 97 04	1888 055 247
004 250 98 03	1861 667 034
004 250 98 04	1888 055 041
004 250 99 04	1888 063 137
004 981 21 25	1863 869 028
004 981 21 25	1863 869 028
005 250 01 03	1878 002 706
005 250 02 03	1878 002 706
005 250 02 04	1888 055 247
005 250 03 01	1888 067 031
005 250 03 04	1888 055 247
005 250 04 04	1888 055 247
005 250 04 04	1888 055 247

Vergleichs-Nr. Compare No.	Artikelnummer Article No.
-------------------------------	------------------------------

MERCEDES-BENZ

005 250 06 03	1861 303 248
005 250 06 04	3482 002 239
005 250 07 03	1861 303 248
005 250 08 04	3482 012 237
005 250 09 04	1882 019 133
005 250 09 04	1882 019 133
005 250 11 04	1882 349 003
005 250 14 04	1888 063 137
005 250 15 04	1888 063 137
005 250 16 04	1888 063 137
005 250 19 03	1878 001 144
005 250 19 03	1878 001 147
005 250 19 04	3482 124 522
005 250 20 03	1861 923 032
005 250 20 03	1878 001 152
005 250 21 03	1878 003 657
005 250 22 03	1878 003 657
005 250 23 03	1878 001 144
005 250 24 03	1878 001 147
005 250 28 04	3483 023 032
005 250 33 01	1888 877 102
005 250 39 03	1878 001 070
005 250 39 04	3482 055 132
005 250 40 03	1878 001 070
005 250 43 03	1878 000 105
005 250 46 04	3482 106 031
005 250 47 04	3482 106 133
005 250 49 01	1888 877 102
005 250 49 03	1861 470 234
005 250 50 03	1878 001 136
005 250 50 04	3483 000 510
005 250 51 04	3483 000 510
005 250 52 04	3482 051 132
005 250 53 03	1861 571 236
005 250 54 03	1861 741 042
005 250 55 03	1861 571 236
005 250 57 03	1878 000 105
005 250 60 03	1878 002 878
005 250 61 03	1878 002 878
005 250 62 04	3482 081 233
005 250 64 03	1878 000 105
005 250 64 04	3483 030 032
005 250 66 04	3483 030 032
005 250 70 03	1861 840 133
005 250 76 04	3488 017 432
005 250 77 03	1878 001 077
005 250 77 04	3488 017 432
005 250 77 04	3488 017 432
005 250 83 04	3482 081 232
005 250 84 04	3482 081 231
005 250 86 01	1888 067 031
005 250 87 04	3488 017 432
005 250 88 04	3488 017 432
005 250 89 03	1861 840 133
005 250 93 04	3483 030 031
005 250 94 03	1861 919 134
005 250 94 04	3483 030 031
005 250 95 03	1861 919 134
006 250 01 04	3082 267 233
006 250 04 04	3082 268 031

Vergleichs-Nr. Compare No.	Artikelnummer Article No.
-------------------------------	------------------------------

MERCEDES-BENZ

006 250 05 03	1861 936 142
006 250 07 04	3082 269 031
006 250 10 04	3482 008 038
006 250 12 03	1878 001 136
006 250 13 04	3482 054 131
006 250 14 03	1861 667 034
006 250 14 04	3483 000 139
006 250 17 03	1878 002 706
006 250 19 03	1862 962 002
006 250 19 04	3082 267 233
006 250 20 04	3082 267 233
006 250 21 04	3082 267 233
006 250 22 04	3082 268 031
006 250 23 04	3082 268 031
006 250 24 04	3082 268 031
006 250 25 04	3082 269 031
006 250 26 04	3082 269 031
006 250 27 04	3082 269 031
006 250 28 04	3482 106 133
006 250 30 04	3482 000 462
006 250 34 04	3482 000 463
006 250 35 03	1861 936 142
006 250 39 03	1878 051 801
006 250 44 04	1888 063 137
006 250 45 03	1878 000 105
006 250 45 04	1888 063 137
006 250 46 03	1878 000 105
006 250 47 03	1861 923 032
006 250 47 03	1878 001 152
006 250 47 04	3488 023 031
006 250 48 04	3488 023 031
006 250 49 04	3488 023 031
006 250 50 04	3082 267 233
006 250 51 04	3082 267 233
006 250 52 04	3082 267 233
006 250 55 03	1878 634 014
006 250 58 04	3082 267 233
006 250 59 04	3082 267 233
006 250 60 04	3082 267 233
006 250 62 03	1861 956 133
006 250 65 04	3082 268 031
006 250 67 04	3482 000 462
006 250 72 04	1888 055 247
006 250 73 04	3483 000 139
006 250 75 03	1861 964 034
006 250 76 03	1861 643 134
006 250 77 03	1878 001 136
006 250 78 03	1861 384 334
006 250 79 03	1861 964 034
006 250 80 03	1861 964 034
006 250 81 03	1861 963 033
006 250 82 03	1861 963 033
006 250 83 03	1878 001 144
006 250 84 03	1878 001 144
006 250 86 04	3488 023 031
006 250 87 03	1878 003 657
006 250 87 04	3488 023 031
006 250 88 04	3488 023 031
006 250 89 03	1861 470 234
006 250 90 03	1878 000 105
006 250 95 03	1862 123 131

Vergleichs-Nr. Compare No.	Artikelnummer Article No.
-------------------------------	------------------------------

MERCEDES-BENZ

006 250 95 03	1878 006 055
006 250 96 03	1862 123 131
006 250 96 03	1862 123 131
006 250 96 03	1878 006 055
007 250 02 03	1862 122 132
007 250 03 03	1862 122 132
007 250 05 03	1878 003 657
007 250 05 04	3488 023 031
007 250 06 04	3488 023 031
007 250 07 04	3488 023 031
007 250 08 03	1878 000 105
007 250 09 03	1878 000 105
007 250 10 03	1878 000 105
007 250 12 03	1878 001 136
007 250 13 03	1878 001 136
007 250 14 04	3483 000 139
007 250 15 04	3482 000 463
007 250 18 03	1861 919 134
007 250 19 03	1861 919 134
007 250 21 03	1861 291 136
007 250 23 04	3482 000 464
007 250 24 04	3482 000 464
007 250 28 03	1861 571 236
007 250 28 04	3488 023 031
007 250 29 03	1861 571 236
007 250 29 04	3488 023 031
007 250 30 03	1878 001 070
007 250 30 04	3488 023 031
007 250 32 04	3488 023 031
007 250 33 04	3488 023 031
007 250 34 04	3488 023 031
007 250 38 03	1878 000 104
007 250 42 03	1878 002 706
007 250 43 03	1878 002 706
007 250 44 04	3488 023 031
007 250 45 04	3488 000 102
007 250 46 03	1878 006 055
007 250 46 04	3488 023 031
007 250 47 03	1878 006 055
007 250 47 04	3488 023 031
007 250 49 03	1862 138 032
007 250 50 03	1862 138 032
007 250 51 04	3488 023 031
007 250 55 03	1861 923 032
007 250 55 03	1878 001 152
007 250 57 04	3483 000 258
007 250 60 03	1878 005 805
007 250 60 03	1878 634 022
007 250 61 03	1878 005 805
007 250 61 03	1878 634 022
007 250 61 04	3483 030 032
007 250 67 03	1878 002 706
007 250 68 03	1878 002 706
007 250 69 03	1878 002 706
007 250 72 03	1861 571 236
007 250 72 04	3488 000 158
007 250 74 03	1878 001 070
007 250 74 04	3483 000 139
007 250 77 04	3488 000 158
007 250 79 04	3483 030 031
007 250 80 04	3483 000 258

Vergleichs-Nr. Compare No.	Artikelnummer Article No.
-------------------------------	------------------------------

MERCEDES-BENZ

007 250 81 04	3483 030 032
007 250 82 04	3488 023 031
007 250 83 04	3483 000 139
007 250 84 04	3488 000 102
007 250 86 03	1878 634 052
007 250 88 01	1888 877 102
007 250 89 04	3488 017 410
007 250 90 01	1888 067 031
007 250 92 01	1888 893 001
007 250 95 03	1861 936 142
007 250 96 03	1861 936 142
007 250 96 04	3488 000 102
007 250 97 03	1861 936 142
007 250 98 03	1861 964 034
007 250 99 03	1861 964 034
008 250 00 04	3488 000 158
008 250 06 03	1861 963 033
008 250 08 03	1878 001 144
008 250 10 04	3488 023 031
008 250 13 03	1878 005 805
008 250 13 03	1878 634 023
008 250 13 04	3488 000 158
008 250 14 03	1878 005 805
008 250 14 03	1878 634 023
008 250 16 03	1878 006 055
008 250 17 03	1862 138 032
008 250 19 03	1878 005 668
008 250 19 04	3488 023 031
008 250 20 03	1878 005 668
008 250 22 03	1861 919 134
008 250 23 03	1861 919 134
008 250 24 04	3483 030 032
008 250 25 04	3483 000 258
008 250 30 04	3483 030 032
008 250 31 04	3483 030 031
008 250 32 04	3483 000 258
008 250 35 04	3488 023 031
008 250 36 03	1878 005 668
008 250 36 04	3488 023 031
008 250 37 03	1878 005 668
008 250 38 04	3488 000 158
008 250 39 04	3488 000 158
008 250 42 03	1861 713 133
008 250 42 04	3488 023 031
008 250 43 03	1861 384 334
008 250 43 04	3483 000 139
008 250 45 04	3488 000 102
008 250 46 03	1878 001 144
008 250 46 03	1878 001 147
008 250 47 03	1888 055 041
008 250 51 03	1878 005 668
008 250 57 04	3482 000 679
008 250 59 04	3488 000 158
008 250 60 03	1878 065 131
008 250 68 03	1864 464 031
008 250 72 03	1861 303 248
008 250 74 03	1878 002 878
008 250 76 03	1878 634 014
008 250 80 03	1878 000 968
008 250 82 03	1878 006 055
008 250 83 03	1862 138 032

Vergleichsliste / Cross reference list

Vergleichs-Nr. Compare No.	Artikelnummer Article No.
-------------------------------	------------------------------

MERCEDES-BENZ

008 250 84 01	1888 877 102
008 250 90 03	1878 087 141
008 250 90 03	1878 087 141
008 250 92 04	3488 000 366
008 250 93 04	3488 000 366
008 250 95 03	1862 211 031
008 250 97 03	1862 304 033
008 250 98 03	1862 304 033
008 250 99 04	3482 000 851
009 250 01 03	1862 305 033
009 250 02 03	1862 305 033
009 250 05 04	3488 000 158
009 250 07 04	3483 030 031
009 250 08 04	3483 030 032
009 250 09 04	3483 000 258
009 250 10 04	3483 000 422
009 250 12 03	1861 303 248
009 250 12 04	3488 000 158
009 250 13 03	1861 303 248
009 250 14 03	1861 741 042
009 250 14 04	3488 023 031
009 250 15 04	3488 023 031
009 250 17 03	1862 225 132
009 250 18 03	1862 225 132
009 250 18 04	3488 000 102
009 250 19 03	1878 080 031
009 250 20 03	1878 080 033
009 250 21 04	3483 000 139
009 250 23 04	3488 023 031
009 250 24 04	3488 000 158
009 250 25 04	3488 023 031
009 250 32 03	1861 279 133
009 250 32 03	1861 279 133
009 250 33 03	1861 279 133
009 250 33 04	3483 000 461
009 250 40 03	1878 001 074
009 250 40 04	3482 000 852
009 250 41 03	1861 470 234
009 250 45 03	1878 003 657
009 250 52 03	1861 956 133
009 250 53 03	1861 956 133
009 250 55 03	1861 384 334
009 250 56 03	1861 384 334
009 250 57 03	1861 667 034
009 250 58 03	1861 840 133
009 250 59 03	1861 840 133
009 250 60 03	1861 603 034
009 250 61 03	1861 603 034
009 250 62 03	1861 713 133
009 250 63 03	1861 713 133
009 250 64 03	1861 713 133
009 250 65 03	1861 713 133
009 250 67 03	1861 594 034
009 250 73 01	1888 998 902
009 250 80 03	1861 713 133
009 250 81 03	1862 718 002
009 250 81 03	1878 634 076
009 250 82 03	1861 966 141
009 250 83 04	3483 030 032
009 250 85 03	1862 962 002
009 250 85 04	3488 000 158

Vergleichs-Nr. Compare No.	Artikelnummer Article No.
-------------------------------	------------------------------

MERCEDES-BENZ

009 250 93 03	1860 062 037
009 250 95 01	1888 877 101
009 250 96 01	1888 067 042
009 250 96 03	1861 279 133
009 250 96 03	1861 279 133
009 250 97 01	1888 067 031
010 250 00 03	1878 000 105
010 250 02 03	1878 003 320
010 250 05 03	1878 634 064
010 250 07 04	3483 030 032
010 250 08 04	3483 030 031
010 250 09 03	1861 574 132
010 250 09 04	3483 000 422
010 250 10 04	3483 030 032
010 250 11 04	3483 000 258
010 250 12 03	1861 123 236
010 250 13 03	1861 632 032
010 250 13 04	3488 000 158
010 250 14 03	1878 000 964
010 250 15 04	3488 023 031
010 250 17 03	1861 643 134
010 250 17 04	3488 023 031
010 250 18 03	1878 002 706
010 250 18 04	3488 000 102
010 250 20 04	3483 000 139
010 250 22 03	1878 000 964
010 250 22 04	3483 000 461
010 250 36 03	1861 470 234
010 250 47 03	1878 003 269
010 250 48 03	1878 003 269
010 250 57 03	1878 002 735
010 250 58 03	1878 002 735
010 250 61 03	1862 304 033
010 250 62 03	1862 304 033
010 250 63 03	1862 304 033
010 250 65 03	1862 305 033
010 250 66 03	1862 305 033
010 250 67 03	1862 305 033
010 250 69 03	1861 936 142
010 250 70 03	1861 936 142
010 250 72 03	1861 936 142
010 250 73 03	1861 936 142
010 250 75 03	1862 123 131
010 250 75 03	1878 006 055
010 250 76 03	1862 122 132
010 250 77 03	1878 006 055
010 250 78 03	1862 138 032
010 250 79 03	1862 304 033
010 250 80 03	1862 305 033
010 250 83 03	1861 741 042
010 250 84 03	1862 962 002
010 250 85 03	1861 919 134
010 250 86 03	1861 303 248
010 250 88 03	1878 005 805
010 250 88 03	1878 634 022
010 250 89 03	1878 005 805
010 250 89 03	1878 634 022
010 250 91 03	1878 005 805
010 250 91 03	1878 634 023
010 250 92 03	1878 005 805
010 250 92 03	1878 634 023

Vergleichs-Nr. Compare No.	Artikelnummer Article No.
-------------------------------	------------------------------

MERCEDES-BENZ

010 250 95 03	1864 464 031
010 250 97 03	1864 464 031
010 981 31 25	1863 869 028
010 981 31 25	1863 869 028
010 981 56 25	1863 869 028
010 981 56 25	1863 869 028
011 250 00 03	1878 000 105
011 250 01 03	1878 000 105
011 250 02 03	1878 000 105
011 250 04 03	1878 005 668
011 250 13 03	1862 123 131
011 250 13 03	1878 006 055
011 250 14 03	1862 123 131
011 250 14 03	1878 006 055
011 250 15 03	1862 123 131
011 250 15 03	1862 123 131
011 250 15 03	1878 006 055
011 250 17 03	1862 122 132
011 250 18 03	1862 122 132
011 250 19 03	1862 122 132
011 250 22 03	1864 464 031
011 250 25 03	1862 299 032
011 250 25 03	1862 299 032
011 250 27 03	1862 286 031
011 250 30 03	1878 080 031
011 250 36 03	1862 538 031
011 250 61 03	1862 304 033
011 250 62 03	1862 304 033
011 250 62 03	1862 304 033
011 250 63 03	1862 304 033
011 250 65 03	1862 305 033
011 250 66 03	1862 305 033
011 250 67 03	1862 305 033
011 250 70 03	1862 088 131
011 250 71 03	1861 611 131
011 250 72 03	1861 594 034
011 250 74 03	1861 571 236
011 250 81 03	1878 001 144
011 250 90 03	1878 080 033
011 250 95 03	1862 122 132
011 250 96 03	1862 122 132
011 250 98 03	1862 123 131
011 250 98 03	1862 123 131
011 250 98 03	1878 006 055
011 250 99 03	1862 123 131
011 250 99 03	1878 006 055
012 250 02 03	1878 001 152
012 250 03 03	1878 001 152
012 250 04 03	1878 001 152
012 250 15 01	1888 600 101
012 250 16 01	1888 877 103
012 250 17 03	1878 080 033
012 250 18 03	1878 080 033
012 250 24 03	1878 003 657
012 250 25 03	1878 003 657
012 250 33 03	1862 211 031
012 250 36 03	1861 384 334
012 250 53 03	1878 080 033
012 250 58 03	1878 080 031
012 250 65 03	1861 923 032

Vergleichsliste / Cross reference list

Vergleichs-Nr. Compare No.	Artikelnummer Article No.
-------------------------------	------------------------------

MERCEDES-BENZ

012 250 65 03	1878 001 152
012 250 69 03	1878 000 105
012 250 81 03	1878 051 801
012 250 84 03	1878 080 033
012 250 85 03	1878 080 033
012 250 88 03	1878 051 801
012 250 93 03	1878 065 131
013 250 01 03	1878 065 131
013 250 08 03	1878 080 033
013 250 13 03	1878 080 031
013 250 14 03	1878 080 031
013 250 16 03	1878 080 033
013 250 17 03	1878 080 033
013 250 18 03	1878 080 031
013 250 25 03	1878 080 031
013 250 26 03	1878 005 668
013 250 27 03	1878 080 031
013 250 28 03	1878 080 033
013 250 33 03	1878 080 033
013 250 35 03	1878 080 033
013 250 41 03	1878 005 668
013 250 42 03	1878 080 031
013 250 49 03	1878 634 071
013 250 54 03	1861 919 134
013 250 71 03	1878 080 033
013 250 74 03	1878 002 735
013 250 79 03	1878 002 735
013 250 80 03	1864 464 031
013 250 81 03	1864 464 031
013 250 82 03	1861 303 248
013 250 85 03	1878 074 641
013 250 87 03	1878 002 735
013 250 88 03	1878 002 735
013 250 89 03	1861 919 134
013 250 92 03	1861 303 248
013 250 94 03	1862 299 032
013 250 95 03	1861 963 033
013 250 95 03	1861 963 033
013 250 98 03	1861 964 034
013 250 98 03	1861 964 034
014 250 20 03	1862 299 032
014 250 21 03	1862 299 032
014 250 27 03	1862 299 032
014 250 27 03	1862 299 032
014 250 28 03	1862 299 032
014 250 35 03	1864 503 231
014 250 36 03	1864 503 231
014 250 41 03	1864 504 031
014 250 42 03	1864 504 031
014 250 43 03	1864 504 031
014 250 53 03	1878 074 641
014 250 54 03	1878 074 641
014 250 56 03	1861 963 033
014 250 57 03	1861 963 033
014 250 64 03	1861 963 033
014 250 65 03	1861 963 033
014 250 76 03	1878 002 735
014 250 77 03	1878 002 735
014 250 78 03	1878 002 735
014 250 79 01	1888 998 902
014 250 80 01	1888 916 001

Vergleichs-Nr. Compare No.	Artikelnummer Article No.
-------------------------------	------------------------------

MERCEDES-BENZ

014 250 82 03	1861 936 142
014 250 83 03	1861 936 142
014 250 84 03	1878 080 037
014 250 88 03	1861 279 133
014 250 89 03	1861 279 133
014 250 89 03	1861 279 133
014 250 94 03	1861 291 136
014 250 95 03	1878 003 780
014 250 99 03	1878 080 033
015 250 00 03	1878 080 033
015 250 07 03	1878 994 001
015 250 08 03	1878 994 001
015 250 09 03	1878 994 001
015 250 12 03	1878 005 187
015 250 13 03	1864 464 031
015 250 14 03	1864 464 031
015 250 15 03	1864 464 031
015 250 16 03	1864 503 231
015 250 17 03	1864 503 231
015 250 18 03	1864 503 231
015 250 19 03	1878 600 501
015 250 22 03	1878 005 668
015 250 24 03	1878 002 735
015 250 25 03	1862 286 031
015 250 26 03	1878 992 401
015 250 28 03	1878 080 033
015 250 30 03	1878 080 033
015 250 33 01	3000 297 002
015 250 33 01	3000 297 002
015 250 33 03	1862 211 031
015 250 34 01	3000 297 002
015 250 34 01	3000 297 002
015 250 34 03	1878 003 657
015 250 36 03	1878 003 657
015 250 37 01	3000 297 002
015 250 37 03	1878 003 662
015 250 39 03	1878 080 031
015 250 40 01	3000 297 002
015 250 40 03	1878 080 031
015 250 46 03	1878 023 831
015 250 55 03	1862 538 031
015 250 57 01	1888 998 201
015 250 63 03	1878 023 831
015 250 65 03	1862 304 033
015 250 66 03	1862 304 033
015 250 68 03	1862 305 033
015 250 68 03	1862 305 033
015 250 79 03	1878 002 024
015 250 80 03	1878 002 024
015 250 81 03	1878 002 024
015 250 83 03	1878 002 023
015 250 84 03	1878 002 023
015 250 85 03	1878 002 023
015 250 92 03	1878 634 050
015 250 93 03	1862 122 132
015 250 94 03	1862 123 131
015 250 94 03	1862 123 131
015 250 94 03	1878 006 055
015 250 98 03	1878 002 732
015 250 99 03	1878 002 732
016 250 00 03	1878 002 732

Vergleichs-Nr. Compare No.	Artikelnummer Article No.
-------------------------------	------------------------------

MERCEDES-BENZ

016 250 01 03	1878 002 732
016 250 03 03	1878 002 732
016 250 04 03	1878 002 732
016 250 05 03	1878 002 732
016 250 07 03	1878 080 031
016 250 08 03	1878 080 031
016 250 09 03	1878 005 668
016 250 10 03	1878 005 668
016 250 12 03	1878 080 031
016 250 13 03	1878 080 031
016 250 14 03	1878 080 033
016 250 15 03	1878 080 033
016 250 16 03	1878 080 033
016 250 19 03	1878 005 805
016 250 19 03	1878 634 022
016 250 25 03	1878 080 031
016 250 26 03	1878 080 031
016 250 27 03	1878 005 668
016 250 28 01	3000 951 784
016 250 28 03	1878 005 668
016 250 29 01	3000 970 079
016 250 29 03	1878 080 031
016 250 30 03	1878 080 033
016 250 31 03	1878 080 033
016 250 32 03	1878 080 033
016 250 33 03	1878 080 033
016 250 34 03	1878 080 033
016 250 35 03	1878 080 034
016 250 36 03	1878 080 034
016 250 37 03	1878 080 034
016 250 40 03	1878 002 735
016 250 41 03	1878 002 735
016 250 42 03	1878 002 735
016 250 45 03	1878 080 033
016 250 46 03	1878 080 034
016 250 47 03	1878 080 031
016 250 50 03	1878 002 735
016 250 58 03	1864 464 031
016 250 81 03	1878 023 931
016 250 82 03	1878 023 931
016 250 83 03	1878 023 931
016 250 84 03	1878 023 831
016 250 87 03	1862 538 031
016 250 92 03	1864 464 031
016 250 94 03	3400 121 501
016 250 95 03	3400 121 501
016 250 96 03	3400 121 501
016 250 99 03	1878 002 023
017 250 00 03	1878 002 023
017 250 03 03	1878 002 024
017 250 04 03	1878 002 023
017 250 05 03	1878 052 842
017 250 06 03	1878 052 842
017 250 09 03	1878 002 024
017 250 11 03	1878 002 024
017 250 13 03	1878 002 023
017 250 17 03	1878 074 641
017 250 18 03	1878 074 641
017 250 22 03	1878 000 615
017 250 25 03	1862 299 032
017 250 32 03	1862 299 032

Vergleichsliste / Cross reference list

Vergleichs-Nr. Compare No.	Artikelnummer Article No.
-------------------------------	------------------------------

MERCEDES-BENZ

017 250 33 03	1862 299 032
017 250 35 03	1862 299 032
017 250 35 03	1862 299 032
017 250 36 03	1862 299 032
017 250 39 01	3000 970 079
017 250 40 03	1861 963 033
017 250 59 03	3400 121 501
017 250 60 03	3400 121 501
017 250 61 03	3400 121 501
017 250 67 03	1878 002 732
017 250 68 03	1878 002 732
017 250 69 03	1878 002 732
017 250 74 03	1861 936 142
017 250 84 03	1878 080 033
017 250 87 01	3000 970 079
017 250 87 03	1878 080 034
017 250 90 03	1878 080 031
018 250 11 03	1878 002 024
018 250 13 03	1878 002 024
018 250 17 03	1861 936 142
018 250 18 03	1878 023 931
018 250 19 01	3800 710 002
018 250 20 01	3800 710 003
018 250 20 03	1878 080 034
018 250 35 03	1878 008 030
018 250 37 03	1878 001 070
018 250 45 01	1862 962 002
018 250 51 01	3000 970 079
018 250 59 03	1878 002 023
018 250 60 03	1878 002 024
018 250 78 01	3000 970 079
018 250 80 03	1878 004 832
018 250 82 01	3000 970 079
018 250 86 03	1878 002 643
018 250 87 01	3000 970 079
018 250 88 03	1878 002 643
018 250 89 03	1861 936 142
018 250 91 01	3400 122 801
018 250 92 03	1878 052 842
018 250 94 01	3400 127 701
018 250 94 03	1878 080 034
018 250 95 01	3400 121 201
018 250 95 03	1878 080 033
018 250 96 01	3400 121 301
018 250 96 03	1878 080 033
018 250 97 01	3400 121 501
018 250 98 01	3400 700 414
018 250 99 01	3400 122 801
018 250 99 03	1878 080 033
018 981 25 10	1863 869 012
019 250 00 01	3400 122 801
019 250 01 01	3400 122 801
019 250 02 01	3400 700 415
019 250 04 01	3400 700 416
019 250 04 03	1878 080 031
019 250 05 01	3400 122 801
019 250 08 03	1878 080 037
019 250 13 03	1878 065 131
019 250 13 04	3488 000 158
019 250 22 01	3000 951 784
019 250 32 01	3000 970 079

Vergleichs-Nr. Compare No.	Artikelnummer Article No.
-------------------------------	------------------------------

MERCEDES-BENZ

019 250 32 03	1878 080 033
019 250 33 03	1878 080 037
019 250 34 03	1878 080 037
019 250 35 03	1878 002 023
019 250 36 03	1878 003 662
019 250 37 03	1878 003 657
019 250 38 03	1878 003 657
019 250 42 03	1878 052 842
019 250 48 01	3000 951 824
019 250 52 03	1878 002 024
019 250 53 03	1878 002 023
019 250 55 03	1878 002 732
019 250 56 01	3000 726 001
019 250 56 03	1878 002 731
019 250 57 01	3000 826 901
019 250 58 03	1878 002 732
019 250 59 01	3000 951 785
019 250 59 03	1878 002 023
019 250 60 01	3000 951 205
019 250 61 01	3000 726 001
019 250 61 03	1878 002 019
019 250 62 01	3000 846 501
019 250 64 01	1878 600 560
019 250 64 01	3482 000 462
019 250 65 01	3400 121 301
019 250 66 03	1878 080 034
019 250 68 03	1878 080 037
019 250 82 03	1878 003 784
019 250 87 01	3000 951 112
019 250 87 01	3000 970 079
019 250 91 03	1878 052 842
019 250 94 03	1878 023 931
019 250 95 03	1878 023 831
019 250 96 03	1878 023 931
019 250 97 03	1878 023 931
019 250 99 03	1878 023 831
020 250 00 03	1878 023 831
020 250 02 03	1878 023 931
020 250 03 03	1878 023 931
020 250 11 03	1878 003 784
020 250 17 03	1878 051 801
020 250 19 03	1878 002 732
020 250 31 03	1878 600 560
020 250 38 03	1878 002 019
020 250 40 01	3400 700 416
020 250 43 03	1878 002 731
020 250 44 03	1878 002 732
020 250 45 01	3400 121 601
020 250 46 03	1878 002 732
020 250 47 01	3400 123 001
020 250 48 01	3400 124 101
020 250 49 01	3400 124 001
020 250 49 03	1878 006 101
020 250 50 01	3400 122 601
020 250 51 01	3400 122 901
020 250 52 01	3400 700 411
020 250 53 01	3400 125 001
020 250 54 01	3400 700 417
020 250 56 01	3400 122 801
020 250 58 03	1878 080 034
020 250 59 03	1878 080 033

Vergleichs-Nr. Compare No.	Artikelnummer Article No.
-------------------------------	------------------------------

MERCEDES-BENZ

020 250 67 03	1878 080 033
020 250 74 01	3000 951 188
020 250 76 03	1878 004 232
020 250 85 01	3400 122 801
020 250 86 01	3400 122 801
020 250 87 01	3400 700 415
020 250 89 01	3400 122 801
020 250 89 03	1878 002 732
020 250 90 03	1878 080 037
020 250 91 01	3400 700 415
020 250 93 01	3400 700 415
020 250 93 03	1878 002 023
020 250 94 01	3400 700 446
020 250 94 03	1878 002 024
020 250 95 01	3400 700 416
020 250 97 03	1878 080 031
020 250 98 01	1878 002 024
020 250 98 01	3488 000 102
021 250 05 01	3400 700 615
021 250 05 03	1878 001 070
021 250 06 01	3400 122 801
021 250 06 03	1878 005 805
021 250 06 03	1878 634 022
021 250 07 01	3400 121 501
021 250 08 01	3400 122 801
021 250 10 03	1878 023 931
021 250 11 01	3000 970 079
021 250 12 01	3000 951 112
021 250 12 01	3000 970 079
021 250 13 03	1878 007 072
021 250 19 01	3400 700 446
021 250 20 01	3400 700 446
021 250 20 03	1878 002 019
021 250 21 01	3400 700 446
021 250 21 03	1878 002 019
021 250 22 01	3400 700 446
021 250 22 03	1878 002 019
021 250 25 01	3482 000 464
021 250 26 01	3400 700 397
021 250 27 01	3400 700 397
021 250 27 03	1878 002 731
021 250 30 03	1878 007 072
021 250 33 05	3000 951 112
021 250 33 05	3000 970 079
021 250 34 01	3400 127 701
021 250 35 01	3400 127 701
021 250 36 01	3400 121 201
021 250 37 01	3400 121 201
021 250 37 03	1878 002 732
021 250 38 01	3400 121 301
021 250 38 03	1878 002 732
021 250 39 01	3400 121 301
021 250 39 03	1878 002 731
021 250 40 01	1878 002 731
021 250 40 01	3400 700 615
021 250 40 01	3483 030 031
021 250 41 01	1878 002 731
021 250 41 01	3400 700 615
021 250 41 01	3483 030 031
021 250 42 01	3400 122 801
021 250 43 01	3400 122 801

Vergleichs-Nr. Compare No.	Artikelnummer Article No.
-------------------------------	------------------------------

MERCEDES-BENZ

021 250 44 01	3400 700 415
021 250 45 01	3400 700 415
021 250 46 01	3400 700 415
021 250 47 01	3400 700 415
021 250 48 01	3400 700 468
021 250 49 03	1878 007 072
021 250 52 01	1878 002 731
021 250 52 01	3483 000 258
021 250 53 01	1878 002 731
021 250 53 01	3483 000 258
021 250 54 01	3400 700 446
021 250 55 01	3400 700 446
021 250 56 01	3400 700 416
021 250 57 01	3400 700 416
021 250 59 03	1878 023 931
021 250 60 01	3400 700 415
021 250 60 03	1878 052 842
021 250 61 03	1878 052 842
021 250 62 01	3400 122 801
021 250 63 01	3400 122 801
021 250 64 01	3400 700 415
021 250 64 03	1878 023 931
021 250 65 01	3400 700 415
021 250 65 03	1878 023 931
021 250 66 01	1878 002 024
021 250 66 01	3488 000 102
021 250 66 03	1878 023 831
021 250 67 01	1878 002 024
021 250 67 01	3488 000 102
021 250 67 03	1878 023 831
021 250 68 01	3400 121 501
021 250 68 03	1878 023 931
021 250 72 01	3400 700 446
021 250 73 01	3400 700 446
021 250 75 01	3400 700 355
021 250 76 03	1878 002 019
021 250 78 03	1878 002 732
021 250 82 03	1878 002 731
021 250 83 03	1878 002 731
021 250 84 03	1878 002 019
021 250 85 03	1878 002 019
021 250 86 01	3400 122 801
021 250 86 03	1878 007 072
021 250 87 03	1878 002 019
021 250 88 03	1878 002 732
021 250 89 01	3400 121 201
021 250 89 03	1878 002 732
021 250 90 01	3400 121 301
021 250 92 03	1878 002 732
021 250 93 03	1878 002 732
021 250 94 01	3400 122 801
021 250 94 03	1878 006 101
021 250 95 01	3400 122 801
021 250 96 01	3400 700 415
021 250 97 01	3400 122 801
021 250 97 03	1878 002 019
021 250 98 01	3400 700 446
021 250 99 01	3400 700 446
021 252 32 05	3000 970 079
022 250 09 01	3400 122 801
022 250 11 01	3400 122 801

Vergleichs-Nr. Compare No.	Artikelnummer Article No.
-------------------------------	------------------------------

MERCEDES-BENZ

022 250 13 03	1861 919 134
022 250 14 01	3400 700 415
022 250 15 01	3400 122 801
022 250 15 03	1878 002 019
022 250 16 01	3400 700 446
022 250 17 01	3400 700 415
022 250 20 01	1878 002 731
022 250 20 01	3400 700 615
022 250 20 01	3483 030 031
022 250 23 01	1878 002 731
022 250 23 01	3483 000 258
022 250 26 01	3400 700 446
022 250 30 01	3400 700 468
022 250 32 01	3400 700 416
022 250 32 03	1878 004 232
022 250 33 01	3400 700 416
022 250 36 01	1878 002 731
022 250 36 01	3483 000 139
022 250 38 01	3400 122 801
022 250 39 01	3400 700 415
022 250 43 01	3400 700 355
022 250 44 01	3400 700 355
022 250 48 01	3400 121 501
022 250 49 01	1878 002 024
022 250 49 01	3488 000 102
022 250 52 01	3400 121 501
022 250 55 01	1878 002 731
022 250 55 01	3400 700 615
022 250 55 01	3483 030 031
022 250 56 01	3400 122 801
022 250 57 01	3400 122 801
022 250 58 01	3400 121 201
022 250 59 01	3400 121 201
022 250 59 03	1878 080 033
022 250 60 01	3400 700 397
022 250 61 01	3400 700 397
022 250 61 03	1878 080 037
022 250 62 01	3400 121 301
022 250 63 01	3400 121 301
022 250 81 01	1878 600 560
022 250 81 01	3482 000 462
022 250 81 03	1878 023 931
022 250 82 03	1878 023 931
022 250 84 03	1878 004 232
022 250 85 03	1878 004 232
022 250 87 03	1878 023 831
022 250 88 03	1878 023 831
022 250 89 03	1878 006 637
022 250 97 03	1878 600 560
023 250 02 01	3000 950 932
023 250 06 03	1878 006 101
023 250 13 03	1878 006 757
023 250 15 01	3400 700 534
023 250 16 01	3400 700 534
023 250 17 01	3400 700 533
023 250 18 01	3400 700 533
023 250 29 01	3400 700 529
023 250 30 01	3400 700 529
023 250 41 01	3400 700 530
023 250 60 01	3400 700 609
023 250 61 01	3400 700 609

Vergleichs-Nr. Compare No.	Artikelnummer Article No.
-------------------------------	------------------------------

MERCEDES-BENZ

023 250 66 01	3400 700 638
023 250 68 01	3400 700 532
023 250 69 01	3400 700 532
023 250 69 03	1878 006 757
023 250 74 01	3400 700 638
023 250 82 01	3000 951 824
023 250 83 01	3000 951 188
023 250 92 01	3400 700 477
023 250 94 01	3400 700 530
024 250 01 01	1878 002 731
024 250 01 01	3400 700 615
024 250 01 01	3483 030 031
024 250 02 01	1878 002 731
024 250 02 01	3400 700 615
024 250 02 01	3483 030 031
024 250 04 01	1878 002 731
024 250 04 01	3400 700 615
024 250 04 01	3483 030 031
024 250 05 01	3400 122 801
024 250 06 01	3400 122 801
024 250 06 03	1878 002 019
024 250 08 01	3400 122 801
024 250 09 01	3400 700 415
024 250 10 01	3400 700 415
024 250 12 01	3400 700 415
024 250 14 01	3400 700 415
024 250 15 01	3400 700 415
024 250 17 01	3400 700 415
024 250 17 03	1878 052 842
024 250 19 01	3400 700 416
024 250 21 01	1878 002 731
024 250 21 01	3483 000 258
024 250 21 03	1878 052 842
024 250 22 01	1878 002 731
024 250 22 01	3483 000 258
024 250 22 04	3400 700 446
024 250 24 01	1878 002 731
024 250 24 01	3483 000 258
024 250 25 01	3400 700 446
024 250 26 01	3400 700 446
024 250 28 01	3400 700 446
024 250 29 01	3400 700 416
024 250 30 01	3400 700 416
024 250 32 01	3400 700 416
024 250 34 01	1878 002 731
024 250 34 01	3483 000 139
024 250 37 01	3400 700 415
024 250 38 01	3400 700 415
024 250 40 01	3400 700 415
024 250 41 01	1878 002 024
024 250 41 01	3488 000 102
024 250 42 01	1878 002 024
024 250 42 01	3488 000 102
024 250 44 01	1878 002 024
024 250 44 01	3488 000 102
024 250 45 01	3400 121 501
024 250 46 01	3400 121 501
024 250 48 01	3400 121 501
024 250 49 01	3400 121 501
024 250 51 01	3400 700 355
024 250 52 01	3400 700 355

Vergleichsliste / Cross reference list

Vergleichs-Nr. Compare No.	Artikelnummer Article No.
-------------------------------	------------------------------

MERCEDES-BENZ

024 250 56 01	3400 700 468
024 250 57 01	3400 700 468
024 250 72 03	1878 007 185
024 250 73 03	1878 007 185
024 250 74 01	1878 002 731
024 250 74 01	3400 700 615
024 250 74 01	3483 030 031
024 250 75 01	3400 122 801
024 250 76 01	3000 951 824
024 250 82 01	3400 700 530
024 250 83 01	3400 700 530
024 250 88 03	1878 007 732
024 250 97 03	1878 006 173
025 250 03 01	3400 700 530
025 250 07 01	3400 700 546
025 250 08 01	3400 700 546
025 250 23 01	3400 127 701
025 250 25 01	3400 127 701
025 250 38 03	1878 002 731
025 250 39 03	1878 002 731
025 250 41 03	1878 007 072
025 250 42 03	1878 007 072
025 250 43 03	1878 007 072
025 250 44 03	1878 002 732
025 250 45 03	1878 002 732
025 250 46 03	1878 002 732
025 250 47 03	1878 002 732
025 250 50 03	1878 006 101
025 250 55 01	3400 700 546
025 250 56 01	3400 700 546
025 250 57 01	3400 700 535
025 250 58 01	3400 700 535
025 250 60 01	3400 700 529
025 250 70 01	3000 951 188
025 250 74 01	3400 700 639
025 250 76 01	3400 700 546
025 250 77 01	3400 700 546
025 250 82 01	3000 970 079
025 250 83 01	3000 951 112
025 250 83 01	3000 970 079
025 250 84 01	3400 122 801
025 250 85 01	3400 122 801
025 250 87 01	3400 700 355
026 250 07 03	1878 002 731
026 250 08 03	1878 002 731
026 250 09 03	1878 007 072
026 250 10 03	1878 007 072
026 250 11 03	1878 002 732
026 250 12 03	1878 002 732
026 250 13 03	1878 006 101
026 250 14 03	1878 006 101
026 250 26 01	3400 700 535
026 250 27 01	3400 700 535
026 250 36 01	3400 122 801
026 250 37 01	3400 700 446
026 250 41 01	3400 700 415
026 250 42 01	3400 700 415
026 250 43 01	3400 122 801
026 250 44 01	3400 122 801
026 250 45 01	3400 122 801
026 250 46 01	3400 700 615

Vergleichs-Nr. Compare No.	Artikelnummer Article No.
-------------------------------	------------------------------

MERCEDES-BENZ

026 250 47 01	1878 002 731
026 250 47 01	3400 700 615
026 250 47 01	3483 030 031
026 250 48 01	3400 700 468
026 250 49 01	3400 122 801
026 250 50 01	1878 002 731
026 250 50 01	3483 000 258
026 250 51 01	3400 700 446
026 250 52 01	3400 700 446
026 250 53 01	3400 122 801
026 250 54 01	3400 700 416
026 250 55 01	3400 700 416
026 250 56 01	1878 002 731
026 250 56 01	3483 000 139
026 250 57 01	1878 007 072
026 250 57 01	3483 000 461
026 250 58 01	1878 002 731
026 250 59 01	1878 007 072
026 250 59 01	3483 000 461
026 250 63 01	3400 700 621
026 250 64 01	3400 700 415
026 250 65 01	3400 700 415
026 250 66 01	1878 002 731
026 250 66 01	3400 700 615
026 250 66 01	3483 030 031
026 250 67 01	3400 700 468
026 250 68 01	3400 122 801
026 250 69 01	3400 122 801
026 250 70 01	1878 002 731
026 250 70 01	3483 000 258
026 250 78 01	3400 700 355
026 250 79 01	3400 700 355
026 250 81 01	3400 700 355
026 250 83 01	1878 002 019
026 250 83 01	3488 000 102
026 250 84 01	1878 002 019
026 250 84 01	3488 000 102
026 250 85 01	3400 700 355
026 250 89 01	3400 700 615
026 250 90 01	3400 700 615
026 250 91 01	3400 122 801
026 250 92 01	3400 122 801
026 250 93 01	3400 700 415
026 250 94 01	3400 700 415
026 250 95 01	3400 700 415
026 250 96 01	3400 700 415
026 250 97 01	3400 700 468
026 250 98 01	3400 700 468
026 250 99 01	3400 700 617
027 250 00 01	3400 700 617
027 250 01 01	3400 700 446
027 250 02 01	3400 700 446
027 250 03 01	3400 700 416
027 250 04 01	3400 700 416
027 250 05 01	1878 002 731
027 250 05 01	3483 000 139
027 250 06 01	1878 002 731
027 250 06 01	3483 000 139
027 250 09 01	1878 007 072
027 250 09 01	3483 000 461
027 250 10 01	1878 007 072

Vergleichs-Nr. Compare No.	Artikelnummer Article No.
-------------------------------	------------------------------

MERCEDES-BENZ

027 250 10 01	3483 000 461
027 250 11 01	3400 122 801
027 250 12 01	3400 122 801
027 250 13 01	3400 700 446
027 250 14 01	3400 700 446
027 250 16 01	3400 700 355
027 250 17 01	3400 700 355
027 250 34 01	3400 700 477
027 250 37 01	3400 700 530
027 250 38 01	3400 700 530
027 250 39 01	3400 700 531
027 250 40 01	3400 700 531
027 250 41 01	3400 700 529
027 250 42 01	3400 700 529
028 250 03 01	3400 700 530
028 250 05 01	3400 700 534
028 250 06 01	3400 700 534
028 250 07 01	3400 700 535
028 250 08 01	3400 700 535
028 250 12 01	3400 700 415
028 250 13 01	3400 700 415
028 250 14 01	3400 122 801
028 250 15 01	3400 122 801
028 250 16 01	3400 700 615
028 250 17 01	3400 700 615
028 250 18 01	3400 700 468
028 250 19 01	3400 700 468
028 250 20 01	3400 122 801
028 250 21 01	3400 122 801
028 250 22 01	3400 700 617
028 250 23 01	3400 700 617
028 250 24 01	3400 700 446
028 250 25 01	3400 700 446
028 250 26 01	3400 700 446
028 250 27 01	3400 700 446
028 250 28 01	3400 700 416
028 250 29 01	3400 700 416
028 250 30 01	1878 002 731
028 250 30 01	3483 000 139
028 250 31 01	1878 002 731
028 250 31 01	3483 000 139
028 250 34 01	1878 007 072
028 250 34 01	3483 000 461
028 250 35 01	1878 007 072
028 250 35 01	3483 000 461
028 250 37 01	3400 700 542
028 250 38 01	3400 700 542
028 250 44 01	3400 700 531
028 250 47 01	3400 700 533
028 250 48 01	3400 700 533
028 250 49 01	3400 700 545
028 250 50 01	3400 700 545
102 980 03 15	1863 869 010
102 981 01 25	1863 869 010
115 980 00 15	1863 869 010
115 980 01 15	1863 869 010
121 250 01 04	1881 059 208
121 250 02 04	1881 059 208
121 250 03 04	1881 059 208
136 250 00 04	1881 059 208
136 250 04 03	1861 123 236

Vergleichs-Nr. Compare No.	Artikelnummer Article No.
-------------------------------	------------------------------

MERCEDES-BENZ

136 250 05 03	1861 123 236
180 250 03 03	1861 123 236
180 250 03 04	1881 059 208
180 250 04 04	1881 059 208
180 250 06 04	1881 059 208
180 250 07 04	1881 059 208
187 250 05 03	1861 123 236
303 250 00 05	1861 034 147
304 250 01 04	1881 039 532
304 252 00 05	1861 034 147
305 250 00 15	3151 094 041
305 250 06 15	3151 094 041
308 250 00 04	1882 205 234
312 250 13 15	3151 095 043
317 250 02 04	1881 041 656
317 250 04 03	1878 000 104
319 250 03 03	1861 123 236
319 250 04 03	1861 123 236
319 250 06 03	1861 123 236
319 250 07 03	1861 123 236
319 250 09 03	1861 123 236
319 250 10 03	1861 123 236
319 250 13 03	1861 123 236
320 250 00 15	3151 000 529
327 250 01 15	3151 094 041
327 250 11 15	3151 094 041
330 250 00 04	1881 039 532
340 250 02 15	3151 095 043
343 254 00 10	3151 000 529
344 250 72 03	1878 000 104
345 250 70 04	1882 166 737
345 250 74 03	1861 303 248
345 250 75 03	1861 303 248
350 250 70 04	1882 301 239
352 250 01 15	3151 095 043
352 250 05 15	3151 095 043
364 250 70 03	1861 470 234
371 250 71 03	1878 026 431
381 250 04 15	3151 044 031
385 250 00 14	3189 600 060
415 250 00 01	3000 951 128
415 250 00 15	3182 654 204
415 250 01 15	3182 654 169
415 250 05 01	3000 951 128
415 290 00 13	6284 600 694
415 290 01 13	6284 600 666
443 250 00 15	1863 837 002
443 250 00 15	1863 855 000
457 030 13 05	6594 000 079
457 030 21 05	6594 000 079
457 030 23 05	6594 000 079
457 030 26 05	6594 000 079
457 030 32 05	6594 000 079
457 030 38 05	6594 000 079
457 030 43 05	6594 000 079
457 030 44 05	6594 000 079
470 030 15 05	6594 000 218
470 030 24 05	6594 000 218
471 030 26 05	6594 000 219
471 030 69 05	6594 000 219
541 030 03 05	6594 000 080

Vergleichs-Nr. Compare No.	Artikelnummer Article No.
-------------------------------	------------------------------

MERCEDES-BENZ

541 030 07 05	6594 000 080
541 030 08 05	6594 000 080
541 030 11 05	6594 000 080
541 030 12 05	6594 000 080
541 030 15 05	6594 000 080
543 030 08 05	6594 000 080
601 030 10 05	2294 000 767
601 030 15 05	2294 000 767
601 030 16 05	2294 000 767
601 030 17 05	2294 000 767
602 030 21 05	2294 000 525
602 030 23 05	2294 000 525
608 250 00 03	1878 634 064
608 250 00 15	3151 270 602
611 030 04 05	2294 001 744
611 030 10 05	2294 001 744
611 030 14 05	2294 001 744
611 030 16 05	2294 001 744
611 030 17 05	2294 001 744
620 254 01 08	3189 600 060
631 250 00 04	3082 191 032
631 250 01 15	3151 198 031
631 250 02 04	3082 191 032
631 250 03 03	1862 375 031
631 250 03 04	3082 191 032
631 250 03 15	3151 198 031
631 250 04 03	1862 375 031
631 250 04 04	3082 191 032
631 290 00 12	6284 600 111
631 293 02 38	3074 600 205
639 290 00 12	6284 605 008
639 290 01 12	6284 605 008
646 030 01 05	2294 001 744
646 030 04 05	2294 001 744
646 030 05 05	2294 000 834
646 030 06 05	2294 001 744
646 030 08 05	2294 000 834
646 030 09 05	2294 000 834
646 030 13 05	2294 000 835
646 030 21 05	2294 000 835
650 250 38 13	3189 600 059
650 254 00 06	3189 600 059
651 030 31 05	2294 000 994
651 030 40 05	2294 000 994
651 030 51 05	2294 000 994
655 250 15 13	3189 600 057
655 254 02 06	3189 600 058
661 250 30 15	3151 000 206
684 250 40 15	3151 000 020
684 254 40 20	3163 030 100
685 250 04 03	1878 001 939
685 250 04 03	1878 006 757
685 250 04 03	1878 006 757
685 250 12 03	1878 004 094
690 250 74 03	1878 000 615
695 250 70 03	1861 777 043
695 250 71 04	3482 000 953
906 290 01 12	6284 605 004
906 290 02 12	6284 605 004
906 981 04 25	1863 869 040
906 981 14 25	1863 869 044

Vergleichs-Nr. Compare No.	Artikelnummer Article No.
-------------------------------	------------------------------

MERCEDES-BENZ

940 250 02 13	3189 600 058
949 250 00 04	3482 000 679

MITSUBISHI

DM029	3400 700 384
MD701283	1863 600 128
ME500194	3400 700 384
ME500237	3400 700 384
ME500850	3400 700 388
ME500906	3400 700 388
ME521046	3400 700 386
ME521103	3400 700 386
ME600340	3400 700 384
ME600340	3400 700 388
ME615141	3400 700 386

NEOPLAN

N10106-8881	1878 085 641
N101100-9968	3488 017 410
N1011009971	3482 083 032
N1011009972	3482 083 118
N1011009996	1878 005 805
N1011009996	1878 634 022
N101101-0036	3151 186 001
N10116-8876	6594 000 080
0101.110.06	3151 110 031
0401.101.00	1882 301 239
0401.101.10	1878 002 706
0401.101.11	1878 002 706
0401.101.21	1878 002 706
0401.103.00	1882 302 131
0401.105.00	1882 311 131
0401.106.00	1881 041 656
0401.107.00	3482 124 516
0401.108.00	1882 342 134
0401.108.01	1888 042 009
0401.109.00	3482 001 234
0401.109.00	3482 119 034
0401.110.00	3482 006 036
0401.110.0099	3482 006 036
0401.112.00	3482 000 953
0401.113.00	3482 002 234
0401.113.00	3482 002 234
0401.113.01	1878 001 070
0401.113.05	1878 001 077
0401.115.01	1878 000 968
0401.116.10	3151 108 031
0401.117.000	3482 124 532
0401.145.00	1878 003 320
0401.149.00	1878 000 104
0401.150.00	1878 002 706
0401.151.00	1878 001 154
0401.152.10	1861 777 037
0401.155.00	1861 923 032
0401.155.00	1878 001 152
0401.170.10	3482 124 522
0401.172.00	3151 000 515
0401.174.73	1863 101 100
0401.175.00	3151 119 001
0401.191.00	1861 911 232
0401.192.00	3151 000 395
0401.202.64	1861 303 248

Vergleichsliste / Cross reference list

Vergleichs-Nr. Compare No.	Artikelnummer Article No.
NEOPLAN	
0401.202.68	1861 206 211
0401.202.83	1881 039 531
0401.202.89	1882 252 331
0401.202.90	3482 124 541
0401.400.00	3082 156 031
0401.403.00	1882 305 131
0401.404.01	3082 190 031
0401.406.00	3482 008 038
0401.410.00	1861 574 132
0401.412.00	1861 571 236
0401.414.00	1878 634 064
0401.423.00	1861 777 037
0401.423.01	3482 060 233
0401.423.01	3482 060 233
0401.424.41	1878 003 657
0401.434.01	1805 042 000
0401.451.00	1878 003 238
0421.000.00	1882 301 238
0421.000.00	3482 124 541
0421.003.00	3482 000 953
0421.006.00	1888 042 009
0421.007.00	3482 017 033
0421.009.00	3482 018 132
0421.009.00	3482 119 031
0421.010.00	1882 342 134
0421.010.0099	1882 342 134
0421.014.00	3482 083 113
0421.015.00	3482 002 234
0421.016.00	3488 017 410
0421.018.00	3482 083 032
0421.019.00	3482 083 118
0421.020.00	3482 017 035
0421.031.100	1862 123 131
0421.035.300	1878 080 034
0421.301.00	1861 777 037
0421.306.00	1878 000 968
0421.317.00	1861 470 234
0421.318.00	1878 086 941
0421.320.00	1878 086 941
0421.321.00	1878 003 657
0421.323.00	1878 005 805
0421.323.00	1878 634 022
0421.324.00	1878 004 832
0421.327.00	1878 085 742
0421.327.10	1878 080 031
0421.330.00	1878 000 957
0421.332.00	1878 001 152
0421.333.00	1878 001 152
0421.342.00	1878 005 805
0421.342.00	1878 634 023
0421.346.00	3482 000 463
0421.347.10	1878 080 033
0421.354.00	1878 080 033
0421.354.00	1878 080 033
0421.503.00	3151 186 001
0421.505.00	3151 202 002
0421.509.00	3151 000 958
0421.517.00	3151 000 419
11000033	3151 000 375
11009713	1878 002 706
11009717	3482 124 516

Vergleichs-Nr. Compare No.	Artikelnummer Article No.
NEOPLAN	
11009718	1878 002 706
11009721	3482 002 234
11009721	3482 002 234
11009727	3482 124 532
11009728	3482 124 533
11009733	1878 001 070
11009734	3151 000 515
11009747	3151 119 001
11009755	1861 577 037
11009760	3082 156 031
11009848	3151 069 131
11009848	3151 069 131
11009965	3482 119 031
11009966	1882 342 134
11009967	1888 055 247
11009968	3488 017 410
11009971	3482 083 032
11009972	3482 083 118
11009977	3482 017 035
11009979	3482 081 232
11009981	3482 062 035
11009981	3482 083 252
11009985	3482 083 032
11009986	3482 083 032
11009989	1862 123 131
11009989	1878 006 055
11009990	1862 122 132
11009993	1878 086 941
11009994	1878 003 657
11009996	1878 005 805
11009996	1878 634 022
11009997	1878 004 832
11010000	1878 004 832
11010002	1878 085 742
11010003	1878 080 033
11010004	1862 506 131
11010005	1878 080 031
11010012	1878 003 658
11010013	1878 085 641
11010013	1878 085 641
11010031	1878 080 034
11010032	1878 080 033
11010036	3151 186 001
11010038	3151 202 002
11010039	3151 000 547
11010042	3151 000 157
11060226	1878 004 832
11068876	6594 000 080
11068877	6594 000 124
11068881	1878 085 641
110688875	6594 000 079
11079828	1878 080 037
11079830	1878 004 832
11079872	1878 080 033
14008832	1878 003 657
20268	1861 206 211
20275	1878 001 070
20276	1878 000 105
20278	1878 002 706
20279	1878 001 136
20280	1878 003 657

Vergleichs-Nr. Compare No.	Artikelnummer Article No.
NEOPLAN	
20281	1878 002 706
20283	1881 039 531
20285	1881 041 656
20285	1881 041 656
20289	1882 252 331
20291	1882 311 131
20292	1882 302 131
20293	1882 301 239
20294	3482 124 516
20295	1882 342 134
20296	1882 301 238
20296	3482 124 541
20297	1882 301 239
NISSAN	
16100147-0	3082 956 001
16200147-1	3082 956 001
16200147-2	3082 956 001
16205050-0	3082 956 001
2117 3125	1878 003 867
21170-00QAA-	1863 869 009
21170-00QAC-	1863 869 009
21173118	3482 001 307
21173120	3482 000 553
21173120	3482 001 308
21173127	1878 006 129
21173129	3488 000 159
21173130	1878 003 768
21465240	6482 000 155
21581661	1878 006 129
21593956	1878 006 129
23354-00QAD-	3000 951 128
30001-F3729	3000 951 373
30001-00QAE-	3000 951 103
30001-00QAK-	3000 951 103
30001-00Q0K-	3000 951 103
30001-00Q3D-	3400 700 515
30001-9X426	3000 951 373
30001-9X430	3000 951 373
30100-00Q0F-	1878 007 204
30210-00Q0B-	3082 600 568
30502-00Q0A	3151 600 529
30502-00Q0B	3151 600 529
30502-69F10-	1863 600 116
30570-00QAA-	3182 654 142
30570-00QAC-	3182 654 142
30570-00Q0D-	3182 654 142
30570-00Q0E-	3182 654 142
30570-00Q0L-	3182 654 142
306A0-JA60A-	3182 654 169
306A0-JA60B-	3182 654 169
306A0-JA60C-	3182 654 169
30610-00QAB-	6284 600 736
30610-00QAG-	6284 600 736
30620-00Q0H-	3182 654 169
30620-1473R	3182 654 169
32150-00QAA	3182 654 169
32150-00QAB-	3182 654 169
32150-00QAC-	3182 654 169
32150-00QAD-	3182 654 169
32202-1329R-	1863 869 009

Vergleichs-Nr. Compare No.	Artikelnummer Article No.
-------------------------------	------------------------------

NISSAN

328D0-00Q0A-	3981 000 093
77014-73307	3000 951 103
82000-31239	6284 600 736
82001-24021	3182 654 142

**ÖSTERREICHISCHE
AUTOMOBILFABRIK (ÖAF)**

81.30301.0228	1878 001 152
81.30301.0250	1861 911 232
81.30301.0260	1861 841 132
81.30301.0261	1862 219 031
81.30301.0270	1861 876 134
81.30301.0279	1878 001 077
81.30301.0284	1878 000 957
81.30301.0288	1861 777 037
81.30301.0291	1878 002 706
81.30301.0293	1878 001 144
81.30301.0293	1878 001 147
81.30301.0299	1862 303 031
81.30301.0306	1878 005 367
81.30301.0327	1878 004 832
81.30301.0342	1878 001 154
81.30301.0343	1878 002 706
81.30301.0351	1862 364 133
81.30301.0355	1878 080 034
81.30301.0364	1878 080 034
81.30301.0376	1878 080 034
81.30301.0377	1878 080 031
81.30301.0380	1862 438 032
81.30301.0381	1878 080 034
81.30301.0382	1878 080 034
81.30301.0385	1878 080 034
81.30301.0386	1878 080 034
81.30301.0388	1878 080 034
81.30301.0459	1878 080 034
81.30301.9381	1878 080 034
81.30305.0056	1882 209 335
81.30305.0079	1882 302 131
81.30305.0099	3482 032 331
81.30305.0109	3482 006 036
81.30305.0112	3482 008 110
81.30305.0113	1882 342 134
81.30305.0120	3482 017 033
81.30305.0123	1882 346 131
81.30305.0124	1882 342 134
81.30305.0137	1882 342 135
81.30305.0137	3482 124 549
81.30305.0158	3482 083 032
81.30305.0161	3482 008 141
81.30305.0162	3482 060 132
81.30305.0163	3482 017 035
81.30305.0164	1888 015 346
81.30305.0170	1882 017 131
81.30305.0172	3482 085 034
81.30305.0178	3482 078 133
81.30305.0184	3482 093 032
81.30305.0186	3482 102 031
81.30305.0187	3482 102 031
81.30305.0189	3482 062 035
81.30305.0189	3482 083 252
81.30305.0190	3482 086 132

Vergleichs-Nr. Compare No.	Artikelnummer Article No.
-------------------------------	------------------------------

**ÖSTERREICHISCHE
AUTOMOBILFABRIK (ÖAF)**

81.30305.0191	3482 083 032
81.30305.0192	3488 017 333
81.30305.0193	3482 083 032
81.30305.0197	3482 114 031
81.30305.0198	3482 000 467
81.30305.0226	3482 114 031
81.30305.9193	3482 083 032
81.30401.7009	1882 110 532
81.30550.0040	1863 009 100
81.30550.0049	3151 000 515
81.30550.0050	3151 000 395
81.30550.0054	3151 000 958
81.30550.0056	3151 067 032
81.30550.0079	3182 005 231
81.32412.0003	3151 032 341
82.30301.0044	1878 022 841
82.30305.0020	1888 042 009
84.30301.0005	1878 065 131

RENAULT TRUCKS

0000 075 288	3482 124 534
0000 165 155	1864 497 042
0000 165 655	1864 497 042
0001 140 732	3482 037 141
0001 140 733	1878 000 960
0001 141 034	1878 001 138
0001 141 035	3151 000 515
0001 144 060	1878 022 841
0001 150 513	1878 000 960
0001 151 423	1878 022 841
0001 151 855	3151 270 341
0001 151 856	1878 001 729
0001 151 857	3482 124 041
0001 152 310	1878 020 241
0001 154 566	1878 020 241
0003 272 816	3499 373 055
0003 722 816	3499 373 055
0023 618 037	1878 000 104
0023 618 127	3482 008 033
0023 618 130	1878 000 960
0023 618 133	3482 037 141
0023 618 140	3151 111 032
0023 618 153	1878 000 960
0023 618 156	1864 497 043
0023 618 158	1878 634 014
0023 618 162	1861 577 037
0023 618 190	3482 037 141
0023 618 195	1864 497 042
0023 818 037	1878 000 104
50 10 245 703	1878 039 631
50 10 613 218	3482 001 199
5000 028 321	3100 008 106
5000 053 508	3482 037 141
5000 055 186	3499 373 055
5000 055 986	3499 373 055
5000 056 638	1850 280 790
5000 057 139	1864 454 101
5000 057 463	1862 353 041
5000 058 221	3151 199 001
5000 059 526	1878 026 241

Vergleichs-Nr. Compare No.	Artikelnummer Article No.
-------------------------------	------------------------------

RENAULT TRUCKS

5000 240 864	3151 199 001
5000 240 959	3482 124 534
5000 241 345	1882 261 013
5000 241 347	3151 111 032
5000 243 161	1861 206 211
5000 243 162	1878 001 136
5000 244 067	1878 049 041
5000 249 083	3482 124 041
5000 249 102	1850 280 790
5000 251 317	1861 034 147
5000 251 352	1882 110 532
5000 273 023	1878 005 367
5000 280 176	3482 124 534
5000 280 176	3482 124 541
5000 280 374	1878 005 367
5000 289 010	1878 000 964
5000 293 627	1863 869 041
5000 295 069	1878 001 144
5000 295 069	1878 001 147
5000 295 253	3400 116 601
5000 295 254	3400 116 601
5000 295 255	3400 116 801
5000 295 256	3400 116 801
5000 295 408	1878 005 367
5000 296 267	1862 353 041
5000 296 325	1864 497 042
5000 326 700	3151 082 001
5000 326 766	3151 082 001
5000 404 186	3151 600 751
5000 404 380	1878 001 713
5000 404 672	1850 280 790
5000 404 673	1878 001 713
5000 436 366	3151 270 341
5000 446 366	3151 270 341
5000 455 001	3482 002 234
5000 455 001	3482 002 234
5000 456 366	3151 270 341
5000 456 369	1861 577 037
5000 456 388	3482 008 033
5000 534 562	1850 280 790
5000 534 738	3482 037 141
5000 534 846	3151 270 341
5000 534 850	3482 124 041
5000 559 741	1878 000 105
5000 587 571	1878 002 706
5000 589 570	3482 124 534
5000 589 571	1878 002 706
5000 612 839	1864 454 101
5000 613 038	3151 079 031
5000 613 533	1864 454 101
5000 613 602	1864 454 101
5000 613 602	1878 001 729
5000 613 650	3151 199 001
5000 652 893	1897 375 775
5000 660 946	1878 027 442
5000 660 956	3482 124 041
5000 660 978	1878 001 729
5000 667 054	1878 020 241
5000 667 267	1878 002 075
5000 670 325	1864 497 042
5000 677 001	1878 027 442

Vergleichsliste / Cross reference list

Vergleichs-Nr. Compare No.	Artikelnummer Article No.
--------------------------------------	-------------------------------------

RENAULT TRUCKS

5000 677 007	1878 020 241
5000 677 053	1878 022 841
5000 677 054	1878 027 442
5000 677 055	1878 022 841
5000 677 060	3482 123 441
5000 677 064	1861 577 037
5000 677 072	1861 577 037
5000 677 073	3482 060 233
5000 677 074	1864 454 101
5000 677 075	3151 199 001
5000 677 087	1878 001 729
5000 677 090	3400 700 630
5000 677 092	3482 097 141
5000 677 095	3482 097 141
5000 677 134	1878 020 241
5000 677 135	1878 027 442
5000 677 138	1878 027 442
5000 677 154	1878 020 241
5000 677 165	1862 379 031
5000 677 176	1861 577 037
5000 677 178	1861 577 037
5000 677 180	3151 600 544
5000 677 194	3482 092 031
5000 677 196	1878 001 713
5000 677 199	3482 008 033
5000 677 200	1878 027 442
5000 677 208	1882 022 101
5000 677 208	1882 022 101
5000 677 211	1878 001 727
5000 677 216	1878 049 041
5000 677 221	1878 001 727
5000 677 230	3482 083 044
5000 677 232	3488 017 334
5000 677 243	1878 020 241
5000 677 249	1878 026 241
5000 677 250	1878 027 442
5000 677 251	1878 027 442
5000 677 252	1864 497 043
5000 677 254	1878 022 841
5000 677 263	3482 060 233
5000 677 264	1878 001 077
5000 677 267	1878 002 075
5000 677 268	1878 001 729
5000 677 276	3100 008 106
5000 677 279	3482 097 141
5000 677 285	1878 022 841
5000 677 294	1862 380 031
5000 677 295	1862 379 031
5000 677 302	3151 000 285
5000 677 307	3482 094 031
5000 677 309	1897 375 775
5000 677 311	3151 270 341
5000 677 313	3100 008 204
5000 677 316	3482 123 243
5000 677 317	3482 083 044
5000 677 323	3482 083 044
5000 677 328	1878 020 241
5000 677 343	1878 020 241
5000 738 593	1864 454 101
5000 783 593	1864 454 101
5000 783 985	1864 497 043

Vergleichs-Nr. Compare No.	Artikelnummer Article No.
--------------------------------------	-------------------------------------

RENAULT TRUCKS

5000 785 114	1878 003 276
5000 785 115	1882 022 101
5000 785 115	1882 022 101
5000 786 263	3151 000 285
5000 787 645	3100 008 106
5000 787 647	3100 008 106
5000 787 648	3482 097 141
5000 787 649	3482 097 141
5000 787 976	1878 002 075
5000 788 292	1878 020 241
5000 788 292	1878 027 442
5000 788 573	3482 124 041
5000 788 792	1878 027 442
5000 789 351	1878 000 104
5000 789 974	3482 124 041
5000 789 975	3482 124 041
5000 789 976	3482 124 041
5000 790 457	1878 002 075
5000 790 518	1864 497 043
5000 790 602	3482 124 041
5000 790 604	3482 060 233
5000 790 604	3482 060 233
5000 790 959	1878 027 442
5000 790 959	1878 027 442
5000 798 974	3482 060 233
5000 806 462	3151 032 341
5000 807 806	3151 067 032
5000 809 155	3151 199 001
5000 819 904	3100 008 106
5000 821 016	3100 008 106
5000 821 053	1878 001 152
5000 821 820	1878 000 104
5000 822 147	1878 002 706
5000 822 585	3151 204 001
5000 826 290	3499 373 055
5000 826 295	3482 037 141
5000 826 296	3482 037 141
5000 826 314	3482 124 041
5000 826 397	3482 097 141
5000 835 199	3100 008 106
5000 841 290	3499 373 055
5000 841 295	3482 037 141
5000 841 296	3482 037 141
5000 841 309	1882 110 532
5000 841 312	1882 302 131
5000 841 313	1882 330 032
5000 841 315	3482 002 234
5000 841 315	3482 002 234
5000 841 397	3482 097 141
5000 841 398	3100 008 106
5000 841 398	3482 097 141
5000249782	3482 097 141
5000297145	3482 123 441
5000677244	1878 020 241
5001 001 621	1878 001 144
5001 001 621	1878 001 147
5001 001 622	3151 000 958
5001 001 623	3151 000 395
5001 001 628	1878 001 152
5001 001 629	1882 302 131
5001 013 872	1882 022 101

Vergleichs-Nr. Compare No.	Artikelnummer Article No.
--------------------------------------	-------------------------------------

RENAULT TRUCKS

5001 014 737	3482 124 041
5001 486 489	3400 700 408
5001 677 232	3488 017 334
5001 811 639	3400 700 444
5001 821 908	3488 017 334
5001 824 450	1878 022 841
5001 824 773	3482 123 243
5001 825 675	3482 083 044
5001 825 689	3100 008 204
5001 825 886	3400 093 031
5001 825 887	3400 093 031
5001 825 889	3488 017 334
5001 825 897	3400 093 031
5001 829 253	3482 000 270
5001 829 253	3482 037 141
5001 830 115	1878 002 075
5001 830 413	3483 000 510
5001 830 900	3400 116 701
5001 830 905	3400 117 001
5001 830 909	3400 117 101
5001 830 914	3400 116 901
5001 830 917	1850 280 790
5001 830 917	1878 001 713
5001 830 917	3151 600 751
5001 830 920	1897 375 775
5001 830 920	3499 373 055
5001 830 936	3400 117 301
5001 830 942	3400 700 339
5001 830 945	3151 000 285
5001 830 945	3482 037 141
5001 830 948	1864 497 042
5001 834 837	3482 060 233
5001 836 428	3400 700 341
5001 836 993	3496 006 000
5001 837 123	3482 083 252
5001 838 967	3400 117 301
5001 843 357	3400 117 631
5001 843 361	3400 117 532
5001 845 014	3400 700 339
5001 845 035	1882 022 101
5001 846 492	3400 123 401
5001 846 505	3400 123 401
5001 846 524	3400 117 202
5001 848 241	3400 700 338
5001 848 242	3400 700 480
5001 850 289	1878 051 801
5001 850 395	3400 700 337
5001 850 396	3400 700 333
5001 853 640	3400 700 449
5001 858 682	3151 000 144
5001 859 387	3400 700 409
5001 864 270	3151 000 144
5001 865 164	3400 700 444
5001 865 764	1878 002 075
5001 865 764	3151 000 285
5001 865 764	3482 124 041
5001 865 858	3400 700 409
5001 865 859	3400 700 480
5001 865 861	3400 700 408
5001 866 091	3400 700 339
5001 866 098	3400 700 630

Vergleichsliste / Cross reference list

Vergleichs-Nr. Compare No.	Artikelnummer Article No.
-------------------------------	------------------------------

RENAULT TRUCKS

5001 866 099	3400 700 630
5001 866 103	3400 117 101
5001 866 104	3400 117 101
5001 866 297	3400 700 350
5001 866 299	3400 700 351
5001 866 621	1878 004 832
5001 866 621	3151 263 031
5001 866 621	3400 700 485
5001 866 621	3482 123 631
5001 866 623	1878 001 077
5001 866 623	3151 199 001
5001 866 623	3482 060 233
5001 866 625	1864 454 101
5001 866 625	3151 199 001
5001 866 625	3482 060 233
5001 866 891	3400 700 334
5001 867 227	3400 700 399
5001 867 502	3400 700 444
5001 867 644	3482 634 003
5001 868 260	3400 700 444
5001 868 263	3400 700 408
5001 868 264	3400 700 409
5001 868 265	3400 700 480
5001 868 266	3400 700 338
5001 868 267	3400 700 630
5001 868 269	3400 700 408
5001 868 271	3400 117 101
5001 868 272	3400 116 601
5001 868 273	3400 700 339
5001 868 274	3400 700 630
5001 868 279	3400 700 626
5001 868 531	3400 700 470
5001 868 533	3400 700 618
5001 872 322	3400 700 466
5001 872 324	3400 700 466
5001 873 287	3151 000 144
5001 875 223	3400 117 532
5001 875 225	3400 700 311
5001848619	3189 600 009
5010 244 017	3151 250 231
5010 244 018	1878 002 455
5010 244 023	3482 094 031
5010 244 043	1878 001 729
5010 244 067	1878 049 041
5010 244 077	1878 001 145
5010 244 080	3482 037 141
5010 244 086	3151 000 404
5010 244 087	1878 020 241
5010 244 091	1878 026 241
5010 244 091	1878 027 442
5010 244 093	3488 017 439
5010 244 094	3488 017 439
5010 244 097	3482 083 252
5010 244 101	3482 115 031
5010 244 119	1878 039 631
5010 244 142	3482 083 044
5010 244 144	1861 577 037
5010 244 144	1878 000 611
5010 244 184	1878 020 241
5010 244 199	1897 375 775
5010 244 202	3151 250 231

Vergleichs-Nr. Compare No.	Artikelnummer Article No.
-------------------------------	------------------------------

RENAULT TRUCKS

5010 244 203	3482 083 252
5010 244 204	3151 000 404
5010 244 213	1862 438 032
5010 244 225	3151 278 941
5010 244 242	1878 001 145
5010 244 256	1878 020 241
5010 244 256	1878 020 241
5010 244 265	3482 083 252
5010 244 301	3482 123 631
5010 244 304	3488 017 442
5010 244 310	3482 124 041
5010 244 324	1878 026 241
5010 244 379	1878 020 241
5010 244 379	1878 020 241
5010 244 384	1878 020 241
5010 244 390	3151 263 031
5010 244 404	1878 002 075
5010 244 412	1878 020 241
5010 245 267	3400 700 444
5010 245 445	1878 049 041
5010 245 447	1878 026 241
5010 245 448	1878 020 241
5010 245 457	3151 274 131
5010 245 896	1878 002 072
5010 245 921	3151 274 131
5010 452 025	3151 262 031
5010 452 026	1862 379 032
5010 452 304	3151 270 341
5010 452 422	3482 634 003
5010 452 423	3151 600 595
5010 452 507	1878 026 241
5010 452 514	3400 700 625
5010 452 572	1878 001 145
5010 545 582	3482 000 691
5010 545 671	3482 123 631
5010 545 676	3151 262 031
5010 545 747	1878 006 847
5010 545 831	1878 634 034
5010 545 836	3482 000 246
5010 545 851	1878 003 968
5010 545 852	3482 083 034
5010 545 984	3482 001 071
5010 545 988	3151 000 752
5010 613 114	3151 000 809
5010 613 123	3488 000 122
5010 613 151	1878 634 034
5010 613 228	3400 700 444
5010 613 657	1878 004 832
5010 613 658	1878 003 968
5010 613 659	3482 634 004
5010 613 741	1862 379 032
5010 622 204	1863 869 039
5010 639 033	3151 600 529
5010 639 242	3400 700 444
5010 837 119	3482 083 252
50106133218	3482 001 199
5430 013 403	1878 020 241
5430 013 704	3482 037 141
5430 120 506	1878 020 241
5516 021 252	3482 008 033
5516 021 253	3482 008 033

Vergleichs-Nr. Compare No.	Artikelnummer Article No.
-------------------------------	------------------------------

RENAULT TRUCKS

5516 021 260	1861 577 037
5516 021 262	1864 454 101
5516 021 264	1864 454 101
5516 021 267	3151 199 001
5516 021 432	1861 577 037
5516 021 433	1861 577 037
5800 207 033	3151 000 958
5800 207 047	1878 001 144
5800 207 047	1878 001 147
5800 207 048	1878 001 152
5800 207 052	3482 124 534
5800 208 580	3482 124 534
5800 208 581	3482 124 534
7000 736 850	3151 600 751
74 21 071 024	3151 001 035
74 21 465 238	6482 000 155
74 21 639 503	1878 007 046
74 85 003 693	3400 700 495
74 85 003 839	3400 700 622
74 85 126 520	1878 003 276
7403 192 219	3151 000 154
7408172031	3189 600 061
7420 512 915	1863 869 037
7420 707 020	3483 034 043
7420 707 022	3483 034 042
7420 707 024	1878 000 634
7420 725 523	1878 006 129
7420 725 524	1878 003 867
7420 730 004	3151 000 154
7420 730 007	3100 026 431
7420 730 008	1878 001 215
7420 811 639	3151 600 529
7420 811 639	3400 700 444
7420 811 639	3400 700 632
7420 811 654	3400 700 632
7420 811 713	3400 700 632
7420 812 085	3482 000 553
7420 812 085	3482 001 308
7420 812 086	3482 001 307
7420 812 087	6482 000 155
7420 813 974	3482 114 031
7420 846 567	1878 006 848
7420 927 461	3488 017 439
7420 927 842	1862 379 032
7420 927 847	1862 380 031
7420 959 262	1878 634 034
7420 981 951	3482 634 003
7420 994 737	1878 007 046
7420 998 835	3151 274 131
7421 005 308	3482 634 003
7421 074 314	3482 634 004
7421 076 710	1878 004 832
7421 134 335	3482 001 307
7421 188 863	3151 000 752
7421 222 008	3482 114 031
7421 235 549	3483 000 348
7421 235 560	3488 000 159
7421 235 561	1878 003 768
7421 274 770	1878 007 939
7421 320 929	6482 000 155
7421 371 121	3483 000 348

Vergleichsliste / Cross reference list

Vergleichs-Nr. Compare No.	Artikelnummer Article No.	Vergleichs-Nr. Compare No.	Artikelnummer Article No.	Vergleichs-Nr. Compare No.	Artikelnummer Article No.
RENAULT TRUCKS		SCANIA		SCANIA	
7421 469 613	3189 600 045	1321258	1878 063 231	1444110	1878 003 066
7421 580 956	6482 000 155	1321259	3482 083 039	1444110	1878 063 231
7421 580 968	6482 000 155	1321259	3482 083 039	1455730	3182 009 938
7421 639 030	3482 001 310	1321280	3483 020 033	1479574	3482 000 999
7421 646 611	3488 000 373	1322780	3483 020 036	1479575	1878 007 253
7421 646 616	1878 007 366	1323138	1878 003 658	1479576	3151 000 151
7421 695 971	1878 006 584	1324883	1878 003 066	1493989	3482 001 346
7421 916 049	1878 634 034	1324883	1878 063 231	1493990	3151 001 101
7422 078 249	1878 007 170	1327022	3483 024 031	1493991	1878 007 278
7422 079 184	1878 007 934	1327023	3483 024 031	1496761	1878 007 120
7422 105 110	1878 007 934	1327025	3151 205 202	1496761	1878 007 120
7422 429 963	6482 000 155	1332108	1878 003 238	1499759	3483 000 259
7485 003 687	6482 000 155	1332619	1878 003 339	1499769	1878 007 253
7485 003 692	3400 700 439	1335280	3483 028 031	1499770	3151 000 151
7485 003 694	3400 700 438	1335281	3482 112 031	1506121	6283 600 557
7485 003 695	3400 700 311	1335282	1862 450 031	1510032	1878 003 066
7485 013 168	6482 000 155	1340192	1878 003 066	1510032	1878 063 231
7485 013 826	3400 700 466	1340192	1878 063 231	1513718	3482 000 257
7485 013 827	3400 700 627	1341683	3180 007 000	1513719	3482 000 251
7485 013 828	3400 700 627	1341687	3482 083 150	1513720	3482 000 251
7485 013 829	3400 700 628	1349349	1878 043 231	1521513	3151 000 273
7485 013 830	3400 700 618	1355282	1862 450 031	1522377	3182 009 938
7485 020 473	6482 000 155	1356981	3482 112 031	1522424	3482 000 257
7485 127 008	3151 000 493	1356981	3482 112 031	1523634	1878 003 895
7485 132 227	3189 600 009	1360231	1878 062 944	1523634	1878 007 123
7485 135 623	3189 600 014	1361679	3482 083 039	1527227	1878 007 120
7485137875	3151 000 493	1365486	3482 083 039	1538455	1878 007 254
7701 011 466	1882 330 032	1367172	1878 062 944	1545062	3100 008 201
7701 012 756	1878 005 367	1367172	1878 062 944	1545626	6283 600 557
8000 243 160	1878 000 104	1368697	1878 003 066	1547163	3482 000 999
SCANIA		1368697	1878 063 231	1548626	3151 000 273
10574853	3482 001 346	1370793	3482 083 039	1548627	3482 000 589
10574906	1878 007 278	1370794	3482 083 039	1571220	3482 083 039
1102425	3482 119 034	1373275	3483 024 031	1574912	1878 007 120
1103478	1878 003 339	1373276	3100 005 202	1728165	3151 000 151
1103479	1878 003 339	1382331	3482 083 150	1749123	1878 003 066
1103482	1878 003 339	1386931	1878 003 066	1749124	1878 003 065
1103489	1878 003 339	1386931	1878 063 231	1749125	3151 000 151
1104305	1878 003 238	1387021	1878 062 944	1749126	3496 006 000
1108445	1878 005 487	1387021	1878 062 944	1754943	6283 600 557
1111147	3483 020 033	1390374	1878 043 231	1763155	3482 000 999
1111148	1878 003 066	1393161	3100 008 201	1785010	1878 006 370
1111148	1878 063 231	1393161	3100 008 201	1851631	3151 000 151
1111149	1878 005 487	1393162	3100 005 202	1854205	3482 000 999
1113870	3482 083 039	1393183	3483 020 036	1854206	3482 000 589
1115420	3483 019 031	1393184	3483 028 031	1864707	1878 007 120
1116682	1878 003 365	1393185	3483 024 031	1898019	1878 003 065
1123296	3182 009 938	1393186	3483 020 033	1898020	1878 003 895
1210032	1878 063 231	1393332	3182 009 938	1898020	1878 007 123
1302903	1878 006 118	1399788	3189 600 056	190326	1878 001 138
1304781	1878 062 944	1407430	3100 008 201	1914989	3482 000 999
1304781	1878 062 944	1407912	3482 124 731	1914991	1878 007 124
1316142	3483 020 033	1407913	3482 000 257	1929397	1878 003 066
1318603	1878 062 944	1409769	1878 063 231	2009984	1878 007 123
1318603	1878 062 944	1412319	1878 003 066	2009987	1878 007 120
1319046	1878 003 365	1412319	1878 063 231	2023015	3482 000 999
1321253	1878 003 066	1413177	1878 043 231	2077903	1878 007 253
1321253	1878 063 231	1434649	3182 009 938	2085861	1878 007 120
1321254	3482 083 039	1436695	1878 003 065	2085862	1878 006 370
1321258	1878 003 066	1444055	3151 000 419	2085863	1878 007 253
		1444086	3151 127 031	2112315	1878 007 120

Vergleichsliste / Cross reference list

Vergleichs-Nr. Compare No.	Artikelnummer Article No.	Vergleichs-Nr. Compare No.	Artikelnummer Article No.	Vergleichs-Nr. Compare No.	Artikelnummer Article No.
SCANIA		SCANIA		SCANIA	
2113295	1878 007 254	524466	3482 119 034	571296	1878 043 231
2113315	1878 007 120	550417	1878 003 238	571298	3483 024 031
2163969	3482 000 999	550501	3400 123 601	571300	1878 003 066
2164195	3151 000 151	550502	3400 123 501	571300	1878 063 231
2189770	1878 007 124	571078	3482 124 514	571305	1878 003 066
2196742	1863 869 045	571079	3482 001 234	571310	1878 003 065
2274550	3151 000 151	571079	3482 119 034	571315	3482 000 257
2302249	1878 007 120	571207	3482 124 514	571316	1878 007 253
2302250	1878 007 253	571208	3482 001 234	571317	1878 007 120
234680	3482 124 514	571208	3482 119 034	571324	3482 000 257
234682	3482 119 034	571210	3482 001 234	571447	1878 003 066
2399800	1878 007 253	571210	3482 119 034	571802	3400 123 601
247244	1878 003 339	571211	3482 033 401	571803	3400 123 501
2548347	3151 000 151	571212	3459 004 108	572923	1878 007 124
2568931	3151 000 273	571212	3482 033 401	572943	3400 700 372
259814	1882 110 542	571213	3483 019 031	572944	3400 700 370
264078	1878 003 339	571214	3482 001 234	572945	3400 700 611
264786	3482 119 034	571214	3482 119 034	572947	3400 700 373
264787	1878 003 339	571216	3482 001 234	572948	3400 700 372
274244	1878 003 339	571216	3482 119 034	572949	3400 700 370
282646	3459 004 108	571217	3482 083 039	572950	3400 700 611
282655	3482 033 401	571218	3482 083 039	572952	1878 007 254
294884	3482 119 034	571219	3482 001 234	572953	3400 700 352
294885	1878 003 339	571219	3482 119 034	572954	3400 700 374
304382	1878 003 238	571220	3482 083 039	572955	3400 710 004
304384	1878 003 238	571221	3482 083 039	574852	3482 000 999
304394	1878 003 238	571222	3482 112 031	574853	3482 001 346
304398	1878 003 238	571223	1862 450 031	574854	3483 000 259
306600	3482 119 034	571224	1878 043 231	574858	3482 000 589
306640	3482 124 514	571226	3482 083 039	574859	3482 000 999
306660	1878 003 339	571227	3482 083 039	574864	3482 000 999
314820	1878 006 118	571250	1878 003 339	574865	3482 000 999
315427	3483 019 031	571251	1878 003 365	574867	3482 000 999
315794	1878 006 118	571252	1878 003 238	574868	3482 000 999
319827	3482 033 401	571253	1878 005 487	574903	1878 007 120
324265	1878 006 118	571254	1878 062 944	574904	1878 003 895
324460	3482 033 401	571254	1878 062 944	574904	1878 007 123
324461	3482 033 401	571256	1878 063 231	574905	1878 007 253
326265	1878 006 118	571261	1878 006 118	574906	1878 007 278
327557	3482 119 034	571263	1878 003 658	574907	1878 006 370
328046	1878 006 118	571265	1878 003 238	574908	1878 003 065
329439	3482 119 034	571268	1878 003 066	574909	1878 003 895
329440	1878 003 238	571268	1878 063 231	574909	1878 007 123
360351	1878 003 238	571269	3482 124 731	574911	1878 007 253
361055	1878 003 238	571270	1878 003 065	574912	1878 007 120
363671	1878 006 118	571271	1878 003 066	574913	1878 006 370
363687	3459 004 108	571271	1878 063 231	574914	3400 700 373
364378	1878 062 944	571279	3483 024 031	574915	3400 700 372
365063	1878 003 238	571280	1878 005 487	574916	3400 700 370
365323	1878 003 238	571282	1878 062 944	574917	3400 700 611
369849	1878 062 944	571282	1878 062 944	574918	1878 007 123
369849	1878 062 944	571283	1878 063 231	574920	3400 700 491
382498	3483 020 033	571284	1878 063 231	574923	1878 007 124
382499	3482 083 039	571285	1878 062 944	574926	1878 007 120
382576	3482 083 039	571285	1878 062 944	574927	1878 007 253
383695	3180 001 008	571288	1878 062 944	574928	1878 007 254
387691	1878 006 118	571289	3482 083 150	574938	1878 007 253
387692	3488 009 634	571290	1878 062 944	574977	3400 700 611
388139	1878 003 238	571291	1878 043 231	574981	3400 700 372
394884	3482 001 234	571292	1878 063 231	574982	3400 700 619
394884	3482 119 034	571295	1878 063 231	574983	3400 710 004

Vergleichsliste / Cross reference list

Vergleichs-Nr. Compare No.	Artikelnummer Article No.
-------------------------------	------------------------------

SCANIA

6490375 1878 001 138

SETRA

A 000 254 27 08 3151 000 144
000 254 27 08 3151 000 144

SISU

130 -503-0321 3151 278 941
130-210-3891 1861 902 032
130-210-3892 1861 902 032
130-210-4341 1878 054 933
130-210-4371 1878 003 968
130-240-3891 3482 021 031
130-240-3892 3482 021 031
130-240-4321 3482 000 209
130-240-4341 3482 123 631
130-240-4351 3482 000 691
130-240-4361 3482 123 631
130-503-0311 3151 027 102
130-510-0031 3151 263 031
139-210-3892 1861 902 032
31068800 3482 046 031
32831400 3482 002 234
62 130-240-4321 3482 083 032

SNVI

1 140 732 3482 037 141
1 140 733 1878 000 960

STEYR

004 250 19 04 3082 156 031
1209160721 1805 042 000
133.70.02.10065 1863 837 002
133.70.02.10066 1863 855 000
159.00.01.60901 1861 919 134
161200160903 1882 110 513
161.40.01.60018 1881 039 531
161.41.60.0181 1881 039 531
1614160734 1878 005 367
161460160902 1882 327 003
179200160902 1878 001 144
189200160904 3482 067 102
19911216007 1878 003 662
199112160905 1878 003 662
199112160907 1878 003 662
209.16.00.03 1881 089 002
209.16.00.05 3151 021 001
209.16.00.06 3151 021 001
209.16.07.21 1805 042 000
209.16.07.24 1864 634 023
209.16.09.01 1881 089 002
209.16.09.02 1864 634 023
209.16.09.03 1864 634 023
337.00.21.0065 1863 837 002
337.00.21.0066 1863 855 000
397.21.0118 3151 082 001
4S2641 1881 039 531
4.712.1.16.001.2 3151 011 001
471221600121 3151 011 001
5 G 2610 B 1882 325 134
527.12.60.10000 3082 121 031
609.E1.60.001 1880 092 415
609.F1.60.001 1878 634 072

Vergleichs-Nr. Compare No.	Artikelnummer Article No.
-------------------------------	------------------------------

STEYR

610.T1.60.004 1864 347 102
610.00.16.0005 1878 634 072
61200160002 1878 001 144
612.00.16.0010 1882 110 513
61260160002 1878 001 144
61260160003 1878 001 144
614 160904 1878 005 367
614E160001 1882 327 003
614.00.16.0018 1881 039 531
614.16.00.02 1881 039 531
614.16.00.18 1881 039 531
614160734 1878 005 367
614.60.16.0001 1882 261 013
61460160004 1882 327 003
61460160005 1882 327 003
61500160002 1878 001 152
61560160001 1878 003 661
61560160901 1878 003 661
692.00.16.0001 3482 063 101
69200160009 1862 125 202
69200160901 3482 063 101
7121160012 3151 011 001
7121160062 1878 634 065
7122160012 3151 011 001
7122160062 1878 634 065
7123160062 1878 634 065
792.00.16.0002 3151 156 003
792.00.16.0006 1878 001 144
792.00.16.0007 3151 156 003
81.30301.0350 1862 438 032
81.30301.0378 1862 506 131
81.30301.0380 1862 438 032
81.30301.0393 1878 044 631
81.30301.0393 1878 044 631
81.30301.0395 1878 044 631
81.30301.0395 1878 044 631
81.30301.9393 1878 044 631
81.30301.9393 1878 044 631
81.30305.0184 3482 093 032
81.30305.0198 3482 000 467
81.30305.0201 3482 120 031
81.30305.0230 3482 000 361
81.30550.0074 3182 005 231
81.30550.0079 3182 005 231
81.30550.0082 3151 253 031
815.00.16.0017 1878 002 706
815.60.16.0003 3482 124 522
815.60.16.0006 3482 124 522
853.03.05.0001 3482 124 522
853.03.05.9001 3482 124 522
892 00 16 0902 3482 067 102
892.00.16.0001 3482 067 102
892.00.16.0003 3482 067 102
892.00.16.0004 1878 001 152
892.00.16.0006 3482 067 102
892.00.16.0007 1878 001 152
990.00.21.0029 3151 111 032
990.00.21.0706 3163 026 100
991.00.16.0003 1862 304 033
991.12.16.0002 1882 304 208
991.12.16.0006 1878 003 661

Vergleichs-Nr. Compare No.	Artikelnummer Article No.
-------------------------------	------------------------------

STEYR

991.12.16.0007 1878 003 662
991.12.16.0009 1878 003 662
991.14.16.0007 1878 000 968
991.14.16.0011 1888 015 515
991.14.16.0013 3482 118 031
991.14.16.0013 3482 118 031
991.14.16.0017 1878 002 706
991.14.16.0019 1882 342 134
991.14.16.0019 1882 342 134
991.14.16.0020 1878 002 706
991.14.16.0022 3151 186 001
991.14.16.0027 1862 315 101
991.14.16.0028 3482 083 113
991.14.16.0028 3482 083 113
991.14.16.0028 3482 083 113
991.14.16.0029 3151 217 001
991.14.16.0030 1878 002 706
991.14.16.0031 1888 015 515
991.14.16.0032 1878 000 968
991.14.16.0033 3151 000 144
991.14.16.0036 1862 315 101
991.14.16.0037 3482 083 113
991.14.16.0738 1878 000 965
991.14.16.0901 3482 118 031
991.14.16.0903 1882 342 134
991.14.16.0916 3482 083 113

TAM

2031033 1880 083 132
2616004 3151 000 395
2616014 3151 000 375
2616632 1880 083 132
2617049 3151 126 031
2618091 1861 600 033
2618559 3151 000 515
2618657 1881 041 656
5024064 1861 600 033
5024072 1882 137 307
5052220 1878 001 074
5095174 1861 034 147
5179629 1878 001 070
5190118 1882 325 134
5196701 3151 068 101
5253497 1878 001 152
5304148 3151 000 515
5516382 1878 001 152
5549485 1882 325 134
5560749 1882 342 134
5579934 1882 342 134
5582684 3482 008 036
5597401 3151 000 395
5599230 3151 000 515
5601006 3482 008 036
5601007 1861 653 132
5601009 3151 199 001
5603773 3482 085 034
5614068 3482 124 534
5614082 3482 017 034
5615592 3482 083 113
5615748 3482 002 234
5616891 3482 085 034

Vergleichs-Nr. Compare No.	Artikelnummer Article No.	Vergleichs-Nr. Compare No.	Artikelnummer Article No.	Vergleichs-Nr. Compare No.	Artikelnummer Article No.
TAM		VAN HOOL		VOLKSWAGEN	
5616893	1878 001 154	632 100 390	3151 108 031	029 141 025 B	3082 086 434
5618023	3151 000 034	632 100 410	1878 002 955	029 141 025 C	3082 086 434
5619162	1882 022 101	632 100 440	1882 342 134	03L 141 016 F	3000 950 746
5631940	3482 008 038	632 100 440	1882 342 134	034 105 313 A	1863 869 005
5645436	3482 017 035	632 100 450	3151 000 375	034 141 031 D	1878 030 841
5650301	1878 001 152	632 100 470	1861 911 232	034 141 031 F	1878 030 841
5651445	3482 000 461	632 100 480	3151 000 395	034 141 031 G	1878 030 841
5654556	1862 506 131	632 100 550	3151 027 102	034 141 031 M	1878 030 841
5654557	3482 000 463	632 100 670	3482 085 033	034 141 031 P	1878 030 841
5750659	3151 000 419	632 100 680	3482 002 234	034 141 031 Q	1878 030 841
6345185	3151 011 001	632 100 680	3482 002 234	034 141 031 R	1878 030 841
8751-52-51.35	1878 001 074	632 100 690	1861 777 037	034 141 031 T	1878 030 841
8751-52-51.36	1881 039 532	632 100 700	3151 199 001	034 141 032	1878 030 841
TEMSA		632 101 010	3151 000 395	034 141 032 J	1878 030 841
13F10-22005-AA	1878 001 709	632 101 020	1882 342 134	034 141 032 K	1878 030 841
VAN HOOL		632 101 030	1882 342 135	034 141 032 N	1878 030 841
VH 140667/3	3151 027 102	632 101 060	1888 042 009	034 141 032 P	1878 030 841
100.901.513	1878 002 139	632 101 110	1861 911 232	034 141 313 A	1863 869 005
10628942	3151 000 034	632 101 220	1878 000 968	035 141 118	3082 919 001
10628946	3400 121 601	632 101 260	1878 086 741	046 105 313 D	1863 869 002
10628946	3488 017 432	632 101 260	1878 086 741	048 141 031 C	1878 030 841
10628949	3482 000 209	632 101 320	1861 777 037	048 141 031 D	1878 030 841
10642776	3151 000 157	632 101 350	1878 002 706	048 141 031 E	1878 030 841
10656900	1878 001 136	632 101 360	1878 001 136	048 141 031 R	1878 030 841
10664863	3482 119 031	632 101 440	1861 777 037	048 141 031 S	1878 030 841
10696404	1878 002 023	632 101 470	3482 017 035	048 141 031 T	1878 030 841
107 987 81	1888 042 009	632 101 600	1862 303 031	050 141 032 A	1878 030 841
10713784	1878 086 742	632 101 610	3488 017 333	050 141 032 B	1878 030 841
10720680	3488 000 108	632 101 620	3151 000 034	050 141 032 C	1878 030 841
10720699	1878 002 643	632 101 630	3151 000 395	050 141 032 D	1878 030 841
10725736	1878 080 033	632 101 640	1888 042 009	050 141 032 N	1878 030 841
10729514	3482 124 549	632 101 670	3482 083 113	050 141 032 P	1878 030 841
10737529	1878 080 031	632 101 670	3482 123 235	050 141 032 Q	1878 030 841
10739529	1878 080 031	632 101 690	1862 302 031	050 141 033 J	1878 030 841
10787669	1878 085 641	632 101 770	3482 119 031	050 141 117 B	3082 178 132
10839052	3482 000 209	632 101 780	3482 119 031	050 141 117 C	3082 178 132
10876696	1878 002 139	632 101 790	1878 003 657	053 141 031	1878 030 841
10901513	1878 002 139	632 101 850	1878 086 741	053 141 031 A	1878 030 841
10909266	1878 001 136	632 101 870	1878 086 742	053 141 117	3082 178 132
10945803	3151 000 034	632 101 880	3151 249 001	060 105 313 A	1863 869 002
1096 8918	3151 000 157	700 113 365	3151 000 515	060 105 313 B	1863 869 002
10996001	3151 000 335	700 117 405	3482 118 031	061 141 025	3482 032 331
10996015	3151 000 034	860 212 52	3482 008 033	061 141 025 A	3482 032 331
11257228	3151 000 335	860 212 52	3482 008 038	061 141 025 D	3482 102 031
11430376	1878 002 139	920 919 503	3482 083 118	061 141 025 E	3482 102 031
42026023	1861 653 132	VOLKSWAGEN		061 141 025 F	3482 102 031
469 5661	1878 000 957	TEG 141 165	3151 997 201	061 141 025 F	3482 102 031
472 4654	3151 127 031	T2D 141 025	3482 934 001	061 141 025 G	3482 102 031
517 974	1878 085 641	0B7 141 671	3182 654 192	061 141 031	1861 897 034
518 312	3482 000 246	0B8 141 671	3182 997 802	061 141 031 A	1861 897 034
632 100 080	3482 085 033	000 141 165	3151 248 031	061 141 031 B	1861 841 132
632 100 090	1878 002 955	007 141 165 A	3151 600 541	061 141 031 C	1861 841 132
632 100 100	3151 054 031	019 141 165	3151 193 041	061 141 031 D	1861 841 132
632 100 110	1878 001 138	025 141 025	3082 086 434	061 141 031 E	1862 219 031
632 100 150	3151 000 515	025 141 025 A	3082 086 434	061 141 031 F	1861 841 132
632 100 200	3482 124 541	025 141 025 D	3082 086 434	061 141 031 H	1861 841 132
632 100 210	1878 002 706	025 141 025 E	3082 086 434	061 141 031 K	1861 841 132
632 100 240	1882 301 239	029 141 025	3082 086 434	061 141 031 L	1862 219 031
632 100 270	1882 302 131	029 141 025 A	3082 086 434	061 141 031 M	1862 219 031
632 100 340	1882 301 239	029 141 025 B	3082 086 434	061 141 031 N	1862 219 031
				061 141 031 P	1862 219 031

Vergleichsliste / Cross reference list

Vergleichs-Nr. Compare No.	Artikelnummer Article No.
-------------------------------	------------------------------

VOLKSWAGEN

062 141 025 A	3082 268 031
062 141 025 A	3082 268 031
062 141 025 B	3082 919 001
062 141 025 E	3000 951 107
062 141 031	1864 528 442
062 141 031 A	1878 994 001
062 141 031 F	3000 951 107
073 141 031	1861 897 034
073 141 031 A	1861 897 034
073 141 031 B	1861 897 034
073 141 031 C	1861 897 034
073 141 031 C	1861 897 034
073 141 031 D	1861 897 034
073 141 031 E	1861 897 034
073 141 031 F	1861 897 034
073 141 031 G	1861 897 034
073 141 031 J	1861 897 034
073 141 031 K	1861 897 034
073 141 031 L	1861 897 034
073 198 141 X	3000 055 006
074 141 025 C	3082 639 402
074 141 025 D	3082 308 043
074 141 025 F	3082 308 043
074 141 025 H	3082 600 522
074 141 025 J	3082 600 522
074 141 025 M	3082 600 509
074 141 032	1864 528 442
074 141 032 B	1878 988 102
074 141 032 E	1878 988 102
076 105 266	2294 501 207
076 105 266 C	2294 501 207
076 105 313	1863 869 012
076 141 015 A	3000 951 841
076 141 015 B	3000 951 876
076 141 015 C	3000 951 932
076 141 025	3082 190 031
076 141 025 A	3082 190 031
076 141 025 B	3082 190 031
076 141 025 C	3082 190 031
076 141 031	1878 004 776
076 141 031 A	1878 004 776
076 141 031 B	1878 004 776
076 141 031 C	1878 004 776
076 141 031 D	1878 004 776
076 141 031 E	1878 004 776
076 141 031 F	1878 004 776
076 141 031 G	1878 004 776
076 141 031 H	1878 004 776
076 141 031 J	1878 004 776
076 141 031 K	1878 004 776
076 141 031 L	1878 004 776
076 141 031 M	1878 004 776
076 141 031 N	1878 004 776
076 141 031 P	1861 897 034
076 141 031 R	1878 004 776
076 141 031 S	1878 004 776
076 141 031 T	1878 004 776
076 141 032	1878 004 776
076 141 032 A	1878 004 776
076 141 032 B	3000 951 841
076 198 141 X	3000 055 005

Vergleichs-Nr. Compare No.	Artikelnummer Article No.
-------------------------------	------------------------------

VOLKSWAGEN

088 141 165	3151 193 041
088 141 165 A	3151 193 041
088 141 165 B	3151 193 041
088 141 165 C	3151 193 041
091 141 165	3151 193 041
091 141 165 A	3151 193 041
091 141 165 B	3151 193 041
091 141 165 D	3151 193 041
111 141 025	1881 065 101
111 141 025 A	1881 065 101
111 141 025 B	1881 065 101
111 141 025 C	1881 065 101
111 141 025 D	1881 065 101
111 141 025 E	1881 065 101
111 141 025 F	1881 065 101
111 141 025 F	1881 065 101
111 141 025 G	1881 065 101
111 141 025 H	1881 065 101
111 141 031	1861 280 136
111 141 031 A	1861 280 136
111 141 031 B	1861 280 136
111 141 031 C	1861 280 136
111 141 031 D	1861 280 136
111 141 031 E	1861 280 136
111 141 031 F	1861 280 136
111 141 031 G	1861 280 136
111 141 165	3151 270 602
111 141 165 A	3151 270 602
111 141 165 C	3151 270 602
113 141 165	3151 193 041
113 141 165 A	3151 193 041
113 141 165 B	3151 193 041
113 141 165 C	3151 193 041
113 141 165 D	3151 193 041
2D0 721 261	6283 600 115
2D0 721 261 A	6283 600 115
2D0 721 261 B	6283 600 115
2D0 721 401	6284 600 573
2E0 721 401 C	6284 605 004
2RD 141 031	1878 654 641
2RD 141 031 B	1878 654 641
2SO 141 025	3483 000 001
2U2.141.165.B	3151 000 493
2VH 141 031	1878 002 642
2V2 141 031D	1878 002 218
2Z0 141 025 D	3483 000 238
211 141 025	1881 065 101
211 141 025 D	1881 065 101
211 141 025 F	1881 065 101
281 721 335 B	3074 003 343
281 721 335 E	3074 003 343
281 721 335 F	3074 003 343
311 141 025	1881 065 101
VOLVO	
1069031	3488 019 032
1069032	3488 019 031
1069033	1862 415 031
1070754	3482 602 008
1071393	3482 602 003
1071544	1878 000 961

Vergleichs-Nr. Compare No.	Artikelnummer Article No.
-------------------------------	------------------------------

VOLVO

1071826	3482 909 001
1071826	3482 909 001
1521246	1862 349 031
1521712	3483 034 034
1521713	3483 034 035
1521714	3488 022 253
1521716	1878 032 331
1521717	1878 002 437
1521718	3482 123 234
1521719	3483 000 382
1521721	3483 034 033
1521725	3459 018 004
1521726	1878 002 442
1521730	3482 123 235
1524768	1862 530 231
1526023	1888 015 515
1526046	1878 001 082
1526047	1878 001 080
1526199	1878 006 117
1526214	1878 006 951
1526574	3482 026 332
1527029	3482 021 031
1527122	1878 006 117
1527123	1861 996 137
1527124	1888 019 445
1527254	3482 026 332
1527255	3459 004 108
1527284	1878 076 031
1527285	1862 974 002
1527307	3482 905 001
1527308	1862 973 002
1527444	3482 021 031
1527445	1878 000 961
1527473	1888 019 542
1527474	1882 250 143
1527475	1859 170 204
1527517	3483 034 032
1527518	1861 988 034
1527519	1878 004 456
1527521	1878 004 456
1527523	1878 001 082
1527524	1878 001 080
1527693	3151 106 041
1527695	3151 105 141
1527910	3482 026 332
1527911	1861 996 137
1527912	1878 006 117
1527913	3459 004 108
1652986	1863 869 037
1655151	1862 974 002
1655152	1878 076 031
1655162	1888 019 445
1655163	1878 001 079
1655164	1878 001 083
1655235	1878 000 961
1655287	3151 600 534
1655288	3151 600 533
1655331	3483 034 032
1655332	3488 013 138
1655334	1878 006 035
1655335	1861 996 137

Vergleichsliste / Cross reference list

Vergleichs-Nr. Compare No.	Artikelnummer Article No.	Vergleichs-Nr. Compare No.	Artikelnummer Article No.	Vergleichs-Nr. Compare No.	Artikelnummer Article No.
VOLVO		VOLVO		VOLVO	
1655335	1878 006 117	1668615	3483 034 032	1672940	3488 019 032
1655342	3482 905 001	1668616	3482 123 235	1672942	3488 018 031
1655406	1888 019 445	1668618	1862 530 231	1672944	3100 026 432
1655407	1888 019 542	1668665	3483 022 031	1672945	3151 000 154
1655408	1888 019 542	1668666	3482 101 032	1672948	3100 002 549
1655409	1888 015 515	1668667	1862 349 031	1673859	1862 530 231
1655410	1888 015 515	1668671	1862 530 231	20350440	1878 600 557
1655412	1859 170 204	1668672	1878 634 026	20366222	1878 001 215
1655417	1859 212 000	1668674	1878 006 035	20366269	1878 001 216
1655648	1878 001 082	1668675	1862 248 033	20366270	1878 040 334
1655649	1878 001 080	1668676	3488 016 031	20366563	1878 001 215
1655676	1861 988 034	1668677	1878 087 241	20366567	3483 034 044
1655677	1878 004 456	1668677	1878 087 241	20366575	3483 034 045
1655678	1878 004 456	1668678	1878 087 241	20366576	3483 034 044
1655684	3482 026 332	1668678	1878 087 241	20366591	1878 000 300
1655684	3482 026 332	1668718	1882 226 533	20366592	1878 000 635
1655685	3459 004 108	1668718	1882 226 533	20366595	1878 000 635
1655685	3459 004 108	1668919	3482 123 234	20366765	3483 034 135
1655686	1861 996 137	1668919	3482 123 234	20366876	3488 000 024
1655686	1878 006 117	1668921	3100 026 432	20376130	3182 998 501
1655687	1878 006 117	1668927	3483 022 032	20376429	1878 021 731
1655688	3474 012 000	1668928	3482 101 032	20400400	1878 000 961
1655688	3474 012 001	1668929	1878 003 779	20400401	1878 000 961
1655731	3459 000 009	1668930	3100 002 549	20400402	1878 600 563
1655738	3482 123 235	1668938	3100 002 549	20484461	3482 001 307
1655741	3482 056 031	1668980	3488 016 031	20484463	3482 000 553
1655752	3482 123 235	1668981	1878 087 241	20484463	3482 001 308
1655773	1878 000 961	1668981	1878 087 241	20484467	1878 003 867
1655822	3483 034 032	1668982	1878 087 241	20484468	1878 006 129
1655829	3180 001 008	1668982	1878 087 241	20504343	1878 002 139
1655840	3483 014 132	1668983	1878 634 026	20504343	3482 000 246
1655841	3483 017 031	1669116	3483 034 033	20507752	1878 001 215
1655842	3459 010 101	1669117	3488 019 031	20507756	1862 248 033
1655843	3100 026 432	1669134	3459 016 031	20507761	1878 001 216
1655875	3488 016 031	1669135	3488 018 031	20510799	3482 123 234
1655877	3459 012 131	1669137	3482 110 031	20510801	3151 000 163
1655878	1878 087 241	1669138	1878 002 458	20510803	1878 001 215
1655878	1878 087 241	1669141	1862 415 031	20510805	1878 000 634
1655879	1878 087 241	1669142	1862 248 033	20514210	1878 000 961
1655879	1878 087 241	1669143	3459 017 031	20514214	1878 600 557
1655884	3482 071 131	1669144	3482 111 031	20514365	1878 000 961
1655899	3482 059 031	1669287	3483 022 031	20514373	1878 600 557
1667255	3483 034 032	1669370	3483 034 032	20525018	1878 000 634
1667256	1878 004 456	1669371	3488 019 032	20526951	1878 000 300
1667257	3482 123 235	1669373	3482 111 032	20566388	1878 003 867
1667927	1861 996 137	1669657	3488 018 031	20566389	1878 006 129
1667928	1878 000 965	1669821	3488 018 031	20569126	3483 034 033
1667929	1878 000 968	1669823	3488 019 031	20569128	3483 034 034
1667930	1878 001 082	1669827	3483 034 033	20569130	3483 034 035
1667931	1878 003 242	1669828	3483 034 032	20569134	3483 034 042
1668369	1878 006 035	1669829	3483 022 032	20569137	3483 034 043
1668370	1861 996 137	1669830	3483 022 031	20569139	3483 034 045
1668370	1878 006 117	1669832	3100 026 432	20569141	3488 019 032
1668371	3488 013 138	1672847	3151 000 163	20569143	3483 027 332
1668372	1878 001 082	1672930	3483 022 031	20569145	3488 000 024
1668373	1878 001 080	1672931	3483 022 032	20569147	3483 034 135
1668375	1862 248 033	1672934	3483 034 032	20569151	3100 026 431
1668529	3482 071 131	1672934	3483 034 032	20569153	3100 026 434
1668536	3482 123 235	1672934	3483 034 032	20569157	3100 026 432
1668537	1878 634 026	1672935	3483 034 033	20569159	3151 000 154
1668567	3488 016 031	1672938	3488 019 031	20569174	3151 000 163

Vergleichsliste / Cross reference list

Vergleichs-Nr. Compare No.	Artikelnummer Article No.
-------------------------------	------------------------------

VOLVO

20569176	3151 000 218
20571156	3488 000 024
20571158	3488 019 032
20571923	3488 022 253
20571927	3488 018 031
20571941	3100 002 549
20571945	3180 000 009
20571946	3180 001 008
20575561	3483 034 033
20577448	1878 000 634
20717563	3488 000 159
20717564	1878 003 768
20725525	3482 001 307
20725526	3482 000 553
20725526	3482 001 308
20730004	3151 000 154
20730007	3100 026 431
20731092	1874 000 068
20733475	6594 000 120
20733540	3483 000 348
20733546	3483 000 348
20744252	3488 000 159
20748154	3483 000 382
20754422	3483 000 348
20796222	1863 869 039
20806451	6482 000 155
20806453	3482 001 307
20806454	3482 000 553
20806454	3482 001 308
20812087	6482 000 155
20812540	3482 634 003
20812547	3151 000 752
20812550	1878 634 034
20812686	3482 001 199
20812688	3151 000 809
20812690	1878 026 241
20839263	6594 000 120
20857090	3482 634 005
20877670	1878 634 038
20891853	1878 005 284
20891854	1878 000 634
20918477	1878 000 634
20994735	1878 007 046
21005310	3482 634 003
21134336	3482 001 307
21188868	3151 000 752
21260847	6594 000 120
21286552	1878 007 939
21320923	6482 000 155
21320929	6482 000 155
21416133	6594 000 120
2146 5238	6482 000 155
21465235	6482 000 155
21469613	3189 600 045
21522835	6594 000 120
21527813	1878 006 129
21539802	1878 006 129
21580956	6482 000 155
21580968	6482 000 155
21580977	6482 000 155
21581138	1866 000 239

Vergleichs-Nr. Compare No.	Artikelnummer Article No.
-------------------------------	------------------------------

VOLVO

21587809	1878 007 046
21587948	1878 007 046
21587950	1878 006 129
21593944	1878 006 129
21593949	1878 007 046
21615193	3482 001 310
21615194	1878 007 046
21615276	3488 000 373
21646614	1878 007 366
21648793	3482 001 309
21695963	1878 006 584
21733185	3482 001 447
21844676	1878 007 046
21844678	1878 007 046
21950293	1878 007 366
22078244	1878 007 170
22078254	1878 007 169
22108762	1878 007 934
22108773	1878 007 934
22429963	6482 000 155
2244 0437	6482 000 155
25378261	1863 869 039
267005	1888 019 445
267006	1859 170 204
267043	1859 212 000
267142	1888 019 445
267143	1882 250 143
267156	3151 106 041
267158	3151 105 141
267160	1882 226 533
267161	1878 006 951
267168	1862 973 002
267169	3482 909 001
267171	3482 119 032
267174	3482 026 332
267175	3459 004 108
267179	1878 000 961
267181	1882 280 213
267182	1859 212 000
267187	3151 824 005
267221	1878 003 242
267235	1888 019 542
267236	1878 001 082
267237	1878 001 080
267238	1888 015 515
267240	1888 019 445
267248	3482 021 031
267249	1878 000 961
267328	1878 006 951
267418	1878 006 951
267445	1882 280 140
267446	1878 000 968
267447	1878 000 965
267490	3482 021 031
267492	1878 000 961
3018010	1888 019 445
3018127	1878 000 961
3018128	1878 006 951
3018129	1888 019 445
3018130	1878 001 083
3018131	1878 001 079

Vergleichs-Nr. Compare No.	Artikelnummer Article No.
-------------------------------	------------------------------

VOLVO

3124470	1878 076 031
3124471	1862 974 002
3124472	1878 000 961
3127465	1862 973 002
3181801	3482 602 005
3181802	3482 602 006
3191766	1878 000 634
3191991	1878 634 026
3192200	3483 034 033
3192201	3483 034 034
3192202	3483 034 035
3192203	3488 022 253
3192205	3488 019 032
3192206	3483 027 332
3192208	3488 018 031
3192209	3100 026 432
3192209	3482 110 031
3192210	3483 034 033
3192211	3483 034 032
3192212	3483 022 031
3192213	3483 022 032
3192216	3100 026 434
3192216	3100 026 434
3192217	3151 000 163
3192218	3100 026 431
3192218	3100 026 431
3192219	3151 000 154
3192222	3100 026 432
3192224	3100 002 549
3192225	3151 000 218
3192782	3483 034 042
3192783	3483 034 043
3192845	1878 003 779
335061	1878 000 961
346319	1882 226 533
346319	1882 226 533
348842	3151 105 141
352221	3151 106 041
354925	1878 001 079
355021	1878 001 079
355022	1882 325 134
355062	3151 824 005
3600663	1882 342 134
363724	3482 021 031
364239	1882 280 213
364240	1878 001 083
3807988	1866 000 140
382853	1882 280 213
3886887	1866 000 239
3950706	1878 021 731
3952874	3482 008 244
3952875	1878 021 731
430123	3082 973 001
446168	1881 059 208
4461682	1881 059 208
5001132	1882 226 533
5001132	1882 226 533
5001387	1882 280 213
5001389	1882 280 213
5001489	1882 250 143
5001490	1882 325 134

Vergleichsliste / Cross reference list

Vergleichs-Nr. Compare No.	Artikelnummer Article No.
-------------------------------	------------------------------

VOLVO

5001499	3482 909 001
5001619	1882 226 533
5001619	1882 226 533
5001642	3482 119 032
5001746	3482 021 031
5001845	1882 280 140
5001855	1882 280 140
5001913	3482 026 332
5002099	3482 021 031
5002221	3482 026 332
5002241	1878 001 082
5002242	1878 001 082
5002243	1878 001 080
5002702	3482 021 031
5002707	1882 250 143
5002861	3482 905 001
5002908	1888 019 542
5003005	3482 026 332
5003214	3482 123 235
5003215	3482 123 235
5003216	3482 056 031
5003237	3482 026 332
5003237	3482 026 332
5003295	3482 059 031
5003316	3482 071 131
5003414	3482 123 235
5003464	3482 602 002
5003471	3482 071 131
5003472	3482 123 235
5100001	1878 000 961
5100004	1878 001 079
5100006	1878 001 082
5100007	1878 001 080
5100057	1878 001 079
5100109	1878 001 079
5430123	3082 973 001
6794389	1862 973 002
6794390	1878 076 031
6794391	1862 974 002
6795044	3482 602 002
6795045	1878 000 961
6797058	3151 600 535
6856112	3151 199 001
8112101	1878 000 961
8112102	1878 006 951
8112103	1878 001 083
8112104	1878 001 079
8112105	1861 988 034
8112106	1878 004 456
8112107	1878 004 456
8112108	1878 001 082
8112109	1878 001 080
8112110	1861 996 137
8112111	1878 006 117
8112112	1878 000 961
8112113	1878 006 035
8112113A	3100 026 432
8112114	1861 996 137
8112114	1878 006 117
8112116	1862 973 002
8112117	1878 076 031

Vergleichs-Nr. Compare No.	Artikelnummer Article No.
-------------------------------	------------------------------

VOLVO

8112118	1862 974 002
8112122	1861 996 137
8112123	1878 000 965
8112124	1878 000 968
8112125	1878 001 082
8112126	1878 003 242
8112127	1878 087 241
8112127	1878 087 241
8112128	1878 087 241
8112128	1878 087 241
8112131	1878 000 961
8112134	1878 000 961
8112135	3482 905 001
8112136	1878 000 961
8112136	1882 325 134
8112136	3151 824 005
8112138	1800 125 601
8112139	1878 003 242
8112139	3151 105 141
8112139	3482 119 032
8112140	3400 037 032
8112148	3400 035 032
8112149	1878 004 456
8112149	3482 123 235
8112157	3482 909 001
8112159	1878 004 456
8112159	3482 123 235
8112160	3400 040 032
8112167	1878 001 079
8112167	1878 001 083
8112167	1882 280 140
8112167	3151 106 041
8112168	1878 001 079
8112168	1878 001 083
8112168	1882 250 143
8112168	3151 106 041
8112171	1800 106 033
8112172	3400 032 033
8112173	3400 031 033
8112174	3400 116 501
8112175	3400 030 033
8112186	1878 076 031
8112186	3482 909 001
8112187	3400 116 001
8112189	1862 974 002
8112189	3482 909 001
8112190	3400 116 301
8112191	3400 043 032
8112192	3400 116 501
8112193	1800 125 001
8112194	1878 634 026
8112221	3482 123 235
8112283	3482 101 032
8112305	3400 116 201
8112306	3400 037 032
8112307	3400 116 101
8112308	3400 037 031
8112309	1878 076 031
8112310	1862 974 002
8112311	1878 000 961
8112340	1862 349 031

Vergleichs-Nr. Compare No.	Artikelnummer Article No.
-------------------------------	------------------------------

VOLVO

8112539	1862 973 002
8112541	3400 116 001
8112597	3482 101 032
8112598	3482 123 234
8112598	3482 123 234
8112600	1862 415 031
8112601	1862 248 033
8112602	3482 111 031
8112603	3482 110 031
8112604	1878 002 458
8112662	1878 003 779
8112754	1800 107 133
8112768	3400 106 031
8112835	3482 602 003
8112836	1878 000 961
8112839	1862 973 002
8112840	3400 116 001
8112841	1878 076 031
8112842	3400 116 201
8112843	1862 974 002
8112844	3400 116 101
8112845	1878 000 961
8112846	3400 037 032
8112848	3400 037 031
8112924	1862 530 231
8113054	1878 634 026
8113225	1878 634 026
8113237	3482 008 244
8113238	1878 021 731
8113257	1862 530 231
8113463	3483 034 033
8113467	1878 032 331
8113468	1878 002 437
8113511	3482 909 001
8113512	3483 034 034
8113513	3483 034 033
8113514	3483 034 035
8113515	3488 022 253
8113525	1878 634 026
8113529	3483 034 033
8113546	3400 035 032
8113547	3400 040 032
8113548	3400 032 033
8113549	3400 043 032
8113550	3400 106 031
8113551	3400 043 032
8113601	3483 022 032
8113658	1878 002 442
8113803	3400 700 301
8113811	3400 127 101
8113812	3400 043 032
8113813	3400 700 401
8113817	1878 600 557
8113818	3482 602 005
8113824	3400 127 201
8113825	3400 127 201
8113894	3483 034 042
8113942	1878 000 961
8113944	1878 600 563
8113946	3488 022 253
8113947	1878 002 437

Vergleichsliste / Cross reference list

Vergleichs-Nr. Compare No.	Artikelnummer Article No.
-------------------------------	------------------------------

VOLVO

8113993	1878 002 442
8171426	1878 000 634
8171479	1878 002 442
8171494	3488 022 253
8171496	1878 002 437
8171497	1878 002 442
8172031	3189 600 061
8172350	3488 000 024
8172354	1878 032 331
8172402	1878 032 331
8172403	1878 032 331
8172732	1878 000 635
8172801	1878 032 331
8172802	1878 000 634
824991	1866 018 131
841893	1866 018 131
85000053	3400 043 032
85000104	3400 106 031
85000125	3482 123 234
85000183	3400 043 032
85000185	3400 125 601
85000235	3483 034 135
85000236	3488 019 032
85000239	1878 000 634
85000241	1878 000 634
85000242	1878 001 215
85000243	1878 001 215
85000244	1878 000 300
85000245	1878 000 635
85000251	3483 034 043
85000252	3488 000 024
85000263	3400 700 357
85000265	3400 700 357
85000266	3400 127 101
85000267	3400 700 343
85000268	3400 700 343
85000269	3400 700 471
85000272	1878 001 215
85000272	3483 034 034
85000273	3400 700 342
85000274	3400 700 342
85000275	1878 001 215
85000275	3483 034 033
85000276	1878 001 215
85000276	3483 034 033
85000277	3400 700 350
85000278	1878 001 215
85000278	3483 034 042
85000279	3400 700 351
85000283	1878 600 557
85000284	1878 000 961
85000307	3400 030 033
85000308	3400 700 407
85000309	3400 700 326
85000310	3400 700 325
85000311	1878 002 458
85000311	3488 018 031
85000312	3400 700 423
85000313	3400 700 406
85000314	3400 700 427
85000361	3483 034 045

Vergleichs-Nr. Compare No.	Artikelnummer Article No.
-------------------------------	------------------------------

VOLVO

85000362	1878 040 334
85000382	1878 000 634
85000393	3483 034 033
85000503	3400 700 463
85000503	3483 000 348
85000510	3400 700 478
85000511	3483 000 382
85000521	3483 034 034
85000522	3400 700 357
85000523	3483 034 033
85000525	3483 034 035
85000527	3483 034 033
85000530	3483 034 135
85000537	3483 000 348
85000542	3400 700 401
85000551	3400 043 032
85000553	3400 043 032
85000555	3400 127 201
85000558	3400 700 357
85000559	3400 127 101
85000560	3400 700 343
85000566	3400 700 406
85000567	3400 700 427
85000568	3400 127 101
85000597	3400 700 423
85000624	3482 000 553
85000624	3482 001 308
85000625	1878 006 129
85000670	1878 000 634
85000773	3400 700 360
85000775	1878 003 768
85000789	3482 634 003
85000790	1878 634 034
85000790	3482 634 003
85000791	3400 700 466
85000792	3482 001 199
85000793	1878 026 241
85000794	3400 700 622
85000796	1878 634 038
85000797	3400 700 490
85000907	3400 700 618
85001003	3488 019 032
85001033	1878 003 779
85003001	3400 700 406
85003035	1878 005 284
85003114	3400 700 358
85003116	1878 000 961
85003116	3482 602 002
85003117	3482 001 307
85003118	1878 003 867
85003119	1878 000 634
85003120	3488 000 024
85003122	1878 001 215
85003685	6482 000 155
85003903	1878 006 129
85003904	1878 006 129
85003972	3400 700 618
85003973	3400 700 618
85013334	1878 007 046
85013713	3482 001 310
85013714	1878 007 170

Vergleichs-Nr. Compare No.	Artikelnummer Article No.
-------------------------------	------------------------------

VOLVO

85013742	3482 001 307
85013743	1878 006 584
85013766	3400 700 618
85013810	1878 007 934
85013811	3400 700 627
85013812	1878 007 934
85013813	3400 700 627
85013814	1878 007 939
85013815	3400 700 628
85013892	3400 700 629
85019411	1878 007 366
85026472	6482 000 155
85105941	3474 012 000
85105942	3474 012 003
85109290	3189 600 004
855389	1866 032 231
855617	1866 118 001
9183759	1878 007 204

Neuaufnahmen / New to range

Artikelnummer Article No.	Seite Page	Hersteller Manufacturer
1863 600 128	5 16 17	DAF
1863 869 045	731	SCANIA
1864 634 039	36	DEMAG
1866 000 332	150 151	LIEBHERR
1866 000 337	150 151	LIEBHERR
1878 005 487	728 918	SCANIA
1878 006 035	754 755 805 807	VOLVO
1878 006 055	812	DRÖGMÖLLER
1878 006 055	589 606 612 620 639 653 654 656 657 659	MERCEDES-BENZ
1878 006 118	727	SCANIA
1878 006 757	401 402 403 404 472 473 474 476 477 478 480 482 483 485 486 488 490 491 495 497 498 501 505 509 519 550 554 563 571 861 886	MERCEDES-BENZ
1878 007 072	409 410 414 415 418 422 423 428 429 434 435 436 438 439 444 445 499 500 502 503 504 506 507	MERCEDES-BENZ
1878 007 103	922	SINOTRUK (CNHTC)
1878 007 204	377 378	MERCEDES-BENZ
1878 007 278	731	SCANIA
1878 007 339	71 73 74 76 77 78 79 80 83 86	IVECO
1878 007 366	761 762 763 764 765 785 787 789 790 791 798	VOLVO

Artikelnummer Article No.	Seite Page	Hersteller Manufacturer
1878 007 729	176 178 179 180 183 184 185 186 188 189 190 191 192 202 203 214 226 261 262 263 264 265 266 267 268 269 270 271 272 273 274 275 276 277 278 279 282 283 284 285 286 287 288 289 290 291 300 301 302 303 304 305 306 307 308 309 310 311 312 313 314 315 316 317 318 319 320 321 322 323 324 325 326 327 328 329 330 331 332 333 334 335 336 337 338 339 340 341 342 343 344 345 346 347 348 349 350 359	MAN
1878 007 729	672 673 676 677 678	ÖSTERREICHISCHE AUTOMOBILFABRIK (ÖAF)
1878 007 729	737 739 740 744 745	STEYR
1878 007 732	518 519 520	MERCEDES-BENZ
1878 007 934	684	RENAULT TRUCKS
1878 007 934	781	VOLVO
1878 007 939	681 685	RENAULT TRUCKS
1878 007 939	760 781	VOLVO
1878 600 863	5 16 17	DAF
1878 634 050	405	MERCEDES-BENZ
1878 634 064	545	MERCEDES-BENZ
1878 634 065	743	STEYR
1878 634 071	516 517 518	MERCEDES-BENZ
1878 634 072	740	STEYR
1878 634 082	37	FAUN
1878 634 082	395 396 398 548 549 551 872	MERCEDES-BENZ
1878 654 641	747	VOLKSWAGEN
1882 600 122	37	FAUN
1882 600 122	395 396 398 548 549 551 872	MERCEDES-BENZ
2294 501 207	746	VOLKSWAGEN
3000 950 746	746	VOLKSWAGEN
3000 970 079	404 405 406 407 861 862 863	MERCEDES-BENZ

Neuaufnahmen / New to range

Artikelnummer Article No.	Seite Page	Hersteller Manufacturer
3000 990 362	746	VOLKSWAGEN
3000 990 381	377	MERCEDES-BENZ
3000 990 382	671	NISSAN
3000 990 394	671	NISSAN
3000 990 415	746	VOLKSWAGEN
3151 001 101	731	SCANIA
3151 600 595	711 712 713 714 715	RENAULT TRUCKS
3151 600 724	17	DAF
3151 600 751	679 706 707	RENAULT TRUCKS
3182 654 142	671	NISSAN
3182 654 169	377 378	MERCEDES-BENZ
3182 654 192 (M)	378 379 380 381 382 383 384 385 386 387 388 389 390 391 392 393 404 405 406 407 855 856 857 858 859 860 861 862 863	MERCEDES-BENZ
3182 654 192 (M)	746 747	VOLKSWAGEN
3182 654 203	405 406	MERCEDES-BENZ
3182 654 204	377	MERCEDES-BENZ
3182 654 216	404 405 861 862 863	MERCEDES-BENZ
3189 600 004	1 2 3 4	ASTRA
3189 600 004	23 24 28 29 30 34 35 36	DAF
3189 600 004	40	HINO
3189 600 004	825 826	IRISBUS
3189 600 004	60 80 81 82 84 85 86 88 89 90 91 92 99 100 101 102 103 104 105 106 107 108 109 110 111 112 113 114 115 116 117 118 119 120 121 122 123 124 125 126 127 128 129 130 133 828	IVECO
3189 600 004	147	KAMAZ

Artikelnummer Article No.	Seite Page	Hersteller Manufacturer
3189 600 004	260 261 262 263 273 274 275 276 277 278 279 280 281 282 283 284 285 286 287 288 289 290 291 292 294 295 296 297 298 299 300 301 302 303 304 305 306 307 308 310 312 313 314 315 316 317 318 319 320 321 322 323 324 325 326 327 328 329 330 331 332 333 334 335 336 337 338 339 340 341 342 343 344 345 346 347 348 349 350 835 836 838	MAN
3189 600 004	377	MAZ-MAN
3189 600 004	891 892 907 908 909 910 911 912	NEOPLAN
3189 600 004	920 921	SETRA
3189 600 004	744 745	STEYR
3189 600 004	926	VDL
3189 600 009	165 166 167 169 171 172 173 174 175 176 177 178 179 180 183 184 186 187 188 189 190 191 192 259	MAN
3189 600 009	690 693 695 713 714 715 716	RENAULT TRUCKS
3189 600 014	183 184 185 188 190 192 206 207 209 210 211 212 213 214 216 218 219 220	MAN

Neuaufnahmen / New to range

Artikelnummer Article No.	Seite Page	Hersteller Manufacturer
3189 600 020	168 169 170	MAN
	175 176 177	
	178 179 180	
	181 182 183	
	184 185 186	
	187 188 189	
	190 191 192	
	193 194 195	
	196 197 198	
	199 200 201	
	202 203 204	
	205 206 207	
	208 209 210	
	211 212 213	
	214 215 216	
	217 218 219	
	220 221 222	
	223 224 225	
	226 227 228	
	229 230 257	
	258 260 261	
	262 263 264	
	265 266 267	
	268 269 270	
	271 272 273	
	274 275 276	
	277 278 279	
	280 282 283	
	284 285 286	
	287 288 289	
	290 292 299	
	300 301 302	
	303 306 307	
	309 311 312	
	313 314 315	
	316 317 318	
	319 320 321	
	322 323 324	
	325 326 327	
	329 331 332	
	333 336 338	
	339 341 343	
	344 347 348	
	349 350 358	
	363 367 374	
	375 834 835	
	836 837 838	
839 840 843		
845 846 848		
849 850 851		
852 853		
3189 600 020	377	MAZ-MAN
3189 600 020	671 672 673	ÖSTERREICHISCHE AUTOMOBILFABRIK (ÖAF)
	674 675 676	
	677 678	
3189 600 028	732	SNVI
3189 600 030	29 30 36	DAF

Artikelnummer Article No.	Seite Page	Hersteller Manufacturer
3189 600 036	170 175 177	MAN
	181 184 186	
	189 190 191	
	192 261 263	
	279 282 283	
	284 285 286	
	287 288 289	
	290 291 292	
	300 301 302	
	303 304 305	
	306 307 308	
	309 310 311	
	312 313 314	
	315 316 317	
	318 319 320	
	321 322 323	
	324 325 326	
	327 328 329	
	330 331 332	
	333 334 335	
3189 600 036	737 739 744	STEYR
	745	
3189 600 041	292 293 294	MAN
	295	
3189 600 044	281 294 295	MAN
	296 299	
3189 600 045	292 293 294	MAN
	295	
3189 600 045	681 684 685	RENAULT TRUCKS
3189 600 045	760 781	VOLVO
3189 600 053	164	MAN
3189 600 056	731	SCANIA
3189 600 057	409 410 412	MERCEDES-BENZ
	413 414 415	
	417 418 420	
	421 422 423	
	426 427 428	
	429 432 433	
	434 435 436	
	437 438 439	
	441 442 443	
	444 445 446	
	447	
3189 600 058	409 410 412	MERCEDES-BENZ
	413 414 415	
	417 418 420	
	421 422 423	
	426 427 428	
	429 432 433	
3189 600 058	434 435 436	MERCEDES-BENZ
	437 438 439	
	441 442 443	
	444 445 446	
	447 502 503	
	506 507 508	
3189 600 059	819	EVOBUS

Neuaufnahmen / New to range

Artikelnummer Article No.	Seite Page	Hersteller Manufacturer
3189 600 059	502 503 506 507 508 569 575 577 578 593 594 595 597 598 599 600 601 605 607 609 610 611 613 621 623 624 625 626 627 628 629 630 631 632 633 634 637 638 639 640 641 642 643 644 646 647 648 649 650 651 652 656 657 658 659 660 661 662 663 664 665 666 667 668 669 670 874 882 883 889	MERCEDES-BENZ
3189 600 059	926	VAN HOOL
3189 600 060	561 567 568 569 575 576 577 582 583 584 585 586 587 588 590 591 602 603 604 605 606 610 611 612 615 616 617 618 619 620 622 634 635 636 638 645 647 649 652 653 654 656 657 659 666 667 867 868 869 870 871 878 879	MERCEDES-BENZ
3189 600 061	761 762 763 764 765 766 767 768 769 782 783 784 785 786 787 788 789 790 791 792 796 797 798 799 800 933	VOLVO
3400 700 383	40	ISUZU
3400 700 384	670	MITSUBISHI
3400 700 385	40	ISUZU
3400 700 386	670	MITSUBISHI
3400 700 387	40	ISUZU
3400 700 388	670	MITSUBISHI
3400 700 389	40	ISUZU
3400 700 390	40	ISUZU
3400 700 391	40	ISUZU
3400 700 392	40	ISUZU
3400 700 540	922	SETRA

Artikelnummer Article No.	Seite Page	Hersteller Manufacturer
3400 700 541	411 416 419 425 431 440 452 454 465 466 467 468 469	MERCEDES-BENZ
3400 700 542	411 415 416 418 419 424 430 431 437 439 440 450 451 453 459 460 461 462 463 464 471	MERCEDES-BENZ
3400 700 545	411 416 419 425 431 440 452 454 465 466 467 468 469	MERCEDES-BENZ
3400 700 546	408 413 417 421 427 453 455 456 475 479 481 484 489 492	MERCEDES-BENZ
3400 700 548	922	SETRA
3400 700 617	493 494 496 499 503 504 508	MERCEDES-BENZ
3400 700 618	761 785 787 788 789 790 791 798	VOLVO
3400 700 619	731	SCANIA
3400 700 621	518 519 520	MERCEDES-BENZ
3400 700 622	717	RENAULT TRUCKS
3400 700 624	731	SCANIA
3400 700 625	711 712 713 714 715	RENAULT TRUCKS
3400 700 626	711 712 713	RENAULT TRUCKS
3400 700 627	684	RENAULT TRUCKS
3400 700 627	781	VOLVO
3400 700 628	681 685	RENAULT TRUCKS
3400 700 628	760 781	VOLVO
3400 700 629	761 762 763 764 765 785 787 789 790 791 798	VOLVO
3400 700 630	706 707	RENAULT TRUCKS
3400 700 632	705	RENAULT TRUCKS
3400 700 633	825 826	IRISBUS
3400 700 636	71 75	IVECO
3400 700 637	55 59	IVECO
3400 700 640	773	VOLVO

Neuaufnahmen / New to range

Artikelnummer Article No.	Seite Page	Hersteller Manufacturer
3400 700 641	176 178 179	MAN
	180 183 184	
	185 186 188	
	189 190 191	
	192 202 203	
	214 226 261	
	262 263 264	
	265 266 267	
	268 269 270	
	271 272 273	
	274 275 276	
	277 278 279	
	282 283 284	
	285 286 287	
	288 289 290	
	291 300 301	
	302 303 304	
	305 306 307	
	308 309 310	
	311 312 313	
	314 315 316	
	317 318 319	
	320 321 322	
	323 324 325	
	326 327 328	
	329 330 331	
	332 333 334	
	335 336 337	
	338 339 340	
	341 342 343	
	344 345 346	
347 348 349		
350 359		
3400 700 641	672 673 676 677 678	ÖSTERREICHISCHE AUTOMOBILFABRIK (ÖAF)
3400 700 641	737 739 740 744 745	STEYR
3400 700 643	919 920	SETRA
3400 710 066	695 700 717 718	RENAULT TRUCKS
3400 710 066	762 763 784 786 788 790 799 935 936	VOLVO
3400 710 067	716 717 718	RENAULT TRUCKS
3400 710 067	759 760	VOLVO
3400 710 068	772 773	VOLVO
3400 710 070 ■	410 415 418 423 430 448 449 457 458 510	MERCEDES-BENZ
3400 710 071 ■	411 415 416 418 419 424 430 431 437 439 440 450 451 459 460 461 462 463 464 471 510 885	MERCEDES-BENZ

Artikelnummer Article No.	Seite Page	Hersteller Manufacturer
3400 710 072 ■	411 416 419 425 431 440 452 454 465 466 467 468 469	MERCEDES-BENZ
3400 710 073 ■	412 417 420 426 433 442 446 453 470 471	MERCEDES-BENZ
3400 710 073 ■	922	SETRA
3400 710 074 #■	411 415 416 418 419 424 430 431 437 439 440 450 451 453 459 460 461 462 463 464 471	MERCEDES-BENZ
3400 710 075 ■	411 416 419 425 431 440 452 454 465 466 467 468 469	MERCEDES-BENZ
3400 710 076 ■	412 417 420 426 433 442 446 453 470 471	MERCEDES-BENZ
3482 001 199	717	RENAULT TRUCKS
3482 001 308	695 700 717 718	RENAULT TRUCKS
3482 001 308	761 762 763 784 785 786 787 788 789 790 791 798 799 935 936	VOLVO
3482 001 346	731	SCANIA
3482 001 447	772 773	VOLVO
3483 000 509 ⊕	91	IVECO
3483 000 509 ⊕	183 184 185 188 190 192 206 207 209 210 211 212 213 214 216 218 219 220	MAN
3483 000 509 ⊕	673 674 675 676	ÖSTERREICHISCHE AUTOMOBILFABRIK (ÖAF)
3483 000 510 ⊕	206 207 208 209 210 211 212 213 215 216 219 220 221 222 224 225 226	MAN
3483 000 510 ⊕	649 651 665	MERCEDES-BENZ
3483 000 510 ⊕	675 676 677	ÖSTERREICHISCHE AUTOMOBILFABRIK (ÖAF)
3483 000 510 ⊕	682 683 719	RENAULT TRUCKS
3488 000 373	761 762 763 764 765 785 787 789 790 791 798	VOLVO
6283 600 557	731	SCANIA
6284 600 736	671	NISSAN

Neuaufnahmen / New to range

Artikelnummer Article No.	Seite Page	Hersteller Manufacturer		
6284 605 064	409 410 412	MERCEDES-BENZ		
	413 414 415			
	417 418 420			
	421 422 423			
	426 427 428			
	429 432 433			
	434 435 436			
	437 438 439			
	441 442 443			
	444 445 446			
	447 508 882			
	6284 605 065		409 410 412	MERCEDES-BENZ
			413 414 415	
417 418 420				
421 422 423				
426 427 428				
429 432 433				
434 435 436				
437 438 439				
441 442 443				
444 445 446				
447 508				

Artikelnummer Article No.	Seite Page	Hersteller Manufacturer
------------------------------	---------------	----------------------------

Geänderte Bestellnummer / Amended part numbers

Artikelnummer alt Article No. old	Artikelnummer neu Article No. new	Artikelnummer alt Article No. old	Artikelnummer neu Article No. new	Artikelnummer alt Article No. old	Artikelnummer neu Article No. new
1850 282 639	3151 600 724	3151 000 512	3151 000 515		
1860 039 024	1864 634 023	3151 000 536	3151 067 032		
1861 433 401	1878 634 065	3151 123 031	3100 002 038		
1861 600 034	1878 634 072	3151 228 201	3100 008 201		
1861 672 033	1878 006 951	3151 859 001	3151 600 751		
1861 799 133	1878 006 118	3182 008 037	3182 998 501		
1861 907 132	1878 006 117	3182 600 138	3182 654 169		
1861 996 137	1878 006 117	3182 600 140	3182 654 204		
1861 997 137	1878 006 035	3182 600 179	3182 654 169		
1862 123 131	1878 006 055	3182 997 801	3182 654 203		
1862 135 035	1878 006 055	3182 997 803	3182 654 216		
1862 308 031	1878 007 339	3182 997 804	3182 654 192		
1862 408 031	1878 634 071	3182 998 101	3182 654 142		
1862 461 031	1878 063 231	3189 600 015	3189 600 004		
1862 718 002	1878 634 076	3189 600 036	3189 600 009		
1862 788 001	1878 600 863	3400 125 101	3400 125 001		
1863 600 107	1863 837 003	3400 700 359	3400 700 618		
1863 600 119	1863 837 002	3400 700 371	3400 700 611		
1863 805 001	1863 600 128	3400 700 482	3400 700 626		
1863 805 001	1863 600 128	3400 700 631	3400 700 625		
1864 121 536	1861 280 136	3400 710 061	3400 710 066		
1866 133 001	1866 000 332	3482 000 270	3482 037 141		
1866 135 001	1866 000 337	3482 000 552	3482 001 307		
1878 000 205	1878 008 030	3482 000 553	3482 001 308		
1878 003 332	1878 007 279	3482 001 165	3482 001 309		
1878 003 839	1878 007 253	3482 001 169	3482 001 310		
1878 003 969	1878 007 120	3482 001 172	3482 000 474		
1878 005 311	1878 007 046	3482 036 331	3482 102 031		
1878 006 854	1878 007 120	3482 062 035	3482 083 252		
1878 600 649	1878 007 204	3482 078 132	3482 078 134		
1878 634 016	1878 002 706	3483 023 001	3483 000 510		
1878 859 001	1878 654 641	3483 023 003	3483 000 509		
1878 997 501	1878 600 863	3488 017 448	3488 023 031		
1882 022 001	1882 022 101	3488 022 431	3488 017 432		
1882 201 131	1882 201 132	6284 605 012	6284 600 736		
1882 304 237	1882 346 131				
3000 856 701	3000 970 079				
3000 951 111	3000 970 079				
3000 951 112	3000 970 079				
3000 951 238	3000 970 079				
3000 970 021	3000 970 079				
3100 002 114	3100 026 432				
3100 002 419	3100 002 549				

Geänderte Bestellnummer / Amended part numbers

Artikelnummer neu Article No. new	Artikelnummer alt Article No. old	Artikelnummer neu Article No. new	Artikelnummer alt Article No. old	Artikelnummer neu Article No. new	Artikelnummer alt Article No. old
1861 280 136	1864 121 536	3483 000 510	3483 023 001		
1863 600 128	1863 805 001	3488 017 432	3488 022 431		
1863 600 128	1863 805 001	3488 023 031	3488 017 448		
1863 837 002	1863 600 119	6284 600 736	6284 605 012		
1863 837 003	1863 600 107				
1864 634 023	1860 039 024				
1866 000 332	1866 133 001				
1866 000 337	1866 135 001				
1878 002 706	1878 634 016				
1878 006 035	1861 997 137				
1878 006 055	1862 123 131				
1878 006 055	1862 135 035				
1878 006 117	1861 907 132				
1878 006 117	1861 996 137				
1878 006 118	1861 799 133				
1878 006 951	1861 672 033				
1878 007 046	1878 005 311				
1878 007 120	1878 003 969				
1878 007 120	1878 006 854				
1878 007 204	1878 600 649				
1878 007 253	1878 003 839				
1878 007 279	1878 003 332				
1878 007 339	1862 308 031				
1878 008 030	1878 000 205				
1878 063 231	1862 461 031				
1878 600 863	1862 788 001				
1878 600 863	1878 997 501				
1878 634 065	1861 433 401				
1878 634 071	1862 408 031				
1878 634 072	1861 600 034				
1878 634 076	1862 718 002				
1878 654 641	1878 859 001				
1882 022 101	1882 022 001				
1882 201 132	1882 201 131				
1882 346 131	1882 304 237				
3000 970 079	3000 856 701				
3000 970 079	3000 951 111				
3000 970 079	3000 951 112				
3000 970 079	3000 951 238				
3000 970 079	3000 970 021				
3100 002 038	3151 123 031				
3100 002 549	3100 002 419				
3100 008 201	3151 228 201				
3100 026 432	3100 002 114				
3151 000 515	3151 000 512				
3151 067 032	3151 000 536				
3151 600 724	1850 282 639				
3151 600 751	3151 859 001				
3182 654 142	3182 998 101				
3182 654 169	3182 600 138				
3182 654 169	3182 600 179				
3182 654 192	3182 997 804				
3182 654 203	3182 997 801				
3182 654 204	3182 600 140				
3182 654 216	3182 997 803				
3182 998 501	3182 008 037				
3189 600 004	3189 600 015				
3189 600 009	3189 600 036				
3400 125 001	3400 125 101				
3400 700 611	3400 700 371				
3400 700 618	3400 700 359				
3400 700 625	3400 700 631				
3400 700 626	3400 700 482				
3400 710 066	3400 710 061				
3482 000 474	3482 001 172				
3482 001 307	3482 000 552				
3482 001 308	3482 000 553				
3482 001 309	3482 001 165				
3482 001 310	3482 001 169				
3482 037 141	3482 000 270				
3482 078 134	3482 078 132				
3482 083 252	3482 062 035				
3482 102 031	3482 036 331				
3483 000 509	3483 023 003				

Gestrichene Nummern / Deleted references

Artikelnummer Article No.	Artikelnummer Article No.	Artikelnummer Article No.
1800 125 602	1888 064 041	3400 300 196
1805 041 100	1888 600 121	3400 654 130
1860 049 028	1888 600 132	3400 700 347
1861 301 002	1888 600 134	3400 700 634
1861 476 432	1897 376 506	3400 700 635
1861 696 045	2294 501 022	3421 601 070
1861 761 035	2294 701 008	3482 001 124
1861 790 033	3000 166 001	3482 001 370
1861 791 232	3000 170 001	3482 001 371
1861 901 134	3000 325 001	3482 001 386
1861 905 039	3000 388 001	3482 042 041
1861 935 032	3000 534 001	3482 124 542
1861 951 001	3000 769 001	3482 125 132
1861 969 333	3000 835 401	3482 602 009
1862 039 015	3000 950 059	3482 602 011
1862 141 042	3000 950 618	3488 000 087
1862 179 033	3000 950 619	3488 007 631
1862 244 032	3000 950 695	6283 600 532
1862 571 001	3000 950 704	6283 605 001
1862 651 001	3000 951 198	6284 600 584
1862 809 001	3000 951 277	6284 605 009
1862 863 002	3000 951 729	6284 605 027
1862 895 003	3000 951 887	6284 605 029
1862 900 043	3000 963 001	
1863 869 016	3000 970 067	
1864 000 511	3000 990 044	
1864 028 211	3000 990 062	
1864 029 113	3000 990 236	
1864 480 001	3059 008 231	
1864 495 001	3074 600 284	
1864 523 441	3074 600 299	
1864 600 316	3082 000 025	
1864 600 320	3082 000 026	
1864 600 332	3082 033 031	
1864 634 007	3082 149 652	
1864 654 119	3082 158 031	
1864 654 122	3082 161 001	
1864 996 201	3082 201 031	
1866 157 631	3082 235 031	
1874 000 056	3082 251 343	
1874 006 000	3082 270 042	
1878 000 884	3082 311 741	
1878 003 175	3082 600 514	
1878 004 265	3082 600 515	
1878 004 583	3082 600 537	
1878 005 779	3082 600 542	
1878 005 785	3082 600 749	
1878 006 114	3082 600 805	
1878 006 436	3082 631 801	
1878 007 993	3082 632 401	
1878 007 994	3082 654 426	
1878 045 541	3082 654 429	
1878 075 141	3082 664 002	
1878 078 141	3082 764 001	
1878 600 565	3082 793 001	
1878 600 618	3082 832 042	
1878 600 833	3082 843 001	
1878 600 927	3082 850 002	
1878 634 019	3082 906 003	
1878 634 021	3082 967 001	
1878 993 001	3151 061 102	
1878 996 001	3151 093 041	
1880 071 008	3151 174 301	
1881 079 207	3151 236 301	
1882 230 238	3151 600 588	
1882 249 303	3151 997 802	
1882 306 242	3400 300 062	

© ZF Friedrichshafen AG, ZF 5 ZHfa Uf_Yh- 25.04.17

Maßtabelle für Nabenprofile

Measure table for hub profiles

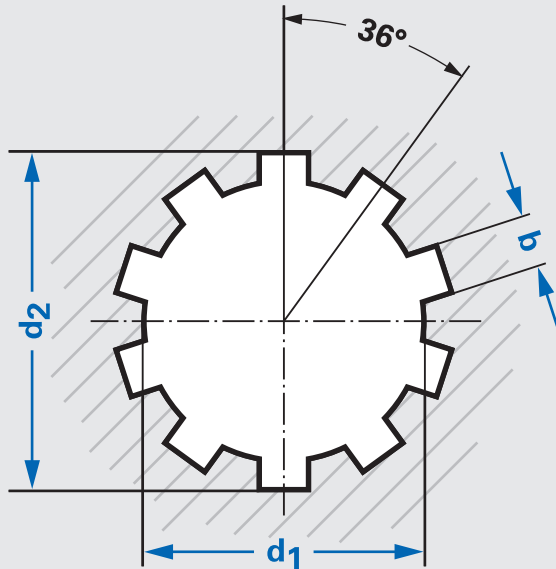

Profiles in inches	$\varnothing d_1$ [mm]	$\varnothing d_2$ [mm]	b [mm]
5/8 "	13,70	16,10	2,50
7/8 "	19,10	22,20	3,45
1 "	20,60	25,80	3,93
1 1/8 "	23,40	28,90	4,45
1 1/4 "	25,80	32,10	4,93
1 3/8 "	28,70	35,20	5,43
1 1/2 "	30,70	38,40	5,89
1 5/8 "	33,40	41,30	6,40
1 3/4 "	36,00	44,50	6,88
2 SAE "	41,10	50,80	7,88

Maßtabelle für Schwungscheiben

Measure table for flywheels

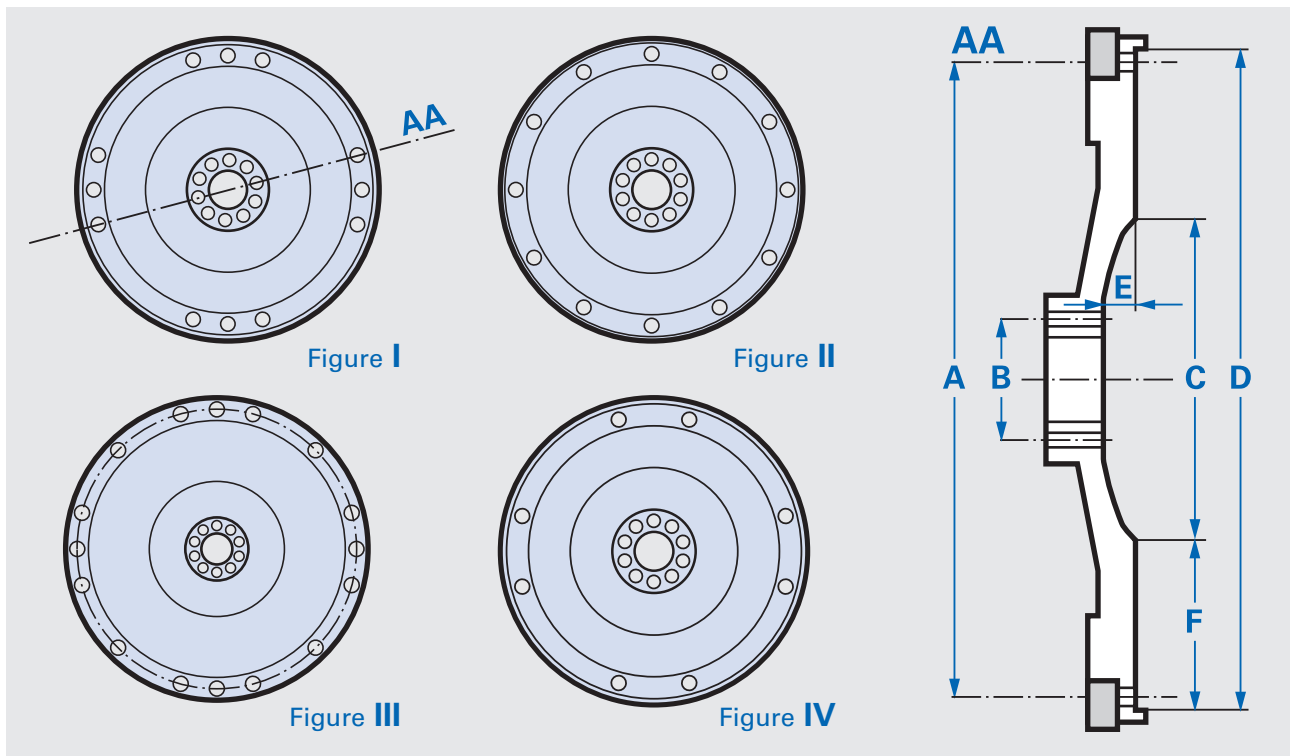

SACHS	Figure	A [mm]	B [mm]	C [mm]	D [mm]	E [mm]	F [mm]
3421 601 001	II	410,00	125,00	193,00	435,00	19,00	121,00
3421 601 002	I	375,00	105,00	190,00	395,00	13,50	102,50
3421 601 003	IV	345,00	105,00	162,00	365,00	23,00	101,50
3421 601 004	IV	345,00	105,00	162,00	365,00	29,00	101,50
3421 601 007	II	410,00	105,00	192,00	435,00	13,50	121,50
3421 601 009	II	410,00	88,00	196,00	435,00	17,50	119,50
3421 601 010	II	450,00	88,00	216,00	475,00	17,50	129,50
3421 601 011	I	450,00	88,00	235,00	475,00	19,00	120,00
3421 601 012	I	450,00	88,00	235,00	475,00	19,00	120,00
3421 601 014	III	450,00	88,00	235,00	475,00	19,00	120,00
3421 601 015	III	450,00	88,00	235,00	475,00	19,00	120,00
3421 601 016	I	450,00	88,00	235,00	475,00	17,50	120,00
3421 601 017	II	410,00	88,00	245,00	435,00	17,50	95,00
3421 601 019	II	450,00	112,00	235,00	470,00	29,50	117,50
3421 601 020	II	450,00	105,00	235,00	470,00	30,50	117,50
3421 601 021	II	450,00	88,00	235,00	475,00	17,50	120,00
3421 601 024	II	450,00	105,00	215,00	470,00	29,50	127,50
3421 601 025	II	450,00	88,00	235,00	475,00	21,00	120,00
3421 601 037	I	450,00	125,00	238,50	470,00	23,00	115,75
3421 601 038	I	450,00	110,00	237,00	475,00	26,00	119,00
3421 601 041	II	450,00	130,00	236,00	475,00	35,00	119,50
3421 601 042	II	450,00	112,00	235,00	470,00	29,50	117,50
3421 601 043	III	450,00	88,00	257,00	475,00	21,00	109,00
3421 601 044	III	450,00	88,00	257,00	475,00	21,00	109,00
3421 601 045	III	450,00	88,00	257,00	475,00	22,20	109,00
3421 601 046	III	450,00	88,00	257,00	475,00	22,50	109,00







Maßtabelle für Schwungscheiben

Measure table for flywheels

 SACHS	Figure	A [mm]	B [mm]	C [mm]	D [mm]	E [mm]	F [mm]
3421 601 047	III	450,00	88,00	235,00	475,00	21,00	120,00
3421 601 048	II	410,00	74,00	235,50	435,00	19,30	99,75
3421 601 049	II	410,00	84,00	235,50	435,00	19,30	99,75
3421 601 050	I	450,00	88,00	235,00	475,00	17,50	120,00
3421 601 051	II	375,00	74,00	236,00	395,00	19,50	79,50
3421 601 052	II	375,00	84,00	235,50	395,00	20,00	79,75
3421 601 053	I	450,00	84,00	235,50	475,00	18,50	119,75
3421 601 054	II	450,00	88,00	257,00	470,00	29,30	106,50
3421 601 055	II	450,00	112,00	257,00	470,00	29,50	106,50
3421 601 056	II	375,00	74,00	235,50	395,00	26,00	79,75
3421 601 057	II	450,00	105,00	236,00	470,00	30,50	117,00
3421 601 058	II	450,00	112,00	257,00	470,00	29,50	106,50
3421 601 059	II	450,00	112,00	257,00	470,00	29,50	106,50
3421 601 060	I	450,00	153,00	237,50	475,00	42,00	118,75
3421 601 061	I	450,00	140,00	235,50	475,00	35,00	119,75
3421 601 062	III	450,00	88,00	257,00	475,00	22,50	109,00
3421 601 063	III	450,00	88,00	235,00	475,00	22,20	120,00
3421 601 064	II	410,00	85,00	193,20	435,00	19,50	120,90
3421 601 065	II	410,00	85,00	193,00	435,00	19,00	121,00
3421 601 066	I	450,00	140,00	235,70	475,00	35,00	119,65
3421 601 067	I	450,00	100,00	237,00	475,00	31,10	119,00
3421 601 068	II	375,00	84,00	235,60	395,00	19,70	79,70
3421 601 071	I	450,00	110,00	256,00	475,00	22,30	109,50
3421 601 072	I	450,00	110,00	256,00	475,00	22,30	109,50
3421 601 073	I	450,00	110,00	256,00	475,00	22,20	109,50
3421 601 074	I	450,00	110,00	256,00	475,00	22,20	109,50
3421 601 075	III	450,00	88,00	235,50	475,00	22,30	119,75
3421 601 076	II	410,00	85,00	217,00	435,00	19,00	109,00
3421 601 077	II	375,00	85,00	190,00	389,00	19,00	99,50
3421 601 078	I	450,00	100,00	257,00	475,00	24,50	103,50
3421 601 079	II	410,00	84,00	235,00	435,00	21,50	100,00
3421 601 080	II	410,00	84,00	235,00	435,00	21,50	100,00
3421 601 081	II	375,00	84,00	235,00	395,00	21,50	80,00
3421 601 082	I	450,00	153,00	289,00	475,00	42,00	93,00
3421 601 083	II	375,00	84,00	235,50	395,00	22,00	80,00
3421 601 084	II	450,00	120,00	261,00	470,00	31,00	104,40
3421 601 085	III	450,00	88,00	260,00	475,00	22,50	170,50
3421 601 086	I	450,00	110,00	256,00	475,00	22,30	109,50
3421 601 087	I	450,00	153,00	258,50	475,00	42,00	108,25
3421 601 088	I	450,00	153,00	237,50	475,00	42,00	118,75
3421 601 089	IV	410,00	100,00	218,00	435,00	27,50	108,50
3421 601 090	I	450,00	100,00	236,00	475,00	27,50	119,50
3421 601 091	I	450,00	100,00	236,00	475,00	50,00	119,50

Stückliste für Zweischeibenkupplungen

Parts List for double disc clutch

 SACHS	Parameter	Pressure plate + Releaser	Pressure plate	Releaser	Intermediate ring	Clutch disc
						
3488 006 201	GMFZ445W	---	3482 025 201	3151 000 598	---	---
3488 006 205	GMFZ445W	---	---	3151 000 598	---	1861 948 101
3488 019 031	GMFZ2/380	3483 027 231	3482 111 031	3151 000 154	3459 017 031	---
3488 019 133	GMFZ2/380	---	3482 111 031	3151 000 750	3459 017 032	1862 248 033
3488 013 138	GMFZ2/350	3483 014 132	3482 056 031	3151 000 154	3459 000 009	1878 001 080
3488 000 024	MFZ2/400X	3483 034 135	---	3151 000 154	3459 018 004	1878 000 635
3488 000 102	GMFZ2/400N	---	---	3100 000 046	---	1878 002 023
3488 000 159	MFZ2/400X	3483 034 135	---	3151 000 154	3459 018 004	1878 004 128
3488 022 253	MFZ2/400X	3483 034 135	---	3151 000 154	3459 018 004	1878 002 442
3488 000 024	MFZ2/400X	3483 034 135	---	3151 000 154	3459 018 004	1878 000 635
3488 023 031	MFZ2/400X	---	---	3100 000 003	3459 018 004	1878 002 023
3488 000 158	MFZ2/400X	---	---	3100 000 003	3459 018 004	1878 002 020
3488 019 032	GMFZ2/380	3483 027 332	3482 111 032	3151 000 154	---	1862 248 033
3488 016 031	GMFZ2/400/GTZ	3483 018 131	3482 071 131	3151 000 154	3459 012 131	1878 087 241
3488 018 031	GMFZ2/400X	---	3482 110 031	3151 000 154	3459 016 031	1878 002 460
3488 000 037	MFZ2/400X	---	---	---	3459 018 004	---
3488 000 122	MFZ2/400X	---	---	---	3459 018 004	---
3488 017 334	MFZ2/400X	---	---	---	3459 018 032	1862 380 031
3488 017 410	MFZ2/400X	---	---	---	3459 018 004	1878 005 805
3488 017 439	MFZ2/400X	---	---	---	3459 018 032	1862 380 031
3488 017 442	MFZ2/400X	---	---	---	3459 018 032	1878 002 456
3488 017 333	MFZ2/400X	---	---	---	3459 018 004	1862 302 031
3488 017 447	MFZ2/400X	---	---	---	3459 018 004	1878 002 023
3488 000 108	MFZ2/400X	---	---	---	3459 018 004	1878 002 020
3488 000 158	MFZ2/400X	---	---	3100 000 003	3459 018 004	1878 002 019
3488 000 373	MFZ2/400X	---	---	3151 000 154	3459 018 004	1878 007 368
3488 009 634	GTF2/380	---	3482 033 401	---	3459 004 108	1878 006 118
3488 007 631	GTF2/380	---	3482 026 332	---	3459 004 108	1878 006 117
3488 000 368	MFZ2/400X	---	---	---	3459 018 004	1878 005 340
3488 000 366	MFZ2/400X	---	---	---	3459 018 004	---
3488 007 631	GTF2/380	---	3482 026 332	---	3459 004 108	1878 006 117

Memo

A large rectangular area filled with horizontal gray lines, serving as a template for writing a memo. The lines are evenly spaced and cover the majority of the page below the header.

- DE** *Kupplungen für Nfz*
- EN** *Clutches for CV*
- FR** *Embrayages pour véhicules industriels*
- ES** *Embragues para vehículos industriales*
- PT** *Embreagens para veículos utilitários*
- IT** *Frizioni per veicoli commerciali*
- NL** *Koppelingen voor bedrijfswagens*
- NO** *Clutcher for nyttekjøretøy*
- SV** *Kopplingar för nyttofordon*
- FI** *Kytkimet hyötyajoneuvoon*
- PL** *Sprzęgła dla pojazdów użytkowych*
- RU** *Сцепления для коммерческого транспорта*
- HU** *Tengelykapcsolók haszonjárművekhez*
- CS** *Spojky pro užitková vozidla*
- RO** *Ambreiaje pentru autoutilitare*
- HR** *Spojke za gospodarska vozila*
- EL** *Συμπλέκτες για φορτηγά*
- TR** *Ticari araçlar için debriyajlar*
- ZH** 商用VH合器

