

Scania

Alternative and interchangeable
spare parts

cosibo[®]



2014 EDITION

For Scania A totally reliable range of alternative and interchangeable spare parts

Cosibo guarantee the high quality of their products.

A staff of mechanical engineers, studies, analyses and "re-designs" original spare parts. It is a very delicate stage, because in order to guarantee to **Cosibo** products the same characteristics of original spare parts, it is necessary to have great mastery of the employed technologies and a perfect knowledge of the characteristics of the materials to be used. After this stage, another fundamental step is related to the identification of the many companies and contractors to which **Cosibo** commissions the realisation of its large range of products.

Cosibo strength and quality are witnessed by the several partnership co-operations in force between the Company and some of the most qualified producers in different sectors: mechanic, electronic, plastic materials moulding, oil hydraulic, electric and all the others specialised in the production of spare parts.

According to the company philosophy, **Cosibo** has with all these companies well established and clear co-operations with the consequence that they can offer not only high quality products but also short lead-times while respecting the agreed delivery dates. The aim is to offer reliable and efficient answers to any single customer all over the world.

This catalogue shows the whole range of spare parts for **Scania** trucks.

A very rich range to guarantee the availability of the spare parts for the various components of the vehicle:

Engine · Clutch · Speed gear · Propeller shaft · Front axle · Differential gear · Rear axle · Hubs and wheels

Braking system · Suspension · Steering · Engine bonnet · Electric unit · Cab · Lights · Mirrors · Body parts

Accessories

NOTES

IMPORTANT

- All the components listed in our catalogue are not original, though perfectly interchangeable.
- Reference numbers, either original or of a different nature, are for information purposes only. When placing an order, please, always use Cosibo reference numbers and do not mention the original reference of the truck manufactures in the invoice to vehicle owners or to anybody else.
- If the customer does not apply with what above he takes all his own responsibilities.

LEGEND

- All the spare parts in this catalogue are divided into **Groups** on the basis of the part of the truck they are destined to.
- Each **Group** is identified by a letter from the alphabet as it follows:

A	ENGINE
B	CLUTCH
C	SPEED GEAR
D	PROPELLER SHAFT
E	FRONT AXLE
F	REAR AXLE
G	HUBS AND WHEELS
H	BRAKING SYSTEM
I	MIRRORS BODY PARTS AND ELECTRIC MATERIAL
J	CAB
L	SUSPENSION
M	STEERING
N	LIGHTS AND ELECTRIC UNIT
O	ACCELERATOR PEDAL

- Each product in the catalogue is identified by specific **Codes**:

Code (Cosibo code)

Re. OEM (original code)

Re. ex OEM (ex original code)

- With reference to each product, truck **Models** and **Applications** it is destined to are shown:

● **Model** (marked by a dot)

★ **Application** (marked by a star)

- Page numbering is determined by the **Letter** indicating the Group + a progressive **number** (in bold) to indicate the sub-group + a progressive **number** to indicate the order of appearance in the catalogue:

A.1.25

- Two **General Indexes** are at the end of the catalogue. The first one is on the basis of the **Cosibo codes** and the second one is on the basis of the **OEM codes** (original codes).

CATALOGUE STRUCTURE

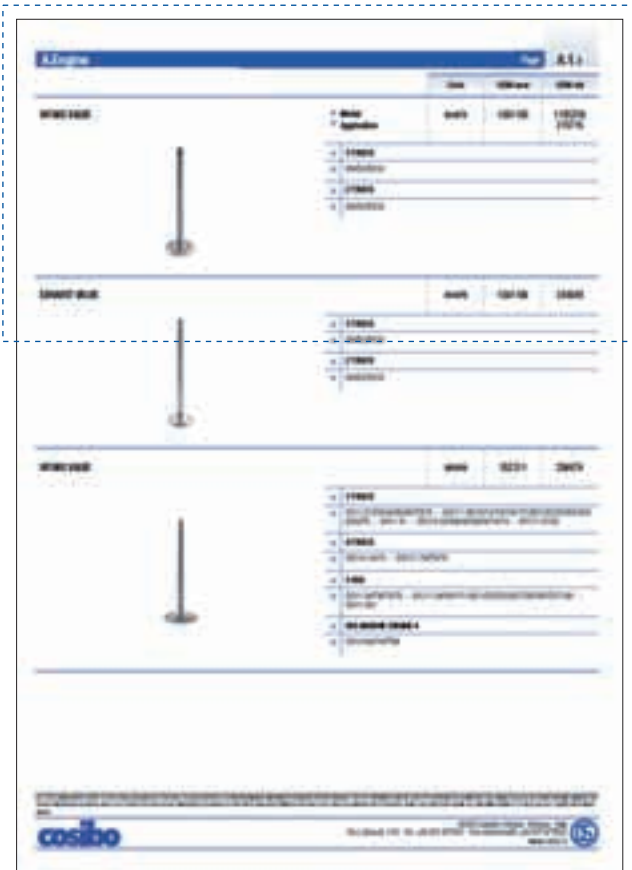

Group it is referred to

Page numbering

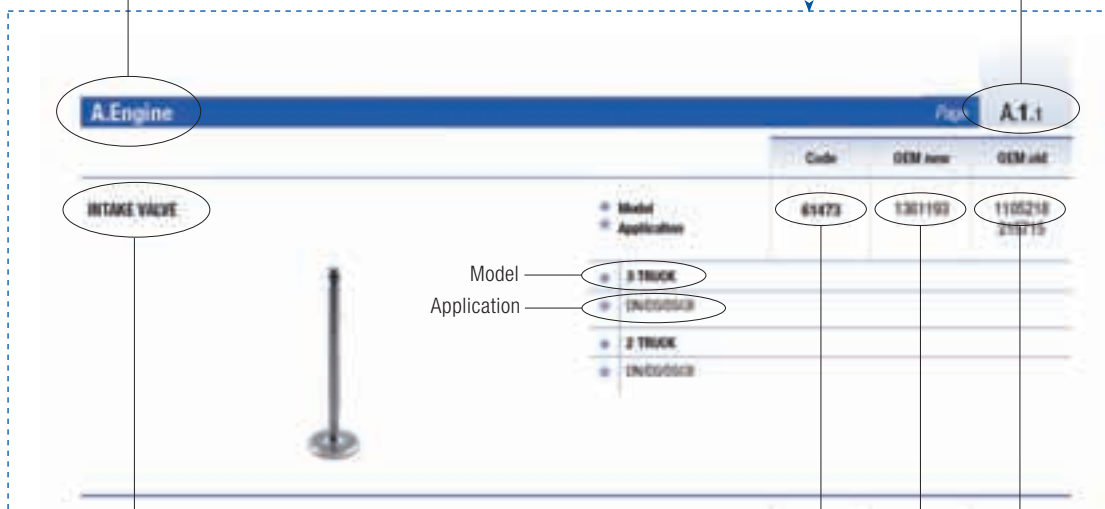

All the components listed in our catalogue are not original, though perfectly interchangeable. Reference numbers, either original or of a different nature, are for information purposes only. When placing an order, please, always use cosibo reference numbers and do not mention the original reference numbers of the truck manufacturers in the invoice to vehicle owners or to anybody else. The customer takes his own responsibility if he does not comply with what above.

GOODS TO BE RETURNED AND COMPLAINTS

When the goods are delivered, the customer has to check that the number of boxes corresponds to what it is shown in the delivery note and that packaging is intact.

If not, when accepting the goods, he will have to clearly mention "subject to inspection" in the delivery note and he will inform immediately or, anyway, within 8 days from the delivery date Cosibo SpA.

In case the goods are made of body parts, lighting and mirrors, the delivery note and/or the CMR will have to be signed **always** by mentioning "subject to inspection" even if the delivered boxes are intact.

It has to be taken into account that only when showing the above mentioned document there will be the chance to have the goods promptly replaced.

And this is valid when carriage is paid both by the sender (Cosibo SpA) and by the customer who receives the goods.

Customer is made aware that no dispute concerning these cases will be accepted by Cosibo SpA unless it has been formalised in the delivery note at the moment of the delivery of the goods.

CHARACTERISTICS OF THE COMPLAINT:

LACK: customer reckons not to have received in full or partially what it is mentioned in a delivery note;

SURPLUS: customer reckons to have received a bigger quantity than what it is mentioned in a delivery note;

INVERSION: customer reckons to have received a different product from what it is mentioned in a delivery note;

QUALITY: customer reckons that the purchased goods do not meet technical characteristics as per what it is mentioned in the catalogue;

BREAKS: customer reckons to have received damaged goods.

In all these cases the customer has to inform Cosibo SpA in writing within 8 days from the delivery date of the goods.

This is valid as well when the customer reckons some prices and/or discounts that have been applied are different from what it was agreed.

Any dispute not formalised according to these procedures and timing will be rejected by Cosibo SpA.

PROCEDURE

GOODS TO BE RETURNED: for any request to return some goods the customer will have to fill in the "authorisation to return the good" form in a proper and detailed way and will send it to Cosibo SpA together with a picture of the piece claimed to be defective; after that, he will wait for the authorisation to return the piece.

Without such an authorisation by Cosibo SpA any returned good will be rejected. Should Cosibo SpA urge the customer to send the pictures if these are not sent within ten days from the solicitation warranty on the product will be considered no more in force. Any good authorised to be returned will have to be shipped to Cosibo SpA possibly in its original packaging together with the "authorisation to return the good" form and a copy of the delivery note signed by both the customer and the freight agent; moreover, it will have to be a good under standard production to be recognised by the computer system as an active code.

Cosibo SpA reserve the right to check the returned good; should the piece turn out to have been tempered or not to be defective the customer will be charged with freight costs and the greater damage as well.



ORDER MISTAKES: if the mistake can be attributed to the customer Cosibo SpA reserve the right to authorise the return. Anyway, the customer will be charged with any freight costs.

RETURNED GOODS NOT PRODUCED BY COSIBO SPA: Cosibo SpA will send back the goods and will charge the customer of the sum of Euro 50,00 + V.A.T. as administration costs. The same applies when the returned goods were delivered years before. Both cases the customer within three days from the rejection of the returned goods by Cosibo SpA will have to send the authorisation to scrap the goods. On the contrary, Cosibo SpA will send back the goods according to what above.

COMPLAINTS INTERRUPTION: each year all the complaint sent during the month of August and from December 15th to January 15th will be put on hold.

All these complaints will be taken into account starting from 15 days after the above mentioned periods.

TERMS AND CONDITIONS: Cosibo SpA will not recognise any warranty right if no communication is sent within eight days from the moment the defect has arisen and anyway after more than year from the delivery.

	Code	OEM new	OEM old
INTAKE VALVE	61473	1361193	1105218 215715
	<ul style="list-style-type: none"> ● Model ★ Application 		
	<ul style="list-style-type: none"> ● 2 TRUCK ★ DN/DS/DSC8 		
	<ul style="list-style-type: none"> ● 3 TRUCK ★ DN/DS/DSC8 		
EXHAUST VALVE	61475	1361196	243648
	<ul style="list-style-type: none"> ● 2 TRUCK ★ DN/DS/DSC8 		
	<ul style="list-style-type: none"> ● 3 TRUCK ★ DN/DS/DSC8 		
INTAKE VALVE	60010	352211	294674
	<ul style="list-style-type: none"> ● 3 BUS ★ DS11 34/ 74/ 75/ 78 - DSC11 04/ 08/ 17/ 18/ 21/ 22/ 23/ 24/ 27/ 35/ 36/ 70/ 71/ 81 - DSI11 E01 		
	<ul style="list-style-type: none"> ● IND. MARINE ENGINE 4 ★ DS14 68/ 74/ 75M 		
	<ul style="list-style-type: none"> ● 3 TRUCK ★ DS11 21/ 23/ 34/ 35/ 36/ 73/ 75 - DSC11 08/ 10/ 12/ 13/ 16/ 17/ 18/ 21/ 22/ 23/ 30/ 35/ 36/ 39/ 70 - DN11 01 - DSC14 03/ 04/ 06/ 08/ 09/ 10/ 16 - DTC11 01/ 02 		
	<ul style="list-style-type: none"> ● 4 TRUCK ★ DSC14 13/ 15 - DSC11 74/ 75/ 79 		

ALL THE COMPONENTS LISTED IN OUR CATALOGUE ARE NOT ORIGINAL, THOUGH PERFECTLY INTERCHANGEABLE. REFERENCE NUMBERS, EITHER ORIGINAL OR OF A DIFFERENT NATURE, ARE FOR INFORMATION PURPOSES ONLY. WHEN PLACING AN ORDER, PLEASE, ALWAYS USE COSIBO REFERENCE NUMBERS AND DO NOT MENTION THE ORIGINAL REFERENCE NUMBERS OF THE TRUCK MANUFACTURERS IN THE INVOICE TO VEHICLE OWNERS OR TO ANYBODY ELSE. THE CUSTOMER TAKES HIS OWN RESPONSIBILITY IF HE DOES NOT COMPLY WITH WHAT ABOVE.

	Code	OEM new	OEM old
INTAKE VALVE	65336	1360836	
● Model			
★ Application			
● 3 BUS			
★ OSC11 G01			
● 4 TRUCK			
★ OSC11 G03			



	Code	OEM new	OEM old
EXHAUST VALVE	60014	1397521	1100997 1360834 232018 352347
● 3 BUS			
★ DS11 34/ 74/ 75/ 78 - DSC11 04/ 08/ 17/ 18/ 21/ 22/ 23/ 24/ 27/ 35/ 36/ 70/ 71/ 81 - DSI11 E01 - OSC11 G01			
● IND. MARINE ENGINE 4			
★ DSI14 68/ 74/ 75M			
● 3 TRUCK			
★ DS11 34/ 73/ 75 - DSC11 08/ 10/ 12/ 13/ 16/ 17/ 18/ 21/ 22/ 23/ 30/ 34/ 35/ 36/ 39/ 70/ 73 - DN11 01 - DSC14 03/ 04/ 06/ 08/ 09/ 10/ 16 - DTC11 01/ 02			
● 4 TRUCK			
★ DSC11 74/ 75/ 79 - OSC11 G03			



	Code	OEM new	OEM old
EXHAUST VALVE	62108	1116987	263427
● 3 BUS			
★ DSC11 24/ 27 - DSI11 E01			
● 3 TRUCK			
★ DS11 34/ 73/ 75 - DSC11 08/ 10/ 12/ 13/ 16/ 17/ 18/ 21/ 22/ 23/ 30/ 35/ 36/ 70 - DN11 01 - DSC14 03/ 04/ 06/ 08/ 09/ 10/ 16 - DTC11 01/ 02			
● 4 TRUCK			
★ DSC14 13/ 15			



ALL THE COMPONENTS LISTED IN OUR CATALOGUE ARE NOT ORIGINAL, THOUGH PERFECTLY INTERCHANGEABLE. REFERENCE NUMBERS, EITHER ORIGINAL OR OF A DIFFERENT NATURE, ARE FOR INFORMATION PURPOSES ONLY. WHEN PLACING AN ORDER, PLEASE, ALWAYS USE COSIBO REFERENCE NUMBERS AND DO NOT MENTION THE ORIGINAL REFERENCE NUMBERS OF THE TRUCK MANUFACTURERS IN THE INVOICE TO VEHICLE OWNERS OR TO ANYBODY ELSE. THE CUSTOMER TAKES HIS OWN RESPONSIBILITY IF HE DOES NOT COMPLY WITH WHAT ABOVE.

	Code	OEM new	OEM old
INTAKE VALVE	65334	1386647	
<ul style="list-style-type: none"> ● Model ★ Application 			
<ul style="list-style-type: none"> ● 4 BUS ★ DC9 01/ 02/ 03/ 04/ / 05/ 06 			
<ul style="list-style-type: none"> ● 4 TRUCK ★ DC9 01/ 02/ 03/ 04/ / 05/ 06 			



	Code	OEM new	OEM old
EXHAUST VALVE	65335	1386648	1414395
<ul style="list-style-type: none"> ● 4 BUS ★ DC9 01/ 02/ 03/ 04/ / 05/ 06 			
<ul style="list-style-type: none"> ● 4 TRUCK ★ DC9 01/ 02/ 03/ 04/ / 05/ 06 			



	Code	OEM new	OEM old
INTAKE VALVE	63546	1785076	1333230 1477022
<ul style="list-style-type: none"> ● 4 BUS ★ DSC12 01/ 02/ 03/ 05 - DC11 01/ 02/ 03/ 04/ 06/ 07 - DC12 01/ 02/ 09/ 16 - DC9 19/ 20/ 21 			
<ul style="list-style-type: none"> ● F-K-N BUS ★ PDE HPI 			
<ul style="list-style-type: none"> ● IND. MARINE ENGINE 4 ★ D12M EMS - DI12 69M - SGI 12A - DC12 50A/ 54A/ 57A - DC16 A - D12A EMS - DI16 48A/ 56A - D16M 			
<ul style="list-style-type: none"> ● IND. MARINE ENGINE 5 ★ SG9 A280 - DC9 EMS 			
<ul style="list-style-type: none"> ● 4 TRUCK ★ DSC12 01/ 02/ 03/ 05 - DC11 01/ 02/ 03/ 04/ 06/ 07 - DC12 01/ 02/ 03/ 09/ 16 - DC9 19/ 20/ 21 - DT12 02/ 08 L01 - DT12 10 - DC16 			
<ul style="list-style-type: none"> ● P-G-R-T TRUCK ★ PDE HPI 			



ALL THE COMPONENTS LISTED IN OUR CATALOGUE ARE NOT ORIGINAL, THOUGH PERFECTLY INTERCHANGEABLE. REFERENCE NUMBERS, EITHER ORIGINAL OR OF A DIFFERENT NATURE, ARE FOR INFORMATION PURPOSES ONLY. WHEN PLACING AN ORDER, PLEASE, ALWAYS USE COSIBO REFERENCE NUMBERS AND DO NOT MENTION THE ORIGINAL REFERENCE NUMBERS OF THE TRUCK MANUFACTURERS IN THE INVOICE TO VEHICLE OWNERS OR TO ANYBODY ELSE. THE CUSTOMER TAKES HIS OWN RESPONSIBILITY IF HE DOES NOT COMPLY WITH WHAT ABOVE.

	Code	OEM new	OEM old
EXHAUST VALVE	63545	1791152	1328537 1445830
● Model			
★ Application			
● 4 BUS			
★ DSC12 01/ 02/ 03/ 05 - DC11 01/ 02/ 03/ 04/ 06/ 07 - DC12 01/ 02/ 09/ 16 - DC9 19/ 20/ 21			
● F-K-N BUS			
★ PDE HPI			
● IND. MARINE ENGINE 4			
★ D12M EMS - DI12 69M - SGI 12A - DC12 50A/ 54A/ 57A - DC16 A - D12A EMS - DI16 48A/ 53A - D16 M			
● IND. MARINE ENGINE 5			
★ SG9 A280 - DC9A EMS			
● 4 TRUCK			
★ DSC12 01/ 02/ 03/ 05 - DC11 01/ 02/ 03/ 04/ 06/ 07 - DC12 01/ 02/ 03/ 09/ 16 - DT12 02/ 08/ L01/ L02 - DT12 10 - DC9 19/ 20/ 21 - DC16			
● P-G-R-T TRUCK			
★ PDE HPI			



	61476	1801529	1319081 391608
INTAKE VALVE			
● 3 BUS			
★ DS/ DSC9			
● 4 BUS			
★ DSC9 - DS19 E01 - OSC9			
● IND. MARINE ENGINE 4			
★ SG9 A280 - D/ DS9 90/ 92A - DC DSC9 46/ 47/ 49/ 50/ 51A - DI/ DS19 48/ 51/ 53A - DC9 51/ 53/ 54/ 55A - DI9 56A			
● 3 TRUCK			
★ DN/ DS9 - DSC9 2/ 7/ 8/ 9/ 10			
● 4 TRUCK			
★ DSC9			



ALL THE COMPONENTS LISTED IN OUR CATALOGUE ARE NOT ORIGINAL, THOUGH PERFECTLY INTERCHANGEABLE. REFERENCE NUMBERS, EITHER ORIGINAL OR OF A DIFFERENT NATURE, ARE FOR INFORMATION PURPOSES ONLY. WHEN PLACING AN ORDER, PLEASE, ALWAYS USE COSIBO REFERENCE NUMBERS AND DO NOT MENTION THE ORIGINAL REFERENCE NUMBERS OF THE TRUCK MANUFACTURERS IN THE INVOICE TO VEHICLE OWNERS OR TO ANYBODY ELSE. THE CUSTOMER TAKES HIS OWN RESPONSIBILITY IF HE DOES NOT COMPLY WITH WHAT ABOVE.

		Code	OEM new	OEM old
EXHAUST VALVE	● Model	61477	1360833	278102
	★ Application			
	● 3 BUS			
	★ DS/ DSC9			
	● 4 BUS			
	★ DSC9 - DS19 E01 - OSC9			
	● IND. MARINE ENGINE 4			
	★ SG9 A280 - D/ DS9 46/ 47/ 49/ 50/ 51A - DI/ DS19 48/ 51/ 53A - DC9 51/ 53/ 54/ 55A - DI9 56A - D/ DS9 90/ 92A - DC/ DSC9 46/ 47/ 49/ 50/ 51A			
	● 3 TRUCK			
	★ DN/ DS9 - DSC9 2/ 7/ 8/ 9/ 10			
	● 4 TRUCK			
	★ DSC9			

		60017	1523410	269715 300957
INTAKE VALVE GUIDE	● 3 BUS			
	★ DS11 34/ 74/ 75/ 78 - DSC11 04/ 08/ 17/ 18/ 21/ 22/ 23/ 35/ 36/ 71 - DS/ DSC9			
	● IND. MARINE ENGINE 4			
	★ DS14 68/ 74/ 75M			
	● 3 TRUCK			
	★ DN9 - DS9 - DSC9 02/ 07/ 08/ 10 - DS11 34/ 73/ 75 - DSC11 08/ 10/ 12/ 13/ 16/ 17/ 18/ 21/ 22/ 23/ 30/ 35/ 36/ 39 - DN11 01 - DSC14 03/ 04/ 06/ 08/ 09/ 10 - DTC11 01			
● 4 TRUCK				
★ DSC11 74/ 75 - OSC11 G03				

ALL THE COMPONENTS LISTED IN OUR CATALOGUE ARE NOT ORIGINAL, THOUGH PERFECTLY INTERCHANGEABLE. REFERENCE NUMBERS, EITHER ORIGINAL OR OF A DIFFERENT NATURE, ARE FOR INFORMATION PURPOSES ONLY. WHEN PLACING AN ORDER, PLEASE, ALWAYS USE COSIBO REFERENCE NUMBERS AND DO NOT MENTION THE ORIGINAL REFERENCE NUMBERS OF THE TRUCK MANUFACTURERS IN THE INVOICE TO VEHICLE OWNERS OR TO ANYBODY ELSE. THE CUSTOMER TAKES HIS OWN RESPONSIBILITY IF HE DOES NOT COMPLY WITH WHAT ABOVE.

	Code	OEM new	OEM old
INTAKE VALVE GUIDE	62105	1521210	393263
● Model			
★ Application			
● 3 BUS			
★ DS11 70/ 78 - DSC11 21/ 24/ 27/ 70/ 71/ 81 - DSI11 E01 - OSC11 G01			
● 4 BUS			
★ OSC9			
● IND. MARINE ENGINE 4			
★ SG9 A280			
● 3 TRUCK			
★ DN/ DS9 - DSC9 07/ 09/ 10 - DSC14 08/ 09/ 10 ENG 5 550 362 - DSC11 70 - DTC11 02 - DSC14 16			
● 4 TRUCK			
★ DSC11 79 - DSC14 13/ 15			



	Code	OEM new	OEM old
EXHAUST VALVE GUIDE	60018	1521209	1398624 223635 269716 300958 393264
● 3 BUS			
★ DS11 34/ 74/ 75/ 78 - DSC11 04/ 08/ 17/ 18/ 21/ 22/ 23/ 24/ 27/ 35/ 36/ 70/ 71/ 81 - DS/ DSC9 - DSI11 E01 - OSC11 G01			
● 4 BUS			
★ DC9 01/ 02/ 03/ 04/ 05/ 06 ALSO INTAKE - OSC9 - DSI9 E01 ALSO INTAKE - DSC9 ALSO INTAKE			
● IND. MARINE ENGINE 4			
★ SG9 A280 - DSI14 68/74/75M - D/DS9 90/92A ALSO INTAKE - DC/DSC9 46/47/49/50/51A ALSO INTAKE - DI/DSI9 48/51/53A ALSO INTAKE - DC9 51/53/54/55A ALSO INTAKE - DI9 56A ALSO INTAKE			
● 3 TRUCK			
★ DN/ DS9 - DSC9 02/ 07/ 08/ 09/ 10 - DS11 34/ 73/ 75 - DSC11 08/ 10/ 12/ 13/ 16/ 17/ 18/ 21/ 23/ 30/ 35/ 36/ 39/ 70 - DN11 01 - DSC14 03/ 04/ 06/ 08/ 09/ 10/ 16 - DTC11 01/ 02			
● 4 TRUCK			
★ DSC11 74/ 75/ 79 - OSC11 G03 - DSC14 13/ 15 - DSC9 ALSO INTAKE - DC9 01/ 02/ 03/ 04/ 05/ 06 ALSO INTAKE			



ALL THE COMPONENTS LISTED IN OUR CATALOGUE ARE NOT ORIGINAL, THOUGH PERFECTLY INTERCHANGEABLE. REFERENCE NUMBERS, EITHER ORIGINAL OR OF A DIFFERENT NATURE, ARE FOR INFORMATION PURPOSES ONLY. WHEN PLACING AN ORDER, PLEASE, ALWAYS USE COSIBO REFERENCE NUMBERS AND DO NOT MENTION THE ORIGINAL REFERENCE NUMBERS OF THE TRUCK MANUFACTURERS IN THE INVOICE TO VEHICLE OWNERS OR TO ANYBODY ELSE. THE CUSTOMER TAKES HIS OWN RESPONSIBILITY IF HE DOES NOT COMPLY WITH WHAT ABOVE.

INTAKE AND EXHAUST VALVE GUIDE



	Code	OEM new	OEM old
● Model	63896	1403823	
★ Application			
● 4 BUS			
★	DSC12 01/ 02/ 03/ 05 - DC11 01/ 02/ 03/ 04/ 06/ 07 - DC12 01/ 02/ 09/ 16 - DC9 19/ 20/ 21		
● F-K-N BUS			
★	PDE HPI - XPI		
● IND. MARINE ENGINE 4			
★	D12M EMS - DI12 69M - SGI12A - DC12 50A/ 54A/ 57A - DC16A - D12A EMS - DI16 48A/ 53A - DI16M		
● IND. MARINE ENGINE 5			
★	SG9 A280 - DC9A EMS		
● 4 TRUCK			
★	DSC12 01/ 02/ 03/ 05 - DC11 01/ 02/ 03/ 04/ 06/ 07 - DC12 01/ 02/ 03/ 09/ 16 - DC9 19/ 20/ 21 - DT12 02/ 08 L01/ L02 - DT12 10 - DC16		
● P-G-R-T TRUCK			
★	PDE HPI - XPI		

FLYWHEEL



	Code	OEM new	OEM old
● Model	60109	393151	306993
★ Application			
● 3 BUS			
★			
● 4 BUS			
★	DSC9 - DC9 01/ 02/ 03/ 04/ 05/ 06 - K/ L/ N 94 - DC9 - DSC9 - DSI9 E01 - OSC9 G01 - DSC9 K94		
● IND. MARINE ENGINE 4			
★	D9A/ M		
● 3 TRUCK			
★	DS/ DSC11 FOR K422 8/ 9/ 12/ 13 - K432 3 - K402 1/ 3/ 4		
● 4 TRUCK			
★	DSC9 - DC9 01/ 02/ 03/ 04/ 05/ 06 - DSC11		

FLYWHEEL HOUSING SET



	64181	1895479	1849151
● 4 TRUCK			
★	DC16		
● P-G-R-T TRUCK			
★	D16		

SPEED SENSOR



	65503	1375688	
● 4 TRUCK			
★	DSC14 13/15 (TERMINAL MARKED NO.4)		

ALL THE COMPONENTS LISTED IN OUR CATALOGUE ARE NOT ORIGINAL, THOUGH PERFECTLY INTERCHANGEABLE. REFERENCE NUMBERS, EITHER ORIGINAL OR OF A DIFFERENT NATURE, ARE FOR INFORMATION PURPOSES ONLY. WHEN PLACING AN ORDER, PLEASE, ALWAYS USE COSIBO REFERENCE NUMBERS AND DO NOT MENTION THE ORIGINAL REFERENCE NUMBERS OF THE TRUCK MANUFACTURERS IN THE INVOICE TO VEHICLE OWNERS OR TO ANYBODY ELSE. THE CUSTOMER TAKES HIS OWN RESPONSIBILITY IF HE DOES NOT COMPLY WITH WHAT ABOVE.

SPEED SENSOR



- Model
- ★ Application

Code

OEM new

OEM old

65504

1375689

- 4 TRUCK

- ★ DSC14 13/15 (TERMINAL MARKED NO.4)

SENSOR



65458

2247379

2020691
1908536

- IND. MARINE ENGINE 5

- ★

ALL THE COMPONENTS LISTED IN OUR CATALOGUE ARE NOT ORIGINAL, THOUGH PERFECTLY INTERCHANGEABLE. REFERENCE NUMBERS, EITHER ORIGINAL OR OF A DIFFERENT NATURE, ARE FOR INFORMATION PURPOSES ONLY. WHEN PLACING AN ORDER, PLEASE, ALWAYS USE COSIBO REFERENCE NUMBERS AND DO NOT MENTION THE ORIGINAL REFERENCE NUMBERS OF THE TRUCK MANUFACTURERS IN THE INVOICE TO VEHICLE OWNERS OR TO ANYBODY ELSE. THE CUSTOMER TAKES HIS OWN RESPONSIBILITY IF HE DOES NOT COMPLY WITH WHAT ABOVE.

	Code	OEM new	OEM old
RING GEAR	60101	1471237	139625
● Model			
★ Application			
● 3 BUS			
★			
● 4 BUS			
★	DSC9/ DC9 01/ 02/ 03/ 04/ 05/ 06 ENG 6028487 - ENG 8028902 - ENG 6028486 - ENG 8028901 - DC9 19/ 20/ 21 ENG 8103229 - ENG/ MAG 8103230 - K/ L/ N94 - DSC9 - DS19 E01 - DC9 - OSC9 G01 - DSC9 K94		
● F-K-N BUS			
★	D11/ D12 - D9 PDE - D9 XPI - DC9 19/ 20/ 21 - D9 PDE K/ N - D12K		
● IND. MARINE ENGINE 4			
★	D9A/ M		
● IND. MARINE ENGINE 5			
★	SG9 A280 - DC9A EMS ENG 6299926 SSS - 6299927 SSS - ENG 8103229 SLA - ENG 8103220 SLA - DC9A EMS CLARK 15"/17" ENG 8103230 SLA - ENG 6299926 SSS - ENG 6299927 SSS - ENG 8103229 SLA - DC9A EMS SAE 11.5"/14" ENG 6299926 SSS - ENG 6299927 SSS - ENG 8103229 SLA - ENG 8103230 SLA		
● 3 TRUCK			
★	DS/ DSC11 - DTC11 - P93 D9 GA750 - P93/ 113 - D9/ 11 GA850/ 850R		
● 4 TRUCK			
★	DSC9/ DC9 01/ 02/ 03/ 04/ 05/ 06 ENG G 6028487 - ENG G 8028902 - ENG G 6028486 - ENG G 8028901 - DC9 19/ 20/ 21 ENG G 8103229 - ENG G/ MAG 8103230 - DSC11 - DSC12 03/ 05 - DC12 - DT12 - OSC11 G03		
● P-G-R-T TRUCK			
★	D11/ D12 - D9 PDE - D9 XPI - D13		



RING GEAR	60591	1891445	1465410 1487567 1527914 170069
● IND. MARINE ENGINE 4			
★			
● 3 TRUCK			
★			
● 4 TRUCK			
★	DSC14 13/ 15		



		Code	OEM new	OEM old
RING GEAR	● Model	64378	1527913	1487566
	★ Application			
	● 4 BUS			
	★	D11 ENG 6302553 - ENG 8103229 - D12 ENG 6302553 - ENG 8103229 - K114/124		
	● IND. MARINE ENGINE 4			
	★	D112 68M ENG 8712210 SLA - ENG 8712209 SLA - D12M EMS ENG 6514494 SSS - D112 49A/DC12 57A ENG 6514494 SSS - ENG 6514495 SSS - ENG 8712209 SLA - ENG 8712210 SLA - D12M EMS ENG 6514495 SSS - ENG 8712209 SLA - ENG 8712210 SLA - SG9 A280 - DC16A - D16M		
	● 4 TRUCK			
	★	D11 ENG 6302553 - ENG 8103229 - DSC12 01/ 02 ENG 5719204 - ENG 5719205 - DSC12 03/ 05 - DC12 - DT12 - OSC11 G03 - DC16		

		65529	1442300	
RING GEAR	● 4 BUS			
	★			
	● 4 TRUCK			
	★			
	● F-K-N BUS			
	★			
	● P-G-R-T TRUCK			
	★			

ALL THE COMPONENTS LISTED IN OUR CATALOGUE ARE NOT ORIGINAL, THOUGH PERFECTLY INTERCHANGEABLE. REFERENCE NUMBERS, EITHER ORIGINAL OR OF A DIFFERENT NATURE, ARE FOR INFORMATION PURPOSES ONLY. WHEN PLACING AN ORDER, PLEASE, ALWAYS USE COSIBO REFERENCE NUMBERS AND DO NOT MENTION THE ORIGINAL REFERENCE NUMBERS OF THE TRUCK MANUFACTURERS IN THE INVOICE TO VEHICLE OWNERS OR TO ANYBODY ELSE. THE CUSTOMER TAKES HIS OWN RESPONSIBILITY IF HE DOES NOT COMPLY WITH WHAT ABOVE.

	Code	OEM new	OEM old
BEARING	63750	1313606	168248
● Model			
★ Application			
● 3 BUS			
★ G/GS/GR - GR801 - GR801R - DSC11 22/70 EDC - DSC11 - DSC11 21 - K/L 113 - K 93			
● 3 TRUCK			
★ G/GR/GS/GRS - DS/DSC11 - DTC11			
● 4 BUS			
★ DSC9 - DC9 01/02/03/04/05/06/19/20/21 - DS19 E01 - OSC9 G01 - D12 - D11 - K/L/N 94 - K 114/124			
● 4 TRUCK			
★ DSC9 - DC9 01/02/03/04/05/06/19/20/21 - DSC11 - DSC12 01/02/03/05 - DC12 - DT12 - DSC14 13/15 - OSC11 G03 - D11 - DC16			
● F-K-N BUS			
★ D9 PDE - D11 - D12 - F			
● IND. MARINE ENGINE 4			
★ D9 A/M - DC16 A			
● IND. MARINE ENGINE 5			
★ DC9A EMS			
● P-G-R-T TRUCK			
★ D9 PDE - D11 - D12 - D16			



	60102	353843	131120 271488
CRANKSHAFT PINION			
● 3 TRUCK			
★ DS/ DSC11 - DTC11 - DS11 75 - DSC11 21/ 22/ 23/ 35/ 36/ 39/ 70 - DTC11 01/ 02			
● 4 TRUCK			
★ OSC11 G03			
● 3 BUS			
★			
● IND. MARINE ENGINE 4			
★			



ALL THE COMPONENTS LISTED IN OUR CATALOGUE ARE NOT ORIGINAL, THOUGH PERFECTLY INTERCHANGEABLE. REFERENCE NUMBERS, EITHER ORIGINAL OR OF A DIFFERENT NATURE, ARE FOR INFORMATION PURPOSES ONLY. WHEN PLACING AN ORDER, PLEASE, ALWAYS USE COSIBO REFERENCE NUMBERS AND DO NOT MENTION THE ORIGINAL REFERENCE NUMBERS OF THE TRUCK MANUFACTURERS IN THE INVOICE TO VEHICLE OWNERS OR TO ANYBODY ELSE. THE CUSTOMER TAKES HIS OWN RESPONSIBILITY IF HE DOES NOT COMPLY WITH WHAT ABOVE.

OIL SEAL 35X52X10



- Model
- ★ Application

Code

OEM new

OEM old

61109

1122620

- 3 TRUCK

- ★ DSC14 08/09/10/16

- IND. MARINE ENGINE 4

- ★

ALL THE COMPONENTS LISTED IN OUR CATALOGUE ARE NOT ORIGINAL, THOUGH PERFECTLY INTERCHANGEABLE. REFERENCE NUMBERS, EITHER ORIGINAL OR OF A DIFFERENT NATURE, ARE FOR INFORMATION PURPOSES ONLY. WHEN PLACING AN ORDER, PLEASE, ALWAYS USE COSIBO REFERENCE NUMBERS AND DO NOT MENTION THE ORIGINAL REFERENCE NUMBERS OF THE TRUCK MANUFACTURERS IN THE INVOICE TO VEHICLE OWNERS OR TO ANYBODY ELSE. THE CUSTOMER TAKES HIS OWN RESPONSIBILITY IF HE DOES NOT COMPLY WITH WHAT ABOVE.

	Code	OEM new	OEM old
CYLINDER HEAD GASKET	60002	373472	257375 346143
● Model			
★ Application			
● 3 BUS			
★ DS11 34/ 74/ 75/ 78 - DSC11 04/ 08/ 17/ 18/ 21/ 22/ 23/ 24/ 27/ 35/ 36/ 70/ 71/ 81 - DSI11 E01 - OSC11 G01			
● 4 BUS			
★ DSC11 - OSC11 G03			
● 3 TRUCK			
★ DS11 34/ 73/ 75 - DSC11 08/ 10/ 12/ 13/ 16/ 17/ 18/ 21/ 22/ 23/ 30/ 35/ 36/ 39/ 70 - DN11 01 - DTC11 01/ 02			
● 4 TRUCK			
★ DSC11 - OSC11 G03 - DSC11 74/ 75/ 79			

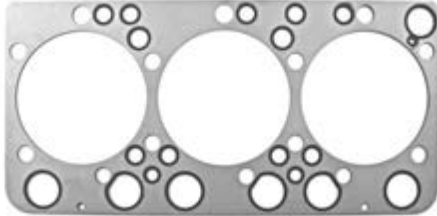

	Code	OEM new	OEM old
CYLINDER HEAD GASKET	60003	1403587	1313459 170274 367569
● IND. MARINE ENGINE 4			
★ D14 A/ M			
● 3 TRUCK			
★ DSC14 03/ 04/ 06/ 08/ 09/ 10/ 16			
● 4 TRUCK			
★ DSC14 13/ 15			

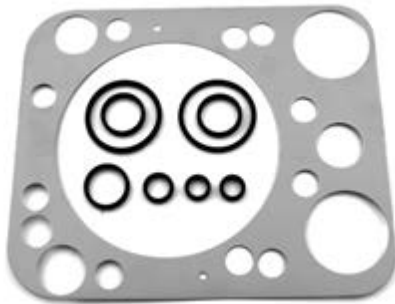

		Code	OEM new	OEM old
CYLINDER HEAD GASKET	● Model	63565	1444941	1377039
	★ Application			
	● 4 BUS			
	★	(DSC12 01/02 - DC11 07 ENG 6150649 SSS - ENG 8021834 SLA) - (DSC12 03/05/ DC12 ENG 6102922 SSS - ENG 6107146 - 6109703 SSS - ENG 3138021 SLA) - (DSC12 03/05 - DC12 ENG 6102923 - 6107145 SSS - ENG 6109704 - 6150649 SSS - ENG 3138022 - 8021834 SLA) - (DC11 01/02/03/04/06 ENG 6102921 SSS - ENG 6104629 - 6105125 SSS - ENG 3138021 SLA) - (DC11 01/02/03/04/06 ENG 6102922 - 6104628 SSS/ENG 6105126 - 6150649 SSS - ENG 3138022 - 8021834 SLA) - (DC11/D12 ENG 6119599 SSS - ENG 8004779 SLA) - (DSC12 01/02 ENG 5740731 SSS - ENG 3125405 SLA) - (DC11 01/02/03/04/06 - DSC12 03/05 - DC12 - DT12 ENG 6119599 SSS - ENG 8004779 SLA) - (DSC12 01/02 - DC11 07 ENG 5740732 - 6119599 SSS - ENG 3125406 - 8004779 SLA)		
	● IND. MARINE ENGINE 4			
	★	(ENG 6150649 - ENG 8021834) - (D12A/ M ENG 6119599 - ENG 8004779)		
	● 4 TRUCK			
	★	(DSC12 01/02 - DC11 07 ENG 6150649 SSS - ENG 8021834 SLA) - (DSC12 03/05/ DC12 ENG 6102922 SSS - ENG 6107146 - 6109703 SSS - ENG 3138021 SLA) - (DSC12 03/05 - DC12 ENG 6102923 - 6107145 SSS - ENG 6109704 - 6150649 SSS - ENG 3138022 - 8021834 SLA) - (DC11 01/02/03/04/06 ENG 6102921 SSS - ENG 6104629 - 6105125 SSS - ENG 3138021 SLA) - (DC11 01/02/03/04/06 ENG 6102922 - 6104628 SSS/ENG 6105126 - 6150649 SSS - ENG 3138022 - 8021834 SLA) - (DC11/D12 ENG 6119599 SSS - ENG 8004779 SLA) - (DSC12 01/02 ENG 5740731 SSS - ENG 3125405 SLA) - (DC11 01/02/03/04/06 - DSC12 03/05 - DC12 - DT12 ENG 6119599 SSS - ENG 8004779 SLA) - (DSC12 01/02 - DC11 07 ENG 5740732 - 6119599 SSS - ENG 3125406 - 8004779 SLA)		

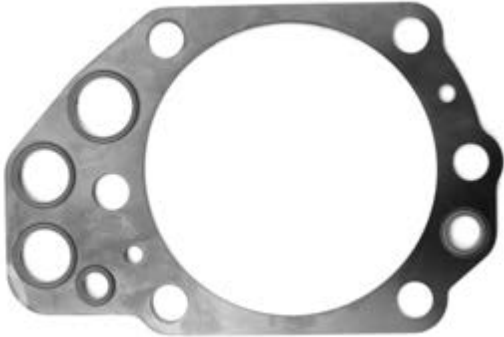
		60970	1403258	387503
CYLINDER HEAD GASKET	● 3 BUS			
	★	DS/DSC9		
	● 3 TRUCK			
	★	DN/DS9 - DSC9 02/07/08/09/10		
	● 4 BUS			
	★	DSC9 - DS19 E01 - DC9 01/02/03/04/05/06 - OSC9 G01		
	● 4 TRUCK			
	★	DSC9 - DC9 01/02/03/04/05/06 - DS19 E01 - OSC9 G01		
	● IND. MARINE ENGINE 4			
	★	SG9 A280 - D/DS9 90/92A - DC/DSC9 46/47/49/50/51A - DI/DS19 48/51/53A - DC9 51/53/54/55A - DI9 56A - D9/DSC9 A/M		

ALL THE COMPONENTS LISTED IN OUR CATALOGUE ARE NOT ORIGINAL, THOUGH PERFECTLY INTERCHANGEABLE. REFERENCE NUMBERS, EITHER ORIGINAL OR OF A DIFFERENT NATURE, ARE FOR INFORMATION PURPOSES ONLY. WHEN PLACING AN ORDER, PLEASE, ALWAYS USE COSIBO REFERENCE NUMBERS AND DO NOT MENTION THE ORIGINAL REFERENCE NUMBERS OF THE TRUCK MANUFACTURERS IN THE INVOICE TO VEHICLE OWNERS OR TO ANYBODY ELSE. THE CUSTOMER TAKES HIS OWN RESPONSIBILITY IF HE DOES NOT COMPLY WITH WHAT ABOVE.

CYLINDER HEAD GASKET



	Code	OEM new	OEM old
● Model ★ Application	63933	1468555	
● 3 TRUCK			
★	DSC12 01/02 - DC11 07 - DC12 03/05 - DC12 - DC11 01/02/03/04/06 - DC9 19/20/21 - DSC12 05 - DC12 01/02/09/16 - DC11 - D12 - DSC12 05 - DT12 - DT12 02/08 L01 - DC12 03 - DT12 02/08 L02 - DT12 10 - DC16		
● 4 BUS			
★	(DSC12 01/02 - DC11 07 ENG 6150649 SSS - ENG 8021834 SLA) - (DC12 03/05 - DC12 ENG 6102923 - 6107145 SSS - ENG 6109704 - 6150649 SSS - ENG 3138022 - 8021834 SLA) - (DC11 01/02/03/04/06 ENG 6102922 - 6104628 SSS - ENG 6105126 - 6150649 SSS - ENG 3138022 - 8021834 SLA) - (DSC12 01/02 - DC11 07 ENG 6150650 SSS - ENG 8021835 SLA) - DC9 19/20/21 - (DC11 01/02/03/04/06 ENG 6150650 SSS - ENG 8021835 SLA) - (DSC12 05 - DC12 01/02/09/16 ENG 6150650 SSS - ENG 8021835 SLA) - (DC11 - D12 ENG 6119600 SSS - ENG 8004780 SLA) - DC9 19/20/21 - (DSC12 01/02 - DC11 07 ENG 6119600 SSS - ENG 8004780 SLA) - DC11 01/02/03/04/06 - DSC12 05 - DC12 - DT12 ENG 6119600 SSS - ENG 8004780 SLA)		
● P-G-R-T TRUCK			
★	PDE - HPI - D9 - D11 - D12 - D16		
● IND. MARINE ENGINE 4			
★	D12M EMS - DI12 69M - SGI12A - DC12 50A/54A/57A - DC16A - D12A EMS - DI16 48A/53A - (D16M ENG 6507872 - 6510537 SSS - ENG 6510538 - 6513510 SSS - ENG 1039758 SSS) - D12A/M - (D12M EMS ENG 6515877 SSS - ENG 8710546 SLA - ENG 6515878 SSS - ENG 8710547 SLA) - (DSC12 03/05 - DC12 ENG 6150649 SSS - ENG 8021834 SLA)		
● IND. MARINE ENGINE 5			
★	SG9 A280 - DC9 EMS - DC9A EMS		
● F-K-N BUS			
★	PDE - HPI - D9 - D11 - D12 - D16		

CYLINDER HEAD GASKET SET

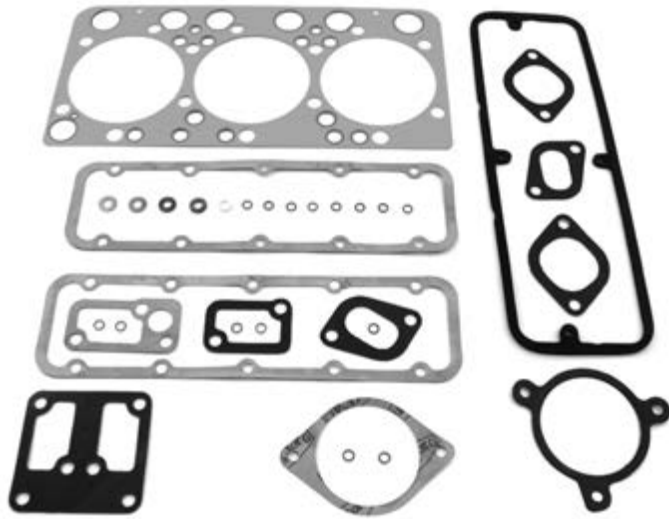

	Code	OEM new	OEM old
● Model	60573	551456	551513
★ Application			

● 3 TRUCK
★ ENG 5307760 - ENG 4070104 - ENG 3075634 SSB

CYLINDER HEAD GASKET SET

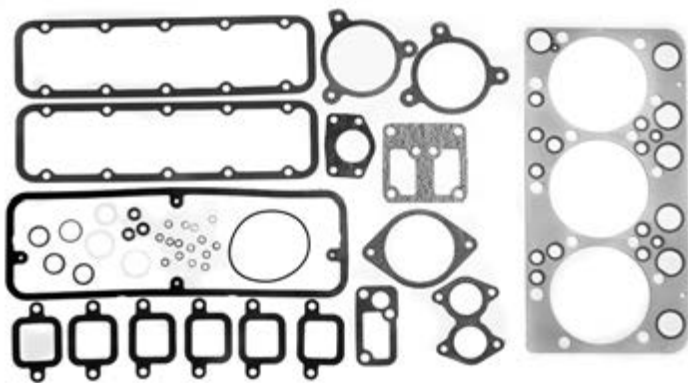

	61560	551512	551500
--	--------------	--------	--------

● 3 BUS
★

● 3 TRUCK
★ ENG 5307761 - ENG 4070105 - ENG 3075635 SSB

CYLINDER HEAD GASKET SET



	60587	551469	550214
--	--------------	--------	--------

● 3 TRUCK
★ DSC14

● 4 TRUCK
★ DSC14 13/ 15

ALL THE COMPONENTS LISTED IN OUR CATALOGUE ARE NOT ORIGINAL, THOUGH PERFECTLY INTERCHANGEABLE. REFERENCE NUMBERS, EITHER ORIGINAL OR OF A DIFFERENT NATURE, ARE FOR INFORMATION PURPOSES ONLY. WHEN PLACING AN ORDER, PLEASE, ALWAYS USE COSIBO REFERENCE NUMBERS AND DO NOT MENTION THE ORIGINAL REFERENCE NUMBERS OF THE TRUCK MANUFACTURERS IN THE INVOICE TO VEHICLE OWNERS OR TO ANYBODY ELSE. THE CUSTOMER TAKES HIS OWN RESPONSIBILITY IF HE DOES NOT COMPLY WITH WHAT ABOVE.

	Code	OEM new	OEM old
CYLINDER HEAD GASKET SET	60972	551484	
<ul style="list-style-type: none"> ● Model ★ Application 			
<ul style="list-style-type: none"> ● 3 TRUCK ★ DS9 - DSC9 			
<ul style="list-style-type: none"> ● 3 BUS ★ DS9 - DSC9 			

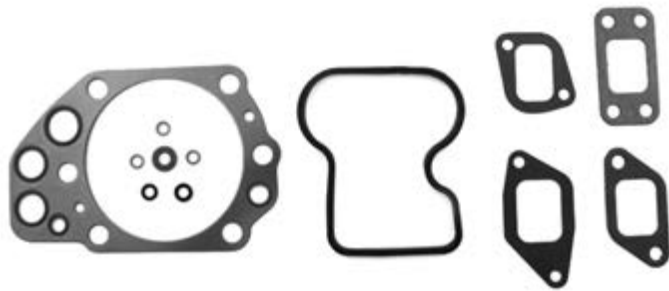

CYLINDER HEAD GASKET SET	63279	551525	
<ul style="list-style-type: none"> ● 4 TRUCK ★ DSC11 74/75/79 - OSC11 G03 - DSC11 			

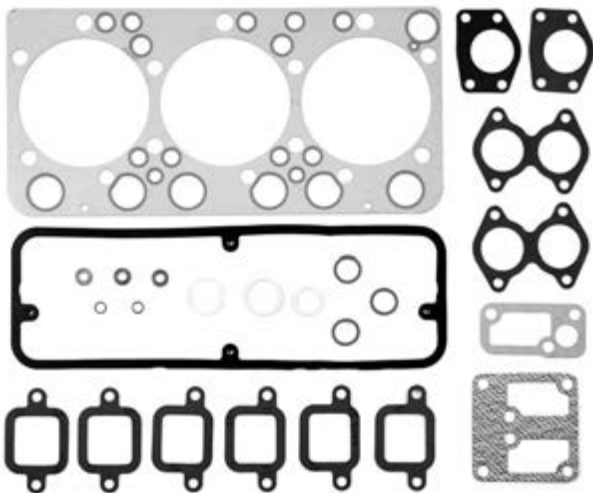

CYLINDER HEAD GASKET SET	63280	551350	
<ul style="list-style-type: none"> ● 4 TRUCK ★ (DSC12 01/ 02 - DC11 07 ENG 6150649 - ENG 8021834) - (DSC12 01/ 02 ENG 5719204) - (DSC12 01/ 02/ DC1107 ENG 5719205) - (DSC12 01/ 02 ENG 574073 - ENG3125405) - DSC12 01/ 02 			
<ul style="list-style-type: none"> ● 4 BUS ★ (DSC12 01/ 02 - DC11 07 ENG 6150649 - ENG 8021834) - (DSC12 01/ 02 ENG 5719204) - (DSC12 01/ 02/ DC1107 ENG 5719205) - (DSC12 01/ 02 ENG 5740731 - ENG3125405) 			

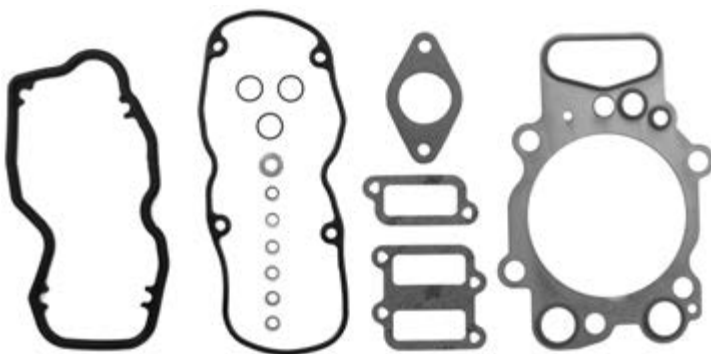

ALL THE COMPONENTS LISTED IN OUR CATALOGUE ARE NOT ORIGINAL, THOUGH PERFECTLY INTERCHANGEABLE. REFERENCE NUMBERS, EITHER ORIGINAL OR OF A DIFFERENT NATURE, ARE FOR INFORMATION PURPOSES ONLY. WHEN PLACING AN ORDER, PLEASE, ALWAYS USE COSIBO REFERENCE NUMBERS AND DO NOT MENTION THE ORIGINAL REFERENCE NUMBERS OF THE TRUCK MANUFACTURERS IN THE INVOICE TO VEHICLE OWNERS OR TO ANYBODY ELSE. THE CUSTOMER TAKES HIS OWN RESPONSIBILITY IF HE DOES NOT COMPLY WITH WHAT ABOVE.

CYLINDER HEAD GASKET SET



● Model

★ Application

Code

OEM new

OEM old

63281

551363

● 4 TRUCK

★

(DSC12 01/02 - DC11 07 EN 6150649 SSS - EN 8021834 SLA) - (DSC12 03/05 - DC12 EN 6102922 SSS EN 6107146 - 6109703 SSS EN 3138021 SLA) - (DSC12 03/05 - DC12 EN 6102923 - 6107145 SSS EN 6109704 - 6150649 SSS - EN 3138022 - 8021834 SLA) - (DSC12 03/05 EN 5731918 SSS - EN 5731798 SNL - EN 5731559 SAN - EN 3123646 SLA) - (DSC12 03/05 - DC12 - DT12 EN 5731919 SSS - EN 5731799 SNL - EN 5731560 SAN - EN 3123647 SLA) - (DC11 01/02/03/04/06 EN 6102921 SSS - EN 6104629 - 6105125 SSS - EN 3138021 SLA) - (DC11 01/02/03/04/06 EN 6102922 - 6104628 SSS - EN 6105126 - 6150649 SSS - EN 3138022 - 8021834 SLA) - (DC11 01/02/03/04/06 - DSC12 03/05 - DC12 - DT12 EN 6119599 SSS - EN 8004779 SLA) - (DSC12 01/02 - DC11 07 EN 5740732 - 6119599 SSS - EN 3125406 - 8004779 SLA)

● 4 BUS

★

(DSC12 01/02 - DC11 07 EN 6150649 SSS - EN 8021834 SLA) - (DSC12 03/05 - DC12 EN 6102922 SSS EN 6107146 - 6109703 SSS EN 3138021 SLA) - (DSC12 03/05 - DC12 EN 6102923 - 6107145 SSS EN 6109704 - 6150649 SSS - EN 3138022 - 8021834 SLA) - (DSC12 03/05 EN 5731918 SSS - EN 5731798 SNL - EN 5731559 SAN - EN 3123646 SLA) - (DSC12 03/05 - DC12 - DT12 EN 5731919 SSS - EN 5731799 SNL - EN 5731560 SAN - EN 3123647 SLA) - (DC11 01/02/03/04/06 EN 6102921 SSS - EN 6104629 - 6105125 SSS - EN 3138021 SLA) - (DC11 01/02/03/04/06 EN 6102922 - 6104628 SSS - EN 6105126 - 6150649 SSS - EN 3138022 - 8021834 SLA) - (DC11 01/02/03/04/06 - DSC12 03/05 - DC12 - DT12 EN 6119599 SSS - EN 8004779 SLA) - (DSC12 01/02 - DC11 07 EN 5740732 - 6119599 SSS - EN 3125406 - 8004779 SLA) - DC11/D12

● IND. MARINE ENGINE 4

★

D12M EMS - DI12 69M - DC12 50/ 54/ 57A - D12A/ M

CYLINDER HEAD GASKET SET

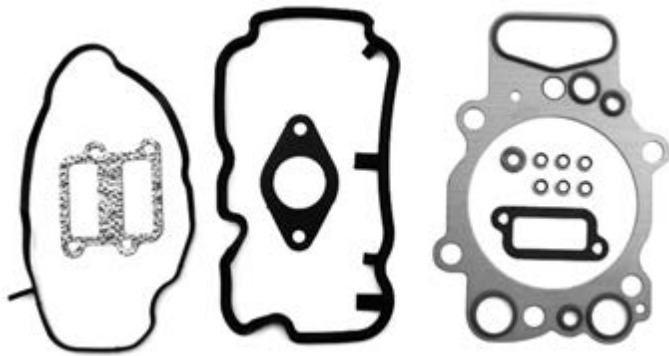

	Code	OEM new	OEM old
● Model	63931	550469	
★ Application			
● 4 TRUCK			
★	(DSC12 03/05 - DC12 ENG 6102923 - 6107145 SSS - ENG 6109704 - 6150649 SSS - ENG 3138022 - 8021834 SLA) - (DSC12 03/05/DC12/DT12 ENG 5731919 SSS - ENG 5731799 SNL - ENG 5731560 SAN - ENG 3123647 SLA) - (DC11 01/02/03/04/06 ENG 6102922 - 6104628 SSS - ENG 6105126 - 6150649 SSS - ENG 3138022 - 8021834 SLA) - (DC11 01/02/03/04/06 ENG 6150650 SSS - ENG 8021835 SLA) - (DSC12 05/DC12 01/02/09/16 ENG 6150650 SSS - ENG 8021835 SLA) - (DC11 01/02/03/04/06 - DCS12 05 - DC12 - DT12 ENG 6119600 SSS - ENG 8004780 SLA) - (DT12 02/08 L01 ENG 6150649 - 6150650 SSS) - (DC12 03 ENG 6214000 - 6214001 SSS) - DT12 02/08 L02 - DT12 10 - (DC16 ENG 1018724 SSS)		
● 4 BUS			
★	(DSC12 03/05 - DC12 ENG 6102923 - 6107145 SSS - ENG 6109704 - 6150649 SSS - ENG 3138022 - 8021834 SLA) - (DSC12 03/05/DC12/DT12 ENG 5731919 SSS - ENG 5731799 SNL - ENG 5731560 SAN - ENG 3123647 SLA) - (DC11 01/02/03/04/06 ENG 6102922 - 6104628 SSS - ENG 6105126 - 6150649 SSS - ENG 3138022 - 8021834 SLA) - (DC11 01/02/03/04/06 ENG 6150650 SSS - ENG 8021835 SLA) - (DSC12 05/DC12 01/02/09/16 ENG 6150650 SSS - ENG 8021835 SLA) - (DC11 01/02/03/04/06 - DCS12 05 - DC12 - DT12 ENG 6119600 SSS - ENG 8004780 SLA)		
● IND. MARINE ENGINE 4			
★	(DC16A ENG 1018724 SSS) - (DC16A ENG 6500001 - 6513503 SSS) - D12A EMS - D116 48A/53A - (DC16A ENG 1018690 - 1047797 SSS) - (DC16A ENG 1047798 - 1059136 SSS) - (DCS16 ENG 1059137 - 1059142 SSS) - (DC16A ENG 1059143 - 1059238 SSS) - (DC16A ENG 1059239 SSS) - (DC16A ENG 1061165 SSS) - (D12M EMS ENG 6515877 SSS - ENG 8710546 SLA) - D12A EMS - (D16M ENG 6500001 - 6507871 SSS) - (D16M ENG 6507872 - 6510537 SSS) - (D116 48A/53A		

CYLINDER HEAD GASKET SET

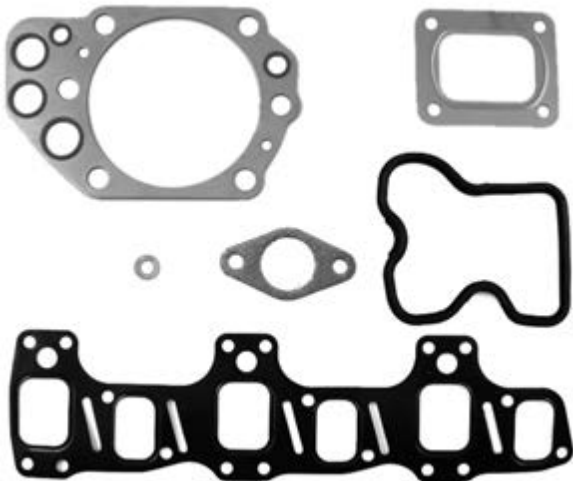

	Code	OEM new	OEM old
	64274	551573	
● 4 TRUCK			
★	DC9 01/ 02/ 03/ 04/ 05/ 06		
● 4 BUS			
★	DC9 01/ 02/ 03/ 04/ 05/ 06		

ALL THE COMPONENTS LISTED IN OUR CATALOGUE ARE NOT ORIGINAL, THOUGH PERFECTLY INTERCHANGEABLE. REFERENCE NUMBERS, EITHER ORIGINAL OR OF A DIFFERENT NATURE, ARE FOR INFORMATION PURPOSES ONLY. WHEN PLACING AN ORDER, PLEASE, ALWAYS USE COSIBO REFERENCE NUMBERS AND DO NOT MENTION THE ORIGINAL REFERENCE NUMBERS OF THE TRUCK MANUFACTURERS IN THE INVOICE TO VEHICLE OWNERS OR TO ANYBODY ELSE. THE CUSTOMER TAKES HIS OWN RESPONSIBILITY IF HE DOES NOT COMPLY WITH WHAT ABOVE.

CYLINDER HEAD GASKET SET

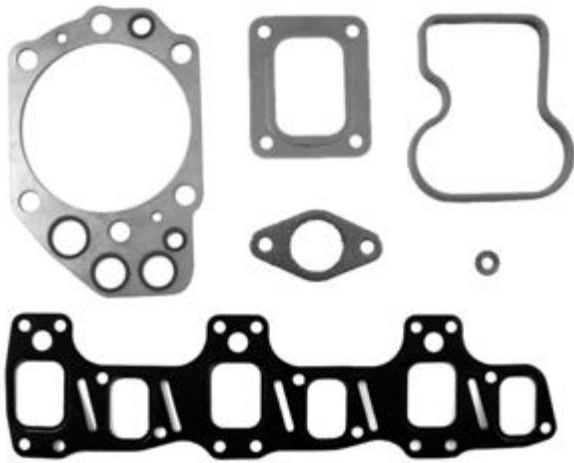

	Code	OEM new	OEM old
● Model ★ Application	64275	551570	550270
● 4 TRUCK			
★ DSC9 - DC9 01/ 02/ 03/ 04/ 05/ 06 - OSC9 - DSI9			
● 4 BUS			
★ DSC9 - DC9 01/ 02/ 03/ 04/ 05/ 06 - OSC9 - DSI9 - DSC9 F94 - K/ L/ N94 - DSI9 E01 N94			
● IND. MARINE ENGINE 4			
★ D/ DS9 90/ 92A - DC/ DSC9 46/ 47/ 49/ 50/ 51A - DI/ DSI9 48/ 41/ 53A - DC9 51/ 53/ 54/ 55A - DI9 56A - DC9 M - D9 A/ M - SG9 A280			

CYLINDER HEAD GASKET SET

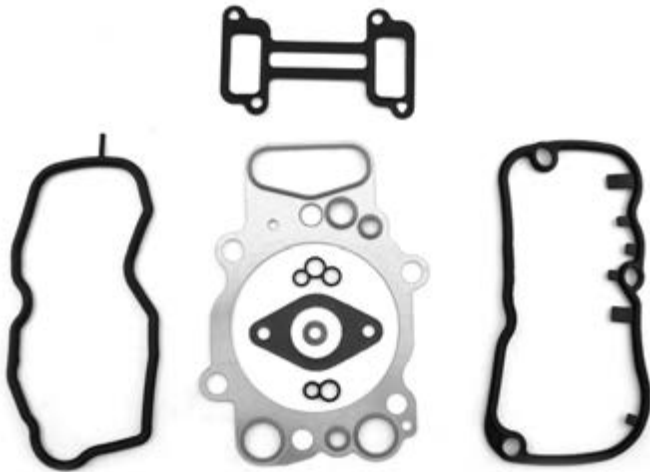

	64306	1725112	
● 4 TRUCK			
★ DC9 19/ 20/ 21 - DC16			
● P-G-R-T TRUCK			
★ PDE HPI - D11 - D12 - D9 PDE - D9 - D16			
● 4 BUS			
★ DC9 19/ 20/ 21			
● IND. MARINE ENGINE 4			
★ SG12A - DC16A - D12M EMS - D16M			
● IND. MARINE ENGINE 5			
★ SG9 A280 - DC9A EMS			
● F-K-N BUS			
★ PDE HPI - D11 - D12 - D9 PDE - D9 - D16			

ALL THE COMPONENTS LISTED IN OUR CATALOGUE ARE NOT ORIGINAL, THOUGH PERFECTLY INTERCHANGEABLE. REFERENCE NUMBERS, EITHER ORIGINAL OR OF A DIFFERENT NATURE, ARE FOR INFORMATION PURPOSES ONLY. WHEN PLACING AN ORDER, PLEASE, ALWAYS USE COSIBO REFERENCE NUMBERS AND DO NOT MENTION THE ORIGINAL REFERENCE NUMBERS OF THE TRUCK MANUFACTURERS IN THE INVOICE TO VEHICLE OWNERS OR TO ANYBODY ELSE. THE CUSTOMER TAKES HIS OWN RESPONSIBILITY IF HE DOES NOT COMPLY WITH WHAT ABOVE.

CYLINDER HEAD GASKET SET

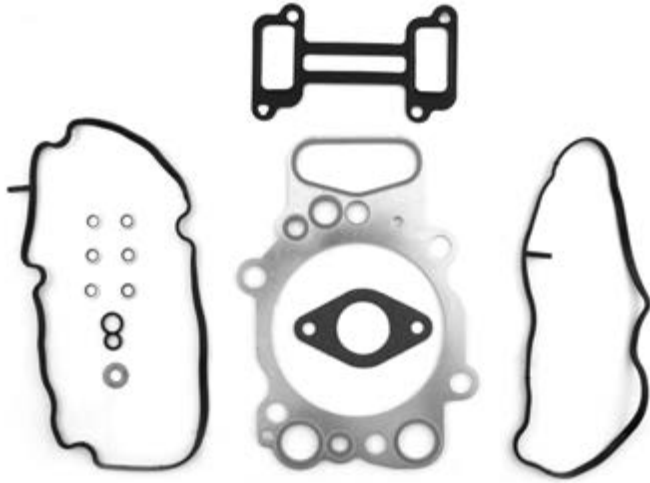

- Model
- ★ Application

Code

OEM new

OEM old

65340

1765974

- 4 TRUCK

- ★ (DSC12 01/ 02 - DC11 07 ENG 6150649 - ENG 8021834) - (DSC12 01/ 02 - DC11 07 ENG 6150650 - ENG 8021835) - (DSC12 01/ 02 - DC11 07 ENG 5719205) - (DSC12 01/ 02 - DC11 07 ENG 6119600 - ENG 8004780)

- 4 BUS

- ★ (DSC12 01/ 02 - DC11 07 ENG 6150649 - ENG 8021834) - (DSC12 01/ 02 - DC11 07 ENG 6150650 - ENG 8021835) - (DSC12 01/ 02 - DC11 07 ENG 5719205) - (DSC12 01/ 02 - DC11 07 ENG 6119600 - ENG 8004780)

- IND. MARINE ENGINE 4

- ★ D12A/ M AFTER YEAR 2000

ALL THE COMPONENTS LISTED IN OUR CATALOGUE ARE NOT ORIGINAL, THOUGH PERFECTLY INTERCHANGEABLE. REFERENCE NUMBERS, EITHER ORIGINAL OR OF A DIFFERENT NATURE, ARE FOR INFORMATION PURPOSES ONLY. WHEN PLACING AN ORDER, PLEASE, ALWAYS USE COSIBO REFERENCE NUMBERS AND DO NOT MENTION THE ORIGINAL REFERENCE NUMBERS OF THE TRUCK MANUFACTURERS IN THE INVOICE TO VEHICLE OWNERS OR TO ANYBODY ELSE. THE CUSTOMER TAKES HIS OWN RESPONSIBILITY IF HE DOES NOT COMPLY WITH WHAT ABOVE.

	Code	OEM new	OEM old
ENGINE GASKET SET	60362	551370	
<ul style="list-style-type: none"> ● Model ★ Application 			
<ul style="list-style-type: none"> ● 4 TRUCK ★ DSC14 13/ 15 			



ENGINE GASKET SET	60575	551516	551457 551459
<ul style="list-style-type: none"> ● 3 BUS ★ K 113 ENG DS1173B01 - DSC1113B01 - DSC1116B01 			
<ul style="list-style-type: none"> ● 3 TRUCK ★ CH 5307760 CH 3075634 CH 4070104 			



ENGINE GASKET SET	64749	551520	551505
<ul style="list-style-type: none"> ● 3 BUS ★ 			



ENGINE GASKET SET	60576	551470	
<ul style="list-style-type: none"> ● 3 TRUCK ★ 			



ALL THE COMPONENTS LISTED IN OUR CATALOGUE ARE NOT ORIGINAL, THOUGH PERFECTLY INTERCHANGEABLE. REFERENCE NUMBERS, EITHER ORIGINAL OR OF A DIFFERENT NATURE, ARE FOR INFORMATION PURPOSES ONLY. WHEN PLACING AN ORDER, PLEASE, ALWAYS USE COSIBO REFERENCE NUMBERS AND DO NOT MENTION THE ORIGINAL REFERENCE NUMBERS OF THE TRUCK MANUFACTURERS IN THE INVOICE TO VEHICLE OWNERS OR TO ANYBODY ELSE. THE CUSTOMER TAKES HIS OWN RESPONSIBILITY IF HE DOES NOT COMPLY WITH WHAT ABOVE.

	Code	OEM new	OEM old
ENGINE GASKET SET	60971	551449	
<ul style="list-style-type: none"> ● Model ★ Application 			
<ul style="list-style-type: none"> ● 3 BUS 			
<ul style="list-style-type: none"> ★ 			
<ul style="list-style-type: none"> ● 3 TRUCK 			
<ul style="list-style-type: none"> ★ 			



ENGINE GASKET SET	63558	551356	
<ul style="list-style-type: none"> ● 4 BUS 			
<ul style="list-style-type: none"> ★ DSC12 01/ 02/ 03/ 05 - DC11 01/ 02/ 03/ 04/ 06/ 07 - DC12 - DT12 - D12 			
<ul style="list-style-type: none"> ● 4 TRUCK 			
<ul style="list-style-type: none"> ★ DSC12 01/ 02/ 03/ 05 - DC11 01/ 02/ 03/ 04/ 06/ 07 - DC12 - DT12 - D12 - D12 CP/ CR/ CT - DC11/ D12 ED120 22/ 37 			



ENGINE GASKET SET	64273	551560	551526
<ul style="list-style-type: none"> ● 4 BUS 			
<ul style="list-style-type: none"> ★ DSC9 - DC9 01/ 02/ 03/ 04/ 05/ 06 - DSI9 E01 - OSC9 G01 - SC9 F94 - K/ L/ N94 - DSI9 E01 N94 - D9 - K94 			
<ul style="list-style-type: none"> ● IND. MARINE ENGINE 4 			
<ul style="list-style-type: none"> ★ SG9 A280 			
<ul style="list-style-type: none"> ● 4 TRUCK 			
<ul style="list-style-type: none"> ★ DSC9 - DC9 01/ 02/ 03/ 04/ 05/ 06 - DSI9 E01 - OSC9 G01 - CP 19F FRONTLINE 			



ENGINE GASKET SET	64750	1849922	
<ul style="list-style-type: none"> ● IND. MARINE ENGINE 4 			
<ul style="list-style-type: none"> ★ D116 48A/53A 			



ALL THE COMPONENTS LISTED IN OUR CATALOGUE ARE NOT ORIGINAL, THOUGH PERFECTLY INTERCHANGEABLE. REFERENCE NUMBERS, EITHER ORIGINAL OR OF A DIFFERENT NATURE, ARE FOR INFORMATION PURPOSES ONLY. WHEN PLACING AN ORDER, PLEASE, ALWAYS USE COSIBO REFERENCE NUMBERS AND DO NOT MENTION THE ORIGINAL REFERENCE NUMBERS OF THE TRUCK MANUFACTURERS IN THE INVOICE TO VEHICLE OWNERS OR TO ANYBODY ELSE. THE CUSTOMER TAKES HIS OWN RESPONSIBILITY IF HE DOES NOT COMPLY WITH WHAT ABOVE.

ENGINE GASKET SET



- Model
- ★ Application
- IND. MARINE ENGINE 4
- ★ DI16 40/41A

Code	OEM new	OEM old
64751	1488658	

ENGINE GASKET SET



- IND. MARINE ENGINE 4
- ★ DC16 - DC16 A - DC16 A - SAE B
- 4 TRUCK
- ★ DC16

65337	551387	
-------	--------	--

ENGINE GASKET SET



- 4 BUS
- ★ DSC11 - OSC11 G03
- 4 TRUCK
- ★ DSC11 - OSC11 G03 - DSC11 74/ 75/ 79 - DSC11/ OSC11 CP/ CR - DSC11 CT

65338	551528	
-------	--------	--

ENGINE GASKET SET



- 4 BUS
- ★ DSC12 01/ 02/ 03/ 05 - DC11 01/ 02/ 03/ 04/ 06/ 07 - DC12 - DT12 - DC12 01/ 02/ 09/ 16 - D12 - DC11
- 4 TRUCK
- ★ DSC12 01/ 02/ 03/ 05 - DC11 01/ 02/ 03/ 04/ 06/ 07 - DC12 - DT12 - DC12 01/ 02/ 09/ 16 - D12 - DC11 - DT12 02/ 08 L01/ L02 - DC12 03 - DT12 10 - DC11 CP/ CR - DC11/ D12 CP/ CR

65339	551386	
-------	--------	--

ALL THE COMPONENTS LISTED IN OUR CATALOGUE ARE NOT ORIGINAL, THOUGH PERFECTLY INTERCHANGEABLE. REFERENCE NUMBERS, EITHER ORIGINAL OR OF A DIFFERENT NATURE, ARE FOR INFORMATION PURPOSES ONLY. WHEN PLACING AN ORDER, PLEASE, ALWAYS USE COSIBO REFERENCE NUMBERS AND DO NOT MENTION THE ORIGINAL REFERENCE NUMBERS OF THE TRUCK MANUFACTURERS IN THE INVOICE TO VEHICLE OWNERS OR TO ANYBODY ELSE. THE CUSTOMER TAKES HIS OWN RESPONSIBILITY IF HE DOES NOT COMPLY WITH WHAT ABOVE.

	Code	OEM new	OEM old
O-RING DIAM.26,2X3	60635	197800	392661
● Model			
★ Application			
● 3 BUS			
★ DSC11 04/08/27 - N113			
● 3 TRUCK			
★			
● 4 BUS			
★ K94 DC9 19/20/21 - DC9 01/02/03/04/05/06 - DSC9 - K/L/N94 - DSI9 E01 - OSC9 G01 - DSC11 - OSC11 G03			
● 4 TRUCK			
★ DC9 01/02/03/04/05/06/19/20/21 - DSC11 - OSC11 G03 - DSC9 - DSI9 E01 - OSC9 G01			
● F-K-N BUS			
★ D9 PDE - D9 XPI			
● IND. MARINE ENGINE 5			
★ DC9A EMS - SG9 A280			
● IND. MARINE ENGINE 4			
★ D9M - DC9 51/53/54/55A - DS/DSC14 - DSI14 68/70/72/73/75/74/77/78/79 M40/41 - DSC9/DC9 A/M			
● P-G-R-T TRUCK			
★ D9 PDE - D9 XPI			



		Code	OEM new	OEM old
GASKET	● Model	62490	1368061	
	★ Application			
	● 4 BUS			
	★	DC11/D12 ENG 6119599 SSS - ENG 8004779 SLA - ENG 6119600 SSS - ENG 8004780 SLA - DC9 19/20/21 ENG 6281664 SSS - ENG 8066509 SLA - ENG 6281665 SSS - ENG 8066510 SLA - DC11 01/02/03/04/06 - DSC12 03/05 - DC12 - DT12 ENG 6119599 SSS - ENG 8004779 SLA - ENG 6119600 SSS - ENG 8004780 SLA - DSC12 01/02 - DC11 07 ENG 5740732 - 6119599 SSS - ENG 3125406 - 8004779 SLA - ENG 6119600 SSS - ENG 8004780 SLA - ENG 6173205 SSS - ENG 8016535 SLA - DSC12 03/05 ENG 6173205 SSS - ENG 8016535 SLA - DSC12 02 - D11/D12 PDE ENG 6217072 - 6290341 SSS - ENG 8031704 - 8066511 SLA - ENG 6290342 SSS - ENG 8066512 SLA - K114/124 ENG 6173206 - 6217071 SSS - ENG 8016536 - 8031704 SLA - DC11 01/02/03/04/06 ENG 6173205 SSS - ENG 8016535 SLA		
	● F-K-N BUS			
	★	D9 - D11 - D12 - 16 - D11/D12 PDE - F.D9 - K.D9 - N.D9 - N.D9.UD		
	● IND. MARINE ENGINE 4			
	★	D12A/M ENG 6119599 SSS - ENG 8004779 SLA - D12M EMS ENG 6515877 SSS - ENG 8710546 SLA - ENG 6515878 SSS - ENG 8710547 SLA - ENG 6511717 SSS - ENG 6511718 SSS - D12A EMS ENG 6509333 - 6514807 SSS - ENG 8709241 SLA - ENG 6514808 SSS - ENG 8709242 SLA - ENG 6509332 SSS - DC16 - DC16A ENG 6500001 - 6513503 SSS - ENG 1018690 - 1018724 SSS - ENG 1018725 SSS - D16M ENG 6500001 - 6507871 SSS - ENG 6507872 - 6510537 SSS - ENG 6510538 - 6513510 SSS - ENG 1039758 SSS - DI16 40/41A/45M/48A/53A - DI12 40/41/42/43/44/45M/46A/49A/50/51/52A - DC12 40/41/42/46/47/48A 57A - DI12 68M STD RH/LH - DSC12 40 - 41/A - DSI12 40A - D16A ENG 6500001 - 6513503 SSS - ENG 1012035 SSS - ENG 1012036 SSS -		
	● IND. MARINE ENGINE 5			
	★	DC9A EMS		
● 4 TRUCK				
★	DC11/D12 ENG 6119599 SSS - ENG 8004779 SLA - ENG 6119600 SSS - ENG 8004780 SLA - ENG 6242516 SSS - ENG 8044475 SLA - DC9 19/20/21 ENG 6280449 SSS - ENG 8066948 SLA - ENG 6280450 SSS - ENG 8066949 SLA - DC11 01/02/03/04/06 - DSC12 03/05 - DC12 - DT12 ENG 6119599 SSS - ENG 8004779 SLA - ENG 6119600 SSS - ENG 8004780 SLA - DSC12 01/02 - DC11 07 ENG 5740732 - 6119599 SSS - ENG 3125406 - 8004779 SLA - ENG 6119600 SSS - ENG 8004780 SLA - ENG 6173205 SSS - ENG 8016535 SLA - DSC12 03/05 ENG 6173205 SSS - ENG 8016535 SLA - ENG 6173206 - 6217071 SSS - ENG 8016536 - 8031703 SLA - DC16 ENG 1018724 SSS - ENG 1018725 SSS - DSC12 01 - DSC12 02 ENG 5707810 SSS - DC16 01/02 ENG 1012035 SSS - ENG 1012036 SSS - D11/D12 PDE ENG 6217072 - 6242515 SSS - ENG 8031704 - 8044474 SLA - DC12 01/02 ENG 6173206 - 6217071 SSS - ENG 8016536 - 8031703 SLA - DC11 01/02/03/04/06 ENG 6173206 - 6217071 SSS - ENG 8016536 - 8031703 SLA - ENG 6173205 SSS - ENG 8016535 SLA			
● P-G-R-T TRUCK				
★	D9 - D11 - D12 - 16 - DC9 11/ 12/ 13 PDE - DC9 16/ 17/ 18 PDE - DC 1108 L01 - DC 1109 - 4X4/ 6X6 - DC11 08 L02 - DC12 06/ 17 PDE - DC16 05/ 06/ 08/ 09/ 17/ 18/ 19 - D16			



		Code	OEM new	OEM old
BUSHING	● Model	63385	131115	
	★ Application			
	● 3 BUS			
	★			
	● 3 TRUCK			
	★ DS11 34/73/75 - DSC11 08/10/12/13/16/17/18/21/22/23/30/35/36/39/70 - DN11 01 - DTC11 01/02			
● 4 TRUCK				
★ DSC11 - OSC11 G03				
● IND. MARINE ENGINE 4				
★				



		63386	157274	
BUSHING	● 3 BUS			
	★			
	● 3 TRUCK			
	★ DS11 34/73/75 - DSC11 08/10/12/13/16/17/18/21/22/23/30/35/36/39/70 - DN11 01 - DTC11 01/02			
	● 4 TRUCK			
	★ DSC11 - OSC11 G03			
● IND. MARINE ENGINE 4				
★				



		65543	1414341	
SLEEVE	● 4 BUS			
	★ DC11 07 - DSC12 01/02			
	● 4 TRUCK			
	★ DC11 07 - DSC12 01/02			



ALL THE COMPONENTS LISTED IN OUR CATALOGUE ARE NOT ORIGINAL, THOUGH PERFECTLY INTERCHANGEABLE. REFERENCE NUMBERS, EITHER ORIGINAL OR OF A DIFFERENT NATURE, ARE FOR INFORMATION PURPOSES ONLY. WHEN PLACING AN ORDER, PLEASE, ALWAYS USE COSIBO REFERENCE NUMBERS AND DO NOT MENTION THE ORIGINAL REFERENCE NUMBERS OF THE TRUCK MANUFACTURERS IN THE INVOICE TO VEHICLE OWNERS OR TO ANYBODY ELSE. THE CUSTOMER TAKES HIS OWN RESPONSIBILITY IF HE DOES NOT COMPLY WITH WHAT ABOVE.

		Code	OEM new	OEM old
BUSHING	● Model ★ Application	63387	131455	
	● 3 BUS			
	★			
	● IND. MARINE ENGINE 4			
	★			
	● 3 TRUCK			
★	DS11 34/73/75 - DSC11 08/10/12/13/16/17/18/21/22/23/30/35/36/39/70 - DN11 01 - DTC11 01/02			
● 4 TRUCK				
★	DSC11 - OSC11 G03			



		63372	1304292	
CONN. ROD BUSHING	● 3 BUS			
	★			
	● IND. MARINE ENGINE 4			
	★			
	● 3 TRUCK			
	★	DS/ DSC11 - DTC11		
● 4 TRUCK				
★	DS11 - DSC14 13/ 15 - OSC11 G03			



		63416	1320973	
CONN. ROD BUSHING	● 3 BUS			
	★			
	● 4 BUS			
	★	DSC9 - DC9 01/ 02/ 03/ 04/ 05/ 06 - K/ L/ N94 - DSC9 - DS19 E01 - DC9 - OSC9 G01 - DSC9 K94		
	● IND. MARINE ENGINE 4			
	★	SG9 A280 - D9A/ M		
● 3 TRUCK				
★				
● 4 TRUCK				
★	DSC9 - DC9 01/ 02/ 03/ 04/ 05/ 06			



ALL THE COMPONENTS LISTED IN OUR CATALOGUE ARE NOT ORIGINAL, THOUGH PERFECTLY INTERCHANGEABLE. REFERENCE NUMBERS, EITHER ORIGINAL OR OF A DIFFERENT NATURE, ARE FOR INFORMATION PURPOSES ONLY. WHEN PLACING AN ORDER, PLEASE, ALWAYS USE COSIBO REFERENCE NUMBERS AND DO NOT MENTION THE ORIGINAL REFERENCE NUMBERS OF THE TRUCK MANUFACTURERS IN THE INVOICE TO VEHICLE OWNERS OR TO ANYBODY ELSE. THE CUSTOMER TAKES HIS OWN RESPONSIBILITY IF HE DOES NOT COMPLY WITH WHAT ABOVE.

		Code	OEM new	OEM old
CONN. ROD BUSHING	● Model	63550	1440359	1339877 1437123
	★ Application			
	● 4 BUS			
	★	DC9 19/ 20/ 21 - D11 - D12 - K114/ 124		
	● F-K-N BUS			
	★	D11/D12 ENG 6302553 - ENG 8103229 - ENG 6302554 - ENG 8103230 - D9 PDE ENG 6299926 - ENG 8103229 - ENG 6299927 - ENG 8103230 - DC9 19/20/21 ENG 8103230 - D9 PDE K/N ENG 6299926 - ENG 8103229 - ENG 6299927 - ENG 8103230 - D12 K ENG 6302553 - ENG 8103229 - ENG 6302554 - ENG 8103230		
	● IND. MARINE ENGINE 4			
	★	D112 68M - D12M EMS - D112 49A - DC12 57A - DC16A - D116 40/ 41A/ 48A/ 53A - D16M		
	● IND. MARINE ENGINE 5			
	★	SG9 A280 - DC9A EMS ENG 6299926 - ENG 6299927 - ENG 8103229 - ENG 8103230 - DC9A EMS.CLARK 15"/17" ENG 8103230 - ENG 6299926 - ENG 6299927 - ENG 8103229 - DC9A EMS.SAE 11.5"/14" ENG 6299926 - ENG 6299927 - ENG 8103229 - ENG 8103230		
● 4 TRUCK				
★	DC9 19/ 20/ 21- D11 - DSC12 01/ 02 - DSC12 03/ 05 - DC12 - DT12 - DC16			
● P-G-R-T TRUCK				
★	D11/ D12 - D9 PDE - D16			

**MAIN BEARING**

		65442	1779130	
● 4 BUS				
★				
● 4 TRUCK				
★				
● F-K-N BUS				
★				
● IND.MARINE ENGINE 4				
★				
● IND.MARINE ENGINE 5				
★				
● P-G-RT- TRUCK				
★				

ALL THE COMPONENTS LISTED IN OUR CATALOGUE ARE NOT ORIGINAL, THOUGH PERFECTLY INTERCHANGEABLE. REFERENCE NUMBERS, EITHER ORIGINAL OR OF A DIFFERENT NATURE, ARE FOR INFORMATION PURPOSES ONLY. WHEN PLACING AN ORDER, PLEASE, ALWAYS USE COSIBO REFERENCE NUMBERS AND DO NOT MENTION THE ORIGINAL REFERENCE NUMBERS OF THE TRUCK MANUFACTURERS IN THE INVOICE TO VEHICLE OWNERS OR TO ANYBODY ELSE. THE CUSTOMER TAKES HIS OWN RESPONSIBILITY IF HE DOES NOT COMPLY WITH WHAT ABOVE.

CONN. ROD BEARING



- Model
- ★ Application

Code

OEM new

OEM old

65443

1785693

- 4 TRUCK



- IND.MARINE ENGINE 4



- P-G-R-T- TRUCK



PISTON RING SET



63708

550247

- 3 BUS

- ★ DS/DSC11 - DS11 34/74/75/78 - DSC11 04/08/18/21/22/23/35/36/70/71 - DS11 E01

- 3 TRUCK

- ★ DN/DS/DSC11 - DSC14 - DSC11 08/10/21/22/23/35/36/70 - DS11 75 - DTC11 01/02

- 4 TRUCK

- ★ DSC11

ALL THE COMPONENTS LISTED IN OUR CATALOGUE ARE NOT ORIGINAL, THOUGH PERFECTLY INTERCHANGEABLE. REFERENCE NUMBERS, EITHER ORIGINAL OR OF A DIFFERENT NATURE, ARE FOR INFORMATION PURPOSES ONLY. WHEN PLACING AN ORDER, PLEASE, ALWAYS USE COSIBO REFERENCE NUMBERS AND DO NOT MENTION THE ORIGINAL REFERENCE NUMBERS OF THE TRUCK MANUFACTURERS IN THE INVOICE TO VEHICLE OWNERS OR TO ANYBODY ELSE. THE CUSTOMER TAKES HIS OWN RESPONSIBILITY IF HE DOES NOT COMPLY WITH WHAT ABOVE.

	Code	OEM new	OEM old
CONN. ROD SCREW	61199	1100867	170132
● Model			
★ Application			
● 3 BUS			
★			
● 4 BUS			
★	DSC9/ DC9 01/ 02/ 03/ 04/ 05/ 06 - DC9 19/ 20/ 21 - D11 - K/ L/ N94 - DSC9 - DS19 E01 - DC9 - OSC9 G01 - DSC9 K94		
● F-K-N BUS			
★	D11 - D12 - D9 PDE K/ N - D12K		
● IND. MARINE ENGINE 4			
★	DI12 68M - D12M EMS - DI12 49A - DC12 57A - D12M EMS - SG9 A280 - D9A/ M		
● IND. MARINE ENGINE 5			
★	DC9A EMS - DC9A EMS.CLARK 15"/ 17" - DC9A EMS.SAE 11.5"/ 14"		
● 3 TRUCK			
★	DS/ DSC11 - DTC11		
● 4 TRUCK			
★	DSC9/ DC9 01/ 02/ 03/ 04/ 05/ 06 - DC9 19/ 20/ 21 - DSC11 - DSC12 01/ 02 - DSC12 03/ 05 - DC12 - DT12 - DSC14 13/ 15 - OSC11 G03		
● P-G-R-T TRUCK			
★	D11/ D12 - D9 PDE		



	64103	1871043	1376911
SEAL RING			
● 4 BUS			
★	DC11/D12 - DC11 07 - DSC12 02		
● IND. MARINE ENGINE 4			
★	SGI 12A - DC16A - D16M - D12A/D12M EMS - DC9 EMS - DI12 41/42/43/44/45/57M - DSC12 40/42A - DC12 40/42A		
● 4 TRUCK			
★	DSC12 01/02 - DC11/D12 - DC11 07		



	Code	OEM new	OEM old
FILTER SET	63407	550154	
<ul style="list-style-type: none"> ● Model ★ Application 			
<ul style="list-style-type: none"> ● 4 BUS ★ 			
<ul style="list-style-type: none"> ● 4 TRUCK ★ 			
<ul style="list-style-type: none"> ● F-K-N BUS ★ 			
<ul style="list-style-type: none"> ● P-G-R-T TRUCK ★ 			



FILTER	63718	1393640	
<ul style="list-style-type: none"> ● 4 TRUCK ★ 8X2 8X2/6 8X4 			
<ul style="list-style-type: none"> ● P-G-R-T TRUCK ★ PDE 			
<ul style="list-style-type: none"> ● 4 BUS ★ F - K - L 			
<ul style="list-style-type: none"> ● IND.MARINE ENGINE 4 ★ D16A/M - D12A/M EMS 			
<ul style="list-style-type: none"> ● IND.MARINE ENGINE 5 ★ DC9A EMS 			
<ul style="list-style-type: none"> ● F-K-N BUS ★ DC9 16/17/18 - DC12 10/13 - DT12 03/12/17 			



O-RING	64410	1304914	
<ul style="list-style-type: none"> ● 4 TRUCK ★ 			
<ul style="list-style-type: none"> ● F-K-N BUS ★ 			
<ul style="list-style-type: none"> ● P-G-R-T TRUCK ★ 			



ALL THE COMPONENTS LISTED IN OUR CATALOGUE ARE NOT ORIGINAL, THOUGH PERFECTLY INTERCHANGEABLE. REFERENCE NUMBERS, EITHER ORIGINAL OR OF A DIFFERENT NATURE, ARE FOR INFORMATION PURPOSES ONLY. WHEN PLACING AN ORDER, PLEASE, ALWAYS USE COSIBO REFERENCE NUMBERS AND DO NOT MENTION THE ORIGINAL REFERENCE NUMBERS OF THE TRUCK MANUFACTURERS IN THE INVOICE TO VEHICLE OWNERS OR TO ANYBODY ELSE. THE CUSTOMER TAKES HIS OWN RESPONSIBILITY IF HE DOES NOT COMPLY WITH WHAT ABOVE.

	Code	OEM new	OEM old
O-RING	64411	1349018	
<ul style="list-style-type: none"> ● Model ★ Application 			
<ul style="list-style-type: none"> ● 4 BUS ★ 			
<ul style="list-style-type: none"> ● 4 TRUCK ★ 			
<ul style="list-style-type: none"> ● F-K-N BUS ★ 			
<ul style="list-style-type: none"> ● P-G-R-T TRUCK ★ 			



FILTER REPAIR SET	63994	561991	
<ul style="list-style-type: none"> ● 4 TRUCK ★ D16 			
<ul style="list-style-type: none"> ● P-G-R-T TRUCK ★ D16 			



FILTER REPAIR SET	64406	2051700	1921327
<ul style="list-style-type: none"> ● P-G-R-T TRUCK ★ XPI 			



ALL THE COMPONENTS LISTED IN OUR CATALOGUE ARE NOT ORIGINAL, THOUGH PERFECTLY INTERCHANGEABLE. REFERENCE NUMBERS, EITHER ORIGINAL OR OF A DIFFERENT NATURE, ARE FOR INFORMATION PURPOSES ONLY. WHEN PLACING AN ORDER, PLEASE, ALWAYS USE COSIBO REFERENCE NUMBERS AND DO NOT MENTION THE ORIGINAL REFERENCE NUMBERS OF THE TRUCK MANUFACTURERS IN THE INVOICE TO VEHICLE OWNERS OR TO ANYBODY ELSE. THE CUSTOMER TAKES HIS OWN RESPONSIBILITY IF HE DOES NOT COMPLY WITH WHAT ABOVE.

		Code	OEM new	OEM old
O-RING	● Model	64408	804664	
	★ Application			
	● 3 TRUCK			
	★			
	● 4 BUS			
	★ D9 DC11 D12 D14 12.2 BAR			
	● 4 TRUCK			
	★ D16 9.3/12.2BAR - D9 DC11 D12 D14 9.3/12.2BAR - D12 HPI 9.3/12.2BAR - DC9 19/20/12			
	● F-K-N BUS			
	★ PDE - XPI			
● IND.MARINE ENGINE 5				
★ DC16A XPI				
● P-G-R-T TRUCK				
★ XPI - HPI - D16 - D9 D11 D12 D16 PDE				



		64409	1328242	
O-RING	● 4 BUS			
	★ K/L94 - N94 UD - K114/124			
	● F-K-N BUS			
	★ XPI - D13 - D9 OC9 - D9 D13 XPI			
	● IND.MARINE ENGINE 5			
	★ DC09/13A - DC16A - SG9 A280			
	● P-G-R-T TRUCK			
★ XPI - D16 - D13 - D9 OC9 - D9 D13 XPI				



		64748	64748	
REPAIR SET	● 4 TRUCK			
	★ D16 --- COMPOSED BY: NO.1 PC 61193 - NO.1 PC 61194 - NO.1 PC 65313 - NO.1 PC 61902			
	● P-G-R-T TRUCK			
★ D16 --- COMPOSED BY: NO.1 PC 61193 - NO.1 PC 61194 - NO.1 PC 65313 - NO.1 PC 61902				



ALL THE COMPONENTS LISTED IN OUR CATALOGUE ARE NOT ORIGINAL, THOUGH PERFECTLY INTERCHANGEABLE. REFERENCE NUMBERS, EITHER ORIGINAL OR OF A DIFFERENT NATURE, ARE FOR INFORMATION PURPOSES ONLY. WHEN PLACING AN ORDER, PLEASE, ALWAYS USE COSIBO REFERENCE NUMBERS AND DO NOT MENTION THE ORIGINAL REFERENCE NUMBERS OF THE TRUCK MANUFACTURERS IN THE INVOICE TO VEHICLE OWNERS OR TO ANYBODY ELSE. THE CUSTOMER TAKES HIS OWN RESPONSIBILITY IF HE DOES NOT COMPLY WITH WHAT ABOVE.

	Code	OEM new	OEM old
OIL FILTER GASKET	64197	1466382	1456041
<ul style="list-style-type: none"> ● Model ★ Application 			
<ul style="list-style-type: none"> ● 4 TRUCK ★ DC16 			
<ul style="list-style-type: none"> ● IND. MARINE ENGINE 4 ★ D16A/M - DC16A - DI16 48/53/A 			
<ul style="list-style-type: none"> ● P-G-R-T TRUCK ★ D16 			

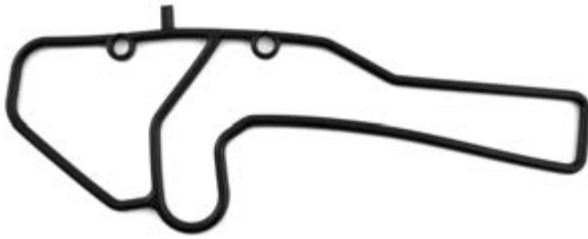

GASKET	64853	1479872	1367849
<ul style="list-style-type: none"> ● 4 BUS ★ 			
<ul style="list-style-type: none"> ● 4 TRUCK ★ 			
<ul style="list-style-type: none"> ● F-K-N BUS ★ 			
<ul style="list-style-type: none"> ● IND.MARINE ENGINE 4 ★ 			
<ul style="list-style-type: none"> ● IND.MARINE ENGINE 5 ★ 			
<ul style="list-style-type: none"> ● P-G-R-T TRUCK ★ 			



ALL THE COMPONENTS LISTED IN OUR CATALOGUE ARE NOT ORIGINAL, THOUGH PERFECTLY INTERCHANGEABLE. REFERENCE NUMBERS, EITHER ORIGINAL OR OF A DIFFERENT NATURE, ARE FOR INFORMATION PURPOSES ONLY. WHEN PLACING AN ORDER, PLEASE, ALWAYS USE COSIBO REFERENCE NUMBERS AND DO NOT MENTION THE ORIGINAL REFERENCE NUMBERS OF THE TRUCK MANUFACTURERS IN THE INVOICE TO VEHICLE OWNERS OR TO ANYBODY ELSE. THE CUSTOMER TAKES HIS OWN RESPONSIBILITY IF HE DOES NOT COMPLY WITH WHAT ABOVE.

	Code	OEM new	OEM old
FILTER	64145	1539675	
<ul style="list-style-type: none"> ● Model ★ Application 			
<ul style="list-style-type: none"> ● 4 TRUCK ★ DC9 19/20/21 			
<ul style="list-style-type: none"> ● F-K-N BUS ★ F 			
<ul style="list-style-type: none"> ● IND. MARINE ENGINE 4 ★ DC12 57A 			
<ul style="list-style-type: none"> ● IND. MARINE ENGINE 5 ★ DC9A EMS 			
<ul style="list-style-type: none"> ● P-G-R-T TRUCK ★ D11 - DC12 - DT12 - D9 PDE 			



	61731	285248	
RUBBER BUFFER			
<ul style="list-style-type: none"> ● 3 TRUCK ★ CR19 - STREAMLINE 			
<ul style="list-style-type: none"> ● IND. MARINE ENGINE 4 ★ D9/D11 - D12A/M - D14A/M - D16M - DC16 			
<ul style="list-style-type: none"> ● IND. MARINE ENGINE 5 ★ DC9A EMS 			



	66581/1	488372	
RUBBER SLEEVE			
<ul style="list-style-type: none"> ● 4 BUS ★ K 94/114/124 - DC9 19/20/21 - F94 LHD 			
<ul style="list-style-type: none"> ● F-K-N BUS ★ K/N - NUD - CNUD 			
<ul style="list-style-type: none"> ● IND. MARINE ENGINE 5 ★ SG9 A280 			



	Code	OEM new	OEM old
RUBBER BUFFER	62214	295297	
<ul style="list-style-type: none"> ● Model ★ Application 			
<ul style="list-style-type: none"> ● 3 TRUCK ★ CR19 			



BOOT	62215	338395	
<ul style="list-style-type: none"> ● 3 TRUCK ★ CR19 			



RUBBER SLEEVE	62216	352543	
<ul style="list-style-type: none"> ● 3 TRUCK ★ LHD/RHD 4X2 6X2 6X4 - DS/DSC11 CH 1154400 - CH 4286035 			



RUBBER SLEEVE	62217	1307953	
<ul style="list-style-type: none"> ● 3 BUS ★ DSC11 21/22/23/24/35/36/70/71/81 - OSC11 G01 			
<ul style="list-style-type: none"> ● 3 TRUCK ★ DSC11 21/22/23/30/35/36/39/70 - DS - DTC11 			
<ul style="list-style-type: none"> ● IND. MARINE ENGINE 4 ★ DI12 41M - DS111 73/76/77/78/79/80/81 - DSC9/DC9 47 A04S - DS/DSC11 - D16M 			



ALL THE COMPONENTS LISTED IN OUR CATALOGUE ARE NOT ORIGINAL, THOUGH PERFECTLY INTERCHANGEABLE. REFERENCE NUMBERS, EITHER ORIGINAL OR OF A DIFFERENT NATURE, ARE FOR INFORMATION PURPOSES ONLY. WHEN PLACING AN ORDER, PLEASE, ALWAYS USE COSIBO REFERENCE NUMBERS AND DO NOT MENTION THE ORIGINAL REFERENCE NUMBERS OF THE TRUCK MANUFACTURERS IN THE INVOICE TO VEHICLE OWNERS OR TO ANYBODY ELSE. THE CUSTOMER TAKES HIS OWN RESPONSIBILITY IF HE DOES NOT COMPLY WITH WHAT ABOVE.

RUBBER SLEEVE



- Model
- ★ Application

Code

OEM new

OEM old

62218

1108488

- **3 BUS**

- ★ DS11 34 - DSC11 08/17/18

- **3 TRUCK**

- ★ DS11 34/75 - DSC11 08/10/17/18/21/23/35/36 - 6X4 CH 1154401 - CH 4286036

- **IND. MARINE ENGINE 4**

- ★ DS11

ALL THE COMPONENTS LISTED IN OUR CATALOGUE ARE NOT ORIGINAL, THOUGH PERFECTLY INTERCHANGEABLE. REFERENCE NUMBERS, EITHER ORIGINAL OR OF A DIFFERENT NATURE, ARE FOR INFORMATION PURPOSES ONLY. WHEN PLACING AN ORDER, PLEASE, ALWAYS USE COSIBO REFERENCE NUMBERS AND DO NOT MENTION THE ORIGINAL REFERENCE NUMBERS OF THE TRUCK MANUFACTURERS IN THE INVOICE TO VEHICLE OWNERS OR TO ANYBODY ELSE. THE CUSTOMER TAKES HIS OWN RESPONSIBILITY IF HE DOES NOT COMPLY WITH WHAT ABOVE.

		Code	OEM new	OEM old
O-RING	● Model	61630	323662	
	★ Application			
	● 3 BUS			
	★	DS9 05/08		
	● 4 BUS			
	★	DSC9 - OSC9 - DS19 - DC9 01/02/03/04/05/06 - DS19 E01 - OSC9 G01 - D9		
	● IND. MARINE ENGINE 4			
	★	SG9 A280 - D9 A/M - DSC9 - DC9 01/02/03/04/05/06		
	● 3 TRUCK			
	★	DS/DSC9 - DN/DS/DSC9		
● 4 TRUCK				
★	DSC9 - OSC9 - DS19 - DC9 01/02/03/04/05/06 - DS19 E01 - OSC9 G01			

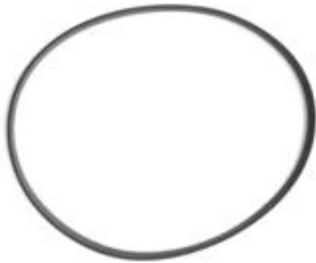

		61631	1302828	342989
SEAL RING	● 3 BUS			
	★	DS11 34/74/75/78 - DSC11 04/08/21/22/23/24/27/35/36/70/71/81 - DS/DSC/OSC11 -		
	● 4 BUS			
	★	OSC11 G03 - DSC11 - DS11 E01		
	● IND. MARINE ENGINE 4			
	★	D14A/M - DS/DSC/DSI 11A - DS11 98/99 - DS11 73/74/75/76/77/78/79/80/81		
	● 3 TRUCK			
	★	DS11 34/73/75 - DSC11 08/10/12/13/16/17/18/21/22/23/30/35/36/39/70 - DN11 01 - DSC14 - DTC11 01/02		
	● 4 TRUCK			
	★	DSC14 13/15 - DSC11 - OSC11 G03		

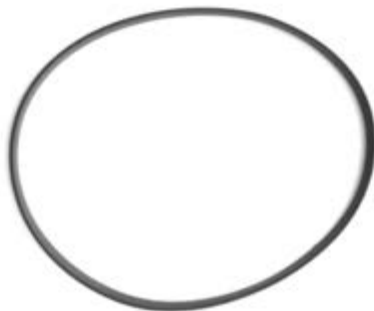

	Code	OEM new	OEM old
SEAL RING	61837	1302827	362408
<ul style="list-style-type: none"> ● Model ★ Application 			
<ul style="list-style-type: none"> ● 3 BUS ★ D9 05/08 			
<ul style="list-style-type: none"> ● 4 BUS ★ D9C9 - DC9 01/02/03/04/05/06 - DSI9 E01 - OSC9 G01 - D9 			
<ul style="list-style-type: none"> ● IND. MARINE ENGINE 4 ★ SG9 A280 - D9 A/M - DSC9 - DC9 01/02/03/04/05/06 			
<ul style="list-style-type: none"> ● 3 TRUCK ★ DN/DS/DSC9 			
<ul style="list-style-type: none"> ● 4 TRUCK ★ DSC9 - DC9 01/02/03/04/05/06 - DSI9 E01 - OSC9 G01 			

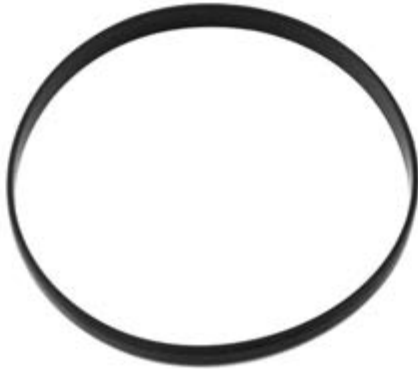

	61632	1312934	323641
O-RING			
<ul style="list-style-type: none"> ● 3 BUS ★ DSC11 - OSC11 - DS11 34/74/75/78 - DSC11 04/08/17/18/21/22/23/24/27/35/36/70/71/81 - DSI11 E01 			
<ul style="list-style-type: none"> ● 4 BUS ★ DSC11 - OSC11 G03 			
<ul style="list-style-type: none"> ● IND. MARINE ENGINE 4 ★ D14A/M - DS/DSC/DSI 11A - DS11 98/99 - DSI11 73/74/75/76/77/78/79/80/81 			
<ul style="list-style-type: none"> ● 3 TRUCK ★ DN/DS/DSC11 - DS11 34/73/75 - DSC11 08/10/12/13/16/17/18/21/22/23/30/35/36/39/70 - DN11 01 - DTC11 01/02 			
<ul style="list-style-type: none"> ● 4 TRUCK ★ DSC - DSC11 - DSC14 13/15 - OSC11 G03 			

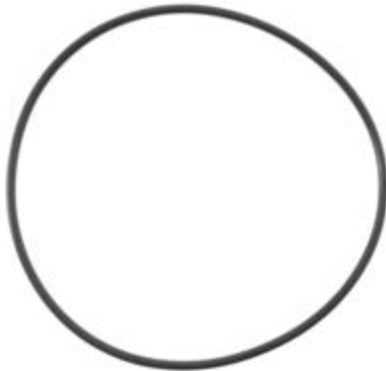

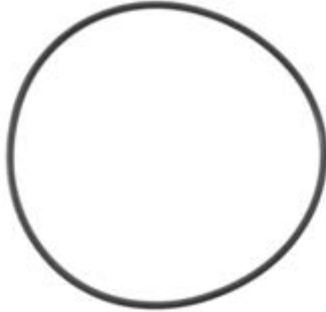

		Code	OEM new	OEM old
O-RING	● Model	63388	323451	
	★ Application			
	● 3 BUS			
	★			
	● 4 BUS			
	★ DSC11 - OSC11 G03 OK			
	● IND. MARINE ENGINE 4			
	★ OK			
	● 3 TRUCK			
	★			
● 4 TRUCK				
★ DSC11 - OSC11 G03 OK				

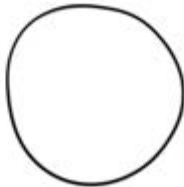

		63548	1862376	1317682 1433063
O-RING	● 4 BUS			
	★ DC11 - D12 - DC9 19/20/21			
	● F-K-N BUS			
	★ D9 - D11 - D12 - D9 PDE			
	● IND. MARINE ENGINE 4			
	★ D12M EMS - DI12 41/42/43/44/45/57/68M - DC12 41/42/45/46/47/48/50/52/53/54/55/56/57/58/59/60A - D12A EMS - D12/16M - DC16 A - DI16 48/53A - DC16 - DI12 46/49/50/51/52/54/56A - DSC12 41A - DSC/DSI/DC/DI12 40A			
	● IND. MARINE ENGINE 5			
	★ DC9A EMS			
	● 4 TRUCK			
	★ DC16 - D12 - DC9 19/20/21 - DC11			
● P-G-R-T TRUCK				
★ D9 - D11 - D12 - D16 - D9 PDE				

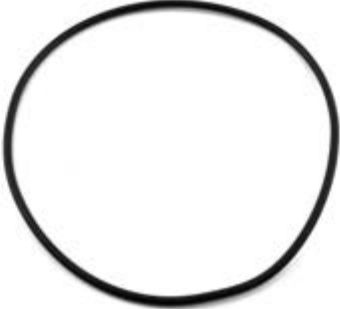

	Code	OEM new	OEM old
O-RING	63549	1328995	
	<ul style="list-style-type: none"> ● Model ★ Application 		
	<ul style="list-style-type: none"> ● 4 BUS ★ DC11 - D12 - DC9 19/20/21 		
	<ul style="list-style-type: none"> ● F-K-N BUS ★ D9 - D11 - D12 - D9 PDE 		
	<ul style="list-style-type: none"> ● IND. MARINE ENGINE 4 ★ D12M EMS - DI12 41/42/43/44/45/57/68M - DC12 41/42/45/46/47/48/50/52/53/54/55/56/57/58/59/60A - D12A EMS - D12/16M - DC16 A - DI16 48A/53A - DC16 - DI12 46/49/50/51/52/54/56A - DSC12 41A - DSC/DSI/DC/DI12 40A 		
	<ul style="list-style-type: none"> ● IND. MARINE ENGINE 5 ★ DC9A EMS 		
	<ul style="list-style-type: none"> ● 4 TRUCK ★ DC16 - D12 - DC9 19/20/21 - DC11 		
	<ul style="list-style-type: none"> ● P-G-R-T TRUCK ★ D9 - D11 - D12 - D16 - D9 PDE 		

	63554	1484765	1352885
O-RING			
	<ul style="list-style-type: none"> ● 4 BUS ★ DC9 19/20/21 - DC11 - D12 		
	<ul style="list-style-type: none"> ● F-K-N BUS ★ D9 PDE - D11 - D12 - D9 XPI 		
	<ul style="list-style-type: none"> ● IND. MARINE ENGINE 4 ★ D12 A/M - DI12 68/69M - DC16 A - DI16 48/53A - D16 M - DC16 		
	<ul style="list-style-type: none"> ● IND. MARINE ENGINE 5 ★ DC9 A EMS - SG9 A280 		
	<ul style="list-style-type: none"> ● 4 TRUCK ★ DC16 - D12 - DC9 19/20/21 - DC11 		
	<ul style="list-style-type: none"> ● P-G-R-T TRUCK ★ D9 PDE - D11 - D12 - D9 XPI - D16 - D13 		

ALL THE COMPONENTS LISTED IN OUR CATALOGUE ARE NOT ORIGINAL, THOUGH PERFECTLY INTERCHANGEABLE. REFERENCE NUMBERS, EITHER ORIGINAL OR OF A DIFFERENT NATURE, ARE FOR INFORMATION PURPOSES ONLY. WHEN PLACING AN ORDER, PLEASE, ALWAYS USE COSIBO REFERENCE NUMBERS AND DO NOT MENTION THE ORIGINAL REFERENCE NUMBERS OF THE TRUCK MANUFACTURERS IN THE INVOICE TO VEHICLE OWNERS OR TO ANYBODY ELSE. THE CUSTOMER TAKES HIS OWN RESPONSIBILITY IF HE DOES NOT COMPLY WITH WHAT ABOVE.

		Code	OEM new	OEM old
O-RING	<ul style="list-style-type: none"> ● Model ★ Application 	63555	1484766	1352866
	<ul style="list-style-type: none"> ● 4 BUS ★ DC9 19/20/21 - DC11 - D12 			
	<ul style="list-style-type: none"> ● F-K-N BUS ★ D9 PDE - D11 - D12 - D9 XPI 			
	<ul style="list-style-type: none"> ● IND. MARINE ENGINE 4 ★ D12 A/M - DI12 68/69M - D16A - DI16 48/53A - D16 M - DC16 			
	<ul style="list-style-type: none"> ● IND. MARINE ENGINE 5 ★ DC9 EMS - SG9 A280 			
	<ul style="list-style-type: none"> ● 4 TRUCK ★ DC16 - D12 - DC9 19/20/21 - DC11 			
	<ul style="list-style-type: none"> ● P-G-R-T TRUCK ★ D9 PDE - D11 - D12 - D9 XPI - D16 - D13 			

		61762	1388684	371492
GASKET				
	<ul style="list-style-type: none"> ● 3 BUS ★ 			
	<ul style="list-style-type: none"> ● 4 BUS ★ DSC11 - OSC11 G03 			
	<ul style="list-style-type: none"> ● IND. MARINE ENGINE 4 ★ 			
	<ul style="list-style-type: none"> ● 3 TRUCK ★ 			
	<ul style="list-style-type: none"> ● 4 TRUCK ★ DSC11 - OSC11 G03 			

ALL THE COMPONENTS LISTED IN OUR CATALOGUE ARE NOT ORIGINAL, THOUGH PERFECTLY INTERCHANGEABLE. REFERENCE NUMBERS, EITHER ORIGINAL OR OF A DIFFERENT NATURE, ARE FOR INFORMATION PURPOSES ONLY. WHEN PLACING AN ORDER, PLEASE, ALWAYS USE COSIBO REFERENCE NUMBERS AND DO NOT MENTION THE ORIGINAL REFERENCE NUMBERS OF THE TRUCK MANUFACTURERS IN THE INVOICE TO VEHICLE OWNERS OR TO ANYBODY ELSE. THE CUSTOMER TAKES HIS OWN RESPONSIBILITY IF HE DOES NOT COMPLY WITH WHAT ABOVE.

	Code	OEM new	OEM old
GASKET	63559	1349497	
● Model			
★ Application			
● 4 BUS			
★ D12 - DC11			
● IND. MARINE ENGINE 4			
★ D12 A/M			
● 4 TRUCK			
★ D12 - DC11			

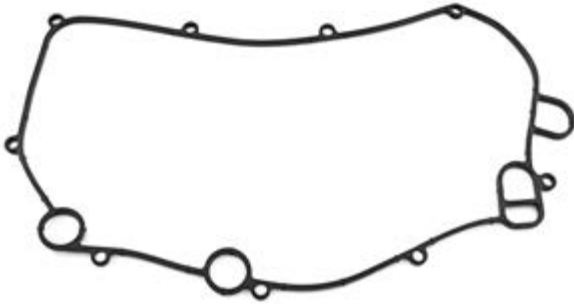

	64137	1502798	1433886
GASKET			
● 4 BUS			
★ DC9 19/20/21 - DC11/D12			
● F-K-N BUS			
★ D9 PDE - D11 - D12			
● IND. MARINE ENGINE 4			
★ D12 A/M - DI12 68/69M			
● IND. MARINE ENGINE 5			
★ DC9A EMS - SG9 A280			
● 4 TRUCK			
★ DC9 19/20/21 - DC11/D12			
● P-G-R-T TRUCK			
★ D9 PDE - D11 - D12			

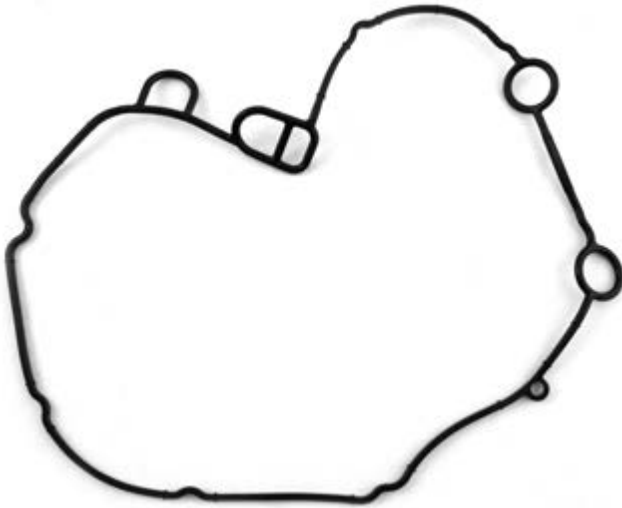

	Code	OEM new	OEM old
VALVE TAPPET (OLD VERSION)	60415	1116635	1103422
<ul style="list-style-type: none"> ● Model ★ Application 			
<ul style="list-style-type: none"> ● 3 BUS 			
<ul style="list-style-type: none"> ★ DSC11 04/08/17/18/21/22/23/24/27/35/36/70/71/81 - DS11 34/74/75/78 - DSI11 E01 - OSC11 G01 			
<ul style="list-style-type: none"> ● IND. MARINE ENGINE 4 			
<ul style="list-style-type: none"> ★ 			
<ul style="list-style-type: none"> ● 3 TRUCK 			
<ul style="list-style-type: none"> ★ DS11 34/73/75 - DSC11 08/10/12/13/16/17/18/21/22/23/30/35/36/39/70 - DN11 01 - DSC14 03/04/06/08/09/10/16 - DTC11 01/02 			
<ul style="list-style-type: none"> ● 4 TRUCK 			
<ul style="list-style-type: none"> ★ DSC14 13/15 - DSC11 - OSC11 G03 			



	Code	OEM new	OEM old
VALVE TAPPET (NEW VERSION)	61187	1522013	1361198 1420836
<ul style="list-style-type: none"> ● Model ★ Application 			
<ul style="list-style-type: none"> ● 3 BUS 			
<ul style="list-style-type: none"> ★ DSC11 04/08/17/18/21/22/23/24/27/35/36/70/71/81 - DS11 34/74/75/78 - DSI11 E01 - OSC11 G01 			
<ul style="list-style-type: none"> ● IND. MARINE ENGINE 4 			
<ul style="list-style-type: none"> ★ 			
<ul style="list-style-type: none"> ● 3 TRUCK 			
<ul style="list-style-type: none"> ★ DS11 34/73/75 - DSC11 08/10/12/13/16/17/18/21/22/23/30/35/36/39/70 - DN11 01 - DSC14 03/04/06/08/09/10/16 - DTC11 01/02 			
<ul style="list-style-type: none"> ● 4 TRUCK 			
<ul style="list-style-type: none"> ★ DSC14 13/15 - DSC11 - OSC11 G03 			



		Code	OEM new	OEM old
GASKET	● Model	64142	1746135	
	★ Application			
	● 4 BUS			
	★ DC9 19/20/21 - DC11/D12			
	● F-K-N BUS			
	★ D9 PDE - D11 - D12			
	● IND. MARINE ENGINE 4			
	★ DI12 68/69M - D12 A/M			
	● IND. MARINE ENGINE 5			
	★ DC9A EMS - SG9 A280			
● 4 TRUCK				
★ DC9 19/20/21 - DC11/D12				
● P-G-R-T TRUCK				
★ D9 PDE - D11 - D12				



		64226	1466383	1423202
GASKET	● 4 TRUCK			
	★ DC16			
	● IND. MARINE ENGINE 4			
	★ DC16 A/M - DC16 - DI16 48/53A			
	● P-G-R-T TRUCK			
	★ D16			



	Code	OEM new	OEM old
GASKET	64232	1509813	1467166
● Model			
★ Application			
● 4 TRUCK			
★ DC16			
● IND. MARINE ENGINE 4			
★ DC16 - DC16 A/M - DI16 48/53A			
● P-G-R-T TRUCK			
★ D16			

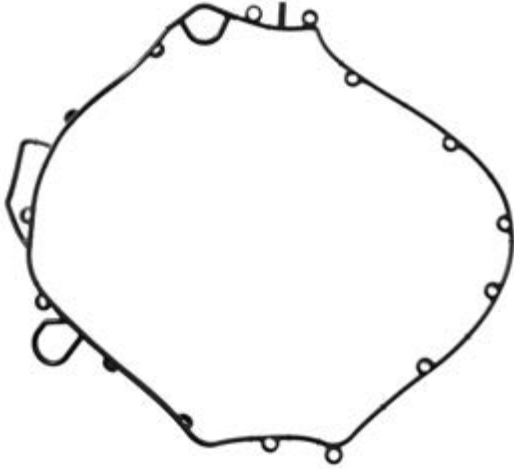

	64138	64138	
OIL COOLER REPAIR SET			
● 4 BUS			
★ DC9 19/20/21 - DC11/D12			
● F-K-N BUS			
★ D9 PDE - D11 - D12			
● IND. MARINE ENGINE 4			
★ D12 A/M - DI12 68/69M			
● IND. MARINE ENGINE 5			
★ DC9A EMS - SG9 A280			
● 4 TRUCK			
★ DC9 19/20/21 - DC11/D12			
● P-G-R-T TRUCK			
★ D9 PDE - D11 - D12			

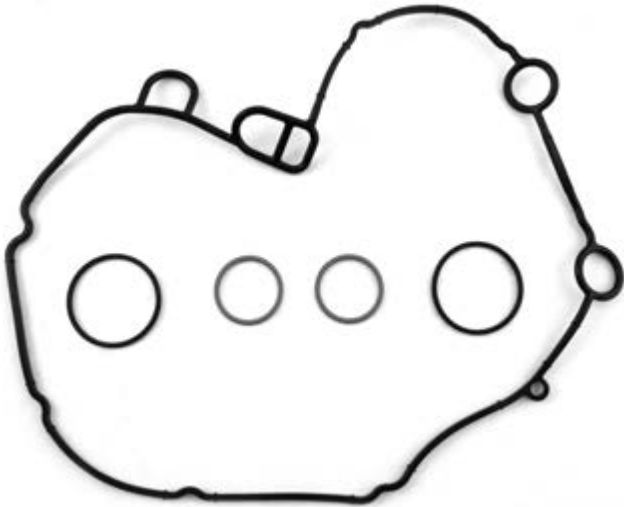

ALL THE COMPONENTS LISTED IN OUR CATALOGUE ARE NOT ORIGINAL, THOUGH PERFECTLY INTERCHANGEABLE. REFERENCE NUMBERS, EITHER ORIGINAL OR OF A DIFFERENT NATURE, ARE FOR INFORMATION PURPOSES ONLY. WHEN PLACING AN ORDER, PLEASE, ALWAYS USE COSIBO REFERENCE NUMBERS AND DO NOT MENTION THE ORIGINAL REFERENCE NUMBERS OF THE TRUCK MANUFACTURERS IN THE INVOICE TO VEHICLE OWNERS OR TO ANYBODY ELSE. THE CUSTOMER TAKES HIS OWN RESPONSIBILITY IF HE DOES NOT COMPLY WITH WHAT ABOVE.

	Code	OEM new	OEM old
OIL COOLER REPAIR SET	64140	64140	
<ul style="list-style-type: none"> ● Model ★ Application 			
<ul style="list-style-type: none"> ● 4 BUS ★ D12 - DC11 FOR OUR 62519 			
<ul style="list-style-type: none"> ● IND. MARINE ENGINE 4 ★ D12 A/M FOR OUR 62519 			
<ul style="list-style-type: none"> ● 4 TRUCK ★ D12 - DC11 FOR OUR 62519 			

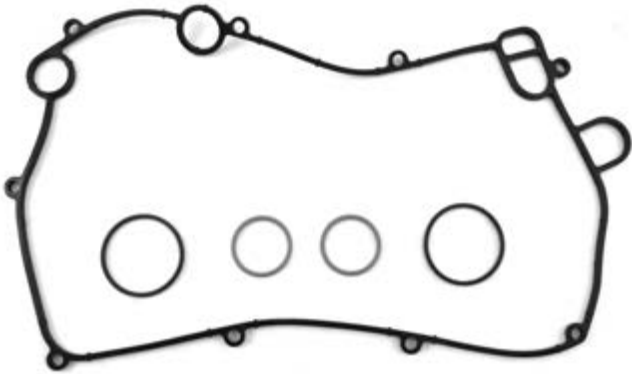

OIL COOLER GASKET SET	64385	64385	
<ul style="list-style-type: none"> ● 3 BUS ★ FOR OUR 61759 & 64383 			
<ul style="list-style-type: none"> ● IND. MARINE ENGINE 4 ★ FOR OUR 61759 & 64383 			
<ul style="list-style-type: none"> ● 3 TRUCK ★ DS - DSC11 FOR OUR 61759 & 64383 			
<ul style="list-style-type: none"> ● 4 TRUCK ★ DSC11 - OSC11 G03 FOR OUR 61759 & 64383 			



OIL COOLER GASKET SET	64386	64386	
<ul style="list-style-type: none"> ● 4 TRUCK ★ DSC14 13/15 FOR OUR 63952 			



OIL COOLER REPAIR SET

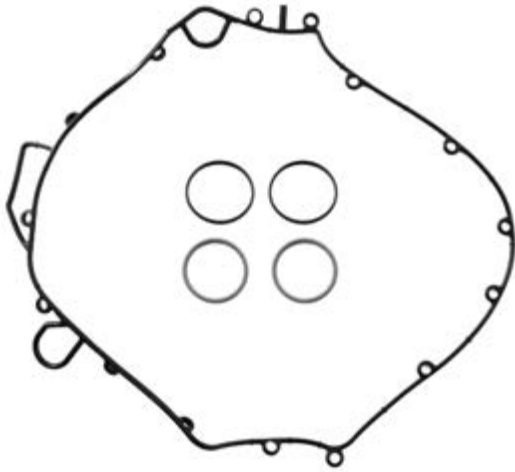

● Model

★ Application

Code

OEM new

OEM old

64398

64398

● IND.MARINE ENGINE 4

★ DC16 - DC16 A/M - DI16 48/53A

● 4 TRUCK

★ DC16

● P-G-R-T TRUCK

★ D16

OIL COOLER REPAIR SET



64395

64395

● 4 BUS

★ DC9 19/20/21 ENG 6357164-6357770-ENG 6368628 - DC11/D12 ENG 6357164-6357770-ENG 6368387

● F-K-N BUS

★ D9 PDE-D11-D12 ENG 6357164-6357770-ENG 6368387

● IND.MARINE ENGINE 4

★ DI12 68/69M ENG 6519084 - D12 A/M ENG 6519084

● IND.MARINE ENGINE 5

★ DC9A EMS ENG 6357164-6357770-ENG 6368628 - SG9 A280 ENG 6519063

● 4 TRUCK

★ DC9 19/20/21 ENG 6357164-6357770-ENG 6368628 - DC11/D12 ENG 6357164-6357770-ENG 6368387

● P-G-R-T TRUCK

★ D9 PDE-D11-D12 ENG 6357164-6357770-ENG 6368387

		Code	OEM new	OEM old
O-RING	● Model	63562	812418	182525
	★ Application			
	● 3 BUS			
	★			
	● 3 TRUCK			
	★			
	● 4 BUS			
	★			
	● 4 TRUCK			
	★			
	● F-K-N BUS			
	★			
	● IND.MARINE ENGINE 4			
	★			
	● IND.MARINE ENGINE 5			
	★			
	● P-G-R-T TRUCK			
	★			

ALL THE COMPONENTS LISTED IN OUR CATALOGUE ARE NOT ORIGINAL, THOUGH PERFECTLY INTERCHANGEABLE. REFERENCE NUMBERS, EITHER ORIGINAL OR OF A DIFFERENT NATURE, ARE FOR INFORMATION PURPOSES ONLY. WHEN PLACING AN ORDER, PLEASE, ALWAYS USE COSIBO REFERENCE NUMBERS AND DO NOT MENTION THE ORIGINAL REFERENCE NUMBERS OF THE TRUCK MANUFACTURERS IN THE INVOICE TO VEHICLE OWNERS OR TO ANYBODY ELSE. THE CUSTOMER TAKES HIS OWN RESPONSIBILITY IF HE DOES NOT COMPLY WITH WHAT ABOVE.

		Code	OEM new	OEM old
GASKET	● Model	63563	1391726	366550
	★ Application			
	● 3 BUS			
	★			
	● 3 TRUCK			
	★			
	● 4 BUS			
	★			
	● 4 TRUCK			
	★			
	● F-K-N BUS			
	★			
	● IND.MARINE ENGINE 4			
	★			
● IND.MARINE ENGINE 5				
★				
● P-G-R-T TRUCK				
★				



		64141	2010938	1795526 1774202
OIL COOLER COVER	● 4 BUS			
	★ DC9 19/20/21 - DC11 - D12			
	● 4 TRUCK			
	★ DC9 19/20/21 - DC11 - D12			
	● F-K-N BUS			
	★ D9/D11/D12			
	● IND.MARINE ENGINE 4			
	★ D12 68/69M - D12A/M - DC12 60A			
	● IND.MARINE ENGINE 5			
	★ DC9A EMS - SG9 A280			
	● P-G-R-T TRUCK			
	★ D9/D11/D12			



ALL THE COMPONENTS LISTED IN OUR CATALOGUE ARE NOT ORIGINAL, THOUGH PERFECTLY INTERCHANGEABLE. REFERENCE NUMBERS, EITHER ORIGINAL OR OF A DIFFERENT NATURE, ARE FOR INFORMATION PURPOSES ONLY. WHEN PLACING AN ORDER, PLEASE, ALWAYS USE COSIBO REFERENCE NUMBERS AND DO NOT MENTION THE ORIGINAL REFERENCE NUMBERS OF THE TRUCK MANUFACTURERS IN THE INVOICE TO VEHICLE OWNERS OR TO ANYBODY ELSE. THE CUSTOMER TAKES HIS OWN RESPONSIBILITY IF HE DOES NOT COMPLY WITH WHAT ABOVE.

		Code	OEM new	OEM old
OIL COOLER	● Model	61759	1368736	1350909
	★ Application			1362222
				1368735
				350061
		● 3 BUS		
		★		
		● IND. MARINE ENGINE 4		
		★		
		● 3 TRUCK		
		★ DS - DSC11		



OIL COOLER	63952	1439171	
		● 4 TRUCK	
		★ DSC14 13/15	



OIL COOLER BODY	64868	1356880	
		● 4 TRUCK	
		★ DSC14 13/15	



ALL THE COMPONENTS LISTED IN OUR CATALOGUE ARE NOT ORIGINAL, THOUGH PERFECTLY INTERCHANGEABLE. REFERENCE NUMBERS, EITHER ORIGINAL OR OF A DIFFERENT NATURE, ARE FOR INFORMATION PURPOSES ONLY. WHEN PLACING AN ORDER, PLEASE, ALWAYS USE COSIBO REFERENCE NUMBERS AND DO NOT MENTION THE ORIGINAL REFERENCE NUMBERS OF THE TRUCK MANUFACTURERS IN THE INVOICE TO VEHICLE OWNERS OR TO ANYBODY ELSE. THE CUSTOMER TAKES HIS OWN RESPONSIBILITY IF HE DOES NOT COMPLY WITH WHAT ABOVE.

		Code	OEM new	OEM old
OIL COOLER	● Model	62519	1543688	1333183
	★ Application			
	● 4 BUS			
	★ DC11 - DC11/D12			
	● F-K-N BUS			
	★ D9 PDE - D11 - D12 - D9 XPI			
	● IND. MARINE ENGINE 4			
	★ D12 A/M - DI12 68/69M			
	● 4 TRUCK			
	★ DC11 - DC11/D12 - DC16			
● P-G-R-T TRUCK				
★ D9 PDE - D11 - D12 - D9 XPI - D16 - D13				



		63953	1448933	
OIL COOLER	● 4 TRUCK			
	★ DC16 ENG 1069776			
	● P-G-R-T TRUCK			
	★ D16 ENG 1069776			
	● IND.MARINE ENGINE 4			
★ DC16 A - DI16 48/53A - D16 M				



		60111	1369981	1318091 301473
OIL PUMP	● 3 BUS			
	★ ENG 5347666 - ENG 5333759 - ENG 5333760 - DSC1117 ENG 5347666 - ENG 5319702			
	● IND. MARINE ENGINE 4			
	★			
	● 3 TRUCK			
	★ DSC1117: ENG 4082208 - ENG 5319701 - ENG 5319702 - ENG 5333759 - ENG 5333760 - ENG 3154338 - ENG 3154339 - ENG 5347666 - ENG 4089251 - ENG 4089252			
	● 4 TRUCK			
★ DSC11 - OSC11 G03				



ALL THE COMPONENTS LISTED IN OUR CATALOGUE ARE NOT ORIGINAL, THOUGH PERFECTLY INTERCHANGEABLE. REFERENCE NUMBERS, EITHER ORIGINAL OR OF A DIFFERENT NATURE, ARE FOR INFORMATION PURPOSES ONLY. WHEN PLACING AN ORDER, PLEASE, ALWAYS USE COSIBO REFERENCE NUMBERS AND DO NOT MENTION THE ORIGINAL REFERENCE NUMBERS OF THE TRUCK MANUFACTURERS IN THE INVOICE TO VEHICLE OWNERS OR TO ANYBODY ELSE. THE CUSTOMER TAKES HIS OWN RESPONSIBILITY IF HE DOES NOT COMPLY WITH WHAT ABOVE.

		Code	OEM new	OEM old
OIL PUMP BUSHING	● Model	60016	319110	139110
	★ Application			
	● 3 BUS			
	★	ENG 5347666 - ENG 5333759 - ENG 5333760 - DSC1117 ENG 5347666 - ENG 5319702		
	● IND. MARINE ENGINE 4			
	★			
	● 3 TRUCK			
★	DSC1117:ENG 4082208 - ENG 5319701 - ENG 5319702 - ENG 5333759 - ENG 5333760 - ENG 3154338 - ENG 3154339 - ENG 5347666 - ENG 4089251 - ENG 4089252			
● 4 TRUCK				
★	DSC11 - OSC11 G03			



		60112	154621	
OIL PUMP GEAR	● 3 BUS			
	★	ENG 5347666 - ENG 5333759 - ENG 5333760 - DSC1117 ENG 5347666 - ENG 5319702		
	● IND. MARINE ENGINE 4			
	★			
	● 3 TRUCK			
	★	DSC1117:ENG 4082208 - ENG 5319701 - ENG 5319702 - ENG 5333759 - ENG 5333760 - ENG 3154338 - ENG 3154339 - ENG 5347666 - ENG 4089251 - ENG 4089252		
	● 4 TRUCK			
★	DSC11 - OSC11 G03			



		Code	OEM new	OEM old
OIL PUMP GEAR	● Model	60113	225931	
	★ Application			
	● 3 BUS			
	★	ENG 5347666 - ENG 5333759 - ENG 5333760 - DSC1117 ENG 5347666 - ENG 5319702		
	● IND. MARINE ENGINE 4			
	★			
● 3 TRUCK				
★	DSC1117:ENG 4082208 - ENG 5319701 - ENG 5319702 - ENG 5333759 - ENG 5333760 - ENG 3154338 - ENG 3154339 - ENG 5347666 - ENG 4089251 - ENG 4089252			
● 4 TRUCK				
★	DSC11 - OSC11 G03			



		60114	225353	
OIL PUMP GEAR	● 3 BUS			
	★	ENG 5347666 - ENG 5333759 - ENG 5333760 - DSC1117 ENG 5347666 - ENG 5319702		
	● IND. MARINE ENGINE 4			
	★			
	● 3 TRUCK			
	★	DSC1117:ENG 4082208 - ENG 5319701 - ENG 5319702 - ENG 5333759 - ENG 5333760 - ENG 3154338 - ENG 3154339 - ENG 5347666 - ENG 4089251 - ENG 4089252		
● 4 TRUCK				
★	DSC11 - OSC11 G03			



		Code	OEM new	OEM old
OIL PUMP GEAR	● Model	60115	225354	
	★ Application			
	● 3 BUS			
	★	ENG 5347666 - ENG 5333759 - ENG 5333760 - DSC1117 ENG 5347666 - ENG 5319702		
	● IND. MARINE ENGINE 4			
	★			
● 3 TRUCK				
★	DSC1117:ENG 4082208 - ENG 5319701 - ENG 5319702 - ENG 5333759 - ENG 5333760 - ENG 3154338 - ENG 3154339 - ENG 5347666 - ENG 4089251 - ENG 4089252			
● 4 TRUCK				
★	DSC11 - OSC11 G03			



		60116	238777	
OIL PUMP GASKET	● 3 BUS			
	★	ENG 5347666 - ENG 5333759 - ENG 5333760 - DSC1117 ENG 5347666 - ENG 5319702		
	● IND. MARINE ENGINE 4			
	★			
	● 3 TRUCK			
	★	DSC1117:ENG 4082208 - ENG 5319701 - ENG 5319702 - ENG 5333759 - ENG 5333760 - ENG 3154338 - ENG 3154339 - ENG 5347666 - ENG 4089251 - ENG 4089252		
● 4 TRUCK				
★	DSC11 - OSC11 G03			



OIL PUMP



● Model

★ Application

Code

OEM new

OEM old

60391

263161

● 3 TRUCK

★ DSC14 03/04/06 - DSC14 08/09/10 ENG 5549166 - ENG 4189352

OIL PUMP GEAR



60407

242299

● 3 TRUCK

★ DSC14 03/04/06 - DSC14 08/09/10 ENG 5549166 - ENG 4189352

OIL PUMP GEAR



60408

242297

● 3 TRUCK

★ DSC14 03/04/06 - DSC14 08/09/10 ENG 5549166 - ENG 4189352

OIL PUMP GEAR



60409

242298

● 3 TRUCK

★ DSC14 03/04/06 - DSC14 08/09/10 ENG 5549166 - ENG 4189352

ALL THE COMPONENTS LISTED IN OUR CATALOGUE ARE NOT ORIGINAL, THOUGH PERFECTLY INTERCHANGEABLE. REFERENCE NUMBERS, EITHER ORIGINAL OR OF A DIFFERENT NATURE, ARE FOR INFORMATION PURPOSES ONLY. WHEN PLACING AN ORDER, PLEASE, ALWAYS USE COSIBO REFERENCE NUMBERS AND DO NOT MENTION THE ORIGINAL REFERENCE NUMBERS OF THE TRUCK MANUFACTURERS IN THE INVOICE TO VEHICLE OWNERS OR TO ANYBODY ELSE. THE CUSTOMER TAKES HIS OWN RESPONSIBILITY IF HE DOES NOT COMPLY WITH WHAT ABOVE.

OIL PUMP



- Model
- ★ Application

Code

OEM new

OEM old

61460

1370254

- 4 TRUCK

- ★ DSC14 13/15

OIL PUMP



61461

2028987

1888025
1448659

- 4 BUS

- ★ DC11 - D12 ENG 6120948 - ENG 6120949 - ENG 8005013 - ENG 8005014

- F-K-N BUS

- ★ D11 - D12K

- IND. MARINE ENGINE 4

- ★ D12 A/M - D112 49A - DC12 57A - D112 68/69M

- 4 TRUCK

- ★ D12 - DSC12 - DC12 - DC11

- P-G-R-T TRUCK

- ★ D11 - D12

		Code	OEM new	OEM old
OIL PUMP	● Model	61909	1402400	1102581
	★ Application			1318075
				1322142
				1402401
		● 3 BUS		
		★ ENG 5109548 - ENG 5109549		
		● 4 BUS		
		★ DSC9 - DC9 01/02/03/04/05/06 ENG 4031032 - ENG 4031029 - ENG 5127534 - DSC9 - DSI9 E01 - DC9 - K/L/N94 - DSC9 - DSI9 E01 - DC9 - OSC9 G01 - K94 DSC9		
		● IND. MARINE ENGINE 4		
		★ SG9 A280 - D9M - D9A/M ENG 5127534		
		● 3 TRUCK		
		★ ENG 4013962 - ENG 5109548 - ENG 5109549		
		● 4 TRUCK		
		★ DSC9 - DC9 01/02/03/04/05/06 ENG 4031032 - ENG 4031029 - ENG 5127534 - DSC9 ENG 4031031 - ENG 4031028 - ENG 5127533		



OIL PUMP	61916	1323823	
● IND. MARINE ENGINE 4			
★			
● 3 TRUCK			
★ DSC14 08/09/10/16 ENG 5549167 - ENG 4189353			



ALL THE COMPONENTS LISTED IN OUR CATALOGUE ARE NOT ORIGINAL, THOUGH PERFECTLY INTERCHANGEABLE. REFERENCE NUMBERS, EITHER ORIGINAL OR OF A DIFFERENT NATURE, ARE FOR INFORMATION PURPOSES ONLY. WHEN PLACING AN ORDER, PLEASE, ALWAYS USE COSIBO REFERENCE NUMBERS AND DO NOT MENTION THE ORIGINAL REFERENCE NUMBERS OF THE TRUCK MANUFACTURERS IN THE INVOICE TO VEHICLE OWNERS OR TO ANYBODY ELSE. THE CUSTOMER TAKES HIS OWN RESPONSIBILITY IF HE DOES NOT COMPLY WITH WHAT ABOVE.

		Code	OEM new	OEM old
SEAL RING	● Model	64143	381235	
	★ Application			
	● 3 BUS			
	★			
	● 3 TRUCK			
	★			
	● 4 BUS			
	★ DC11 - D12 - DSC9 - DS19 E01 - DC9 01/02/03/04/05/06 - OSC9 G01 - K/L/N 94			
	● 4 TRUCK			
	★ D12 - DSC9 - DC9 01/02/03/04/05/06 - DC11 - DS19 E01 - OSC9 G01			
● IND. MARINE ENGINE 4				
★ D12 A/M - SG9 A280 - D9 A/M - DSC9				



		64144	1351692	
O-RING	● 4 BUS			
	★ DC11 - D12 - DC9 19/20/21 - K 94			
	● 4 TRUCK			
	★ DC11 - D12 - DC9 19/20/21			
	● F-K-N BUS			
	★ D9 PDE - D11 - D12 K			
	● IND. MARINE ENGINE 4			
	★ D12 A/M - DI12 49A - DC12 57A - DI12 68/69M			
	● IND. MARINE ENGINE 5			
	★ DC9 A EMS - SG9 A280			
● P-G-R-T TRUCK				
★ D9 PDE - D11 - D12				



	Code	OEM new	OEM old
REPAIR SET	64190	64190	
● Model			
★ Application			
● 3 BUS			
★ COMPOSED BY: N.2 PCS 64143 - N.1 PC 64144			
● 3 TRUCK			
★ COMPOSED BY: N.2 PCS 64143 - N.1 PC 64144			
● 4 BUS			
★ DC11 - D12 - DSC9 - DS19 E01 - DC9 01/02/03/04/05/06 - OSC9 G01 - K/L/N 94 - COMPOSED BY: N.2 PCS 64143 - N.1 PC 64144			
● 4 TRUCK			
★ D12 - DSC9 - DC9 01/02/03/04/05/06 - DC11 - DS19 E01 - OSC9 G01 - COMPOSED BY: N.2 PCS 64143 - N.1 PC 64144			
● IND. MARINE ENGINE 4			
★ D12 A/M - SG9 A280 - D9 A/M - DSC9 - COMPOSED BY: N.2 PCS 64143 - N.1 PC 64144			



		Code	OEM new	OEM old
GASKET	● Model	60206	1388678	371507
	★ Application			
	● 3 BUS			
	★	DS11 34/74/75/78 - DSC11 04/08/17/18/21/22/23/24/27/35/36/70/71/81 - DSI11 E01 - OSC11 G01		
	● 4 BUS			
	★	OSC11 G03		
	● IND. MARINE ENGINE 4			
	★	DS DSC DSI11 A		
	● 3 TRUCK			
	★	DS11 34/73/75 - DSC11 08/10/12/13/16/17/18/21/22/23/30/35/36/39/70 - DN11 01 - DTC11 01/02		
● 4 TRUCK				
★	DSC11 74/75/79 - OSC11 G03			



		60561	258459	
GASKET	● 3 BUS			
	★			
	● 4 BUS			
	★	DSC11 OSC11 G03		
	● IND. MARINE ENGINE 4			
	★	DS/DSC/DSI11A		
	● 3 TRUCK			
	★			
	● 4 TRUCK			
	★	DSC11 OSC11 G03		



		Code	OEM new	OEM old
GASKET	● Model	61237	378299	344426
	★ Application			
	● 3 BUS			
	★ DSC9 UP TO ENG 5130020 - ENG 4032264			
● 3 TRUCK				
★ DSC9 UP TO ENG 5130020 - ENG 4032264				



GASKET		61834	1305959	170610 381638
	● IND. MARINE ENGINE 4			
	★ D/DC/D14/D114 A/M			
	● 3 TRUCK			
★				
● 4 TRUCK				
★ DSC14 13/15				





GASKET		62489	1420776	
	● 4 BUS			
	★ DSC9 - DS19 E01 - DC9 01/ 02/ 03/ 04/ 05/ 06 - OSC9 G01 - OSC9 - DS19 - DSC9 ENG 5130021 - ENG 4032265 - DSC9 - DS19 E01 OSC9 G01 ENG 5130021 - ENG 4032265 - ENG 3127204 - DSC9 DS19 E01 ENG 5130021 - ENG 4032264			
	● IND. MARINE ENGINE 4			
★ D - DC - DI 9A/ 9M - SG9 A280 - D9 A/ M - DSC9/ DC9 A/ M - FOR ENG 5130021 - ENG 4032265				
● 4 TRUCK				
★ DSC9 - DS19 E01 - DC9 01/ 02/ 03/ 04/ 05/ 06 - OSC9 G01 - OSC9 - DS19 - DSC9 ENG 5130021 - ENG 4032265				



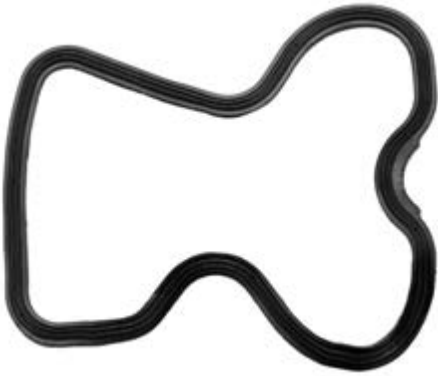

ALL THE COMPONENTS LISTED IN OUR CATALOGUE ARE NOT ORIGINAL, THOUGH PERFECTLY INTERCHANGEABLE. REFERENCE NUMBERS, EITHER ORIGINAL OR OF A DIFFERENT NATURE, ARE FOR INFORMATION PURPOSES ONLY. WHEN PLACING AN ORDER, PLEASE, ALWAYS USE COSIBO REFERENCE NUMBERS AND DO NOT MENTION THE ORIGINAL REFERENCE NUMBERS OF THE TRUCK MANUFACTURERS IN THE INVOICE TO VEHICLE OWNERS OR TO ANYBODY ELSE. THE CUSTOMER TAKES HIS OWN RESPONSIBILITY IF HE DOES NOT COMPLY WITH WHAT ABOVE.

		Code	OEM new	OEM old
GASKET	● Model	64276	1425921	
	★ Application			
	● 4 TRUCK			
	★ P/R 94 K/N94 DC9 01/02/03/04/05/06			
	● 4 BUS			
	★ P/R 94 K/N94 DC9 01/02/03/04/05/06 - F/L 94 DC9			

		63085	1367028	
GASKET	● 4 BUS			
	★ DSC12 01/02 - DC11 07 - DC11 - DC12			
	● IND. MARINE ENGINE 4			
	★ D12A			
	● 4 TRUCK			
	★ DSC12 01/02 - DC11 07 - DC11 - DC12			

		63627	291826	
GASKET	● 3 BUS			
	★ DS11 34/74/75/78 - DSC11 08/17/18/21/22/23/35/36/70/71 - DS11 - N113 - K113 GR801 DS11 34 DSC11 21 - L113 G776 GS771/772 GR801 GA775/781/R - F113 RH - GR801R			
	● 4 BUS			
	★ DSC11 - OSC11 G03			
	● IND. MARINE ENGINE 4			
	★ D11 - DS/DSC/DSI 11A			
	● 3 TRUCK			
	★ DS11 34/73/75 - DSC11 08/10/12/13/16/17/18/21/22/23/30/35/36/39/70 - DN11 01 - DTC11 01/02 - CP/CR/CT 113 - CR13/19 D11 - CP/CR DSC11 21/22(EDC)/23 - CP/CR/CT 113 GR/GRS900R - CP113 ML/HL 4X2 6X2 GA850 - GA850R (HD4060PR)			
	● 4 TRUCK			
	★ DSC11 - OSC11 G03 - CP/CR/CT DSC11 74/75/79			

ALL THE COMPONENTS LISTED IN OUR CATALOGUE ARE NOT ORIGINAL, THOUGH PERFECTLY INTERCHANGEABLE. REFERENCE NUMBERS, EITHER ORIGINAL OR OF A DIFFERENT NATURE, ARE FOR INFORMATION PURPOSES ONLY. WHEN PLACING AN ORDER, PLEASE, ALWAYS USE COSIBO REFERENCE NUMBERS AND DO NOT MENTION THE ORIGINAL REFERENCE NUMBERS OF THE TRUCK MANUFACTURERS IN THE INVOICE TO VEHICLE OWNERS OR TO ANYBODY ELSE. THE CUSTOMER TAKES HIS OWN RESPONSIBILITY IF HE DOES NOT COMPLY WITH WHAT ABOVE.

	Code	OEM new	OEM old
GASKET	63804	1367027	
	<ul style="list-style-type: none"> ● Model ★ Application 		
	<ul style="list-style-type: none"> ● 4 BUS ★ DSC12 01/02 - DC11 07 - D12 		
	<ul style="list-style-type: none"> ● 4 TRUCK ★ DSC12 01/02 - DC11 07 - D12 		
GASKET	63853	1411851	
	<ul style="list-style-type: none"> ● 4 BUS ★ DSC12 01/02/03/05 - DC12 - DT12 - DC11 01/02/03/04/06/07 		
	<ul style="list-style-type: none"> ● IND. MARINE ENGINE 4 ★ DC16 - DC16A - D16A - D16M - D12M EMS - D12A EMS - D116 48A/53A - D12A/M 		
	<ul style="list-style-type: none"> ● 4 TRUCK ★ DSC12 01/02/03/05 - DC12 - DT12 - DC11 01/02/03/04/06/07 - DC16 		
GASKET	63854	1401984	
	<ul style="list-style-type: none"> ● 4 BUS ★ DSC12 01/02/03/05 - DC12 - D12 - DC11 01/02/03/04/06/07 - DT12 		
	<ul style="list-style-type: none"> ● IND. MARINE ENGINE 4 ★ D12 A/M 		
	<ul style="list-style-type: none"> ● 4 TRUCK ★ DSC12 01/02/03/05 - DC12 - D12 - DC11 01/02/03/04/06/07 - DT12 		

ALL THE COMPONENTS LISTED IN OUR CATALOGUE ARE NOT ORIGINAL, THOUGH PERFECTLY INTERCHANGEABLE. REFERENCE NUMBERS, EITHER ORIGINAL OR OF A DIFFERENT NATURE, ARE FOR INFORMATION PURPOSES ONLY. WHEN PLACING AN ORDER, PLEASE, ALWAYS USE COSIBO REFERENCE NUMBERS AND DO NOT MENTION THE ORIGINAL REFERENCE NUMBERS OF THE TRUCK MANUFACTURERS IN THE INVOICE TO VEHICLE OWNERS OR TO ANYBODY ELSE. THE CUSTOMER TAKES HIS OWN RESPONSIBILITY IF HE DOES NOT COMPLY WITH WHAT ABOVE.

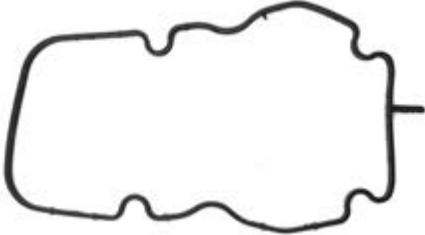
		Code	OEM new	OEM old
GASKET	● Model	63855	1414422	
	★ Application			
	● 4 BUS			
	★ DSC12 01/02/03/05 - DC11 01/02/03/04/06/07 - DC12 - DT12			
	● IND. MARINE ENGINE 4			
	★ D12A - D12M - SGI12A - D12A/M			
	● IND. MARINE ENGINE 5			
	★ SG9 A280			
	● 4 TRUCK			
	★ DSC12 01/02/03/05 - DC11 01/02/03/04/06/07 - DC12 - DT12			

		65342	1505366	
GASKET	● 4 BUS			
	★ DC9 19/20/21			
	● F-K-N BUS			
	★ D9 PDE - D9 - D11 - D12 - D16			
	● IND. MARINE ENGINE 4			
	★ D16A - D16M - D12M EMS - DC12 50A/57A			
	● IND. MARINE ENGINE 5			
	★ DC9A EMS			
	● 4 TRUCK			
	★ DC16 ENG 1018725 - DC9 19/20/21			
	● P-G-R-T TRUCK			
	★ D9 PDE - D9 - D11 - D12 - D16			

ALL THE COMPONENTS LISTED IN OUR CATALOGUE ARE NOT ORIGINAL, THOUGH PERFECTLY INTERCHANGEABLE. REFERENCE NUMBERS, EITHER ORIGINAL OR OF A DIFFERENT NATURE, ARE FOR INFORMATION PURPOSES ONLY. WHEN PLACING AN ORDER, PLEASE, ALWAYS USE COSIBO REFERENCE NUMBERS AND DO NOT MENTION THE ORIGINAL REFERENCE NUMBERS OF THE TRUCK MANUFACTURERS IN THE INVOICE TO VEHICLE OWNERS OR TO ANYBODY ELSE. THE CUSTOMER TAKES HIS OWN RESPONSIBILITY IF HE DOES NOT COMPLY WITH WHAT ABOVE.

		Code	OEM new	OEM old
GASKET	● Model	65343	1449542	
	★ Application			
	● 4 BUS			
	★ DC9 19/20/21			
	● F-K-N BUS			
	★ D11 - D12 - D9 PDE - D9 - D16			
	● IND. MARINE ENGINE 4			
	★ D12M EMS - DC12 50A/57A - DC16A - D16M - DC16			
	● IND. MARINE ENGINE 5			
	★ DC9A EMS			
● 4 TRUCK				
★ DC16 - DC9 19/20/21				
● P-G-R-T TRUCK				
★ D11 - D12 - D9 PDE - D9 - D16				



GASKET		65344	1542104	1476506 1401982
	● 4 BUS			
	★ DSC12 01/02/03/05 - DC12 - DT12 - DC11 01/02/03/04/05/06/07 - D12			
	● IND. MARINE ENGINE 4			
	★ D12A/M - D12A EMS - D12M EMS - SGI12A - DC16A - D16M - D16 48A/53A			
	● IND. MARINE ENGINE 5			
	★ SG9 A280			
	● 4 TRUCK			
	★ DSC12 01/02/03/05 - DC12 - DT12 - DC11 01/02/03/04/05/06/07 - D12 - DC16			

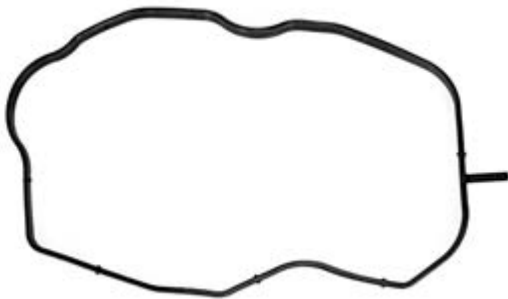



	Code	OEM new	OEM old
SEAL RING	63148	292811	
● Model			
★ Application			
● 3 BUS			
★			
● 4 BUS			
★ DSC11 - SC11 G03 - DSC9 F94 - K/L/N94 DSC9 - DSC9 - DSI9 E01 N94			
● IND. MARINE ENGINE 4			
★			
● 3 TRUCK			
★			
● 4 TRUCK			
★ DSC11 - SC11 G03 - DSC9			



	64087	1355703	
RUBBER SPACER			
● 4 BUS			
★ DC11 07 - DSC12 02			
● IND. MARINE ENGINE 4			
★ SGI 12A - DI12 41/42/43/44/45/57M - DSC12 40/42A - DC12 40/42A			
● IND. MARINE ENGINE 5			
★ SG9 A280			
● 4 TRUCK			
★ DC11 07 - DSC12 01/02			

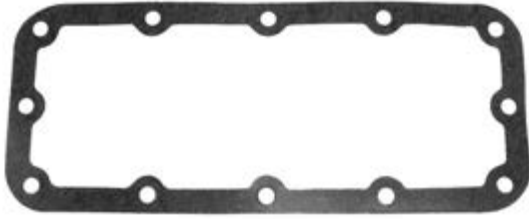



		Code	OEM new	OEM old
GASKET	● Model	61842	1392932	170694
	★ Application			
	● IND. MARINE ENGINE 4			
	★ D14A/M 1100W-500/1500W			
	● 3 TRUCK			
	★ CR/CT143 - STEAMLINE - CR143 GRS900			
	● 4 TRUCK			
	★ DSC14 13/15 - 144 CR19 - GRSH900R GSR900R DC14			

		61844	1384551	371483
GASKET	● 3 BUS			
	★			
	● 4 BUS			
	★ DSC11 - OSC11 G03			
	● IND. MARINE ENGINE 4			
	★			
	● 3 TRUCK			
	★ DS11 34/ 73/ 75 - DSC11 08/ 10/ 12/ 13/ 16/ 17/ 18/ 21/ 22/ 23/ 30/ 35/ 36/ 39/ 70 - DN11 01 - OSC11 G03 - DTC11 01/ 02 - FOR/ PER ENG 5307760 - ENG 3075634 - ENG 4070104 - ENG 5307761 - ENG 4070105 - ENG 3075635			
● 4 TRUCK				
★ DSC11 - OSC11 G03 - DSC11 ENG 4122036 - ENG 4122013 - ENG 4122014 - ENG 3193582 - ENG 4122037 - ENG 4122015 - ENG 3193583				

ALL THE COMPONENTS LISTED IN OUR CATALOGUE ARE NOT ORIGINAL, THOUGH PERFECTLY INTERCHANGEABLE. REFERENCE NUMBERS, EITHER ORIGINAL OR OF A DIFFERENT NATURE, ARE FOR INFORMATION PURPOSES ONLY. WHEN PLACING AN ORDER, PLEASE, ALWAYS USE COSIBO REFERENCE NUMBERS AND DO NOT MENTION THE ORIGINAL REFERENCE NUMBERS OF THE TRUCK MANUFACTURERS IN THE INVOICE TO VEHICLE OWNERS OR TO ANYBODY ELSE. THE CUSTOMER TAKES HIS OWN RESPONSIBILITY IF HE DOES NOT COMPLY WITH WHAT ABOVE.

		Code	OEM new	OEM old
GASKET	● Model	63114	1375383	
	★ Application			
	● 4 BUS			
	★ DC11 - D12			
	● F-K-N BUS			
	★ D11 - D12			
	● IND. MARINE ENGINE 4			
	★ DC16 - D12M EMS - DI12 68M - 69M - DC12 46A/47A/48A/50A/57A - D12A EMS - DC16 A/M - DI16 48A/53A			
	● 4 TRUCK			
	★ D16 - GRS900/920R DC16 - DC16 - D12 - DC11			
	● P-G-R-T TRUCK			
	★ D11 - D12 - D16			

		64022	1374326	
GASKET	● 4 BUS			
	★ DC11 - D12			
	● 4 TRUCK			
	★ DC11 - D12			

		65345	1392933	170696
GASKET	● IND. MARINE ENGINE 4			
	★ D14 - DSI14 69M - DI14 82M			
	● 3 TRUCK			
	★			
	● 4 TRUCK			
★ DSC14 13/15				

ALL THE COMPONENTS LISTED IN OUR CATALOGUE ARE NOT ORIGINAL, THOUGH PERFECTLY INTERCHANGEABLE. REFERENCE NUMBERS, EITHER ORIGINAL OR OF A DIFFERENT NATURE, ARE FOR INFORMATION PURPOSES ONLY. WHEN PLACING AN ORDER, PLEASE, ALWAYS USE COSIBO REFERENCE NUMBERS AND DO NOT MENTION THE ORIGINAL REFERENCE NUMBERS OF THE TRUCK MANUFACTURERS IN THE INVOICE TO VEHICLE OWNERS OR TO ANYBODY ELSE. THE CUSTOMER TAKES HIS OWN RESPONSIBILITY IF HE DOES NOT COMPLY WITH WHAT ABOVE.

SHOCK ABSORBER



- **Model**
 - ★ **Application**
- | | Code | OEM new | OEM old |
|--|--------------|---------|---------|
| | 65392 | 1502474 | |
- **4 TRUCK**
 - ★ PC/CR 14/19
- **P-G-R-T TRUCK**
 - ★ CP/19 L/N/H - CR19 L/N - CP16

ALL THE COMPONENTS LISTED IN OUR CATALOGUE ARE NOT ORIGINAL, THOUGH PERFECTLY INTERCHANGEABLE. REFERENCE NUMBERS, EITHER ORIGINAL OR OF A DIFFERENT NATURE, ARE FOR INFORMATION PURPOSES ONLY. WHEN PLACING AN ORDER, PLEASE, ALWAYS USE COSIBO REFERENCE NUMBERS AND DO NOT MENTION THE ORIGINAL REFERENCE NUMBERS OF THE TRUCK MANUFACTURERS IN THE INVOICE TO VEHICLE OWNERS OR TO ANYBODY ELSE. THE CUSTOMER TAKES HIS OWN RESPONSIBILITY IF HE DOES NOT COMPLY WITH WHAT ABOVE.

		Code	OEM new	OEM old
GASKET	● Model	60567	1388682	371487
	★ Application			
	● 3 BUS			
	★			
	● 4 BUS			
	★ DSC11 - OSC11 G03			
	● IND. MARINE ENGINE 4			
	★			
	● 3 TRUCK			
	★ DS/DSC11 - DTC11 - P113 D11 GA850/850R			
● 4 TRUCK				
★ DSC11 - OSC11 G03				





		61230	1392935	371499
GASKET	● IND. MARINE ENGINE 4			
	★			
	● 3 TRUCK			
	★			
	● 4 TRUCK			
	★ DSC14 13/15			



ALL THE COMPONENTS LISTED IN OUR CATALOGUE ARE NOT ORIGINAL, THOUGH PERFECTLY INTERCHANGEABLE. REFERENCE NUMBERS, EITHER ORIGINAL OR OF A DIFFERENT NATURE, ARE FOR INFORMATION PURPOSES ONLY. WHEN PLACING AN ORDER, PLEASE, ALWAYS USE COSIBO REFERENCE NUMBERS AND DO NOT MENTION THE ORIGINAL REFERENCE NUMBERS OF THE TRUCK MANUFACTURERS IN THE INVOICE TO VEHICLE OWNERS OR TO ANYBODY ELSE. THE CUSTOMER TAKES HIS OWN RESPONSIBILITY IF HE DOES NOT COMPLY WITH WHAT ABOVE.

		Code	OEM new	OEM old
OIL SEAL 35x62x7	<ul style="list-style-type: none"> ● Model ★ Application 	61023	1109870	310951
		<ul style="list-style-type: none"> ● 3 TRUCK ★ DS11 34/73/75 - DSC11 08/10/12/13/16/17/18/21/23/30/35/36/39/70 - DN11 01 - DTC11 01/02 		
		<ul style="list-style-type: none"> ● 4 TRUCK ★ OSC11 G03 		
		<ul style="list-style-type: none"> ● 3 BUS ★ DS11 34/74/75/78 - DSC11 04/08/17/18/21/22/23/24/27/35/36/70/71 - DSI11 - DSI11 E01 - OSC11 G01 		
		<ul style="list-style-type: none"> ● 4 BUS ★ OSC9 G01 		

		61219	369478	366303
OIL SEAL 130x160x13				
		<ul style="list-style-type: none"> ● 3 BUS ★ 		
		<ul style="list-style-type: none"> ● 4 BUS ★ DSC9 - DS19 E01 - DC9 01/ 02/ 03/ 04/ 05/ 06 - OSC9 G01 - DSC11 - OSC11 G03 - OSC9 G91 		
		<ul style="list-style-type: none"> ● IND. MARINE ENGINE 4 ★ SG9 A280 - DSC9 - DC9 A/ M 		
		<ul style="list-style-type: none"> ● 3 TRUCK ★ DS - DSC11 - DTC11 - P93 D9:GA750/ 850R - P113 D11:GA850/ 850R 		
		<ul style="list-style-type: none"> ● 4 TRUCK ★ DSC9 - DS19 E01 - DC9 01/ 02/ 03/ 04/ 05/ 06 - OSC9 G01 - DSC11 - OSC11 G03 - DSC14 13/ 15 		

ALL THE COMPONENTS LISTED IN OUR CATALOGUE ARE NOT ORIGINAL, THOUGH PERFECTLY INTERCHANGEABLE. REFERENCE NUMBERS, EITHER ORIGINAL OR OF A DIFFERENT NATURE, ARE FOR INFORMATION PURPOSES ONLY. WHEN PLACING AN ORDER, PLEASE, ALWAYS USE COSIBO REFERENCE NUMBERS AND DO NOT MENTION THE ORIGINAL REFERENCE NUMBERS OF THE TRUCK MANUFACTURERS IN THE INVOICE TO VEHICLE OWNERS OR TO ANYBODY ELSE. THE CUSTOMER TAKES HIS OWN RESPONSIBILITY IF HE DOES NOT COMPLY WITH WHAT ABOVE.

		Code	OEM new	OEM old
OIL SEAL 175x155x13	<ul style="list-style-type: none"> ● Model ★ Application 	63767	1433183	1375002
<ul style="list-style-type: none"> ● 4 BUS 				
<ul style="list-style-type: none"> ★ DC9 19/ 20/ 21 - DC11/ DSC12 03/ 05/ DC12 - DC11/ D12 - DSC12 02 				
<ul style="list-style-type: none"> ● F-K-N BUS 				
<ul style="list-style-type: none"> ★ D9/ D12 K/ N - F 				
<ul style="list-style-type: none"> ● IND. MARINE ENGINE 4 				
<ul style="list-style-type: none"> ★ DC16 - DI12 68M/D12A EMS - ENG 6516259 - ENG 6516260 - 6517506 - DI12 49A/DC12 54A/57A ENG 6516260 - 6517600 - D12M EMS ENG 6516259 - ENG 6516260 - 6517506 - DC12A/DI12M ENG 6516259 - ENG 6516260 - ENG 8710777 - DC16A ENG 6500001 - 6513503 - ENG 1051599 - 1060948 - ENG 1018690 - 1051598 - ENG 1061165 - ENG 1060949 - 1067699 - DI16 40/41A - DI16 48A/53A ENG 1060948 - ENG 1060949 - 1068481 - D16M ENG 6500001 - 6516259 - ENG 6516260 - 6513510 - ENG 1039758 - 1060948 - ENG 1061165 - ENG 1060949 - 1067699 				
<ul style="list-style-type: none"> ● IND. MARINE ENGINE 5 				
<ul style="list-style-type: none"> ★ DC9A EMS - SG9 A280 				
<ul style="list-style-type: none"> ● 4 TRUCK 				
<ul style="list-style-type: none"> ★ DC9 19/20/21 - DC11/DSC12 03/05/ DC12 ENG 6123709 - ENG 8005739 - ENG 6125027 - 6130334 - ENG 6123710 - 6125026 - ENG 8005740 - ENG 6130335 - DC11/D12 ENG 6119599 - ENG 8004779 - ENG 6119600 - ENG 8004780 - DC16 - DSC12 01/02 ENG 6123709 - ENG 8005739 - ENG 6125027 - 6130334 - ENG 6123710 - 6125026 - ENG 8005740 - ENG 6130335 - DT12 				
<ul style="list-style-type: none"> ● P-G-R-T TRUCK 				
<ul style="list-style-type: none"> ★ D9/ D11/ D12 - D16 				



		64263	1757903	
OIL SEAL 185X145X13				
<ul style="list-style-type: none"> ● 4 TRUCK 				
<ul style="list-style-type: none"> ★ DC16 				
<ul style="list-style-type: none"> ● F-K-N BUS 				
<ul style="list-style-type: none"> ★ D9 PDE - D12 K/N 				
<ul style="list-style-type: none"> ● IND.MARINE ENGINE 4 				
<ul style="list-style-type: none"> ★ DI12 68/69M - D12A EMS - DC12 54A - D12 A/M EMS - SGI 12A - DC16A - DI16 48A 53A - D16 M 				
<ul style="list-style-type: none"> ● IND.MARINE ENGINE 5 				
<ul style="list-style-type: none"> ★ SG9 A280 - DC9 EMS 				
<ul style="list-style-type: none"> ● P-G-R-T TRUCK 				
<ul style="list-style-type: none"> ★ D9 PDE - D11/D12 - D16 - 				



	Code	OEM new	OEM old
O-RING 114,5x3 (GREEN VITON)	60127	323790	362128
● Model			
★ Application			
● 3 BUS			
★			
● 4 BUS			
★ DC11 - D12 - DSC11 - OSC11 G03			
● F-K-N BUS			
★ D9 XPI - D9 - DC12 K/N			
● IND. MARINE ENGINE 4			
★ DC16 - DC16A - D16M - DSI14 68/69/73/74/75/78M - DC12A - DI12M - DI16 40/41/48/53A - SAE B RH/DX - SAE B - DSC9/DC9 A/M - D9M - D11M - D14A/M - DI14 82M - D12M EMS - DC9A EMS - D12A EMS			
● IND. MARINE ENGINE 5			
★ SG9 A280			
● 3 TRUCK			
★ CR/CT 143			
● 4 TRUCK			
★ DC16 - DC11 - D12 - DSC11 - OSC11 G03 - DSC14 13/15			
● P-G-R-T TRUCK			
★ D9 XPI - D13 XPI			

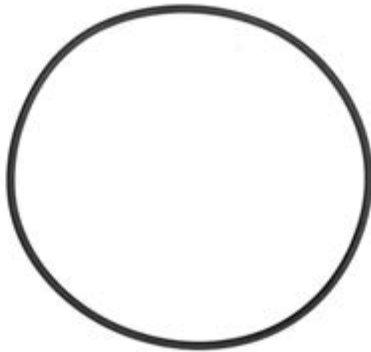



		Code	OEM new	OEM old
GASKET	● Model	60589	1388681	131180
	★ Application			287554
				374742
				385022
	● 3 BUS			
	★			DSC11 81
	● 4 BUS			
	★			DSC11 - OSC11 G03
	● IND. MARINE ENGINE 4			
	★			
	● 3 TRUCK			
	★			DS11 34/73/75 - DSC11 08/10/12/13/16/17/18/21/23/35/36 - DN11 01 - DS/DSC/DTC11 - DS/DSC11
	● 4 TRUCK			
	★			DSC11 - OSC11 G03

		65001	1388680	1305341
GASKET	● 3 BUS			
	★			DSC11 81
	● 4 BUS			
	★			DSC11 - OSC11 G03
	● IND. MARINE ENGINE 4			
	★			
	● 3 TRUCK			
	★			DS11 75 - DSC11 21/23/35/36 - DS/DSC/DTC11 - DS/DSC11
	● 4 TRUCK			
	★			DSC11 - OSC11 G03

ALL THE COMPONENTS LISTED IN OUR CATALOGUE ARE NOT ORIGINAL, THOUGH PERFECTLY INTERCHANGEABLE. REFERENCE NUMBERS, EITHER ORIGINAL OR OF A DIFFERENT NATURE, ARE FOR INFORMATION PURPOSES ONLY. WHEN PLACING AN ORDER, PLEASE, ALWAYS USE COSIBO REFERENCE NUMBERS AND DO NOT MENTION THE ORIGINAL REFERENCE NUMBERS OF THE TRUCK MANUFACTURERS IN THE INVOICE TO VEHICLE OWNERS OR TO ANYBODY ELSE. THE CUSTOMER TAKES HIS OWN RESPONSIBILITY IF HE DOES NOT COMPLY WITH WHAT ABOVE.

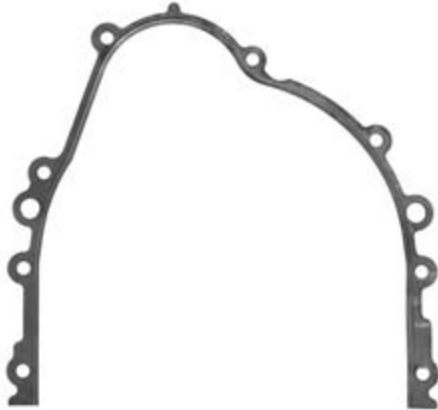
		Code	OEM new	OEM old
GASKET	● Model	65352	1896605	1403129
	★ Application			
	● 4 BUS			
	★	DC11 - D12 - K94 DC9 19/20/21		
	● F-K-N BUS			
	★	K/N		
	● IND. MARINE ENGINE 4			
	★	DC12 50A/57A		
	● IND. MARINE ENGINE 5			
	★	SG9 A280 - DC9A EMS		
● 4 TRUCK				
★	DC11 - D12 - DSC12 01/02/03/05 - DC9 19/20/21 - DC12 - DT12			
● P-G-R-T TRUCK				
★	D9 PDE - D11 - D12			



OIL SEAL 80x100x12,75		63140	369477	372773
	● 3 BUS			
	★	DSC11 81		
	● 4 BUS			
	★	DSC9 - DC9 01/ 02/ 03/ 04/ 05/ 06 - DS19 E01 - OSC9 G01 - DSC11 - OSC11 G03		
	● IND. MARINE ENGINE 4			
	★	SG9 A280 - DSC9 - DC9 A/ M		
	● 3 TRUCK			
	★	FOR CH 5118341 - CH 4021349 - DS11 73/34 75 - DSC11 08/10/12/13/16/17/18/21/23/35/36 - DN11 01 - ENG 5324679 - DS/DSC/DTC11 ENG 5324679 - ENG 4085804 - DS/DSC11 CH 5324679 - CH 4085804 - FOR ENG 5118341 - ENG 4021349 - ENG 5307760 - ENG 3075634 - ENG 4070104 - ENG 5307761 - ENG 4070105 - ENG 3075635		
	● 4 TRUCK			
	★	DSC11 - OSC11 G03 - DSC9 - DC9 01/ 02/ 03/ 04/ 05/ 06 - DSC14 13/ 15 - DS19 E01 - OSC9 G01		

ALL THE COMPONENTS LISTED IN OUR CATALOGUE ARE NOT ORIGINAL, THOUGH PERFECTLY INTERCHANGEABLE. REFERENCE NUMBERS, EITHER ORIGINAL OR OF A DIFFERENT NATURE, ARE FOR INFORMATION PURPOSES ONLY. WHEN PLACING AN ORDER, PLEASE, ALWAYS USE COSIBO REFERENCE NUMBERS AND DO NOT MENTION THE ORIGINAL REFERENCE NUMBERS OF THE TRUCK MANUFACTURERS IN THE INVOICE TO VEHICLE OWNERS OR TO ANYBODY ELSE. THE CUSTOMER TAKES HIS OWN RESPONSIBILITY IF HE DOES NOT COMPLY WITH WHAT ABOVE.

OIL SEAL 140x118x12



	Code	OEM new	OEM old
● Model ★ Application	64351	1392708	
● 4 BUS			
★ DC11/ D12			
● F-K-N BUS			
★ K/ N			
● IND. MARINE ENGINE 4			
★ DI12 68/ 69M - DC12 50A - DC12 57A - DC16A - DI16 40/ 41A 48A 53A - D16M - DC16			
● IND. MARINE ENGINE 5			
★ SG9 A280 - DC9A EMS			
● 4 TRUCK			
★ DC16 - DSC12 01/ 02 - DC9 19/ 20/ 21 - DC11 - DSC12 03/ 05 - DC12 - DT12 - DC11/ D12			
● P-G-R-T TRUCK			
★ D9 PDE - D11 - D12 - D16			

OIL SEAL 80x100x12



	Code	OEM new	OEM old
	61026	338643	275591
● 3 BUS			
★ ENG 5324678 - ENG 5118340			
● 3 TRUCK			
★ DS11 34/73/75 - DSC11 08/10/12/13/16/17/18/21/23/35/36 - DN11 01 - DS/ DSC/DTC11			
● 4 TRUCK			
★ DSC14 13/15			

ENGINE FILTER SET



	Code	OEM new	OEM old
	62382	1486634	
● IND. MARINE ENGINE 4			
★ D16A - DC16A			
● 4 TRUCK			
★ D16 - DC16			
● P-G-R-T TRUCK			
★ D16			

ALL THE COMPONENTS LISTED IN OUR CATALOGUE ARE NOT ORIGINAL, THOUGH PERFECTLY INTERCHANGEABLE. REFERENCE NUMBERS, EITHER ORIGINAL OR OF A DIFFERENT NATURE, ARE FOR INFORMATION PURPOSES ONLY. WHEN PLACING AN ORDER, PLEASE, ALWAYS USE COSIBO REFERENCE NUMBERS AND DO NOT MENTION THE ORIGINAL REFERENCE NUMBERS OF THE TRUCK MANUFACTURERS IN THE INVOICE TO VEHICLE OWNERS OR TO ANYBODY ELSE. THE CUSTOMER TAKES HIS OWN RESPONSIBILITY IF HE DOES NOT COMPLY WITH WHAT ABOVE.

ENGINE BRAKE CYLINDER



	Code	OEM new	OEM old
● Model	61536	1332503	1348896
★ Application			
● 3 BUS			
★ N113 - DSC1108B			
● 3 TRUCK			
★ CP/CR/CT113 - CG/CP/CR/CT93 - CR/CT143 - DSC9 LHD CP/CR - DTC11 01(EDC) - DSC1122(EDC) - DSC11 - DTC11 LHD CP/CR 80dB(A) - DSC14 LHD CR - DSC14 LHD CR 80dB(A)			
● 4 TRUCK			
★ 80dB(A)144			

OIL TEMPERATURE SENSOR



	61346	374338	
● 3 BUS			
★ DS9 - DSC9			
● 4 BUS			
★ DSC9 - DC9 01/02/03/04/05/06 - DS19 E01 - OSC9 G01 - D12			
● 3 TRUCK			
★ DN9 - DS/DSC9 - DS9 4X4			
● 4 TRUCK			
★ DSC9 - DC9 01/02/03/04/05/06 - DSC12 - DC12 01/02/09			

COOLANT LEVEL SENSOR



	62223	1304725	397929
● 3 BUS			
★ N113 - F113 - K113 - F93 - K113 DSC11 22/70 EDC - K113 DSC11 21 GR801 - K113 DSC11 22/70 EDC GR801 - K113 GR801R - K93/113 - L113			
● 4 BUS			
★ N - K/L - F94 - N94UD			
● IND. MARINE ENGINE 4			
★ SG9 A208 - D9/11/14			
● IND. MARINE ENGINE 5			
★ SG9 A208			
● 3 TRUCK			
★ D9/11/14 - CG/CP/CR/CT93 - CP/CR/CT113 - CR/CT143 - CR13/19 - D11 - CR13/19 - DSC11 21/22(EDC)/23 - DTC11 - CP/CR - DSC11 21/22/23 - DTC11			

ALL THE COMPONENTS LISTED IN OUR CATALOGUE ARE NOT ORIGINAL, THOUGH PERFECTLY INTERCHANGEABLE. REFERENCE NUMBERS, EITHER ORIGINAL OR OF A DIFFERENT NATURE, ARE FOR INFORMATION PURPOSES ONLY. WHEN PLACING AN ORDER, PLEASE, ALWAYS USE COSIBO REFERENCE NUMBERS AND DO NOT MENTION THE ORIGINAL REFERENCE NUMBERS OF THE TRUCK MANUFACTURERS IN THE INVOICE TO VEHICLE OWNERS OR TO ANYBODY ELSE. THE CUSTOMER TAKES HIS OWN RESPONSIBILITY IF HE DOES NOT COMPLY WITH WHAT ABOVE.

		Code	OEM new	OEM old
OIL BULB	● Model	63152	1316331	1334704
	★ Application			
	● 3 BUS			
	★			
	● IND. MARINE ENGINE 4			
	★ D12A/M - D9M			
	● 3 TRUCK			
	★			
	● 4 TRUCK			
	★ DSC11 - DSC14 13/15			

RELAY		63447	2077837	1431781 1391322 243460
	● 3 BUS			
	★			

OIL SENSOR		63847	1452862	1393113 1488340
	● 4 BUS			
	★ DC11 D12 - DSC9 DC9 01/02/03/04/05/06 - DSC9 DSI9 E01 DC9 OSC9 G01			
	● IND. MARINE ENGINE 4			
	★ SG9 A280 - D9M			
	● 4 TRUCK			
	★ DC11 D12 - DSC9 DC9 01/02/03/04/05/06 - DSC12 DC12 01/02/09 - DSC14 13/15 - OSC11 G03 - 8X8 WLS/ZLS EXTRA			

ALL THE COMPONENTS LISTED IN OUR CATALOGUE ARE NOT ORIGINAL, THOUGH PERFECTLY INTERCHANGEABLE. REFERENCE NUMBERS, EITHER ORIGINAL OR OF A DIFFERENT NATURE, ARE FOR INFORMATION PURPOSES ONLY. WHEN PLACING AN ORDER, PLEASE, ALWAYS USE COSIBO REFERENCE NUMBERS AND DO NOT MENTION THE ORIGINAL REFERENCE NUMBERS OF THE TRUCK MANUFACTURERS IN THE INVOICE TO VEHICLE OWNERS OR TO ANYBODY ELSE. THE CUSTOMER TAKES HIS OWN RESPONSIBILITY IF HE DOES NOT COMPLY WITH WHAT ABOVE.

		Code	OEM new	OEM old
OIL BULB	● Model	63153	1316330	
	★ Application			
	● 3 BUS			
	★			
	● 3 TRUCK			
	★			
	● 4 TRUCK			
	★ DSC14 13/15 - DSC11			
	● IND. MARINE ENGINE 4			
	★			
	● 3 BUS			
	★			
	● IND. MARINE ENGINE 4			
	★			
● 3 TRUCK				
★				
● 4 TRUCK				
★ DSC14 13/15 - DSC11				



		65191	2038653	1536304 1340231 1421322
SOLENOID VALVE	● 3 BUS			
	★ N113 - DSC1108B			
	● 3 TRUCK			
	★ CP/CR/CT 113 - CG/CP/CR/CT 93 - CR/CT 143 - CP/CR DSC9 LHD - DTC11 01 (EDC) - DSC11 22(EDC) - DSC11 DTC11 LHD CP/CR 80dB(A) - DSC14 LHD CR 80dB(A)			
	● 4 TRUCK			
	★ 8X8 WLS/ZLS - 144			



ALL THE COMPONENTS LISTED IN OUR CATALOGUE ARE NOT ORIGINAL, THOUGH PERFECTLY INTERCHANGEABLE. REFERENCE NUMBERS, EITHER ORIGINAL OR OF A DIFFERENT NATURE, ARE FOR INFORMATION PURPOSES ONLY. WHEN PLACING AN ORDER, PLEASE, ALWAYS USE COSIBO REFERENCE NUMBERS AND DO NOT MENTION THE ORIGINAL REFERENCE NUMBERS OF THE TRUCK MANUFACTURERS IN THE INVOICE TO VEHICLE OWNERS OR TO ANYBODY ELSE. THE CUSTOMER TAKES HIS OWN RESPONSIBILITY IF HE DOES NOT COMPLY WITH WHAT ABOVE.

		Code	OEM new	OEM old
EGR VALVE	● Model	65485	1748892	1513440
	★ Application			
	● F-K-N BUS			
	★ D9 PDE - DC12 - DT12			
	● P-G-R-T TRUCK			
	★ D9 PDE - DC12 - DT12			
● F-K-N BUS				
★				
● P-G-R-T TRUCK				
★				



		64806	1378541	
SOLENOID VALVE	● 3 BUS			
	★ DSC11 81			
	● 4 BUS			
	★ DSC9			
	● IND.MARINE ENGINE 4			
	★ DS9 A - DSC9 A - D12 EMS - DI12 49A - DC12 57A - DSI14			
● 4 TRUCK				
★ DSC9 - DSC11 79				



ALL THE COMPONENTS LISTED IN OUR CATALOGUE ARE NOT ORIGINAL, THOUGH PERFECTLY INTERCHANGEABLE. REFERENCE NUMBERS, EITHER ORIGINAL OR OF A DIFFERENT NATURE, ARE FOR INFORMATION PURPOSES ONLY. WHEN PLACING AN ORDER, PLEASE, ALWAYS USE COSIBO REFERENCE NUMBERS AND DO NOT MENTION THE ORIGINAL REFERENCE NUMBERS OF THE TRUCK MANUFACTURERS IN THE INVOICE TO VEHICLE OWNERS OR TO ANYBODY ELSE. THE CUSTOMER TAKES HIS OWN RESPONSIBILITY IF HE DOES NOT COMPLY WITH WHAT ABOVE.

	Code	OEM new	OEM old
GASKET	60058	385998	235178 277273
● Model			
★ Application			
● 3 BUS			
★ OSC11 G01			
● IND. MARINE ENGINE 4			
★ DS/ DSC/ DSI 11A			
● 3 TRUCK			
★ DN11 01 - DS/ DSC11 - DS 73/ DSC11 12			
● 4 TRUCK			
★ DS11 73 - DSC11 12			







	Code	OEM new	OEM old
GASKET	61485	387775	303419
● 3 TRUCK			
★			





	Code	OEM new	OEM old
GASKET	60059	385997	235177 277272
● 3 BUS			
★ OSC11 G01			
● IND. MARINE ENGINE 4			
★ DS/DSC/DSI 11A			
● 3 TRUCK			
★ DN11 01 - DS/DSC11 - DS 73/DSC11 12			
● 4 TRUCK			
★ DS11 73 - DSC11 12			



		Code	OEM new	OEM old
GASKET		60566	139616	
	<ul style="list-style-type: none"> ● Model ★ Application 			
	<ul style="list-style-type: none"> ● 3 BUS ★ OSC11 G01 			
	<ul style="list-style-type: none"> ● IND. MARINE ENGINE 4 ★ DSC14 			
	<ul style="list-style-type: none"> ● 3 TRUCK ★ DS/DSC11 - DS11 73 - DSC11 12 - DSC14 03/04/06/08/09/10/16 			
	<ul style="list-style-type: none"> ● 4 TRUCK ★ DSC14 - OSC11 G03 - DSC14 13/15 			
GASKET		61490	365863	
	<ul style="list-style-type: none"> ● Model ★ Application 			
	<ul style="list-style-type: none"> ● 3 BUS ★ DS11 74/78 - DSC11 08/21/71 - DSH1 E01 - OSC11 G01 			
	<ul style="list-style-type: none"> ● 3 TRUCK ★ DS/DSC11 - DS11 34/75 - DTC11 			
	<ul style="list-style-type: none"> ● IND. MARINE ENGINE 4 ★ D16 M - DC9/DSC9 A/M - DI12 41/59/62/64/65/70M - DSC9 47A - DS/DSC11 			
GASKET		61486	364792	
	<ul style="list-style-type: none"> ● Model ★ Application 			
	<ul style="list-style-type: none"> ● 3 BUS ★ 			
	<ul style="list-style-type: none"> ● 3 TRUCK ★ DN9 - DS9 4X4 			
GASKET		61490/1	222499	
	<ul style="list-style-type: none"> ● Model ★ Application 			
	<ul style="list-style-type: none"> ● 3 TRUCK ★ DS/DSC11 - DS11 73 - DSC11 12 - DSC14 03/04/06/08/09/10/16 			
	<ul style="list-style-type: none"> ● 4 TRUCK ★ OSC11 G03 			
	<ul style="list-style-type: none"> ● IND. MARINE ENGINE 4 ★ DC16 46A 			

ALL THE COMPONENTS LISTED IN OUR CATALOGUE ARE NOT ORIGINAL, THOUGH PERFECTLY INTERCHANGEABLE. REFERENCE NUMBERS, EITHER ORIGINAL OR OF A DIFFERENT NATURE, ARE FOR INFORMATION PURPOSES ONLY. WHEN PLACING AN ORDER, PLEASE, ALWAYS USE COSIBO REFERENCE NUMBERS AND DO NOT MENTION THE ORIGINAL REFERENCE NUMBERS OF THE TRUCK MANUFACTURERS IN THE INVOICE TO VEHICLE OWNERS OR TO ANYBODY ELSE. THE CUSTOMER TAKES HIS OWN RESPONSIBILITY IF HE DOES NOT COMPLY WITH WHAT ABOVE.

		Code	OEM new	OEM old
GASKET		61487	364791	
	<ul style="list-style-type: none"> ● Model ★ Application 			
	<ul style="list-style-type: none"> ● 3 BUS ★ 			
	<ul style="list-style-type: none"> ● 3 TRUCK ★ DN9 - DS9 4X4 - DS/DSC9 			
	<ul style="list-style-type: none"> ● IND. MARINE ENGINE 4 ★ D9 M - DS19 - DI9 56A - DSI/DI9 - DSC9 - DC9 A/M 			
GASKET		61484	369276	170363
	<ul style="list-style-type: none"> ● IND. MARINE ENGINE 4 ★ D14 A/M - DSI14 68/69/73/74/75/78 M 			
	<ul style="list-style-type: none"> ● 3 TRUCK ★ DSC14 03/04/06/08/09/10/16 			
	<ul style="list-style-type: none"> ● 4 TRUCK ★ DSC14 13/15 			
GASKET		61553	1320292	371491
	<ul style="list-style-type: none"> ● 3 BUS ★ D11 - DS11 - DSC11 08/17/18/21/22/23/35/36/70 - DSC11 			
	<ul style="list-style-type: none"> ● 4 BUS ★ DSC11 - OSC11 G03 			
	<ul style="list-style-type: none"> ● IND. MARINE ENGINE 4 ★ D11 - DI12 68M/69M - D12 A/M - DC12 57A - D12 49A - D9 A/M - DS11 95 A46S - DSC9 A/M - D14 A/M - SG9 A280 - DSC9 - DC9 A/M 			
	<ul style="list-style-type: none"> ● 3 TRUCK ★ LHD/RHD - STREAMLINE RHD 			
	<ul style="list-style-type: none"> ● 4 TRUCK ★ DSC14 13/15 - DSC11 - OSC11 G03 - DSC9 - DC9 01/02/03/04/05/06 			

ALL THE COMPONENTS LISTED IN OUR CATALOGUE ARE NOT ORIGINAL, THOUGH PERFECTLY INTERCHANGEABLE. REFERENCE NUMBERS, EITHER ORIGINAL OR OF A DIFFERENT NATURE, ARE FOR INFORMATION PURPOSES ONLY. WHEN PLACING AN ORDER, PLEASE, ALWAYS USE COSIBO REFERENCE NUMBERS AND DO NOT MENTION THE ORIGINAL REFERENCE NUMBERS OF THE TRUCK MANUFACTURERS IN THE INVOICE TO VEHICLE OWNERS OR TO ANYBODY ELSE. THE CUSTOMER TAKES HIS OWN RESPONSIBILITY IF HE DOES NOT COMPLY WITH WHAT ABOVE.

		Code	OEM new	OEM old
GASKET	● Model	61835	378264	
	★ Application			
	● 3 BUS			
	★	DS11 74/78 - DSC11 04/24/27/71 - DSI11 E01 - DS/DSC11		
	● 4 BUS			
	★	DSC11 - OSC11 G03		
	● IND. MARINE ENGINE 4			
	★	DS/DSI 11 - DS/DSC/DSI 11A		
	● 3 TRUCK			
	★	DS/DSC/DTC11 - DS11 34/75		
● 4 TRUCK				
★	DSC11 - OSC11 G03			



		61836	1109288	
GASKET	● 3 BUS			
	★	DS11 74/78 - DSC11 04/24/27/71 - DSI11 E01 - DS/DSC11		
	● 4 BUS			
	★	DSC11 - OSC11 G03		
	● IND. MARINE ENGINE 4			
	★	DS/DSI 11 - DS/DSC/DSI 11A		
	● 3 TRUCK			
	★	DS/DSC/DTC11 - DS11 34/75		
	● 4 TRUCK			
	★	DSC11 - OSC11 G03		



		Code	OEM new	OEM old
GASKET	● Model	61838	1801737	1323354 1393937
	★ Application			
	● 3 BUS			
	★	DS11 74/78 - DSC11 04/08/21/24/27/71 - DS11 E01 - DS/DSC 11 - OSC11 G01		
	● 4 BUS			
	★	DSC9 - DS19 E01 - DC9 01/02/03/04/05/06 - OSC9 G01 - DC 11 - D 12 - DSC11 - OSC11 G03 - DSC9 - OSC9 - DS19 - L/N/K 94 - D9 F94		
	● F-K-N BUS			
	★	D 11/12 - D9 PDE EGR - D9 XPI		
	● IND. MARINE ENGINE 4			
	★	DC 11 - D 12 - DC9 51/53/54/55 A - SG9 A280 - D9 - DC9 - DSC9 A/M - DI16 40/41/48/53 A -		
● 3 TRUCK				
★	DN9 - DS9 4X4 - DS/DSC 9/11 - DS11 34/75 - DTC 11			
● 4 TRUCK				
★	DC - DSC 9/11/12 - DC9 01/02/03/04/05/06 - DC12 4X4/6X6/8X8 - DT 12 - DC11 4X4/6X6 - DS19 E01 - OSC9 G01 - D 12 - OSC11 G03 - DSC9 - OSC9 - DS19			
● P-G-R-T TRUCK				
★	D 11/12 - D9 PDE EGR - D9 XPI			



		63862	1746684	1392459
GASKET	● 3 TRUCK			
	★	DSC14		
	● 4 TRUCK			
	★	DSC14 13/15		
	● IND. MARINE ENGINE 4			
	★	DS14 - DSC14 - D14 A/M		



		Code	OEM new	OEM old
GASKET	● Model	63547	1309051	
	★ Application			
	● 4 BUS			
	★	DC 11/12 - DC9 20/21 - DSC12 01/02/03/05 - DC11 01/02/03/04/06/07 - DT12 - D12		
	● F-K-N BUS			
	★	D 9/11/12/16 - D9 PDE EGR - D9 F		
	● IND. MARINE ENGINE 4			
	★	DSC/DC 12 A - DSI/DI 12 A - DI 12 M - D12A/M EMS - DI 12 68/69M - DC12 54A - DC16 A - DI16 40/41/48/53 A - D16 M - D12 A/M - DC16		
	● IND. MARINE ENGINE 5			
	★	SGNA280 - DC9A EMS - DC9 69A		
● 4 TRUCK				
★	DC 11/12/16 - DSC12 - DC12 4X4/6X6/8X8 - DC11 4X4/6X6 - DT12 - DC9 20/21 - DSC12 01/02/03/05 - DC11 01/02/03/04/06/07 - DT12			
● P-G-R-T TRUCK				
★	D 9/11/12/16 - D 9/16 - D9 PDE EGR			



		63863	390918	
GASKET	● IND. MARINE ENGINE 4			
	★	D14 A/M		
	● 4 TRUCK			
	★	DSC14 13/15		



		64278	1336138	1485685
GASKET	● 4 BUS			
	★	DSC9 - DSI9 E01 - DC9 01/02/03/04/05/06 - OSC9 G01 - OSC9 - DSI9 - L/N/K94 - D9 F94		
	● IND. MARINE ENGINE 4			
	★	DC9 51/53/54/55 A - SG9 A280 - D9A/M		
	● 4 TRUCK			
★	DSC9 - DSI9 E01 - DC9 01/02/03/04/05/06 - OSC9 G01 - OSC9 - DSI9			



	Code	OEM new	OEM old
OIL SUMP GASKET SET	60570	551438	
<ul style="list-style-type: none"> ● Model ★ Application 			
<ul style="list-style-type: none"> ● 3 TRUCK ★ 			

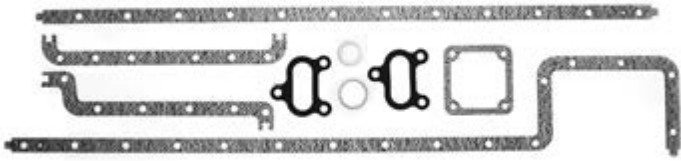

GASKET	61554	388402	
<ul style="list-style-type: none"> ● 3 TRUCK ★ 			



OIL SUMP GASKET	60569	1459004	371505
<ul style="list-style-type: none"> ● IND. MARINE ENGINE 4 ★ D14 A/M 			
<ul style="list-style-type: none"> ● 3 TRUCK ★ 			
<ul style="list-style-type: none"> ● 4 TRUCK ★ DSC14 13/15 			



ALL THE COMPONENTS LISTED IN OUR CATALOGUE ARE NOT ORIGINAL, THOUGH PERFECTLY INTERCHANGEABLE. REFERENCE NUMBERS, EITHER ORIGINAL OR OF A DIFFERENT NATURE, ARE FOR INFORMATION PURPOSES ONLY. WHEN PLACING AN ORDER, PLEASE, ALWAYS USE COSIBO REFERENCE NUMBERS AND DO NOT MENTION THE ORIGINAL REFERENCE NUMBERS OF THE TRUCK MANUFACTURERS IN THE INVOICE TO VEHICLE OWNERS OR TO ANYBODY ELSE. THE CUSTOMER TAKES HIS OWN RESPONSIBILITY IF HE DOES NOT COMPLY WITH WHAT ABOVE.

		Code	OEM new	OEM old
OIL SUMP GASKET	● Model	61552	1412666	366539
	★ Application			
	● 3 BUS			
	★			
	● 4 BUS			
	★	DSC9 - DS19 E01 - DC9 01/02/03/04/05/06 - OSC9 G01 - DC9 - K94 DSC9 - K/L/N94 DSC9-DS19 E01-DC9-OSC9 G01		
	● IND. MARINE ENGINE 4			
	★	DSC9 A/M - SG9 A280 - DSC9/DC9 A/M		
	● 3 TRUCK			
	★			
	● 4 TRUCK			
	★	DSC9 - DS19 E01 - DC9 01/02/03/04/05/06 - OSC9 G01		

		63120	1865675	1460362 1744775
OIL SUMP GASKET	● IND. MARINE ENGINE 4			
	★	DC16 - DC16A - DI16 40A/41A/48A/53A - D16M - D16 A/M		
	● 4 TRUCK			
	★	DC16		
	● P-G-R-T TRUCK			
	★	D16		

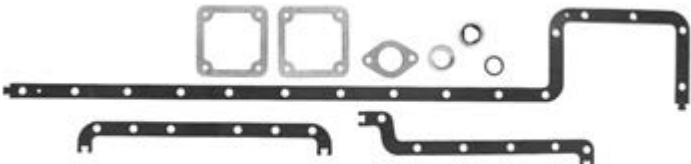
		60758	551365	
OIL SUMP GASKET SET	● IND. MARINE ENGINE 4			
	★	D14 A/M		
	● 4 TRUCK			
	★	DSC14 13/15 - CR/CT 144 DSC14 13/05		

ALL THE COMPONENTS LISTED IN OUR CATALOGUE ARE NOT ORIGINAL, THOUGH PERFECTLY INTERCHANGEABLE. REFERENCE NUMBERS, EITHER ORIGINAL OR OF A DIFFERENT NATURE, ARE FOR INFORMATION PURPOSES ONLY. WHEN PLACING AN ORDER, PLEASE, ALWAYS USE COSIBO REFERENCE NUMBERS AND DO NOT MENTION THE ORIGINAL REFERENCE NUMBERS OF THE TRUCK MANUFACTURERS IN THE INVOICE TO VEHICLE OWNERS OR TO ANYBODY ELSE. THE CUSTOMER TAKES HIS OWN RESPONSIBILITY IF HE DOES NOT COMPLY WITH WHAT ABOVE.

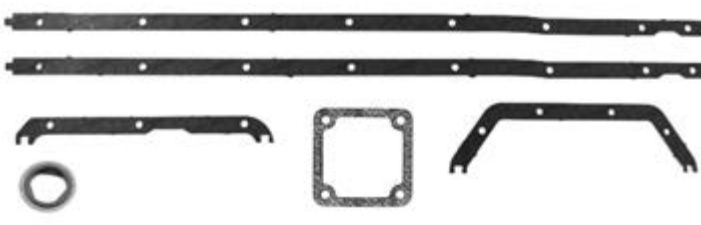
		Code	OEM new	OEM old
OIL SUMP GASKET SET 	● Model	61832	551450	550231
	★ Application			
	● 3 BUS			
	★			
	● 4 BUS			
	★	DSC9 - DS19 E01 - DC9 - OSC9 G01		
	● IND. MARINE ENGINE 4			
	★	D9 A/M - SG9 A280 - DSC9 A/M		
	● 3 TRUCK			
	★			
● 4 TRUCK				
★	DSC9 - DC9 01/02/03/04/05/06			

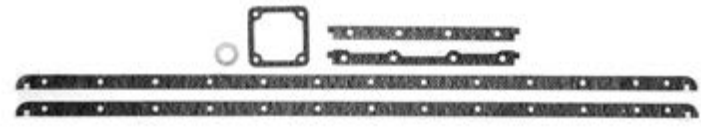
		61833	550343	551466
OIL SUMP GASKET SET 	● 3 BUS			
	★	D11		
	● IND. MARINE ENGINE 4			
	★	D11		
	● 3 TRUCK			
	★			
	● 4 TRUCK			
	★	DSC11 - OSC11 G03 - CP/CR DSC11/OSC11 - DSC11 CT		

		63064	551351	
OIL SUMP GASKET SET 	● 4 BUS			
	★	DC11 - D12		
	● 4 TRUCK			
	★	DC11 - D12		

ALL THE COMPONENTS LISTED IN OUR CATALOGUE ARE NOT ORIGINAL, THOUGH PERFECTLY INTERCHANGEABLE. REFERENCE NUMBERS, EITHER ORIGINAL OR OF A DIFFERENT NATURE, ARE FOR INFORMATION PURPOSES ONLY. WHEN PLACING AN ORDER, PLEASE, ALWAYS USE COSIBO REFERENCE NUMBERS AND DO NOT MENTION THE ORIGINAL REFERENCE NUMBERS OF THE TRUCK MANUFACTURERS IN THE INVOICE TO VEHICLE OWNERS OR TO ANYBODY ELSE. THE CUSTOMER TAKES HIS OWN RESPONSIBILITY IF HE DOES NOT COMPLY WITH WHAT ABOVE.

	Code	OEM new	OEM old
OIL SUMP GASKET	65370	1865674	1744774
● Model			
★ Application			
● 4 TRUCK			
★ DC11 - D12			
● P-G-R-T TRUCK			
★ D11 - D12			
● 4 BUS			
★ DC11 - D12			
● IND. MARINE ENGINE 4			
★ DC12 50A			
● F-K-N BUS			
★ D12 K			

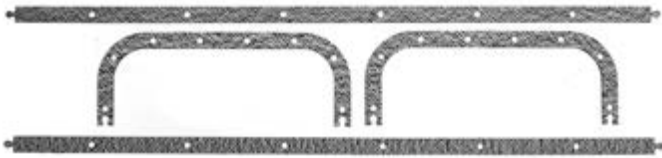

	62259/1	62259/1	
EXHAUST MANIFOLD SET W/RINGS			
● IND. MARINE ENGINE 4			
★ D14A			
● 3 TRUCK			
★ DSC14 08/09/10/16			

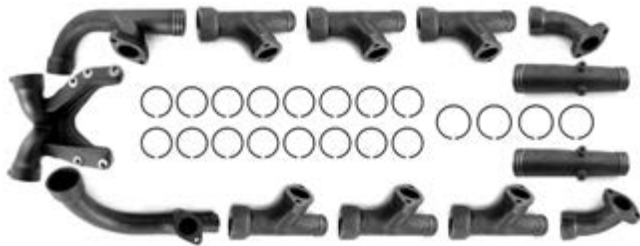

	65275	371211	
EXHAUST MANIFOLD			
● IND. MARINE ENGINE 4			
★ D14A			
● 3 TRUCK			
★ DSC14 08/09/10/16			



ALL THE COMPONENTS LISTED IN OUR CATALOGUE ARE NOT ORIGINAL, THOUGH PERFECTLY INTERCHANGEABLE. REFERENCE NUMBERS, EITHER ORIGINAL OR OF A DIFFERENT NATURE, ARE FOR INFORMATION PURPOSES ONLY. WHEN PLACING AN ORDER, PLEASE, ALWAYS USE COSIBO REFERENCE NUMBERS AND DO NOT MENTION THE ORIGINAL REFERENCE NUMBERS OF THE TRUCK MANUFACTURERS IN THE INVOICE TO VEHICLE OWNERS OR TO ANYBODY ELSE. THE CUSTOMER TAKES HIS OWN RESPONSIBILITY IF HE DOES NOT COMPLY WITH WHAT ABOVE.

		Code	OEM new	OEM old
EXHAUST MANIFOLD	● Model	63408	1332967	
	★ Application			
	● IND. MARINE ENGINE 4			
	★ D14A			
● 3 TRUCK				
★ DSC14 08/09/10/16				



EXHAUST MANIFOLD		63409	1332968	
	● IND. MARINE ENGINE 4			
	★ D14A			
	● 3 TRUCK			
★ DSC14 08/09/10/16				



EXHAUST MANIFOLD		63410	1332969	
	● IND. MARINE ENGINE 4			
	★ D14A			
	● 3 TRUCK			
★ DSC14 08/09/10/16				



RH EXHAUST MANIFOLD		63411	1332970	
	● IND. MARINE ENGINE 4			
	★ D14A			
	● 3 TRUCK			
★ DSC14 08/09/10/16				



ALL THE COMPONENTS LISTED IN OUR CATALOGUE ARE NOT ORIGINAL, THOUGH PERFECTLY INTERCHANGEABLE. REFERENCE NUMBERS, EITHER ORIGINAL OR OF A DIFFERENT NATURE, ARE FOR INFORMATION PURPOSES ONLY. WHEN PLACING AN ORDER, PLEASE, ALWAYS USE COSIBO REFERENCE NUMBERS AND DO NOT MENTION THE ORIGINAL REFERENCE NUMBERS OF THE TRUCK MANUFACTURERS IN THE INVOICE TO VEHICLE OWNERS OR TO ANYBODY ELSE. THE CUSTOMER TAKES HIS OWN RESPONSIBILITY IF HE DOES NOT COMPLY WITH WHAT ABOVE.

LH EXHAUST MANIFOLD



- Model
- ★ Application

Code	OEM new	OEM old
63412	1332971	

- **IND. MARINE ENGINE 4**

- ★ D14A

- **3 TRUCK**

- ★ DSC14 08/09/10/16

EXHAUST MANIFOLD SET W/RINGS



- **4 TRUCK**

- ★ DSC14 13/15

63777	63777	
--------------	-------	--

EXHAUST MANIFOLD



- **4 TRUCK**

- ★ DSC14 13/15

63780	1354420	
--------------	---------	--

ALL THE COMPONENTS LISTED IN OUR CATALOGUE ARE NOT ORIGINAL, THOUGH PERFECTLY INTERCHANGEABLE. REFERENCE NUMBERS, EITHER ORIGINAL OR OF A DIFFERENT NATURE, ARE FOR INFORMATION PURPOSES ONLY. WHEN PLACING AN ORDER, PLEASE, ALWAYS USE COSIBO REFERENCE NUMBERS AND DO NOT MENTION THE ORIGINAL REFERENCE NUMBERS OF THE TRUCK MANUFACTURERS IN THE INVOICE TO VEHICLE OWNERS OR TO ANYBODY ELSE. THE CUSTOMER TAKES HIS OWN RESPONSIBILITY IF HE DOES NOT COMPLY WITH WHAT ABOVE.

	Code	OEM new	OEM old
LH EXHAUST MANIFOLD 	63781	1340899	
<ul style="list-style-type: none"> ● Model ★ Application 			
<ul style="list-style-type: none"> ● 4 TRUCK ★ DSC14 13/15 			
RH EXHAUST MANIFOLD 	63782	1354428	
<ul style="list-style-type: none"> ● 4 TRUCK ★ DSC14 13/15 			
EXHAUST MANIFOLD 	63784	1422198	1354423
<ul style="list-style-type: none"> ● 4 TRUCK ★ DSC14 13/15 			
EXHAUST MANIFOLD 	63785	1422200	1354424
<ul style="list-style-type: none"> ● 4 TRUCK ★ DSC14 13/15 			
LH/RH EXHAUST MANIFOLD 	63783	1355353	
<ul style="list-style-type: none"> ● 4 TRUCK ★ DSC14 13/15 			

ALL THE COMPONENTS LISTED IN OUR CATALOGUE ARE NOT ORIGINAL, THOUGH PERFECTLY INTERCHANGEABLE. REFERENCE NUMBERS, EITHER ORIGINAL OR OF A DIFFERENT NATURE, ARE FOR INFORMATION PURPOSES ONLY. WHEN PLACING AN ORDER, PLEASE, ALWAYS USE COSIBO REFERENCE NUMBERS AND DO NOT MENTION THE ORIGINAL REFERENCE NUMBERS OF THE TRUCK MANUFACTURERS IN THE INVOICE TO VEHICLE OWNERS OR TO ANYBODY ELSE. THE CUSTOMER TAKES HIS OWN RESPONSIBILITY IF HE DOES NOT COMPLY WITH WHAT ABOVE.

	Code	OEM new	OEM old
EXHAUST MANIFOLD SET W/RINGS	63925	63925	
<ul style="list-style-type: none"> ● Model ★ Application 			
<ul style="list-style-type: none"> ● IND. MARINE ENGINE 4 ★ DC16A 			
<ul style="list-style-type: none"> ● 4 TRUCK ★ DC16 			
<ul style="list-style-type: none"> ● P-G-R-T TRUCK ★ D16 			



GASKET	64757	1801736	1424924
<ul style="list-style-type: none"> ● 4 TRUCK ★ DC16 			
<ul style="list-style-type: none"> ● P-G-R-T TRUCK ★ D16 			
<ul style="list-style-type: none"> ● IND.MARINE ENGINE 4 ★ DC16 - DC16 A 			





GASKET	65481	1936370	
<ul style="list-style-type: none"> ● 4 TRUCK ★ DC16 			
<ul style="list-style-type: none"> ● IND.MARINE ENGINE 4 ★ DC16A 			
<ul style="list-style-type: none"> ● P-G-R-T TRUCK ★ D16 			



ALL THE COMPONENTS LISTED IN OUR CATALOGUE ARE NOT ORIGINAL, THOUGH PERFECTLY INTERCHANGEABLE. REFERENCE NUMBERS, EITHER ORIGINAL OR OF A DIFFERENT NATURE, ARE FOR INFORMATION PURPOSES ONLY. WHEN PLACING AN ORDER, PLEASE, ALWAYS USE COSIBO REFERENCE NUMBERS AND DO NOT MENTION THE ORIGINAL REFERENCE NUMBERS OF THE TRUCK MANUFACTURERS IN THE INVOICE TO VEHICLE OWNERS OR TO ANYBODY ELSE. THE CUSTOMER TAKES HIS OWN RESPONSIBILITY IF HE DOES NOT COMPLY WITH WHAT ABOVE.

		Code	OEM new	OEM old
EXHAUST MANIFOLD	● Model	63919	1928759	1520700 1793582 1863896
	★ Application			
	● IND. MARINE ENGINE 4			
	★ DC16A			
	● 4 TRUCK			
	★ DC16			
	● P-G-R-T TRUCK			
	★ D16			

EXHAUST MANIFOLD	63920	1928762	1381069 1541367
	● IND. MARINE ENGINE 4		
	★ DC16A		
	● 4 TRUCK		
	★ DC16		
	● P-G-R-T TRUCK		
	★ D16		

EXHAUST MANIFOLD	63921	1928763	1381070 1541368
	● IND. MARINE ENGINE 4		
	★ DC16A		
	● 4 TRUCK		
	★ DC16		
	● P-G-R-T TRUCK		
	★ D16		

ALL THE COMPONENTS LISTED IN OUR CATALOGUE ARE NOT ORIGINAL, THOUGH PERFECTLY INTERCHANGEABLE. REFERENCE NUMBERS, EITHER ORIGINAL OR OF A DIFFERENT NATURE, ARE FOR INFORMATION PURPOSES ONLY. WHEN PLACING AN ORDER, PLEASE, ALWAYS USE COSIBO REFERENCE NUMBERS AND DO NOT MENTION THE ORIGINAL REFERENCE NUMBERS OF THE TRUCK MANUFACTURERS IN THE INVOICE TO VEHICLE OWNERS OR TO ANYBODY ELSE. THE CUSTOMER TAKES HIS OWN RESPONSIBILITY IF HE DOES NOT COMPLY WITH WHAT ABOVE.

	Code	OEM new	OEM old
EXHAUST MANIFOLD	63922	2138380	1850826 1503932
● Model	IND. MARINE ENGINE 4		
★ Application	DC16A		
● 4 TRUCK	DC16		
★ P-G-R-T TRUCK	D16		



RH EXHAUST MANIFOLD	63923	1928760	1520701 1793583 1863897
● IND. MARINE ENGINE 4	DC16A		
★ 4 TRUCK	DC16		
● P-G-R-T TRUCK	D16		



LH EXHAUST MANIFOLD	63924	1928761	1520702 1793584 1863898
● IND. MARINE ENGINE 4	DC16A		
★ 4 TRUCK	DC16		
● P-G-R-T TRUCK	D16		



ALL THE COMPONENTS LISTED IN OUR CATALOGUE ARE NOT ORIGINAL, THOUGH PERFECTLY INTERCHANGEABLE. REFERENCE NUMBERS, EITHER ORIGINAL OR OF A DIFFERENT NATURE, ARE FOR INFORMATION PURPOSES ONLY. WHEN PLACING AN ORDER, PLEASE, ALWAYS USE COSIBO REFERENCE NUMBERS AND DO NOT MENTION THE ORIGINAL REFERENCE NUMBERS OF THE TRUCK MANUFACTURERS IN THE INVOICE TO VEHICLE OWNERS OR TO ANYBODY ELSE. THE CUSTOMER TAKES HIS OWN RESPONSIBILITY IF HE DOES NOT COMPLY WITH WHAT ABOVE.

	Code	OEM new	OEM old
EXHAUST MANIFOLD	61908	1349045	
<ul style="list-style-type: none"> ● Model ★ Application 			
<ul style="list-style-type: none"> ● IND. MARINE ENGINE 4 ★ 			
<ul style="list-style-type: none"> ● 3 TRUCK ★ DSC14 08/09/10/16 			



EXHAUST MANIFOLD	62047	326631	
<ul style="list-style-type: none"> ● 3 TRUCK ★ DS/DSC11 - DS11 73 - DSC11 12 			



EXHAUST MANIFOLD	63376	1374700	354334
<ul style="list-style-type: none"> ● 3 TRUCK ★ DS/DSC 11 - DS11 34/75 			
<ul style="list-style-type: none"> ● 4 TRUCK ★ DSC 11 			
<ul style="list-style-type: none"> ● 3 BUS ★ DS11 74/78 - DSC11 04/24/27/71 - DSI11 E01 - DS/DSC11 			
<ul style="list-style-type: none"> ● IND. MARINE ENGINE 4 ★ DS/DSI 11 			



ALL THE COMPONENTS LISTED IN OUR CATALOGUE ARE NOT ORIGINAL, THOUGH PERFECTLY INTERCHANGEABLE. REFERENCE NUMBERS, EITHER ORIGINAL OR OF A DIFFERENT NATURE, ARE FOR INFORMATION PURPOSES ONLY. WHEN PLACING AN ORDER, PLEASE, ALWAYS USE COSIBO REFERENCE NUMBERS AND DO NOT MENTION THE ORIGINAL REFERENCE NUMBERS OF THE TRUCK MANUFACTURERS IN THE INVOICE TO VEHICLE OWNERS OR TO ANYBODY ELSE. THE CUSTOMER TAKES HIS OWN RESPONSIBILITY IF HE DOES NOT COMPLY WITH WHAT ABOVE.

		Code	OEM new	OEM old
EXHAUST MANIFOLD	● Model	63377	1380451	1109278
	★ Application			
	● 3 TRUCK			
	★	DS/DSC 11 - DS11 34/75		
	● 4 TRUCK			
	★	DSC 11		
● 3 BUS				
★	DS11 74/78 - DSC11 04/24/27/71 - DSI11 E01 - DS/DSC11			
● IND. MARINE ENGINE 4				
★	DS/DSI 11			



		63378	1371209	1109279
EXHAUST MANIFOLD	● 3 TRUCK			
	★	DS/DSC11 - DS11 34/75		
	● 3 BUS			
	★	DS11 74/78 - DSC11 04/24/27/71 - DSI11 E01		
	● IND. MARINE ENGINE 4			
★				



		63468	270739	
EXHAUST MANIFOLD	● 3 TRUCK			
	★	DS/DSC11 - DS11 73 6X4 - DSC11 12 6X4		



ALL THE COMPONENTS LISTED IN OUR CATALOGUE ARE NOT ORIGINAL, THOUGH PERFECTLY INTERCHANGEABLE. REFERENCE NUMBERS, EITHER ORIGINAL OR OF A DIFFERENT NATURE, ARE FOR INFORMATION PURPOSES ONLY. WHEN PLACING AN ORDER, PLEASE, ALWAYS USE COSIBO REFERENCE NUMBERS AND DO NOT MENTION THE ORIGINAL REFERENCE NUMBERS OF THE TRUCK MANUFACTURERS IN THE INVOICE TO VEHICLE OWNERS OR TO ANYBODY ELSE. THE CUSTOMER TAKES HIS OWN RESPONSIBILITY IF HE DOES NOT COMPLY WITH WHAT ABOVE.

EXHAUST MANIFOLD



- Model
- ★ Application

Code

OEM new

OEM old

63469

270738

- 3 TRUCK

- ★ DS/DSC11 - CP RHD - DS11 73 - DSC11 12 6X4

EXHAUST MANIFOLD



- 3 TRUCK

- ★ DS/DSC11 - DS11 73 6X4 - DSC11 12 6X4

Code

OEM new

63470

293853

EXHAUST MANIFOLD



- 4 TRUCK

- ★ DSC11

Code

OEM new

63619

1395248

	Code	OEM new	OEM old
EXHAUST MANIFOLD	63649	1671745	
<ul style="list-style-type: none"> ● Model ★ Application 			
<ul style="list-style-type: none"> ● 3 TRUCK ★ 			



EXHAUST MANIFOLD	65227	1945331	2000364 1866391 1374099 1792307 1792308 1945014
<ul style="list-style-type: none"> ● 4 BUS ★ DC11 - D12 			
<ul style="list-style-type: none"> ● 4 TRUCK ★ DSC12 - DC12 			
<ul style="list-style-type: none"> ● F-K-N BUS ★ D9 PDE EGR - D11 - D12 			
<ul style="list-style-type: none"> ● IND. MARINE ENGINE 4 ★ DSI/DI12A - DSC/DC12A - DC12 54A 			
<ul style="list-style-type: none"> ● IND. MARINE ENGINE 5 ★ DC9 EMS - DC9 69A - DC 09/13A EGR PDE - SG9 A280 			
<ul style="list-style-type: none"> ● P-G-R-T TRUCK ★ D9 - D9 PDE EGR - D11 - D12 			



ALL THE COMPONENTS LISTED IN OUR CATALOGUE ARE NOT ORIGINAL, THOUGH PERFECTLY INTERCHANGEABLE. REFERENCE NUMBERS, EITHER ORIGINAL OR OF A DIFFERENT NATURE, ARE FOR INFORMATION PURPOSES ONLY. WHEN PLACING AN ORDER, PLEASE, ALWAYS USE COSIBO REFERENCE NUMBERS AND DO NOT MENTION THE ORIGINAL REFERENCE NUMBERS OF THE TRUCK MANUFACTURERS IN THE INVOICE TO VEHICLE OWNERS OR TO ANYBODY ELSE. THE CUSTOMER TAKES HIS OWN RESPONSIBILITY IF HE DOES NOT COMPLY WITH WHAT ABOVE.

		Code	OEM new	OEM old
EXHAUST MANIFOLD	● Model	65279	1853773	1384089 1413894 1470305
	★ Application			
	● 4 TRUCK			
	★	DC/DSC12 - DC12 4X4/6X6/8X8 - DC11 4X4/6X6 - DC11 - DT12		
	● P-G-R-T TRUCK			
	★	D11 - D12		
	● 4 BUS			
	★	DC11 - D12		
	● IND. MARINE ENGINE 4			
	★	DC12 54A - DSI/DI 12 A - DSC/DC 12 A		
● F-K-N BUS				
★	D11 - D12			

**BIG JUNCTION SLEEVE**

		61491	170948	
● 3 TRUCK				
★	DSC14 03/04/06/08/09/10/16			
● IND. MARINE ENGINE 4				
★				

SEAL RING

		61492	170955	
● 3 TRUCK				
★	DSC14 03/04/06/08/09/10/16			
● IND. MARINE ENGINE 4				
★				

ALL THE COMPONENTS LISTED IN OUR CATALOGUE ARE NOT ORIGINAL, THOUGH PERFECTLY INTERCHANGEABLE. REFERENCE NUMBERS, EITHER ORIGINAL OR OF A DIFFERENT NATURE, ARE FOR INFORMATION PURPOSES ONLY. WHEN PLACING AN ORDER, PLEASE, ALWAYS USE COSIBO REFERENCE NUMBERS AND DO NOT MENTION THE ORIGINAL REFERENCE NUMBERS OF THE TRUCK MANUFACTURERS IN THE INVOICE TO VEHICLE OWNERS OR TO ANYBODY ELSE. THE CUSTOMER TAKES HIS OWN RESPONSIBILITY IF HE DOES NOT COMPLY WITH WHAT ABOVE.

	Code	OEM new	OEM old
SMALL JUNCTION SLEEVE	61538	276087	
<ul style="list-style-type: none"> ● Model ★ Application 			
<ul style="list-style-type: none"> ● 3 BUS ★ DS11 74/78 - DSC11 04/24/27/71 - DSI11 E01 			
<ul style="list-style-type: none"> ● 3 TRUCK ★ DS/DSC11 - DS11 34/73/75 - DSC11 12 			
<ul style="list-style-type: none"> ● 4 TRUCK ★ OSC11 G03 			



	63375	1356677	355939
SEAL RING			
<ul style="list-style-type: none"> ● 3 BUS ★ DS11 74/78 - DSC11 04/24/27/71 - DSI11 E01 - DS/DSC 11 			
<ul style="list-style-type: none"> ● 4 BUS ★ DSC11 - OSC11 G03 - 			
<ul style="list-style-type: none"> ● IND. MARINE ENGINE 4 ★ DS/DSI 11 			
<ul style="list-style-type: none"> ● 3 TRUCK ★ DS/DSC 11 - DS11 34/75 - DTC 11 			
<ul style="list-style-type: none"> ● 4 TRUCK ★ DSC11 - OSC11 G03 			



	60073	250996	279052
SEAL RING			
<ul style="list-style-type: none"> ● 3 BUS ★ OSC11 G01 			
<ul style="list-style-type: none"> ● 3 TRUCK ★ DS/DSC11 - DSC11 73 - DSC11 12 - DS11 73 			
<ul style="list-style-type: none"> ● 4 TRUCK ★ OSC11 G03 			





	Code	OEM new	OEM old
SEAL RING	61537	15323	
● Model			
★ Application			
● 3 BUS			
★ DS11 74/78 - DSC11 04/24/27/71 - DSI11 E01 - DS/DSC11			
● 4 BUS			
★ D9 F94			
● IND. MARINE ENGINE 4			
★ DSC9/DC9 A/M - DSC9 47A			
● 3 TRUCK			
★ DN9 - DS9 4X4 - DN11 01 - DS/DSC11 - DS11 34/73/75 - DSC11 12 - DS/DSC9 - DTC11			
● 4 TRUCK			
★ OSC11 G03			



	65313	1439814	1423610
SEAL RING			
● 3 BUS			
★ GR801R			
● 4 BUS			
★ DC11 - D12 - K94 - DC9 19/ 20/ 21 - DSC9 - DSI9 E01 - DC9 - F94 - K/ L/ N94 - OSC9 G01 - GR801R			
● F-K-N BUS			
★ D9 PDE - GR801R/ GR900R/ GRS890R/ GRS900R/ GRS920R/ GRSO900R - D12K - D9 K/ N			
● IND. MARINE ENGINE 4			
★ DH12 68M - SG9 A280 - DC12 50A - D12A/ M - DC16A - D16M - D16A/ M			
● IND. MARINE ENGINE 5			
★ SG9 A280 - DC9A EMS			
● 3 TRUCK			
★ AD85 RBP730 6X4 - 8X4 - AD85 RP730 6X4 - 8X4 - GR/ GRS900R			
● 4 TRUCK			
★ DC11 - D12 - DSC14 13/ 15 - DSC11 - OSC11 G03 - DSC9 - DC9 01/ 02/ 03/ 04/ 05/ 06/ 19/ 20/ 21 - DC16 - GR/ GRS/ GRSH/ R/ GRSO/ R			
● P-G-R-T TRUCK			
★ D9 PDE - GR801R/ GR900R/ GRS890R/ GRS900R/ GRS920R/ GRSO900R - D11 - D12 - D16 - D9 - D13 XPI			



	Code	OEM new	OEM old
BIG SEAL RING	63414	1545479	394794
	<ul style="list-style-type: none"> ● Model ★ Application 		
	<ul style="list-style-type: none"> ● IND. MARINE ENGINE 4 ★ D14A 		
	<ul style="list-style-type: none"> ● 3 TRUCK ★ DSC14 08/09/10/16 		
	<ul style="list-style-type: none"> ● 4 TRUCK ★ DSC14 13/15 		
SMALL SEAL RING	63413	1333116	
	<ul style="list-style-type: none"> ● IND. MARINE ENGINE 4 ★ D14A 		
	<ul style="list-style-type: none"> ● 3 TRUCK ★ DSC14 08/09/10/16 		
	<ul style="list-style-type: none"> ● 4 TRUCK ★ DSC14 13/15 		
SMALL RING	65311	1775964	
	<ul style="list-style-type: none"> ● 4 BUS ★ DC9 19/20/21 - DC11 - D12 		
	<ul style="list-style-type: none"> ● F-K-N BUS ★ D11 - D12 - D9 PDE EGR - D9 F 		
	<ul style="list-style-type: none"> ● IND. MARINE ENGINE 4 ★ DC16 A 		
	<ul style="list-style-type: none"> ● IND. MARINE ENGINE 5 ★ DC9A EMS - SG9 A280 - DC9 69A 		
	<ul style="list-style-type: none"> ● 4 TRUCK ★ DC9 19/20/21 - DC16 		
	<ul style="list-style-type: none"> ● P-G-R-T TRUCK ★ D9 - D11 - D12 - D16 - D9 PDE EGR 		

ALL THE COMPONENTS LISTED IN OUR CATALOGUE ARE NOT ORIGINAL, THOUGH PERFECTLY INTERCHANGEABLE. REFERENCE NUMBERS, EITHER ORIGINAL OR OF A DIFFERENT NATURE, ARE FOR INFORMATION PURPOSES ONLY. WHEN PLACING AN ORDER, PLEASE, ALWAYS USE COSIBO REFERENCE NUMBERS AND DO NOT MENTION THE ORIGINAL REFERENCE NUMBERS OF THE TRUCK MANUFACTURERS IN THE INVOICE TO VEHICLE OWNERS OR TO ANYBODY ELSE. THE CUSTOMER TAKES HIS OWN RESPONSIBILITY IF HE DOES NOT COMPLY WITH WHAT ABOVE.

	Code	OEM new	OEM old
BIG RING	65312	1775965	
<ul style="list-style-type: none"> ● Model ★ Application 			
<ul style="list-style-type: none"> ● 4 BUS 			
★ DC9 19/20/21 - DC11 - D12			
<ul style="list-style-type: none"> ● F-K-N BUS 			
★ D11 - D12 - D9 PDE EGR - D9 F			
<ul style="list-style-type: none"> ● IND. MARINE ENGINE 4 			
★ DC16 A			
<ul style="list-style-type: none"> ● IND. MARINE ENGINE 5 			
★ DC9A EMS - SG9 A280 - DC9 69A			
<ul style="list-style-type: none"> ● 4 TRUCK 			
★ DC9 19/20/21 - DC16			
<ul style="list-style-type: none"> ● P-G-R-T TRUCK 			
★ D9 - D11 - D12 - D16 - D9 PDE EGR			



	61707	1545478	1408455 250995 278531
SEAL RING			
<ul style="list-style-type: none"> ● 3 BUS 			
★ OSC11 G01			
<ul style="list-style-type: none"> ● 4 BUS 			
★ DC9 19/20/21 - DC11/D12			
<ul style="list-style-type: none"> ● F-K-N BUS 			
★ D11/D12 - D9 PDE EGR - DT12 - DC12 - D9 PDE			
<ul style="list-style-type: none"> ● IND. MARINE ENGINE 4 			
★ DSI/DI 12 A - DSC/DC 12 A - DC 12 54A - D9A - DI9 56A - DC16A - DI 16 40/41/48/53 A - DC16 - DSC9/DC9 A/M			
<ul style="list-style-type: none"> ● IND. MARINE ENGINE 5 			
★ SG9 A280 - DC9A EMS			
<ul style="list-style-type: none"> ● 3 TRUCK 			
★ DN9 - DS9 4X4 - DS/DSC9 -			
<ul style="list-style-type: none"> ● 4 TRUCK 			
★ DC16 - DC9 19/20/21 - DSC12/DC12 4X4/6X6/8X8 - DSC12 - DSC12/DC12 - DC11 4X4/6X6 - DC11 - DT12			
<ul style="list-style-type: none"> ● P-G-R-T TRUCK 			
★ D11/D12 - D9 - D9 PDE EGR - DT12 - DC12 - D9 PDE			



ALL THE COMPONENTS LISTED IN OUR CATALOGUE ARE NOT ORIGINAL, THOUGH PERFECTLY INTERCHANGEABLE. REFERENCE NUMBERS, EITHER ORIGINAL OR OF A DIFFERENT NATURE, ARE FOR INFORMATION PURPOSES ONLY. WHEN PLACING AN ORDER, PLEASE, ALWAYS USE COSIBO REFERENCE NUMBERS AND DO NOT MENTION THE ORIGINAL REFERENCE NUMBERS OF THE TRUCK MANUFACTURERS IN THE INVOICE TO VEHICLE OWNERS OR TO ANYBODY ELSE. THE CUSTOMER TAKES HIS OWN RESPONSIBILITY IF HE DOES NOT COMPLY WITH WHAT ABOVE.

	Code	OEM new	OEM old
RING	62144	384848	
<ul style="list-style-type: none"> ● Model ★ Application 			
<ul style="list-style-type: none"> ● IND.MARINE ENGINE 4 ★ D14A 			
<ul style="list-style-type: none"> ● 3 TRUCK ★ DSC14 03/04/06/08/09/10 			



	64379	64379	
OIL PUMP REPAIR SET			
<ul style="list-style-type: none"> ● 3 BUS ★ GR801R 			
<ul style="list-style-type: none"> ● 4 BUS ★ DC11 - D12 - K94 - DC9 19/ 20/ 21 - DSC9 - DSI9 E01 - DC9 - F94 - K/ L/ N94 - OSC9 G01 - GR801R 			
<ul style="list-style-type: none"> ● F-K-N BUS ★ D9 PDE - GR801R/ GR900R/ GRS890R/ GRS900R/ GRS920R/ GRSO900R - D12K - D9 K/ N 			
<ul style="list-style-type: none"> ● IND. MARINE ENGINE 4 ★ DI12 68M - SG9 A280 - DC12 50A - D12A/ M - DC16A - D16M - D16A/ M 			
<ul style="list-style-type: none"> ● IND. MARINE ENGINE 5 ★ SG9 A280 - DC9A EMS 			
<ul style="list-style-type: none"> ● 3 TRUCK ★ AD85 RBP730 6X4 - 8X4 - AD85 RP730 6X4 - 8X4 - GR/ GRS900R 			
<ul style="list-style-type: none"> ● 4 TRUCK ★ DC11 - D12 - DSC14 13/ 15 - DSC11 - OSC11 G03 - DSC9 - DC9 01/ 02/ 03/ 04/ 05/ 06/ 19/ 20/ 21 - DC16 - GR/ GRS/ GRSH/ R/ GRSO/ R 			
<ul style="list-style-type: none"> ● P-G-R-T TRUCK ★ D9 PDE - GR801R/ GR900R/ GRS890R/ GRS900R/ GRS920R/ GRSO900R - D11 - D12 - D16 - D9 - D13 XPI 			



ALL THE COMPONENTS LISTED IN OUR CATALOGUE ARE NOT ORIGINAL, THOUGH PERFECTLY INTERCHANGEABLE. REFERENCE NUMBERS, EITHER ORIGINAL OR OF A DIFFERENT NATURE, ARE FOR INFORMATION PURPOSES ONLY. WHEN PLACING AN ORDER, PLEASE, ALWAYS USE COSIBO REFERENCE NUMBERS AND DO NOT MENTION THE ORIGINAL REFERENCE NUMBERS OF THE TRUCK MANUFACTURERS IN THE INVOICE TO VEHICLE OWNERS OR TO ANYBODY ELSE. THE CUSTOMER TAKES HIS OWN RESPONSIBILITY IF HE DOES NOT COMPLY WITH WHAT ABOVE.

	Code	OEM new	OEM old
THREAD FITTING	61917	180435	
● Model			
★ Application			
● 3 BUS			
★ GR801R			
● 4 BUS			
★ DC11 - D12 - K94 - DC9 19/ 20/ 21 - DSC9 - DSI9 E01 - DC9 - F94 - K/ L/ N94 - OSC9 G01 - GR801R			
● F-K-N BUS			
★ D9 PDE - GR801R/ GR900R/ GRS890R/ GRS900R/ GRS920R/ GRSO900R - D12K - D9 K/ N			
● IND. MARINE ENGINE 4			
★ DI12 68M - SG9 A280 - DC12 50A - D12A/ M - DC16A - D16M - D16A/ M			
● IND. MARINE ENGINE 5			
★ SG9 A280 - DC9A EMS			
● 3 TRUCK			
★ AD85 RBP730 6X4 - 8X4 - AD85 RP730 6X4 - 8X4 - GR/ GRS900R			
● 4 TRUCK			
★ DC11 - D12 - DSC14 13/ 15 - DSC11 - OSC11 G03 - DSC9 - DC9 01/ 02/ 03/ 04/ 05/ 06/ 19/ 20/ 21 - DC16 - GR/ GRS/ GRSH/ R/ GRSO/ R			
● P-G-R-T TRUCK			
★ D9 PDE - GR801R/ GR900R/ GRS890R/ GRS900R/ GRS920R/ GRSO900R - D11 - D12 - D16 - D9 - D13 XPI			



		Code	OEM new	OEM old
DRAIN PLUG	● Model	61204	1433641	1423608 165282
	★ Application			
	● 3 BUS			
	★	GR801R		
	● 4 BUS			
	★	DC11 - D12 - K94 - DC9 19/ 20/ 21 - DSC9 - DSI9 E01 - DC9 - F94 - K/ L/ N94 - OSC9 G01 - GR801R		
	● F-K-N BUS			
	★	D9 PDE - GR801R/ GR900R/ GRS890R/ GRS900R/ GRS920R/ GRSO900R - D12K - D9 K/ N		
	● IND. MARINE ENGINE 4			
	★	DI12 68M - SG9 A280 - DC12 50A - D12A/ M - DC16A - D16M - D16A/ M		
	● IND. MARINE ENGINE 5			
	★	SG9 A280 - DC9A EMS		
● 3 TRUCK				
★	AD85 RBP730 6X4 - 8X4 - AD85 RP730 6X4 - 8X4 - GR/ GRS900R			
● 4 TRUCK				
★	DC11 - D12 - DSC14 13/ 15 - DSC11 - OSC11 G03 - DSC9 - DC9 01/ 02/ 03/ 04/ 05/ 06/ 19/ 20/ 21 - DC16 - GR/ GRS/ GRSH/ R/ GRSO/ R			
● P-G-R-T TRUCK				
★	D9 PDE - GR801R/ GR900R/ GRS890R/ GRS900R/ GRS920R/ GRSO900R - D11 - D12 - D16 - D9 - D13 XPI			



	Code	OEM new	OEM old
GASKET	61205	165286	
● Model			
★ Application			
● 3 BUS			
★ GR801R			
● 3 TRUCK			
★ AD85 RBP730 6X4 - 8X4 - AD85 RP730 6X4 - 8X4 - GR/GRS900R			
● 4 BUS			
★ DC11 - D12 - K94 - DC9 19/20/21 - DSC9 - DS19 E01 - DC9 - F94 - K/L/N94 - OSC9 G01 - GR801R			
● 4 TRUCK			
★ DC11 - D12 - DSC14 13/15 - DSC11 - OSC11 G03 - DSC9 - DC9 01/02/03/04/05/06/19/20/21 - DC16 - GR/GRS/GRSH/R/GRSO/R			
● F-K-N BUS			
★ D9 PDE - GR801R/GR900R/GRS890R/GRS900R/GRS920R/GRS0900R - D12K - D9 K/N			
● IND. MARINE ENGINE 4			
★ DI12 68M - SG9 A280 - DC12 50A - D12A/M - DC16A - D16M - D16A/M			
● IND. MARINE ENGINE 5			
★ SG9 A280 - DC9A EMS			
● P-G-R-T TRUCK			
★ D9 PDE - GR801R/GR900R/GRS890R/GRS900R/GRS920R/GRS0900R - D11 - D12 - D16 - D9 - D13 XPI			



	64857	2057206	1770297
SAFETY VALVE			
● 3 TRUCK			
★			
● 4 BUS			
★			
● 4 TRUCK			
★			
● F-K-N BUS			
★			
● P-G-R-T RUCK			
★			



ALL THE COMPONENTS LISTED IN OUR CATALOGUE ARE NOT ORIGINAL, THOUGH PERFECTLY INTERCHANGEABLE. REFERENCE NUMBERS, EITHER ORIGINAL OR OF A DIFFERENT NATURE, ARE FOR INFORMATION PURPOSES ONLY. WHEN PLACING AN ORDER, PLEASE, ALWAYS USE COSIBO REFERENCE NUMBERS AND DO NOT MENTION THE ORIGINAL REFERENCE NUMBERS OF THE TRUCK MANUFACTURERS IN THE INVOICE TO VEHICLE OWNERS OR TO ANYBODY ELSE. THE CUSTOMER TAKES HIS OWN RESPONSIBILITY IF HE DOES NOT COMPLY WITH WHAT ABOVE.

	Code	OEM new	OEM old
SCREW	63303	1108053	
● Model			
★ Application			
● 3 BUS			
★ DS11 74/78 - DSC11 71 - DSI11 E01 - DS/DSC11 - DSC11 04/24/27			
● 4 BUS			
★ ARA 860			
● F-K-N BUS			
★ D11 - D12 - D9 PDE - D9 XPI - ARA 860			
● IND. MARINE ENGINE 4			
★ DSI/DI12 A - DSC/DC12 A - DC12 54A - DS/DSI 11 - DC16 A - DC16			
● IND. MARINE ENGINE 5			
★ SG9 A280 - DC9A EMS			
● 3 TRUCK			
★ DS/DSC11 - DS11 34/75 - DTC11			
● 4 TRUCK			
★ DC9 19/20/21 - DSC11 - CP/CR 14 - CP/CR 19 114/124 - D16 - DC16			
● P-G-R-T TRUCK			
★ D11 - D12 - D9 PDE - D9 XPI - D16 - D13 XPI - D9			



		Code	OEM new	OEM old
OIL FILTER	● Model	61758	153468	
	★ Application			
	● 3 TRUCK			
	★			

		60126	173171	
OIL FILTER	● 3 BUS			
	★ DS/DSC11 - OSC11 G01 - DSI 11 E01 - DSC11 08/21/24/27/71			
	● 3 TRUCK			
	★ DS9 - DSC9 - DS11 75 - DSC11 12/13/16/17/18/21/23/30/35/36 - DTC11 - GR871 - GR/GRE871T - GR880 T - CAG - GR871 CAG - GRH880			
	● 4 TRUCK			
	★ DSC 11 - OSC 11 G03			
	● IND.MARINE ENGINE 4			
	★ D/DC/DI 9M/11M/14M/14A/11A - DS/DSC 14 - DSI 14 68/73/74/75/78 M40/41/46/47 - DS/DSI 11 - DSI 14 70/72/77/79 - DS 11 95 A46S - DSI 14 69 M48			

ALL THE COMPONENTS LISTED IN OUR CATALOGUE ARE NOT ORIGINAL, THOUGH PERFECTLY INTERCHANGEABLE. REFERENCE NUMBERS, EITHER ORIGINAL OR OF A DIFFERENT NATURE, ARE FOR INFORMATION PURPOSES ONLY. WHEN PLACING AN ORDER, PLEASE, ALWAYS USE COSIBO REFERENCE NUMBERS AND DO NOT MENTION THE ORIGINAL REFERENCE NUMBERS OF THE TRUCK MANUFACTURERS IN THE INVOICE TO VEHICLE OWNERS OR TO ANYBODY ELSE. THE CUSTOMER TAKES HIS OWN RESPONSIBILITY IF HE DOES NOT COMPLY WITH WHAT ABOVE.

DRYER FILTER



	Code	OEM new	OEM old
● Model	64118	2081360	1384549 1774598
★ Application			
● F-K-N BUS			
★ HP - PDE - XPI			
● 4 TRUCK			
★ D9 - DC11 - D12 - D12 HPI 9.3 BAR - D14 9.3 BAR			
● P-G-R-T TRUCK			
★ D9 D11 D12 PDE - D16 - HPI PDE			

OIL FILTER REPAIR SET

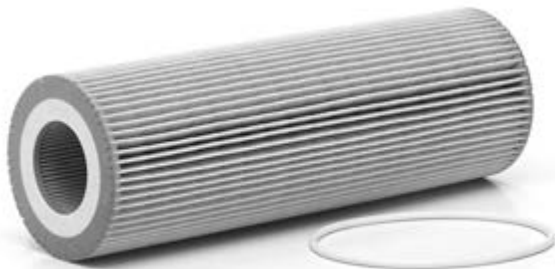

	65400	2022275	1742032
● F-K-N BUS			
★ D13 - D9 - D13 XPI - D9 OC9 - XPI			
● IND.MARINE ENGINE 5			
★ DC09/13A - D9 OC9 - XPI			
● P-G-R-T-TRUCK			
★ D13 - D9 - D13 XPI			

GASKET



	65119	1392929	371502
● 3 TRUCK			
★			
● IND.MARINE ENGINE 3			
★			
● IND. MARINE ENGINE 4			
★			

ALL THE COMPONENTS LISTED IN OUR CATALOGUE ARE NOT ORIGINAL, THOUGH PERFECTLY INTERCHANGEABLE. REFERENCE NUMBERS, EITHER ORIGINAL OR OF A DIFFERENT NATURE, ARE FOR INFORMATION PURPOSES ONLY. WHEN PLACING AN ORDER, PLEASE, ALWAYS USE COSIBO REFERENCE NUMBERS AND DO NOT MENTION THE ORIGINAL REFERENCE NUMBERS OF THE TRUCK MANUFACTURERS IN THE INVOICE TO VEHICLE OWNERS OR TO ANYBODY ELSE. THE CUSTOMER TAKES HIS OWN RESPONSIBILITY IF HE DOES NOT COMPLY WITH WHAT ABOVE.

		Code	OEM new	OEM old
O-RING	● Model	61193	1769799	211818 372985
	★ Application			
	● 3 BUS			
	★			
	● 4 BUS			
	★	L D9/DC11/D12/D14 12.2BAR - S D9/DC11/D12/D14 - DSC9 - DSI9 E01 - DC9 01/02/03/04/05/06 - OSC9 G01 - DSC11 - OSC11 G03		
	● F-K-N BUS			
	★	D12 HPI - D9 - D11 - D12 PDE - D9 PDE - D9 XP		
	● IND. MARINE ENGINE 4			
	★	D/DC/DI 9/9A/11A/11M/14A/14M - D12A/M - D12A/M EMS - D16A/M - DI12 49A - DC12 57A - DI12 68M - D9M - DC9 51/53/54/55A - DI16 48A/53A - DC16 - DSC9/DC9 A/M		
	● IND. MARINE ENGINE 5			
	★	DC9A EMS - SG9 A280		
	● 3 TRUCK			
★	L - M - DSC14 13/15			
● 4 TRUCK				
★	DC16 - S D16 - L D16 9.3BAR/12.2BAR - L D9/DC11/D12/D14 9.3BAR/12.2BAR - L D12 HPI 9.3BAR/12.2BAR - S D9/DC11/D12/D14 - S D12 HPI - S DSC11 - DSC12 - DC12 01/02/03/09 - DSC14 13/15 - DSC11 - OSC9 G01 - OSC11 G03 - DSC9 - DSI9 E01 - DC9 01/02/03/04/05/06 - DT12			
● P-G-R-T TRUCK				
★	D16 - HPI - D9 - D11 - D12 PDE - D13 - D9 PDE - D9 XPI			

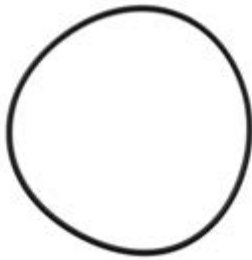

		Code	OEM new	OEM old
O-RING	● Model	61194	1769798	290534 372984
	★ Application			
	● 3 BUS			
	★			
	● 4 BUS			
	★	L D9/DC11/D12/D14 12.2BAR - S D9/DC11/D12/D14 - DSC9 - DSI9 E01 - DC9 01/02/03/04/05/06 - OSC9 G01 - DSC11 - OSC11 G03		
	● F-K-N BUS			
	★	D12 HPI - D9 - D11 - D12 PDE - D9 PDE - D9 XP		
	● IND. MARINE ENGINE 4			
	★	D/DC/DI 9/9A/11A/11M/14A/14M - D12A/M - D12A/M EMS - D16A/M - DI12 49A - DC12 57A - DI12 68M - D9M - DC9 51/53/54/55A - DI16 48A/53A - DC16 - DSC9/DC9 A/M		
	● IND. MARINE ENGINE 5			
	★	DC9A EMS - SG9 A280		
	● 3 TRUCK			
	★	L - M - DSC14 13/15		
● 4 TRUCK				
★	DC16 - S D16 - L D16 9.3BAR/12.2BAR - L D9/DC11/D12/D14 9.3BAR/12.2BAR - L D12 HPI 9.3BAR/12.2BAR - S D9/DC11/D12/D14 - S D12 HPI - S DSC11 - DSC12 - DC12 01/02/03/09 - DSC14 13/15 - DSC11 - OSC9 G01 - OSC11 G03 - DSC9 - DSI9 E01 - DC9 01/02/03/04/05/06 - DT12			
● P-G-R-T TRUCK				
★	D16 - HPI - D9 - D11 - D12 PDE - D13 - D9 PDE - D9 XPI			

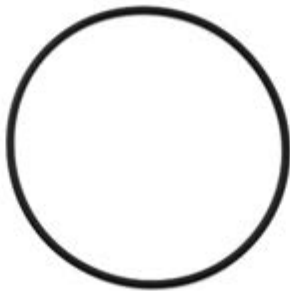

	Code	OEM new	OEM old
O-RING	61902	1769800	1475433
● Model			
★ Application			
● 4 BUS			
★ L D9/DC11/D12/D14 12.2BAR - S D9/DC11/D12/D14 - DC9 19/20/21 - DC11 D12			
● F-K-N BUS			
★ D9 PDE/D11/D12 - D9 XPI - L/S D12 HPI - L/S D9/D11/D12 PDE			
● IND. MARINE ENGINE 4			
★ D12A/M - DI12 49A/68M - DC12 57A			
● IND. MARINE ENGINE 5			
★ DC9A EMS - SG9 A280			
● 4 TRUCK			
★ L D9/DC11/D12/D14 9.3BAR/12.2BAR - S D9/DC11/D12/D14 - DC9 19/20/21 - DC11 D12 - L D12 HPI 9.3BAR/12.2BAR - S D12 HPI			
● P-G-R-T TRUCK			
★ L/S HPI - L/S D9/D11/D12 PDE - D13 - D9 PDE/D11/D12 - D9 XPI			

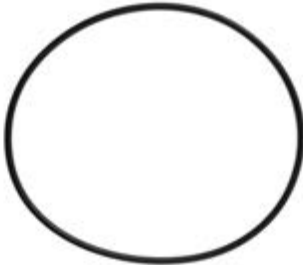
**LUBE SYST.O-R DIAM.107,5X3,53**

	61233	211813	
● 4 TRUCK			
★ DC11 - DSC9 - DSC - OSC11 - DC - DSC - DT12 -			

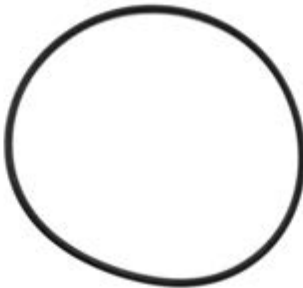

		Code	OEM new	OEM old
O-RING	● Model	63320	750226	
	★ Application			
	● 4 BUS			
	★			
	● 4 TRUCK			
	★			
	● F-K-N BUS			
	★			
	● IND.MARINE ENGINE 4			
	★			
	● IND.MARINE ENGINE 5			
	★			
	● P-G-R-T TRUCK			
★				



		64129	64129	
GASKET SET	● 3 BUS			
	★ GR801R			
	● 3 TRUCK			
	★ AD85 RBP730 6X4 - 8X4 - AD85 RP730 6X4 - 8X4 - GR/GRS900R			
	● 4 BUS			
	★ DC11 - D12 - K94 - DC9 19/20/21 - DSC9 - DS19 E01 - DC9 - F94 - K/L/N94 - OSC9 G01 - GR801R			
	● 4 TRUCK			
	★ DC11 - D12 - DSC14 13/15 - DSC11 - OSC11 G03 - DSC9 - DC9 01/02/03/04/05/06/19/20/21 - DC16 - GR/GRS/GRSH/R/GRSO/R			
	● F-K-N BUS			
	★ D9 PDE - GR801R/GR900R/GRS890R/GRS900R/GRS920R/GRSO900R - D12K - D9 K/N			
	● IND. MARINE ENGINE 4			
	★ DI12 68M - SG9 A280 - DC12 50A - D12A/M - DC16A - D16M - D16A/M			
	● IND. MARINE ENGINE 5			
★ SG9 A280 - DC9A EMS				
● P-G-R-T TRUCK				
★ D9 PDE - GR801R/GR900R/GRS890R/GRS900R/GRS920R/GRSO900R - D11 - D12 - D16 - D9 - D13 XPI				



ALL THE COMPONENTS LISTED IN OUR CATALOGUE ARE NOT ORIGINAL, THOUGH PERFECTLY INTERCHANGEABLE. REFERENCE NUMBERS, EITHER ORIGINAL OR OF A DIFFERENT NATURE, ARE FOR INFORMATION PURPOSES ONLY. WHEN PLACING AN ORDER, PLEASE, ALWAYS USE COSIBO REFERENCE NUMBERS AND DO NOT MENTION THE ORIGINAL REFERENCE NUMBERS OF THE TRUCK MANUFACTURERS IN THE INVOICE TO VEHICLE OWNERS OR TO ANYBODY ELSE. THE CUSTOMER TAKES HIS OWN RESPONSIBILITY IF HE DOES NOT COMPLY WITH WHAT ABOVE.

GASKET SET



	Code	OEM new	OEM old
● Model	64130	64130	
★ Application			
● 3 BUS			
★ GR801R			
● 3 TRUCK			
★ AD85 RBP730 6X4 - 8X4 - AD85 RP730 6X4 - 8X4 - GR/GRS900R			
● 4 BUS			
★ DC11 - D12 - K94 - DC9 19/20/21 - DSC9 - DS19 E01 - DC9 - F94 - K/L/N94 - OSC9 G01 - GR801R			
● 4 TRUCK			
★ DC11 - D12 - DSC14 13/15 - DSC11 - OSC11 G03 - DSC9 - DC9 01/02/03/04/05/06/19/20/21 - DC16 - GR/GRS/GRSH/R/GRSO/R			
● F-K-N BUS			
★ D9 PDE - GR801R/GR900R/GRS890R/GRS900R/GRS920R/GRS0900R - D12K - D9 K/N			
● IND. MARINE ENGINE 4			
★ DI12 68M - SG9 A280 - DC12 50A - D12A/M - DC16A - D16M - D16A/M			
● IND. MARINE ENGINE 5			
★ SG9 A280 - DC9A EMS			
● P-G-R-T TRUCK			
★ D9 PDE - GR801R/GR900R/GRS890R/GRS900R/GRS920R/GRS0900R - D11 - D12 - D16 - D9 - D13 XPI			

ALL THE COMPONENTS LISTED IN OUR CATALOGUE ARE NOT ORIGINAL, THOUGH PERFECTLY INTERCHANGEABLE. REFERENCE NUMBERS, EITHER ORIGINAL OR OF A DIFFERENT NATURE, ARE FOR INFORMATION PURPOSES ONLY. WHEN PLACING AN ORDER, PLEASE, ALWAYS USE COSIBO REFERENCE NUMBERS AND DO NOT MENTION THE ORIGINAL REFERENCE NUMBERS OF THE TRUCK MANUFACTURERS IN THE INVOICE TO VEHICLE OWNERS OR TO ANYBODY ELSE. THE CUSTOMER TAKES HIS OWN RESPONSIBILITY IF HE DOES NOT COMPLY WITH WHAT ABOVE.

GASKET SET



	Code	OEM new	OEM old
● Model	64131	64131	
★ Application			
● 3 BUS			
★ GR801R			
● 3 TRUCK			
★ AD85 RBP730 6X4 - 8X4 - AD85 RP730 6X4 - 8X4 - GR/GRS900R			
● 4 BUS			
★ DC11 - D12 - K94 - DC9 19/20/21 - DSC9 - DS19 E01 - DC9 - F94 - K/L/N94 - OSC9 G01 - GR801R			
● 4 TRUCK			
★ DC11 - D12 - DSC14 13/15 - DSC11 - OSC11 G03 - DSC9 - DC9 01/02/03/04/05/06/19/20/21 - DC16 - GR/GRS/GRSH/R/GRSO/R			
● F-K-N BUS			
★ D9 PDE - GR801R/GR900R/GRS890R/GRS900R/GRS920R/GRS0900R - D12K - D9 K/N			
● IND. MARINE ENGINE 4			
★ DI12 68M - SG9 A280 - DC12 50A - D12A/M - DC16A - D16M - D16A/M			
● IND. MARINE ENGINE 5			
★ SG9 A280 - DC9A EMS			
● P-G-R-T TRUCK			
★ D9 PDE - GR801R/GR900R/GRS890R/GRS900R/GRS920R/GRS0900R - D11 - D12 - D16 - D9 - D13 XPI			

CENTRIFUGAL OIL FILTER SPINDLE



	65367	1475436	
● 4 BUS			
★ DC9 19/20/21 - DC11 - D12			
● 4 TRUCK			
★ DC9 19/20/21 - DC11 - D12			
● F-K-N BUS			
★ D9 PDE - D11/D12 - D9 XPI			
● IND. MARINE ENGINE 4			
★ D12 A/M - DI12 49A 68M STD & LH/RH - DC12 57A -			
● IND. MARINE ENGINE 5			
★ DC9A - EMSSG9 A280			
● P-G-R-T TRUCK			
★ D9 PDE - D11/D12 - D9 XPI - D13			

ALL THE COMPONENTS LISTED IN OUR CATALOGUE ARE NOT ORIGINAL, THOUGH PERFECTLY INTERCHANGEABLE. REFERENCE NUMBERS, EITHER ORIGINAL OR OF A DIFFERENT NATURE, ARE FOR INFORMATION PURPOSES ONLY. WHEN PLACING AN ORDER, PLEASE, ALWAYS USE COSIBO REFERENCE NUMBERS AND DO NOT MENTION THE ORIGINAL REFERENCE NUMBERS OF THE TRUCK MANUFACTURERS IN THE INVOICE TO VEHICLE OWNERS OR TO ANYBODY ELSE. THE CUSTOMER TAKES HIS OWN RESPONSIBILITY IF HE DOES NOT COMPLY WITH WHAT ABOVE.

	Code	OEM new	OEM old
CENTRIFUGAL OIL FILTER SPINDLE	61206	362257	
● Model			
★ Application			
● 3 BUS			
★			
● 4 BUS			
★ D12 - K/L/N 94 DSC9 DS19 E01 DC9 OSC9 G01 - DSC9 DC9 01/02/03/04/05/06 - DC11			
● IND. MARINE ENGINE 4			
★			
● IND. MARINE ENGINE 4			
★ D12A - D12M - D9M - DC9 51/53/54/55A - DC16A - D116 48A 53A - D16M			
● 3 TRUCK			
★			
● 4 TRUCK			
★ DSC9 DC9 01/02/03/04/05/06 - DC11 - DSC12 DC12 01/02/03/09 - DSC14 13/15 - DSC11 - OSC11 G03 - DT12 - DC16			
● P-G-R-T TRUCK			
★ D16			



	Code	OEM new	OEM old
SAFETY LOCK NUT	63151	372981	
● Model			
★ Application			
● 3 BUS			
★			
● 3 TRUCK			
★			
● 4 BUS			
★ D12 - K/L/N 94 DSC9 DS19 E01 DC9 OSC9 G01 - DSC9 DC9 01/02/03/04/05/06 - DC11			
● 4 TRUCK			
★ DSC9 DC9 01/02/03/04/05/06 - DC11 - DSC12 DC12 01/02/03/09 - DSC14 13/15 - DSC11 - OSC11 G03 - DT12 - DC16			
● F-K-N BUS			
★ D9 PDE - D11 - D12 - D9 XPI			
● IND.MARINE ENGINE 3			
★			
● IND. MARINE ENGINE 4			
★ D12A - D12M - D9M - DC9 51/53/54/55A - DC16A - DI16 48A 53A - D16M			
● IND. MARINE ENGINE 5			
★ DC9 EMS - SG9 A280			
● P-G-R-T TRUCK			
★ D16 - D9 XPI - D9 PDE - D11 - D12 - D13			



		Code	OEM new	OEM old
GASKET	● Model	61191	1392196	1320290
	★ Application			
	● IND.MARINE ENGINE 3			
	★			
	● 3 BUS			
	★			
	● 4 BUS			
	★	DSC9 - DC9 01/02/03/04/05/06 - DSC11 - K/L/N94 DSC9-DSI9 E01-DC9-OSC9 G01 - DSI9 E01 - OSC11 G03		
	● IND.MARINE ENGINE 4			
	★	D9M - DC9 51/53/54/55A - DSC9 DC9 A/M		
● 3 TRUCK				
★				
● 4 TRUCK				
★	DSC9 - DC9 01/02/03/04/05/06 - DSC11 - OSC9 G01 - OSC11 G03 - DSI9 E01			



GASKET		61192	1384872	371489
	● 3 BUS			
	★			
	● 4 BUS			
	★	DSC11 - OSC11 G03		
	● IND.MARINE ENGINE 4			
	★			
	● 3 TRUCK			
	★			
	● 4 TRUCK			
★	DSC11 - OSC11 G03			



O-RING DIAM.=59,5X3 mm

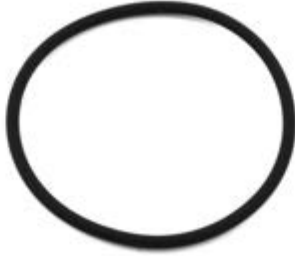

- Model
- ★ Application

Code

OEM new

OEM old

60636

332119

392663

- 3 BUS

★

- 3 TRUCK

★ CR/CT 143

- 4 BUS

★ DSC11 - OSC11 G03

- 4 TRUCK

★ DSC11 - OSC11 G03 - CR/CT144

- IND. MARINE ENGINE 4

★ DSC9/DC9 A/M - SG9 A280

- IND. MARINE ENGINE 5

★ SG9 A280

		Code	OEM new	OEM old
O-RING (GREEN VITON) 	● Model	65036	372983	
	★ Application			
	● 3 BUS			
	★			
	● 3 TRUCK			
	★			
	● 4 BUS			
	★	D12 - DSC9 - DC9 01/02/03/04/05/06/19/20/21 - DSC9 - DS19 E01 - OSC9 G01 - DC11 - OSC11 G03 - K/L/N 94		
	● 4 TRUCK			
	★	DC16 - DSC12 - DC12 01/02/03/09 - DSC14 13/15 - DSC11 - OSC11 G03 - DSC9 - DSC9 - DC9 01/02/03/04/05/06/19/20/21 - DC11 - DT12 - D12 - DC16 - DS19 01 - OSC9 G01		
	● F-K-N BUS			
	★	D9 PDE - D11 - D12 - D9 XPI		
	● IND. MARINE ENGINE 4			
★	D/DC/DI 9/11/14 A/M - D12 A/M - D12 A/M EMS - D16 A/M - DI12 49A - 68M - DC12 57A - D9 M - DC9 51/53/54/55A - DC16 A - DI16 48/53A - DC16 - DSC9/DC9 A/M			
● IND. MARINE ENGINE 5				
★	DC9 EMS - SG9 A280			
● P-G-R-T TRUCK				
★	D9 PDE - D11 - D12 - D9 XPI - D16 - D13			

		Code	OEM new	OEM old
OIL FILTER	● Model	60455	2059778	1117285
	★ Application			
	● 4 BUS			
	★	DC11/D12 - L D9/DC11/D12/D14 12,2 BAR - S D9/DC11/D12/D14 - DSC9 DC9 01/02/03/04/05/06/19/20/21 - DSI9 E01 - OSC9 G01 - K/L/N 94		
	● F-K-N BUS			
	★	D9 PDE - D11/D12 - L/S D12 HPI - L/S D9/D11/D12 PDE		
	● IND. MARINE ENGINE 4			
	★	D/DC/DI 9A/M - D12 A/M - D12A/M EMS - SG9 A280 - DI12 49A - DC12 57A - DI12 68M STD & LH/RH - DC9 51/53/54/55A - DSC14 - DC11/D12		
	● IND. MARINE ENGINE 5			
	★	DC9 EMS - SG9A 280		
● 4 TRUCK				
★	DSC14 13/15 - DC11/D12 - L D12 HPI 9,3/12,2 BAR - L D9/DC11/D12/D14 9,3/12,2 BAR - S D12 HPI - DSC12 - DC12 01/02/03/09 - DT12 - S D9/DC11/D12/D14 - DSC9 DC9 01/02/03/04/05/06/19/20/21 - DSI9 E01 - OSC9 G01			
● P-G-R-T TRUCK				
★	L/S HPI - L/S D9/D11/D12 PDE - D9 PDE - D11/D12			



		64400	1862892	
PRESSURE SENSOR	● ING MARINE ENGINE			
	★	DC16A		
	● 4 BUS			
	★	DC11 - D12		
	● 4 TRUCK			
	★	DC16 - DT12 - DC12 01/02/03/09 - DSC12		



		65479	1377930	
SENSOR	● 4 TRUCK			
	★	D12		
	● 4 TRUCK			
	★	D12 - DC12 - DSC12		



ALL THE COMPONENTS LISTED IN OUR CATALOGUE ARE NOT ORIGINAL, THOUGH PERFECTLY INTERCHANGEABLE. REFERENCE NUMBERS, EITHER ORIGINAL OR OF A DIFFERENT NATURE, ARE FOR INFORMATION PURPOSES ONLY. WHEN PLACING AN ORDER, PLEASE, ALWAYS USE COSIBO REFERENCE NUMBERS AND DO NOT MENTION THE ORIGINAL REFERENCE NUMBERS OF THE TRUCK MANUFACTURERS IN THE INVOICE TO VEHICLE OWNERS OR TO ANYBODY ELSE. THE CUSTOMER TAKES HIS OWN RESPONSIBILITY IF HE DOES NOT COMPLY WITH WHAT ABOVE.

TEMPERATURE SENSOR



	Code	OEM new	OEM old
● Model ★ Application	64240	1865317	1788333
● 3 BUS			
★ DSC11			
● 4 BUS			
★ D9			
● 4 TRUCK			
★ D9 - DSC9 - DSC11 - D12 - D14 - DC16			
● IND.MARINE ENGINE 4			
★ DC12 46A 47A 48A - D12A EMS - D12M - DC16A			

OIL FILTER



	Code	OEM new	OEM old
	62402	2057893	1439036 1873014
● IND. MARINE ENGINE 4			
★ D16A - D16M - DC16A - D116 48A/53A			
● 4 TRUCK			
★ D16 - DC16			
● P-G-R-T TRUCK			
★ D16			

RETARDER OIL FILTER



	Code	OEM new	OEM old
	62361	1381235	1329876
● 4 BUS			
★			
● F-K-N BUS			
★ GR/GRS/GRSO/875/895/905/R			
● 4 TRUCK			
★			
● P-G-R-T TRUCK			
★ GR/GRS/GRSO/875/895/905/R			

ALL THE COMPONENTS LISTED IN OUR CATALOGUE ARE NOT ORIGINAL, THOUGH PERFECTLY INTERCHANGEABLE. REFERENCE NUMBERS, EITHER ORIGINAL OR OF A DIFFERENT NATURE, ARE FOR INFORMATION PURPOSES ONLY. WHEN PLACING AN ORDER, PLEASE, ALWAYS USE COSIBO REFERENCE NUMBERS AND DO NOT MENTION THE ORIGINAL REFERENCE NUMBERS OF THE TRUCK MANUFACTURERS IN THE INVOICE TO VEHICLE OWNERS OR TO ANYBODY ELSE. THE CUSTOMER TAKES HIS OWN RESPONSIBILITY IF HE DOES NOT COMPLY WITH WHAT ABOVE.

		Code	OEM new	OEM old
GASKET	● Model	60969	1392931	139472
	★ Application			
	● 3 TRUCK			
	★ DSC11 12/13/16			
	● IND. MARINE ENGINE 4			
	★ DS/DSC14 - DSI14 74/78 M40/41/46/47 - DSI14 72/77/79			

		60564	357363	
GASKET	● 3 BUS			
	★			
	● 3 TRUCK			
	★ DN11 01 - DS11 34/73			
	● IND. MARINE ENGINE 4			
	★ DS/DSC/DSI 11A			

		60565	1384552	393820
GASKET	● 3 BUS			
	★ DSI11			
	● 3 TRUCK			
	★ DN11 01 - DS11 34/73 - DSC11			
	● IND. MARINE ENGINE 4			
	★ DSI11 73/75/75/76/77/78/79/80/81 - DSI11 A46/47			

		Code	OEM new	OEM old
GASKET	● Model	61483	1746684	1308589
	★ Application			1392459
				277607
				353249
				371510
	● 3 TRUCK			
	★ DSC14			
	● 4 TRUCK			
	★ DSC14 13/15			
	● IND. MARINE ENGINE 4			
	★ DS14 - DSC14 - D14 A/M			



		61921	1384554	1301628
GASKET	● 3 TRUCK			
	★ DS11 34/75 - DSC11 - DSC/DTC11 - OSC11 G03			
	● 4 TRUCK			
	★ DSC11 - OSC11 G03			
	● 3 BUS			
	★ DS11 - DSC11			
	● 4 BUS			
	★ DSC11 - OSC11 G03			
	● IND. MARINE ENGINE 4			
	★ DS11 A45 - DS11 - DSC11 - DS/DSC/DSI 11A			



		60973	1392930	139471 371514
GASKET	● 3 TRUCK			
	★ DSC11 12/13/16			
	● 4 TRUCK			
	★ DC16 - DSC14 13/15			
	● IND. MARINE ENGINE 4			
	★ DC16 A - DS/DSC14 - DS14 70/72/77/79 - DS14 68/73/74/75/78 M46/47 - DC6			
	● P-G-R-T TRUCK			
	★ D16			



ALL THE COMPONENTS LISTED IN OUR CATALOGUE ARE NOT ORIGINAL, THOUGH PERFECTLY INTERCHANGEABLE. REFERENCE NUMBERS, EITHER ORIGINAL OR OF A DIFFERENT NATURE, ARE FOR INFORMATION PURPOSES ONLY. WHEN PLACING AN ORDER, PLEASE, ALWAYS USE COSIBO REFERENCE NUMBERS AND DO NOT MENTION THE ORIGINAL REFERENCE NUMBERS OF THE TRUCK MANUFACTURERS IN THE INVOICE TO VEHICLE OWNERS OR TO ANYBODY ELSE. THE CUSTOMER TAKES HIS OWN RESPONSIBILITY IF HE DOES NOT COMPLY WITH WHAT ABOVE.

		Code	OEM new	OEM old
GASKET	● Model	61922	1384555	1301629
	★ Application			
	● 3 TRUCK			
	★	DS11 34/75 - DSC11 - DSC/DTC11 - OSC11 G03		
	● 4 TRUCK			
	★	DSC11 - ASC11 G03		
	● 3 BUS			
	★	DS11 - DSC11		
	● 4 BUS			
	★	DSC11 - OSC11 G03		
● IND. MARINE ENGINE 4				
★	DS11 34/75 - DSC11 - DSC/DTC11 - OSC11 G03			



GASKET		62542	1516474	1374338 1374340 1516145
	● 4 TRUCK			
	★	DC16 - DSC12 01/02/03/05 - DC12 - DT12 - DC9 19/20/21 - DC11 01/02/03/04/06/07 - D12		
	● P-G-R-T TRUCK			
	★	D9 - D11 - D12 - D16 - D11/D12 CG/CP/CR/CT EGR - D9PDE/DC12 EGR		
	● 4 BUS			
	★	DC11 01/02/03/04/06/07 - D12 - K94 DC9 19/20/21 - DSC12 01/02/03/05 - DC12 - DT12		
	● IND. MARINE ENGINE 4			
	★	DSC/DC12A - DSI/DI12A - DI12 59M/60M/62M/64M/65M/66M/68M/69M/70M - DC12A EMS - SGI12A - DC16A - DI16 40A/41A/48A/53A - D16M - DI16 50M - D12A/M - D12M EMS - D12A EMS - DC16		
	● IND. MARINE ENGINE 5			
★	DC9A EMS - SG9 A280			
● F-K-N BUS				
★	D9 - D11 - D12 - D16 - DC12K EGR - D9K EGR - D9N EGR - K D9/D11/D12 - D9NUD EGR			



		Code	OEM new	OEM old
GASKET OLD VERSION	● Model	61482	366547	
	★ Application			
	● 3 BUS			
	★	DS9 - DSC9 - K93 - F93		
	● 3 TRUCK			
	★	DS9 4X4/6X4/8X4 - DSC9 - DN9 - DS9 - CG/CP/CR/CT93		
	● 4 BUS			
	★	L/N94 DSI9 E01 - DSC9 - DC9 - OSC9 G01 - D9 - F94 - DC9 01/02/03/04/05/06 - DSI9 E01 - OSC9 - DSI9		
● 4 TRUCK				
★	D9 - DSC9 - DC9 01/02/03/04/05/06 - DSI9 E01 - OSC9 G01 - OSC9 - DSI9			
● IND. MARINE ENGINE 4				
★	SG9 A280 - DSC9/DC9 46 A03/A05 - DSC9/DC9 47/49/50 - DI9 A/M - DC9 M - DS9/D9 - DI9 56A - DC9 51A/53A/54A/55A - D9 A/M - DSC9/DC9 A/M - D9 - DC9 51 A05E			

		64277	1437296	1349714 366557
GASKET	● 3 TRUCK			
	★	DS9 4X4/6X4/8X4 - DSC9 - DN9 - DS9 - CG/CP/CR/CT93		
	● 4 TRUCK			
	★	D9 - DSC9 - DC9 01/02/03/04/05/06 - DSI9 E01 - OSC9 G01 - OSC9 - DSI9		
	● 3 BUS			
	★	DS9 - DSC9 - K93 - F93		
	● 4 BUS			
	★	L/N94 DSI9 E01 - DSC9 - DC9 - OSC9 G01 - D9 - F94 - DC9 01/02/03/04/05/06 - DSI9 E01 - OSC9 - DSI9		
● IND. MARINE ENGINE 4				
★	SG9 A280 - DSC9/DC9 46 A03/A05 - DSC9/DC9 47/49/50 - DI9 A/M - DC9 M - DS9/D9 - DI9 56A - DC9 51A/53A/54A/55A - D9 A/M - DSC9/DC9 A/M - D9 - DC9 51 A05E			

		64262	1862798	1784636
AIR SENSOR	● 4 TRUCK			
	★	DSC12 01/03/05 - DC12 - DT12		
				

ALL THE COMPONENTS LISTED IN OUR CATALOGUE ARE NOT ORIGINAL, THOUGH PERFECTLY INTERCHANGEABLE. REFERENCE NUMBERS, EITHER ORIGINAL OR OF A DIFFERENT NATURE, ARE FOR INFORMATION PURPOSES ONLY. WHEN PLACING AN ORDER, PLEASE, ALWAYS USE COSIBO REFERENCE NUMBERS AND DO NOT MENTION THE ORIGINAL REFERENCE NUMBERS OF THE TRUCK MANUFACTURERS IN THE INVOICE TO VEHICLE OWNERS OR TO ANYBODY ELSE. THE CUSTOMER TAKES HIS OWN RESPONSIBILITY IF HE DOES NOT COMPLY WITH WHAT ABOVE.

AIR SENSOR



	Code	OEM new	OEM old
● Model	64420	2131819	1784637
★ Application			1862799
● 4 TRUCK			
★	DSC12 01/02 - DSC14 13/15		

AIR FILTER



	60367	1869988	1387549 1526087 1801775
● 4 BUS			
★	94/114/124 - F94		
● 4 TRUCK			
★	94/114/124		
● P-G-R-T TRUCK			
★	D9/D11/D12/D13		

AIR FILTER



	60584	1869993	1421022
● 4 TRUCK			
★	94/114/124 - 8X8 WLS ZLS		
● P-G-R-T TRUCK			
★	D9/D11/D12		

ALL THE COMPONENTS LISTED IN OUR CATALOGUE ARE NOT ORIGINAL, THOUGH PERFECTLY INTERCHANGEABLE. REFERENCE NUMBERS, EITHER ORIGINAL OR OF A DIFFERENT NATURE, ARE FOR INFORMATION PURPOSES ONLY. WHEN PLACING AN ORDER, PLEASE, ALWAYS USE COSIBO REFERENCE NUMBERS AND DO NOT MENTION THE ORIGINAL REFERENCE NUMBERS OF THE TRUCK MANUFACTURERS IN THE INVOICE TO VEHICLE OWNERS OR TO ANYBODY ELSE. THE CUSTOMER TAKES HIS OWN RESPONSIBILITY IF HE DOES NOT COMPLY WITH WHAT ABOVE.

		Code	OEM new	OEM old
AIR FILTER	● Model	62403	1421021	1335678
	★ Application			
	● IND. MARINE ENGINE 4			
	★	DI12 41M/42M/43M/44M/45M - DSI14 68M/73M/74M/75M/78M - DS11 - DS111 73/74/75/76/77/78/79/80/81 - DS/DSC14 - DC16 A - D16M		
	● IND. MARINE ENGINE 5			
	★	DC9A EMS		
	● 4 TRUCK			
★	144 - 164			
● P-G-R-T TRUCK				
★	D9 - D13 - D16 - CG/CP14 EK PTO			



		63618	1869987	1387548 1526086
AIR FILTER	● 4 TRUCK			
	★	144/164		
	● P-G-R-T TRUCK			
	★	D16 - D9/13		



		64390	1869992	
AIR FILTER	● 4 BUS			
	★	F94		
	● 4 TRUCK			
	★	94 114 124 164		
	● P-G-R-T TRUCK			
★				



ALL THE COMPONENTS LISTED IN OUR CATALOGUE ARE NOT ORIGINAL, THOUGH PERFECTLY INTERCHANGEABLE. REFERENCE NUMBERS, EITHER ORIGINAL OR OF A DIFFERENT NATURE, ARE FOR INFORMATION PURPOSES ONLY. WHEN PLACING AN ORDER, PLEASE, ALWAYS USE COSIBO REFERENCE NUMBERS AND DO NOT MENTION THE ORIGINAL REFERENCE NUMBERS OF THE TRUCK MANUFACTURERS IN THE INVOICE TO VEHICLE OWNERS OR TO ANYBODY ELSE. THE CUSTOMER TAKES HIS OWN RESPONSIBILITY IF HE DOES NOT COMPLY WITH WHAT ABOVE.

AIR FILTER



- Model
- ★ Application

Code	OEM new	OEM old
65487	1872151	1730757

- 4 BUS



- 4 TRUCK



- P-G-R-T TRUCK



AIR FILTER



65524	1485592	
--------------	---------	--

- 4 BUS



- 4 TRUCK



- F-K-N BUS



- IND.MARINE ENGINE 4



- IND.MARINE ENGINE 5



- P-G-R-T TRUCK



ALL THE COMPONENTS LISTED IN OUR CATALOGUE ARE NOT ORIGINAL, THOUGH PERFECTLY INTERCHANGEABLE. REFERENCE NUMBERS, EITHER ORIGINAL OR OF A DIFFERENT NATURE, ARE FOR INFORMATION PURPOSES ONLY. WHEN PLACING AN ORDER, PLEASE, ALWAYS USE COSIBO REFERENCE NUMBERS AND DO NOT MENTION THE ORIGINAL REFERENCE NUMBERS OF THE TRUCK MANUFACTURERS IN THE INVOICE TO VEHICLE OWNERS OR TO ANYBODY ELSE. THE CUSTOMER TAKES HIS OWN RESPONSIBILITY IF HE DOES NOT COMPLY WITH WHAT ABOVE.

AIR FILTER ASSY W/O INTERNAL FILTER



	Code	OEM new	OEM old
● Model	64009	1335674	
★ Application			
● 4 TRUCK			
★ 94/114/124 - 8X8 WLS/ZLS			
● P-G-R-T TRUCK			
★ D9/D11/D12			

AIR FILTER ASSY W/O INTERNAL FILTER



	64058	1870001	1387542 1801772
● 4 BUS			
★ F94			
● 4 TRUCK			
★ 94/114/124			
● P-G-R-T TRUCK			
★ D9/D11/D12/D13			

AIR FILTER COVER



	64375	1387547	
● 4 BUS			
★ F94			
● 4 TRUCK			
★ 94/114/124			
● P-G-R-T TRUCK			
★ D9/D11/D12/D13			

ALL THE COMPONENTS LISTED IN OUR CATALOGUE ARE NOT ORIGINAL, THOUGH PERFECTLY INTERCHANGEABLE. REFERENCE NUMBERS, EITHER ORIGINAL OR OF A DIFFERENT NATURE, ARE FOR INFORMATION PURPOSES ONLY. WHEN PLACING AN ORDER, PLEASE, ALWAYS USE COSIBO REFERENCE NUMBERS AND DO NOT MENTION THE ORIGINAL REFERENCE NUMBERS OF THE TRUCK MANUFACTURERS IN THE INVOICE TO VEHICLE OWNERS OR TO ANYBODY ELSE. THE CUSTOMER TAKES HIS OWN RESPONSIBILITY IF HE DOES NOT COMPLY WITH WHAT ABOVE.

AIR FILTER ASSY W/O INTERNAL FILTER



	Code	OEM new	OEM old
● Model	64380	1870000	
★ Application			
● P-G-R-T TRUCK			
★ D9/13 D16 CH 2044086 - CH 5220340 - CH 9139307			

SEAL RING



	64402	1424853	
● 4 TRUCK			
★ 114 CD11 - 124 - DC9 19/20/21			
● P-G-R-T TRUCK			
★ CG/CP/CR/CT D9 PDE - D11 - D12			

CLAMP





	64016	1431701	
● 4 BUS			
★ L94 ENG 5131571 - N94 ENG 6003287 ENG 5749530 - D9 F94 ENG 3131425 - D12 ENG 5749530			
● IND. MARINE ENGINE 4			
★ DSI/DI12 A - DSI11 ENG 5367779			
● 4 TRUCK			
★ DSC9 ENG 5131571 - DC9 01/02/03/04/05/06 - DSC11/DSC12 ENG 5749530 - DSC12 - DC12 4X4/6X6/8X8 ENG 5749530 - DC11 4X4/6X6 ENG 5749530 -			

ALL THE COMPONENTS LISTED IN OUR CATALOGUE ARE NOT ORIGINAL, THOUGH PERFECTLY INTERCHANGEABLE. REFERENCE NUMBERS, EITHER ORIGINAL OR OF A DIFFERENT NATURE, ARE FOR INFORMATION PURPOSES ONLY. WHEN PLACING AN ORDER, PLEASE, ALWAYS USE COSIBO REFERENCE NUMBERS AND DO NOT MENTION THE ORIGINAL REFERENCE NUMBERS OF THE TRUCK MANUFACTURERS IN THE INVOICE TO VEHICLE OWNERS OR TO ANYBODY ELSE. THE CUSTOMER TAKES HIS OWN RESPONSIBILITY IF HE DOES NOT COMPLY WITH WHAT ABOVE.

	Code	OEM new	OEM old
RUBBER HOSE	63166	1331309	
	<ul style="list-style-type: none"> ● Model ★ Application 		
	<ul style="list-style-type: none"> ● 4 TRUCK ★ CP/CR14 - CP/CR19 - 114-124 - CR/CT 164 		

RUBBER BOOT	63170	375937	
	<ul style="list-style-type: none"> ● 3 TRUCK ★ 		

SEAL RING	64403	1424854	
	<ul style="list-style-type: none"> ● 4 TRUCK ★ 114 DC11 - 124 - DC9 19/20/21 - CR/CT 164 ● P-G-R-T TRUCK ★ D9 PDE CG/CP/CR/CT - D11 - D12 - D13 - OC9 - D16 CR/CT - D9 XPI CG/CP/CR 14/16/19 - D9 XPI CP 28/31 		

SEAL RING	64404	1446910	
	<ul style="list-style-type: none"> ● 4 TRUCK ★ 164 CR/CT ● P-G-R-T TRUCK ★ D16 CR/CT 		

ALL THE COMPONENTS LISTED IN OUR CATALOGUE ARE NOT ORIGINAL, THOUGH PERFECTLY INTERCHANGEABLE. REFERENCE NUMBERS, EITHER ORIGINAL OR OF A DIFFERENT NATURE, ARE FOR INFORMATION PURPOSES ONLY. WHEN PLACING AN ORDER, PLEASE, ALWAYS USE COSIBO REFERENCE NUMBERS AND DO NOT MENTION THE ORIGINAL REFERENCE NUMBERS OF THE TRUCK MANUFACTURERS IN THE INVOICE TO VEHICLE OWNERS OR TO ANYBODY ELSE. THE CUSTOMER TAKES HIS OWN RESPONSIBILITY IF HE DOES NOT COMPLY WITH WHAT ABOVE.

		Code	OEM new	OEM old
CLAMP	● Model	64358	1433190	
	★ Application			
	● 4 BUS			
	★	L94 ENG 5131752 - DC11/D12 ENG 5749531		
	● IND. MARINE ENGINE 4			
	★	DSI/DI12 A ENG 5749531 - DC9 51A/53A/54A/55A - DSI11 ENG 5367780 - SG9 A280		
● IND. MARINE ENGINE 5				
★	DC9A EMS - SG9 A280			
● 4 TRUCK				
★	DSC9 ENG 5131572 - DSC11 ENG 5749531 - DSC12 ENG 5749531 - DC12 4X4/6X6/8X8 ENG 5749531 - DC11 4X4/6X6 ENG 5749531			



		61960	132650	
PIN	● 4 BUS			
	★	L94 - N94 - K94		
	● 4 TRUCK			
	★	DSC9 - DC9 01/02/03/04/05/06 - DSC14 13/15		
	● F-K-N BUS			
	★	D9-D11-D12-D13 F/K/N		
	● IND.MARINE ENGINE 4			
	★	DC9 51A		
	● IND.MARINE ENGINE 5			
	★	DC9A EMS - DC09/13A		
● P-G-R-T TRUCK				
★	D9-D11-D12-D13-D16 CG/CP/CR/CT			



TURBO REPAIR SET



- Model
- ★ Application

Code	OEM new	OEM old
60505	550195	

- 3 TRUCK

★ DSC11 12/13 - ENG 3075634 - ENG 5307760 - ENG 4070104

TURBO REPAIR SET



- 3 TRUCK

60506	1382113	1382110 550196
-------	---------	-------------------

★ DS11 73 - DSC11 16 - ENG 5307760 - ENG 4070104 - ENG 3075634

ALL THE COMPONENTS LISTED IN OUR CATALOGUE ARE NOT ORIGINAL, THOUGH PERFECTLY INTERCHANGEABLE. REFERENCE NUMBERS, EITHER ORIGINAL OR OF A DIFFERENT NATURE, ARE FOR INFORMATION PURPOSES ONLY. WHEN PLACING AN ORDER, PLEASE, ALWAYS USE COSIBO REFERENCE NUMBERS AND DO NOT MENTION THE ORIGINAL REFERENCE NUMBERS OF THE TRUCK MANUFACTURERS IN THE INVOICE TO VEHICLE OWNERS OR TO ANYBODY ELSE. THE CUSTOMER TAKES HIS OWN RESPONSIBILITY IF HE DOES NOT COMPLY WITH WHAT ABOVE.

ENGINE MOUNTING



	Code	OEM new	OEM old
● Model	60141	364833	364833
★ Application			
● 3 BUS			
★			
● IND. MARINE ENGINE 4			
★ D9 A/M - DSC9/DC9 47 A04S			
● 3 TRUCK			
★ DS/DSC11 - DTC11 - 6X4 8X4			

ENGINE MOUNTING



	60140	309885	138849 238999
● IND. MARINE ENGINE 4			
★ D9 A/M			

RUBBER MOUNTING



	60405	332738	137207
● 3 BUS			
★			
● IND. MARINE ENGINE 4			
★ SG9 A280 - D9 A/M			
● 3 TRUCK			
★ 4X4 6X4 6X6 8X4 - DS/DSC11 - DTC11			

ALL THE COMPONENTS LISTED IN OUR CATALOGUE ARE NOT ORIGINAL, THOUGH PERFECTLY INTERCHANGEABLE. REFERENCE NUMBERS, EITHER ORIGINAL OR OF A DIFFERENT NATURE, ARE FOR INFORMATION PURPOSES ONLY. WHEN PLACING AN ORDER, PLEASE, ALWAYS USE COSIBO REFERENCE NUMBERS AND DO NOT MENTION THE ORIGINAL REFERENCE NUMBERS OF THE TRUCK MANUFACTURERS IN THE INVOICE TO VEHICLE OWNERS OR TO ANYBODY ELSE. THE CUSTOMER TAKES HIS OWN RESPONSIBILITY IF HE DOES NOT COMPLY WITH WHAT ABOVE.

ENGINE & GEARBOX MOUNTING



	Code	OEM new	OEM old
● Model	62040	1336882	
★ Application			
● 4 TRUCK			
★ 144			

FRONT ENGINE MOUNTING - GREEN



	60435	1496288	1423011 1336885
● 4 BUS			
★ P/ R94 - N94 - D9 F94 -			
● F-K-N BUS			
★ F			
● 4 TRUCK			
★ P/ R94 - D12 - DSC11 OSC11 G03 - DC9 19/ 20/ 21 - DC11 - DC11 D12 - 2 POINTS SUSP. CAB			
● P-G-R-T TRUCK			
★ D11 - D12 2 POINTS SUSP. CAB - D9 PDE			

FRONT ENGINE MOUNTING - RED



	60435/2	1778532	
● 4 BUS			
★ K94 DC9 19/20/21			
● 4 TRUCK			
★ DC11 - D12			
● F-K-N BUS			
★ K PDE - N - D9-D13 XPI			
● IND.MARINE ENGINE 5			
★ DC9A EMS - SG9A 280			
● P-G R-T TRUCK			
★ D9 OC9 - D11 - D12 - D13			

ALL THE COMPONENTS LISTED IN OUR CATALOGUE ARE NOT ORIGINAL, THOUGH PERFECTLY INTERCHANGEABLE. REFERENCE NUMBERS, EITHER ORIGINAL OR OF A DIFFERENT NATURE, ARE FOR INFORMATION PURPOSES ONLY. WHEN PLACING AN ORDER, PLEASE, ALWAYS USE COSIBO REFERENCE NUMBERS AND DO NOT MENTION THE ORIGINAL REFERENCE NUMBERS OF THE TRUCK MANUFACTURERS IN THE INVOICE TO VEHICLE OWNERS OR TO ANYBODY ELSE. THE CUSTOMER TAKES HIS OWN RESPONSIBILITY IF HE DOES NOT COMPLY WITH WHAT ABOVE.

	Code	OEM new	OEM old
FRONT ENGINE MOUNTING-GREEN AND WHITE	60435/3	1778530	
● Model			
★ Application			
● 4 BUS			
★ K/L/N 94 - D9 F94			
● 4 TRUCK			
★ DC9 19/20/21 - DC11 - D12 - DSC11 - OSC11 G03			
● F-K-N BUS			
★ F			
● IND.MARINE ENGINE 4			
★ DC12 55A			
● P-G-R-T TRUCK			
★ D9 - D9 PDE - OC9 - D11 - D12 - D13			



FRONT ENGINE MOUNTING - YELLOW	63139	1475868	1371729 1423012
● 4 BUS			
★ K94 - DC11 - D12 - L94			
● 4 TRUCK			
★ K94 - DSC14 13/ 15 - DC16			
● P-G-R-T TRUCK			
★ D16			



INTERCOOLER CLAMP



	Code	OEM new	OEM old
● Model	64775	1439825	
★ Application			
● 4 TRUCK			
★	CP OSC11 G03 - CP DC9 19/20/21 - CP DC11 01/02/03/04/06/07 - DC12 01/02/03/09/16 - CR94 - CR/CT DSC11 - CR/CT 144 - CR/CT 124 - CP DSC12 01/02/05 - CP D9 - CP DSC11 74/75/79 - 164 - CR 4X4/6X6 - CP DC12 03 - CR/CT DC11 01/02/03/04/06/07 - CP 19F FRONTLINE		
● 4 BUS			
★	F94 LHD/RHD		
● IND.MARINE ENGINE 4			
★	DC12 46A - DC9 - D16 40A/41A		
● IND.MARINE ENGINE 5			
★	DC9A EMS		

RADIATOR

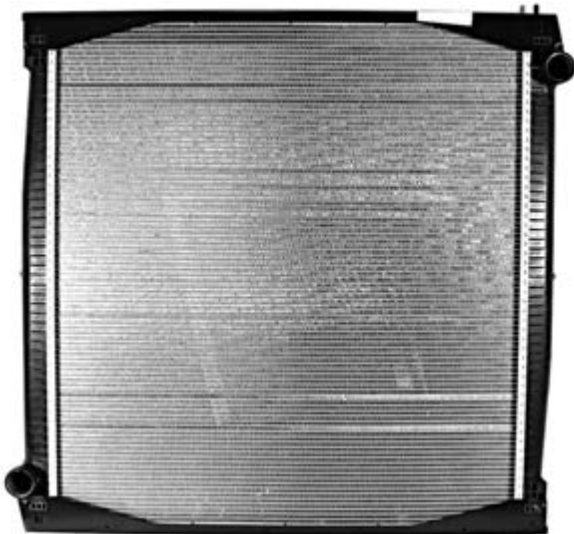

	62260	1764886	1327249 1397435 1408881 1442751 570491
● IND. MARINE ENGINE 4			
★	D16		
● 4 TRUCK			
★	CR/CT		

ALL THE COMPONENTS LISTED IN OUR CATALOGUE ARE NOT ORIGINAL, THOUGH PERFECTLY INTERCHANGEABLE. REFERENCE NUMBERS, EITHER ORIGINAL OR OF A DIFFERENT NATURE, ARE FOR INFORMATION PURPOSES ONLY. WHEN PLACING AN ORDER, PLEASE, ALWAYS USE COSIBO REFERENCE NUMBERS AND DO NOT MENTION THE ORIGINAL REFERENCE NUMBERS OF THE TRUCK MANUFACTURERS IN THE INVOICE TO VEHICLE OWNERS OR TO ANYBODY ELSE. THE CUSTOMER TAKES HIS OWN RESPONSIBILITY IF HE DOES NOT COMPLY WITH WHAT ABOVE.

RADIATOR

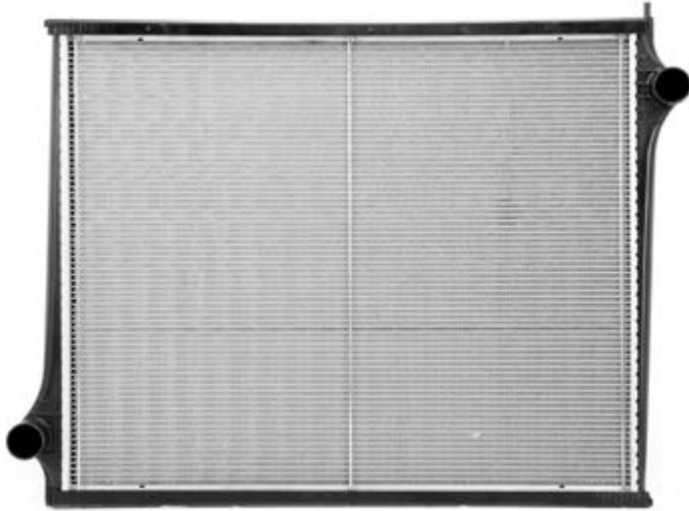

- Model
- ★ Application

Code	OEM new	OEM old
65124	1516491	1365371 1439504 570482

- **4 TRUCK**
- ★ CP
- **4 BUS**
- ★ K/L/N - DS19 E01 - N94UD - F94
- **IND. MARINE ENGINE 4**
- ★ SG9 A280
- **IND. MARINE ENGINE 5**
- ★ SG9 A280

RADIATOR



62290	1764885	1384059 1477051 570490
--------------	---------	------------------------------

- **IND. MARINE ENGINE 4**
- ★ DC12 46A - DC9 - D16 40A/41A
- **IND. MARINE ENGINE 5**
- ★
- **4 TRUCK**
- ★ CR94 - CR/CT DSC11 - CR/CT 144 - CR/CT 124 - 164 - CR 4X4/6X6 - CR/CT DC11 01/02/03/04/06/07

ALL THE COMPONENTS LISTED IN OUR CATALOGUE ARE NOT ORIGINAL, THOUGH PERFECTLY INTERCHANGEABLE. REFERENCE NUMBERS, EITHER ORIGINAL OR OF A DIFFERENT NATURE, ARE FOR INFORMATION PURPOSES ONLY. WHEN PLACING AN ORDER, PLEASE, ALWAYS USE COSIBO REFERENCE NUMBERS AND DO NOT MENTION THE ORIGINAL REFERENCE NUMBERS OF THE TRUCK MANUFACTURERS IN THE INVOICE TO VEHICLE OWNERS OR TO ANYBODY ELSE. THE CUSTOMER TAKES HIS OWN RESPONSIBILITY IF HE DOES NOT COMPLY WITH WHAT ABOVE.

RADIATOR

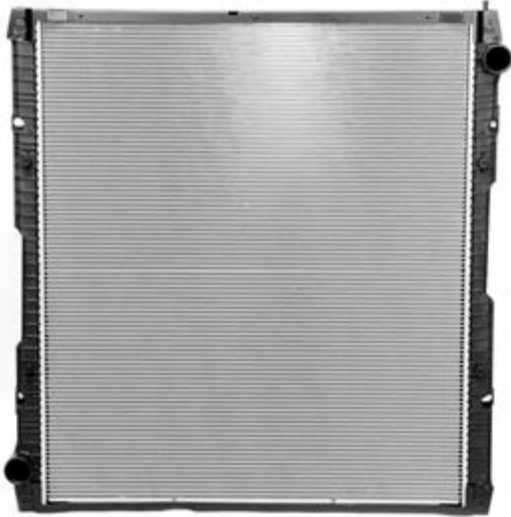

- Model
- ★ Application

Code	OEM new	OEM old
65398	1769997	1784616 1527653 1741588 570485

- P-G-R-T TRUCK
- ★ CR/CT

RADIATOR



- P-G-R-T TRUCK

- ★ D11 - D12 - CG/CR/CT - D16 - DC16 XPI

64822	1795730	1531761 1766614 1766617 1769483 1790041
--------------	---------	---

ALL THE COMPONENTS LISTED IN OUR CATALOGUE ARE NOT ORIGINAL, THOUGH PERFECTLY INTERCHANGEABLE. REFERENCE NUMBERS, EITHER ORIGINAL OR OF A DIFFERENT NATURE, ARE FOR INFORMATION PURPOSES ONLY. WHEN PLACING AN ORDER, PLEASE, ALWAYS USE COSIBO REFERENCE NUMBERS AND DO NOT MENTION THE ORIGINAL REFERENCE NUMBERS OF THE TRUCK MANUFACTURERS IN THE INVOICE TO VEHICLE OWNERS OR TO ANYBODY ELSE. THE CUSTOMER TAKES HIS OWN RESPONSIBILITY IF HE DOES NOT COMPLY WITH WHAT ABOVE.

EXPANSION TANK



	Code	OEM new	OEM old
● Model	65021	1320602	
★ Application			
● 3 BUS			
★ F93 CH 1822935			
● 3 TRUCK			
★ CR 143 CH 1173982 - CG/CP/CR 93 CH 1173982 - CP/CR 113 CH 1173982			

CAP



	61627	367761	
● 3 TRUCK			
★ CG/CP/CR/CT 93 - CP/CR/CT 113			

EXPANSION TANK FILLER CAP



	62299	367762	
● 3 BUS			
★ L/K/N 113			
● 3 TRUCK			
★ CG/CP/CR/CT 93 - CP/CR/CT 113 - CR/CT 143			
● IND. MARINE ENGINE 4			
★ DSI			

ALL THE COMPONENTS LISTED IN OUR CATALOGUE ARE NOT ORIGINAL, THOUGH PERFECTLY INTERCHANGEABLE. REFERENCE NUMBERS, EITHER ORIGINAL OR OF A DIFFERENT NATURE, ARE FOR INFORMATION PURPOSES ONLY. WHEN PLACING AN ORDER, PLEASE, ALWAYS USE COSIBO REFERENCE NUMBERS AND DO NOT MENTION THE ORIGINAL REFERENCE NUMBERS OF THE TRUCK MANUFACTURERS IN THE INVOICE TO VEHICLE OWNERS OR TO ANYBODY ELSE. THE CUSTOMER TAKES HIS OWN RESPONSIBILITY IF HE DOES NOT COMPLY WITH WHAT ABOVE.

	Code	OEM new	OEM old
RUBBER BUSHING	63194	318362	
● Model			
★ Application			
● 3 BUS			
★ F 93 CH 1822936 - F 113			
● 3 TRUCK			
★ CT 93/113/143			
● 4 BUS			
★ F 94			
● IND. MARINE ENGINE 4			
★ D16 - DS9A - DSC9A - DSC9 46/47A - DC9 51 A05E			
● IND. MARINE ENGINE 5			
★ DC9A EMS			



	60479	1363634	
RADIATOR BRACKET			
● 4 BUS			
★ K/L/N - L DS19 E01 - N 94UD - F94			
● F-K-N BUS			
★ CNUA - CNUB - K D12 - N D9 - CNUD			
● IND. MARINE ENGINE 4			
★ SG9 A280 - D16 40A/41A			
● IND. MARINE ENGINE 5			
★ SG9 A280			
● 4 TRUCK			
★ 8X8 WLS/ZLS CR - CP/CR/CT			



	61959	391555	
RADIATOR BRACKET			
● 3 TRUCK			
★ CR13 - CR19 - CP/CR113 - CR143			



ALL THE COMPONENTS LISTED IN OUR CATALOGUE ARE NOT ORIGINAL, THOUGH PERFECTLY INTERCHANGEABLE. REFERENCE NUMBERS, EITHER ORIGINAL OR OF A DIFFERENT NATURE, ARE FOR INFORMATION PURPOSES ONLY. WHEN PLACING AN ORDER, PLEASE, ALWAYS USE COSIBO REFERENCE NUMBERS AND DO NOT MENTION THE ORIGINAL REFERENCE NUMBERS OF THE TRUCK MANUFACTURERS IN THE INVOICE TO VEHICLE OWNERS OR TO ANYBODY ELSE. THE CUSTOMER TAKES HIS OWN RESPONSIBILITY IF HE DOES NOT COMPLY WITH WHAT ABOVE.

	Code	OEM new	OEM old
LH RADIATOR MOUNTING SET	64632	64632	
<ul style="list-style-type: none"> ● Model ★ Application 			
<ul style="list-style-type: none"> ● 3 TRUCK ★ CR13 CR19 CP/CR113 CR143 			



RH RADIATOR MOUNTING SET	64631	64631	
<ul style="list-style-type: none"> ● 3 TRUCK ★ CR13 CR19 CP/CR113 CR143 			



BUSHING	61077	393950	
<ul style="list-style-type: none"> ● 3 TRUCK ★ CR 13/19 - CP/CR 113 - CR 143 			



		Code	OEM new	OEM old
SENSOR	● Model	61232	309065	
	★ Application			
	● 3 BUS			
	★ F 93/113			
	● 3 TRUCK			
	★ D9/11/14 - DSC11 21/22/23 - DTC11 - CG/CP/CR/CT 93 - CP/CR/CT 113 - CR 13/19 - CR/CT 143			
● 4 BUS				
★ F 94 - DSC9				
● IND. MARINE ENGINE 4				
★ D9/11/14				



BEARING		62011	393932	
	● 3 TRUCK			
★ CR 13/19 - CP/CR 113 - CR 143				



RUBBER BUFFER		60653	308604	
	● 3 BUS			
★ F 93/113				
● 3 TRUCK				
★ DN/DS - DSC - CG/CP/CR/CT 93 - CP/CR 113 - CR/CT 143 - CR 13/19				



	Code	OEM new	OEM old
RUBBER BUSHING	60654	273793	
● Model			
★ Application			
● 3 BUS			
★ F 93/113			
● 3 TRUCK			
★ DN/DS - DSC - CP/CR/CT 93 - CP/CR 113 - CR/CT 143 - CR 13/19 - CG			
● IND. MARINE ENGINE 4			
★ D9 - D12 - D14			
● IND. MARINE ENGINE 5			
★ DC9A EMS			



	63155	219722	
RUBBER DAMPER			
● 3 BUS			
★			
● 3 TRUCK			
★			
● 4 BUS			
★			
● 4 TRUCK			
★			
● IND.MARINE ENGINE 4			
★			
● P-G-R-T TRUCK			
★			



LH RADIATOR BRACKET



	Code	OEM new	OEM old
● Model	62529	1762623	1492746
★ Application			
● F-K-N BUS			
★ F			
● P-G-R-T TRUCK			
★ CG/CR/CT D9/D11/D12/D16 - CP D9/D11/D12 - D13 - F			

RH RADIATOR BRACKET



	Code	OEM new	OEM old
	62528	1762624	1492747
● F-K-N BUS			
★ F			
● P-G-R-T TRUCK			
★ CG/CR/CT D9/D11/D12/D16 - CP D9/D11/D12 - D13 - F			

ALL THE COMPONENTS LISTED IN OUR CATALOGUE ARE NOT ORIGINAL, THOUGH PERFECTLY INTERCHANGEABLE. REFERENCE NUMBERS, EITHER ORIGINAL OR OF A DIFFERENT NATURE, ARE FOR INFORMATION PURPOSES ONLY. WHEN PLACING AN ORDER, PLEASE, ALWAYS USE COSIBO REFERENCE NUMBERS AND DO NOT MENTION THE ORIGINAL REFERENCE NUMBERS OF THE TRUCK MANUFACTURERS IN THE INVOICE TO VEHICLE OWNERS OR TO ANYBODY ELSE. THE CUSTOMER TAKES HIS OWN RESPONSIBILITY IF HE DOES NOT COMPLY WITH WHAT ABOVE.

	Code	OEM new	OEM old
RUBBER BUFFER	62274	1795583	397308
<ul style="list-style-type: none"> ● Model ★ Application 			
<ul style="list-style-type: none"> ● 3 BUS ★ F113 RH 			
<ul style="list-style-type: none"> ● IND. MARINE ENGINE 4 ★ DC9 - DI16 50M - D16M 			
<ul style="list-style-type: none"> ● 3 TRUCK ★ CR143 - DSC11 18 - CABIN CP/CR113 - CABIN CR13/19 D11 - CABIN CP/CR DSC11 21 - DSC11 21/22 (EDC/23) DTC11 - 			
<ul style="list-style-type: none"> ● 4 TRUCK ★ CABIN CP14/CR14 - R164 			
<ul style="list-style-type: none"> ● P-G-R-T TRUCK ★ CABIN CP/CG/CR 19M - CABIN CP/CG/CR 16/19 - CABIN CR16 D16 - CABIN CP/CG14 			



SCREW M12X50	64397	1757877	1344182 1117597 1328597 313228
<ul style="list-style-type: none"> ● 4 BUS ★ L 94 			
<ul style="list-style-type: none"> ● F-K-N BUS ★ 			
<ul style="list-style-type: none"> ● P-G-R-T TRUCK ★ D13 			



RUBBER BUFFER	63929	1388070	
<ul style="list-style-type: none"> ● F-K-N BUS ★ K - N XPI 			
<ul style="list-style-type: none"> ● P-G-R-T TRUCK ★ 			



	Code	OEM new	OEM old
RUBBER CAP	62220	303649	
● Model			
★ Application			
● 3 BUS			
★ DSC			
● F-K-N BUS			
★ F			
● IND. MARINE ENGINE 4			
★ DC16A			
● IND. MARINE ENGINE 5			
★ DC9A EMS - DC9 60A/68A - SG9 A280			
● 3 TRUCK			
★ CG/CP/CR/CT 93 - CP/CR/CT 113 - CP/CR/CT 143			
● 4 TRUCK			
★ DC11 01/02/03/04 - D12			



	62222	300296	
RUBBER BUSHING			
● 3 BUS			
★ DSC			
● IND. MARINE ENGINE 4			
★ DC9 - DSC11 - DSC14 - DSC/DC12 A			
● 3 TRUCK			
★ CP/CR/CT 113 - CR/CT 143			



		Code	OEM new	OEM old
CLAMP	● Model	63321	1445398	
	★ Application			
	● 4 BUS			
	★	N 94 - F 94 RHD - F 94 LHD 1X65A - 2X65A		
	● F-K-N BUS			
	★	N - N XPI - F		
	● IND. MARINE ENGINE 4			
	★	D16 40A/41A		
	● 4 TRUCK			
	★	CP OSC11 G03 - CP DC9 19/20/21 - CP DC11 01/02/03/04/06/07 - DC12 01/02/03/09/16 - CR94 - CR/CT DSC11 - CR 124 8X8 WLS/ZLS - CR/CT 144 - CR/CT 124 - CP DSC12 01/02/05 - CP D9 - CP DSC11 74/75/79 - 164 - CR 4X4 6X6 - CR/CT DC11 01/02/03/04/06/07 - CP 19F FRONTLINE		
● P-G-R-T TRUCK				
★	CG/CP/CR/CT D11/12 - D16 - D9 PDE - D9 XPI - D13			



		64017	1439822	
CLAMP	● 4 BUS			
	★	N 94 - F 94 RHD - F 94 LHD 1X65A-2X65A		
	● F-K-N BUS			
	★	N - N XPI - F		
	● IND. MARINE ENGINE 4			
	★	D16 40A/41A		
	● IND. MARINE ENGINE 5			
	★	DC9A EMS		
	● 4 TRUCK			
	★	CP OSC11 G03 - CP DC9 19/20/21 - CP DC11 01/02/03/04/06/07-DC12 01/02/03/09/16 - CR94 - CR/CT DSC11 - CR 124 8X8 WLS/ZLS - CR/CT 144 - CR/CT 124 - CP DSC12 01/02/05 - CP D9 - CP DSC11 74/75/79 - 164 - CR 4X4 6X6 - CR/CT DC11 01/02/03/04/06/07 - CP 19F FRONTLINE		
● P-G-R-T TRUCK				
★	CG/CP/CR/CT D11/12 - D16 - D9 PDE - D9 XPI - D13			



	Code	OEM new	OEM old
SILICONE HOSE	63229	412080	
● Model			
★ Application			
● 3 BUS			
★ N 113			



	Code	OEM new	OEM old
EXPANSION TANK FILLER CAP	62313	1403954	1318911
● 3 BUS			
★ F/K 93 - L/N/K/F 113 - K 113 GR801R			
● 3 TRUCK			
★ CR/CT 143 - CG/CP/CR/CT 93 - CP/CR/CT 113			
● 4 BUS			
★ K/L/N - N 94 UD - F 94			
● F-K-N BUS			
★ F/K/N			
● IND. MARINE ENGINE 4			
★ DS9A - DSC9A - DSC9 46/47A - DC9 51 A05 - ESG9 A280 - D12 - D9 - D11 - D16 - D16 M			
● IND. MARINE ENGINE 5			
★ DC9A EMS - SG9 A280			



	Code	OEM new	OEM old
SILICONE HOSE	61463	1381926	270142
● 3 BUS			
★ K 113 - K 93 - F 93 - K 113 DSC11 22 70 EDC-GR801 - K 113 DSC11 21 GR801 - K 113 GR801R - F 113 LHD/RHD			
● IND. MARINE ENGINE 4			
★			
● 3 TRUCK			
★ CG/CP/CR 93 - CP/CR/CT 113 - CR/CT 143 - CP/CR DSC11 21/22(EDC)/23-DTC11 - CP 93 GA850R ALLISON HD4060PR			



ALL THE COMPONENTS LISTED IN OUR CATALOGUE ARE NOT ORIGINAL, THOUGH PERFECTLY INTERCHANGEABLE. REFERENCE NUMBERS, EITHER ORIGINAL OR OF A DIFFERENT NATURE, ARE FOR INFORMATION PURPOSES ONLY. WHEN PLACING AN ORDER, PLEASE, ALWAYS USE COSIBO REFERENCE NUMBERS AND DO NOT MENTION THE ORIGINAL REFERENCE NUMBERS OF THE TRUCK MANUFACTURERS IN THE INVOICE TO VEHICLE OWNERS OR TO ANYBODY ELSE. THE CUSTOMER TAKES HIS OWN RESPONSIBILITY IF HE DOES NOT COMPLY WITH WHAT ABOVE.

		Code	OEM new	OEM old
SILICONE HOSE	● Model	61704	312646	
	★ Application			
	● 3 BUS			
	★	DSC11 22/70 EDC - DSC11 04/08/08B/21/23/27/71 - K 113 - L 113 - DSC - OSC11 01		
	● IND. MARINE ENGINE 4			
	★	DSC14 - DSC11		
	● 3 TRUCK			
	★	CT 93 - CP/CR/CT 113 - CR/CT 143		
● 4 TRUCK				
★	DSC14 13/15 - CP OSC11 G03 - OSC11 G03			

		63154	1433110	1423508 397999
SILICONE HOSE	● 3 BUS			
	★	DS/DSC11 - DS11 - OSC11 G01 - DSC11		
	● 4 BUS			
	★	DC11 - D12 - L 94 DSC9 - DS19 E01 - DC9 - OSC9 G01 - N 94 DSC9 - DS19 E01 - DC9 - D9		
	● IND. MARINE ENGINE 4			
	★	D12A - DC9 51A/53A/54A/55A - DI9 56A - DI16 50M		
	● 3 TRUCK			
	★	DS11 75 - DSC11 12/13/16/17/18/21/23/30/35/36 - DSC11 - DS9 4X4 - DS/ DSC9 - DTC11		
● 4 TRUCK				
★	DC11 - D12 - DSC9 - DC9 01/02/03/04/05/06			

		63175	1375718	1315195 368559
SILICONE HOSE	● 3 BUS			
	★	F 93		
	● 3 TRUCK			
	★	CG/CP/CR/CT 93 - CP/CR/CT 113 - CR 143 - CR 143 GRH880 - CP 93 GA850R ALLISON HD4060PR		

ALL THE COMPONENTS LISTED IN OUR CATALOGUE ARE NOT ORIGINAL, THOUGH PERFECTLY INTERCHANGEABLE. REFERENCE NUMBERS, EITHER ORIGINAL OR OF A DIFFERENT NATURE, ARE FOR INFORMATION PURPOSES ONLY. WHEN PLACING AN ORDER, PLEASE, ALWAYS USE COSIBO REFERENCE NUMBERS AND DO NOT MENTION THE ORIGINAL REFERENCE NUMBERS OF THE TRUCK MANUFACTURERS IN THE INVOICE TO VEHICLE OWNERS OR TO ANYBODY ELSE. THE CUSTOMER TAKES HIS OWN RESPONSIBILITY IF HE DOES NOT COMPLY WITH WHAT ABOVE.

		Code	OEM new	OEM old
SILICONE HOSE		63219	350572	
	<ul style="list-style-type: none"> ● Model ★ Application 			
	<ul style="list-style-type: none"> ● IND. MARINE ENGINE 4 ★ D14 			
	<ul style="list-style-type: none"> ● 3 TRUCK ★ CR/CT 143 			

		63297	488368	390581
SILICONE HOSE				
	<ul style="list-style-type: none"> ● 3 BUS ★ DSC11 22/70 EDC - DSC11 04/08/21/23/27/71 - L 113 - K 113 - DSC 			
	<ul style="list-style-type: none"> ● 4 BUS ★ K 94 - K 114/124 - L 94 - L 94 DC9 01/02/03/04/05/06 - L 94 DSC9 11/12/13/15 - N 94UD - L 94 OSC9 G01 - L 94 OC9 G02 			
	<ul style="list-style-type: none"> ● F-K-N BUS ★ K D9 OC9 - K D9 XPI - K D11/D12 OC11 OC12 - K DT12 			
	<ul style="list-style-type: none"> ● IND. MARINE ENGINE 4 ★ SG9 A280 - DSC14 - DC12 - DSC11 OK 			
	<ul style="list-style-type: none"> ● IND. MARINE ENGINE 5 ★ SG9 A280 - DC9A EMS 			
	<ul style="list-style-type: none"> ● 3 TRUCK ★ CG/CP/CR/CT 93 - CP/CR/CT 113 - CR/CT 143 - HK/MK - DSC11 18/22/30 			

		63300	373210	
SILICONE HOSE				
	<ul style="list-style-type: none"> ● 3 TRUCK ★ DS11 73 - CP/CR 113 - CR/CT 143 			

ALL THE COMPONENTS LISTED IN OUR CATALOGUE ARE NOT ORIGINAL, THOUGH PERFECTLY INTERCHANGEABLE. REFERENCE NUMBERS, EITHER ORIGINAL OR OF A DIFFERENT NATURE, ARE FOR INFORMATION PURPOSES ONLY. WHEN PLACING AN ORDER, PLEASE, ALWAYS USE COSIBO REFERENCE NUMBERS AND DO NOT MENTION THE ORIGINAL REFERENCE NUMBERS OF THE TRUCK MANUFACTURERS IN THE INVOICE TO VEHICLE OWNERS OR TO ANYBODY ELSE. THE CUSTOMER TAKES HIS OWN RESPONSIBILITY IF HE DOES NOT COMPLY WITH WHAT ABOVE.

		Code	OEM new	OEM old
SILICONE HOSE	● Model	63301	375527	
	★ Application			
	● 3 BUS			
	★	DSI11 - DSC11 04/27/71 - L 113		
	● 3 TRUCK			
	★	CP/CR/CT 113 - CP/CR 113 4X4 6X6 - DSC11 18/22/30		

		65002	1522011	1442579 1522010
SILICONE HOSE	● 4 BUS			
	★	N 94 - F 94 RHD - F 94 LHD 1X65A-2X65A		
	● F-K-N BUS			
	★	N - N XPI - F		
	● IND. MARINE ENGINE 4			
	★	D16 40A/41A		
	● 4 TRUCK			
	★	CP OSC11 G03 - CP DC9 19/20/21 - CP DC11 01/02/03/04/06/07 - DC12 01/02/03/09/16 - CR94 - CR/CT DSC11 - CR 124 8X8 WLS/ZLS - CR/CT 144 - CR/CT 124 - CP DSC12 01/02/05 - CP D9 - CP DSC11 74/75/79 - 164 - CR 4X4 6X6 - CR/CT DC11 01/02/03/04/06/07 - CP 19F FRONTLINE		
	● P-G-R-T TRUCK			
	★	CG/CP/CR/CT D11/12 - D16 - D9 PDE - D9 XPI - D13		

ALL THE COMPONENTS LISTED IN OUR CATALOGUE ARE NOT ORIGINAL, THOUGH PERFECTLY INTERCHANGEABLE. REFERENCE NUMBERS, EITHER ORIGINAL OR OF A DIFFERENT NATURE, ARE FOR INFORMATION PURPOSES ONLY. WHEN PLACING AN ORDER, PLEASE, ALWAYS USE COSIBO REFERENCE NUMBERS AND DO NOT MENTION THE ORIGINAL REFERENCE NUMBERS OF THE TRUCK MANUFACTURERS IN THE INVOICE TO VEHICLE OWNERS OR TO ANYBODY ELSE. THE CUSTOMER TAKES HIS OWN RESPONSIBILITY IF HE DOES NOT COMPLY WITH WHAT ABOVE.

		Code	OEM new	OEM old
SILICONE HOSE 	● Model	65092	1525145	
	★ Application			
	● 4 BUS			
	★ N 94 - F 94 RHD - F 94 LHD 1X65A - 2X65A			
	● F-K-N BUS			
	★ N - N XPI - F			
	● IND. MARINE ENGINE 4			
	★ D16 40A/41A			
	● 4 TRUCK			
	★ CP OSC11 G03 - CP DC9 19/20/21 - CP DC11 01/02/03/04/06/07 - DC12 01/02/03/09/16 - CR94 - CR/CT DSC11 - CR 124 8X8 WLS/ZLS - CR/CT 144 - CR/CT 124 - CP DSC12 01/02/05 - CP D9 - CP DSC11 74/75/79 - 164 - CR 4X4 6X6 - CR/CT DC11 01/02/03/04/06/07 - CP 19F FRONTLINE			
● P-G-R-T TRUCK				
★ CG/CP/CR/CT D11/12 - D16 - D9 PDE - D9 XPI - D13				

		65099	1794725	
SILICONE HOSE 	● 4 BUS			
	★ N 94 - F 94 RHD - F 94 LHD 1X65A - 2X65A			
	● F-K-N BUS			
	★ N - N XPI - F			
	● IND. MARINE ENGINE 4			
	★ D16 40A/41A			
	● 4 TRUCK			
	★ CP OSC11 G03 - CP DC9 19/20/21 - CP DC11 01/02/03/04/06/07 - DC12 01/02/03/09/16 - CR94 - CR/CT DSC11 - CR 124 8X8 WLS/ZLS - CR/CT 144 - CR/CT 124 - CP DSC12 01/02/05 - CP D9 - CP DSC11 74/75/79 - 164 - CR 4X4 6X6 - CR/CT DC11 01/02/03/04/06/07 - CP 19F FRONTLINE			
	● P-G-R-T TRUCK			
	★ CG/CP/CR/CT D11/12 - D16 - D9 PDE - D9 XPI - D13			

		Code	OEM new	OEM old
SILICON HOSE	● Model	64861	1809771	
	★ Application			
	● 4 BUS			
	★ F94 - N94			
	● 4 TRUCK			
	★ 124-144-164 - D9 - DC9 19/20/21 - DC11 01/02/03/04/06/07 - DC12 01/02/03/09/16 CR94 - DSC11 - DSC11 74/75/79 - DSC12 01/02/05 - CP19F FRONTLINE - OSC11 G03			
	● F-K-N BUS			
	★ F - N - N XPI - K D9/13 PB/BR - OC9			
	● IND.MARINE ENGINE 4			
	★ D16 40A/41A			
● P-G-R-T TRUCK				
★ D9 XPI - D11 - D12 CG/CP/CR/CT - D13/D16 - D13 CP - D16				



		65371	1379888	
SILICONE HOSE	● 4 TRUCK			
	★ DSC12 01/02/03/05 - DC11 01/02 - D11			
	● P-G-R-T TRUCK			
	★ D11/12			
	● 4 BUS			
★ DSC12 02/05 - D11/12				



		61703	297394	
RUBBER HOSE	● 3 BUS			
	★ K 113 - GR801 - GR801R - DS11 34 - DSC11 21/22/70			
	● 3 TRUCK			
	★ CR/CT 143 - GRH880			
	● 4 BUS			
	★ N 94 - N 94 UD - N/CN			
	● IND. MARINE ENGINE 4			
	★ D12 - D12A - D16			
● IND. MARINE ENGINE 5				
★ DC9 EMS				



ALL THE COMPONENTS LISTED IN OUR CATALOGUE ARE NOT ORIGINAL, THOUGH PERFECTLY INTERCHANGEABLE. REFERENCE NUMBERS, EITHER ORIGINAL OR OF A DIFFERENT NATURE, ARE FOR INFORMATION PURPOSES ONLY. WHEN PLACING AN ORDER, PLEASE, ALWAYS USE COSIBO REFERENCE NUMBERS AND DO NOT MENTION THE ORIGINAL REFERENCE NUMBERS OF THE TRUCK MANUFACTURERS IN THE INVOICE TO VEHICLE OWNERS OR TO ANYBODY ELSE. THE CUSTOMER TAKES HIS OWN RESPONSIBILITY IF HE DOES NOT COMPLY WITH WHAT ABOVE.

		Code	OEM new	OEM old
O-RING	● Model	64777	1373126	
	★ Application			
	● 4 BUS			
	★ F94 LHD/RHD			
	● IND. MARINE ENGINE 4			
	★ DC12 46A - DC9 - D16 40A/41A			
● IND. MARINE ENGINE 5				
★ DC9A EMS				
● 4 TRUCK				
★ CP OSC11 G03 - CP DC9 19/20/21 - CP DC11 01/02/03/04/06/07 - DC12 01/02/03/09/16 - CR94 - CR/CT DSC11 - 8X8 WLS/ZLS CR 124 - CR/CT 144 - CR/CT 124 - CP DSC12 01/02/05 - CP D9/DC12 03 - CP DSC11 74/75/79 - 164 - CR 4X4/6X6 - CR/CT DC11 01/02/03/04/06/07 - CP 19F FRONTLINE				

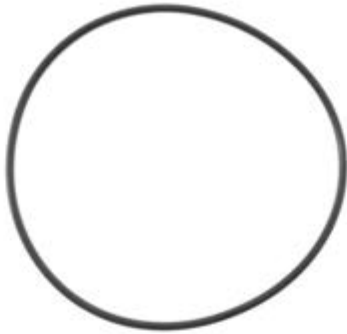

		64778	1331820	
O-RING	● 4 BUS			
	★ DSC9 - DS19 E01 - DC9 01/02/03/04/05/06 - L94 OSC9 G01 - DSC11 - OSC11 G03 - L94/N94 DS19 E01 - K94/114/124 - L94 DC9 01/02/03/04/05/06 - F94 LHD - L94 DSC9 11/12/13/15 - N94UD - L94 OC9 G02 - L94UA - CL94			
	● F-K-N BUS			
	★ K D11/D12 OC11/OC12 - K D9 OC9 - N - F - CKUB - CNUD			
	● IND. MARINE ENGINE 4			
	★ SG9 A280 - DI16 40A/41A/48A/53A - DI16 50M - D16 M - DI12 49A - DC12A EMS - DC12 46A/54A/55A/57A/58A/59A/60A - SGI12A - DSI 12A - DC9 51/53 - DSI14 69M - DI14 82M - DSC/DC 12A			
	● IND. MARINE ENGINE 5			
	★ SG9 A280 - DC9A EMS			
	● 4 TRUCK			
	★ DSC9 - DS19 E01 - DC9 01/02/03/04/05/06 - OSC9 G01 - DSC11 - OSC11 G03 - CP D9/DC9 19/20/21 - CP DC11 01/02/03/04/06/07 - DC12 01/02/03/09/16 - CR94 - CR/CT DSC11 - 8X8 WLS/ZLS CR 124 - CR/CT 124 - CP DSC12 01/02/05 - CP DSC11 74/75/79 - CR 4X4/6X6 - CP DC12 03 - CR/CT DC11 01/02/03/04/06			
● P-G-R-T TRUCK				
★ CG/CR/CT D11/12 - D9 PDE - CP D11/D12				

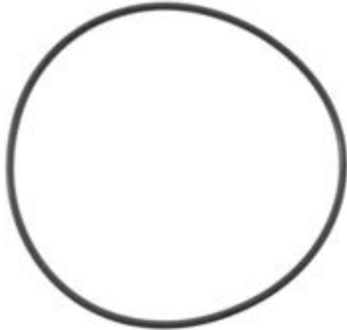

EXPANSION TANK



- Model
- ★ Application

Code

OEM new

OEM old

60359

1894478

1421090
1492421
1511775
1765735
1855164

- 4 TRUCK

- ★ CR D16 - CP/CR/CT

- P-G-R-T TRUCK

- ★ PDE - HPI

EXPANSION TANK PLUG W/VALVE



64054

1849428

1757490
1874363

- 4 TRUCK

- ★ CR D16 - CP/CR/CT

- P-G-R-T TRUCK

- ★ PDE - HPI

ALL THE COMPONENTS LISTED IN OUR CATALOGUE ARE NOT ORIGINAL, THOUGH PERFECTLY INTERCHANGEABLE. REFERENCE NUMBERS, EITHER ORIGINAL OR OF A DIFFERENT NATURE, ARE FOR INFORMATION PURPOSES ONLY. WHEN PLACING AN ORDER, PLEASE, ALWAYS USE COSIBO REFERENCE NUMBERS AND DO NOT MENTION THE ORIGINAL REFERENCE NUMBERS OF THE TRUCK MANUFACTURERS IN THE INVOICE TO VEHICLE OWNERS OR TO ANYBODY ELSE. THE CUSTOMER TAKES HIS OWN RESPONSIBILITY IF HE DOES NOT COMPLY WITH WHAT ABOVE.

		Code	OEM new	OEM old
CAP	● Model	62397	308678	
	★ Application			
	● 3 BUS			
	★			
	● 3 TRUCK			
	★			
	● 4 TRUCK			
★	DSC9 - DC9 - CP19 F - FRONTLINE - T 164			
● IND. MARINE ENGINE 4				
★	D12 A/M - D9 A/M - DC16 A			



		Code	OEM new	OEM old
CAP		62512	1371839	295960
	● P-G-R-T TRUCK			
	★			



VISCO FAN



- Model
- ★ Application

Code	OEM new	OEM old
64832	1766909	1422502

- 4 TRUCK
- ★ DC16

VISCO FAN



- P-G-R-T TRUCK

64833	2132266	1453967 1856995 2052003
-------	---------	-------------------------------

- ★ D11/12 - D16

VISCO FAN WITH FITTING SET



- P-G-R-T TRUCK

64833/K	64833/K	
---------	---------	--

- ★ D11/12 - D16

ALL THE COMPONENTS LISTED IN OUR CATALOGUE ARE NOT ORIGINAL, THOUGH PERFECTLY INTERCHANGEABLE. REFERENCE NUMBERS, EITHER ORIGINAL OR OF A DIFFERENT NATURE, ARE FOR INFORMATION PURPOSES ONLY. WHEN PLACING AN ORDER, PLEASE, ALWAYS USE COSIBO REFERENCE NUMBERS AND DO NOT MENTION THE ORIGINAL REFERENCE NUMBERS OF THE TRUCK MANUFACTURERS IN THE INVOICE TO VEHICLE OWNERS OR TO ANYBODY ELSE. THE CUSTOMER TAKES HIS OWN RESPONSIBILITY IF HE DOES NOT COMPLY WITH WHAT ABOVE.

	Code	OEM new	OEM old
FITTING SET	64839	64839	
<ul style="list-style-type: none"> ● Model ★ Application 			
<ul style="list-style-type: none"> ● P-G-R-T TRUCK ★ D11/12 - D16 			



	63786	1412398	1402869
VISCO FAN			
<ul style="list-style-type: none"> ● F-K-N BUS ★ F 			
<ul style="list-style-type: none"> ● 4 TRUCK ★ DC9 19/20/21 - CP/CR/CT114/124 - DC12 01/02/03/09 - DT12 02/08/10/16 - DC11 01/02/03/04/06/07 			
<ul style="list-style-type: none"> ● P-G-R-T TRUCK ★ D9 PDE 			



	64833	2132266	1453967 1856995 2052003
VISCO FAN			
<ul style="list-style-type: none"> ● P-G-R-T TRUCK ★ D11 - D12 - D16 WITH 8 BLADES 			



ALL THE COMPONENTS LISTED IN OUR CATALOGUE ARE NOT ORIGINAL, THOUGH PERFECTLY INTERCHANGEABLE. REFERENCE NUMBERS, EITHER ORIGINAL OR OF A DIFFERENT NATURE, ARE FOR INFORMATION PURPOSES ONLY. WHEN PLACING AN ORDER, PLEASE, ALWAYS USE COSIBO REFERENCE NUMBERS AND DO NOT MENTION THE ORIGINAL REFERENCE NUMBERS OF THE TRUCK MANUFACTURERS IN THE INVOICE TO VEHICLE OWNERS OR TO ANYBODY ELSE. THE CUSTOMER TAKES HIS OWN RESPONSIBILITY IF HE DOES NOT COMPLY WITH WHAT ABOVE.

VISCO FAN



	Code	OEM new	OEM old
● Model	64156	1392261	1393424
★ Application			
● 4 TRUCK			
★	CR/CT 124-DSC12 01/02/05/06 - CR/CP/CT 124-DC12 01/02/03/09-DT12 02/08/10/16-DC16 - CP/CR/CT 114-DC11 03/04/06		
● IND.MARINI ENGINE 4			
★	DC16		
● P-G-R-T TRUCK			
★	D16 - D11-D12		

VISCO FAN



	Code	OEM new	OEM old
	64834	2132264	1763618
● P-G-R-T TRUCK			
★	D11 - D12 - D16 WITH 11 BLADES		

FAN COVER



	Code	OEM new	OEM old
	62553	1390706	
● 4 TRUCK			
★	CR/CT D12 - DC11 03/04/06 CH 6221004 - CH 8030600 - CH 6187808 - 6221003 - CH 8024382 - 8030599 - CR/CT 144 - CR/CT 124 CH 6187807		

ALL THE COMPONENTS LISTED IN OUR CATALOGUE ARE NOT ORIGINAL, THOUGH PERFECTLY INTERCHANGEABLE. REFERENCE NUMBERS, EITHER ORIGINAL OR OF A DIFFERENT NATURE, ARE FOR INFORMATION PURPOSES ONLY. WHEN PLACING AN ORDER, PLEASE, ALWAYS USE COSIBO REFERENCE NUMBERS AND DO NOT MENTION THE ORIGINAL REFERENCE NUMBERS OF THE TRUCK MANUFACTURERS IN THE INVOICE TO VEHICLE OWNERS OR TO ANYBODY ELSE. THE CUSTOMER TAKES HIS OWN RESPONSIBILITY IF HE DOES NOT COMPLY WITH WHAT ABOVE.

FAN CONVEYOR



- Model
- ★ Application

Code

OEM new

OEM old

64648

1332193

- IND. MARINE ENGINE 4

- ★ SG9 A280

- 4 TRUCK

- ★ CP D12 - DC11 01/02/03/04/06/07 - CP D11/12 4X4/6X6 - CP DC9 19/20/21 - CP/CR/CT DSC11 74/75/79 - CP/CR/CT OSC11 G03 260 HP - CP94 - CP94 FRONTLINE

FAN COVER



65325

1390705

1349968

- 4 TRUCK

- ★ CR/CT D12 - DC11 03/04/06 - CR/CT 144 - CR/CT 124

FAN COVER



- Model
- ★ Application

Code

OEM new

OEM old

65360

1769522

1444954

- P-G-R-T TRUCK

- ★ DC9 18 FOR CP CAB - D11/12 FOR CP CAB - D9 XPI

FAN COVER



- P-G-R-T TRUCK

- ★ D11 - D12 - CG/CP/CR

65525

1446239

FAN RING



- **Model**
- ★ **Application**

Code	OEM new	OEM old
64647	1486148	1434106

- **4 TRUCK**

- ★ CP - CP/CR/CT DSC11 74/75/79 - CP/CR/CT OSC11 G03 260HP - CP/CR94 - CP94 FRONTLINE - CR/CT DC11 01/02/07

FAN RING



- **4 TRUCK**

- ★ CR/CT 144 - CR/CT 124 - DC16

65320	1511832	1440404
--------------	---------	---------

ALL THE COMPONENTS LISTED IN OUR CATALOGUE ARE NOT ORIGINAL, THOUGH PERFECTLY INTERCHANGEABLE. REFERENCE NUMBERS, EITHER ORIGINAL OR OF A DIFFERENT NATURE, ARE FOR INFORMATION PURPOSES ONLY. WHEN PLACING AN ORDER, PLEASE, ALWAYS USE COSIBO REFERENCE NUMBERS AND DO NOT MENTION THE ORIGINAL REFERENCE NUMBERS OF THE TRUCK MANUFACTURERS IN THE INVOICE TO VEHICLE OWNERS OR TO ANYBODY ELSE. THE CUSTOMER TAKES HIS OWN RESPONSIBILITY IF HE DOES NOT COMPLY WITH WHAT ABOVE.

	Code	OEM new	OEM old
FAN RING	64374	1530783	
● Model			
★ Application			
● 4 TRUCK			
★ CP - D12 - DC11 01/02/03/04/06/07 - CR/CT DC11 01/02/07 - CP DC9 19/20/21			
● F-K-N BUS			
★ F			
● P-G-R-T TRUCK			
★ D9 PDE			



FAN RUBBER RING	66579/1	1373520	
● 4 BUS			
★ F 94			



FAN RUBBER RING



	Code	OEM new	OEM old
● Model	64649	1440406	
★ Application			
● F-K-N BUS			
★ F			
● 4 TRUCK			
★ CP D12 - DC11 01/02/03/04/06/07 - CP D11/12 4X4/6X6 - CR 124 4X4/6X6 - CR/CT DC11 01/02/07 - CP DC9 19/20/21 - CP/CR/CT DSC11 74/75/79 - CP/CR/CT OSC11 G03 260HP - CP/CR 94 - CP 94 FRONTLINE			
● P-G-R-T TRUCK			
★ D9 PDE - CP/CR D11/12 AWD - D11/D12			

FAN RUBBER RING





	65319	1440407	1371782 1397796
● F-K-N BUS			
★ D9 XPI			
● IND. MARINE ENGINE 4			
★ DC16 - DS12 40 A01			
● 4 TRUCK			
★ CR/CT D12 - DC11 03/04/06 - 8X8 WLS/ZLS CR D12 - CR/CT 144 - CR/CT 124 - DC16			
● P-G-R-T TRUCK			
★ D11/12 - D16 - CP/CR D11/12 AWD - D13 - D9 XPI			

FAN FRAME BRACKET





	64034	1374500	
● 4 BUS			
★ F94			
● 4 TRUCK			
★ 144 CR/CT - 124 CR/CT - CP 94/CR94 - CP94 FRONTLINE - CR/CT/CP DSC11 74/75/79 - CR/CT/CP - OSC11 G03/260 - CR/CT - DC11 01/02/07			

ALL THE COMPONENTS LISTED IN OUR CATALOGUE ARE NOT ORIGINAL, THOUGH PERFECTLY INTERCHANGEABLE. REFERENCE NUMBERS, EITHER ORIGINAL OR OF A DIFFERENT NATURE, ARE FOR INFORMATION PURPOSES ONLY. WHEN PLACING AN ORDER, PLEASE, ALWAYS USE COSIBO REFERENCE NUMBERS AND DO NOT MENTION THE ORIGINAL REFERENCE NUMBERS OF THE TRUCK MANUFACTURERS IN THE INVOICE TO VEHICLE OWNERS OR TO ANYBODY ELSE. THE CUSTOMER TAKES HIS OWN RESPONSIBILITY IF HE DOES NOT COMPLY WITH WHAT ABOVE.

	Code	OEM new	OEM old
OIL SEAL 42x72x8	60998	1109871	170226 310953
	<ul style="list-style-type: none"> ● Model ★ Application 		
	<ul style="list-style-type: none"> ● IND. MARINE ENGINE 4 ★ D14A/M 		
	<ul style="list-style-type: none"> ● 3 TRUCK ★ CR/CT 143 - DSC14 08 GR/GS900R - DSC14 08/09/10 		
OIL SEAL 25x47x7	60999	170761	
	<ul style="list-style-type: none"> ● A.22.5 ★ 		
	<ul style="list-style-type: none"> ● 3 TRUCK ★ D14 - DS14 		

ALL THE COMPONENTS LISTED IN OUR CATALOGUE ARE NOT ORIGINAL, THOUGH PERFECTLY INTERCHANGEABLE. REFERENCE NUMBERS, EITHER ORIGINAL OR OF A DIFFERENT NATURE, ARE FOR INFORMATION PURPOSES ONLY. WHEN PLACING AN ORDER, PLEASE, ALWAYS USE COSIBO REFERENCE NUMBERS AND DO NOT MENTION THE ORIGINAL REFERENCE NUMBERS OF THE TRUCK MANUFACTURERS IN THE INVOICE TO VEHICLE OWNERS OR TO ANYBODY ELSE. THE CUSTOMER TAKES HIS OWN RESPONSIBILITY IF HE DOES NOT COMPLY WITH WHAT ABOVE.

		Code	OEM new	OEM old
BELT TENSIONER	● Model	63652	1859654	1493670
	★ Application			1503113 1545982 1774651
	● 4 BUS			
	★			K/R/L/N94 - K114/124
	● IND. MARINE ENGINE 4			
	★			SG9 A280 - D12A/M - DC12 57A - D9A/M
	● 4 TRUCK			
	★			DC11/DC12 - D11/D12/D14 - DSC11 74/75/79 - OSC11 G03/260HP - DC11 01/02/03/04

BELT TENSIONER		63858	2197003	1859655
				1476395 1503114 1545983 1774652
	● IND. MARINE ENGINE 4			
	★			D16A/M - D116 45M/48A/53A
	● 4 TRUCK			
	★			D16
	● P-G-R-T TRUCK			
	★			D16

ALL THE COMPONENTS LISTED IN OUR CATALOGUE ARE NOT ORIGINAL, THOUGH PERFECTLY INTERCHANGEABLE. REFERENCE NUMBERS, EITHER ORIGINAL OR OF A DIFFERENT NATURE, ARE FOR INFORMATION PURPOSES ONLY. WHEN PLACING AN ORDER, PLEASE, ALWAYS USE COSIBO REFERENCE NUMBERS AND DO NOT MENTION THE ORIGINAL REFERENCE NUMBERS OF THE TRUCK MANUFACTURERS IN THE INVOICE TO VEHICLE OWNERS OR TO ANYBODY ELSE. THE CUSTOMER TAKES HIS OWN RESPONSIBILITY IF HE DOES NOT COMPLY WITH WHAT ABOVE.

		Code	OEM new	OEM old
BELT TENSIONER	● Model	64185	1859657	1774654
	★ Application			
	● 4 BUS			
	★ DC9 19/20/21			
	● F-K-N BUS			
	★ 2X100A - 2X150A - F 1X100A			
	● IND. MARINE ENGINE 4			
	★ DC12 50A			
	● IND. MARINE ENGINE 5			
	★ DC9A EMS - SG9 A280			
● 3 TRUCK				
★ DC9 19/20/21 - D9				
● P-G-R-T TRUCK				
★ D9/D11/D12				



BELT TENSIONER		64998	2197007	1859656 1545984 1774653
	● IND. MARINE ENGINE 4			
	★			
	● IND. MARINE ENGINE 5			
	★ DC9A EMS			
	● 4 TRUCK			
	★ D16			
	● P-G-R-T TRUCK			
	★ D16			



BELT TENSIONER		65547	2197390	2191990 1870552
	● IND. MARINE ENGINE 5			
	★ P96 - D16M			
	● P-G-R-T TRUCK			
	★ D13			



ALL THE COMPONENTS LISTED IN OUR CATALOGUE ARE NOT ORIGINAL, THOUGH PERFECTLY INTERCHANGEABLE. REFERENCE NUMBERS, EITHER ORIGINAL OR OF A DIFFERENT NATURE, ARE FOR INFORMATION PURPOSES ONLY. WHEN PLACING AN ORDER, PLEASE, ALWAYS USE COSIBO REFERENCE NUMBERS AND DO NOT MENTION THE ORIGINAL REFERENCE NUMBERS OF THE TRUCK MANUFACTURERS IN THE INVOICE TO VEHICLE OWNERS OR TO ANYBODY ELSE. THE CUSTOMER TAKES HIS OWN RESPONSIBILITY IF HE DOES NOT COMPLY WITH WHAT ABOVE.

	Code	OEM new	OEM old
BELT TENSIONER	65459	2191989	1870551
<ul style="list-style-type: none"> ● Model ★ Application 			
<ul style="list-style-type: none"> ● P-G-R-T TRUCK ★ D13 - DC16 XPI 			



	63292	1514086	1428940
BELT TENSIONER ROLLER			
<ul style="list-style-type: none"> ● 4 BUS ★ K/L/N94 65A/140A/2X140A - K114/124 			
<ul style="list-style-type: none"> ● IND. MARINE ENGINE 4 ★ D9/12/16 A/M - DC12 57A - DI16 45M 			
<ul style="list-style-type: none"> ● 4 TRUCK ★ DC11/DC12 - D12/14/16 - DSC11 74/75/79 - OSC11 G03/260HP - DC11 01/02/03/04 			
<ul style="list-style-type: none"> ● P-G-R-T TRUCK ★ D16 			



	63384	1514087	1413609 1428941
BELT TENSIONER ROLLER			
<ul style="list-style-type: none"> ● 4 BUS ★ K/L/N94 65A/140A/2X140A 			
<ul style="list-style-type: none"> ● IND. MARINE ENGINE 4 ★ SG9 A280 - D9/12/16 A/M - DI16 45M 			
<ul style="list-style-type: none"> ● 4 TRUCK ★ D11/D12/D16 - DC11 			
<ul style="list-style-type: none"> ● P-G-R-T TRUCK ★ D16 			



		Code	OEM new	OEM old
BELT TENSIONER ROLLER	● Model	64066	1858884	1510698 1795774
	★ Application			
	● 4 BUS			
	★ DC9 19/20/21			
	● F-K-N BUS			
	★ 2X100A - F 1X100A			
	● IND. MARINE ENGINE 4			
	★ DC12 50A			
	● IND. MARINE ENGINE 5			
	★ DC9A EMS - SG9 A280			
● 4 TRUCK				
★ DC9 19/20/21 - D9				
● P-G-R-T TRUCK				
★ D9/D11/D12				



BELT TENSIONER ROLLER		64251	1858885	1510697 1512749 1795775
	● 4 BUS			
	★ DC9 19/20/21			
	● F-K-N BUS			
	★ 2X100A - 2X150A - F 1X100A			
	● IND. MARINE ENGINE 4			
	★ D12A/M - DC12 50A			
	● IND. MARINE ENGINE 5			
	★ DC9A EMS - SG9 A280			
	● 4 TRUCK			
★ DC9 19/20/21 - D9 - DC11/DC12				
● P-G-R-T TRUCK				
★ D9/D11/D12/D13				



V-BELT L=2160

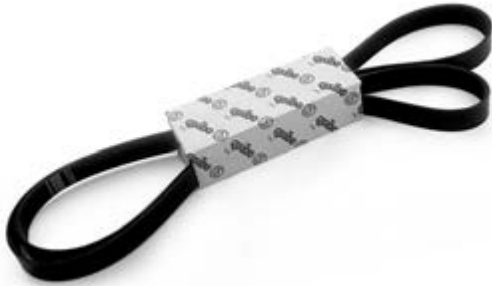

	Code	OEM new	OEM old
● Model	60129	1800538	1389042 1530980
★ Application			
● 4 BUS			
★ DC9 19/20/21			
● F-K-N BUS			
★ 2X100A			
● 4 TRUCK			
★ DSC11 74/75/79 - OSC11 G03/260HP			

V-BELT L=1600



	60484	814210	
● 3 BUS			
★ DSC11			
● IND. MARINE ENGINE 4			
★			
● 3 TRUCK			
★ CT113			

V-BELT L=1575

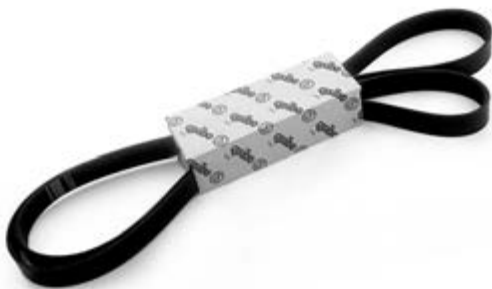

	61322	814209	
● 3 BUS			
★ L113 - DSC11			
● IND. MARINE ENGINE 4			
★ ENG 5366480			

ALL THE COMPONENTS LISTED IN OUR CATALOGUE ARE NOT ORIGINAL, THOUGH PERFECTLY INTERCHANGEABLE. REFERENCE NUMBERS, EITHER ORIGINAL OR OF A DIFFERENT NATURE, ARE FOR INFORMATION PURPOSES ONLY. WHEN PLACING AN ORDER, PLEASE, ALWAYS USE COSIBO REFERENCE NUMBERS AND DO NOT MENTION THE ORIGINAL REFERENCE NUMBERS OF THE TRUCK MANUFACTURERS IN THE INVOICE TO VEHICLE OWNERS OR TO ANYBODY ELSE. THE CUSTOMER TAKES HIS OWN RESPONSIBILITY IF HE DOES NOT COMPLY WITH WHAT ABOVE.

V-BELT L=1985

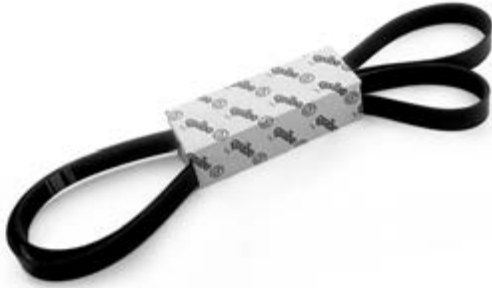

	Code	OEM new	OEM old
● Model	63639	1800521	1389028 1454280 1888463
★ Application			
● IND. MARINE ENGINE 4			
★ D9A/M - D16M - DI16 45M			
● 4 TRUCK			
★ D12 - DC11 01/02/03/04 - WITH AIR CONDITIONING			

V-BELT L=2220

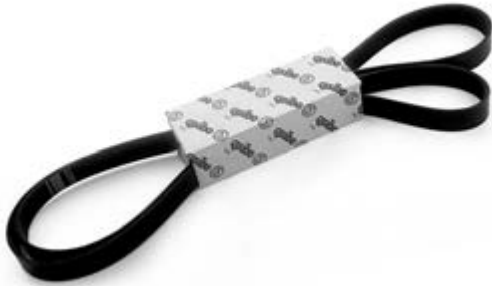

	Code	OEM new	OEM old
	63640	1803333	1389031 1530979
● 4 TRUCK			
★ D14 144 WITH AIR CONDITIONING			

V-BELT L=1535

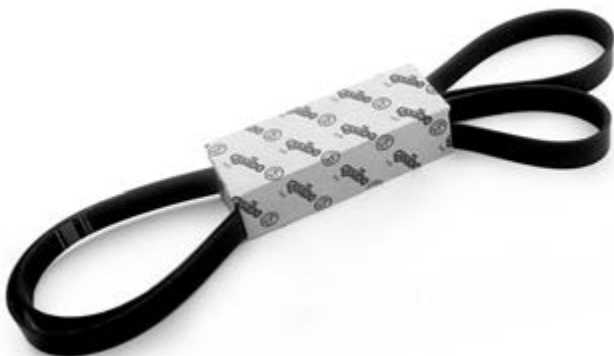

	Code	OEM new	OEM old
	63966	1888464	1389029 1454281 1800522
● 4 TRUCK			
★ DC11 - D12 - WITHOUT AIR CONDITIONING			

ALL THE COMPONENTS LISTED IN OUR CATALOGUE ARE NOT ORIGINAL, THOUGH PERFECTLY INTERCHANGEABLE. REFERENCE NUMBERS, EITHER ORIGINAL OR OF A DIFFERENT NATURE, ARE FOR INFORMATION PURPOSES ONLY. WHEN PLACING AN ORDER, PLEASE, ALWAYS USE COSIBO REFERENCE NUMBERS AND DO NOT MENTION THE ORIGINAL REFERENCE NUMBERS OF THE TRUCK MANUFACTURERS IN THE INVOICE TO VEHICLE OWNERS OR TO ANYBODY ELSE. THE CUSTOMER TAKES HIS OWN RESPONSIBILITY IF HE DOES NOT COMPLY WITH WHAT ABOVE.

V-BELT L=1580

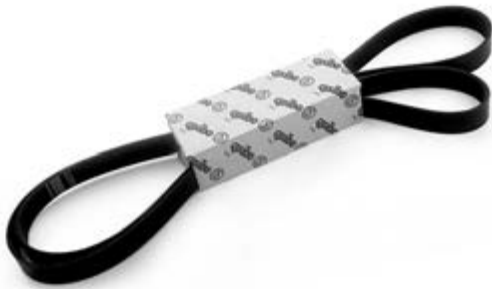

	Code	OEM new	OEM old
● Model	63967	1800539	1530981
★ Application			
● 4 TRUCK			
★	DSC11 74/75/79 - OSC11 G03/260HP - WITHOUT AIR CONDITIONING		

V-BELT L=1795

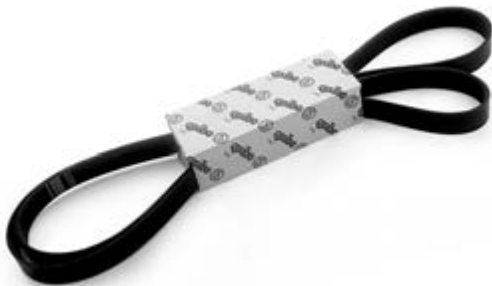

	Code	OEM new	OEM old
	63969	1888465	1514865 1800533
● IND. MARINE ENGINE 4			
★	D16A		
● IND. MARINE ENGINE 5			
★	DC9A EMS		
● 4 TRUCK			
★	DC11/12 WITH AIR CONDITIONING - D16		
● P-G-R-T TRUCK			
★	D16		

V-BELT L=1520

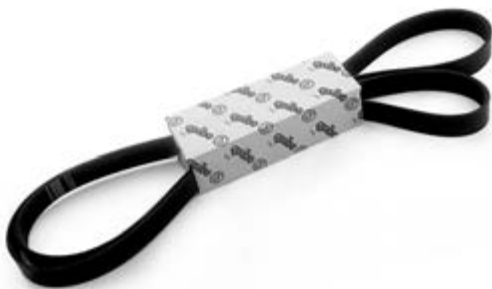

	Code	OEM new	OEM old
	64121	1800535	1354390 1519788 1530973 1803332
● 4 BUS			
★	K114/124 - D11		
● 4 TRUCK			
★	D11/D12 - WITHOUT AIR CONDITIONING		

ALL THE COMPONENTS LISTED IN OUR CATALOGUE ARE NOT ORIGINAL, THOUGH PERFECTLY INTERCHANGEABLE. REFERENCE NUMBERS, EITHER ORIGINAL OR OF A DIFFERENT NATURE, ARE FOR INFORMATION PURPOSES ONLY. WHEN PLACING AN ORDER, PLEASE, ALWAYS USE COSIBO REFERENCE NUMBERS AND DO NOT MENTION THE ORIGINAL REFERENCE NUMBERS OF THE TRUCK MANUFACTURERS IN THE INVOICE TO VEHICLE OWNERS OR TO ANYBODY ELSE. THE CUSTOMER TAKES HIS OWN RESPONSIBILITY IF HE DOES NOT COMPLY WITH WHAT ABOVE.

V-BELT L=2575 MM

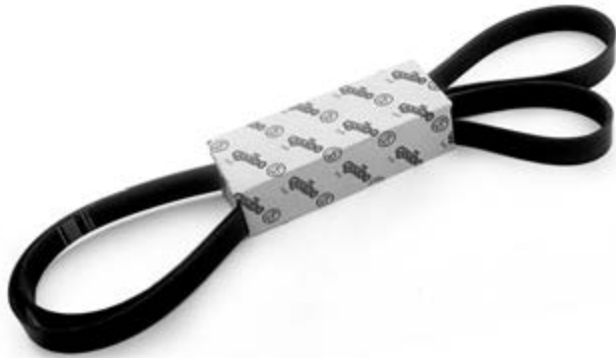

	Code	OEM new	OEM old
● Model ★ Application	62437	1803335	1534505
● 4 BUS			
★ K/L/N 94			

BELT L=1600 MM

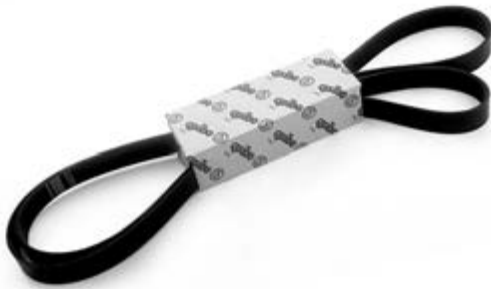

	63968	1420911	
● 4 BUS			
★ F 94			
● 4 TRUCK			
★ D9			

V-BELT L=1900

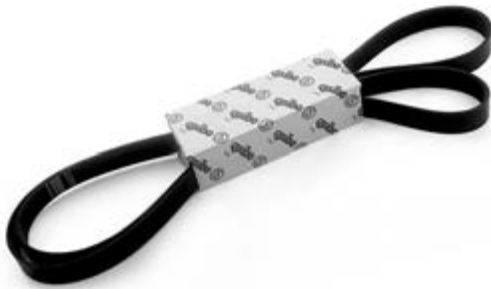

	64346	1420908	1372545
● 4 TRUCK			
★ D9			
● 4 BUS			
★ F94			

ALL THE COMPONENTS LISTED IN OUR CATALOGUE ARE NOT ORIGINAL, THOUGH PERFECTLY INTERCHANGEABLE. REFERENCE NUMBERS, EITHER ORIGINAL OR OF A DIFFERENT NATURE, ARE FOR INFORMATION PURPOSES ONLY. WHEN PLACING AN ORDER, PLEASE, ALWAYS USE COSIBO REFERENCE NUMBERS AND DO NOT MENTION THE ORIGINAL REFERENCE NUMBERS OF THE TRUCK MANUFACTURERS IN THE INVOICE TO VEHICLE OWNERS OR TO ANYBODY ELSE. THE CUSTOMER TAKES HIS OWN RESPONSIBILITY IF HE DOES NOT COMPLY WITH WHAT ABOVE.

V-BELT L=2430

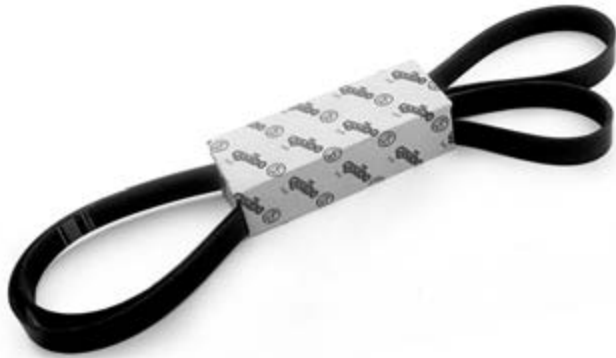

	Code	OEM new	OEM old
● Model	63934	1800527	1490821
★ Application			
● 4 BUS			
★ K/L/N94			
● IND. MARINE ENGINE 4			
★			

V-BELT L=2085

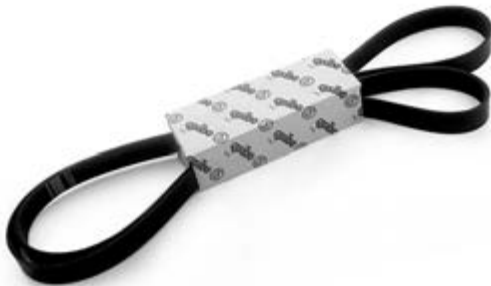

	65094	1888471	1530984 1800541
● 4 TRUCK			
★ D16			
● P-G-R-T TRUCK			
★ D16 WITH AIR CONDITIONING			
● IND. MARINE ENGINE 4			
★ D16A/M			

V-BELT L=1255

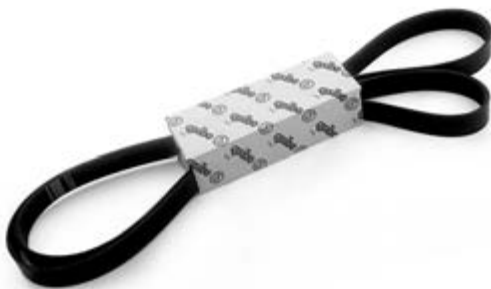

	65095	1800523	1454282
● 4 TRUCK			
★ D16			
● P-G-R-T TRUCK			
★ D16			
● IND. MARINE ENGINE 4			
★			

ALL THE COMPONENTS LISTED IN OUR CATALOGUE ARE NOT ORIGINAL, THOUGH PERFECTLY INTERCHANGEABLE. REFERENCE NUMBERS, EITHER ORIGINAL OR OF A DIFFERENT NATURE, ARE FOR INFORMATION PURPOSES ONLY. WHEN PLACING AN ORDER, PLEASE, ALWAYS USE COSIBO REFERENCE NUMBERS AND DO NOT MENTION THE ORIGINAL REFERENCE NUMBERS OF THE TRUCK MANUFACTURERS IN THE INVOICE TO VEHICLE OWNERS OR TO ANYBODY ELSE. THE CUSTOMER TAKES HIS OWN RESPONSIBILITY IF HE DOES NOT COMPLY WITH WHAT ABOVE.

BELT L=2130 MM

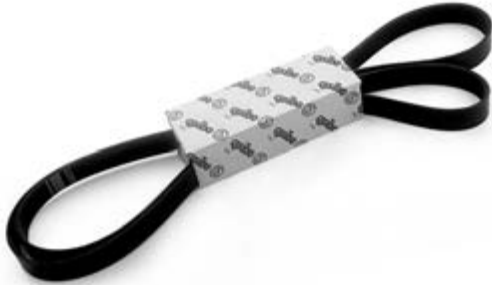

- Model
- ★ Application

Code	OEM new	OEM old
64183	1888468	1389024 1389048 1490819 1800531

- **IND. MARINE ENGINE 4**
- ★ DC12 50A
- **IND. MARINE ENGINE 5**
- ★ DC9A EMS
- **P-G-R-T TRUCK**
- ★ D9/11/12

BELT L=1225 mm

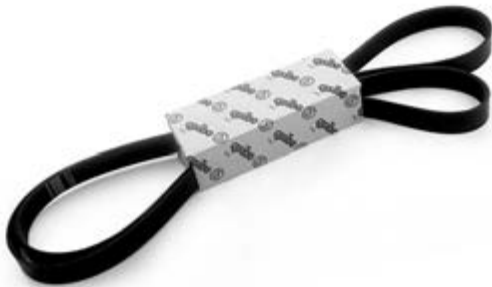

- **3 BUS**
- ★ L113 G776 GA775/781R GS771/772 GR801 - K93

64187	814195	
--------------	--------	--

ALTERNATOR REVISION SET



- **IND. MARINE ENGINE 4**
- ★ D9A/M - D16M - DI16 45M
- **4 TRUCK**
- ★ D12 - DC11 01/02/03/04 - WITH AIR CONDITIONING

63794	63794	
--------------	-------	--

ALL THE COMPONENTS LISTED IN OUR CATALOGUE ARE NOT ORIGINAL, THOUGH PERFECTLY INTERCHANGEABLE. REFERENCE NUMBERS, EITHER ORIGINAL OR OF A DIFFERENT NATURE, ARE FOR INFORMATION PURPOSES ONLY. WHEN PLACING AN ORDER, PLEASE, ALWAYS USE COSIBO REFERENCE NUMBERS AND DO NOT MENTION THE ORIGINAL REFERENCE NUMBERS OF THE TRUCK MANUFACTURERS IN THE INVOICE TO VEHICLE OWNERS OR TO ANYBODY ELSE. THE CUSTOMER TAKES HIS OWN RESPONSIBILITY IF HE DOES NOT COMPLY WITH WHAT ABOVE.

ALTERNATOR REVISION SET



- Model
 - ★ Application
- | Code | OEM new | OEM old |
|-------|---------|---------|
| 63795 | 63795 | |
- 4 TRUCK
 - ★ D14 144 WITH AIR CONDITIONING

ALL THE COMPONENTS LISTED IN OUR CATALOGUE ARE NOT ORIGINAL, THOUGH PERFECTLY INTERCHANGEABLE. REFERENCE NUMBERS, EITHER ORIGINAL OR OF A DIFFERENT NATURE, ARE FOR INFORMATION PURPOSES ONLY. WHEN PLACING AN ORDER, PLEASE, ALWAYS USE COSIBO REFERENCE NUMBERS AND DO NOT MENTION THE ORIGINAL REFERENCE NUMBERS OF THE TRUCK MANUFACTURERS IN THE INVOICE TO VEHICLE OWNERS OR TO ANYBODY ELSE. THE CUSTOMER TAKES HIS OWN RESPONSIBILITY IF HE DOES NOT COMPLY WITH WHAT ABOVE.

THERMOSTAT 80°C WITH RETARDER



	Code	OEM new	OEM old
● Model	63171	1745449	1347594
★ Application			1404925
● 3 BUS			
★	GR801R		
● 3 TRUCK			
★	GR/GRS900R - P113 ML/HL 4X2/6X2 - P93 EXCEPT DSC9 09 GA850		
● 4 BUS			
★	F/L/N94 - K94/K114/K124 - N94UB		
● 4 TRUCK			
★	D9/D12/D14/D16 - DSC11 74/75/79 - DC11 01/02/03/04 - DC9 19/20/21		
● F-K-N BUS			
★	K - N		
● IND. MARINE ENGINE 4			
★	SG9 A280 - DC12 57A		
● IND. MARINE ENGINE 5			
★	SG9 A280 - DC9 60A/68A		
● P-G-R-T TRUCK			
★	D9/D11/D12/D13/D16		

THERMOSTAT 80°



	Code	OEM new	OEM old
	65394	1849060	1423451
			1799757
			1800909
● P-G-R-T TRUCK			
★	D9/11/12/13/16 WITH RETARDER/CON RETARDER		

ALL THE COMPONENTS LISTED IN OUR CATALOGUE ARE NOT ORIGINAL, THOUGH PERFECTLY INTERCHANGEABLE. REFERENCE NUMBERS, EITHER ORIGINAL OR OF A DIFFERENT NATURE, ARE FOR INFORMATION PURPOSES ONLY. WHEN PLACING AN ORDER, PLEASE, ALWAYS USE COSIBO REFERENCE NUMBERS AND DO NOT MENTION THE ORIGINAL REFERENCE NUMBERS OF THE TRUCK MANUFACTURERS IN THE INVOICE TO VEHICLE OWNERS OR TO ANYBODY ELSE. THE CUSTOMER TAKES HIS OWN RESPONSIBILITY IF HE DOES NOT COMPLY WITH WHAT ABOVE.

THERMOSTAT 83°C



	Code	OEM new	OEM old
● Model	63172	1916620	1358995
★ Application			1404924
● 4 TRUCK			
★ DC9 19/20/21 - D12/D14 - DC11 01/02/03/04			
● F-K-N BUS			
★ F			
● IND. MARINE ENGINE 4			
★ D12/D12M ENG 5997349			
● IND. MARINE ENGINE 5			
★ DC9A EMS			
● P-G-R-T TRUCK			
★ D9 PDE - D11/D12			

THERMOSTAT 75°C



	Code	OEM new	OEM old
	63926	1431979	
● IND. MARINE ENGINE 4			
★ D12 49A - D12/D12M ENG 5997350 - D16M			
● IND. MARINE ENGINE 5			
★ DC9A EMS			

THERMOSTAT 79°C



	Code	OEM new	OEM old
	63174	283281	
● 3 BUS			
★ K93/113 - L113 - F93/113			
● 3 TRUCK			
★ CG/CP/CR/CT93 - CP/CR/CT113 - CR/CT143			

ALL THE COMPONENTS LISTED IN OUR CATALOGUE ARE NOT ORIGINAL, THOUGH PERFECTLY INTERCHANGEABLE. REFERENCE NUMBERS, EITHER ORIGINAL OR OF A DIFFERENT NATURE, ARE FOR INFORMATION PURPOSES ONLY. WHEN PLACING AN ORDER, PLEASE, ALWAYS USE COSIBO REFERENCE NUMBERS AND DO NOT MENTION THE ORIGINAL REFERENCE NUMBERS OF THE TRUCK MANUFACTURERS IN THE INVOICE TO VEHICLE OWNERS OR TO ANYBODY ELSE. THE CUSTOMER TAKES HIS OWN RESPONSIBILITY IF HE DOES NOT COMPLY WITH WHAT ABOVE.

	Code	OEM new	OEM old
THERMOSTAT GASKET	61846	351197	278335
			
● Model			
★ Application			
● 3 BUS			
★ K93/113 - L113 - F93/113 - FOR OUR 63174			
● 3 TRUCK			
★ CG/CP/CR/CT93 - CP/CR/CT113 - CR/CT143 - FOR OUR 63174			

	62221	1755952	1351075
THERMOSTAT GASKET			
			
● 3 BUS			
★ GR801R - FOR OUR 63171			
● 3 TRUCK			
★ GR/GRS900R - P113 ML/HL 4X2/6X2 - P93 EXCEPT DSC9 09 GA850 - FOR OUR 63171			
● 4 BUS			
★ F/L/N94 - K94/K114/K124 - N94UB - FOR OUR 63171			
● 4 TRUCK			
★ D9/D12/D14/D16 - DSC11 74/75/79 - DC11 01/02/03/04 - DC9 19/20/21 - WITH RETARDER - FOR OUR 63171			
● F-K-N BUS			
★ K - N - FOR OUR 63171			
● IND. MARINE ENGINE 4			
★ SG9 A280 - DC12 57A - FOR OUR 63171			
● IND. MARINE ENGINE 5			
★ SG9 A280 - DC9 60A/68A - FOR OUR 63171			
● P-G-R-T TRUCK			
★ D9/D11/D12/D13/D16 - FOR OUR 63171			

ALL THE COMPONENTS LISTED IN OUR CATALOGUE ARE NOT ORIGINAL, THOUGH PERFECTLY INTERCHANGEABLE. REFERENCE NUMBERS, EITHER ORIGINAL OR OF A DIFFERENT NATURE, ARE FOR INFORMATION PURPOSES ONLY. WHEN PLACING AN ORDER, PLEASE, ALWAYS USE COSIBO REFERENCE NUMBERS AND DO NOT MENTION THE ORIGINAL REFERENCE NUMBERS OF THE TRUCK MANUFACTURERS IN THE INVOICE TO VEHICLE OWNERS OR TO ANYBODY ELSE. THE CUSTOMER TAKES HIS OWN RESPONSIBILITY IF HE DOES NOT COMPLY WITH WHAT ABOVE.

	Code	OEM new	OEM old
THERMOSTAT GASKET	63193	1421825	1358996
● Model			
★ Application			
● 4 TRUCK			
★ DC9 19/20/21 - D12/D14 - DC11 01/02/03/04 - FOR OUR 63172 & 63926			
● F-K-N BUS			
★ F - FOR OUR 63172 & 63926			
● IND. MARINE ENGINE 4			
★ D12/D12M ENG 5997349 - FOR OUR 63172 & 63926			
● IND. MARINE ENGINE 5			
★ DC9A EMS - FOR OUR 63172 & 63926			
● P-G-R-T TRUCK			
★ D9 PDE - D11/D12 - FOR OUR 63172 & 63926			

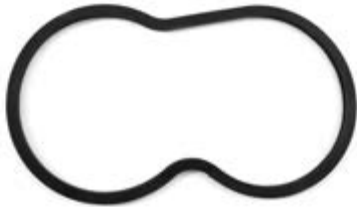

	63192	1375602	1305644
SILICONE HOSE			
● 3 TRUCK			
★ CR/CT 143 - CP93 GA850R ALLISON HD4060PR - GA850R ALLISON HD4060PR - GR900R/GRS900R			
● 4 TRUCK			
★ D14 - CP19F D9			
● IND. MARINE ENGINE 4			
★ D16M - D9 - DC9 51 A05E - D12A - D16 - D12 - DI16 45M			
● IND. MARINE ENGINE 5			
★ DC9 A EMS			



COOLANT FILTER



	Code	OEM new	OEM old
● Model	60629	342988	378396
★ Application			
● 3 BUS			
★ F/K/L/N113 - F/K93 - K113 GR801R			
● 3 TRUCK			
★ CR/CT113/143 - CP/CR113 LHD/RHD - CR143 LHD/RHD - 113/143 LHD/RHD STREAMLINE - 113/143 RHD 6X2/4 - CG/CP/CR/CT93			
● 4 BUS			
★ D9/D11/D12/D14 - DSC9 - DSI9 E01 - DC9 01/02/03/04/05/06 - OSC9 G01 - K/L/N94			
● 4 TRUCK			
★ D9/D11/D12/D14 - DSC9 - DSI9 E01 - DC9 01/02/03/04/05/06 - OSC9 G01 - DSC11 74/75/79 - DC11 01/02/03/04			
● IND. MARINE ENGINE 4			
★ D14M			

WATER PUMP



	Code	OEM new	OEM old
● Model	60060	1510490	1486098 570957
★ Application			

● 4 BUS
★ D9 - K/L/N94
● 4 TRUCK
★ D9
● IND. MARINE ENGINE 4
★ SG9 A280 - SGI12A - D9A/M - DI9 53 A02S - DC9 51 A05E - DI9 56A

WATER PUMP



	Code	OEM new	OEM old
	61005	1375837	261575

● 1 TRUCK
★ 141 D14 DS14

WATER PUMP



	Code	OEM new	OEM old
	60633	1508533	1353072 570955

● 4 TRUCK
★ DC9 19/20/21 - D11/D12 - DSC11 74/75/79
● P-G-R-T TRUCK
★ D9/D11/D12
● 4 BUS
★ DC9 19/20/21 - D11/D12
● IND. MARINE ENGINE 4
★ DI12 49A - D12A/M

ALL THE COMPONENTS LISTED IN OUR CATALOGUE ARE NOT ORIGINAL, THOUGH PERFECTLY INTERCHANGEABLE. REFERENCE NUMBERS, EITHER ORIGINAL OR OF A DIFFERENT NATURE, ARE FOR INFORMATION PURPOSES ONLY. WHEN PLACING AN ORDER, PLEASE, ALWAYS USE COSIBO REFERENCE NUMBERS AND DO NOT MENTION THE ORIGINAL REFERENCE NUMBERS OF THE TRUCK MANUFACTURERS IN THE INVOICE TO VEHICLE OWNERS OR TO ANYBODY ELSE. THE CUSTOMER TAKES HIS OWN RESPONSIBILITY IF HE DOES NOT COMPLY WITH WHAT ABOVE.

COVER WATER PUMP



	Code	OEM new	OEM old
● Model ★ Application	64854	1450153	1376495
● 4 BUS			
★ DC9 19/20/21 - D11/D12			
● 4 TRUCK			
★ DC9 19/20/21 - D11/D12 - DSC11 74/75/79			
● IND.MARINE ENGINE 4			
★ D12 49A - D12A/M			
● P-G-R-T TRUCK			
★ D9/D11/D12			

GASKET



	64307	1403883	1353010
● 4 BUS			
★ DC9 19/20/21 - D11/D12			
● 4 TRUCK			
★ DC9 19/20/21 - D11/D12			
● IND. MARINE ENGINE 4			
★ D12 49A - D12A/M			
● P-G-R-T TRUCK			
★ D9/D11/D12			

WATER PUMP



	60634	1508534	1365841 570956
● 4 TRUCK			
★ D14			

ALL THE COMPONENTS LISTED IN OUR CATALOGUE ARE NOT ORIGINAL, THOUGH PERFECTLY INTERCHANGEABLE. REFERENCE NUMBERS, EITHER ORIGINAL OR OF A DIFFERENT NATURE, ARE FOR INFORMATION PURPOSES ONLY. WHEN PLACING AN ORDER, PLEASE, ALWAYS USE COSIBO REFERENCE NUMBERS AND DO NOT MENTION THE ORIGINAL REFERENCE NUMBERS OF THE TRUCK MANUFACTURERS IN THE INVOICE TO VEHICLE OWNERS OR TO ANYBODY ELSE. THE CUSTOMER TAKES HIS OWN RESPONSIBILITY IF HE DOES NOT COMPLY WITH WHAT ABOVE.

	Code	OEM new	OEM old
WATER PUMP	61000	259065	571055
● Model			
★ Application			
● 3 BUS			
★ N113			



WATER PUMP	61002	1314406	292761 571059 575100
● 3 TRUCK			
★ CP/CR/CT113			
● IND. MARINE ENGINE 4			
★ D11A/M			



WATER PUMP	61174	1377571	1338490 397957 571067
● 3 TRUCK			
★ CG/CP/CR/CT93			
● 3 BUS			
★ F/K93			



ALL THE COMPONENTS LISTED IN OUR CATALOGUE ARE NOT ORIGINAL, THOUGH PERFECTLY INTERCHANGEABLE. REFERENCE NUMBERS, EITHER ORIGINAL OR OF A DIFFERENT NATURE, ARE FOR INFORMATION PURPOSES ONLY. WHEN PLACING AN ORDER, PLEASE, ALWAYS USE COSIBO REFERENCE NUMBERS AND DO NOT MENTION THE ORIGINAL REFERENCE NUMBERS OF THE TRUCK MANUFACTURERS IN THE INVOICE TO VEHICLE OWNERS OR TO ANYBODY ELSE. THE CUSTOMER TAKES HIS OWN RESPONSIBILITY IF HE DOES NOT COMPLY WITH WHAT ABOVE.

	Code	OEM new	OEM old
WATER PUMP	63856	1375839	571154
<ul style="list-style-type: none"> ● Model ★ Application 			
<ul style="list-style-type: none"> ● 3 TRUCK ★ CR/CT143 WITH RETARDER 			



WATER PUMP	64008	1549482	1433792 1510404 1549481 570958
<ul style="list-style-type: none"> ● 4 TRUCK ★ AD/ADA1501P - RBP/RP832 835 - 4X4 6X6 - AD/ADA1501P ADRE 6X4 8X4 - 8X8 AD1101P - AD1100P 4X4 - 6X4 - 8X4 - 6X6 ADRE - AS1300 - ASA1000 6X2 - 8X2 - 8X2/4 - AD/ADA1500P RP832 - ADRE 6X4 - 8X4 - 6X6 - 8X8 - AD/ADA1500P - 1501P ADFR 6X4 - 6X6 - 8X4 - AD/ADA1300 ADRE R660/ADFR RB660 6X4 - 8X4 - ASA80 6X2 - AD/ADA1100/1300/1500 			
<ul style="list-style-type: none"> ● P-G-R-T TRUCK ★ D16 			
<ul style="list-style-type: none"> ● IND. MARINE ENGINE 4 ★ D16A/M 			



WATER PUMP	64123	1789522	1546188 570964
<ul style="list-style-type: none"> ● 4 TRUCK ★ DC9 19/20/21 - D11/D12 			
<ul style="list-style-type: none"> ● P-G-R-T TRUCK ★ D9 PDE - D11/D12 			
<ul style="list-style-type: none"> ● 4 BUS ★ DC9 19/20/21 - D11/D12 			
<ul style="list-style-type: none"> ● IND. MARINE ENGINE 4 ★ D12 - DC12 57A 			
<ul style="list-style-type: none"> ● IND. MARINE ENGINE 5 ★ SG9 A280 - DC9A EMS 			
<ul style="list-style-type: none"> ● F-K-N BUS ★ 			



ALL THE COMPONENTS LISTED IN OUR CATALOGUE ARE NOT ORIGINAL, THOUGH PERFECTLY INTERCHANGEABLE. REFERENCE NUMBERS, EITHER ORIGINAL OR OF A DIFFERENT NATURE, ARE FOR INFORMATION PURPOSES ONLY. WHEN PLACING AN ORDER, PLEASE, ALWAYS USE COSIBO REFERENCE NUMBERS AND DO NOT MENTION THE ORIGINAL REFERENCE NUMBERS OF THE TRUCK MANUFACTURERS IN THE INVOICE TO VEHICLE OWNERS OR TO ANYBODY ELSE. THE CUSTOMER TAKES HIS OWN RESPONSIBILITY IF HE DOES NOT COMPLY WITH WHAT ABOVE.

	Code	OEM new	OEM old
GASKET	64243	1879484	1549027
● Model			
★ Application			
● 4 BUS			
★ DC9 19/20/21 - D11/D12			
● 4 TRUCK			
★ DC9 19/20/21 - D11/D12			
● F-K-N BUS			
★			
● IND.MARINE ENGINE 4			
★ D12 - DC12 57A			
● IND.MARINE ENGINE 5			
★ SG9 A280 - DC9A EMS			
● P-G-R-T TRUCK			
★ D9 PDE - D11/D12			



	64167	1354103	571150
WATER PUMP			
● 3 TRUCK			
★ CP/CR/CT113 GR/GRS900R - CP113 GA850 ALLISON HD460P			
● 3 BUS			
★ K113 GR801R			



ALL THE COMPONENTS LISTED IN OUR CATALOGUE ARE NOT ORIGINAL, THOUGH PERFECTLY INTERCHANGEABLE. REFERENCE NUMBERS, EITHER ORIGINAL OR OF A DIFFERENT NATURE, ARE FOR INFORMATION PURPOSES ONLY. WHEN PLACING AN ORDER, PLEASE, ALWAYS USE COSIBO REFERENCE NUMBERS AND DO NOT MENTION THE ORIGINAL REFERENCE NUMBERS OF THE TRUCK MANUFACTURERS IN THE INVOICE TO VEHICLE OWNERS OR TO ANYBODY ELSE. THE CUSTOMER TAKES HIS OWN RESPONSIBILITY IF HE DOES NOT COMPLY WITH WHAT ABOVE.

WATER PUMP



- Model
- ★ Application

Code	OEM new	OEM old
64645	1375838	571153

- **3 TRUCK**
- ★ CR/CT143

WATER PUMP REPAIR SET



- **3 BUS**
- ★ F/K/L/N113 - 113 - FOR OUR 61000

61147	550044	
--------------	--------	--

- **IND. MARINE ENGINE 4**
- ★ D11 - FOR OUR 61000

- **3 TRUCK**
- ★ F/L113 - 113 - CP/CR113 - FOR OUR 61000

WATER PUMP REPAIR SET



- **3 TRUCK**
- ★ CR/CT143

61180	551476	550216
--------------	--------	--------

ALL THE COMPONENTS LISTED IN OUR CATALOGUE ARE NOT ORIGINAL, THOUGH PERFECTLY INTERCHANGEABLE. REFERENCE NUMBERS, EITHER ORIGINAL OR OF A DIFFERENT NATURE, ARE FOR INFORMATION PURPOSES ONLY. WHEN PLACING AN ORDER, PLEASE, ALWAYS USE COSIBO REFERENCE NUMBERS AND DO NOT MENTION THE ORIGINAL REFERENCE NUMBERS OF THE TRUCK MANUFACTURERS IN THE INVOICE TO VEHICLE OWNERS OR TO ANYBODY ELSE. THE CUSTOMER TAKES HIS OWN RESPONSIBILITY IF HE DOES NOT COMPLY WITH WHAT ABOVE.

	Code	OEM new	OEM old
WATER PUMP REPAIR SET	61183	550167	
<ul style="list-style-type: none"> ● Model ★ Application 			
<ul style="list-style-type: none"> ● 3 BUS ★ CT113 - F/K113 			
<ul style="list-style-type: none"> ● IND. MARINE ENGINE 4 ★ D11 			
<ul style="list-style-type: none"> ● 3 TRUCK ★ CP/CR/CT113 - F113 			



WATER PUMP REPAIR SET	61186	550206	
<ul style="list-style-type: none"> ● IND. MARINE ENGINE 4 ★ D14A/M 			
<ul style="list-style-type: none"> ● 3 TRUCK ★ CR/CT143 			



WATER PUMP REPAIR SET	63293	550269	
<ul style="list-style-type: none"> ● 4 BUS ★ 94 D9 ENG 6174480 - ENG 8017697 			
<ul style="list-style-type: none"> ● IND. MARINE ENGINE 4 ★ 94 D9 ENG 6174480 - ENG 8017697 			
<ul style="list-style-type: none"> ● 4 TRUCK ★ 94 D9 ENG 6174480 - ENG 8017697 			



ALL THE COMPONENTS LISTED IN OUR CATALOGUE ARE NOT ORIGINAL, THOUGH PERFECTLY INTERCHANGEABLE. REFERENCE NUMBERS, EITHER ORIGINAL OR OF A DIFFERENT NATURE, ARE FOR INFORMATION PURPOSES ONLY. WHEN PLACING AN ORDER, PLEASE, ALWAYS USE COSIBO REFERENCE NUMBERS AND DO NOT MENTION THE ORIGINAL REFERENCE NUMBERS OF THE TRUCK MANUFACTURERS IN THE INVOICE TO VEHICLE OWNERS OR TO ANYBODY ELSE. THE CUSTOMER TAKES HIS OWN RESPONSIBILITY IF HE DOES NOT COMPLY WITH WHAT ABOVE.

WATER PUMP REPAIR SET

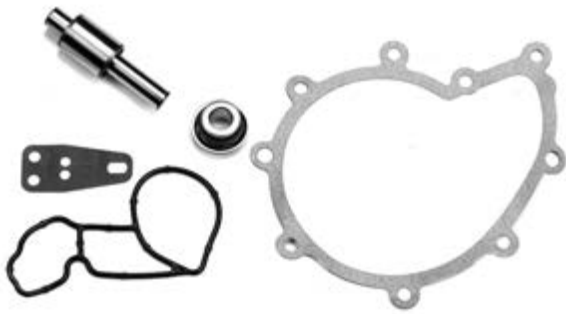

	Code	OEM new	OEM old
● Model	63295	551355	
★ Application			
● 4 BUS			
★ D11/D12 114/124 ENG 6174480 - ENG 8017697			
● IND. MARINE ENGINE 4			
★ D11/D12 114/124 ENG 6174480 - ENG 8017697			
● 4 TRUCK			
★ D11/D12 114/124 ENG 6174480 - ENG 8017697 - DC11 01/02/03/04			

WATER PUMP REPAIR SET

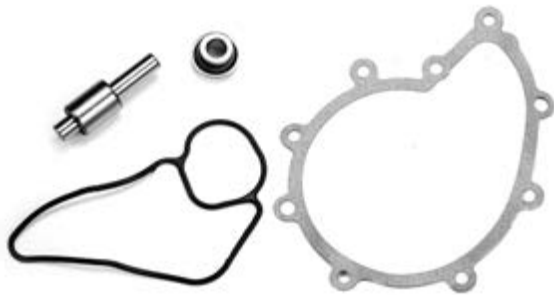

	63296	551369	
● 4 TRUCK			
★ 144			

WATER PUMP REPAIR SET



	64188	551477	
● IND. MARINE ENGINE 4			
★ D14A/M			

ALL THE COMPONENTS LISTED IN OUR CATALOGUE ARE NOT ORIGINAL, THOUGH PERFECTLY INTERCHANGEABLE. REFERENCE NUMBERS, EITHER ORIGINAL OR OF A DIFFERENT NATURE, ARE FOR INFORMATION PURPOSES ONLY. WHEN PLACING AN ORDER, PLEASE, ALWAYS USE COSIBO REFERENCE NUMBERS AND DO NOT MENTION THE ORIGINAL REFERENCE NUMBERS OF THE TRUCK MANUFACTURERS IN THE INVOICE TO VEHICLE OWNERS OR TO ANYBODY ELSE. THE CUSTOMER TAKES HIS OWN RESPONSIBILITY IF HE DOES NOT COMPLY WITH WHAT ABOVE.

		Code	OEM new	OEM old
SEAL RING	● Model	64376	1804034	1522518
	★ Application			
	● 4 BUS			
	★	DC9 20/21 - D11/D12		
	● F-K-N BUS			
	★	D9 XPI		
	● IND. MARINE ENGINE 4			
	★	DI16 48A/53A - D12 - DC12 57A - DI12 49A - D16A/M - DI16 45M - DI12 68M/69M		
	● IND. MARINE ENGINE 5			
	★	SG9 A280 - DC9A EMS		
	● 4 TRUCK			
	★	D11/12/16 - OSC11 G03 - DC9 20/21		
● P-G-R-T TRUCK				
★	D9/D11/D12/D13/D16 - D9 PDE			



	Code	OEM new	OEM old
RADIATOR HOSE	63201		
● Model ★ Application			
● 1 TRUCK			
★ 141			



RUBBER HOSE	61808	142729	
● 3 TRUCK			
★ GR900R/GRS900R			



RUBBER HOSE	61798	303643	
● 3 TRUCK			
★ CR 143			



RUBBER HOSE	63214	267460	
● 3 TRUCK			
★ CR/CT143			



ALL THE COMPONENTS LISTED IN OUR CATALOGUE ARE NOT ORIGINAL, THOUGH PERFECTLY INTERCHANGEABLE. REFERENCE NUMBERS, EITHER ORIGINAL OR OF A DIFFERENT NATURE, ARE FOR INFORMATION PURPOSES ONLY. WHEN PLACING AN ORDER, PLEASE, ALWAYS USE COSIBO REFERENCE NUMBERS AND DO NOT MENTION THE ORIGINAL REFERENCE NUMBERS OF THE TRUCK MANUFACTURERS IN THE INVOICE TO VEHICLE OWNERS OR TO ANYBODY ELSE. THE CUSTOMER TAKES HIS OWN RESPONSIBILITY IF HE DOES NOT COMPLY WITH WHAT ABOVE.

	Code	OEM new	OEM old
RUBBER HOSE 	61864	318350	
<ul style="list-style-type: none"> ● Model ★ Application 			
<ul style="list-style-type: none"> ● 3 TRUCK ★ CT 113 ENG 5307928 - ENG 4070104 - CP/CR 113 ENG 5307760 - ENG 4070104 			
RUBBER HOSE 	61212	346627	
<ul style="list-style-type: none"> ● 3 TRUCK ★ CP/CR/CT113 - CR/CT143 ● IND. MARINE ENGINE 4 ★ DSI14 69M - DI14 82M 			
RUBBER HOSE 	61800	241805	
<ul style="list-style-type: none"> ● 3 BUS ★ L113 - K113 - F113 ● 3 TRUCK ★ CP-CR-CT113 - CR13/19 D11 - DSC11 21/22(EDC)/23 - DTC11 ● IND. MARINE ENGINE 4 ★ D9 - DC9 51 A05E 			
RUBBER HOSE 	64288	1375601	1358384
<ul style="list-style-type: none"> ● 4 TRUCK ★ D14 			

ALL THE COMPONENTS LISTED IN OUR CATALOGUE ARE NOT ORIGINAL, THOUGH PERFECTLY INTERCHANGEABLE. REFERENCE NUMBERS, EITHER ORIGINAL OR OF A DIFFERENT NATURE, ARE FOR INFORMATION PURPOSES ONLY. WHEN PLACING AN ORDER, PLEASE, ALWAYS USE COSIBO REFERENCE NUMBERS AND DO NOT MENTION THE ORIGINAL REFERENCE NUMBERS OF THE TRUCK MANUFACTURERS IN THE INVOICE TO VEHICLE OWNERS OR TO ANYBODY ELSE. THE CUSTOMER TAKES HIS OWN RESPONSIBILITY IF HE DOES NOT COMPLY WITH WHAT ABOVE.

	Code	OEM new	OEM old
RUBBER HOSE	64842	1444948	
<ul style="list-style-type: none"> ● Model ★ Application 			
<ul style="list-style-type: none"> ● P-G-R-T TRUCK ★ D9/11/12 - D16 			



RUBBER HOSE	64843	1525983	
<ul style="list-style-type: none"> ● P-G-R-T TRUCK ★ D9/11/12 - D16 			



RUBBER HOSE	64844	1755951	1446229
<ul style="list-style-type: none"> ● P-G-R-T-TRUCK\ ★ D9/11/12 - D13 - D16 			



RUBBER HOSE	64845	1755953	1446228
<ul style="list-style-type: none"> ● F-K-N BUS ★ F ● P-G-R-T TRUCK ★ D9/11/12 - D13 - D16 			



ALL THE COMPONENTS LISTED IN OUR CATALOGUE ARE NOT ORIGINAL, THOUGH PERFECTLY INTERCHANGEABLE. REFERENCE NUMBERS, EITHER ORIGINAL OR OF A DIFFERENT NATURE, ARE FOR INFORMATION PURPOSES ONLY. WHEN PLACING AN ORDER, PLEASE, ALWAYS USE COSIBO REFERENCE NUMBERS AND DO NOT MENTION THE ORIGINAL REFERENCE NUMBERS OF THE TRUCK MANUFACTURERS IN THE INVOICE TO VEHICLE OWNERS OR TO ANYBODY ELSE. THE CUSTOMER TAKES HIS OWN RESPONSIBILITY IF HE DOES NOT COMPLY WITH WHAT ABOVE.

	Code	OEM new	OEM old
RUBBER HOSE	64285	1422499	
● Model			
★ Application			
● 4 TRUCK			
★ CR/CT 164			
● P-G-R-T- TRUCK			
★ CR/CT D16			



RUBBER HOSE	64294	1511620	1494718
● 4 TRUCK			
★ CR/CT 164			
● P-G-R-T- TRUCK			
★ CR/CT D16			



RUBBER HOSE	65372	1376295	
● P-G-R-T TRUCK			
★ CR D9/11/12 - CR D16 - CR D9/11/12 EGR - CP D9 PDE - D11 - D12 - CP/CR D11/12 4X4 6X6 - CR D9/11/12 4X4 6X6 - CT D11/12 - CT D16 - CT D12 EGR			
● 4 BUS			
★ F 94			
● F-K-N BUS			
★ F			



RUBBER HOSE



- Model
- ★ Application

Code

OEM new

OEM old

65127

1375859

- 4 TRUCK

- ★ CP/CR 94 - CP 19F D9

RUBBER HOSE



- 4 TRUCK

- ★ CR DSC11 74/75/79

65139

1392276

RUBBER HOSE



- 4 TRUCK

- ★ CR DSC11 74/75/79

65140

1391796

ALL THE COMPONENTS LISTED IN OUR CATALOGUE ARE NOT ORIGINAL, THOUGH PERFECTLY INTERCHANGEABLE. REFERENCE NUMBERS, EITHER ORIGINAL OR OF A DIFFERENT NATURE, ARE FOR INFORMATION PURPOSES ONLY. WHEN PLACING AN ORDER, PLEASE, ALWAYS USE COSIBO REFERENCE NUMBERS AND DO NOT MENTION THE ORIGINAL REFERENCE NUMBERS OF THE TRUCK MANUFACTURERS IN THE INVOICE TO VEHICLE OWNERS OR TO ANYBODY ELSE. THE CUSTOMER TAKES HIS OWN RESPONSIBILITY IF HE DOES NOT COMPLY WITH WHAT ABOVE.

	Code	OEM new	OEM old
RUBBER HOSE	65141	1391795	
● Model			
★ Application			
● 4 TRUCK			
★ CP DSC11 74/75/79			



	65146	1376294	1363545
RUBBER HOSE			
● 4 TRUCK			
★ CR/CT 144 - CR/CT 144 GR/GRS900R			



	65147	1376291	
RUBBER HOSE			
● 4 TRUCK			
★ CR/CT 144			



ALL THE COMPONENTS LISTED IN OUR CATALOGUE ARE NOT ORIGINAL, THOUGH PERFECTLY INTERCHANGEABLE. REFERENCE NUMBERS, EITHER ORIGINAL OR OF A DIFFERENT NATURE, ARE FOR INFORMATION PURPOSES ONLY. WHEN PLACING AN ORDER, PLEASE, ALWAYS USE COSIBO REFERENCE NUMBERS AND DO NOT MENTION THE ORIGINAL REFERENCE NUMBERS OF THE TRUCK MANUFACTURERS IN THE INVOICE TO VEHICLE OWNERS OR TO ANYBODY ELSE. THE CUSTOMER TAKES HIS OWN RESPONSIBILITY IF HE DOES NOT COMPLY WITH WHAT ABOVE.

	Code	OEM new	OEM old
RUBBER HOSE	65149	1375604	1357342
<ul style="list-style-type: none"> ● Model ★ Application 			
<ul style="list-style-type: none"> ● 4 TRUCK ★ D14 			



RUBBER HOSE	61799	223315	
<ul style="list-style-type: none"> ● 3 TRUCK ★ CP/CR 113 - CP/CR DSC11 21/22/23 DTC11 ● IND. MARINE ENGINE 4 ★ SG9 A280 - D9 - D14 - D11 ● IND. MARINE ENGINE 5 ★ SG9 A280 			



RUBBER SLEEVE	61213	354967	
<ul style="list-style-type: none"> ● 3 TRUCK ★ DSC14 03/04/06/08/09/10 			





RUBBER HOSE	61793	298823	
<ul style="list-style-type: none"> ● 3 BUS ★ F113 RH ● 3 TRUCK ★ CP/CR/CT113 GR/GRS900R - CT143 - CR13/19 D11 - CP/CR DSC11 21/22(EDC)/23 - DTC11 - CR13/19 DSC11 21/22(EDC)/23 - DTC11 - CP113 ML/HL 4X2 6X2 GA850 			





	Code	OEM new	OEM old
<p>RUBBER HOSE</p> 	61869	1340201	
<ul style="list-style-type: none"> ● Model ★ Application 			
<ul style="list-style-type: none"> ● 3 BUS 			
<ul style="list-style-type: none"> ★ F 113 RH 			
<ul style="list-style-type: none"> ● 3 TRUCK 			
<ul style="list-style-type: none"> ★ CP/CR/CT 113 - CR13/19 D11 - CP/CR DSC11 21/22(EDC)/23 - DTC11 - CR13/19 DSC11 21/22(EDC)/23 - DTC11 - CP/CR DSC11 21/22/23 - DTC11 			
<p>RUBBER HOSE</p> 	63176	318364	
<ul style="list-style-type: none"> ● 3 TRUCK 			
<ul style="list-style-type: none"> ★ CP 113 - CT143 			
<p>RUBBER HOSE</p> 	63178	301789	
<ul style="list-style-type: none"> ● 3 TRUCK 			
<ul style="list-style-type: none"> ★ CT 113 - CT 143 			
<p>RUBBER HOSE</p> 	63179	382985	
<ul style="list-style-type: none"> ● 3 BUS 			
<ul style="list-style-type: none"> ★ F 113 			
<ul style="list-style-type: none"> ● 3 TRUCK 			
<ul style="list-style-type: none"> ★ CP/CR/CT 113 - CP/CR/CT 113 79° - 			

ALL THE COMPONENTS LISTED IN OUR CATALOGUE ARE NOT ORIGINAL, THOUGH PERFECTLY INTERCHANGEABLE. REFERENCE NUMBERS, EITHER ORIGINAL OR OF A DIFFERENT NATURE, ARE FOR INFORMATION PURPOSES ONLY. WHEN PLACING AN ORDER, PLEASE, ALWAYS USE COSIBO REFERENCE NUMBERS AND DO NOT MENTION THE ORIGINAL REFERENCE NUMBERS OF THE TRUCK MANUFACTURERS IN THE INVOICE TO VEHICLE OWNERS OR TO ANYBODY ELSE. THE CUSTOMER TAKES HIS OWN RESPONSIBILITY IF HE DOES NOT COMPLY WITH WHAT ABOVE.





	Code	OEM new	OEM old
RUBBER HOSE	63601	1377231	
	<ul style="list-style-type: none"> ● Model ★ Application 		
	<ul style="list-style-type: none"> ● 4 BUS ★ F 94 		
	<ul style="list-style-type: none"> ● 4 TRUCK ★ CP DC9 19/20/21 - CP/CR 114/124 - CR/CT 164 - CP/CR/CT DSC11 74/75/79 - CR/CT 144 - CT 124 - CP/CR 94 - CR/CT 144 GR/GRS900R - CT 124 GR/GRS900R - CP 19F D9 - CP/CR 124 4X4 6X6 - CR 124 4X4 6X6 GR/GRS900R - CP/CR/CT DC11 01/02/03/04/06/07 - CP/CR/CT DC11 01/02/03/04/06/07 GR900R/GRS890R 		

RUBBER HOSE	63602	1341729	
	<ul style="list-style-type: none"> ● 4 TRUCK ★ CP 124 - CP DC11 01/02/03/04/06/07 		

RUBBER HOSE	65125	1373919	
	<ul style="list-style-type: none"> ● 4 BUS ★ F 94 		
	<ul style="list-style-type: none"> ● 4 TRUCK ★ CP 19F D9 - CP/CR 94 		

RUBBER HOSE	65128	1376226	
	<ul style="list-style-type: none"> ● IND. MARINE ENGINE 4 ★ D12A - DC12 50A - SG9 A280 		
	<ul style="list-style-type: none"> ● IND. MARINE ENGINE 5 ★ DC9A EMS 		
	<ul style="list-style-type: none"> ● 4 TRUCK ★ CP 19F D9 - CP/CR/CT DSC11 74/75/79 - CP/CR 94 		

ALL THE COMPONENTS LISTED IN OUR CATALOGUE ARE NOT ORIGINAL, THOUGH PERFECTLY INTERCHANGEABLE. REFERENCE NUMBERS, EITHER ORIGINAL OR OF A DIFFERENT NATURE, ARE FOR INFORMATION PURPOSES ONLY. WHEN PLACING AN ORDER, PLEASE, ALWAYS USE COSIBO REFERENCE NUMBERS AND DO NOT MENTION THE ORIGINAL REFERENCE NUMBERS OF THE TRUCK MANUFACTURERS IN THE INVOICE TO VEHICLE OWNERS OR TO ANYBODY ELSE. THE CUSTOMER TAKES HIS OWN RESPONSIBILITY IF HE DOES NOT COMPLY WITH WHAT ABOVE.

	Code	OEM new	OEM old
<p>RUBBER HOSE</p> 	65129	1374040	
<ul style="list-style-type: none"> ● Model ★ Application 			
<ul style="list-style-type: none"> ● 4 TRUCK 			
<ul style="list-style-type: none"> ★ CP/CR 14 - CP/CR19 114/124 - CP/CR 114/124 - CP DC9 19/20/21 - CP DSC11 74/75/79 - CR/CP94 - CP 19F D9 - CP/CR DC11 01/02/03/04/06/07 GR900R GRS890R - CP/CR 124 GR/GRS900R 			
<p>RUBBER HOSE</p> 	65130	1449431	1376293
<ul style="list-style-type: none"> ● 4 TRUCK 			
<ul style="list-style-type: none"> ★ CR 164 - CR/CT DSC11 74/75/79 - CP/CR 94 - CR/CT 144 GR/GRS900R - CP/CR/CT 124 GR/GRS900R - CR 124 4X4 6X6 GR/GRS900R - CP/CR/CT DC11 01/02/03/04/06/07 - GR900R GRS890R 			
<p>RUBBER HOSE</p> 	65131	1376895	
<ul style="list-style-type: none"> ● 4 TRUCK 			
<ul style="list-style-type: none"> ★ CP DC9 19/20/21 - CP/CR 114/124 - CR 164 - CP/CR DSC11 74/75/79 - CR 144 - CR 144 GR/GRS900R - CP/CR 94 - CP 19F D9 - CP/CR 124 4X4 6X6 - CR 124 4X4 6X6 GR/GRS900R - CP/CR DC11 01/02/03/04/06/07 - CP/CR DC11 01/02/03/04/06/07 GR900R/GRS890R - CP/CR 124 GR/GRS900R - CR 124 8X8 WLS/ZLS GRS890R 			
<p>RUBBER HOSE</p> 	65132	1545116	1380621 1448384 1531776
<ul style="list-style-type: none"> ● 4 TRUCK 			
<ul style="list-style-type: none"> ★ CP DC9 19/20/21 - CP/CR 114/124 - CR 164 - CR DSC11 74/75/79 - CP/CR 94 - CR 144 GR/GRS900 - CP 19F D9 - CP/CR 124 4X4 6X6 - CR 124 4X4 6X6 GR/GRS900R - CP/CR DC11 01/02/03/04/06/07 - CP/CR DC11 01/02/03/04/06/07 GR900R/GRS890R - CP/CR 124 GR/GRS900R - CR 124 8X8 WLS/ZLS GRS890R 			

ALL THE COMPONENTS LISTED IN OUR CATALOGUE ARE NOT ORIGINAL, THOUGH PERFECTLY INTERCHANGEABLE. REFERENCE NUMBERS, EITHER ORIGINAL OR OF A DIFFERENT NATURE, ARE FOR INFORMATION PURPOSES ONLY. WHEN PLACING AN ORDER, PLEASE, ALWAYS USE COSIBO REFERENCE NUMBERS AND DO NOT MENTION THE ORIGINAL REFERENCE NUMBERS OF THE TRUCK MANUFACTURERS IN THE INVOICE TO VEHICLE OWNERS OR TO ANYBODY ELSE. THE CUSTOMER TAKES HIS OWN RESPONSIBILITY IF HE DOES NOT COMPLY WITH WHAT ABOVE.

RUBBER HOSE



- Model
- ★ Application

Code

OEM new

OEM old

65133

1376896

- 4 TRUCK

- ★ CP DC9 19/20/21 - CP/CR 114/124 - CR 164 - CP/CR DSC11 74/75/79 - CR 144 - CP/CR 94 - CR 144 GR/GRS900R - CP 19F D9 - CP/CR 124 4X4 6X6 - CR 124 4X4 6X6 GR/GRS900R - CP/CR DC11 01/02/03/04/06/07 - CP/CR DC11 01/02/03/04/06/07 GR900R/GRS890R - CP/CR 124 GR/GRS900R - CR 124 8X8 WLS/ZLS GRS890R

RUBBER HOSE



- 4 TRUCK

- ★ CP DC9 19/20/21 - CP/CR 114/124 - CR 164 - CP/CR DSC11 74/75/79 - CR 144 - CP/CR 94 - CR 144 GR/GRS900R - CP 19F D9 - CP/CR 124 4X4 6X6 - CR 124 4X4 6X6 GR/GRS900R - CP/CR DC11 01/02/03/04/06/07 - CP/CR DC11 01/02/03/04/06/07 GR900R/GRS890R - CP/CR 124 GR/GRS900R - CR 124 8X8 WLS/ZLS GRS890R

65134

1383873

RUBBER HOSE



- 4 TRUCK

- ★ CP/CR/CT DSC11 74/75/79

65135

1383990

	Code	OEM new	OEM old
RUBBER HOSE	65136	1426194	1375874
● Model			
★ Application			
● F-K-N BUS			
★ F			
● 4 TRUCK			
★ CP/CR 14 - CP/CR 19 114/124 - CP/CR 114/124 - CP DC9 19/20/21 - CR/CT 164 - CP/CR/CT DSC11 74/75/79 - CR/CT 144 GR/GRS900R - CP/CR/CT 124 GR/GRS900R - CR 124 4X4 6X6 GR/GRS900R - CP/CR/CT DC11 01/02/03/04/06/07 GR900R/GRS890R			
● P-G-R-T TRUCK			
★ CG/CR D9/11/12 - CR D9/11/12 EGR - CR/CT D16 - CP D9 PDE - D11/12 - CG/CP/CR D11/12 4X4 6X6 - CT D11/D12 - CT D12 EGR - CG/CR D9/12 EGR			



RUBBER HOSE	65137	1395066	1384464
● 4 TRUCK			
★ CP/CR/CT DSC11 74/75/79			



RUBBER HOSE	65142	1385086	
● 4 TRUCK			
★ CP/CR/CT DSC11 74/75/79			



	Code	OEM new	OEM old
RUBBER HOSE 	65143	1529007	1377332 1447198
<ul style="list-style-type: none"> ● Model ★ Application 			
<ul style="list-style-type: none"> ● 4 TRUCK ★ CP/CR 114/124 - CP/CR/CT 124 - CT 124 GR/GRS900R - CP/CR 124 4X4 6X6 - CR 124 4X4 6X6 GR/GRS900R - CP/CR/CT DC11 01/02/03/04/06/07 - CP/CR/CT DC11 01/02/03/04/06/07 GR900R/GRS890R - CP/CR 124 GR/GRS900R - CR 124 8X8 WLS/ZLS GRS890R 			
RUBBER HOSE 	65144	1377331	
<ul style="list-style-type: none"> ● 4 TRUCK ★ CR/CT 124 - CR 124 4X4 6X6 - CR/CT DC11 01/02/03/04/06/07 			
RUBBER HOSE 	65145	1376949	1358296
<ul style="list-style-type: none"> ● 4 TRUCK ★ CP DSC11 74/75/79 - CR 144 CH 1213498 - CP/CR 124 - CR 144 GR/GRS900R - CP/CR 124 4X4 6X6 - CR 124 4X4 6X6 GR/GRS900R - CP/CR 124 GR/GRS900R 			
RUBBER HOSE 	65150	1375603	1357341
<ul style="list-style-type: none"> ● 4 TRUCK ★ D14 			

ALL THE COMPONENTS LISTED IN OUR CATALOGUE ARE NOT ORIGINAL, THOUGH PERFECTLY INTERCHANGEABLE. REFERENCE NUMBERS, EITHER ORIGINAL OR OF A DIFFERENT NATURE, ARE FOR INFORMATION PURPOSES ONLY. WHEN PLACING AN ORDER, PLEASE, ALWAYS USE COSIBO REFERENCE NUMBERS AND DO NOT MENTION THE ORIGINAL REFERENCE NUMBERS OF THE TRUCK MANUFACTURERS IN THE INVOICE TO VEHICLE OWNERS OR TO ANYBODY ELSE. THE CUSTOMER TAKES HIS OWN RESPONSIBILITY IF HE DOES NOT COMPLY WITH WHAT ABOVE.

RUBBER HOSE



- Model
- ★ Application

Code

OEM new

OEM old

63180

382983

- 3 BUS

- ★ F 113 LHD/RHD

- 3 TRUCK

- ★ CP/CR/CT 113 - CR 13/19 D11 - DSC11 21/22(EDC)/23 DTC11 - CP/CR DSC11 21/22(EDC)/23 DTC11

RUBBER HOSE



- P-G-R-T TRUCK

- ★ CR D16

64355

1733735

RUBBER HOSE



- P-G-R-T TRUCK

- ★ D13 - CG/CP/CR

64356

1790071

ALL THE COMPONENTS LISTED IN OUR CATALOGUE ARE NOT ORIGINAL, THOUGH PERFECTLY INTERCHANGEABLE. REFERENCE NUMBERS, EITHER ORIGINAL OR OF A DIFFERENT NATURE, ARE FOR INFORMATION PURPOSES ONLY. WHEN PLACING AN ORDER, PLEASE, ALWAYS USE COSIBO REFERENCE NUMBERS AND DO NOT MENTION THE ORIGINAL REFERENCE NUMBERS OF THE TRUCK MANUFACTURERS IN THE INVOICE TO VEHICLE OWNERS OR TO ANYBODY ELSE. THE CUSTOMER TAKES HIS OWN RESPONSIBILITY IF HE DOES NOT COMPLY WITH WHAT ABOVE.

		Code	OEM new	OEM old
HOSE BY METER	● Model	60638	561408	
	★ Application			
	● 3 TRUCK			
	★	CG/CP/CR/CT 93 - CP/CR/CT 113 - CR/CT 143 - CR 13/19 D11 - CP/CR DSC11 21/22(EDC)/23 - DTC11 - CR 13/19 DSC11 21/22(EDC)/23 - DTC11 - CP/CR DSC11 21/22/23 - DTC11 - CR 143 GRH880 - CP 93 GA850R - ALLISON HD4060PR		
	● 4 TRUCK			
	★	CP/CR 114/124 - CP/CT DSC11 74/75/79 - CR/CT 144 - CT 124 - CP/CR 94 - CR/CT 144 GR/GRS900R - CP/CR/CT 124 GR/GRS900R - CP 19F D9 - CP/CR 124 4X4 6X6 - CR 124 4X4 6X6 GR/GRS900R - CP/CR/CT DC11 01/02/03/04/06/07 - CP/CR/CT DC11 01/02/03/04/06/07 GR900R/GRS890R - CR 124 8X8 WLS/ZLS GRS890R		
	● P-G-R-T TRUCK			
	★	CG/CR D9/11/12 - CR D16 - CR D9/11/12 EGR - CP D9 PDE - D11/D12 - CG/CP/CR D11/12 4X4 6X6 - CR D9/11/12 4X4 6X6 - CP D9 XPI - CG/CR D9/12 EGR - CG/CR D9/11/12 4X4 6X6		
	● 3 BUS			
	★	N 113 - L 113 - K 93 - F 93 - L 113 G776 - GS771/772 - GR801 - L 113 OSC11 G01 - L 113 GA775/781R - F 113 RHD - LH - F 113 LHD - LH		
	● 4 BUS			
	★	N - N 94 UD - K/L - F 94		
	● IND. MARINE ENGINE 4			
★	SG9 A280 - DSC9 47A - D14 - D12A - D1 - D12			
● IND. MARINE ENGINE 5				
★	DC9 EMS - DC9A EMS - SG9 A280			
● F-K-N BUS				
★	K - N - F - CK RHD - CN RHD - K D12 - K D9			



	Code	OEM new	OEM old
RUBBER PLUG	64081	1350394	
● Model			
★ Application			
● 4 BUS			
★ K/L DSC9 DSI9 DC9 - CN 94 - F94 LHD - L94 OSC9 - CL94 DSC9 DSI9 DC9			
● F-K-N BUS			
★ K			
● IND. MARINE ENGINE 5			
★ DC9A EMS			
● 3 TRUCK			
★ CP 93 - GA850R CHIUSO			
● 4 TRUCK			
★ DSC14 13/15 - DC11/D12 - CP/CR 14 - CP/CR 19 - CP DC9 19/20/21 - CP DSC 74/75/79 - CP DSC11 74/75/79 - CT DSC11 74/75/79 - CR/CT 144 - CR/CP/CT 124 - CR/CP 124 4X4 6X6 - CR/CP/CT DC11 01/02/03/04/06/07			
● P-G-R-T TRUCK			
★ CR D9/11/12 EGR - CG/CR D9/12 EGR - CR D9 PDE - CR D16 - CP/CT D9 PDE - D11/D12 - D9 XPI			



	65402	1466075	
CLAMP			
● 3 BUS			
★			
● 3 TRUCK			
★			
● 4 BUS			
★			
● 4 TRUCK			
★			
● F-K-N BUS			
★			
● IND. MARINE ENGINE 4			
★			
● IND. MARINE ENGINE 5			
★			



FUEL PUMP



- Model
- ★ Application

Code

OEM new

OEM old

65154

269342

- 2 TRUCK

- ★ DS14 01

FEED PUMP



- 3 TRUCK

- ★ DN11 01

61120

211005

FUEL PUMP (PLASTIC HAND PUMP + GLASS TANK)



- 3 BUS

- ★ DS9 05B - DSC11 08B/C - DSC11 18B

- 3 TRUCK

- ★ DS9 05 - DSC9 02/07/08/10 - DSC11 08/10/13/18/30 - DSC11 08/10 L03

65151/2

371780

ALL THE COMPONENTS LISTED IN OUR CATALOGUE ARE NOT ORIGINAL, THOUGH PERFECTLY INTERCHANGEABLE. REFERENCE NUMBERS, EITHER ORIGINAL OR OF A DIFFERENT NATURE, ARE FOR INFORMATION PURPOSES ONLY. WHEN PLACING AN ORDER, PLEASE, ALWAYS USE COSIBO REFERENCE NUMBERS AND DO NOT MENTION THE ORIGINAL REFERENCE NUMBERS OF THE TRUCK MANUFACTURERS IN THE INVOICE TO VEHICLE OWNERS OR TO ANYBODY ELSE. THE CUSTOMER TAKES HIS OWN RESPONSIBILITY IF HE DOES NOT COMPLY WITH WHAT ABOVE.

FUEL PUMP (ALUMINIUM HAND PUMP + GLASS TANK)



	Code	OEM new	OEM old
● Model	65151/1	371780/1	
★ Application			
● 3 BUS			
★ DS9 05B - DSC11 08B/C - DSC11 18B			
● 3 TRUCK			
★ DS9 05 - DSC9 02/07/08/10 - DSC11 08/10/13/18/30 - DSC11 08/10 L03			

FUEL PUMP



	65152	319792	
● 3 TRUCK			
★ DSC14 06			

FUEL PUMP



	65153	367624	
● 3 TRUCK			
★ DSC14 03/04/08/09/10/16 - GRH880			
● IND. MARINE ENGINE 4			
★ DI14 81A RE30(EDC)			

ALL THE COMPONENTS LISTED IN OUR CATALOGUE ARE NOT ORIGINAL, THOUGH PERFECTLY INTERCHANGEABLE. REFERENCE NUMBERS, EITHER ORIGINAL OR OF A DIFFERENT NATURE, ARE FOR INFORMATION PURPOSES ONLY. WHEN PLACING AN ORDER, PLEASE, ALWAYS USE COSIBO REFERENCE NUMBERS AND DO NOT MENTION THE ORIGINAL REFERENCE NUMBERS OF THE TRUCK MANUFACTURERS IN THE INVOICE TO VEHICLE OWNERS OR TO ANYBODY ELSE. THE CUSTOMER TAKES HIS OWN RESPONSIBILITY IF HE DOES NOT COMPLY WITH WHAT ABOVE.

FUEL PUMP (PLASTIC HAND PUMP + GLASS TANK)



	Code	OEM new	OEM old
● Model	60718/1	371781	319789
★ Application			
● 3 BUS			
★ DS11 34/74 C/B - DSC11 21 B/C - DS9 08B			
● 3 TRUCK			
★ DN9 01 - DS11 34/73 - DSC11 12/16/17 - DS9 06/08			

PRE-FILTER



	62329	207783	
● 3 BUS			
★ DSC11 18 B 08/21 B/C - DS9 05/08 B - DS11 34/74 B/C			
● 3 TRUCK			
★ DSC11 8/10/17/18/30 - DSC14 03/06 - DS11 34			

FEED PUMP



	61936	1375493	
● 4 BUS			
★ DSC9 11/12/13/15 - DC9 01/02/03/04/05/06			
● 4 TRUCK			
★ DSC9 11/12/13/15 - DC9 01/02/03/04/05/06			

ALL THE COMPONENTS LISTED IN OUR CATALOGUE ARE NOT ORIGINAL, THOUGH PERFECTLY INTERCHANGEABLE. REFERENCE NUMBERS, EITHER ORIGINAL OR OF A DIFFERENT NATURE, ARE FOR INFORMATION PURPOSES ONLY. WHEN PLACING AN ORDER, PLEASE, ALWAYS USE COSIBO REFERENCE NUMBERS AND DO NOT MENTION THE ORIGINAL REFERENCE NUMBERS OF THE TRUCK MANUFACTURERS IN THE INVOICE TO VEHICLE OWNERS OR TO ANYBODY ELSE. THE CUSTOMER TAKES HIS OWN RESPONSIBILITY IF HE DOES NOT COMPLY WITH WHAT ABOVE.

FEED PUMP (PLASTIC HAND PUMP)



	Code	OEM new	OEM old
● Model	65155/1	1307770	
★ Application			
● 3 BUS			
★	DS9 05B - DSC11 21B/22B/23B/24B/35B/36B/71B - DS11 75B/77B/78B - DS11 77C/78C - DSC11 04C/24C/27C/71C - DSC9 08B - DS11 75 - DSC11 23/70		
● 4 BUS			
★	DC11 07 - DSC12 01/02		
● IND. MARINE ENGINE 4			
★	DSC11 58A - DI12 41M/42M/43M/44M/45M/57M - DC/DSC12 40A/42/A - DS19 47M - DSC12 41 - DSI12 40 - DSI11 74M/75M		
● 3 TRUCK			
★	DSC9 07/08/09 - DS11 75 - DSC11 21/22/23/35/36/39/70 - DTC11 01/02		
● 4 TRUCK			
★	DC11 07 - DSC12 01/02 - DSC11 74/75/79		

HAND PUMP-ALUMINIUM VERSION



	61121	192882	
● SUITABLE/ADATTABILE			
★	BOSCH: 2 441 222 003 - 2 441 222 016 - 2 441 222 020 - 2 441 222 023 - 2 441 222 025 - 2 447 010 025		
● 3 BUS			
★			
● 4 BUS			
★	DC9 01/02/03/04/05/06/19/20/21 - DSC9 13/15 - DC11 07 - DSC12 01/02 - DC11/D12 PDE - DSC9 11/12/13/15		
● IND. MARINE ENGINE 4			
★	D12A/M EMS - D16A/M - DSC12 41 - DSI12 40		
● IND. MARINE ENGINE 5			
★	DC9A EMS		
● 3 TRUCK			
★			
● 4 TRUCK			
★	DC9 01/02/03/04/05/06/19/20/21 - DSC9 11/12/13/15 - DC11 07 - DSC12 01/02 - DC11/D12 PDE - DC16 01/02 - DSC14 13/15 - DSC11 74/75/79		
● P-G-R-T TRUCK			
★	D9/11/12/16		

ALL THE COMPONENTS LISTED IN OUR CATALOGUE ARE NOT ORIGINAL, THOUGH PERFECTLY INTERCHANGEABLE. REFERENCE NUMBERS, EITHER ORIGINAL OR OF A DIFFERENT NATURE, ARE FOR INFORMATION PURPOSES ONLY. WHEN PLACING AN ORDER, PLEASE, ALWAYS USE COSIBO REFERENCE NUMBERS AND DO NOT MENTION THE ORIGINAL REFERENCE NUMBERS OF THE TRUCK MANUFACTURERS IN THE INVOICE TO VEHICLE OWNERS OR TO ANYBODY ELSE. THE CUSTOMER TAKES HIS OWN RESPONSIBILITY IF HE DOES NOT COMPLY WITH WHAT ABOVE.

		Code	OEM new	OEM old
HAND PUMP	● Model	61955	1427670	1384501 393620
	★ Application			
	● 3 BUS			
	★			
	● 4 BUS			
	★	DC9 01/02/03/04/05/06/19/20/21 - DSC9 13/15 - DC11 07 - DSC12 01/02 - DC11/D12 PDE - DSC9 11/12/13/15		
	● IND. MARINE ENGINE 4			
	★	D12A/M EMS - D16A/M - DSC12 41 - DSI12 40		
	● IND. MARINE ENGINE 5			
	★	DC9A EMS		
	● 3 TRUCK			
	★			
● 4 TRUCK				
★	DC9 01/02/03/04/05/06/19/20/21 - DSC9 11/12/13/15 - DC11 07 - DSC12 01/02 - DC11/D12 PDE - DC16 01/02 - DSC14 13/15 - DSC11 74/75/79			
● P-G-R-T TRUCK				
★	D9/11/12/16			



		64790	804670	
O-RING	● 4 BUS			
	★	DC11 - D12 - DC9 19/20/21 - DC11/D12 PDE		
	● F-K-N BUS			
	★	D9 N XPI - D12 HPI - D9/D11/D12 PDE - D9		
	● IND. MARINE ENGINE 4			
	★	DI16 40A/41A/48A/53A - D16A - D16M - DSI14 69M - DI14 82M - D14 - D12M EMS - D12A EMS		
	● IND. MARINE ENGINE 5			
	★	DC9A EMS		
	● 4 TRUCK			
	★	DC11 - D12 - DC9 19/20/21 - DC11/D12 PDE - DSC12 01/02 - DC16 01/02 - DT12 02/08/10 - DC12 03 HPI		
	● P-G-R-T TRUCK			
	★	D16 - D9/D11/D12 PDE - D12 HPI		

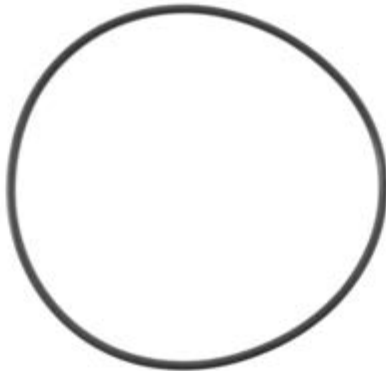

ALL THE COMPONENTS LISTED IN OUR CATALOGUE ARE NOT ORIGINAL, THOUGH PERFECTLY INTERCHANGEABLE. REFERENCE NUMBERS, EITHER ORIGINAL OR OF A DIFFERENT NATURE, ARE FOR INFORMATION PURPOSES ONLY. WHEN PLACING AN ORDER, PLEASE, ALWAYS USE COSIBO REFERENCE NUMBERS AND DO NOT MENTION THE ORIGINAL REFERENCE NUMBERS OF THE TRUCK MANUFACTURERS IN THE INVOICE TO VEHICLE OWNERS OR TO ANYBODY ELSE. THE CUSTOMER TAKES HIS OWN RESPONSIBILITY IF HE DOES NOT COMPLY WITH WHAT ABOVE.

		Code	OEM new	OEM old
FUEL FILTER	● Model	61162	364624	
	★ Application			
	● 3 BUS			
	★			
	● IND. AMRINE ENGINE 4			
	★ D/DC/DI9/11/14 M - D/DC/DI14 A - DS14A - DSC14A - DSI14 A/M - DS11M - DSC11 M - DI12 41/42/43/44/45M			
	● 3 TRUCK			
	★ DSC14 03/06 - DSC14 04 (EDC) - DSC14 09 (EDC) - DSC14 16 (EDC) - DSC14 08			

		60632	1763776	1411894
FUEL FILTER (6 BAR)	● 4 BUS			
	★ L D9/DC11/D12/D14 12.2 BAR - S D9/DC11/D12/D14 - DSC12 03/05 - DC12 01/02 - D11/D12 PDE - D12A EMS - D16M			
	● IND. MARINE ENGINE 4			
	★ D12A/M EMS - D16M - DI16 40/41/48/53A			
	● 4 TRUCK			
	★ L D9/DC11/D12/D14 9.3/12.2 BAR - S D9/DC11/D12/D14 - DSC12 03/05 - DC12 01/02 - D11/D12 PDE - D12A EMS - D16M - DC11 01/02/03/04/06			

ALL THE COMPONENTS LISTED IN OUR CATALOGUE ARE NOT ORIGINAL, THOUGH PERFECTLY INTERCHANGEABLE. REFERENCE NUMBERS, EITHER ORIGINAL OR OF A DIFFERENT NATURE, ARE FOR INFORMATION PURPOSES ONLY. WHEN PLACING AN ORDER, PLEASE, ALWAYS USE COSIBO REFERENCE NUMBERS AND DO NOT MENTION THE ORIGINAL REFERENCE NUMBERS OF THE TRUCK MANUFACTURERS IN THE INVOICE TO VEHICLE OWNERS OR TO ANYBODY ELSE. THE CUSTOMER TAKES HIS OWN RESPONSIBILITY IF HE DOES NOT COMPLY WITH WHAT ABOVE.

	Code	OEM new	OEM old
O-RING SET	63322	1422564	
<ul style="list-style-type: none"> ● Model ★ Application 			
<ul style="list-style-type: none"> ● 4 BUS 			
<ul style="list-style-type: none"> ★ DC9 19/20/21 - DSC12 03 PDE - DC12 01/02/05/09/16 PDE - DC11 03/04/06 PDE - DSC12 05 PDE 			
<ul style="list-style-type: none"> ● F-K-N BUS 			
<ul style="list-style-type: none"> ★ D9 PDE - DC12 06/17 - D11 			
<ul style="list-style-type: none"> ● IND. MARINE ENGINE 4 			
<ul style="list-style-type: none"> ★ DC16 - D12A EMS - D12A/M EMS - D16 40A/41A/48A/53A 			
<ul style="list-style-type: none"> ● IND. MARINE ENGINE 5 			
<ul style="list-style-type: none"> ★ DC9A EMS 			
<ul style="list-style-type: none"> ● 4 TRUCK 			
<ul style="list-style-type: none"> ★ DC16 - DC9 19/20/21 - DSC12 03/05 PDE - DC12 01/02/09 PDE - DC16 01/02 PDE - DC11 01/02/03/04/06 PDE 			
<ul style="list-style-type: none"> ● P-G-R-T TRUCK 			
<ul style="list-style-type: none"> ★ D9 PDE - DC12 06/17 - D16 - D11 			



	Code	OEM new	OEM old
O-RING 18X1,6 (VITON GREEN)	60429	1340615	
<ul style="list-style-type: none"> ● 4 BUS 			
<ul style="list-style-type: none"> ★ DC11 - DC11 07 - D12 - DSC12 01/02 - DC9 01/02/03/04/05/06 			
<ul style="list-style-type: none"> ● IND.MARINE ENGINE 4 			
<ul style="list-style-type: none"> ★ D12A - D12M - D12 41/42/43/44/45/57M - DSC12 40/42A - DC12 40/42A 			
<ul style="list-style-type: none"> ● 4 TRUCK 			
<ul style="list-style-type: none"> ★ DC11 - DC11 07 - D12 - DSC12 01/02 - DC9 01/02/03/04/05/06 			



	Code	OEM new	OEM old
FUEL FILTER SET	64396	2003505	1794863
<ul style="list-style-type: none"> ● F-K-N BUS 			
<ul style="list-style-type: none"> ★ D9 XPI 			
<ul style="list-style-type: none"> ● IND.MARINE ENGINE 5 			
<ul style="list-style-type: none"> ★ DC9A XPI - DC13A XPI - DC16A XPI 			
<ul style="list-style-type: none"> ● P-G-R-T TRUCK 			
<ul style="list-style-type: none"> ★ D9 XPI - D13 - D13 XPI - DC16 XPI 			



ALL THE COMPONENTS LISTED IN OUR CATALOGUE ARE NOT ORIGINAL, THOUGH PERFECTLY INTERCHANGEABLE. REFERENCE NUMBERS, EITHER ORIGINAL OR OF A DIFFERENT NATURE, ARE FOR INFORMATION PURPOSES ONLY. WHEN PLACING AN ORDER, PLEASE, ALWAYS USE COSIBO REFERENCE NUMBERS AND DO NOT MENTION THE ORIGINAL REFERENCE NUMBERS OF THE TRUCK MANUFACTURERS IN THE INVOICE TO VEHICLE OWNERS OR TO ANYBODY ELSE. THE CUSTOMER TAKES HIS OWN RESPONSIBILITY IF HE DOES NOT COMPLY WITH WHAT ABOVE.

	Code	OEM new	OEM old
INJECTION PIPE 1ST	60319	258410	
<ul style="list-style-type: none"> ● Model ★ Application 			
<ul style="list-style-type: none"> ● 2 TRUCK ★ G/P/R/T 112 			
<ul style="list-style-type: none"> ● 1 TRUCK ★ L/LS/LT 111 - LB/LBS/LBT 111 			



INJECTION PIPE 2ST	60322	168778	
<ul style="list-style-type: none"> ● 2 TRUCK ★ G/P/R/T 112 			
<ul style="list-style-type: none"> ● 1 TRUCK ★ L/LS/LT 111 - LB/LBS/LBT 111 			







INJECTION PIPE 3RD	60320	258411	
<ul style="list-style-type: none"> ● 2 TRUCK ★ G/P/R/T 112 			
<ul style="list-style-type: none"> ● 1 TRUCK ★ L/LS/LT 111 - LB/LBS/LBT 111 			



INJECTON PIPE 4TH	60321	258412	
<ul style="list-style-type: none"> ● 2 TRUCK ★ G/P/R/T 112 			
<ul style="list-style-type: none"> ● 1 TRUCK ★ L/LS/LT 111 - LB/LBS/LBT 111 			



ALL THE COMPONENTS LISTED IN OUR CATALOGUE ARE NOT ORIGINAL, THOUGH PERFECTLY INTERCHANGEABLE. REFERENCE NUMBERS, EITHER ORIGINAL OR OF A DIFFERENT NATURE, ARE FOR INFORMATION PURPOSES ONLY. WHEN PLACING AN ORDER, PLEASE, ALWAYS USE COSIBO REFERENCE NUMBERS AND DO NOT MENTION THE ORIGINAL REFERENCE NUMBERS OF THE TRUCK MANUFACTURERS IN THE INVOICE TO VEHICLE OWNERS OR TO ANYBODY ELSE. THE CUSTOMER TAKES HIS OWN RESPONSIBILITY IF HE DOES NOT COMPLY WITH WHAT ABOVE.

	Code	OEM new	OEM old
INJECTION PIPE 5TH 	60323	168781	
<ul style="list-style-type: none"> ● Model ★ Application 			
<ul style="list-style-type: none"> ● 2 TRUCK ★ G/P/R/T 112 			
<ul style="list-style-type: none"> ● 1 TRUCK ★ L/LS/LT 111 - LB/LBS/LBT 111 			
INJECTION PIPE 6TH 	60324	168782	
<ul style="list-style-type: none"> ● 2 TRUCK ★ G/P/R/T 112 			
<ul style="list-style-type: none"> ● 1 TRUCK ★ L/LS/LT 111 - LB/LBS/LBT 111 			
INJECTION PIPE 1ST 	60331	169316	
<ul style="list-style-type: none"> ● 2 TRUCK ★ T112 			
<ul style="list-style-type: none"> ● 1 TRUCK ★ L/LS/LT110 - LB/LBS/LBT110 - L/LS/LT111 - LB/LBS/LBT111 			
INJECTION PIPE 2ND 	60332	169317	
<ul style="list-style-type: none"> ● 2 TRUCK ★ T112 			
<ul style="list-style-type: none"> ● 1 TRUCK ★ L/LS/LT110 - LB/LBS/LBT110 - L/LS/LT111 - LB/LBS/LBT111 			
INJECTION PIPE 3RD 	60333	169318	
<ul style="list-style-type: none"> ● 2 TRUCK ★ T112 			
<ul style="list-style-type: none"> ● 1 TRUCK ★ L/LS/LT110 - LB/LBS/LBT110 - L/LS/LT111 - LB/LBS/LBT111 			

ALL THE COMPONENTS LISTED IN OUR CATALOGUE ARE NOT ORIGINAL, THOUGH PERFECTLY INTERCHANGEABLE. REFERENCE NUMBERS, EITHER ORIGINAL OR OF A DIFFERENT NATURE, ARE FOR INFORMATION PURPOSES ONLY. WHEN PLACING AN ORDER, PLEASE, ALWAYS USE COSIBO REFERENCE NUMBERS AND DO NOT MENTION THE ORIGINAL REFERENCE NUMBERS OF THE TRUCK MANUFACTURERS IN THE INVOICE TO VEHICLE OWNERS OR TO ANYBODY ELSE. THE CUSTOMER TAKES HIS OWN RESPONSIBILITY IF HE DOES NOT COMPLY WITH WHAT ABOVE.

	Code	OEM new	OEM old
INJECTION PIPE 4TH	60334	169319	
<ul style="list-style-type: none"> ● Model ★ Application 			
<ul style="list-style-type: none"> ● 2 TRUCK ★ T112 			
<ul style="list-style-type: none"> ● 1 TRUCK ★ L/LS/LT110 - LB/LBS/LBT110 - L/LS/LT111 - LB/LBS/LBT111 			



INJECTION PIPE 5TH	60335	169320	
<ul style="list-style-type: none"> ● 2 TRUCK ★ T112 			
<ul style="list-style-type: none"> ● 1 TRUCK ★ L/LS/LT110 - LB/LBS/LBT110 - L/LS/LT111 - LB/LBS/LBT111 			



INJECTION PIPE 6TH	60336	169321	
<ul style="list-style-type: none"> ● 2 TRUCK ★ T112 			
<ul style="list-style-type: none"> ● 1 TRUCK ★ L/LS/LT110 - LB/LBS/LBT110 - L/LS/LT111 - LB/LBS/LBT111 			



INJECTION PIPE 1ST	60325	258686	
<ul style="list-style-type: none"> ● 1 TRUCK ★ L/LS/LT111 - LB/LBS/LBT111/111H 			
<ul style="list-style-type: none"> ● 1 TRUCK ★ L/LS/LT111 - LB/LBS/LBT111/111H 			



ALL THE COMPONENTS LISTED IN OUR CATALOGUE ARE NOT ORIGINAL, THOUGH PERFECTLY INTERCHANGEABLE. REFERENCE NUMBERS, EITHER ORIGINAL OR OF A DIFFERENT NATURE, ARE FOR INFORMATION PURPOSES ONLY. WHEN PLACING AN ORDER, PLEASE, ALWAYS USE COSIBO REFERENCE NUMBERS AND DO NOT MENTION THE ORIGINAL REFERENCE NUMBERS OF THE TRUCK MANUFACTURERS IN THE INVOICE TO VEHICLE OWNERS OR TO ANYBODY ELSE. THE CUSTOMER TAKES HIS OWN RESPONSIBILITY IF HE DOES NOT COMPLY WITH WHAT ABOVE.

	Code	OEM new	OEM old
INJECTION PIPE 2ND	60326	258687	



- Model
 - ★ Application
-
- 1 TRUCK
 - ★ L/LS/LT111 - LB/LBS/LBT111/111H

INJECTION PIPE 3RD	60327	258688	
---------------------------	--------------	--------	--



- 1 TRUCK
- ★ L/LS/LT111 - LB/LBS/LBT111/111H

INJECTION PIPE 4TH	60328	258689	
---------------------------	--------------	--------	--



- 1 TRUCK
- ★ L/LS/LT111 - LB/LBS/LBT111/111H

INJECTION PIPE 5TH	60329	258690	
---------------------------	--------------	--------	--



- 1 TRUCK
- ★ L/LS/LT111 - LB/LBS/LBT111/111H

ALL THE COMPONENTS LISTED IN OUR CATALOGUE ARE NOT ORIGINAL, THOUGH PERFECTLY INTERCHANGEABLE. REFERENCE NUMBERS, EITHER ORIGINAL OR OF A DIFFERENT NATURE, ARE FOR INFORMATION PURPOSES ONLY. WHEN PLACING AN ORDER, PLEASE, ALWAYS USE COSIBO REFERENCE NUMBERS AND DO NOT MENTION THE ORIGINAL REFERENCE NUMBERS OF THE TRUCK MANUFACTURERS IN THE INVOICE TO VEHICLE OWNERS OR TO ANYBODY ELSE. THE CUSTOMER TAKES HIS OWN RESPONSIBILITY IF HE DOES NOT COMPLY WITH WHAT ABOVE.

INJECTION PIPE 6TH



- Model
- ★ Application

Code	OEM new	OEM old
60330	258691	

- 1 TRUCK
- ★ L/LS/LT111 - LB/LBS/LBT111/111H

INJECTION PIPE 1ST



- 2 TRUCK
- ★ R - T142

60683	305286	
-------	--------	--

INJECTION PIPE 2ND



- 2 TRUCK
- ★ R - T142

60684	305287	
-------	--------	--

INJECTION PIPE 3RD



- 2 TRUCK
- ★ R - T142

60685	305288	
-------	--------	--





INJECTION PIPE 4TH







- 2 TRUCK
- ★ R - T142

60686	305289	
-------	--------	--





ALL THE COMPONENTS LISTED IN OUR CATALOGUE ARE NOT ORIGINAL, THOUGH PERFECTLY INTERCHANGEABLE. REFERENCE NUMBERS, EITHER ORIGINAL OR OF A DIFFERENT NATURE, ARE FOR INFORMATION PURPOSES ONLY. WHEN PLACING AN ORDER, PLEASE, ALWAYS USE COSIBO REFERENCE NUMBERS AND DO NOT MENTION THE ORIGINAL REFERENCE NUMBERS OF THE TRUCK MANUFACTURERS IN THE INVOICE TO VEHICLE OWNERS OR TO ANYBODY ELSE. THE CUSTOMER TAKES HIS OWN RESPONSIBILITY IF HE DOES NOT COMPLY WITH WHAT ABOVE.

	Code	OEM new	OEM old
<p>INJECTION PIPE 5TH</p> 	60687	320813	
<ul style="list-style-type: none"> ● Model ★ Application 			
<ul style="list-style-type: none"> ● 2 TRUCK ★ R - T142 			
<p>INJECTION PIPE 6TH</p> 	60688	320814	
<ul style="list-style-type: none"> ● 2 TRUCK ★ R - T142 			
<p>INJECTION PIPE 7TH</p> 	60689	348293	
<ul style="list-style-type: none"> ● 2 TRUCK ★ R - T142 			
<p>INJECTION PIPE 8TH</p> 	60690	348294	
<ul style="list-style-type: none"> ● 2 TRUCK ★ R - T142 			
<p>INJECTION PIPE 1ST</p> 	60692	263911	
<ul style="list-style-type: none"> ● 2 TRUCK ★ T142 ● 1 TRUCK ★ LB/LBS/LBT141 			





ALL THE COMPONENTS LISTED IN OUR CATALOGUE ARE NOT ORIGINAL, THOUGH PERFECTLY INTERCHANGEABLE. REFERENCE NUMBERS, EITHER ORIGINAL OR OF A DIFFERENT NATURE, ARE FOR INFORMATION PURPOSES ONLY. WHEN PLACING AN ORDER, PLEASE, ALWAYS USE COSIBO REFERENCE NUMBERS AND DO NOT MENTION THE ORIGINAL REFERENCE NUMBERS OF THE TRUCK MANUFACTURERS IN THE INVOICE TO VEHICLE OWNERS OR TO ANYBODY ELSE. THE CUSTOMER TAKES HIS OWN RESPONSIBILITY IF HE DOES NOT COMPLY WITH WHAT ABOVE.

	Code	OEM new	OEM old
INJECTION PIPE 2ND 	60693	263912	
<ul style="list-style-type: none"> ● Model ★ Application 			
<ul style="list-style-type: none"> ● 2 TRUCK ★ T142 			
<ul style="list-style-type: none"> ● 1 TRUCK ★ LB/LBS/LBT141 			
INJECTION PIPE 3RD 	60694	271147	
<ul style="list-style-type: none"> ● 2 TRUCK ★ T142 			
<ul style="list-style-type: none"> ● 1 TRUCK ★ LB/LBS/LBT141 			
INJECTION PIPE 4TH 	60695	271148	
<ul style="list-style-type: none"> ● 2 TRUCK ★ T142 			
<ul style="list-style-type: none"> ● 1 TRUCK ★ LB/LBS/LBT141 			
INJECTION PIPE 5TH 	60696	308385	263915
<ul style="list-style-type: none"> ● 2 TRUCK ★ T142 			
<ul style="list-style-type: none"> ● 1 TRUCK ★ LB/LBS/LBT141 			
INJECTION PIPE 6TH 	60697	308386	263916
<ul style="list-style-type: none"> ● 2 TRUCK ★ T142 			
<ul style="list-style-type: none"> ● 1 TRUCK ★ LB/LBS/LBT141 			

ALL THE COMPONENTS LISTED IN OUR CATALOGUE ARE NOT ORIGINAL, THOUGH PERFECTLY INTERCHANGEABLE. REFERENCE NUMBERS, EITHER ORIGINAL OR OF A DIFFERENT NATURE, ARE FOR INFORMATION PURPOSES ONLY. WHEN PLACING AN ORDER, PLEASE, ALWAYS USE COSIBO REFERENCE NUMBERS AND DO NOT MENTION THE ORIGINAL REFERENCE NUMBERS OF THE TRUCK MANUFACTURERS IN THE INVOICE TO VEHICLE OWNERS OR TO ANYBODY ELSE. THE CUSTOMER TAKES HIS OWN RESPONSIBILITY IF HE DOES NOT COMPLY WITH WHAT ABOVE.

	Code	OEM new	OEM old
INJECTION PIPE 7TH 	60698	263917	
<ul style="list-style-type: none"> ● Model ★ Application 			
<ul style="list-style-type: none"> ● 2 TRUCK ★ T142 			
<ul style="list-style-type: none"> ● 1 TRUCK ★ LB/LBS/LBT141 			
INJECTION PIPE 8TH 	60699	263918	
<ul style="list-style-type: none"> ● 2 TRUCK ★ T142 			
<ul style="list-style-type: none"> ● 1 TRUCK ★ LB/LBS/LBT141 			
INJECTION PIPE 1ST 	60712	322693	
<ul style="list-style-type: none"> ● 3 TRUCK ★ DN11 01 ENG 5307928 - ENG 4070104 			
<ul style="list-style-type: none"> ● 2 TRUCK ★ G/P/R/T112 			
INJECTION PIPE 2ND 	60713	322694	
<ul style="list-style-type: none"> ● 3 TRUCK ★ DN11 01 ENG 5307928 - ENG 4070104 			
<ul style="list-style-type: none"> ● 2 TRUCK ★ G/P/R/T112 			
INJECTION PIPE 3RD 	60714	322695	
<ul style="list-style-type: none"> ● 3 TRUCK ★ DN11 01 ENG 5307928 - ENG 4070104 			
<ul style="list-style-type: none"> ● 2 TRUCK ★ G/P/R/T112 			

ALL THE COMPONENTS LISTED IN OUR CATALOGUE ARE NOT ORIGINAL, THOUGH PERFECTLY INTERCHANGEABLE. REFERENCE NUMBERS, EITHER ORIGINAL OR OF A DIFFERENT NATURE, ARE FOR INFORMATION PURPOSES ONLY. WHEN PLACING AN ORDER, PLEASE, ALWAYS USE COSIBO REFERENCE NUMBERS AND DO NOT MENTION THE ORIGINAL REFERENCE NUMBERS OF THE TRUCK MANUFACTURERS IN THE INVOICE TO VEHICLE OWNERS OR TO ANYBODY ELSE. THE CUSTOMER TAKES HIS OWN RESPONSIBILITY IF HE DOES NOT COMPLY WITH WHAT ABOVE.

	Code	OEM new	OEM old
INJECTION PIPE 4TH	60715	322697	
	<ul style="list-style-type: none"> ● Model ★ Application 		
	<ul style="list-style-type: none"> ● 3 TRUCK ★ DN11 01 ENG 5307928 - ENG 4070104 		
	<ul style="list-style-type: none"> ● 2 TRUCK ★ G/P/R/T112 		
INJECTION PIPE 5TH	60716	322698	
	<ul style="list-style-type: none"> ● 3 TRUCK ★ DN11 01 ENG 5307928 - ENG 4070104 		
	<ul style="list-style-type: none"> ● 2 TRUCK ★ G/P/R/T112 		
INJECTION PIPE 6TH	60717	322699	
	<ul style="list-style-type: none"> ● 3 TRUCK ★ DN11 01 ENG 5307928 - ENG 4070104 		
	<ul style="list-style-type: none"> ● 2 TRUCK ★ G/P/R/T112 		
INJECTION PIPE 1ST	60706	312217	
	<ul style="list-style-type: none"> ● 3 TRUCK ★ DS11 73 - DS11 73 ENG 5307928 - ENG 4070104 		
	<ul style="list-style-type: none"> ● 2 TRUCK ★ G/P/R/T112 		

ALL THE COMPONENTS LISTED IN OUR CATALOGUE ARE NOT ORIGINAL, THOUGH PERFECTLY INTERCHANGEABLE. REFERENCE NUMBERS, EITHER ORIGINAL OR OF A DIFFERENT NATURE, ARE FOR INFORMATION PURPOSES ONLY. WHEN PLACING AN ORDER, PLEASE, ALWAYS USE COSIBO REFERENCE NUMBERS AND DO NOT MENTION THE ORIGINAL REFERENCE NUMBERS OF THE TRUCK MANUFACTURERS IN THE INVOICE TO VEHICLE OWNERS OR TO ANYBODY ELSE. THE CUSTOMER TAKES HIS OWN RESPONSIBILITY IF HE DOES NOT COMPLY WITH WHAT ABOVE.

	Code	OEM new	OEM old
INJECTION PIPE 2ND	60707	312218	
<ul style="list-style-type: none"> ● Model ★ Application 			
<ul style="list-style-type: none"> ● 3 TRUCK ★ DS11 73 - DS11 73 ENG 5307928 - ENG 4070104 			
<ul style="list-style-type: none"> ● 2 TRUCK ★ G/P/R/T112 			



INJECTION PIPE 3RD	60708	312219	
<ul style="list-style-type: none"> ● 3 TRUCK ★ DS11 73 - DS11 73 ENG 5307928 - ENG 4070104 			
<ul style="list-style-type: none"> ● 2 TRUCK ★ G/P/R/T112 			



INJECTION PIPE 4TH	60709	312221	
<ul style="list-style-type: none"> ● 3 TRUCK ★ DS11 73 - DS11 73 ENG 5307928 - ENG 4070104 			
<ul style="list-style-type: none"> ● 2 TRUCK ★ G/P/R/T112 			



INJECTION PIPE 5TH	60710	312222	
<ul style="list-style-type: none"> ● 3 TRUCK ★ DS11 73 - DS11 73 ENG 5307928 - ENG 4070104 			
<ul style="list-style-type: none"> ● 2 TRUCK ★ G/P/R/T112 			



ALL THE COMPONENTS LISTED IN OUR CATALOGUE ARE NOT ORIGINAL, THOUGH PERFECTLY INTERCHANGEABLE. REFERENCE NUMBERS, EITHER ORIGINAL OR OF A DIFFERENT NATURE, ARE FOR INFORMATION PURPOSES ONLY. WHEN PLACING AN ORDER, PLEASE, ALWAYS USE COSIBO REFERENCE NUMBERS AND DO NOT MENTION THE ORIGINAL REFERENCE NUMBERS OF THE TRUCK MANUFACTURERS IN THE INVOICE TO VEHICLE OWNERS OR TO ANYBODY ELSE. THE CUSTOMER TAKES HIS OWN RESPONSIBILITY IF HE DOES NOT COMPLY WITH WHAT ABOVE.

INJECTION PIPE 6TH



	Code	OEM new	OEM old
● Model ★ Application	60711	312223	
● 3 TRUCK			
★ DS11 73 - DS11 73 ENG 5307928 - ENG 4070104			
● 2 TRUCK			
★ G/P/R/T112			

INJECTION PIPE 1ST



	Code	OEM new	OEM old
	60700	369291	
● 3 TRUCK			
★ DSC11 12/13/16 ENG 5307928 - ENG 4070104			

INJECTION PIPE 2ND







	Code	OEM new	OEM old
	60701	369292	
● A.29.1			
★ DOPO 60700			
● 3 TRUCK			
★ DSC11 12/13/16 ENG 5307928 - ENG 4070104			

INJECTION PIPE 3RD



	Code	OEM new	OEM old
	60702	369293	
● 3 TRUCK			
★ DSC11 12/13/16 ENG 5307928 - ENG 4070104			

ALL THE COMPONENTS LISTED IN OUR CATALOGUE ARE NOT ORIGINAL, THOUGH PERFECTLY INTERCHANGEABLE. REFERENCE NUMBERS, EITHER ORIGINAL OR OF A DIFFERENT NATURE, ARE FOR INFORMATION PURPOSES ONLY. WHEN PLACING AN ORDER, PLEASE, ALWAYS USE COSIBO REFERENCE NUMBERS AND DO NOT MENTION THE ORIGINAL REFERENCE NUMBERS OF THE TRUCK MANUFACTURERS IN THE INVOICE TO VEHICLE OWNERS OR TO ANYBODY ELSE. THE CUSTOMER TAKES HIS OWN RESPONSIBILITY IF HE DOES NOT COMPLY WITH WHAT ABOVE.

	Code	OEM new	OEM old
INJECTION PIPE 4TH 	60703	369295	
<ul style="list-style-type: none"> ● Model ★ Application 			
<ul style="list-style-type: none"> ● 3 TRUCK ★ DSC11 12/13/16 ENG 5307928 - ENG 4070104 			
INJECTION PIPE 5TH 	60704	369296	
<ul style="list-style-type: none"> ● 3 TRUCK ★ DSC11 12/13/16 ENG 5307928 - ENG 4070104 			
INJECTION PIPE 6TH 	60705	369297	
<ul style="list-style-type: none"> ● 3 TRUCK ★ DSC11 12/13/16 ENG 5307928 - ENG 4070104 			
INJECTION PIPE 1ST 	60677	365485	
<ul style="list-style-type: none"> ● 3 TRUCK ★ DS11 34 ENG 5307929 - 5335712 - ENG 4070105 - 4092818 - DS11 75 ENG 5331613 - ENG 4090481 - DSC11 18 ENG 5307929 - 5329484 - ENG 4070105 - 4089032 - ENG 5314171 - 5329484 - ENG 5314171 - DSC11 17 ENG 5307929 - 5329484 - ENG 4070105 - 4089033 - DSC11 30 ENG 5320489 - 5331740 - ENG 4082306 - 4090198 - ENG 5310453 - 5331740 - ENG 4072204 - 4090198 - DSC11 08 ENG 5308341 - 5342128 - ENG 4088739 - DSC11 08/10 L03 ENG 5322490 - ENG 4011502 - DSC11 10 ENG 5308341 - 5342127 - ENG 4088739 			
<ul style="list-style-type: none"> ● 3 BUS ★ DS11 34B/C - DSC11 74C - DS11 74C/B - DS11 77C ENG 5326645 - DSC11 04 ENG 5327909 - DSC11 08/18B - DSC11 08C ENG 5335712 - DS11 E01 ENG 5331740 - ENG 5332619 			

ALL THE COMPONENTS LISTED IN OUR CATALOGUE ARE NOT ORIGINAL, THOUGH PERFECTLY INTERCHANGEABLE. REFERENCE NUMBERS, EITHER ORIGINAL OR OF A DIFFERENT NATURE, ARE FOR INFORMATION PURPOSES ONLY. WHEN PLACING AN ORDER, PLEASE, ALWAYS USE COSIBO REFERENCE NUMBERS AND DO NOT MENTION THE ORIGINAL REFERENCE NUMBERS OF THE TRUCK MANUFACTURERS IN THE INVOICE TO VEHICLE OWNERS OR TO ANYBODY ELSE. THE CUSTOMER TAKES HIS OWN RESPONSIBILITY IF HE DOES NOT COMPLY WITH WHAT ABOVE.

INJECTION PIPE 2ND



- Model
- ★ Application

Code**OEM new****OEM old****60678**

365486

- **3 TRUCK**

- ★ DS11 34 ENG 5307929 - 5335712 - ENG 4070105 - 4092818 - DS11 75 ENG 5331613 - ENG 4090481 - DSC11 18 ENG 5307929 - 5329484 - ENG 4070105 - 4089032 - ENG 5314171 - 5329484 - ENG 5314171 - DSC11 17 ENG 5307929 - 5329484 - ENG 4070105 - 4089033 - DSC11 30 ENG 5320489 - 5331740 - ENG 4082306 - 4090198 - ENG 5310453 - 5331740 - ENG 4072204 - 4090198 - DSC11 08 ENG 5308341 - 5342128 - ENG 4088739 - DSC11 08/10 L03 ENG 5322490 - ENG 4011502 - DSC11 10 ENG 5308341 - 5342127 - ENG 4088739

- **3 BUS**

- ★ DS11 34B/C - DSC11 74C - DS11 74C/B - DS11 77C ENG 5326645 - DSC11 04 ENG 5327909 - DSC11 08/18B - DSC11 08C ENG 5335712 - DS11 E01 ENG 5331740 - ENG 5332619

INJECTION PIPE 3RD

**60679**

365487

- **3 TRUCK**

- ★ DS11 34 ENG 5307929 - 5335712 - ENG 4070105 - 4092818 - DS11 75 ENG 5331613 - ENG 4090481 - DSC11 18 ENG 5307929 - 5329484 - ENG 4070105 - 4089032 - ENG 5314171 - 5329484 - ENG 5314171 - DSC11 17 ENG 5307929 - 5329484 - ENG 4070105 - 4089033 - DSC11 30 ENG 5320489 - 5331740 - ENG 4082306 - 4090198 - ENG 5310453 - 5331740 - ENG 4072204 - 4090198 - DSC11 08 ENG 5308341 - 5342128 - ENG 4088739 - DSC11 08/10 L03 ENG 5322490 - ENG 4011502 - DSC11 10 ENG 5308341 - 5342127 - ENG 4088739

- **3 BUS**

- ★ DS11 34B/C - DSC11 74C - DS11 74C/B - DS11 77C ENG 5326645 - DSC11 04 ENG 5327909 - DSC11 08/18B - DSC11 08C ENG 5335712 - DS11 E01 ENG 5331740 - ENG 5332619

INJECTION PIPE 4TH

**60680**

365489

- **3 TRUCK**

- ★ DS11 34 ENG 5307929 - 5335712 - ENG 4070105 - 4092818 - DS11 75 ENG 5331613 - ENG 4090481 - DSC11 18 ENG 5307929 - 5329484 - ENG 4070105 - 4089032 - ENG 5314171 - 5329484 - ENG 5314171 - DSC11 17 ENG 5307929 - 5329484 - ENG 4070105 - 4089033 - DSC11 30 ENG 5320489 - 5331740 - ENG 4082306 - 4090198 - ENG 5310453 - 5331740 - ENG 4072204 - 4090198 - DSC11 08 ENG 5308341 - 5342128 - ENG 4088739 - DSC11 08/10 L03 ENG 5322490 - ENG 4011502 - DSC11 10 ENG 5308341 - 5342127 - ENG 4088739

- **3 BUS**

- ★ DS11 34B/C - DSC11 74C - DS11 74C/B - DS11 77C ENG 5326645 - DSC11 04 ENG 5327909 - DSC11 08/18B - DSC11 08C ENG 5335712 - DS11 E01 ENG 5331740 - ENG 5332619

ALL THE COMPONENTS LISTED IN OUR CATALOGUE ARE NOT ORIGINAL, THOUGH PERFECTLY INTERCHANGEABLE. REFERENCE NUMBERS, EITHER ORIGINAL OR OF A DIFFERENT NATURE, ARE FOR INFORMATION PURPOSES ONLY. WHEN PLACING AN ORDER, PLEASE, ALWAYS USE COSIBO REFERENCE NUMBERS AND DO NOT MENTION THE ORIGINAL REFERENCE NUMBERS OF THE TRUCK MANUFACTURERS IN THE INVOICE TO VEHICLE OWNERS OR TO ANYBODY ELSE. THE CUSTOMER TAKES HIS OWN RESPONSIBILITY IF HE DOES NOT COMPLY WITH WHAT ABOVE.

INJECTION PIPE 5TH



	Code	OEM new	OEM old
● Model	60681	365490	
★ Application			
● 3 TRUCK			
★	DS11 34 ENG 5307929 - 5335712 - ENG 4070105 - 4092818 - DS11 75 ENG 5331613 - ENG 4090481 - DSC11 18 ENG 5307929 - 5329484 - ENG 4070105 - 4089032 - ENG 5314171 - 5329484 - ENG 5314171 - DSC11 17 ENG 5307929 - 5329484 - ENG 4070105 - 4089033 - DSC11 30 ENG 5320489 - 5331740 - ENG 4082306 - 4090198 - ENG 5310453 - 5331740 - ENG 4072204 - 4090198 - DSC11 08 ENG 5308341 - 5342128 - ENG 4088739 - DSC11 08/10 L03 ENG 5322490 - ENG 4011502 - DSC11 10 ENG 5308341 - 5342127 - ENG 4088739		
● 3 BUS			
★	DS11 34B/C - DSC11 74C - DS11 74C/B - DS11 77C ENG 5326645 - DSC11 04 ENG 5327909 - DSC11 08/18B - DSC11 08C ENG 5335712 - DSI11 E01 ENG 5331740 - ENG 5332619		

INJECTION PIPE 6TH



	Code	OEM new	OEM old
	60682	365491	
● 3 TRUCK			
★	DS11 34 ENG 5307929 - 5335712 - ENG 4070105 - 4092818 - DS11 75 ENG 5331613 - ENG 4090481 - DSC11 18 ENG 5307929 - 5329484 - ENG 4070105 - 4089032 - ENG 5314171 - 5329484 - ENG 5314171 - DSC11 17 ENG 5307929 - 5329484 - ENG 4070105 - 4089033 - DSC11 30 ENG 5320489 - 5331740 - ENG 4082306 - 4090198 - ENG 5310453 - 5331740 - ENG 4072204 - 4090198 - DSC11 08 ENG 5308341 - 5342128 - ENG 4088739 - DSC11 08/10 L03 ENG 5322490 - ENG 4011502 - DSC11 10 ENG 5308341 - 5342127 - ENG 4088739		
● 4 BUS			
★	DS11 34B/C - DSC11 74C - DS11 74C/B - DS11 77C ENG 5326645 - DSC11 04 ENG 5327909 - DSC11 08/18B - DSC11 08C ENG 5335712 - DSI11 E01 ENG 5331740 - ENG 5332619		

INJECTION PIPE 1ST



	Code	OEM new	OEM old
	60657	1105079	351301
● 3 TRUCK			
★	DS9 05 - DSC9 02 ENG 5108502 - ENG 4012891 - DSC9 07/08 ENG 5105298 - ENG 4306729 - DSC9 09 ENG 5110567 - ENG 4014926		
● 3 BUS			
★	DS9 05B - DSC9 08B ENG 5111501		

ALL THE COMPONENTS LISTED IN OUR CATALOGUE ARE NOT ORIGINAL, THOUGH PERFECTLY INTERCHANGEABLE. REFERENCE NUMBERS, EITHER ORIGINAL OR OF A DIFFERENT NATURE, ARE FOR INFORMATION PURPOSES ONLY. WHEN PLACING AN ORDER, PLEASE, ALWAYS USE COSIBO REFERENCE NUMBERS AND DO NOT MENTION THE ORIGINAL REFERENCE NUMBERS OF THE TRUCK MANUFACTURERS IN THE INVOICE TO VEHICLE OWNERS OR TO ANYBODY ELSE. THE CUSTOMER TAKES HIS OWN RESPONSIBILITY IF HE DOES NOT COMPLY WITH WHAT ABOVE.

	Code	OEM new	OEM old
INJECTION PIPE 2ND	60658	1105080	351302
<ul style="list-style-type: none"> ● Model ★ Application 			
<ul style="list-style-type: none"> ● 3 TRUCK ★ DS9 05 - DSC9 02 ENG 5108502 - ENG 4012891 - DSC9 07/08 ENG 5105298 - ENG 4306729 - DSC9 09 ENG 5110567 - ENG 4014926 			
<ul style="list-style-type: none"> ● 3 BUS ★ DS9 05B - DSC9 08B ENG 5111501 			



	Code	OEM new	OEM old
INJECTION PIPE 3RD	60659	1105081	351303
<ul style="list-style-type: none"> ● 3 TRUCK ★ DS9 05 - DSC9 02 ENG 5108502 - ENG 4012891 - DSC9 07/08 ENG 5105298 - ENG 4306729 - DSC9 09 ENG 5110567 - ENG 4014926 			
<ul style="list-style-type: none"> ● 3 BUS ★ DS9 05B - DSC9 08B ENG 5111501 			



	Code	OEM new	OEM old
INJECTION PIPE 4TH	60660	1105082	351305
<ul style="list-style-type: none"> ● 3 TRUCK ★ DS9 05 - DSC9 02 ENG 5108502 - ENG 4012891 - DSC9 07/08 ENG 5105298 - ENG 4306729 - DSC9 09 ENG 5110567 - ENG 4014926 			
<ul style="list-style-type: none"> ● 3 BUS ★ DS9 05B - DSC9 08B ENG 5111501 			



	Code	OEM new	OEM old
INJECTION PIPE 5TH	60661	1105083	351306
<ul style="list-style-type: none"> ● 3 TRUCK ★ DS9 05 - DSC9 02 ENG 5108502 - ENG 4012891 - DSC9 07/08 ENG 5105298 - ENG 4306729 - DSC9 09 ENG 5110567 - ENG 4014926 			
<ul style="list-style-type: none"> ● 3 BUS ★ DS9 05B - DSC9 08B ENG 5111501 			



ALL THE COMPONENTS LISTED IN OUR CATALOGUE ARE NOT ORIGINAL, THOUGH PERFECTLY INTERCHANGEABLE. REFERENCE NUMBERS, EITHER ORIGINAL OR OF A DIFFERENT NATURE, ARE FOR INFORMATION PURPOSES ONLY. WHEN PLACING AN ORDER, PLEASE, ALWAYS USE COSIBO REFERENCE NUMBERS AND DO NOT MENTION THE ORIGINAL REFERENCE NUMBERS OF THE TRUCK MANUFACTURERS IN THE INVOICE TO VEHICLE OWNERS OR TO ANYBODY ELSE. THE CUSTOMER TAKES HIS OWN RESPONSIBILITY IF HE DOES NOT COMPLY WITH WHAT ABOVE.

INJECTION PIPE 6TH



	Code	OEM new	OEM old
● Model ★ Application	60662	1105084	351307
● 3 TRUCK			
★	DS9 05 - DSC9 02 ENG 5108502 - ENG 4012891 - DSC9 07/08 ENG 5105298 - ENG 4306729 - DSC9 09 ENG 5110567 - ENG 4014926		
● 3 BUS			
★	DS9 05B - DSC9 08B ENG 5111501		

INJECTION PIPE 1ST



	Code	OEM new	OEM old
	60663	1105073	351309
● 3 TRUCK			
★	DN9 01 ENG 5108502 - ENG 4012891 - DS9 06 ENG 5108502 - ENG 4012891 - DS9 08 - DSC9 10 ENG 5105298 - ENG 4306729		
● 3 BUS			
★	DS9 08B		

INJECTION PIPE 2ND







	Code	OEM new	OEM old
	60664	1105074	351310
● 3 TRUCK			
★	DN9 01 ENG 5108502 - ENG 4012891 - DS9 06 ENG 5108502 - ENG 4012891 - DS9 08 - DSC9 10 ENG 5105298 - ENG 4306729		
● 3 BUS			
★	DS9 08B		

INJECTION PIPE 3RD







	Code	OEM new	OEM old
	60665	1105075	351311
● 3 TRUCK			
★	DN9 01 ENG 5108502 - ENG 4012891 - DS9 06 ENG 5108502 - ENG 4012891 - DS9 08 - DSC9 10 ENG 5105298 - ENG 4306729		
● 3 BUS			
★	DS9 08B		





ALL THE COMPONENTS LISTED IN OUR CATALOGUE ARE NOT ORIGINAL, THOUGH PERFECTLY INTERCHANGEABLE. REFERENCE NUMBERS, EITHER ORIGINAL OR OF A DIFFERENT NATURE, ARE FOR INFORMATION PURPOSES ONLY. WHEN PLACING AN ORDER, PLEASE, ALWAYS USE COSIBO REFERENCE NUMBERS AND DO NOT MENTION THE ORIGINAL REFERENCE NUMBERS OF THE TRUCK MANUFACTURERS IN THE INVOICE TO VEHICLE OWNERS OR TO ANYBODY ELSE. THE CUSTOMER TAKES HIS OWN RESPONSIBILITY IF HE DOES NOT COMPLY WITH WHAT ABOVE.

	Code	OEM new	OEM old
INJECTION PIPE 4TH	60666	1105076	351313
	<ul style="list-style-type: none"> ● Model ★ Application 		
	<ul style="list-style-type: none"> ● 3 TRUCK ★ DN9 01 ENG 5108502 - ENG 4012891 - DS9 06 ENG 5108502 - ENG 4012891 - DS9 08 - DSC9 10 ENG 5105298 - ENG 4306729 		
	<ul style="list-style-type: none"> ● 3 BUS ★ DS9 08B 		
INJECTION PIPE 5TH	60667	1105077	351314
	<ul style="list-style-type: none"> ● 3 TRUCK ★ DN9 01 ENG 5108502 - ENG 4012891 - DS9 06 ENG 5108502 - ENG 4012891 - DS9 08 - DSC9 10 ENG 5105298 - ENG 4306729 		
	<ul style="list-style-type: none"> ● 3 BUS ★ DS9 08B 		
INJECTION PIPE 6TH	60668	1105078	351315
	<ul style="list-style-type: none"> ● 3 TRUCK ★ DN9 01 ENG 5108502 - ENG 4012891 - DS9 06 ENG 5108502 - ENG 4012891 - DS9 08 - DSC9 10 ENG 5105298 - ENG 4306729 		
	<ul style="list-style-type: none"> ● 3 BUS ★ DS9 08B 		
INJECTION PIPE 1ST	60669	381918	
	<ul style="list-style-type: none"> ● 3 TRUCK ★ DSC14 03 ENG 5550629 - ENG 4190967 - GRH880 - DSC14 06 ENG 5550629 - ENG 4191153 - DSC14 04 (EDC) - 		
INJECTION PIPE 2ND	60670	381919	
	<ul style="list-style-type: none"> ● 3 TRUCK ★ DSC14 03 ENG 5550629 - ENG 4190967 - GRH880 - DSC14 06 ENG 5550629 - ENG 4191153 - DSC14 04 (EDC) - 		





ALL THE COMPONENTS LISTED IN OUR CATALOGUE ARE NOT ORIGINAL, THOUGH PERFECTLY INTERCHANGEABLE. REFERENCE NUMBERS, EITHER ORIGINAL OR OF A DIFFERENT NATURE, ARE FOR INFORMATION PURPOSES ONLY. WHEN PLACING AN ORDER, PLEASE, ALWAYS USE COSIBO REFERENCE NUMBERS AND DO NOT MENTION THE ORIGINAL REFERENCE NUMBERS OF THE TRUCK MANUFACTURERS IN THE INVOICE TO VEHICLE OWNERS OR TO ANYBODY ELSE. THE CUSTOMER TAKES HIS OWN RESPONSIBILITY IF HE DOES NOT COMPLY WITH WHAT ABOVE.

	Code	OEM new	OEM old
INJECTION PIPE 3RD 	60671	381920	
<ul style="list-style-type: none"> ● Model ★ Application 			
<ul style="list-style-type: none"> ● 3 TRUCK ★ DSC14 03 ENG 5550629 - ENG 4190967 - GRH880 - DSC14 06 ENG 5550629 - ENG 4191153 - DSC14 04 (EDC) - 			
INJECTION PIPE 4TH 	60672	381921	
<ul style="list-style-type: none"> ● 3 TRUCK ★ DSC14 03 ENG 5550629 - ENG 4190967 - GRH880 - DSC14 06 ENG 5550629 - ENG 4191153 - DSC14 04 (EDC) - 			
INJECTION PIPE 5TH 	60673	381922	
<ul style="list-style-type: none"> ● 3 TRUCK ★ DSC14 03 ENG 5550629 - ENG 4190967 - GRH880 - DSC14 06 ENG 5550629 - ENG 4191153 - DSC14 04 (EDC) - 			
INJECTION PIPE 6TH 	60674	381923	
<ul style="list-style-type: none"> ● 3 TRUCK ★ DSC14 03 ENG 5550629 - ENG 4190967 - GRH880 - DSC14 06 ENG 5550629 - ENG 4191153 - DSC14 04 (EDC) - 			
INJECTION PIPE 7TH 	60675	381924	
<ul style="list-style-type: none"> ● 3 TRUCK ★ DSC14 03 ENG 5550629 - ENG 4190967 - GRH880 - DSC14 06 ENG 5550629 - ENG 4191153 - DSC14 04 (EDC) - 			

ALL THE COMPONENTS LISTED IN OUR CATALOGUE ARE NOT ORIGINAL, THOUGH PERFECTLY INTERCHANGEABLE. REFERENCE NUMBERS, EITHER ORIGINAL OR OF A DIFFERENT NATURE, ARE FOR INFORMATION PURPOSES ONLY. WHEN PLACING AN ORDER, PLEASE, ALWAYS USE COSIBO REFERENCE NUMBERS AND DO NOT MENTION THE ORIGINAL REFERENCE NUMBERS OF THE TRUCK MANUFACTURERS IN THE INVOICE TO VEHICLE OWNERS OR TO ANYBODY ELSE. THE CUSTOMER TAKES HIS OWN RESPONSIBILITY IF HE DOES NOT COMPLY WITH WHAT ABOVE.

	Code	OEM new	OEM old
INJECTION PIPE 8TH 	60676	381925	
<ul style="list-style-type: none"> ● Model ★ Application 			
<ul style="list-style-type: none"> ● 3 TRUCK ★ DSC14 03 ENG 5550629 - ENG 4190967 - GRH880 - DSC14 06 ENG 5550629 - ENG 4191153 - DSC14 04 (EDC) - 			
INJECTION PIPE 1ST 	61746	1303951	
<ul style="list-style-type: none"> ● 3 TRUCK ★ DSC14 09 (EDC) ENG 5547245 - ENG 4186607 - DSC14 08/10 - DSC14 16 (EDC) - ● IND. MARINE ENGINE 4 ★ DS/DSC14 A 			
INJECTION PIPE 2ND 	61747	1303952	
<ul style="list-style-type: none"> ● 3 TRUCK ★ DSC14 09 (EDC) ENG 5547245 - ENG 4186607 - DSC14 08/10 - DSC14 16 (EDC) - ● IND. MARINE ENGINE 4 ★ DS/DSC14 A 			
INJECTION PIPE 3RD 	61748	1303953	
<ul style="list-style-type: none"> ● 3 TRUCK ★ DSC14 09 (EDC) ENG 5547245 - ENG 4186607 - DSC14 08/10 - DSC14 16 (EDC) - ● IND. MARINE ENGINE 4 ★ DS/DSC14 A 			
INJECTION PIPE 4TH 	61749	1303954	
<ul style="list-style-type: none"> ● 3 TRUCK ★ DSC14 09 (EDC) ENG 5547245 - ENG 4186607 - DSC14 08/10 - DSC14 16 (EDC) - ● IND. MARINE ENGINE 4 ★ DS/DSC14 A 			

ALL THE COMPONENTS LISTED IN OUR CATALOGUE ARE NOT ORIGINAL, THOUGH PERFECTLY INTERCHANGEABLE. REFERENCE NUMBERS, EITHER ORIGINAL OR OF A DIFFERENT NATURE, ARE FOR INFORMATION PURPOSES ONLY. WHEN PLACING AN ORDER, PLEASE, ALWAYS USE COSIBO REFERENCE NUMBERS AND DO NOT MENTION THE ORIGINAL REFERENCE NUMBERS OF THE TRUCK MANUFACTURERS IN THE INVOICE TO VEHICLE OWNERS OR TO ANYBODY ELSE. THE CUSTOMER TAKES HIS OWN RESPONSIBILITY IF HE DOES NOT COMPLY WITH WHAT ABOVE.

	Code	OEM new	OEM old
INJECTION PIPE 5TH	61750	1303955	
	<ul style="list-style-type: none"> ● Model ★ Application 		
	<ul style="list-style-type: none"> ● 3 TRUCK ★ DSC14 09 (EDC) ENG 5547245 - ENG 4186607 - DSC14 08/10 - DSC14 16 (EDC) - 		
	<ul style="list-style-type: none"> ● IND. MARINE ENGINE 4 ★ DS/DSC14 A 		
INJECTION PIPE 6TH	61751	1303956	
	<ul style="list-style-type: none"> ● 3 TRUCK ★ DSC14 09 (EDC) ENG 5547245 - ENG 4186607 - DSC14 08/10 - DSC14 16 (EDC) - 		
	<ul style="list-style-type: none"> ● IND. MARINE ENGINE 4 ★ DS/DSC14 A 		
INJECTION PIPE 7TH	61752	1303957	
	<ul style="list-style-type: none"> ● 3 TRUCK ★ DSC14 09 (EDC) ENG 5547245 - ENG 4186607 - DSC14 08/10 - DSC14 16 (EDC) - 		
	<ul style="list-style-type: none"> ● IND. MARINE ENGINE 4 ★ DS/DSC14 A 		
INJECTION PIPE 8TH	61753	1303958	
	<ul style="list-style-type: none"> ● 3 TRUCK ★ DSC14 09 (EDC) ENG 5547245 - ENG 4186607 - DSC14 08/10 - DSC14 16 (EDC) - 		
	<ul style="list-style-type: none"> ● IND. MARINE ENGINE 4 ★ DS/DSC14 A 		

ALL THE COMPONENTS LISTED IN OUR CATALOGUE ARE NOT ORIGINAL, THOUGH PERFECTLY INTERCHANGEABLE. REFERENCE NUMBERS, EITHER ORIGINAL OR OF A DIFFERENT NATURE, ARE FOR INFORMATION PURPOSES ONLY. WHEN PLACING AN ORDER, PLEASE, ALWAYS USE COSIBO REFERENCE NUMBERS AND DO NOT MENTION THE ORIGINAL REFERENCE NUMBERS OF THE TRUCK MANUFACTURERS IN THE INVOICE TO VEHICLE OWNERS OR TO ANYBODY ELSE. THE CUSTOMER TAKES HIS OWN RESPONSIBILITY IF HE DOES NOT COMPLY WITH WHAT ABOVE.

INJECTION PIPE SET (FROM 1ST TO 4TH)



	Code	OEM new	OEM old
● Model	63676	1341702	
★ Application			
● 3 TRUCK			
★ DSC14 09 (EDC) ENG 5547245 - ENG 4186607 - DSC14 08/10 - DSC14 16 (EDC) -			
● IND. MARINE ENGINE 4			
★ DS/DSC14 A			

INJECTION PIPE SET (FROM 5TH TO 8TH)

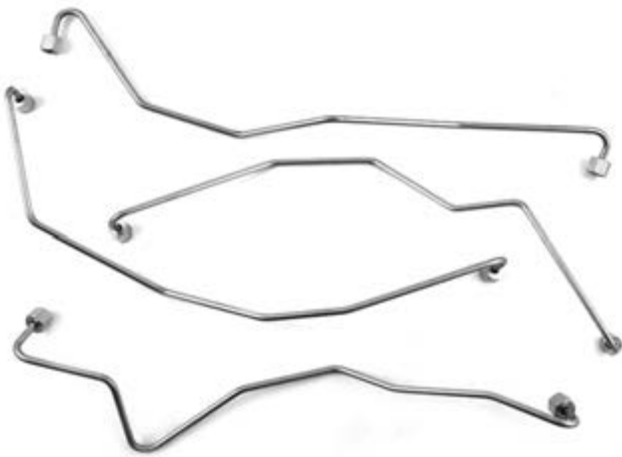

	63675	1341701	
● 3 TRUCK			
★ DSC14 09 (EDC) ENG 5547245 - ENG 4186607 - DSC14 08/10 - DSC14 16 (EDC) -			
● IND. MARINE ENGINE 4			
★ DS/DSC14 A			

INJECTION PIPE 1ST



	63954	1382072	1313678
● 3 TRUCK			
★ DS11 75 ENG 5352582 - ENG 4103049 - DSC11 21 ENG 4103049			
● 3 BUS			
★ DSC11 21B/21C/71B/71C ENG 5352582 - ENG 4103049 - DS11 75B/77B/77C/78B/78C ENG 5352582 - ENG 4103049 - DSC11 24B/24C/27C (EDC) ENG 5352582 - ENG 4103049 -			

ALL THE COMPONENTS LISTED IN OUR CATALOGUE ARE NOT ORIGINAL, THOUGH PERFECTLY INTERCHANGEABLE. REFERENCE NUMBERS, EITHER ORIGINAL OR OF A DIFFERENT NATURE, ARE FOR INFORMATION PURPOSES ONLY. WHEN PLACING AN ORDER, PLEASE, ALWAYS USE COSIBO REFERENCE NUMBERS AND DO NOT MENTION THE ORIGINAL REFERENCE NUMBERS OF THE TRUCK MANUFACTURERS IN THE INVOICE TO VEHICLE OWNERS OR TO ANYBODY ELSE. THE CUSTOMER TAKES HIS OWN RESPONSIBILITY IF HE DOES NOT COMPLY WITH WHAT ABOVE.

INJECTION PIPE 2ND



	Code	OEM new	OEM old
● Model	63955	1382073	1313679
★ Application			
● 3 TRUCK			
★ DS11 75 ENG 5352582 - ENG 4103049 - DSC11 21 ENG 4103049			
● 3 BUS			
★ DSC11 21B/21C/71B/71C ENG 5352582 - ENG 4103049 - DS11 75B/77B/77C/78B/78C ENG 5352582 - ENG 4103049 - DSC11 24B/24C/27C (EDC) ENG 5352582 - ENG 4103049 -			

INJECTION PIPE 3RD



	Code	OEM new	OEM old
	63956	1382074	1313680
● 3 TRUCK			
★ DS11 75 ENG 5352582 - ENG 4103049 - DSC11 21 ENG 4103049			
● 3 BUS			
★ DSC11 21B/21C/71B/71C ENG 5352582 - ENG 4103049 - DS11 75B/77B/77C/78B/78C ENG 5352582 - ENG 4103049 - DSC11 24B/24C/27C (EDC) ENG 5352582 - ENG 4103049 -			

INJECTION PIPE 4TH



	Code	OEM new	OEM old
	63957	1313681	
● 3 TRUCK			
★ DS11 75 ENG 5352582 - ENG 4103049 - DSC11 21 ENG 4103049			
● 3 BUS			
★ DSC11 21B/21C/71B/71C ENG 5352582 - ENG 4103049 - DS11 75B/77B/77C/78B/78C ENG 5352582 - ENG 4103049 - DSC11 24B/24C/27C (EDC) ENG 5352582 - ENG 4103049 -			

INJECTION PIPE 5TH



	Code	OEM new	OEM old
	63958	1313682	
● 3 TRUCK			
★ DS11 75 ENG 5352582 - ENG 4103049 - DSC11 21 ENG 4103049			
● 3 BUS			
★ DSC11 21B/21C/71B/71C ENG 5352582 - ENG 4103049 - DS11 75B/77B/77C/78B/78C ENG 5352582 - ENG 4103049 - DSC11 24B/24C/27C (EDC) ENG 5352582 - ENG 4103049 -			

ALL THE COMPONENTS LISTED IN OUR CATALOGUE ARE NOT ORIGINAL, THOUGH PERFECTLY INTERCHANGEABLE. REFERENCE NUMBERS, EITHER ORIGINAL OR OF A DIFFERENT NATURE, ARE FOR INFORMATION PURPOSES ONLY. WHEN PLACING AN ORDER, PLEASE, ALWAYS USE COSIBO REFERENCE NUMBERS AND DO NOT MENTION THE ORIGINAL REFERENCE NUMBERS OF THE TRUCK MANUFACTURERS IN THE INVOICE TO VEHICLE OWNERS OR TO ANYBODY ELSE. THE CUSTOMER TAKES HIS OWN RESPONSIBILITY IF HE DOES NOT COMPLY WITH WHAT ABOVE.

	Code	OEM new	OEM old
INJECTION PIPE 6TH	63959	1313683	
<ul style="list-style-type: none"> ● Model ★ Application 			
<ul style="list-style-type: none"> ● 3 TRUCK 			
<ul style="list-style-type: none"> ★ DS11 75 ENG 5352582 - ENG 4103049 - DSC11 21 ENG 4103049 			
<ul style="list-style-type: none"> ● 3 BUS 			
<ul style="list-style-type: none"> ★ DSC11 21B/21C/71B/71C ENG 5352582 - ENG 4103049 - DS11 75B/77B/77C/78B/78C ENG 5352582 - ENG 4103049 - DSC11 24B/24C/27C (EDC) ENG 5352582 - ENG 4103049 - 			



	63374/S	1382071	1313676
INJECTION PIPE SET (FROM 1ST TO 3RD)			
<ul style="list-style-type: none"> ● 3 TRUCK 			
<ul style="list-style-type: none"> ★ DS11 75 ENG 5352582 - ENG 4103049 - DSC11 21 ENG 4103049 			
<ul style="list-style-type: none"> ● 3 BUS 			
<ul style="list-style-type: none"> ★ DSC11 21B/21C/71B/71C ENG 5352582 - ENG 4103049 - DS11 75B/77B/77C/78B/78C ENG 5352582 - ENG 4103049 - DSC11 24B/24C/27C (EDC) ENG 5352582 - ENG 4103049 - 			



	63373/S	1313677	
INJECTION PIPE SET (FROM 4TH TO 6TH)			
<ul style="list-style-type: none"> ● 3 TRUCK 			
<ul style="list-style-type: none"> ★ DS11 75 ENG 5352582 - ENG 4103049 - DSC11 21 ENG 4103049 - ALSO ENG 5333534 - 			
<ul style="list-style-type: none"> ● 3 BUS 			
<ul style="list-style-type: none"> ★ DSC11 21B/21C/71B/71C ENG 5352582 - ENG 4103049 - DS11 75B/77B/77C/78B/78C ENG 5352582 - ENG 4103049 - DSC11 24B/24C/27C (EDC) ENG 5352582 - ENG 4103049 - ALSO ENG 5333534 - 			



ALL THE COMPONENTS LISTED IN OUR CATALOGUE ARE NOT ORIGINAL, THOUGH PERFECTLY INTERCHANGEABLE. REFERENCE NUMBERS, EITHER ORIGINAL OR OF A DIFFERENT NATURE, ARE FOR INFORMATION PURPOSES ONLY. WHEN PLACING AN ORDER, PLEASE, ALWAYS USE COSIBO REFERENCE NUMBERS AND DO NOT MENTION THE ORIGINAL REFERENCE NUMBERS OF THE TRUCK MANUFACTURERS IN THE INVOICE TO VEHICLE OWNERS OR TO ANYBODY ELSE. THE CUSTOMER TAKES HIS OWN RESPONSIBILITY IF HE DOES NOT COMPLY WITH WHAT ABOVE.

INJECTION PIPE SET (FROM 1ST TO 3RD)



	Code	OEM new	OEM old
● Model ★ Application	63991	1382075	1302530
● 3 TRUCK			
★	DSC11 22 (EDC) ENG 5345021 - ENG 5345022 - ENG 4098746 - ENG 4098747 - DSC11 23 ENG 5320785 - DSC11 21 ENG 5333533 - DSC11 39 ENG 5531900 - ENG 4090569 - DSC11 35/36 ENG 5331693 - DSC11 22 (EDC) - DTC11 01 (EDC) ENG 5317578 - 5345021 - ENG 5345022 - ENG 4080150 - 4098746 - ENG 4098747 - DSC11 70 (EDC) - DTC11 02 (EDC) ENG 5345021 - ENG 5345022 - ENG 4098746 - ENG 4098747 -		
● 3 BUS			
★	DSC11 21B/21C ENG 5333533 - DSC11 22B/24C/27C (EDC) - DSC11 23B/35B/36B - DSC11 24C (EDC) ENG 5333881 - DSC11 70 (EDC) ENG 5345022 - ENG 4098747 -		

INJECTION PIPE SET (FROM 4TH TO 6TH)



	Code	OEM new	OEM old
	63992	1302531	
● 3 TRUCK			
★	DSC11 22 (EDC) ENG 5345021 - ENG 5345022 - ENG 4098746 - ENG 4098747 - DSC11 23 ENG 5320785 - DSC11 21 ENG 5333533 - DSC11 39 ENG 5531900 - ENG 4090569 - DSC11 35/36 ENG 5331693 - DSC11 22 (EDC) - DTC11 01 (EDC) ENG 5317578 - 5345021 - ENG 5345022 - ENG 4080150 - 4098746 - ENG 4098747 - DSC11 70 (EDC) - DTC11 02 (EDC) ENG 5345021 - ENG 5345022 - ENG 4098746 - ENG 4098747 -		
● 3 BUS			
★	DSC11 21B/21C ENG 5333533 - DSC11 22B/24C/27C (EDC) - DSC11 23B/35B/36B - DSC11 24C (EDC) ENG 5333881 - DSC11 70 (EDC) ENG 5345022 - ENG 4098747 -		

INJECTION PIPE SET (FROM 1ST TO 3RD)



	Code	OEM new	OEM old
	61771/S	365484	
● 3 TRUCK			
★	DS11 34 ENG 5307929 - 5335712 - ENG 4070105 - 4092818 - DS11 75 ENG 5331613 - ENG 4090481 - DSC11 18 ENG 5307929 - 5329484 - ENG 4070105 - 4089032 - ENG 5314171 - 5329484 - ENG 5314171 - DSC11 17 ENG 5307929 - 5329484 - ENG 4070105 - 4089033 - DSC11 30 ENG 5320489 - 5331740 - ENG 4082306 - 4090198 - ENG 5310453 - 5331740 - ENG 4072204 - 4090198 - DSC11 08 ENG 5308341 - 5342128 - ENG 4088739 - DSC11 08/10 L03 ENG 5322490 - ENG 4011502 - DSC11 10 ENG 5308341 - 5342127 - ENG 4088739		
● 3 BUS			
★	DS11 34B/C - DSC11 74C - DS11 74C/B - DS11 77C ENG 5326645 - DSC11 04 ENG 5327909 - DSC11 08/18B - DSC11 08C ENG 5335712 - DS11 E01 ENG 5331740 - ENG 5332619		

ALL THE COMPONENTS LISTED IN OUR CATALOGUE ARE NOT ORIGINAL, THOUGH PERFECTLY INTERCHANGEABLE. REFERENCE NUMBERS, EITHER ORIGINAL OR OF A DIFFERENT NATURE, ARE FOR INFORMATION PURPOSES ONLY. WHEN PLACING AN ORDER, PLEASE, ALWAYS USE COSIBO REFERENCE NUMBERS AND DO NOT MENTION THE ORIGINAL REFERENCE NUMBERS OF THE TRUCK MANUFACTURERS IN THE INVOICE TO VEHICLE OWNERS OR TO ANYBODY ELSE. THE CUSTOMER TAKES HIS OWN RESPONSIBILITY IF HE DOES NOT COMPLY WITH WHAT ABOVE.

INJECTION PIPE SET (FROM 4TH TO 6TH)



	Code	OEM new	OEM old
● Model ★ Application	61770/S	365488	
● 3 TRUCK			
★	DS11 34 ENG 5307929 - 5335712 - ENG 4070105 - 4092818 - DS11 75 ENG 5331613 - ENG 4090481 - DSC11 18 ENG 5307929 - 5329484 - ENG 4070105 - 4089032 - ENG 5314171 - 5329484 - ENG 5314171 - DSC11 17 ENG 5307929 - 5329484 - ENG 4070105 - 4089033 - DSC11 30 ENG 5320489 - 5331740 - ENG 4082306 - 4090198 - ENG 5310453 - 5331740 - ENG 4072204 - 4090198 - DSC11 08 ENG 5308341 - 5342128 - ENG 4088739 - DSC11 08/10 L03 ENG 5322490 - ENG 4011502 - DSC11 10 ENG 5308341 - 5342127 - ENG 4088739		
● 3 BUS			
★	DS11 34B/C - DSC11 74C - DS11 74C/B - DS11 77C ENG 5326645 - DSC11 04 ENG 5327909 - DSC11 08/18B - DSC11 08C ENG 5335712 - DS11 E01 ENG 5331740 - ENG 5332619		

INJECTION PIPE 1ST



	Code	OEM new	OEM old
	63571	1375369	
● 4 TRUCK			
★	DSC12 01/02 - DC11 07		
● 4 BUS			
★	DC11 07 - DSC12 02		
● IND. MARINE ENGINE 4			
★	DSC/DC12 41/46/47/48		

INJECTION PIPE 2ND



	Code	OEM new	OEM old
	63572	1375370	
● 4 TRUCK			
★	DSC12 01/02 - DC11 07		
● 4 BUS			
★	DC11 07 - DSC12 02		
● IND. MARINE ENGINE 4			
★	DSC/DC12 41/46/47/48		

ALL THE COMPONENTS LISTED IN OUR CATALOGUE ARE NOT ORIGINAL, THOUGH PERFECTLY INTERCHANGEABLE. REFERENCE NUMBERS, EITHER ORIGINAL OR OF A DIFFERENT NATURE, ARE FOR INFORMATION PURPOSES ONLY. WHEN PLACING AN ORDER, PLEASE, ALWAYS USE COSIBO REFERENCE NUMBERS AND DO NOT MENTION THE ORIGINAL REFERENCE NUMBERS OF THE TRUCK MANUFACTURERS IN THE INVOICE TO VEHICLE OWNERS OR TO ANYBODY ELSE. THE CUSTOMER TAKES HIS OWN RESPONSIBILITY IF HE DOES NOT COMPLY WITH WHAT ABOVE.

	Code	OEM new	OEM old
INJECTION PIPE 3RD	63573	1375371	
<ul style="list-style-type: none"> ● Model ★ Application 			
<ul style="list-style-type: none"> ● 4 TRUCK 			
<ul style="list-style-type: none"> ★ DSC12 01/02 - DC11 07 			
<ul style="list-style-type: none"> ● 4 BUS 			
<ul style="list-style-type: none"> ★ DC11 07 - DSC12 02 			
<ul style="list-style-type: none"> ● IND. MARINE ENGINE 4 			
<ul style="list-style-type: none"> ★ DSC/DC12 41/46/47/48 			



INJECTION PIPE 4TH	63574	1375372	
<ul style="list-style-type: none"> ● 4 TRUCK 			
<ul style="list-style-type: none"> ★ DSC12 01/02 - DC11 07 			
<ul style="list-style-type: none"> ● 4 BUS 			
<ul style="list-style-type: none"> ★ DC11 07 - DSC12 02 			
<ul style="list-style-type: none"> ● IND. MARINE ENGINE 4 			
<ul style="list-style-type: none"> ★ DSC/DC12 41/46/47/48 			



INJECTION PIPE 5TH	63575	1375373	
<ul style="list-style-type: none"> ● 4 TRUCK 			
<ul style="list-style-type: none"> ★ DSC12 01/02 - DC11 07 			
<ul style="list-style-type: none"> ● 4 BUS 			
<ul style="list-style-type: none"> ★ DC11 07 - DSC12 02 			
<ul style="list-style-type: none"> ● IND. MARINE ENGINE 4 			
<ul style="list-style-type: none"> ★ DSC/DC12 41/46/47/48 			



ALL THE COMPONENTS LISTED IN OUR CATALOGUE ARE NOT ORIGINAL, THOUGH PERFECTLY INTERCHANGEABLE. REFERENCE NUMBERS, EITHER ORIGINAL OR OF A DIFFERENT NATURE, ARE FOR INFORMATION PURPOSES ONLY. WHEN PLACING AN ORDER, PLEASE, ALWAYS USE COSIBO REFERENCE NUMBERS AND DO NOT MENTION THE ORIGINAL REFERENCE NUMBERS OF THE TRUCK MANUFACTURERS IN THE INVOICE TO VEHICLE OWNERS OR TO ANYBODY ELSE. THE CUSTOMER TAKES HIS OWN RESPONSIBILITY IF HE DOES NOT COMPLY WITH WHAT ABOVE.

INJECTION PIPE 6TH



- Model
- ★ Application

Code	OEM new	OEM old
63576	1375374	

- 4 TRUCK
- ★ DSC12 01/02 - DC11 07
- 4 BUS
- ★ DC11 07 - DSC12 02
- IND. MARINE ENGINE 4
- ★ DSC/DC12 41/46/47/48

INJECTION PIPE SET (FROM 1ST TO 8TH)

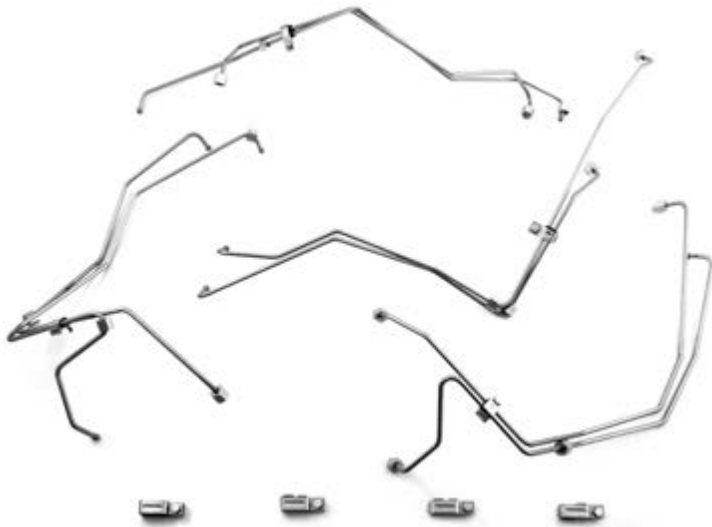

- 4 TRUCK
- ★ DSC14

64000	1357628 1357633	
-------	--------------------	--

ALL THE COMPONENTS LISTED IN OUR CATALOGUE ARE NOT ORIGINAL, THOUGH PERFECTLY INTERCHANGEABLE. REFERENCE NUMBERS, EITHER ORIGINAL OR OF A DIFFERENT NATURE, ARE FOR INFORMATION PURPOSES ONLY. WHEN PLACING AN ORDER, PLEASE, ALWAYS USE COSIBO REFERENCE NUMBERS AND DO NOT MENTION THE ORIGINAL REFERENCE NUMBERS OF THE TRUCK MANUFACTURERS IN THE INVOICE TO VEHICLE OWNERS OR TO ANYBODY ELSE. THE CUSTOMER TAKES HIS OWN RESPONSIBILITY IF HE DOES NOT COMPLY WITH WHAT ABOVE.

FUEL FILTER (2 BAR)



	Code	OEM new	OEM old
● Model	60630	1372444	
★ Application			
● 4 BUS			
★	DC11 07 - DSC12 01/02 - K94 DC9 01/02/03/04/05/06 - K/L/N94 DSC9 - N94 DC9 01		
● IND. MARINE ENGINE 4			
★	D/DC/DI9 A/M - D12 A/M - D/DC/DI11 A - DS9/DSC9/DSI9 - DS11A/DSC11A/DSI11A - DI12 41/42/43/44/45/M		
● 4 TRUCK			
★	DC11 07 - DSC12 01/02 - DSC11 74/75/79 - DSC14 13/15 - DSC9L - DC9L		

FUEL FILTER



	62401	1873018	1446432
● 4 BUS			
★	DC9 19/20/21		
● F-K-N BUS			
★	L/S D9/D11/D12 PDE		
● IND. MARINE ENGINE 4			
★	D16A		
● IND. MARINE ENGINE 5			
★	DC9A EMS		
● 4 TRUCK			
★	S D16 - L D16 9.3/12.2 BAR - DC19 19/20/21 - DC16 01/02		
● P-G-R-T TRUCK			
★	L/S D16 - L/S D9/D11/D12 PDE - DC16 03/04/05/06/08/09/17/18/19		

ALL THE COMPONENTS LISTED IN OUR CATALOGUE ARE NOT ORIGINAL, THOUGH PERFECTLY INTERCHANGEABLE. REFERENCE NUMBERS, EITHER ORIGINAL OR OF A DIFFERENT NATURE, ARE FOR INFORMATION PURPOSES ONLY. WHEN PLACING AN ORDER, PLEASE, ALWAYS USE COSIBO REFERENCE NUMBERS AND DO NOT MENTION THE ORIGINAL REFERENCE NUMBERS OF THE TRUCK MANUFACTURERS IN THE INVOICE TO VEHICLE OWNERS OR TO ANYBODY ELSE. THE CUSTOMER TAKES HIS OWN RESPONSIBILITY IF HE DOES NOT COMPLY WITH WHAT ABOVE.

FUEL FILTER



	Code	OEM new	OEM old
● Model	63886	1873016	1459762
★ Application			
● F-K-N BUS			
★ D12 HPI - L/S D12 HPI -			
● 4 TRUCK			
★ L D12 HPI 9.3/12.2 BAR - S D12 HPI - DT12 - DC12 03 HPI			
● P-G-R-T TRUCK			
★ L/S HPI - D12 HPI			

FILTER PIPE



	65469	1473979	
● 4 TRUCK			
★ DT12 - DC12 03 HPI			
● F-K-N BUS			
★ D12 HPI			
● P-G-R-T TRUCK			
★ D12 HPI			

ALL THE COMPONENTS LISTED IN OUR CATALOGUE ARE NOT ORIGINAL, THOUGH PERFECTLY INTERCHANGEABLE. REFERENCE NUMBERS, EITHER ORIGINAL OR OF A DIFFERENT NATURE, ARE FOR INFORMATION PURPOSES ONLY. WHEN PLACING AN ORDER, PLEASE, ALWAYS USE COSIBO REFERENCE NUMBERS AND DO NOT MENTION THE ORIGINAL REFERENCE NUMBERS OF THE TRUCK MANUFACTURERS IN THE INVOICE TO VEHICLE OWNERS OR TO ANYBODY ELSE. THE CUSTOMER TAKES HIS OWN RESPONSIBILITY IF HE DOES NOT COMPLY WITH WHAT ABOVE.

	Code	OEM new	OEM old
FLANGE	64347	1549330	1376871
<ul style="list-style-type: none"> ● Model ★ Application 			
<ul style="list-style-type: none"> ● 4 BUS 			
<ul style="list-style-type: none"> ★ DC11 07 - DSC12 02 			
<ul style="list-style-type: none"> ● 4 TRUCK 			
<ul style="list-style-type: none"> ★ DC11 07 - DSC12 01/02 			
<ul style="list-style-type: none"> ● IND. MARINE ENGINE 4 			
<ul style="list-style-type: none"> ★ DI12 41/42/43/44/45/57M - DSC12 40/42A - DC12 40/42A 			



INJECTION PUMP PLATE	60720	392204	280862
<ul style="list-style-type: none"> ● 3 TRUCK 			
<ul style="list-style-type: none"> ★ 			



INJECTION PUMP PLATE	60721	318523	
<ul style="list-style-type: none"> ● 3 BUS 			
<ul style="list-style-type: none"> ★ 			
<ul style="list-style-type: none"> ● 3 TRUCK 			
<ul style="list-style-type: none"> ★ 			



ALL THE COMPONENTS LISTED IN OUR CATALOGUE ARE NOT ORIGINAL, THOUGH PERFECTLY INTERCHANGEABLE. REFERENCE NUMBERS, EITHER ORIGINAL OR OF A DIFFERENT NATURE, ARE FOR INFORMATION PURPOSES ONLY. WHEN PLACING AN ORDER, PLEASE, ALWAYS USE COSIBO REFERENCE NUMBERS AND DO NOT MENTION THE ORIGINAL REFERENCE NUMBERS OF THE TRUCK MANUFACTURERS IN THE INVOICE TO VEHICLE OWNERS OR TO ANYBODY ELSE. THE CUSTOMER TAKES HIS OWN RESPONSIBILITY IF HE DOES NOT COMPLY WITH WHAT ABOVE.

INJECTION PUMP PLATE



● Model
★ Application

Code	OEM new	OEM old
63084	1111494	

● 3 BUS

★

● 3 TRUCK

★

● IND. MARINE ENGINE 4

★

ALL THE COMPONENTS LISTED IN OUR CATALOGUE ARE NOT ORIGINAL, THOUGH PERFECTLY INTERCHANGEABLE. REFERENCE NUMBERS, EITHER ORIGINAL OR OF A DIFFERENT NATURE, ARE FOR INFORMATION PURPOSES ONLY. WHEN PLACING AN ORDER, PLEASE, ALWAYS USE COSIBO REFERENCE NUMBERS AND DO NOT MENTION THE ORIGINAL REFERENCE NUMBERS OF THE TRUCK MANUFACTURERS IN THE INVOICE TO VEHICLE OWNERS OR TO ANYBODY ELSE. THE CUSTOMER TAKES HIS OWN RESPONSIBILITY IF HE DOES NOT COMPLY WITH WHAT ABOVE.

	Code	OEM new	OEM old
FUEL TANK CAP	61548	1122696	361692
● Model			
★ Application			
● 3 BUS			
★			
● 3 TRUCK			
★			



	66625	308710	
METAL FUEL TANK PLUG W/KEY			
● 2 TRUCK			
★ 112-142			
● 3 TRUCK			
★ 113-143			



	61745	1478450	1369848 1432186
FUELL TANK CAP W/O KEY			
● 4 TRUCK			
★ CH 2022159 - CH 2022160 - CH 5161834 - CH 5161835 - CH 9115701 - CH 9115702 - CH 3598108 - CH 3598109 - DT12 02/08/10 CH 2009304 - CH 2009305 - CH 5126028 - CH 5126029 - CH 9100952 - CH 9100953 - CH 3574738 - CH 3574739 - DC12 03HPI CH 2009304 - CH 2009305 - CH 5126028 - CH 5126029 - CH 9100952 - CH 9100953 - CH 3574738 - CH 3574739 - D16 CH 2022159 - CH 5161834 - CH 9115701 - CH 3598108			
● P-G-R-T TRUCK			
★ PDE CH 2022159 - CH 2024649 - CH 5161834 - CH 5169578 - CH 9115701 - CH 9118385 - CH 3598108 - CH 3602569 - CH 2022160 - 2024648 - CH 5161835 - 5169577 - CH 9115702 - 9118384 - CH 3598109 - 3602568 - HPI CH 2009304 - CH 2009305 - CH 5126028 - CH 5126029 - CH 9100952 - CH 9100953 - CH 3574738 - CH 3574739 - XPI			



	Code	OEM new	OEM old
FUELL TANK CAP W/ KEY	63864	2123147	1481301 2061500
● Model			
★ Application			
● 4 TRUCK			
★	D16 CH 2022159 - CH 2022160 - CH 5161834 - CH 5161835 - CH 9115701 - CH 9115702 - CH 3598108 - CH 3598109 - DT12 02/08/10 DC12 03 HPI CH 2009304 - CH 2009305 - CH 5126028 - CH 5126029 - CH 9100952 - CH 9100953 - CH 3574738 - CH 3574739		
● P-G-R-T TRUCK			
★	PDE CH 2022159 - CH 2022160 - 2024648 - CH 2024649 - CH 5161834 - CH 5161835 - 5169577 - CH 5169578 - CH 9115701 - CH 9115702 - 9118384 - CH 9118385 - CH 3598108 - CH 3598109 - 3602568 - CH 3602569 - HPI CH 2009304 - CH 2009305 - CH 5126028 - CH 5126029 - CH 9100952 - CH 9100953 - CH 3574738 - CH 3574739 - XPI		
● 4 BUS			
★			



FUEL TANK FILLER CAP (OLD VERSION)	62225	1432187	
● 4 TRUCK			
★	D16 CH 2022159 - CH 2022160 - CH 5161834 - CH 5161835 - CH 9115701 - CH 9115702 - CH 3598108 - CH 3598109 - DT12 02/08/10 DC12 03 HPI CH 2009304 - CH 2009305 - CH 5126028 - CH 5126029 - CH 9100952 - CH 9100953 - CH 3574738 - CH 3574739		
● P - G - R - T TRUCK			
★	PDE CH 2022159 - CH 2022160 - 2024648 - CH 2024649 - CH 5161834 - CH 5161835 - 5169577 - CH 5169578 - CH 9115701 - CH 9115702 - 9118384 - CH 9118385 - CH 3598108 - CH 3598109 - 3602568 - CH 3602569 - HPI CH 2009304 - CH 2009305 - CH 5126028 - CH 5126029 - CH 9100952 - CH 9100953 - CH 3574738 - CH 3574739 - XPI		
● 4 BUS			
★			





ANTITHEFT FUEL TANK CAP	65157	65157	
● 3 TRUCK			
★			
● 4 TRUCK			
★			
● P-G-R-T TRUCK			
★			



ALL THE COMPONENTS LISTED IN OUR CATALOGUE ARE NOT ORIGINAL, THOUGH PERFECTLY INTERCHANGEABLE. REFERENCE NUMBERS, EITHER ORIGINAL OR OF A DIFFERENT NATURE, ARE FOR INFORMATION PURPOSES ONLY. WHEN PLACING AN ORDER, PLEASE, ALWAYS USE COSIBO REFERENCE NUMBERS AND DO NOT MENTION THE ORIGINAL REFERENCE NUMBERS OF THE TRUCK MANUFACTURERS IN THE INVOICE TO VEHICLE OWNERS OR TO ANYBODY ELSE. THE CUSTOMER TAKES HIS OWN RESPONSIBILITY IF HE DOES NOT COMPLY WITH WHAT ABOVE.

		Code	OEM new	OEM old
O-RING 	● Model	66573/1	242857	
	★ Application			
	● 3 BUS			
	★			
	● 3 TRUCK			
	★			
	● 4 BUS			
	★			
	● 4 TRUCK			
	★	D16 - DT12 02/08/10 - DC12 03 HPI		
● P-G-R-T TRUCK				
★	PDE - HPI - XPI			

		62534	1401839 1398636	1387191 1398636 1401839
TENSIONING BAND + RUBBER CUSHION L=683 mm 	● 4 BUS			
	★			
	● 4 TRUCK			
	★			
	● P-G-R-T TRUCK			
	★			

		62535	1401840 1482500	1387193 1401840 1482500
TENSIONING BAND + RUBBER CUSHION L=710 mm 	● 4 TRUCK			
	★			
	● P-G-R-T TRUCK			
	★			

ALL THE COMPONENTS LISTED IN OUR CATALOGUE ARE NOT ORIGINAL, THOUGH PERFECTLY INTERCHANGEABLE. REFERENCE NUMBERS, EITHER ORIGINAL OR OF A DIFFERENT NATURE, ARE FOR INFORMATION PURPOSES ONLY. WHEN PLACING AN ORDER, PLEASE, ALWAYS USE COSIBO REFERENCE NUMBERS AND DO NOT MENTION THE ORIGINAL REFERENCE NUMBERS OF THE TRUCK MANUFACTURERS IN THE INVOICE TO VEHICLE OWNERS OR TO ANYBODY ELSE. THE CUSTOMER TAKES HIS OWN RESPONSIBILITY IF HE DOES NOT COMPLY WITH WHAT ABOVE.

FUEL LEVEL GAUGE



- Model
- ★ Application

Code	OEM new	OEM old
65163	361481	

- 3 TRUCK

- ★

FUEL LEVEL GAUGE



- 4 TRUCK

- ★ D16

- P-G-R-T TRUCK

- ★ PDE

64028	1424074	1373479
-------	---------	---------

FUEL GAUGE



- 4 TRUCK

- ★

- P-G-R-T TRUCK



- ★

- 4 BUS

- ★

64370	1541083	1423990
-------	---------	---------

ALL THE COMPONENTS LISTED IN OUR CATALOGUE ARE NOT ORIGINAL, THOUGH PERFECTLY INTERCHANGEABLE. REFERENCE NUMBERS, EITHER ORIGINAL OR OF A DIFFERENT NATURE, ARE FOR INFORMATION PURPOSES ONLY. WHEN PLACING AN ORDER, PLEASE, ALWAYS USE COSIBO REFERENCE NUMBERS AND DO NOT MENTION THE ORIGINAL REFERENCE NUMBERS OF THE TRUCK MANUFACTURERS IN THE INVOICE TO VEHICLE OWNERS OR TO ANYBODY ELSE. THE CUSTOMER TAKES HIS OWN RESPONSIBILITY IF HE DOES NOT COMPLY WITH WHAT ABOVE.

	Code	OEM new	OEM old
SILENCER	62253	1114170	
	<ul style="list-style-type: none"> ● Model ★ Application 		
	<ul style="list-style-type: none"> ● 3 TRUCK ★ 		
SILENCER	60343	1338128	1338071
	<ul style="list-style-type: none"> ● 3 TRUCK ★ DS9/DSC9 6X4 84dB(A) - HK 4X4/6X4/6X6 - EK 6X4 84dB(A) - GR900/GR900R/GRS900/GRS900R 84dB(A) - DN9 84dB(A) - 4X2 6X2 6X4 6X2/4 GR880/GR880T 84dB(A) - P/R93 4X2 6X2 6X2/4 6X4 GA/GAE770 - GR/GRE871T - GR801/GR900 - 4X2 6X2 6X4 GR/GRE871T - GR801/GR900 84dB(A) - 4X2 6X2 6X2/4 6X4 G770 - GS771/772 - GR/GRE871 - GR/GRS900R 84dB - 4X2 6X2 6X4 GRH880 - GRH900 84dB(A) - 4X2 6X2 6X4 GRH880 84dB - 8X2 8X4 GR900/GRS900 84dB - 8X4 84dB(A) - DSC9 07/08 84dB(A) - 8X2 8X4 GRH880/GR900/GRS900 84dB(A) - G93 4X2 G770 - GA/GAE770 - GA/GAE774 - GR/GRE871T - GR801/GR900 - 4X2 6X2 G770 - GS771/772 - GR/GRE871T - GR/GRS900R 84dB(A) - P/R93 8X2 8X4 GR801 84dB(A) - 8X2 8X4 GR900/GR900R/GRS900/GRS900R 84dB(A) - P/R93 ad38 - ad42/62 84dB(A) - P93 ML4X2 - ML6X2 - ML6X4 - HL4X2 - HL6X2 GA776 84dB(A) - P93 ML/MV/HL 4X2/6X2 GA750 84dB(A) - DTC11 GRS900 - P93 4X2/6X2 GA850 ad38 - ad42/62 84dB(A) - P113 ML/HL 4X2/6X2 GA850/GA850R ad38 - ad42/62 84dB(A) 		
	<ul style="list-style-type: none"> ● 3 TRUCK ★ DN9 - DS9 - DSC9 - DSC9 07 - DTC11 - G/P/R 93 - P 113 		
SLIDING BUSHING	65088	1335618	
	<ul style="list-style-type: none"> ● 3 TRUCK ★ DN9 - DS9 - DSC9 - DSC9 07 - DTC11 - G/P/R 93 - P 113 		

ALL THE COMPONENTS LISTED IN OUR CATALOGUE ARE NOT ORIGINAL, THOUGH PERFECTLY INTERCHANGEABLE. REFERENCE NUMBERS, EITHER ORIGINAL OR OF A DIFFERENT NATURE, ARE FOR INFORMATION PURPOSES ONLY. WHEN PLACING AN ORDER, PLEASE, ALWAYS USE COSIBO REFERENCE NUMBERS AND DO NOT MENTION THE ORIGINAL REFERENCE NUMBERS OF THE TRUCK MANUFACTURERS IN THE INVOICE TO VEHICLE OWNERS OR TO ANYBODY ELSE. THE CUSTOMER TAKES HIS OWN RESPONSIBILITY IF HE DOES NOT COMPLY WITH WHAT ABOVE.

SILENCER



	Code	OEM new	OEM old
● Model	62336	1497013	1387823
★ Application			
● 4 TRUCK			
★ D16 CH 2002333 - CH 5106746 - CH 9092530 - CH 3560649			
● P-G-R-T TRUCK			
★ D16 CH 2002333 - CH 5106746 - CH 9092530			

SILENCER



	63093	1500455	1420278
● 4 TRUCK			
★ 4X4 6X6 - CR GRSH900 - GRSH900R			
● P-G-R-T TRUCK			
★ D9/D11/D12/D13 CH 2028960 - CH 5181645 - CH 9123036 - CH 3611301			
● 3 BUS			
★ CH 1828105			
● 4 BUS			
★ K/L 94			
● F-K-N BUS			
★ K			

SILENCER



	64740	1800871	1484094
● 4 TRUCK			
★ D9/D11/D12 CH 1290985 - CH 4499486 - CH 9082897 - CH 3542832 - D12 8X8 WLS/ZLS - D16 CH 2002334 - CH 5106747 - CH 9092531 - CH 3560650			
● P-G-R-T TRUCK			
★ D9/D11/D12/D13 CH 2028960 - CH 5181645 - CH 9123036 - CH 3611301 - D16 CH 2002334 - CH 5106747 - CH 9092531 - D9/D11/D12 CH 2028959 - CH 5181644 - CH 9123035 - CH 3611300			





ALL THE COMPONENTS LISTED IN OUR CATALOGUE ARE NOT ORIGINAL, THOUGH PERFECTLY INTERCHANGEABLE. REFERENCE NUMBERS, EITHER ORIGINAL OR OF A DIFFERENT NATURE, ARE FOR INFORMATION PURPOSES ONLY. WHEN PLACING AN ORDER, PLEASE, ALWAYS USE COSIBO REFERENCE NUMBERS AND DO NOT MENTION THE ORIGINAL REFERENCE NUMBERS OF THE TRUCK MANUFACTURERS IN THE INVOICE TO VEHICLE OWNERS OR TO ANYBODY ELSE. THE CUSTOMER TAKES HIS OWN RESPONSIBILITY IF HE DOES NOT COMPLY WITH WHAT ABOVE.

		Code	OEM new	OEM old
EXHAUST PIPE	● Model	60346	1361983	
	★ Application			
	● 3 BUS			
	★	CH 1827459 - DSC11 22/23/74 CH 1825186		
	● IND. MARINE ENGINE 4			
	★			
	● IND. MARINE ENGINE 5			
	★			
	● 3 TRUCK			
	★	DS9 DSC9 CH 1183014 6X4 GR900 - GRS900 84dB(A) - CH 1167918 4X4/6X6 ad38 46 84dB(A) - 8X4 84dB(A) - HK 4X4 - HK 6X6 84dB(A) CH 1167918 - 1183183 - GR/GRE871T 84dB(A) - 4X2 6X2 6X4 8X2 8X4 MA6X2A 84dB - GR801 84dB(A) CH 1192433 - CH 9000673 - P93H GR900/GRS900 84dB(A) CH 1183014 - 4X2 6X2 6X2/4 6X4 8X4 GR900/GRS900 84dB CH 1183014 - CP13/CP19 4X4 6X6 84dB(A) CH 1209040 - CH 1209041 - CH 4344437 - CH 4344438 - 4X2 6X2 6X4 8X2 8X4 GRH900/GRS900 84dB(A) - ad36/38 MA4X2 84dB(A) CH 1193611 - CH 1199484 - CH 4334055 - CH 9002352 - P/R 93 4X2 6X2 6X4 8X2 8X4 MA6X2A 84dB(A) - ad36/38 MA/MW/HA GR/GRS900 - GR/GRS900R 84dB(A) - P/R 93 GR801 84dB - CH 1192433 - CH 9000673 - ad36/38 MA4X2/MW4X2 84dB CH 1193611 - CH 1199484 - CH 4334055 - CH 9002352 - ad36/38 MA4X2/MW4X2 DTC11 84dB - ad36/38 MA/MW/HA GR/GRS900R 84dB CH 1193612 - P/R 113 MW 4X2 A/B - R143 MW 4X2 A/B ad36/38 MEGA - TRAILER		
● 4 TRUCK				
★	CP/CR 14 - CP/CR 19 8X2/8X4/8X8			



		60347	357402	
EXHAUST PIPE	● 3 BUS			
	★	CH 1823425 - CH 1823072 - CH 1823419 - CH 1827458 - CH 1823426 - CH 1823420 - DS/DSC		
	● 3 TRUCK			
	★	DN9 01 CH 1166898 - ad31 - 34 38 - 62 MA ad36 GA770/GAE770 CH 1166898 - ad31 - 34 G770/GS771/772 - GR871/GRE871T CH 1166898 - ad31 - 34 6X4 CH 1167917 - GR880 - GRH880 CH 1166898 - CR19 84dB(A) CH 1166898 - ad38 - 62 MA ad36 GS771/772 - GR/GRE871T CH 1166898 - CG13 GA/GAE770 GS771/772 GR/GRE871T CH 1166898 - ad36 - 62 GS771/772 GR871 GRE871T CH 1166898 - ad28 6X2/4 LHD/RHD CH 1166898 - ad38 - 62 GRH880 CH 1166898 - ad38 - 62 8X2 8X4 GR871 GRH880 - ad46 - 62 8X2 8X4 - ad34 GRH880 CH 1166898 - ad42 8X4 GR871 GRE871T - G93 ad38 42 - 62 GA - GAE774 CH 1166898 - P93 ad31/34/36/38 42 - 62 GA/GAE774 CH 1166898 - ad28 6X2/4 ad31 - 62 6X2 MA ad36 CH 1157366 - CH 4287118		



	Code	OEM new	OEM old
EXHAUST PIPE	63094	1397273	
	<ul style="list-style-type: none"> ● Model ★ Application 		
	<ul style="list-style-type: none"> ● 4 TRUCK ★ 94 - 114 - 124 - 144 UP TO CH 1235758 - CH 4385404 - CH 9028647 		
EXHAUST PIPE	64665	1483281	1445925
	<ul style="list-style-type: none"> ● 4 TRUCK ★ R164 ● P-G-R-T TRUCK ★ D16 CH 2010136 CH 5128409 CH 9102002 		
EXHAUST PIPE	64742	1505748	1497653
	<ul style="list-style-type: none"> ● 4 TRUCK ★ D9/D11/D12 - DT12 CH 1290794 - CH 4497414 - CH 9081938 - CH 3543198 - CH 1277993 - 1290793 - CH 4466325 - 4497413 - CH 9067728 - 9081937 - CH 3532779 - 3543197 ● P-G-R-T TRUCK ★ DT12 		
EXHAUST PIPE	65098	1510575	
	<ul style="list-style-type: none"> ● 4 TRUCK ★ DC9 19/20/21 ● P-G-R-T TRUCK ★ CH 2010137 - 2014271 - CH 5128410 - 5139835 - CH 9102003 - 9106792 		

ALL THE COMPONENTS LISTED IN OUR CATALOGUE ARE NOT ORIGINAL, THOUGH PERFECTLY INTERCHANGEABLE. REFERENCE NUMBERS, EITHER ORIGINAL OR OF A DIFFERENT NATURE, ARE FOR INFORMATION PURPOSES ONLY. WHEN PLACING AN ORDER, PLEASE, ALWAYS USE COSIBO REFERENCE NUMBERS AND DO NOT MENTION THE ORIGINAL REFERENCE NUMBERS OF THE TRUCK MANUFACTURERS IN THE INVOICE TO VEHICLE OWNERS OR TO ANYBODY ELSE. THE CUSTOMER TAKES HIS OWN RESPONSIBILITY IF HE DOES NOT COMPLY WITH WHAT ABOVE.

	Code	OEM new	OEM old
EXHAUST PIPE	64763	1488557	
<ul style="list-style-type: none"> ● Model ★ Application 			
<ul style="list-style-type: none"> ● 4 TRUCK 			
<ul style="list-style-type: none"> ★ DC16 CH 1289938 - 2002333 CH 4495080 - 5106746 CH 9080903 - 9092530 CH 3543034 			
<ul style="list-style-type: none"> ● P-G-R-T TRUCK 			
<ul style="list-style-type: none"> ★ D16 CH 2002333 CH 5106746 CH 9092530 			



	64764	1483278	1397052
EXHAUST PIPE			
<ul style="list-style-type: none"> ● 4 TRUCK 			
<ul style="list-style-type: none"> ★ 94 - 114 - 124 - 144 			
<ul style="list-style-type: none"> ● P-G-R-T TRUCK 			
<ul style="list-style-type: none"> ★ D11/D12 CH 2010136 CH 5128409 CH 9102002 - D16 CH 2010136 CH 5128409 CH 9102002 			



	65016	1483280	1405350
EXHAUST PIPE			
<ul style="list-style-type: none"> ● 4 TRUCK 			
<ul style="list-style-type: none"> ★ 94 - 114 - 124 - 144 FROM CH 1235759 - CH 4385405 - CH 9028648 - WITH ADR CH 1248285 - CH 4408570 - CH 9040439 			
<ul style="list-style-type: none"> ● P-G-R-T TRUCK 			
<ul style="list-style-type: none"> ★ D11/D12 80/82 dBA CH 2010136 - CH 5128409 - CH 9102002 - D16 80/82 dBA CH 2010136 - CH 5128409 - CH 9102002 			



ALL THE COMPONENTS LISTED IN OUR CATALOGUE ARE NOT ORIGINAL, THOUGH PERFECTLY INTERCHANGEABLE. REFERENCE NUMBERS, EITHER ORIGINAL OR OF A DIFFERENT NATURE, ARE FOR INFORMATION PURPOSES ONLY. WHEN PLACING AN ORDER, PLEASE, ALWAYS USE COSIBO REFERENCE NUMBERS AND DO NOT MENTION THE ORIGINAL REFERENCE NUMBERS OF THE TRUCK MANUFACTURERS IN THE INVOICE TO VEHICLE OWNERS OR TO ANYBODY ELSE. THE CUSTOMER TAKES HIS OWN RESPONSIBILITY IF HE DOES NOT COMPLY WITH WHAT ABOVE.

	Code	OEM new	OEM old
EXHAUST PIPE	65361	1505749	
<ul style="list-style-type: none"> ● Model ★ Application 			
<ul style="list-style-type: none"> ● 4 TRUCK 			
<ul style="list-style-type: none"> ★ D9/D11/D12 CH 1290794 - CH 4497414 - CH 9081938 - CH/TL 3543198 - CH 1290104 - 1290793 - CH 4495472 - 4497413 - CH 9081076 - 9081937 - CH 3541894 - 3543197 			
<ul style="list-style-type: none"> ● P-G-R-T TRUCK 			
<ul style="list-style-type: none"> ★ D9/D11/D12 			



	Code	OEM new	OEM old
EXHAUST HOSE	64827	1433667	
<ul style="list-style-type: none"> ● 4 TRUCK 			
<ul style="list-style-type: none"> ★ D16 			



	Code	OEM new	OEM old
EXHAUST BELLOW	60432	1428892	1364355
<ul style="list-style-type: none"> ● 4 BUS 			
<ul style="list-style-type: none"> ★ OSC9 G01 - L/N/K 94 - K94 REAR/POT 4X2 6X2 - F94 LHD/RHD 			
<ul style="list-style-type: none"> ● IND. MARINE ENGINE 4 			
<ul style="list-style-type: none"> ★ DSI/DI12A - DC9 51/53/54/55A 			
<ul style="list-style-type: none"> ● IND. MARINE ENGINE 5 			
<ul style="list-style-type: none"> ★ DC9A EMS 			
<ul style="list-style-type: none"> ● 4 TRUCK 			
<ul style="list-style-type: none"> ★ 94 - 114 - 124 - 144 - D12 CP/CR14 CP/CR19 8X2 8X4 8X8 - DSC11 74/75/79 - DC11 01/02/03/04/06 - OSC11 G03 			



EXHAUST SET



	Code	OEM new	OEM old
● Model	62499	62499	
★ Application			
● 4 BUS			
★ OSC9 G01 - L/N/K 94 - K94 REAR/POT 4X2 6X2 - F94 LHD/RHD			
● 4 TRUCK			
★ 94-114-124-144 - D12 CP/CR14 CP/CR19 8X2 8X4 8X8 - DSC11 74/75/79 - DC11 01/02/03/04/06 - OSC11 G03			
● IND.MARINE ENGINE 4			
★ DSI/DI12A - DC9 51/53/54/55A			
● IND.MARINE ENGINE 5			
★ DC9A EMS			

EXHAUST BELLOW



	60556	1387983	
● 4 TRUCK			
★ 164 - D16			

EXHAUST BELLOW



	65341		
● 4 TRUCK			
★ D9 - D11 - DC12			
● P-G-R-T TRUCK			
★ D9 - D11 - DC12			

ALL THE COMPONENTS LISTED IN OUR CATALOGUE ARE NOT ORIGINAL, THOUGH PERFECTLY INTERCHANGEABLE. REFERENCE NUMBERS, EITHER ORIGINAL OR OF A DIFFERENT NATURE, ARE FOR INFORMATION PURPOSES ONLY. WHEN PLACING AN ORDER, PLEASE, ALWAYS USE COSIBO REFERENCE NUMBERS AND DO NOT MENTION THE ORIGINAL REFERENCE NUMBERS OF THE TRUCK MANUFACTURERS IN THE INVOICE TO VEHICLE OWNERS OR TO ANYBODY ELSE. THE CUSTOMER TAKES HIS OWN RESPONSIBILITY IF HE DOES NOT COMPLY WITH WHAT ABOVE.

SLIDING JOINT



	Code	OEM new	OEM old
● Model	63778	1364290	
★ Application			
● 4 BUS			
★ OSC9 G01 - L/N/K 94 - K94 REAR 4X2/6X2 - F94 LHD/RHD			
● IND. MARINE ENGINE 4			
★ DSI/DI 12 A - DC9 51/53/54/55 A			
● IND. MARINE ENGINE 5			
★ DC9A EMS			
● 4 TRUCK			
★ D12 - CP14 - CR14 - CP19 - CR19 8X2/8X4/8X8 - D12 - DSC11 74/75/79 - DC11 01/02/03/04/06 - OSC11 G03			

EXHAUST SET



	60439	60439	
● 4 BUS			
★ OSC9 G01 - L/N/K 94 - K94 REAR 4X2/6X2 - F94 LHD/RHD COMPOSED BY 1PC 60432 - 1 PC 63323 - 1PC 63778			
● 4 TRUCK			
★ D12-CP14-CR14-CP19-CR19 8X2/8X4/8X8 - D12 - DSC11 74/75/79 - DC11 01/02/03/04/06 - OSC11 COMPOSED BY 1PC 60432 - 1 PC 63323 - 1PC 63778G03			
● IND.MARINE ENGINE 4			
★ DSI/DI 12 A - DC9 51/53/54/55 A COMPOSED BY 1PC 60432 - 1 PC 63323 - 1PC 63778			
● IND.MARINE ENGINE 5			
★ DC9A EMS COMPOSED BY 1PC 60432 - 1 PC 63323 - 1PC 63778			
● 4 BUS			
★ OSC9 G01 - L/N/K 94 - K94 REAR 4X2/6X2 - F94 LHD/RHD COMPOSED BY 1PC 60432 - 1 PC 63323 - 1PC 63778			
● IND.MARINE ENGINE 4			
★ DSI/DI 12 A - DC9 51/53/54/55 A COMPOSED BY 1PC 60432 - 1 PC 63323 - 1PC 63778			
● IND.MARINE ENGINE 5			
★ DC9A EMS COMPOSED BY 1PC 60432 - 1 PC 63323 - 1PC 63778			
● 4 TRUCK			
★ D12-CP14-CR14-CP19-CR19 8X2/8X4/8X8 - D12 - DSC11 74/75/79 - DC11 01/02/03/04/06 - OSC11 COMPOSED BY 1PC 60432 - 1 PC 63323 - 1PC 63778G03			

ALL THE COMPONENTS LISTED IN OUR CATALOGUE ARE NOT ORIGINAL, THOUGH PERFECTLY INTERCHANGEABLE. REFERENCE NUMBERS, EITHER ORIGINAL OR OF A DIFFERENT NATURE, ARE FOR INFORMATION PURPOSES ONLY. WHEN PLACING AN ORDER, PLEASE, ALWAYS USE COSIBO REFERENCE NUMBERS AND DO NOT MENTION THE ORIGINAL REFERENCE NUMBERS OF THE TRUCK MANUFACTURERS IN THE INVOICE TO VEHICLE OWNERS OR TO ANYBODY ELSE. THE CUSTOMER TAKES HIS OWN RESPONSIBILITY IF HE DOES NOT COMPLY WITH WHAT ABOVE.

		Code	OEM new	OEM old
CLAMP	● Model	63097	1300367	
	★ Application			
	● 3 BUS			
	★	DSC11 22/23/70 CH 1825186		
	● IND. MARINE ENGINE 4			
	★			
	● IND. MARINE ENGINE 5			
	★			
	● 3 TRUCK			
	★	4X4 6X6 ad38 - 46 84dB(A) - 4X4 6X6 GT800 84dB(A) - DS9/DSC9 6X4 84dB(A) - HK 6X4 - EK 6X4 84dB(A) - 8X2 8X4 GR900/GR900R/GRS900/GRS900R 84dB(A) - DS9/DSC9 6X4 GR900/GRS900 84dB(A) - DN9 84dB(A) - 4X2 6X2 6X4 6X2/4 GR880/GR880T 84dB(A) - P/R93 4X2 6X2 6X2/4 6X4 GA - GAE770/GR - GRE871T/GR801/GR900 84dB(A) - 4X4 8X4 84dB(A) - 4X2 6X2 6X2/4 6X4 G770/GS771 - 772 GR/GRE871 GR/GRS900R 84dB - HK 4X4 6X6 84dB(A) - 4X2 6X2 6X4 GRH880/GRH900 84dB(A) - 4X2 6X2 6X4 GRH880 84dB - 4X2 6X2 6X2/4 6X4 8X2 8X4 GR900/GRS900 84dB - 4X2 6X2 6X4 8X2 8X4 MA6X2A 84dB - P93H GR900/GRS900 84dB(A) - DSC9 07/08 84dB(A) - CP13/19 4X4 6X6 84dB(A) - 8X2 8X4 GRH880 GRS900 84dB(A) - G93 4X2 G770 - GA/GAE770 - GA/GAE774 - GR/GRE871T - GR801/GR900 - 4X2 6X2 6X4 8X2 8X4 GRH900/GRS900 84dB(A) - 4X2 6X2 G770 - GS771/772 - GR/GRE871T GR/GRS900R 84dB - P/R93 8X2 8X4 GR801 84dB(A) - ad36/38 MA4X2 84dB(A) - P/R93 4X2 6X2 6X4 8X2 8X4 MA6X2A 84dB(A) - P/R93 ad38 ad42 - 62 84dB(A) - 8X2 8X4 GRH880 GR900/GRS900 84dB - ad36 - 38 MA/MW/HA GR/GRS900 GR/GRS900R 84dB(A) - P93 ML4X2/ML6X2/ML6X4/HL4X2/HL6X2 GA776 84dB(A) - P93 ML/MV/HL 4X2 6X2 GA750 84dB(A) - DTC11 GRS900 - P/R93 GR801 84dB - ad36 - 38 MA4X2/MW4X2 DTC11 84dB - ad36 - 38 MA/MW/HA GR/GRS900R 84dB - DSC11 22/23/70 - P93 4X2 6X2 GA850 ad38 - ad42/62 - P113 ML/HL 4X2 6X2 GA850/GA850R ad38 ad42/62 - R143 4X2 A/B LHD ad36/38 MEGA - TRAILER - P113 MW 4X2 A/B - R113 MW 4X2 A/B ad36/38 MEGA - TRAILER - ad34/38/42/62 84dB(A) - T113 MA/HA 4X2A - T143 MA/HA 4X2A ad38/42/46 84dB(A) - ad31/36 6X4 84dB(A) - CP/CR 8X2 8X4 84dB(A) - ad31/34/38MA 84dB(A) - 6X2/4 LHD - MA6X2A LHD 84dB(A) - 6X2/4 RHD - MA6X2A ad29 84dB(A) - CP/CR ML4X2 - ML6X2 84dB(A) - CP/CR MA4X2 Z ad36 84dB(A) - CP/CR MA4X2 Z HA4X2 Z ad36/38 84dB(A) - CP/CR MA4X2 MW4X2 ad36/38 84dB(A) - CP/CR GR/GRS900R ad36/ad36Z ad38 MA/MW/HA 84dB(A)		
	● 4 TRUCK			
	★	D12 CP/CR14 CP/CR19 8X2 8X4 8X8		



ALL THE COMPONENTS LISTED IN OUR CATALOGUE ARE NOT ORIGINAL, THOUGH PERFECTLY INTERCHANGEABLE. REFERENCE NUMBERS, EITHER ORIGINAL OR OF A DIFFERENT NATURE, ARE FOR INFORMATION PURPOSES ONLY. WHEN PLACING AN ORDER, PLEASE, ALWAYS USE COSIBO REFERENCE NUMBERS AND DO NOT MENTION THE ORIGINAL REFERENCE NUMBERS OF THE TRUCK MANUFACTURERS IN THE INVOICE TO VEHICLE OWNERS OR TO ANYBODY ELSE. THE CUSTOMER TAKES HIS OWN RESPONSIBILITY IF HE DOES NOT COMPLY WITH WHAT ABOVE.

		Code	OEM new	OEM old
CLAMP	● Model ★ Application	63323	1422474	1387136
	● 3 BUS			
	★			
	● 4 BUS			
	★ F94 LHD/RHD - L94 - N94 - K94 - K94 REAR/POST 4X2 6X2 - OSC9 G01 - OSC09 G01			
	● F-K-N BUS			
	★ DT12 - K DC9 11/12/13/16/17/18/29/30 - DC11 08 - DC12 06/10/13/17 - DT12 03/12/17 - N - F - K UD - K D9			
	● IND. MARINE ENGINE 4			
	★ DC12 54A - D16A - D16M - DI12 42/43/44/45/57/60/66/68/69M - DC9 51/53/54/55A OK			
	● IND. MARINE ENGINE 5			
	★ DC9A EMS			
● 4 TRUCK				
★ 94 - 114 - 124 - 144 - 164 - DT12 - D9/D11/D12 - D9/D11/D12 CP/CR14 PDE - DC16 - D12 CP/CR14 CP/CR19 8X2 8X4 8X8 - DSC11 74/75/79 - DC11 01/02/03/04/06 - OSC11 G03 - DC9 19/20/21 - CT14/19 - CR19/CT19/CT14 GRSH900R - CT14/CT19 DC16 - DC11/DC12 PDE/HPI - HAI - D9/D11/DC12 AWD - D9/D11/D12 CP/CR14 AWD				
● P-G-R-T TRUCK				
★ D9/D11/DC12 AWD - D9/D11/D12 CP/CR14 AWD - DT12 - D13 - DC12 14 - D16 - D11/D12/D16 80/82 dBA - CP/CR/CT19 - CG/CP/CT14 - CP/CR16				



CLAMP		64770	1431579	
	● 4 TRUCK			
	★ 164 - DC16 - D16			
	● P-G-R-T TRUCK			
	★ D13 - D16 - CG/CP/CR16 EURO 4/EURO 5 - CG/CP14 EURO 4/EURO 5 - CG/CP/CR19 EURO 4/EURO 5			
● F-K-N BUS				
★ K DC9 16/17/18/29/30 - DC12 10/13 - DT12 03/12/17				



	Code	OEM new	OEM old
FLEXIBLE SLEEVE	62213	395339	
			
<ul style="list-style-type: none"> ● Model ★ Application 			
<ul style="list-style-type: none"> ● 3 TRUCK ★ 			
CLAMP	64771	1782741	1420480
			
<ul style="list-style-type: none"> ● 4 TRUCK ★ CP/CR14 - CP/CR/CT19 - CP19F FRONTLINE - CT14/CT19 DC16 			
<ul style="list-style-type: none"> ● P-G-R-T TRUCK ★ CP/CR/CT19 - CG/CP/CT14 - CP/CR16 			
CLAMP	63107	1315559	
			
<ul style="list-style-type: none"> ● 3 TRUCK ★ DTC11 			
<ul style="list-style-type: none"> ● IND. MARINE ENGINE 4 ★ 			
<ul style="list-style-type: none"> ● IND. MARINE ENGINE 5 ★ 			

ALL THE COMPONENTS LISTED IN OUR CATALOGUE ARE NOT ORIGINAL, THOUGH PERFECTLY INTERCHANGEABLE. REFERENCE NUMBERS, EITHER ORIGINAL OR OF A DIFFERENT NATURE, ARE FOR INFORMATION PURPOSES ONLY. WHEN PLACING AN ORDER, PLEASE, ALWAYS USE COSIBO REFERENCE NUMBERS AND DO NOT MENTION THE ORIGINAL REFERENCE NUMBERS OF THE TRUCK MANUFACTURERS IN THE INVOICE TO VEHICLE OWNERS OR TO ANYBODY ELSE. THE CUSTOMER TAKES HIS OWN RESPONSIBILITY IF HE DOES NOT COMPLY WITH WHAT ABOVE.

	Code	OEM new	OEM old
RUBBER MOUNTING	60398	40607	
● Model			
★ Application			
● 3 BUS			
★			
● 4 BUS			
★ F94 LH/RHD			
● F-K-N BUS			
★ F			
● IND. MARINE ENGINE 5			
★ SG9 A280			
● 3 TRUCK			
★			



	64006	1545149	1421621
PROTECTION COVER			
● 4 TRUCK			
★ D9/11/12 CH 1290985 - CH 4499486 - CH 9082897 - CH 3542832 - DC9 04/05/06 - DSC9 11/12/13 CH 1240717 - CH 4393474 - CH 9033049 - CH 3504513 - OSC11 G03 - D16 CH 2002333CH 2002334 - CH 5106746 - CH 5106747 - CH 9092530 - CH 9092531 - CH 3560649 - CH 3560650 - AND ALSO CH 1240717 - 1290984 - CH 4393474 - 4499485 - CH 9033049 - 9082896 - CH 3504513 - 3542831			
● P-G-R-T TRUCK			
★ D9 - D11 - D12 - D13 CH 2028960 - CH 5181645 - CH 9123036 - CH 3611301 - D16 - D9 - D11 - D12 CH 2028959 - CH 5181644 - CH 9123035 - CH 3611300			

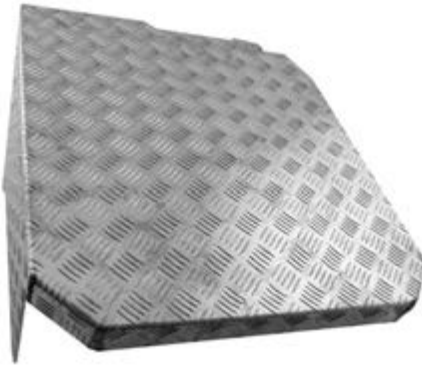

ALL THE COMPONENTS LISTED IN OUR CATALOGUE ARE NOT ORIGINAL, THOUGH PERFECTLY INTERCHANGEABLE. REFERENCE NUMBERS, EITHER ORIGINAL OR OF A DIFFERENT NATURE, ARE FOR INFORMATION PURPOSES ONLY. WHEN PLACING AN ORDER, PLEASE, ALWAYS USE COSIBO REFERENCE NUMBERS AND DO NOT MENTION THE ORIGINAL REFERENCE NUMBERS OF THE TRUCK MANUFACTURERS IN THE INVOICE TO VEHICLE OWNERS OR TO ANYBODY ELSE. THE CUSTOMER TAKES HIS OWN RESPONSIBILITY IF HE DOES NOT COMPLY WITH WHAT ABOVE.

PROTECTION COVER

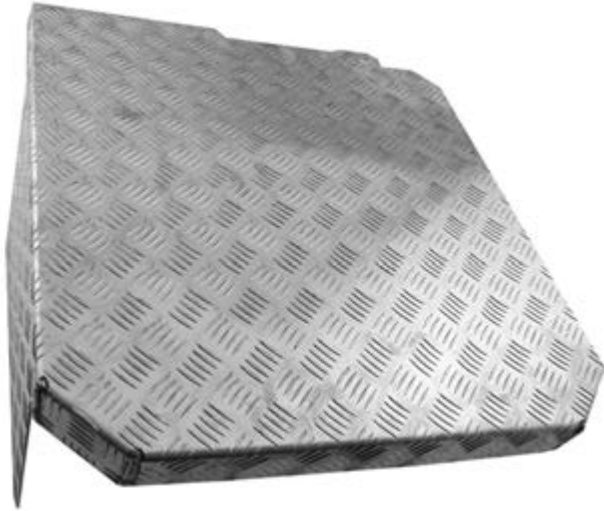

- Model
- ★ Application

Code

OEM new

OEM old

64007

1722828

- 4 TRUCK

- ★ D9/ 11/ 12 CH 1290985 - CH 4499486 - CH 9082897 - CH 3542832 - CR GRSH900/ GRSH900R CH 1240717 - CH 4393474 - CH 9033049 - D16 CH 2002334 - CH 5106747 - CH 9092531 - CH 3560650

ALL THE COMPONENTS LISTED IN OUR CATALOGUE ARE NOT ORIGINAL, THOUGH PERFECTLY INTERCHANGEABLE. REFERENCE NUMBERS, EITHER ORIGINAL OR OF A DIFFERENT NATURE, ARE FOR INFORMATION PURPOSES ONLY. WHEN PLACING AN ORDER, PLEASE, ALWAYS USE COSIBO REFERENCE NUMBERS AND DO NOT MENTION THE ORIGINAL REFERENCE NUMBERS OF THE TRUCK MANUFACTURERS IN THE INVOICE TO VEHICLE OWNERS OR TO ANYBODY ELSE. THE CUSTOMER TAKES HIS OWN RESPONSIBILITY IF HE DOES NOT COMPLY WITH WHAT ABOVE.

FEEDER



	Code	OEM new	OEM old
● Model ★ Application	65441	2001791	1753208
● F-K-N BUS			
★			
● P-G-R-T TRUCK			
★			

JET



	Code	OEM new	OEM old
	65444	1918538	1749823 1884205
● F-K-N BUS			
★			
● P-G-R-T TRUCK			
★			

BREATHER VALVE



	Code	OEM new	OEM old
	65498	1917858	
● F-K-N BUS			
★			
● P-G-R-T TRUCK			
★			

ALL THE COMPONENTS LISTED IN OUR CATALOGUE ARE NOT ORIGINAL, THOUGH PERFECTLY INTERCHANGEABLE. REFERENCE NUMBERS, EITHER ORIGINAL OR OF A DIFFERENT NATURE, ARE FOR INFORMATION PURPOSES ONLY. WHEN PLACING AN ORDER, PLEASE, ALWAYS USE COSIBO REFERENCE NUMBERS AND DO NOT MENTION THE ORIGINAL REFERENCE NUMBERS OF THE TRUCK MANUFACTURERS IN THE INVOICE TO VEHICLE OWNERS OR TO ANYBODY ELSE. THE CUSTOMER TAKES HIS OWN RESPONSIBILITY IF HE DOES NOT COMPLY WITH WHAT ABOVE.

FEEDER FILTER



- Model
- ★ Application

Code	OEM new	OEM old
65499	1907422	1795459 1852188 1488093

- P-G-R-T TRUCK

★

- F-K-N BUS

★

- P-G-R-T TRUCK

★

ALL THE COMPONENTS LISTED IN OUR CATALOGUE ARE NOT ORIGINAL, THOUGH PERFECTLY INTERCHANGEABLE. REFERENCE NUMBERS, EITHER ORIGINAL OR OF A DIFFERENT NATURE, ARE FOR INFORMATION PURPOSES ONLY. WHEN PLACING AN ORDER, PLEASE, ALWAYS USE COSIBO REFERENCE NUMBERS AND DO NOT MENTION THE ORIGINAL REFERENCE NUMBERS OF THE TRUCK MANUFACTURERS IN THE INVOICE TO VEHICLE OWNERS OR TO ANYBODY ELSE. THE CUSTOMER TAKES HIS OWN RESPONSIBILITY IF HE DOES NOT COMPLY WITH WHAT ABOVE.

	Code	OEM new	OEM old
CLAMP D.6	64082	813933	
● Model			
★ Application			
● 3 BUS			
★			
● 4 BUS			
★			
● F-K-N BUS			
★			
● IND. MARINE ENGINE 4			
★			
● 3 TRUCK			
★			
● 4 TRUCK			
★			
● P-G-R-T TRUCK			
★			



CLAMP D.10	64083	813935	
● 3 BUS			
★			
● F-K-N BUS			
★			
● IND. MARINE ENGINE 4			
★			
● 3 TRUCK			
★			
● P-G-R-T TRUCK			
★			



ALL THE COMPONENTS LISTED IN OUR CATALOGUE ARE NOT ORIGINAL, THOUGH PERFECTLY INTERCHANGEABLE. REFERENCE NUMBERS, EITHER ORIGINAL OR OF A DIFFERENT NATURE, ARE FOR INFORMATION PURPOSES ONLY. WHEN PLACING AN ORDER, PLEASE, ALWAYS USE COSIBO REFERENCE NUMBERS AND DO NOT MENTION THE ORIGINAL REFERENCE NUMBERS OF THE TRUCK MANUFACTURERS IN THE INVOICE TO VEHICLE OWNERS OR TO ANYBODY ELSE. THE CUSTOMER TAKES HIS OWN RESPONSIBILITY IF HE DOES NOT COMPLY WITH WHAT ABOVE.

	Code	OEM new	OEM old
CLAMP D. 16	64084	813937	
● Model			
★ Application			
● 3 BUS			
★			
● 4 BUS			
★			
● F-K-N BUS			
★			
● IND. MARINE ENGINE 4			
★			
● IND. MARINE ENGINE 5			
★			
● 3 TRUCK			
★			
● 4 TRUCK			
★			
● P-G-R-T TRUCK			
★			



	64085	813939	
CLAMP D.20			
● 3 BUS			
★			
● 4 BUS			
★			
● F-K-N BUS			
★			
● IND. MARINE ENGINE 4			
★			
● IND. MARINE ENGINE 5			
★			
● 3 TRUCK			
★			
● 4 TRUCK			
★			



ALL THE COMPONENTS LISTED IN OUR CATALOGUE ARE NOT ORIGINAL, THOUGH PERFECTLY INTERCHANGEABLE. REFERENCE NUMBERS, EITHER ORIGINAL OR OF A DIFFERENT NATURE, ARE FOR INFORMATION PURPOSES ONLY. WHEN PLACING AN ORDER, PLEASE, ALWAYS USE COSIBO REFERENCE NUMBERS AND DO NOT MENTION THE ORIGINAL REFERENCE NUMBERS OF THE TRUCK MANUFACTURERS IN THE INVOICE TO VEHICLE OWNERS OR TO ANYBODY ELSE. THE CUSTOMER TAKES HIS OWN RESPONSIBILITY IF HE DOES NOT COMPLY WITH WHAT ABOVE.

		Code	OEM new	OEM old
CLAMP D.25	● Model	64086	813941	
	★ Application			
	● 3 BUS			
	★			
	● 4 BUS			
	★			
	● F-K-N BUS			
	★			
	● IND. MARINE ENGINE 4			
	★			
● IND. MARINE ENGINE 5				
★				



CLAMP D.5		64089	813932	
	● 3 BUS			
	★			
	● IND. MARINE ENGINE 4			
	★			
	● 3 TRUCK			
	★			
	● 4 TRUCK			
	★			



ALL THE COMPONENTS LISTED IN OUR CATALOGUE ARE NOT ORIGINAL, THOUGH PERFECTLY INTERCHANGEABLE. REFERENCE NUMBERS, EITHER ORIGINAL OR OF A DIFFERENT NATURE, ARE FOR INFORMATION PURPOSES ONLY. WHEN PLACING AN ORDER, PLEASE, ALWAYS USE COSIBO REFERENCE NUMBERS AND DO NOT MENTION THE ORIGINAL REFERENCE NUMBERS OF THE TRUCK MANUFACTURERS IN THE INVOICE TO VEHICLE OWNERS OR TO ANYBODY ELSE. THE CUSTOMER TAKES HIS OWN RESPONSIBILITY IF HE DOES NOT COMPLY WITH WHAT ABOVE.

	Code	OEM new	OEM old
CLAMP D.8	64090	813934	
● Model			
★ Application			
● 3 BUS			
★			
● 4 BUS			
★			
● F-K-N BUS			
★			
● IND. MARINE ENGINE 4			
★			
● 3 TRUCK			
★			
● 4 TRUCK			
★			
● P-G-R-T TRUCK			
★			



	Code	OEM new	OEM old
CLAMP D.13	64091	813936	
● 3 BUS			
★			
● 4 BUS			
★			
● F-K-N BUS			
★			
● IND. MARINE ENGINE 4			
★			
● IND. MARINE ENGINE 5			
★			
● 3 TRUCK			
★			
● 4 TRUCK			
★			
● P-G-R-T TRUCK			
★			



ALL THE COMPONENTS LISTED IN OUR CATALOGUE ARE NOT ORIGINAL, THOUGH PERFECTLY INTERCHANGEABLE. REFERENCE NUMBERS, EITHER ORIGINAL OR OF A DIFFERENT NATURE, ARE FOR INFORMATION PURPOSES ONLY. WHEN PLACING AN ORDER, PLEASE, ALWAYS USE COSIBO REFERENCE NUMBERS AND DO NOT MENTION THE ORIGINAL REFERENCE NUMBERS OF THE TRUCK MANUFACTURERS IN THE INVOICE TO VEHICLE OWNERS OR TO ANYBODY ELSE. THE CUSTOMER TAKES HIS OWN RESPONSIBILITY IF HE DOES NOT COMPLY WITH WHAT ABOVE.

	Code	OEM new	OEM old
CLAMP D.18	64092	813938	
● Model			
★ Application			
● 3 BUS			
★			
● F-K-N BUS			
★			
● IND. MARINE ENGINE 4			
★			
● 3 TRUCK			
★			
● 4 TRUCK			
★			





CLAMP D.22	64093	813940	
● 3 BUS			
★			
● IND. MARINE ENGINE 4			
★			
● 3 TRUCK			
★			



CLAMP D. 45	64094	813942	
● 3 BUS			
★			
● 4 BUS			
★			
● F-K-N BUS			
★			
● IND. MARINE ENGINE 5			
★			
● 3 TRUCK			
★			



ALL THE COMPONENTS LISTED IN OUR CATALOGUE ARE NOT ORIGINAL, THOUGH PERFECTLY INTERCHANGEABLE. REFERENCE NUMBERS, EITHER ORIGINAL OR OF A DIFFERENT NATURE, ARE FOR INFORMATION PURPOSES ONLY. WHEN PLACING AN ORDER, PLEASE, ALWAYS USE COSIBO REFERENCE NUMBERS AND DO NOT MENTION THE ORIGINAL REFERENCE NUMBERS OF THE TRUCK MANUFACTURERS IN THE INVOICE TO VEHICLE OWNERS OR TO ANYBODY ELSE. THE CUSTOMER TAKES HIS OWN RESPONSIBILITY IF HE DOES NOT COMPLY WITH WHAT ABOVE.

	Code	OEM new	OEM old
CLAMP D.28 	64095	804578	
<ul style="list-style-type: none"> ● Model ★ Application 			
<ul style="list-style-type: none"> ● 3 BUS ★ 			
<ul style="list-style-type: none"> ● 4 BUS ★ 			
CLAMP D.35 	64096	804589	
<ul style="list-style-type: none"> ● 3 BUS ★ 			
<ul style="list-style-type: none"> ● IND. MARINE ENGINE 4 ★ 			
<ul style="list-style-type: none"> ● 3 TRUCK ★ 			
<ul style="list-style-type: none"> ● 4 TRUCK ★ 			
CLAMP D.32 	64100	804583	
<ul style="list-style-type: none"> ● 3 BUS ★ 			
<ul style="list-style-type: none"> ● 4 BUS ★ 			
<ul style="list-style-type: none"> ● F-K-N BUS ★ 			
<ul style="list-style-type: none"> ● IND. MARINE ENGINE 4 ★ 			
<ul style="list-style-type: none"> ● 3 TRUCK ★ 			
<ul style="list-style-type: none"> ● 4 TRUCK ★ 			
<ul style="list-style-type: none"> ● P-G-R-T TRUCK ★ 			

ALL THE COMPONENTS LISTED IN OUR CATALOGUE ARE NOT ORIGINAL, THOUGH PERFECTLY INTERCHANGEABLE. REFERENCE NUMBERS, EITHER ORIGINAL OR OF A DIFFERENT NATURE, ARE FOR INFORMATION PURPOSES ONLY. WHEN PLACING AN ORDER, PLEASE, ALWAYS USE COSIBO REFERENCE NUMBERS AND DO NOT MENTION THE ORIGINAL REFERENCE NUMBERS OF THE TRUCK MANUFACTURERS IN THE INVOICE TO VEHICLE OWNERS OR TO ANYBODY ELSE. THE CUSTOMER TAKES HIS OWN RESPONSIBILITY IF HE DOES NOT COMPLY WITH WHAT ABOVE.

	Code	OEM new	OEM old
CLAMP D.38	64101	804591	
● Model			
★ Application			
● 3 BUS			
★			
● 4 BUS			
★			
● F-K-N BUS			
★			
● IND. MARINE ENGINE 4			
★			
● 3 TRUCK			
★			
● 4 TRUCK			
★			



ALL THE COMPONENTS LISTED IN OUR CATALOGUE ARE NOT ORIGINAL, THOUGH PERFECTLY INTERCHANGEABLE. REFERENCE NUMBERS, EITHER ORIGINAL OR OF A DIFFERENT NATURE, ARE FOR INFORMATION PURPOSES ONLY. WHEN PLACING AN ORDER, PLEASE, ALWAYS USE COSIBO REFERENCE NUMBERS AND DO NOT MENTION THE ORIGINAL REFERENCE NUMBERS OF THE TRUCK MANUFACTURERS IN THE INVOICE TO VEHICLE OWNERS OR TO ANYBODY ELSE. THE CUSTOMER TAKES HIS OWN RESPONSIBILITY IF HE DOES NOT COMPLY WITH WHAT ABOVE.

HYDRAULIC RELEASE BEARING



● Model

★ Application

Code

OEM new

OEM old

60155

1522377

1393332
1434649
1455730

● **4 BUS**

★ K432 15/ 16/ 17 CH 1835919 - CH 3511088 - CH 1843282 - K432 18 CH 3511088 - CH 3511089 - K432 16 CH 1835920 - CH 3511089 - CH 1843283 - K432 15/ 17 CH 1835920 - CH 3511089 - CH 1843283

● **4 TRUCK**

★ K432 15/17 CH 1251352 - CH 4414948 - CH 9043609 - CH 3510913 - K402 5 - K432 16 - K442 3 CH 1251352 - CH 4414948 - CH 9043610 - K442 3 K432 15/17 LHD CH 1251353 - 1274125 - CH 4414949 - 4459238 - CH 9043610 - 9064687 - CH 3510914 - K432 19 LHD CH 1274125 - CH 4459238 - CH 9064687 - K432 15/17/19 RHD - K442 3 RHD CH 1265045 - CH 4440645 - CH 9056589 - K432 19 RHD CH 1265044 - CH 4440644 - CH 9056588 - K432 15/17 RHD - K442 3 RHD CH 1251353 - 1265044 - CH 4414949 - 4440644 - CH 9043610 - 9056588 - CH 3510914 - K432 15/17 LHD - K432 19 LHD - K442 3 LHD CH 1274126 - CH 4459239 - CH 9064688

CLUTCH SERVO



60807

360719

● **2 TRUCK**

★

CLUTCH SERVO



60808

1747895

1331770
371612

● **3 BUS**

★

● **3 TRUCK**

★ CG/CP/CR/CT 93/113 - CP/CR 113 GR/GRS/GRH900 - 93

ALL THE COMPONENTS LISTED IN OUR CATALOGUE ARE NOT ORIGINAL, THOUGH PERFECTLY INTERCHANGEABLE. REFERENCE NUMBERS, EITHER ORIGINAL OR OF A DIFFERENT NATURE, ARE FOR INFORMATION PURPOSES ONLY. WHEN PLACING AN ORDER, PLEASE, ALWAYS USE COSIBO REFERENCE NUMBERS AND DO NOT MENTION THE ORIGINAL REFERENCE NUMBERS OF THE TRUCK MANUFACTURERS IN THE INVOICE TO VEHICLE OWNERS OR TO ANYBODY ELSE. THE CUSTOMER TAKES HIS OWN RESPONSIBILITY IF HE DOES NOT COMPLY WITH WHAT ABOVE.

CLUTCH SERVO



	Code	OEM new	OEM old
● Model	62089	1747894	298953 338923 360717
★ Application			
● 2 TRUCK			
★			
● 3 TRUCK			
★			

CLUTCH SERVOMASTER



	Code	OEM new	OEM old
	62012	1513717	1367453 1421186 1454590 1469161
● 4 BUS			
★ K402 5 - K432 15/16/17/18/30/31/32/34 - F94			
● F-K-N BUS			
★			
● 4 TRUCK			
★ K432 30/31/32/33 - CH 1291370 - CH 4499183 - CH 9082800 - CH 3543610 - CP/CR/CT CH 1251352 - CH 4414948 - CH 9043609 - CH 3512914 - K432 15/16/17/19 - K442 3 CH 1251353 - 1291369 - CH 4414949 - 4499182 - CH 9043610 - 9082799 - CH 3512915 - 3543609 - K432 13 CH 1251353 - 1277406 - CH 1277407 - CH 4414949 - 4465078 - CH 4465079 - CH 9043610 - 9067200 - CH 9067201 - CH 3512915 - 3531785 - CH 3531786			
● P-G-R-T TRUCK			
★			

HOSE



	Code	OEM new	OEM old
	65399	1433203	
● 4 TRUCK			
★ K432 15/16/17/19/30/31/32/33 - K442 3			
● P-G-R-T TRUCK			
★			

ALL THE COMPONENTS LISTED IN OUR CATALOGUE ARE NOT ORIGINAL, THOUGH PERFECTLY INTERCHANGEABLE. REFERENCE NUMBERS, EITHER ORIGINAL OR OF A DIFFERENT NATURE, ARE FOR INFORMATION PURPOSES ONLY. WHEN PLACING AN ORDER, PLEASE, ALWAYS USE COSIBO REFERENCE NUMBERS AND DO NOT MENTION THE ORIGINAL REFERENCE NUMBERS OF THE TRUCK MANUFACTURERS IN THE INVOICE TO VEHICLE OWNERS OR TO ANYBODY ELSE. THE CUSTOMER TAKES HIS OWN RESPONSIBILITY IF HE DOES NOT COMPLY WITH WHAT ABOVE.

CLUTCH CYLINDER



	Code	OEM new	OEM old
● Model ★ Application	64353	1927829	1523400 1800442
● P-G-R-T TRUCK ★			
● F-K-N BUS ★			

FLEXIBLE HOSE



	Code	OEM new	OEM old
	64856	1860195	
● P-G-R-T TRUCK ★			

NIPPLE



	Code	OEM new	OEM old
	64855	1905884	1755194
● F-K-N BUS ★			
● P-G-R-T TRUCK ★			

SENSOR



	Code	OEM new	OEM old
	65174	1360842	
● 4 BUS ★			
● 4 TRUCK ★			

ALL THE COMPONENTS LISTED IN OUR CATALOGUE ARE NOT ORIGINAL, THOUGH PERFECTLY INTERCHANGEABLE. REFERENCE NUMBERS, EITHER ORIGINAL OR OF A DIFFERENT NATURE, ARE FOR INFORMATION PURPOSES ONLY. WHEN PLACING AN ORDER, PLEASE, ALWAYS USE COSIBO REFERENCE NUMBERS AND DO NOT MENTION THE ORIGINAL REFERENCE NUMBERS OF THE TRUCK MANUFACTURERS IN THE INVOICE TO VEHICLE OWNERS OR TO ANYBODY ELSE. THE CUSTOMER TAKES HIS OWN RESPONSIBILITY IF HE DOES NOT COMPLY WITH WHAT ABOVE.

TWO WAY CONTROL VALVE REPAIR SET



	Code	OEM new	OEM old
● Model ★ Application	60799	550446	
● 1 TRUCK			
★ 110 - 111 - 140 - 141			
● 2 TRUCK			
★ 112 - 142			

CLUTCH CYLINDER



	Code	OEM new	OEM old
	61961	1361136	1105332 1114685
● 3 BUS			
★ 93/113/143 - F93/113			
● 3 TRUCK			
★ 93/113/143 - F93/113 - GR801R - GRS890R - GR/GRS900R			

CLUTCH CYLINDER



	Code	OEM new	OEM old
	63885	1754943	1545626
● 4 BUS			
★ K432 30/31/32/33 CH 1847532 - CH 1847533 - CH 3548918 - CH 3548919 - K432 34			
● F-K-N BUS			
★ K432 37/38			
● 4 TRUCK			
★ K432 34 - K432 30/31/32/33 CH 1294477 - CH 1294478 - CH 4509371 - CH 4509372 - CH 9087193 - CH 9087194 - CH 3548918 - CH 3548919			
● P-G-R-T TRUCK			
★ K432 20/26/27/33/35/36/37/38/39/54/55			

ALL THE COMPONENTS LISTED IN OUR CATALOGUE ARE NOT ORIGINAL, THOUGH PERFECTLY INTERCHANGEABLE. REFERENCE NUMBERS, EITHER ORIGINAL OR OF A DIFFERENT NATURE, ARE FOR INFORMATION PURPOSES ONLY. WHEN PLACING AN ORDER, PLEASE, ALWAYS USE COSIBO REFERENCE NUMBERS AND DO NOT MENTION THE ORIGINAL REFERENCE NUMBERS OF THE TRUCK MANUFACTURERS IN THE INVOICE TO VEHICLE OWNERS OR TO ANYBODY ELSE. THE CUSTOMER TAKES HIS OWN RESPONSIBILITY IF HE DOES NOT COMPLY WITH WHAT ABOVE.

ALUMINIUM CLUTCH CYLINDER



	Code	OEM new	OEM old
● Model	64122	1756460	1355979
★ Application			1532517
● 4 BUS			
★	K432 8		
● 3 TRUCK			
★	K432 13 - EK330/340/630/640 CH 1217686 - CH 1294476 - CH 1294477 - CH 4357445 - 4509371 - CH 4509372 - CH 9087192 - CH 9087193 - CH 3548818 - CH 3548819 - K402 4 - EK330/340/630/640 CH 1217686 - CH 4357445		
● 4 TRUCK			
★	K432 13 - EK330/340/630/640 CH 1217686 - CH 1294476 - CH 1294477 - CH 4357445 - 4509371 - CH 4509372 - CH 9087192 - CH 9087193 - CH 3548818 - CH 3548819 - K402 4 - EK330/340/630/640 CH 1217686 - CH 4357445 - K432 13 - EK300/310 CH 1294476 - CH 1294477 - CH 4509371 - CH 4509372 - CH 9087192 - CH 9087193 - CH 3548818 - CH 3548819 - K432 43 - EK330/340/630/640 - K402 4 - EK300/310		
● P-G-R-T TRUCK			
★	K432 25/46 - EK630/640		

CLUTCH SERVO REPAIR SET

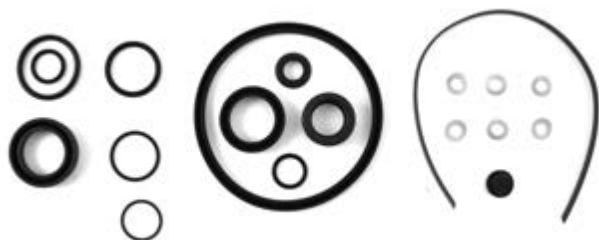

	60426	550453	550421 550422 550437
● 2 TRUCK			
★	FOR OUR 62089		
● 3 TRUCK			
★	FOR OUR 62089		

CLUTCH SERVO REPAIR SET



	60810	1336159	550455 550465
● 3 BUS			
★	FOR OUR 60808		
● 3 TRUCK			
★	FOR OUR 60808		

ALL THE COMPONENTS LISTED IN OUR CATALOGUE ARE NOT ORIGINAL, THOUGH PERFECTLY INTERCHANGEABLE. REFERENCE NUMBERS, EITHER ORIGINAL OR OF A DIFFERENT NATURE, ARE FOR INFORMATION PURPOSES ONLY. WHEN PLACING AN ORDER, PLEASE, ALWAYS USE COSIBO REFERENCE NUMBERS AND DO NOT MENTION THE ORIGINAL REFERENCE NUMBERS OF THE TRUCK MANUFACTURERS IN THE INVOICE TO VEHICLE OWNERS OR TO ANYBODY ELSE. THE CUSTOMER TAKES HIS OWN RESPONSIBILITY IF HE DOES NOT COMPLY WITH WHAT ABOVE.

CLUTCH CYLINDER REPAIR SET



	Code	OEM new	OEM old
● Model	62013	550464	550458 550562
★ Application			
● 3 BUS			
★ FOR OUR 61961			
● 3 TRUCK			
★ FOR OUR 61961			

PEDAL RUBBER COVER



	65177	389035	293152
● 3 BUS			
★ CAG/CS - F93/113 - K93/113 - L113			
● 4 BUS			
★ K IM - K94/114/124 - L94 - F94			
● 3 TRUCK			
★ CG/CP 93/113 - CR/CT 93/113/143 - CP/CR 113			
● 4 TRUCK			
★ CP/CR/CT GR/GRS			

SPRING



	65178	1409551	1391676
● 3 BUS			
★ F 93/113			
● 4 BUS			
★ K94 IB - K94/114/124 - F/L94			
● 3 TRUCK			
★ CG/CP/CR 93/113 - CR/CT 93/113/143			
● 4 TRUCK			
★ CR/GRS			

ALL THE COMPONENTS LISTED IN OUR CATALOGUE ARE NOT ORIGINAL, THOUGH PERFECTLY INTERCHANGEABLE. REFERENCE NUMBERS, EITHER ORIGINAL OR OF A DIFFERENT NATURE, ARE FOR INFORMATION PURPOSES ONLY. WHEN PLACING AN ORDER, PLEASE, ALWAYS USE COSIBO REFERENCE NUMBERS AND DO NOT MENTION THE ORIGINAL REFERENCE NUMBERS OF THE TRUCK MANUFACTURERS IN THE INVOICE TO VEHICLE OWNERS OR TO ANYBODY ELSE. THE CUSTOMER TAKES HIS OWN RESPONSIBILITY IF HE DOES NOT COMPLY WITH WHAT ABOVE.

SERVO CLUTCH FORK L=95 mm WITH NUT



	Code	OEM new	OEM old
● Model ★ Application	61344	1120884	338692
● 2 TRUCK			
★ 112 - 142			
● 3 TRUCK			
★ 113 - 143			

SERVO CLUTCH FORK L= 110 WITH NUT







	Code	OEM new	OEM old
	61493	1120880	
● 2 TRUCK			
★ 112 - 142			

SERVO CLUTCH FORK L= 220 mm WITH NUT



	Code	OEM new	OEM old
	61350	1120881	345360
● 3 BUS			
★ F/K 93/113 - L 113			
● 3 TRUCK			
★ CG/CP/CR/CT 93/113			

ALL THE COMPONENTS LISTED IN OUR CATALOGUE ARE NOT ORIGINAL, THOUGH PERFECTLY INTERCHANGEABLE. REFERENCE NUMBERS, EITHER ORIGINAL OR OF A DIFFERENT NATURE, ARE FOR INFORMATION PURPOSES ONLY. WHEN PLACING AN ORDER, PLEASE, ALWAYS USE COSIBO REFERENCE NUMBERS AND DO NOT MENTION THE ORIGINAL REFERENCE NUMBERS OF THE TRUCK MANUFACTURERS IN THE INVOICE TO VEHICLE OWNERS OR TO ANYBODY ELSE. THE CUSTOMER TAKES HIS OWN RESPONSIBILITY IF HE DOES NOT COMPLY WITH WHAT ABOVE.

	Code	OEM new	OEM old
REPAIR SET	62091	62091	
	<ul style="list-style-type: none"> ● Model ★ Application 		
	<ul style="list-style-type: none"> ● 3 BUS ★ F/K 93/113 - L 113 		
	<ul style="list-style-type: none"> ● 3 TRUCK ★ CG/CP/CR/CT 93/113 		
PIN	61352	808214	
	<ul style="list-style-type: none"> ● 2 TRUCK ★ 142 		
	<ul style="list-style-type: none"> ● 3 BUS ★ F/K 93/113 - L 113 		
	<ul style="list-style-type: none"> ● 3 TRUCK ★ CG/CP/CR/CT 93/113 - CR/CT 143 		
BUSHING	65179	283650	
	<ul style="list-style-type: none"> ● 3 BUS ★ F/K 93/113 - L113 		
	<ul style="list-style-type: none"> ● 3 TRUCK ★ CG/CP/CR/CT 93/113 - CR/CT 143 		
FLEXIBLE HOSE	60597	306278	
	<ul style="list-style-type: none"> ● 3 BUS ★ K 93/113 GS771/772 GR801 - L 113 		
	<ul style="list-style-type: none"> ● 3 TRUCK ★ CG/CP/CR/CT 93/113/143 - AMA56/61 - CP/CR 113/143 GRH880/900 		

ALL THE COMPONENTS LISTED IN OUR CATALOGUE ARE NOT ORIGINAL, THOUGH PERFECTLY INTERCHANGEABLE. REFERENCE NUMBERS, EITHER ORIGINAL OR OF A DIFFERENT NATURE, ARE FOR INFORMATION PURPOSES ONLY. WHEN PLACING AN ORDER, PLEASE, ALWAYS USE COSIBO REFERENCE NUMBERS AND DO NOT MENTION THE ORIGINAL REFERENCE NUMBERS OF THE TRUCK MANUFACTURERS IN THE INVOICE TO VEHICLE OWNERS OR TO ANYBODY ELSE. THE CUSTOMER TAKES HIS OWN RESPONSIBILITY IF HE DOES NOT COMPLY WITH WHAT ABOVE.

FLEXIBLE HOSE



- **Model**
- ★ **Application**

Code	OEM new	OEM old
63567	1340408	

- **3 TRUCK**
- ★ CG/CP/CR/CT 93/113/143

ALL THE COMPONENTS LISTED IN OUR CATALOGUE ARE NOT ORIGINAL, THOUGH PERFECTLY INTERCHANGEABLE. REFERENCE NUMBERS, EITHER ORIGINAL OR OF A DIFFERENT NATURE, ARE FOR INFORMATION PURPOSES ONLY. WHEN PLACING AN ORDER, PLEASE, ALWAYS USE COSIBO REFERENCE NUMBERS AND DO NOT MENTION THE ORIGINAL REFERENCE NUMBERS OF THE TRUCK MANUFACTURERS IN THE INVOICE TO VEHICLE OWNERS OR TO ANYBODY ELSE. THE CUSTOMER TAKES HIS OWN RESPONSIBILITY IF HE DOES NOT COMPLY WITH WHAT ABOVE.

CLUTCH DISC



- Model
- ★ Application

Code

OEM new

OEM old

63324

1304781

571254

- 3 TRUCK

- ★ K432 6

CLUTCH DISC

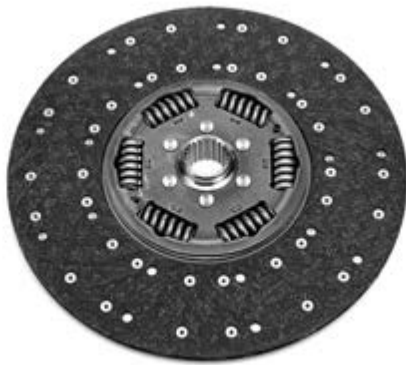

- 3 BUS

- ★ K432 3

- 3 TRUCK

- ★ K432 3

60778

1108445

304394

GEARBOX OIL PUMP



- 3 BUS

- ★ K432 3 - K422 9 - GS771

- 3 TRUCK

- ★ K432 3/5/6/9 - K422 8/9 - EK422 - K442 1

61341

194838

ALL THE COMPONENTS LISTED IN OUR CATALOGUE ARE NOT ORIGINAL, THOUGH PERFECTLY INTERCHANGEABLE. REFERENCE NUMBERS, EITHER ORIGINAL OR OF A DIFFERENT NATURE, ARE FOR INFORMATION PURPOSES ONLY. WHEN PLACING AN ORDER, PLEASE, ALWAYS USE COSIBO REFERENCE NUMBERS AND DO NOT MENTION THE ORIGINAL REFERENCE NUMBERS OF THE TRUCK MANUFACTURERS IN THE INVOICE TO VEHICLE OWNERS OR TO ANYBODY ELSE. THE CUSTOMER TAKES HIS OWN RESPONSIBILITY IF HE DOES NOT COMPLY WITH WHAT ABOVE.

		Code	OEM new	OEM old
SLEEVE	● Model	61764	1103619	
	★ Application			
	● 3 BUS			
	★ K432 3 - K422 9 - GS771			
● 3 TRUCK				
★ K432 5/6 - K442 1				



SLEEVE		62461	1103934	
	● 3 BUS			
	★ K402 3 GR801 - K432 14 GR801			
	● 4 BUS			
★ K432 8				
● 3 TRUCK				
★ K402 3 GR801 - GR/GRS900 - K432 7/8/10/14 GR/GRS900 - K432 8 DTC11 GR/GRS900 - K442 2 GRH900				



CLUTCH RELEASE BEARING INT. DIAM. = 45 mm		60794	342832	294999
	● 2 TRUCK			
★ 112/142 1st series				



ALL THE COMPONENTS LISTED IN OUR CATALOGUE ARE NOT ORIGINAL, THOUGH PERFECTLY INTERCHANGEABLE. REFERENCE NUMBERS, EITHER ORIGINAL OR OF A DIFFERENT NATURE, ARE FOR INFORMATION PURPOSES ONLY. WHEN PLACING AN ORDER, PLEASE, ALWAYS USE COSIBO REFERENCE NUMBERS AND DO NOT MENTION THE ORIGINAL REFERENCE NUMBERS OF THE TRUCK MANUFACTURERS IN THE INVOICE TO VEHICLE OWNERS OR TO ANYBODY ELSE. THE CUSTOMER TAKES HIS OWN RESPONSIBILITY IF HE DOES NOT COMPLY WITH WHAT ABOVE.

CLUTCH RELEASE BEARING INT. DIAM. = 45 mm



	Code	OEM new	OEM old
● Model	60795	342833	304305
★ Application			
● 2 TRUCK			
★	112 G770 VLX 6020030/6020031 - GS770 VLX 6120939 - GS771/772 VLX 6800460/6800461 - GR870 VLX 6296900 - GR871		

CLUTCH RELEASE BEARING INT. DIAM = 60 mm



	Code	OEM new	OEM old
	60798	397956	352745
● 2 TRUCK			
★	112/142 2nd series		

CLUTCH RELEASE BEARING INT. DIAM. = 70 mm



	Code	OEM new	OEM old
	60789	1367604	352750
● 3 BUS			
★	K422 12 GR801		
● 3 TRUCK			
★	K422 9 - K422 12 GR801 - K422 9 CAG - K432 3/9		

ALL THE COMPONENTS LISTED IN OUR CATALOGUE ARE NOT ORIGINAL, THOUGH PERFECTLY INTERCHANGEABLE. REFERENCE NUMBERS, EITHER ORIGINAL OR OF A DIFFERENT NATURE, ARE FOR INFORMATION PURPOSES ONLY. WHEN PLACING AN ORDER, PLEASE, ALWAYS USE COSIBO REFERENCE NUMBERS AND DO NOT MENTION THE ORIGINAL REFERENCE NUMBERS OF THE TRUCK MANUFACTURERS IN THE INVOICE TO VEHICLE OWNERS OR TO ANYBODY ELSE. THE CUSTOMER TAKES HIS OWN RESPONSIBILITY IF HE DOES NOT COMPLY WITH WHAT ABOVE.

CLUTCH RELEASE BEARING PRESSURE PLATE



	Code	OEM new	OEM old
● Model	60974	304309	
★ Application			
● 2 TRUCK			
★ 112/142 1st series FOR OUR 60974			

CLUTCH RELEASE BEARING PRESSURE PLATE



	60975	362778	352722
● 2 TRUCK			
★ 112 G770 VLX 6020030/6020031 - GS770 VLX 6120939 - GS771/772 VLX 6800460/6800461 - GR870 VLX 6296900 - GR871 - FOR OUR 60789 & 60795			
● 3 TRUCK			
★ K422 12 GR801 - K422 9 CAG - GE 6806706 - K432 3/9 - K422 9 - FOR OUR 60789 & 60795			
● 3 BUS			
★ K422 12 GR801 - K432 3 - K422 9 - GS771 - FOR OUR 60789 & 60795			

CLUTCH RELEASER BEARING



	60790	1797431	1321260 1393163 382413 388053
● 3 TRUCK			
★ K432 6			

ALL THE COMPONENTS LISTED IN OUR CATALOGUE ARE NOT ORIGINAL, THOUGH PERFECTLY INTERCHANGEABLE. REFERENCE NUMBERS, EITHER ORIGINAL OR OF A DIFFERENT NATURE, ARE FOR INFORMATION PURPOSES ONLY. WHEN PLACING AN ORDER, PLEASE, ALWAYS USE COSIBO REFERENCE NUMBERS AND DO NOT MENTION THE ORIGINAL REFERENCE NUMBERS OF THE TRUCK MANUFACTURERS IN THE INVOICE TO VEHICLE OWNERS OR TO ANYBODY ELSE. THE CUSTOMER TAKES HIS OWN RESPONSIBILITY IF HE DOES NOT COMPLY WITH WHAT ABOVE.

CLUTCH RELEASE BEARING



	Code	OEM new	OEM old
● Model	63117	1545062	1393161
★ Application			
● 3 BUS			
★ K402 1 - K402 3 GR801			
● 3 TRUCK			
★ K402 1 - K402 3 GR801 - GR/GRS900 - K432 7/8/10 GR/GRS900 - K432 8 DTC11 GR/GRS900 - K432 6/7/8			
● 4 BUS			
★ K432 8			

CLUTCH RELEASE BEARING



	61910	1407430	1321255
● 3 BUS			
★ K432 10/14 - K432 14 GR801			
● 3 TRUCK			
★ K432 5/7/8/10/14 - K432 7/8/10/14 GR/GRS900			

CLUTCH RELEASE BEARING



	65331	2164195	1851631 1479576 1499770 1728165 1749125
● P-G-R-T TRUCK			
★ K432 20/26/27/33/35/36/37/38/39/48/54/55			
● F-K-N BUS			
★ K432 20/27/37/38			
● 4 TRUCK			
★ K432 30/31/32/33/34			
● 4 BUS			
★ K432 30/31/32/33/34			

ALL THE COMPONENTS LISTED IN OUR CATALOGUE ARE NOT ORIGINAL, THOUGH PERFECTLY INTERCHANGEABLE. REFERENCE NUMBERS, EITHER ORIGINAL OR OF A DIFFERENT NATURE, ARE FOR INFORMATION PURPOSES ONLY. WHEN PLACING AN ORDER, PLEASE, ALWAYS USE COSIBO REFERENCE NUMBERS AND DO NOT MENTION THE ORIGINAL REFERENCE NUMBERS OF THE TRUCK MANUFACTURERS IN THE INVOICE TO VEHICLE OWNERS OR TO ANYBODY ELSE. THE CUSTOMER TAKES HIS OWN RESPONSIBILITY IF HE DOES NOT COMPLY WITH WHAT ABOVE.

	Code	OEM new	OEM old
BEARING	61856	1386452	
<ul style="list-style-type: none"> ● Model ★ Application 			
<ul style="list-style-type: none"> ● 3 BUS 			
<ul style="list-style-type: none"> ★ K402 1 - K402 3 GR801 - K432 14 GR801 			
<ul style="list-style-type: none"> ● 3 TRUCK 			
<ul style="list-style-type: none"> ★ K402 3 GR801 - GR/GRS900 - K432 7/8/10/14 GR/GRS900 - K432 8 DTC11 GR/GRS900 - K432 10 			
<ul style="list-style-type: none"> ● 4 BUS 			
<ul style="list-style-type: none"> ★ K432 8 			



	64331	64331	
BELL HOUSING REPAIR SET	64331	64331	
<ul style="list-style-type: none"> ● 3 BUS 			
<ul style="list-style-type: none"> ★ K402 1 - K402 3 GR801 - K432 14 GR801 - COMPOSED BY: 1 PC 63307 - 2 PCS 63308 - 1 PC 61856 			
<ul style="list-style-type: none"> ● 3 TRUCK 			
<ul style="list-style-type: none"> ★ K402 3 GR801 - GR/GRS900 - K432 7/8/10/14 GR/GRS900 - K432 8 DTC11 GR/GRS900 - K432 10 - COMPOSED BY: 1 PC 63307 - 2 PCS 63308 - 1 PC 61856 			
<ul style="list-style-type: none"> ● 4 BUS 			
<ul style="list-style-type: none"> ★ K432 8 - COMPOSED BY: 1 PC 63307 - 2 PCS 63308 - 1 PC 61856 			



	61366	1535698	224915
GASKET	61366	1535698	224915
<ul style="list-style-type: none"> ● 3 BUS 			
<ul style="list-style-type: none"> ★ K432 3 - K422 9 - GS771 			
<ul style="list-style-type: none"> ● 3 TRUCK 			
<ul style="list-style-type: none"> ★ K432 3/5/6/9 - K422 8 EK422 - K422 9 - K442 1 			



ALL THE COMPONENTS LISTED IN OUR CATALOGUE ARE NOT ORIGINAL, THOUGH PERFECTLY INTERCHANGEABLE. REFERENCE NUMBERS, EITHER ORIGINAL OR OF A DIFFERENT NATURE, ARE FOR INFORMATION PURPOSES ONLY. WHEN PLACING AN ORDER, PLEASE, ALWAYS USE COSIBO REFERENCE NUMBERS AND DO NOT MENTION THE ORIGINAL REFERENCE NUMBERS OF THE TRUCK MANUFACTURERS IN THE INVOICE TO VEHICLE OWNERS OR TO ANYBODY ELSE. THE CUSTOMER TAKES HIS OWN RESPONSIBILITY IF HE DOES NOT COMPLY WITH WHAT ABOVE.

CLUTCH ASSY



	Code	OEM new	OEM old
● Model	62006	327557	234682
★ Application			
● 3 BUS			
★ K422 9 - K422 12			
● 3 TRUCK			
★ K422 9 - K422 12			

BOOT



	62226	1308969	
● 4 TRUCK			
★ K432 13 EK300/310/330/340/630/640 - K402 4 EK300/310/330/340/630/640 - K432 43 EK330/340/630/640			
● 3 TRUCK			
★ K432 13 EK330/340/630/640 - K402 4 EK330/340/630/640 - K402 4 - K422 13 - K432 13 EK330/340/630/640 - GR/GRS900 - K402 4 - K422 13 - K432 13 EK300/310 - GR/GRS900			
● P-G-R-T TRUCK			
★ K432 25/46 EK630/640			

ALL THE COMPONENTS LISTED IN OUR CATALOGUE ARE NOT ORIGINAL, THOUGH PERFECTLY INTERCHANGEABLE. REFERENCE NUMBERS, EITHER ORIGINAL OR OF A DIFFERENT NATURE, ARE FOR INFORMATION PURPOSES ONLY. WHEN PLACING AN ORDER, PLEASE, ALWAYS USE COSIBO REFERENCE NUMBERS AND DO NOT MENTION THE ORIGINAL REFERENCE NUMBERS OF THE TRUCK MANUFACTURERS IN THE INVOICE TO VEHICLE OWNERS OR TO ANYBODY ELSE. THE CUSTOMER TAKES HIS OWN RESPONSIBILITY IF HE DOES NOT COMPLY WITH WHAT ABOVE.

		Code	OEM new	OEM old
BOOT	● Model	62227	1307793	
	★ Application			
	● 3 BUS			
	★	K402 1 - K432 14 GR801		
	● 4 TRUCK			
	★	K432 13 EK300/310/330/340/630/640 - K402 4 EK300/310/330/340/630/640 - K432 43 EK330/340/630/640		
	● 3 TRUCK			
	★	K432 13 EK330/340/630/640 - K402 4 EK330/340/630/640 - K402 1 - K432 5/6/10 - K422 8 EK422 - K432 7/8/10/14 GR/GRS900 - K402 4 - K422 13 - K432 13 EK300/310/330/340/630/640 - GR/GRS900 - K442 1 - K442 2 GRH900		
	● P-G-R-T TRUCK			
	★	K432 25/46 EK630/640		
● 4 BUS				
★	K432 8			



		63307	1386453	
BUSHING	● 3 BUS			
	★	K402 1 - K402 3 GR801 - K432 14 GR801		
	● 3 TRUCK			
	★	K402 3 GR801 - GR/GRS900 - K432 7/8/10/14 GR/GRS900 - K432 8 DTC11 GR/GRS900 - K432 10		
	● 4 BUS			
	★	K432 8		



		63308	1386454	
SEAL RING	● 3 BUS			
	★	K402 1 - K402 3 GR801 - K432 14 GR801		
	● 3 TRUCK			
	★	K402 3 GR801 - GR/GRS900 - K432 7/8/10/14 GR/GRS900 - K432 8 DTC11 GR/GRS900 - K432 10		
	● 4 BUS			
	★	K432 8		



ALL THE COMPONENTS LISTED IN OUR CATALOGUE ARE NOT ORIGINAL, THOUGH PERFECTLY INTERCHANGEABLE. REFERENCE NUMBERS, EITHER ORIGINAL OR OF A DIFFERENT NATURE, ARE FOR INFORMATION PURPOSES ONLY. WHEN PLACING AN ORDER, PLEASE, ALWAYS USE COSIBO REFERENCE NUMBERS AND DO NOT MENTION THE ORIGINAL REFERENCE NUMBERS OF THE TRUCK MANUFACTURERS IN THE INVOICE TO VEHICLE OWNERS OR TO ANYBODY ELSE. THE CUSTOMER TAKES HIS OWN RESPONSIBILITY IF HE DOES NOT COMPLY WITH WHAT ABOVE.

CLUTCH DISC



	Code	OEM new	OEM old
● Model	65332	1929397	1444110
★ Application			1749123
● 3 BUS			
★	K432 14 - K432 10		
● 4 BUS			
★	K432 30 - K432 31 - K432 32 - K432 15 - K432 16 - K432 17 - K432 8		
● 3 TRUCK			
★	K432 7/ 8 - K432 10 - K432 13 - EK300/ 310/ 330/ 340/ 630/ 640 CH 1217685 - CH 4357444 - K432 14 - K432 13 - EK330/ 340/ 630/ 640 CH 1217686 - CH 4357445		
● 4 TRUCK			
★	K432 30 - K432 31 - K432 32 - K432 15 - K432 16 - K432 17 - K432 13		

CLUTCH DISC



	Code	OEM new	OEM old
	64423	1898019	574908
● 4 TRUCK			
★	K432 19/33		
● P-G-R-T TRUCK			
★	K 432 33/35/39		

ALL THE COMPONENTS LISTED IN OUR CATALOGUE ARE NOT ORIGINAL, THOUGH PERFECTLY INTERCHANGEABLE. REFERENCE NUMBERS, EITHER ORIGINAL OR OF A DIFFERENT NATURE, ARE FOR INFORMATION PURPOSES ONLY. WHEN PLACING AN ORDER, PLEASE, ALWAYS USE COSIBO REFERENCE NUMBERS AND DO NOT MENTION THE ORIGINAL REFERENCE NUMBERS OF THE TRUCK MANUFACTURERS IN THE INVOICE TO VEHICLE OWNERS OR TO ANYBODY ELSE. THE CUSTOMER TAKES HIS OWN RESPONSIBILITY IF HE DOES NOT COMPLY WITH WHAT ABOVE.

CLUTCH DISC



	Code	OEM new	OEM old
● Model	65102	2085863	1479575 571316 574911
★ Application			
● P-G-R-T TRUCK			
★ K432 20/36/37			
● F-K-N BUS			
★ K432 20/37			

CLUTCH PRESSURE PLATE



	65544	1479574	
● F-K-N BUS			
★ K432 20 - K432 27 - K432 50			
● P-G-R-T TRUCK			
★ K432 20 - K432 27			

CLUTCH COVER



	65368	1513719	1513720
● 4 BUS			
★ K432 30/31/32/34			
● F-K-N BUS			
★ K432 35			
● 4 TRUCK			
★ K432 30/31/32/34			

ALL THE COMPONENTS LISTED IN OUR CATALOGUE ARE NOT ORIGINAL, THOUGH PERFECTLY INTERCHANGEABLE. REFERENCE NUMBERS, EITHER ORIGINAL OR OF A DIFFERENT NATURE, ARE FOR INFORMATION PURPOSES ONLY. WHEN PLACING AN ORDER, PLEASE, ALWAYS USE COSIBO REFERENCE NUMBERS AND DO NOT MENTION THE ORIGINAL REFERENCE NUMBERS OF THE TRUCK MANUFACTURERS IN THE INVOICE TO VEHICLE OWNERS OR TO ANYBODY ELSE. THE CUSTOMER TAKES HIS OWN RESPONSIBILITY IF HE DOES NOT COMPLY WITH WHAT ABOVE.

CLUTCH DISK+COVER



- Model
- ★ Application

Code	OEM new	OEM old
65379	1929397 1382331	

- 4 BUS
- ★ K432 16/18
- 4 TRUCK
- ★ K432 16

CLUTCH COVER



Code	OEM new	OEM old
61866	1321259	

- 3 TRUCK
- ★ K432 6/7/8
- 4 BUS
- ★ K432 8/15/17
- 4 TRUCK
- ★ K432 15/17

ALL THE COMPONENTS LISTED IN OUR CATALOGUE ARE NOT ORIGINAL, THOUGH PERFECTLY INTERCHANGEABLE. REFERENCE NUMBERS, EITHER ORIGINAL OR OF A DIFFERENT NATURE, ARE FOR INFORMATION PURPOSES ONLY. WHEN PLACING AN ORDER, PLEASE, ALWAYS USE COSIBO REFERENCE NUMBERS AND DO NOT MENTION THE ORIGINAL REFERENCE NUMBERS OF THE TRUCK MANUFACTURERS IN THE INVOICE TO VEHICLE OWNERS OR TO ANYBODY ELSE. THE CUSTOMER TAKES HIS OWN RESPONSIBILITY IF HE DOES NOT COMPLY WITH WHAT ABOVE.

CLUTCH SET

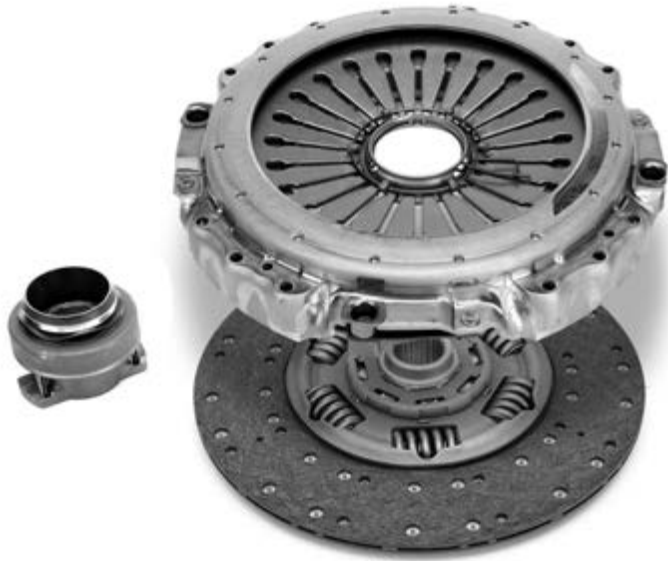

- Model
- ★ Application

Code

OEM new

OEM old

64425

64425

- 4 TRUCK

- ★ K432 19/33

- P-G-R-T TRUCK

- ★ K432 33/35/39

CLUTCH SET



- F-K-N BUS

- ★ K432 20

- P-G-R-T TRUK

- ★ K432 20

64866

572950

ALL THE COMPONENTS LISTED IN OUR CATALOGUE ARE NOT ORIGINAL, THOUGH PERFECTLY INTERCHANGEABLE. REFERENCE NUMBERS, EITHER ORIGINAL OR OF A DIFFERENT NATURE, ARE FOR INFORMATION PURPOSES ONLY. WHEN PLACING AN ORDER, PLEASE, ALWAYS USE COSIBO REFERENCE NUMBERS AND DO NOT MENTION THE ORIGINAL REFERENCE NUMBERS OF THE TRUCK MANUFACTURERS IN THE INVOICE TO VEHICLE OWNERS OR TO ANYBODY ELSE. THE CUSTOMER TAKES HIS OWN RESPONSIBILITY IF HE DOES NOT COMPLY WITH WHAT ABOVE.

	Code	OEM new	OEM old
CLUTCH MOUNTING SET	63846	1341683	
● Model			
★ Application			
● 3 BUS			
★ K402 1/3 - K432 18			
● 4 BUS			
★ K402 5 - K432 8/15/16/17/18			
● 3 TRUCK			
★ K402 1/3 - K432 6/7/8			
● 4 TRUCK			
★ K402 5 - K432 15/16/17/19 - K442 3			



	64413	1749126	
CLUTCH MOUNTING SET			
● 4 TRUCK			
★ K432 30/32/33/35/37/39/55			
● P-G-R-T TRUCK			
★ K432 30/32/33/35/37/39/55			
● F-K-N BUS			
★ K432 30/32/33/35/37/39/55			



ALL THE COMPONENTS LISTED IN OUR CATALOGUE ARE NOT ORIGINAL, THOUGH PERFECTLY INTERCHANGEABLE. REFERENCE NUMBERS, EITHER ORIGINAL OR OF A DIFFERENT NATURE, ARE FOR INFORMATION PURPOSES ONLY. WHEN PLACING AN ORDER, PLEASE, ALWAYS USE COSIBO REFERENCE NUMBERS AND DO NOT MENTION THE ORIGINAL REFERENCE NUMBERS OF THE TRUCK MANUFACTURERS IN THE INVOICE TO VEHICLE OWNERS OR TO ANYBODY ELSE. THE CUSTOMER TAKES HIS OWN RESPONSIBILITY IF HE DOES NOT COMPLY WITH WHAT ABOVE.

CLUTCH FORK



	Code	OEM new	OEM old
● Model	64246	1737306	1545625
★ Application			
● 4 BUS			
★ K432 30/31/32/33/34			
● F-K-N BUS			
★ K432 37/38			
● 4 TRUCK			
★ K432 30/31/32/33/34			
● P-G-R-T TRUCK			
★ K432 20/26/27/33/35/36/37/38/39/54/55			

RELEASE LEVER REPAIR SET



	64340	64340	
● 4 BUS			
★ K432 30/31/32/33/34 FOR OUR 64246			
● F-K-N BUS			
★ K432 37/38 FOR OUR 64246			
● 4 TRUCK			
★ K432 30/31/32/33/34 FOR OUR 64246			
● P-G-R-T TRUCK			
★ K432 20/26/27/33/35/36/37/38/39/54/55 FOR OUR 64246			

RELEASE ROLLER BEARING



	62014	355708	
● 3 BUS			
★ K402 3 GR801 - K432 14 GR801 - K432 10			
● 3 TRUCK			
★ K432 5/13 - EK330/340/422/630/640 - K402 4 - K422 8 - K402 4 - K422 13 - K432 13 - EK300/310/330/340/630/640 GR/GRS900			
● 4 TRUCK			
★ K432 13/43 - EK300/310/330/340/630/640 - K402 4			
● P-G-R-T TRUCK			
★ K432 25/46 - EK630/640			

ALL THE COMPONENTS LISTED IN OUR CATALOGUE ARE NOT ORIGINAL, THOUGH PERFECTLY INTERCHANGEABLE. REFERENCE NUMBERS, EITHER ORIGINAL OR OF A DIFFERENT NATURE, ARE FOR INFORMATION PURPOSES ONLY. WHEN PLACING AN ORDER, PLEASE, ALWAYS USE COSIBO REFERENCE NUMBERS AND DO NOT MENTION THE ORIGINAL REFERENCE NUMBERS OF THE TRUCK MANUFACTURERS IN THE INVOICE TO VEHICLE OWNERS OR TO ANYBODY ELSE. THE CUSTOMER TAKES HIS OWN RESPONSIBILITY IF HE DOES NOT COMPLY WITH WHAT ABOVE.

RELEASE ROLLER BEARING



	Code	OEM new	OEM old
● Model	63569	1753479	1335485
★ Application			
● 3 BUS			
★	K402 1 - K402 3 GR801 - K432 14 GR801		
● 4 BUS			
★	K432 8/30/31/32/33/34		
● F-K-N BUS			
★	K432 20/27/37/38/50		
● 3 TRUCK			
★	K402 1 - K432 5/6/10/14 - K402 3 GR801 - GR/GRS900 - K432 7/8/10/14 GR/GRS900 - K442 1 - K432 8 DTC11 GR/GRS900 - K442 2 GRH900		
● 4 TRUCK			
★	K402 1 - K432 30/31/32/33/34		
● P-G-R-T TRUCK			
★	K432 20/26/27/33/35/36/37/38/39/48/54/55 - K392 1 - K432 40/41/42/49 PTO EK		

O-RING

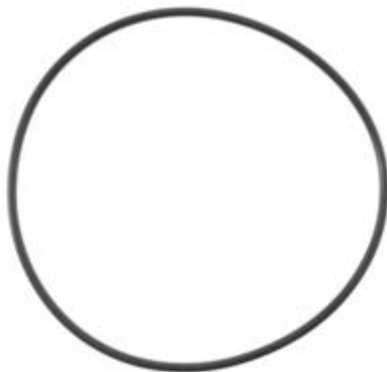

	61632	1312934	323641
● 3 BUS			
★	K113 - GA775/781R		

ALL THE COMPONENTS LISTED IN OUR CATALOGUE ARE NOT ORIGINAL, THOUGH PERFECTLY INTERCHANGEABLE. REFERENCE NUMBERS, EITHER ORIGINAL OR OF A DIFFERENT NATURE, ARE FOR INFORMATION PURPOSES ONLY. WHEN PLACING AN ORDER, PLEASE, ALWAYS USE COSIBO REFERENCE NUMBERS AND DO NOT MENTION THE ORIGINAL REFERENCE NUMBERS OF THE TRUCK MANUFACTURERS IN THE INVOICE TO VEHICLE OWNERS OR TO ANYBODY ELSE. THE CUSTOMER TAKES HIS OWN RESPONSIBILITY IF HE DOES NOT COMPLY WITH WHAT ABOVE.

OIL SEAL 55x75x9



	Code	OEM new	OEM old
● Model	63128	1318388	
★ Application			
● 4 BUS			
★ K432 30/31/32/33/34			
● F-K-N BUS			
★ K432 37/38			
● 4 TRUCK			
★ K432 30/31/32/33/34			
● P-G-R-T TRUCK			
★ K432 20/26/27/33/35/36/37/38/39/54/55			

RUBBER COVER



	64097	1379922	
● 3 BUS			
★ K422 12 - GR801 - K402 1/3 - K432 3/10/14 - K422 9 - F93/113 - GS771			
● 4 BUS			
★ K432 8/15/16/17/18/30/31/32/33/34			
● F-K-N BUS			
★ K432 37/38			
● 3 TRUCK			
★ K401 1 - K421 - K422 8/9/12 - EK422 - K432 3/6/9 - K402 3 GR801 GR/GRS900 - K432 7/8/10/14 GR/GRS900 - K442 1 - K442 2 GRH900 - K432 8 DTC11 GR/GRS900 - K402 4 - K422 13 - K432 13 - EK300/310 GR/GRS900 - K432 10			
● 4 TRUCK			
★ K402 4/5 - K300/301 - K432 13 - EK300/301 - K432 15/16/17/30/31/32/33/34 - K442 3 - K442 3 LHD/RHD - K432 15/17/19 LHD/RHD			
● P-G-R-T TRUCK			
★ K432 20/26/27/33/35/36/37/38/39/54/55			

ALL THE COMPONENTS LISTED IN OUR CATALOGUE ARE NOT ORIGINAL, THOUGH PERFECTLY INTERCHANGEABLE. REFERENCE NUMBERS, EITHER ORIGINAL OR OF A DIFFERENT NATURE, ARE FOR INFORMATION PURPOSES ONLY. WHEN PLACING AN ORDER, PLEASE, ALWAYS USE COSIBO REFERENCE NUMBERS AND DO NOT MENTION THE ORIGINAL REFERENCE NUMBERS OF THE TRUCK MANUFACTURERS IN THE INVOICE TO VEHICLE OWNERS OR TO ANYBODY ELSE. THE CUSTOMER TAKES HIS OWN RESPONSIBILITY IF HE DOES NOT COMPLY WITH WHAT ABOVE.

	Code	OEM new	OEM old
RUBBER COVER	64098	1302914	
<ul style="list-style-type: none"> ● Model ★ Application 			
	<ul style="list-style-type: none"> ● 4 BUS 		
	<ul style="list-style-type: none"> ★ K432 15/16/17 		
	<ul style="list-style-type: none"> ● 3 TRUCK 		
	<ul style="list-style-type: none"> ★ K432 3/9 - K422 9 		
	<ul style="list-style-type: none"> ● 4 TRUCK 		
	<ul style="list-style-type: none"> ★ K402 5 - K432 15/17/19 LHD/RHD - K432 16 LHD - K442 3 LHD/RHD 		



ALL THE COMPONENTS LISTED IN OUR CATALOGUE ARE NOT ORIGINAL, THOUGH PERFECTLY INTERCHANGEABLE. REFERENCE NUMBERS, EITHER ORIGINAL OR OF A DIFFERENT NATURE, ARE FOR INFORMATION PURPOSES ONLY. WHEN PLACING AN ORDER, PLEASE, ALWAYS USE COSIBO REFERENCE NUMBERS AND DO NOT MENTION THE ORIGINAL REFERENCE NUMBERS OF THE TRUCK MANUFACTURERS IN THE INVOICE TO VEHICLE OWNERS OR TO ANYBODY ELSE. THE CUSTOMER TAKES HIS OWN RESPONSIBILITY IF HE DOES NOT COMPLY WITH WHAT ABOVE.

RUBBER BUFFER



● Model

★ Application

Code

OEM new

OEM old

63929

1388070

● F-K-N BUS

★ DC9/11/12 GR875R - GRS895R - GR/GRS/GRSO905R - K GR875 - K UD

● 4 TRUCK

★ DC14 GRS/GRSH/900R - DC11 01/04/06/07 - DC12 GRS890R - GR/GRS/GRSO/900R - DC11 74/75 - OSC11 G03 GRS890R - GR/GRS/GRSO900R - DC9 GRS890R - GR/GRS/GRSO900R - GA851/852R - DC16 GRS/GRSO/900/920R

● P-G-R-T TRUCK

★ DC9/11/12/13/16 - GA750/760/850/860 - GA750/850/760/860R - GRS0H901R - DC9/11/12 GR875R - GRS895R - GR/GRS/GRSO905R - DC16 GRS895/905R - GRS0905R

ALL THE COMPONENTS LISTED IN OUR CATALOGUE ARE NOT ORIGINAL, THOUGH PERFECTLY INTERCHANGEABLE. REFERENCE NUMBERS, EITHER ORIGINAL OR OF A DIFFERENT NATURE, ARE FOR INFORMATION PURPOSES ONLY. WHEN PLACING AN ORDER, PLEASE, ALWAYS USE COSIBO REFERENCE NUMBERS AND DO NOT MENTION THE ORIGINAL REFERENCE NUMBERS OF THE TRUCK MANUFACTURERS IN THE INVOICE TO VEHICLE OWNERS OR TO ANYBODY ELSE. THE CUSTOMER TAKES HIS OWN RESPONSIBILITY IF HE DOES NOT COMPLY WITH WHAT ABOVE.

	Code	OEM new	OEM old
CLAMP D.8	64090	813934	
<ul style="list-style-type: none"> ● Model ★ Application 			
<ul style="list-style-type: none"> ● 3 BUS ★ 			
<ul style="list-style-type: none"> ● 4 BUS ★ 			
<ul style="list-style-type: none"> ● F-K-N BUS ★ 			
<ul style="list-style-type: none"> ● 3 TRUCK ★ 			
<ul style="list-style-type: none"> ● 4 TRUCK ★ 			



CLAMP D.13	64091	813936	
<ul style="list-style-type: none"> ● 3 TRUCK ★ 			





CLAMP D. 16	64084	813937	
<ul style="list-style-type: none"> ● 3 BUS ★ 			
<ul style="list-style-type: none"> ● 3 TRUCK ★ 			



ALL THE COMPONENTS LISTED IN OUR CATALOGUE ARE NOT ORIGINAL, THOUGH PERFECTLY INTERCHANGEABLE. REFERENCE NUMBERS, EITHER ORIGINAL OR OF A DIFFERENT NATURE, ARE FOR INFORMATION PURPOSES ONLY. WHEN PLACING AN ORDER, PLEASE, ALWAYS USE COSIBO REFERENCE NUMBERS AND DO NOT MENTION THE ORIGINAL REFERENCE NUMBERS OF THE TRUCK MANUFACTURERS IN THE INVOICE TO VEHICLE OWNERS OR TO ANYBODY ELSE. THE CUSTOMER TAKES HIS OWN RESPONSIBILITY IF HE DOES NOT COMPLY WITH WHAT ABOVE.

	Code	OEM new	OEM old
CLAMP D.18	64092	813938	
	<ul style="list-style-type: none"> ● Model ★ Application 		
	<ul style="list-style-type: none"> ● 3 BUS ★ 		
	<ul style="list-style-type: none"> ● 3 TRUCK ★ 		
	<ul style="list-style-type: none"> ● 4 TRUCK ★ 		

CLAMP D.22	64093	813940	
	<ul style="list-style-type: none"> ● 3 TRUCK ★ 		

CLAMP D.28	64095	804578	
	<ul style="list-style-type: none"> ● 3 TRUCK ★ 		
	<ul style="list-style-type: none"> ● 4 TRUCK ★ 		

ALL THE COMPONENTS LISTED IN OUR CATALOGUE ARE NOT ORIGINAL, THOUGH PERFECTLY INTERCHANGEABLE. REFERENCE NUMBERS, EITHER ORIGINAL OR OF A DIFFERENT NATURE, ARE FOR INFORMATION PURPOSES ONLY. WHEN PLACING AN ORDER, PLEASE, ALWAYS USE COSIBO REFERENCE NUMBERS AND DO NOT MENTION THE ORIGINAL REFERENCE NUMBERS OF THE TRUCK MANUFACTURERS IN THE INVOICE TO VEHICLE OWNERS OR TO ANYBODY ELSE. THE CUSTOMER TAKES HIS OWN RESPONSIBILITY IF HE DOES NOT COMPLY WITH WHAT ABOVE.

		Code	OEM new	OEM old
OIL FILTER	● Model	60434	2002705	1768402 1301696
	★ Application			
	● 3 BUS			
	★	GR801R		
	● 4 BUS			
	★	GR801R		
	● F-K-N BUS			
	★	GR801R - GR875R - GRS/GRS0895R - GR/GRS/GRS0905R		
	● 3 TRUCK			
	★	GR801R - GR/GRS900R - GRH900 - GR/GRS900 - GRS900 CAG		
● 4 TRUCK				
★	GR801R - GRSH/GRS0900R - GRS890R - GR/GRS/GRS920R - GRS890 - GR/GRS900 DSC11 - GRS/GRSH900R DC14 - GRS920R AIR DC16 6X2/4 8X2/4			
● P-G-R-T TRUCK				
★	GR801R - GRS890R - GRS900/920R - GR900R - GRS0900R - GR875R - GRS895R - GR/GRS/GRS0905R - GRS920R - GRS0900R AIR DC16 - GRS/GRS0905R AIR DC13/16			



GEARBOX OIL PUMP		61341	194838	
	● 3 TRUCK			
	★	EK330/340/421/422/423		
	● 4 TRUCK			
	★	EK330/340/630/640		
	● P-G-R-T TRUCK			
	★	EK630/640		



	Code	OEM new	OEM old
GEARBOX OIL PUMP	65192	1426449	1120646
● Model			
★ Application			
● 3 BUS			
★ GR801R			
● 4 BUS			
★ GR801R			
● F-K-N BUS			
★			
● 3 TRUCK			
★ GR801R - GR/GRS900R - GRH900			
● 4 TRUCK			
★ GR/GRS/GRSH/GRSO			
● P-G-R-T TRUCK			
★			



GEARBOX GASKET	61356	387300	
● 3 TRUCK			
★ GR871 - GR871-GR/GRE871T CAG - GR871-GR/*GRE871T - GR880/T-GRH880 - GR880			



ALL THE COMPONENTS LISTED IN OUR CATALOGUE ARE NOT ORIGINAL, THOUGH PERFECTLY INTERCHANGEABLE. REFERENCE NUMBERS, EITHER ORIGINAL OR OF A DIFFERENT NATURE, ARE FOR INFORMATION PURPOSES ONLY. WHEN PLACING AN ORDER, PLEASE, ALWAYS USE COSIBO REFERENCE NUMBERS AND DO NOT MENTION THE ORIGINAL REFERENCE NUMBERS OF THE TRUCK MANUFACTURERS IN THE INVOICE TO VEHICLE OWNERS OR TO ANYBODY ELSE. THE CUSTOMER TAKES HIS OWN RESPONSIBILITY IF HE DOES NOT COMPLY WITH WHAT ABOVE.

GEARBOX GASKET



	Code	OEM new	OEM old
● Model	63124	1305139	
★ Application			
● 3 BUS			
★			
● 3 TRUCK			
★			
● 4 BUS			
★			
● 4 TRUCK			
★			
● F-K-N BUS			
★			
● P-G-R-T TRUCK			
★			

GASKET

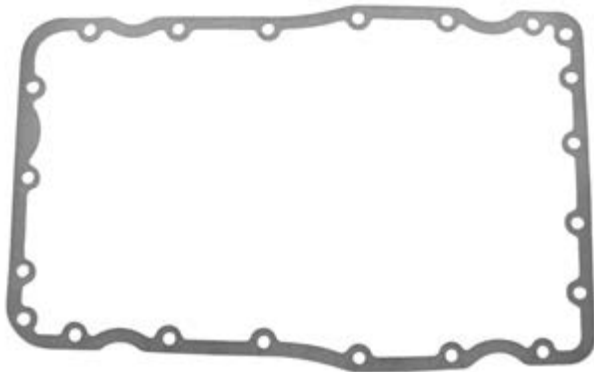

	63123	1527743	1329585
● 4 BUS			
★ GRS890 - GR/GRS920R - GRSH900R			
● F-K-N BUS			
★ GRS890 - GR/GRS920R - GRSH900R			
● 3 TRUCK			
★ GR/GRS900R - GRH900 - GRS900 - GRS900CAG - GR900			
● 4 TRUCK			
★ GRS890 - GR/GRS920R - GRSH900R - GRSO900R - GRS890R - GR/GRS900R			
● P-G-R-T TRUCK			
★ GRS890 - GR/GRS920R - GRSH900R - GRS890R - GRS900/920R - GR900R			

ALL THE COMPONENTS LISTED IN OUR CATALOGUE ARE NOT ORIGINAL, THOUGH PERFECTLY INTERCHANGEABLE. REFERENCE NUMBERS, EITHER ORIGINAL OR OF A DIFFERENT NATURE, ARE FOR INFORMATION PURPOSES ONLY. WHEN PLACING AN ORDER, PLEASE, ALWAYS USE COSIBO REFERENCE NUMBERS AND DO NOT MENTION THE ORIGINAL REFERENCE NUMBERS OF THE TRUCK MANUFACTURERS IN THE INVOICE TO VEHICLE OWNERS OR TO ANYBODY ELSE. THE CUSTOMER TAKES HIS OWN RESPONSIBILITY IF HE DOES NOT COMPLY WITH WHAT ABOVE.

	Code	OEM new	OEM old
GASKET	64312	1549495	1329586
● Model			
★ Application			
● 3 BUS			
★ GR801R			
● 4 BUS			
★ GR801R			
● F-K-N BUS			
★ GR801R			
● 3 TRUCK			
★ GR801R - GR801			
● 4 TRUCK			
★ GR801R			
● P-G-R-T TRUCK			
★ GR801R			



	60897	550520	
GASKET SET			
● 3 TRUCK			
★ GS771/772 - GR871 GR/GRE871T			



	64314	550533	
GASKET SET			
● 3 BUS			
★ GS771/772 - G776/777 - GR801			

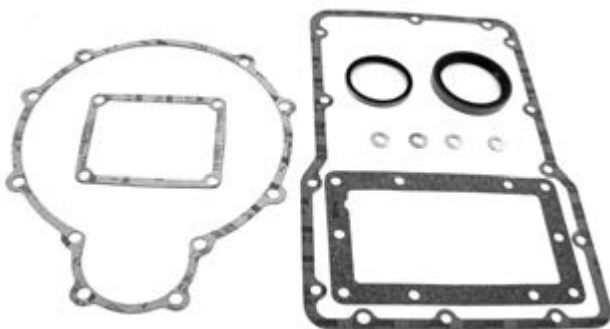

GASKET SET

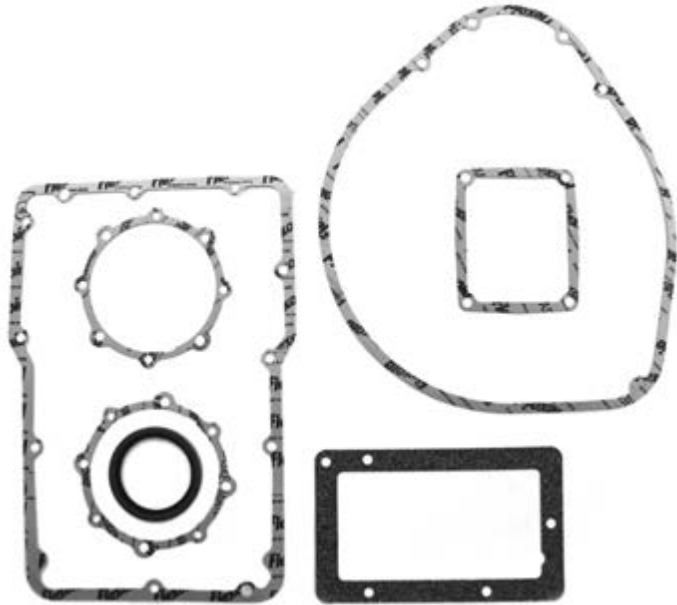

- Model
- ★ Application

Code

OEM new

OEM old

60900

550527

550521

- 3 TRUCK

- ★ GS771/772 - GR871 GR/GRE871T

GASKET SET

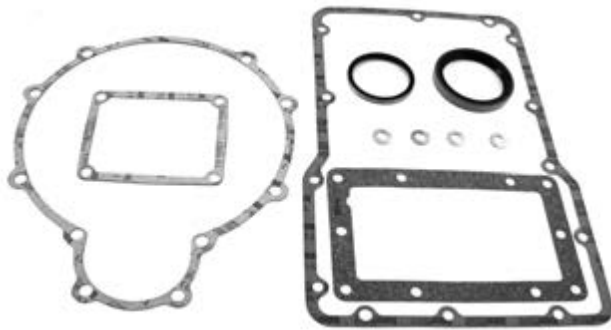

64314

550533

- 3 TRUCK

- ★ GS771/772

GASKET SET



63678

550537

- 3 BUS

- ★ G770

- 3 TRUCK

- ★ G770 - GS771/772 - GR871 - GR/GRE871T

ALL THE COMPONENTS LISTED IN OUR CATALOGUE ARE NOT ORIGINAL, THOUGH PERFECTLY INTERCHANGEABLE. REFERENCE NUMBERS, EITHER ORIGINAL OR OF A DIFFERENT NATURE, ARE FOR INFORMATION PURPOSES ONLY. WHEN PLACING AN ORDER, PLEASE, ALWAYS USE COSIBO REFERENCE NUMBERS AND DO NOT MENTION THE ORIGINAL REFERENCE NUMBERS OF THE TRUCK MANUFACTURERS IN THE INVOICE TO VEHICLE OWNERS OR TO ANYBODY ELSE. THE CUSTOMER TAKES HIS OWN RESPONSIBILITY IF HE DOES NOT COMPLY WITH WHAT ABOVE.

GASKET SET

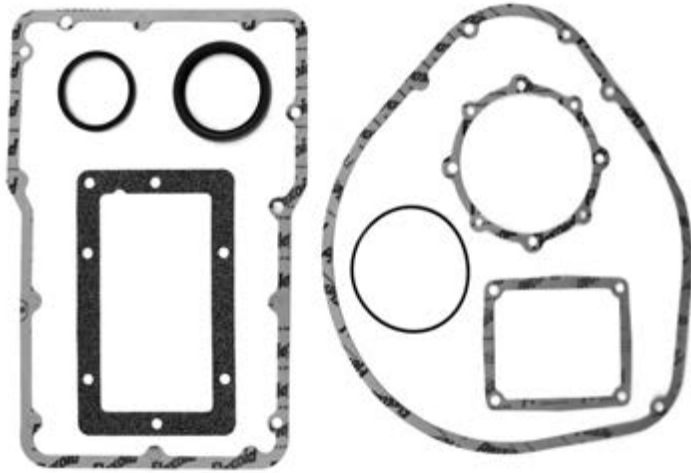

- Model
- ★ Application

Code

OEM new

OEM old

61498

550534

- 3 TRUCK

- ★ GR871 - GR/GRE871T

GEARBOX GASKET SET

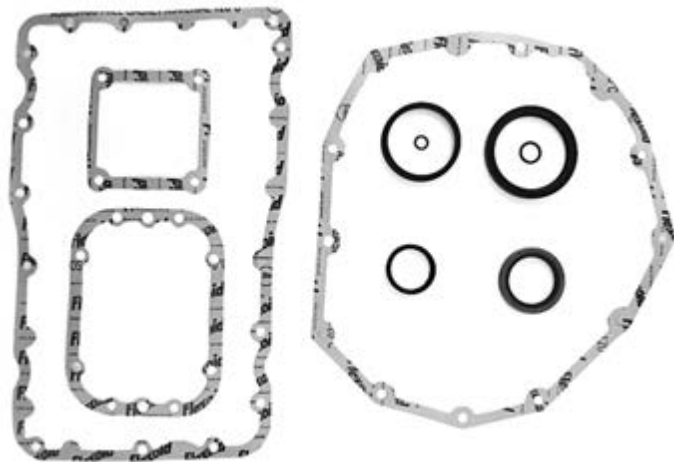

60895

550539

- 4 BUS

- ★ GRS890 - GR/GRS900R - GRSH900R

- F-K-N BUS

- ★ GRS890 - GR/GRS900R - GRSH900R - GR/GRS/GRSH900 - GR801

- 3 TRUCK

- ★ GRS900 - GR900 - GRH900

- 4 TRUCK

- ★ GRS890 - GR/GRS900R - GRSH900R - GR/GRS890R

- P-G-R-T TRUCK

- ★ GRS890 - GR/GRS900R - GRSH900R - GR/GRS/GRSH900 - GR801

ALL THE COMPONENTS LISTED IN OUR CATALOGUE ARE NOT ORIGINAL, THOUGH PERFECTLY INTERCHANGEABLE. REFERENCE NUMBERS, EITHER ORIGINAL OR OF A DIFFERENT NATURE, ARE FOR INFORMATION PURPOSES ONLY. WHEN PLACING AN ORDER, PLEASE, ALWAYS USE COSIBO REFERENCE NUMBERS AND DO NOT MENTION THE ORIGINAL REFERENCE NUMBERS OF THE TRUCK MANUFACTURERS IN THE INVOICE TO VEHICLE OWNERS OR TO ANYBODY ELSE. THE CUSTOMER TAKES HIS OWN RESPONSIBILITY IF HE DOES NOT COMPLY WITH WHAT ABOVE.

	Code	OEM new	OEM old
GASKET SET	64175	550578	550540
● Model			
★ Application			
● 3 BUS			
★ GR801 - GR801R - K113			
● 4 BUS			
★ GR801 - GR801R			
● F-K-N BUS			
★ GR801 - GR801R - GR890 - GR/GRS/GRSH900			
● 3 TRUCK			
★ GR801 - GR801R			
● 4 TRUCK			
★ GR801 - GR801R			
● P-G-R-T TRUCK			
★ GR801 - GR801R - GR/GRS/GRSH900			

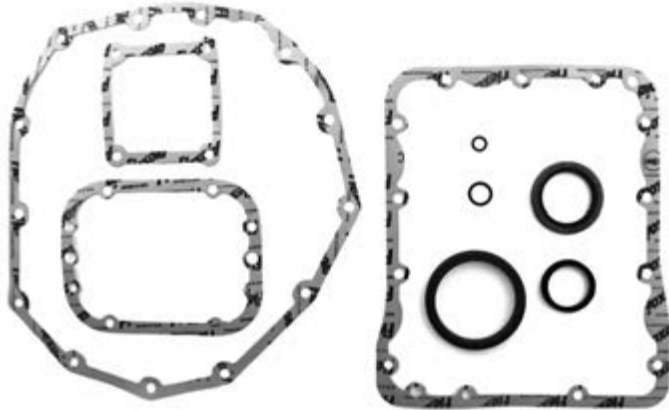

	64311	550577	
GASKET SET			
● 4 BUS			
★ GRS890 - GR/GRS900R - GRSH900R			
● F-K-N BUS			
★ GRS890 - GR/GRS900R - GRSH900R - GR/GRS/GRSH900 - GR801			
● 3 TRUCK			
★ GRS900 - GR900 - GRH900			
● 4 TRUCK			
★ GRS890 - GR/GRS900R - GRSH900R - GR/GRS890R			
● P-G-R-T TRUCK			
★ GRS890 - GR/GRS900R - GRSH900R - GR/GRS/GRSH900 - GR801			

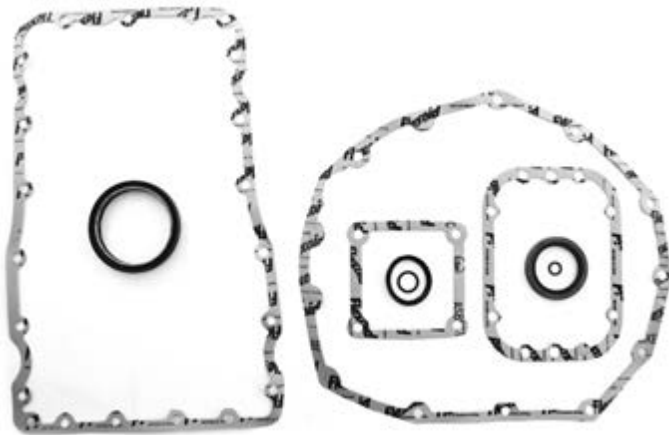

ALL THE COMPONENTS LISTED IN OUR CATALOGUE ARE NOT ORIGINAL, THOUGH PERFECTLY INTERCHANGEABLE. REFERENCE NUMBERS, EITHER ORIGINAL OR OF A DIFFERENT NATURE, ARE FOR INFORMATION PURPOSES ONLY. WHEN PLACING AN ORDER, PLEASE, ALWAYS USE COSIBO REFERENCE NUMBERS AND DO NOT MENTION THE ORIGINAL REFERENCE NUMBERS OF THE TRUCK MANUFACTURERS IN THE INVOICE TO VEHICLE OWNERS OR TO ANYBODY ELSE. THE CUSTOMER TAKES HIS OWN RESPONSIBILITY IF HE DOES NOT COMPLY WITH WHAT ABOVE.

	Code	OEM new	OEM old
O-RING	63388	323451	
<ul style="list-style-type: none"> ● Model ★ Application 			
<ul style="list-style-type: none"> ● 3 TRUCK ★ GA/GAE 770/774 			

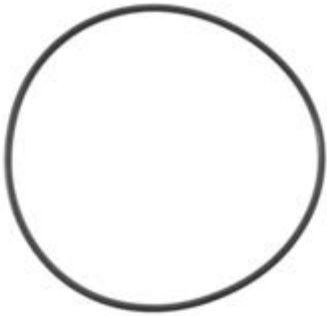

	63554	1484765	1352885
O-RING			
<ul style="list-style-type: none"> ● 4 BUS ★ K114/124 GR801R 			
<ul style="list-style-type: none"> ● F-K-N BUS ★ DC11/12 GR875R - GRS/GRS0895R 			
<ul style="list-style-type: none"> ● 4 TRUCK ★ DC11 GRS890R - GR/GRS900R - DC16 GRS900/920R - GRS/GRS0900/920R - DC12 GR/GRS900R - DC11/12 GRS890R - GR/GRS/GRS0900R 			
<ul style="list-style-type: none"> ● P-G-R-T TRUCK ★ GRS/GRS0900R - GRS920R - DC16 - DC11/12 - DC11/12/13 GR875R - GRS895R - GR/GRS/GRS0905R - DC16 GRS895/905R - GRS0905R 			



	63555	1484766	1352866
O-RING			
<ul style="list-style-type: none"> ● 4 BUS ★ K114/124 GR801R 			
<ul style="list-style-type: none"> ● F-K-N BUS ★ DC11/12 GR875R - GR/GRS0895R 			
<ul style="list-style-type: none"> ● 4 TRUCK ★ DC11 GRS890R - GR/GRS900R - DC16 GRS900/920R - GRS/GRS0900/920R - DC12 GR/GRS900R - DC11/12 GRS890R - GR/GRS/GRS0900R 			
<ul style="list-style-type: none"> ● P-G-R-T TRUCK ★ DC16 GRS/GRS0900/R - GRS920/R - GRS895R/905R - GRS0905R - DC11/12/13 GR875R - GRS0895R - GR/GRS/GRS0905R 			

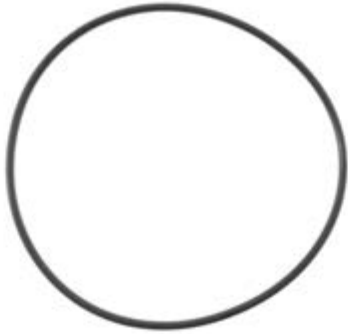

ALL THE COMPONENTS LISTED IN OUR CATALOGUE ARE NOT ORIGINAL, THOUGH PERFECTLY INTERCHANGEABLE. REFERENCE NUMBERS, EITHER ORIGINAL OR OF A DIFFERENT NATURE, ARE FOR INFORMATION PURPOSES ONLY. WHEN PLACING AN ORDER, PLEASE, ALWAYS USE COSIBO REFERENCE NUMBERS AND DO NOT MENTION THE ORIGINAL REFERENCE NUMBERS OF THE TRUCK MANUFACTURERS IN THE INVOICE TO VEHICLE OWNERS OR TO ANYBODY ELSE. THE CUSTOMER TAKES HIS OWN RESPONSIBILITY IF HE DOES NOT COMPLY WITH WHAT ABOVE.

	Code	OEM new	OEM old
O-RING	64778	1331820	
	<ul style="list-style-type: none"> ● Model ★ Application 		
	<ul style="list-style-type: none"> ● 4 BUS ★ GR801R K114/124 		
	<ul style="list-style-type: none"> ● F-K-N BUS ★ GR801/875R - GRS/GRS0895R - GR/GRS/GRS0905R - DC11/DC12 		
	<ul style="list-style-type: none"> ● 3 TRUCK ★ GR/GRS/GRH900 		
	<ul style="list-style-type: none"> ● 4 TRUCK ★ DSC9 - DS19 E01 - DC9 01/02/03/04/05/06 - OSC9 G01 - DSC11 - OSC11 G03 - CP D9/DC9 19/20/21 - CP DC11 01/02/03/04/06/07 - DC12 01/02/03/09/16 - CR94 - CR/CT DSC11 - 8X8 WLS/ZLS CR 124 - CR/CT 124 - CP DSC12 01/02/05 - CP DSC11 74/75/79 - CR 4X4/6X6 - CP DC12 03 - CR/CT DC11 01/02/03/04/06/07 - CP19F FRONTLINE 		
	<ul style="list-style-type: none"> ● P-G-R-T TRUCK ★ GR801/875/900R - GRS890/895R - GRS895/900/905/920R - GRS/GRS0900/905R - DC11/DC12/DC13/DC16 - GR/GRS/GRS0905R - 		

	63562	812418	182525
O-RING			
	<ul style="list-style-type: none"> ● 3 BUS ★ 		
	<ul style="list-style-type: none"> ● 3 TRUCK ★ 		
	<ul style="list-style-type: none"> ● 4 TRUCK ★ 		
	<ul style="list-style-type: none"> ● F-K-N BUS ★ 		
	<ul style="list-style-type: none"> ● P-G-R-T TRUCK ★ 		

ALL THE COMPONENTS LISTED IN OUR CATALOGUE ARE NOT ORIGINAL, THOUGH PERFECTLY INTERCHANGEABLE. REFERENCE NUMBERS, EITHER ORIGINAL OR OF A DIFFERENT NATURE, ARE FOR INFORMATION PURPOSES ONLY. WHEN PLACING AN ORDER, PLEASE, ALWAYS USE COSIBO REFERENCE NUMBERS AND DO NOT MENTION THE ORIGINAL REFERENCE NUMBERS OF THE TRUCK MANUFACTURERS IN THE INVOICE TO VEHICLE OWNERS OR TO ANYBODY ELSE. THE CUSTOMER TAKES HIS OWN RESPONSIBILITY IF HE DOES NOT COMPLY WITH WHAT ABOVE.

SOLENOID VALVE



	Code	OEM new	OEM old
● Model	60304	1488083	1334037 1423566
★ Application			
● 3 BUS			
★ GR801R			
● 4 BUS			
★ GR801R CS/OPTICRUISE - GR/GRS/R			
● 3 TRUCK			
★ GRS900CAG - GRS900R - GR/GRS900R - GRH900			
● 4 TRUCK			
★ GRS890R - GRS920R - GRS0900R - GR/GRSH900R - GR/GRS900R - GR801R & OPTICRUISE - GR/GRS900 - GRS920 - GRSH900 - GR/GRS/GRSH/GRSO/R - GRS/GRSH/GRSO900R - GRS890			
● P-G-R-T TRUCK			
★ GRS890R - GRS920R - GRS900R - GRS0900R			

REPAIR SET FOR OUR 60304



	63754	63754	
● 3 BUS			
★ GR801R			
● 4 BUS			
★ GR801R CS/OPTICRUISE - GR/GRS/R			
● 3 TRUCK			
★ GRS900CAG - GRS900R - GR/GRS900R - GRH900			
● 4 TRUCK			
★ GRS890R - GRS920R - GRS0900R - GR/GRSH900R - GR/GRS900R - GR801R & OPTICRUISE - GR/GRS900 - GRS920 - GRSH900 - GR/GRS/GRSH/GRSO/R - GRS/GRSH/GRSO900R - GRS890			
● P-G-R-T TRUCK			
★ GRS890R - GRS920R - GRS900R - GRS0900R			

ALL THE COMPONENTS LISTED IN OUR CATALOGUE ARE NOT ORIGINAL, THOUGH PERFECTLY INTERCHANGEABLE. REFERENCE NUMBERS, EITHER ORIGINAL OR OF A DIFFERENT NATURE, ARE FOR INFORMATION PURPOSES ONLY. WHEN PLACING AN ORDER, PLEASE, ALWAYS USE COSIBO REFERENCE NUMBERS AND DO NOT MENTION THE ORIGINAL REFERENCE NUMBERS OF THE TRUCK MANUFACTURERS IN THE INVOICE TO VEHICLE OWNERS OR TO ANYBODY ELSE. THE CUSTOMER TAKES HIS OWN RESPONSIBILITY IF HE DOES NOT COMPLY WITH WHAT ABOVE.

REPAIR SET FOR OUR 60304



	Code	OEM new	OEM old
● Model	63755	1364636	
★ Application			
● 3 BUS			
★ GR801R			
● 4 BUS			
★ GR801R CS/OPTICRUISE - GR/GRS/R			
● 3 TRUCK			
★ GRS900CAG - GRS900R - GR/GRS900R - GRH900			
● 4 TRUCK			
★ GRS890R - GRS920R - GRS0900R - GR/GRSH900R - GR/GRS900R - GR801R & OPTICRUISE - GR/GRS900 - GRS920 - GRSH900 - GR/GRS/GRSH/GRSO/R - GRS/GRSH/GRSO900R - GRS890			
● P-G-R-T TRUCK			
★ GRS890R - GRS920R - GRS900R - GRS0900R			

VALVE



	63276	1319557	
● 3 BUS			
★ GR801 - GR801R			
● 4 BUS			
★ GR801R			
● F-K-N BUS			
★ GR/GRS - GR801R			
● 3 TRUCK			
★ GR801/900 - GRH900 - CP/CR 93/113/143 - CT93 - CP/CR/CT 113/143 - CT143 LHD/RHD GR/GRH900 - CR143 LHD/RDH GR900 - GRS900 - CR/CT 113/143 RHD GRS900 - CG/CP/CR RHD GR/GRH900			
● 4 TRUCK			
★ GR900 - CT LHD GR/GRS/GRSH/GRSO900R - GRS920R - CP/CR GR801/900R - GRS890R - CR GRS/GRSH900R - CT RHD GR/GRS900R - GRS890			
● P-G-R-T TRUCK			
★ GR/GRS - CT LHD/RHD			

ALL THE COMPONENTS LISTED IN OUR CATALOGUE ARE NOT ORIGINAL, THOUGH PERFECTLY INTERCHANGEABLE. REFERENCE NUMBERS, EITHER ORIGINAL OR OF A DIFFERENT NATURE, ARE FOR INFORMATION PURPOSES ONLY. WHEN PLACING AN ORDER, PLEASE, ALWAYS USE COSIBO REFERENCE NUMBERS AND DO NOT MENTION THE ORIGINAL REFERENCE NUMBERS OF THE TRUCK MANUFACTURERS IN THE INVOICE TO VEHICLE OWNERS OR TO ANYBODY ELSE. THE CUSTOMER TAKES HIS OWN RESPONSIBILITY IF HE DOES NOT COMPLY WITH WHAT ABOVE.

SOLENOID VALVE



	Code	OEM new	OEM old
● Model	65191	2038653	1536304 1340231 1421322
★ Application			
● 3 BUS			
★	GS771/772 - GR801		
● 4 BUS			
★	OPTICRUISE CS		
● F-K-N BUS			
★	OPTICRUISE CS		
● 3 TRUCK			
★	GS771/772 - GR871 - GR/GRE871 - GR880/T GRH880 - GRS900 - GT800 - CP/CR 93/113 - CT 113 - CR/CT 143		
● 4 TRUCK			
★	OPTICRUISE - GRS/GRSH/GRS0900/R - GRS920/R - GRS890		

SOLENOID VALVE



	65470	2038655	1376794
● P-G-R-T TRUCK			
★	GR/GRS - GR50H901R - EK - OPTICRUISE - PTO EG		
● F-K-N BUS			
★	GR/GRS		

SOLENOID VALVE



	60375	1413047	303470
● 3 BUS			
★	GS771 CAG/CS		
● 3 TRUCK			
★	GS771 CAG - GR871/880 CAG - GR/GRE871 TE70 CAG - GRS900 CAG - GR900 EK330/340 CAG - GR801 CAG - G770 CAG		

ALL THE COMPONENTS LISTED IN OUR CATALOGUE ARE NOT ORIGINAL, THOUGH PERFECTLY INTERCHANGEABLE. REFERENCE NUMBERS, EITHER ORIGINAL OR OF A DIFFERENT NATURE, ARE FOR INFORMATION PURPOSES ONLY. WHEN PLACING AN ORDER, PLEASE, ALWAYS USE COSIBO REFERENCE NUMBERS AND DO NOT MENTION THE ORIGINAL REFERENCE NUMBERS OF THE TRUCK MANUFACTURERS IN THE INVOICE TO VEHICLE OWNERS OR TO ANYBODY ELSE. THE CUSTOMER TAKES HIS OWN RESPONSIBILITY IF HE DOES NOT COMPLY WITH WHAT ABOVE.

OIL COOLER

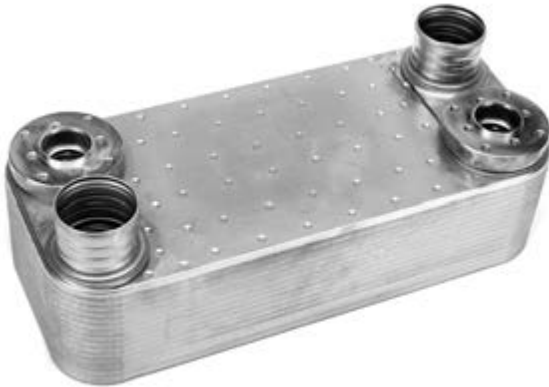

	Code	OEM new	OEM old
● Model	65309	1414200	
★ Application			
● 4 TRUCK			
★	GA750/751R - GA851 - GA852R		
● P-G-R-T TRUCK			
★			

IMPULSE SENSOR







	62530	1852113	1742947
● F-K-N BUS			
★	GR875 GRS/GRS0895 - GR875R		
● 4 TRUCK			
★	GR801/R & OPTICRUISE		
● P-G-R-T TRUCK			
★	GR875 GRS895 GR/GRS/GRS0905 - GR875R GRS895R GR/GRS/GRS0905R		

SPEED SENSOR



	65186	1853436	1111459
● 3 BUS			
★	K113 - GR801R - GR801		
● 4 BUS			
★			
● F-K-N BUS			
★			
● 3 TRUCK			
★	GT811 - GR801 GR/GRS/GRH900 - GR/GRS900R - GR880 GR880/T GRH880 - GR871		
● P-G-R-T TRUCK			
★	GR801		

ALL THE COMPONENTS LISTED IN OUR CATALOGUE ARE NOT ORIGINAL, THOUGH PERFECTLY INTERCHANGEABLE. REFERENCE NUMBERS, EITHER ORIGINAL OR OF A DIFFERENT NATURE, ARE FOR INFORMATION PURPOSES ONLY. WHEN PLACING AN ORDER, PLEASE, ALWAYS USE COSIBO REFERENCE NUMBERS AND DO NOT MENTION THE ORIGINAL REFERENCE NUMBERS OF THE TRUCK MANUFACTURERS IN THE INVOICE TO VEHICLE OWNERS OR TO ANYBODY ELSE. THE CUSTOMER TAKES HIS OWN RESPONSIBILITY IF HE DOES NOT COMPLY WITH WHAT ABOVE.

	Code	OEM new	OEM old
GEARBOX KNOB SWITCH	61624	234387	
	<ul style="list-style-type: none"> ● Model ★ Application 		
	<ul style="list-style-type: none"> ● 3 BUS ★ K113 - GS771/772 		
	<ul style="list-style-type: none"> ● 3 TRUCK ★ CT 93/113 GR871/880 - CG/CP RHD GS771/772 - GR871 - CG/CP LHD GS771/772 - GR871/880 - CP/CR 93 LHD/RHD GR871 - CP 113 LHD GRS771/772 - GR871/880 - CP/CR 113 RHD - CP/CR 113 LHD/RHD 4X4/6X6 GR871 - CR/CT 143 - CR 93 GS771/772 - GR871 - CR 113 LHD GS771/772 - GR871 - CP/CR 113 RHD GS771/772 - GR871 - CR143 GR880 - CT143 GR880T/GRH880 		
SWITCH	61953	1303472	375734
	<ul style="list-style-type: none"> ● 3 TRUCK ★ GR871 - GR/GRE871T CAG - GR880T - GRH880 		
SWITCH	64304	1472738	
	<ul style="list-style-type: none"> ● F-K-N BUS ★ G701 		
SWITCH	63677	1472739	1420005
	<ul style="list-style-type: none"> ● 4 BUS ★ GR801R WITH OPTICRUISE ● F-K-N BUS ★ GR801R WITH OPTICRUISE ● 4 TRUCK ★ GRS890R - GRS/GRSH/GRS0900R - GRS920R - GT/GTD 800/900/901 ● P-G-R-T TRUCK ★ GRS890R - GRS/GRSH/GRS0900R - GRS920R - GT/GTD 800/900/901 		

ALL THE COMPONENTS LISTED IN OUR CATALOGUE ARE NOT ORIGINAL, THOUGH PERFECTLY INTERCHANGEABLE. REFERENCE NUMBERS, EITHER ORIGINAL OR OF A DIFFERENT NATURE, ARE FOR INFORMATION PURPOSES ONLY. WHEN PLACING AN ORDER, PLEASE, ALWAYS USE COSIBO REFERENCE NUMBERS AND DO NOT MENTION THE ORIGINAL REFERENCE NUMBERS OF THE TRUCK MANUFACTURERS IN THE INVOICE TO VEHICLE OWNERS OR TO ANYBODY ELSE. THE CUSTOMER TAKES HIS OWN RESPONSIBILITY IF HE DOES NOT COMPLY WITH WHAT ABOVE.

	Code	OEM new	OEM old
SWITCH	63055	1303471	370710
<ul style="list-style-type: none"> ● Model ★ Application 			
<ul style="list-style-type: none"> ● 3 BUS 			
<ul style="list-style-type: none"> ★ G776 CAG - G776/777 - GS771 CAG - GS771/772 - G770 - K113 - GR801 - GR801R - GR801 CAG - GR/GRS900 CAG 			
<ul style="list-style-type: none"> ● 4 BUS 			
<ul style="list-style-type: none"> ★ GR801R WITH OPTICRUISE 			
<ul style="list-style-type: none"> ● 3 TRUCK 			
<ul style="list-style-type: none"> ★ G770 - G770 CAG - GS771 CAG - GR801 - GR801 CAG - GR871 - GR/GRE871T CAG - GR880 - GR880T - GRH880 - GR900 - GRH900 - GR/GRS900 - GRS900 CAG - GRS900 R - GS771/772 - GT811 - GR801/900 - CP/CR 93/113/143 LHD GR/GRH900 - CT93 - CP/CR/CT 113/143 RHD GR900 - CT RHD GR/GRS900R - CT 143 LHD/RHD GR/GRH900 - CR 143 LHD/RHD GR900 - CP 113 CR/CT 113/143 RHD GRS900 - CG/CP/CR RHD GR/GRH900 - EK300/EK310/EK330/EK340/EK422/EK423 			
<ul style="list-style-type: none"> ● 4 TRUCK 			
<ul style="list-style-type: none"> ★ GRS890R - GRS920R - GRS/GRSH900R - GR/GRS/R WITH OPTICRUISE 			
<ul style="list-style-type: none"> ● P-G-R-T TRUCK 			
<ul style="list-style-type: none"> ★ GRS890R - GRS920R - GRS/GRSH900R 			



	65452	1541086	
SWITCH			
<ul style="list-style-type: none"> ● 4 TRUCK 			
<ul style="list-style-type: none"> ★ GRS890/R - GRS920/R - GRSO900/R - GRS/GRSH900/R 			
<ul style="list-style-type: none"> ● P-G-R-T TRUCK 			
<ul style="list-style-type: none"> ★ GRS890/R - GRS920/R - GRSO900/R 			



	65453	1424221	
CABLE HARNESS			
<ul style="list-style-type: none"> ● 4 TRUCK 			
<ul style="list-style-type: none"> ★ GRS890/R - GRS920/R - GRSO900/R - GRS/GRSH900/R 			
<ul style="list-style-type: none"> ● P-G-R-T TRUCK 			
<ul style="list-style-type: none"> ★ GRS890/R - GRS920/R - GRSO900/R 			



CABLE HARNESS



- Model
- ★ Application

Code

OEM new

OEM old

65454

1549304

- 4 TRUCK

- ★ GRS890/R - GRS920/R - GRS0900/R - GRS/GRSH900/R

- P-G-R-T TRUCK

- ★ GRS890/R - GRS920/R - GRS0900/R

RETARDER SENSOR



- 3 TRUCK

- ★ GR/GRS900

- 4 TRUCK

- ★ GRS890R - GR/GRS900/920R - GR/GRS/GRS0900R

SPEED SENSOR



- 4 BUS

- ★ WITH OPTICRUISE

- 4 TRUCK

- ★ ADR WITH OPTICRUISE

SPEED SENSOR



- F-K-N BUS

- ★ CS WITH OPTICRUISE

- P-G-R-T TRUCK

- ★ ADR WITH OPTICRUISE

ALL THE COMPONENTS LISTED IN OUR CATALOGUE ARE NOT ORIGINAL, THOUGH PERFECTLY INTERCHANGEABLE. REFERENCE NUMBERS, EITHER ORIGINAL OR OF A DIFFERENT NATURE, ARE FOR INFORMATION PURPOSES ONLY. WHEN PLACING AN ORDER, PLEASE, ALWAYS USE COSIBO REFERENCE NUMBERS AND DO NOT MENTION THE ORIGINAL REFERENCE NUMBERS OF THE TRUCK MANUFACTURERS IN THE INVOICE TO VEHICLE OWNERS OR TO ANYBODY ELSE. THE CUSTOMER TAKES HIS OWN RESPONSIBILITY IF HE DOES NOT COMPLY WITH WHAT ABOVE.

	Code	OEM new	OEM old
RELAY	63447	2077837	1431781 1391322 243460
<ul style="list-style-type: none"> ● Model ★ Application 			
<ul style="list-style-type: none"> ● 4 TRUCK ★ ALLISON GA750 - 750/R - GA751 751/R - GA851 851/R - GA852 852/R LHD/RHD 			



	63793	1881850	
OPTICRUISE REPAIR SET			
<ul style="list-style-type: none"> ● 4 BUS ★ 			
<ul style="list-style-type: none"> ● 4 TRUCK ★ 94 - 114 - 124 - 144 - 164 			
<ul style="list-style-type: none"> ● F-K-N BUS ★ 			
<ul style="list-style-type: none"> ● P-G-R-T TRUCK ★ 			

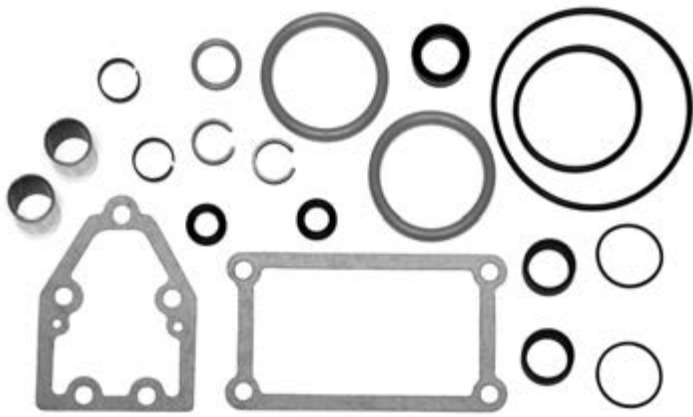

	65534	1523635	
OPTICRUISE SHAFT			
<ul style="list-style-type: none"> ● 4 BUS ★ 			
<ul style="list-style-type: none"> ● 4 TRUCK ★ 94-114-124-144-164 			
<ul style="list-style-type: none"> ● F-K-N BUS ★ 			
<ul style="list-style-type: none"> ● P-G-R-T TRUCK ★ 			



ALL THE COMPONENTS LISTED IN OUR CATALOGUE ARE NOT ORIGINAL, THOUGH PERFECTLY INTERCHANGEABLE. REFERENCE NUMBERS, EITHER ORIGINAL OR OF A DIFFERENT NATURE, ARE FOR INFORMATION PURPOSES ONLY. WHEN PLACING AN ORDER, PLEASE, ALWAYS USE COSIBO REFERENCE NUMBERS AND DO NOT MENTION THE ORIGINAL REFERENCE NUMBERS OF THE TRUCK MANUFACTURERS IN THE INVOICE TO VEHICLE OWNERS OR TO ANYBODY ELSE. THE CUSTOMER TAKES HIS OWN RESPONSIBILITY IF HE DOES NOT COMPLY WITH WHAT ABOVE.

SEAL 25x35x7



	Code	OEM new	OEM old
● Model	63570	329638	
★ Application			
● 3 BUS			
★ GR801 CAG - GR/GRS900 CAG - G770 - K113 - GS771/772 - G776/777 - GR801 - GR801R - GS771 CAG			
● 4 BUS			
★ GR801R			
● F-K-N BUS			
★ GR801R			
● 3 TRUCK			
★ GR801 CAG - GR801/900 - GRH900 - GR/GRS900 CAG - GRS900 - CT93/113 - CG/CP/CR 93 LHD/RHD - CG/CP 113 LHD - CP/CR 113 RHD 4X4/6X6 - CP/CR 113 LHD 4X4/6X4/6X6 - CR 143 LHD/RHD GR/GRH880 - CP/CR 93/113/143 LHD GR/GRH900 - CT93 - CP/CR/CT 113/143 RHD GR900 - CT143 LHD/RHD GR/GRH900 - CP/CR93 RHD - CP113 - CR/CT 113/143 RHD GRS900 - CG/CP/CR RHD GR/GRH900 - CR143 RHD GR900 - CT143 GR880T/GRH880			
● 4 TRUCK			
★ CP/CR GR801/900R GRS890R - CR GRS/GRSH900R GRS920R - CT LHD GR/GRS/GRSH/GRSO900R - CT RHD GR/GRS900R			
● P-G-R-T TRUCK			
★ CT LHD/RHD			

BUSHING



	61496	244780	
● 3 BUS			
★ GR801 CAG - GR/GRS900 CAG - K113 - GS771/772 - G776/777 - GS771 CAG			
● 4 BUS			
★ OPTICRUISE			
● F-K-N BUS			
★ GR875R GRS895R GR/GRS/GRSO905R WITH OPTICRUISE - G670			
● 3 TRUCK			
★ GR801 CAG - GR/GRS900 CAG - GR871 - GR871/880 CAG - GR/GRE871 - GR880T - GRH880			
● 4 TRUCK			
★ CP/CR GR801/900R GRS890R - CR GRS/GRH900R GRS920R - CT LHD GR/GRS/GRSH/GRSO900R - OPTICRUISE			
● P-G-R-T TRUCK			
★ GR875R GRS895R GR/GRS/GRSO905R WITH OPTICRUISE - G670 - CT LHD			

ALL THE COMPONENTS LISTED IN OUR CATALOGUE ARE NOT ORIGINAL, THOUGH PERFECTLY INTERCHANGEABLE. REFERENCE NUMBERS, EITHER ORIGINAL OR OF A DIFFERENT NATURE, ARE FOR INFORMATION PURPOSES ONLY. WHEN PLACING AN ORDER, PLEASE, ALWAYS USE COSIBO REFERENCE NUMBERS AND DO NOT MENTION THE ORIGINAL REFERENCE NUMBERS OF THE TRUCK MANUFACTURERS IN THE INVOICE TO VEHICLE OWNERS OR TO ANYBODY ELSE. THE CUSTOMER TAKES HIS OWN RESPONSIBILITY IF HE DOES NOT COMPLY WITH WHAT ABOVE.

	Code	OEM new	OEM old
BUSHING	65179	283650	
● Model			
★ Application			
● 3 BUS			
★ K 113			
● 3 TRUCK			
★ GR/GRS900			
● 4 BUS			
★			
● 4 TRUCK			
★			
● F-K-N BUS			
★ G670 - GR875R - GRS/GRS0895R			
● P-G-R-T TRUCK			
★ GR875R - GRS895R - GR/GRS/GRS0905R - G670			



	62228	1345492	
RUBBER BOOT			
● 3 BUS			
★ GR801R			
● 4 BUS			
★ GR801R			
● F-K-N BUS			
★ GR801R			
● 3 TRUCK			
★ GR801/900 - GRH900 - GRS900 - CP/CR 93/113/143 LHD GR/GRH900 - CP113 - CR/CT 113/143 RHD GRS900 - CG/CP/CR RHD GR/GRH900 - CR143 RHD GR900			
● 4 TRUCK			
★ CP/CR GR801/900R GRS890R - CR GRS/GRSH900R GRS920R - CT LHD GR/GRS/GRSH/GRS0900R			
● P-G-R-T TRUCK			
★ CT LHD			



CYLINDER HOUSING



- Model
- ★ Application

Code

OEM new

OEM old

62526

284015

- 3 TRUCK

- ★ GR871 - GR871/880 - CAG - GR/GRE871 - GR880/T - GRH880

	Code	OEM new	OEM old
GEAR	63262	1114838	244536
● Model			
★ Application			
● 3 TRUCK			
★ GR871 - GR/GRE871T - GRH880 - GR880T			



INPUT SHAFT	63005	294904	294903
● 3 TRUCK			
★ GR871			



SYNCHRONIZING RING	63241	184490	
● 3 TRUCK			
★ GR871 - GR/GRE871T - GR880T - GR/GRH880			



ALL THE COMPONENTS LISTED IN OUR CATALOGUE ARE NOT ORIGINAL, THOUGH PERFECTLY INTERCHANGEABLE. REFERENCE NUMBERS, EITHER ORIGINAL OR OF A DIFFERENT NATURE, ARE FOR INFORMATION PURPOSES ONLY. WHEN PLACING AN ORDER, PLEASE, ALWAYS USE COSIBO REFERENCE NUMBERS AND DO NOT MENTION THE ORIGINAL REFERENCE NUMBERS OF THE TRUCK MANUFACTURERS IN THE INVOICE TO VEHICLE OWNERS OR TO ANYBODY ELSE. THE CUSTOMER TAKES HIS OWN RESPONSIBILITY IF HE DOES NOT COMPLY WITH WHAT ABOVE.

	Code	OEM new	OEM old
RING	63253	254333	
<ul style="list-style-type: none"> ● Model ★ Application 			
<ul style="list-style-type: none"> ● 3 TRUCK ★ GR871 - GR/GRE871T - GR880T - GR/GRH880 			



G.B.COVER	61634	315002	
<ul style="list-style-type: none"> ● 2 TRUCK ★ GRS870/870T 			
<ul style="list-style-type: none"> ● 3 TRUCK ★ GR871/871T 			



SLEEVE	61764	1103619	
<ul style="list-style-type: none"> ● 3 TRUCK ★ G770 - G770 CAG - GS771 CAG - GS771/772 - GR871 - GR871 - GR/GRE871T CAG - GR871 - GR/GRE871T - GR880 - GR880T - GRH880 			
<ul style="list-style-type: none"> ● 3 BUS ★ G770 - G776 CAG - G776/777 - GS771 CAG - GS771/772 			



	Code	OEM new	OEM old
SLEEVE	62461	1103934	
<ul style="list-style-type: none"> ● Model ★ Application 			
<ul style="list-style-type: none"> ● 3 TRUCK ★ GR801R - GR801 			
<ul style="list-style-type: none"> ● 4 TRUCK ★ GR801R 			
<ul style="list-style-type: none"> ● 3 BUS ★ GR801R - GR801 - K113 			
<ul style="list-style-type: none"> ● 4 BUS ★ GR801R 			



	60015	315060	
OIL TUBE			
<ul style="list-style-type: none"> ● 3 TRUCK ★ GR801R - G770 - G770 CAG - GS771 CAG - GS771/772 - GR871R - GR871 - GR/GRE871T - GR880T - GRH880 - GR880 - GR/GRS900R 			
<ul style="list-style-type: none"> ● 4 TRUCK ★ GR801R - GR900R - GSR0900R - GRS/GRSH900R - GRS920R - GRS890R 			
<ul style="list-style-type: none"> ● P-G-R-T TRUCK ★ GR801R - GR/GRS900R - GRS890R - GRS920R - GRS0900R 			
<ul style="list-style-type: none"> ● 3 BUS ★ G770/776/777 - G776 CAG - GS771 CAG - GS771/772 - GR801R 			
<ul style="list-style-type: none"> ● 4 BUS ★ GR801R 			
<ul style="list-style-type: none"> ● F-K-N BUS ★ GR801R 			



	61494	1372543	335683
BUSHING			
<ul style="list-style-type: none"> ● 3 BUS ★ G776/777 - GS771/772 			
<ul style="list-style-type: none"> ● 3 TRUCK ★ GR871 - GR/GRE871T - GR880T - GRH880 - GS771/772 			



ALL THE COMPONENTS LISTED IN OUR CATALOGUE ARE NOT ORIGINAL, THOUGH PERFECTLY INTERCHANGEABLE. REFERENCE NUMBERS, EITHER ORIGINAL OR OF A DIFFERENT NATURE, ARE FOR INFORMATION PURPOSES ONLY. WHEN PLACING AN ORDER, PLEASE, ALWAYS USE COSIBO REFERENCE NUMBERS AND DO NOT MENTION THE ORIGINAL REFERENCE NUMBERS OF THE TRUCK MANUFACTURERS IN THE INVOICE TO VEHICLE OWNERS OR TO ANYBODY ELSE. THE CUSTOMER TAKES HIS OWN RESPONSIBILITY IF HE DOES NOT COMPLY WITH WHAT ABOVE.

	Code	OEM new	OEM old
OIL SEAL 55X75X9	63128	1318388	
● Model			
★ Application			
● 3 TRUCK			
★ GR801 - GR801R - GR900 - GR900R - GRS900 - GRS900R - GR/GRS/GRH900			
● 4 TRUCK			
★ GR801R - GRS890 - GR/GRS900R - GRSH900R - GR900R - GRSO900R - GRS/GRSH900R - GRS920R - GRS890R			
● P-G-R-T TRUCK			
★ GR801R - GRS890 - GR/GRS900R - GRSH900R - GR900R - GRS890R - GRS920R - GRSO900R			
● 3 BUS			
★ GR801R			
● 4 BUS			
★ GR801R - GRS890 - GR/GRS900R - GRSH900R			
● F-K-N BUS			
★ GR801R - GRS890 - GR/GRS900R - GRSH900R			



	61025	388528	314063
OIL SEAL 45X65X10			
● 3 TRUCK			
★ G770 - GS771 CAG - GS771/772 - GR871 - GR/GRE871T - GR871 - GR/GRE871T CAG - GR880T - GRH880 -			
● 3 BUS			
★ G770/776/777 - G776 CAG - GS771 CAG - GS771/772			



	61026	338643	275591
OIL SEAL 80x100x12			
● 3 TRUCK			
★ GR871 - GR/GRE871T - GR871 - GR/GRE871T CAG - GR871			



ALL THE COMPONENTS LISTED IN OUR CATALOGUE ARE NOT ORIGINAL, THOUGH PERFECTLY INTERCHANGEABLE. REFERENCE NUMBERS, EITHER ORIGINAL OR OF A DIFFERENT NATURE, ARE FOR INFORMATION PURPOSES ONLY. WHEN PLACING AN ORDER, PLEASE, ALWAYS USE COSIBO REFERENCE NUMBERS AND DO NOT MENTION THE ORIGINAL REFERENCE NUMBERS OF THE TRUCK MANUFACTURERS IN THE INVOICE TO VEHICLE OWNERS OR TO ANYBODY ELSE. THE CUSTOMER TAKES HIS OWN RESPONSIBILITY IF HE DOES NOT COMPLY WITH WHAT ABOVE.

	Code	OEM new	OEM old
MAGNETIC PLUG	61371	235434	153682
● Model			
★ Application			
● 3 BUS			
★ G770/776/777 - GS771/772			
● 3 TRUCK			
★ G770 - GS771/772 - GR871 GR/GRE871T - GR880T - GR/GRH880			



	64074	358404	
V4 OIL SEAL 73X85X6.6			
● 3 TRUCK			
★ GR880T - GRH880 - GR880 - GR900R - GR801 - GR801R			
● 4 TRUCK			
★ GR900R			
● 3 BUS			
★ GR801R			





	64080	378613	
GEARBOX V RING			
● 3 TRUCK			
★ GR801 - GR801/R - GR900 - GR900/R - GRS900 - GRS900/R - GR/GRS/GRH900			
● 4 TRUCK			
★ GR801/GRS890 - GR/GRS900/R - GRS/GRSH900/R - GRS920/R - GRS890/R			
● P-G-R-T TRUCK			
★ GRS890 - GR/GRS900/R - GRSH900/R			
● 3 BUS			
★ - GR801 - GR801/R - K 113			
● 4 BUS			
★ GR801/RGRS890 - GR/GRS900/R - GRSH900/R			
● F-K-N BUS			
★ GR801/R - GRS890 - GR/GRS900/R - GRSH900/R			



ALL THE COMPONENTS LISTED IN OUR CATALOGUE ARE NOT ORIGINAL, THOUGH PERFECTLY INTERCHANGEABLE. REFERENCE NUMBERS, EITHER ORIGINAL OR OF A DIFFERENT NATURE, ARE FOR INFORMATION PURPOSES ONLY. WHEN PLACING AN ORDER, PLEASE, ALWAYS USE COSIBO REFERENCE NUMBERS AND DO NOT MENTION THE ORIGINAL REFERENCE NUMBERS OF THE TRUCK MANUFACTURERS IN THE INVOICE TO VEHICLE OWNERS OR TO ANYBODY ELSE. THE CUSTOMER TAKES HIS OWN RESPONSIBILITY IF HE DOES NOT COMPLY WITH WHAT ABOVE.

	Code	OEM new	OEM old
RETARDER OIL FILTER	62361	1381235	1329876
	<ul style="list-style-type: none"> ● Model ★ Application 		
	<ul style="list-style-type: none"> ● P-G-R-T TRUCK ★ GR875R - GRS895R - GR/GRS/GRSO905R 		
	<ul style="list-style-type: none"> ● F-K-N BUS ★ GR875R - GRS/GRSO895R 		

	64408	804664	
O-RING			
	<ul style="list-style-type: none"> ● 3 BUS ★ GR801R 		
	<ul style="list-style-type: none"> ● 3 TRUCK ★ GS771/772 - GRS900 CAG 		
	<ul style="list-style-type: none"> ● 4 TRUCK ★ GRSH900R - GR801/900R GRS890R CP/CR - GRS/GRSH900R/GRS920R CR - GR/GRS/GRSH/GRSO900R CT 		
	<ul style="list-style-type: none"> ● F-K-N BUS ★ GR801R 		

	64409	1328242	
O-RING			
	<ul style="list-style-type: none"> ● 3 TRUCK ★ GA850R 		
	<ul style="list-style-type: none"> ● 4 BUS ★ OPTICRUISE CS 		
	<ul style="list-style-type: none"> ● 4 TRUCK ★ GA750/751R - GA851/852R - OPTICRUISE AND ADR 		
	<ul style="list-style-type: none"> ● F-K-N BUS ★ OPTICRUISE CS 		
	<ul style="list-style-type: none"> ● P-G-R-T TRUCK ★ OPTICRUISE 		

ALL THE COMPONENTS LISTED IN OUR CATALOGUE ARE NOT ORIGINAL, THOUGH PERFECTLY INTERCHANGEABLE. REFERENCE NUMBERS, EITHER ORIGINAL OR OF A DIFFERENT NATURE, ARE FOR INFORMATION PURPOSES ONLY. WHEN PLACING AN ORDER, PLEASE, ALWAYS USE COSIBO REFERENCE NUMBERS AND DO NOT MENTION THE ORIGINAL REFERENCE NUMBERS OF THE TRUCK MANUFACTURERS IN THE INVOICE TO VEHICLE OWNERS OR TO ANYBODY ELSE. THE CUSTOMER TAKES HIS OWN RESPONSIBILITY IF HE DOES NOT COMPLY WITH WHAT ABOVE.

	Code	OEM new	OEM old
O-RING	64410	1304914	
<ul style="list-style-type: none"> ● Model ★ Application 			
<ul style="list-style-type: none"> ● 3 BUS 			
<ul style="list-style-type: none"> ★ GR801 - GR801R - K113 			
<ul style="list-style-type: none"> ● 3 TRUCK 			
<ul style="list-style-type: none"> ★ GR/GRS900 - GR/GRS900R - GRH900 - GRS900 - GR801 - GR801R - GRS900 CAG 			
<ul style="list-style-type: none"> ● 4 BUS 			
<ul style="list-style-type: none"> ★ GR801R 			
<ul style="list-style-type: none"> ● 4 TRUCK 			
<ul style="list-style-type: none"> ★ GRSO900R - GR801R - GRS890 - GRS890R - GR/GRS900 - GR/GRS900R - GRS920R - GRSH900R 			
<ul style="list-style-type: none"> ● F-K-N BUS 			
<ul style="list-style-type: none"> ★ GR801R 			
<ul style="list-style-type: none"> ● P-G-R-T TRUCK 			
<ul style="list-style-type: none"> ★ GR801R - GRS890R - GRS900/920R - GR900R - GRSO900R 			



	Code	OEM new	OEM old
O-RING	64411	1349018	
<ul style="list-style-type: none"> ● F-K-N BUS 			
<ul style="list-style-type: none"> ★ GR875R - GRS/GRSO895R - GR/GRS/GRSO905R 			
<ul style="list-style-type: none"> ● P-G-R-T TRUCK 			
<ul style="list-style-type: none"> ★ GR875R - GRS895R - GR/GRS/GRSO905R - GRSO925R 			



ALL THE COMPONENTS LISTED IN OUR CATALOGUE ARE NOT ORIGINAL, THOUGH PERFECTLY INTERCHANGEABLE. REFERENCE NUMBERS, EITHER ORIGINAL OR OF A DIFFERENT NATURE, ARE FOR INFORMATION PURPOSES ONLY. WHEN PLACING AN ORDER, PLEASE, ALWAYS USE COSIBO REFERENCE NUMBERS AND DO NOT MENTION THE ORIGINAL REFERENCE NUMBERS OF THE TRUCK MANUFACTURERS IN THE INVOICE TO VEHICLE OWNERS OR TO ANYBODY ELSE. THE CUSTOMER TAKES HIS OWN RESPONSIBILITY IF HE DOES NOT COMPLY WITH WHAT ABOVE.

	Code	OEM new	OEM old
RING NUT	64071	1461414	1114622
<ul style="list-style-type: none"> ● Model ★ Application 			
<ul style="list-style-type: none"> ● 3 BUS 			
<ul style="list-style-type: none"> ★ GR801 - GR801/R 			
<ul style="list-style-type: none"> ● 4 BUS 			
<ul style="list-style-type: none"> ★ GR801/R - GR801 			
<ul style="list-style-type: none"> ● F-K-N BUS 			
<ul style="list-style-type: none"> ★ GR801/R - GRS/GRS0895/R 			
<ul style="list-style-type: none"> ● 3 TRUCK 			
<ul style="list-style-type: none"> ★ GRS900/R - GRH900 - GR900/R - GR801 - GR801/R 			
<ul style="list-style-type: none"> ● 4 TRUCK 			
<ul style="list-style-type: none"> ★ GRS900/R - GRS0900/R - RGS/GRSH900/R - GRS920/R - GRS890/R - GR801/R - GRS890/R 			
<ul style="list-style-type: none"> ● P-G-R-T TRUCK 			
<ul style="list-style-type: none"> ★ GR801/R - GRS890R - GR900/R - GRS900/920/R - GRS0900/R - GRS895/R - GRS/GRS0905/R 			



LOCK NUT	65091	315085	
<ul style="list-style-type: none"> ● 3 BUS 			
<ul style="list-style-type: none"> ★ G770 G776 G777 - G776 CAG - GA775/781R - GS771 CAG - GS771/772 - GA-V771R GAV773R GAV781R GAV783R 			
<ul style="list-style-type: none"> ● 3 TRUCK 			
<ul style="list-style-type: none"> ★ G770 - G770 CAG - GS771/772 - GR871 			



	Code	OEM new	OEM old
LOCK NUT	60836	1525988	387877
● Model			
★ Application			
● 3 BUS			
★ K 113 GR801 - K 93/113 L 113 P40/400/50/500 GR801R -			
● 3 TRUCK			
★ P300/400/500/600 93/143 - GR871 GR/GRE871T - GRH880 - GR771 - GR880/880T - GA/GAE770/774			
● 4 BUS			
★ P300/400 GR801R			
● 4 TRUCK			
★			
● F-K-N BUS			
★ P602			
● P-G-R-T TRUCK			
★ P602			



	60047	284843	
BEARING			
● 3 BUS			
★ G770 - G776 - G776 CAG - G777 - GS771 CAG - GS771/772			
● 3 TRUCK			
★ G770 - G770 CAG - GS771 CAG - GS771/772 - GR871 - GR/GRE871T			



	60249	338706	
SYNCHRO ASSY			
● 3 TRUCK			
★ GR871 - GR/GRE871T CAG - GR/GRE871T			



ALL THE COMPONENTS LISTED IN OUR CATALOGUE ARE NOT ORIGINAL, THOUGH PERFECTLY INTERCHANGEABLE. REFERENCE NUMBERS, EITHER ORIGINAL OR OF A DIFFERENT NATURE, ARE FOR INFORMATION PURPOSES ONLY. WHEN PLACING AN ORDER, PLEASE, ALWAYS USE COSIBO REFERENCE NUMBERS AND DO NOT MENTION THE ORIGINAL REFERENCE NUMBERS OF THE TRUCK MANUFACTURERS IN THE INVOICE TO VEHICLE OWNERS OR TO ANYBODY ELSE. THE CUSTOMER TAKES HIS OWN RESPONSIBILITY IF HE DOES NOT COMPLY WITH WHAT ABOVE.

	Code	OEM new	OEM old
OIL SEAL 68X80X8	61198	315022	
<ul style="list-style-type: none"> ● Model ★ Application 			
<ul style="list-style-type: none"> ● 3 BUS 			
<ul style="list-style-type: none"> ★ G770/776/777 - GS771/772 			
<ul style="list-style-type: none"> ● 3 TRUCK 			
<ul style="list-style-type: none"> ★ G770 - GS771/772 - GR871 - GR/GRE871T 			



OIL SEAL 50X40X8	61214	315270	
<ul style="list-style-type: none"> ● 3 BUS 			
<ul style="list-style-type: none"> ★ G770/776/777 - GS771/772 			
<ul style="list-style-type: none"> ● 3 TRUCK 			
<ul style="list-style-type: none"> ★ G770 - GS771/772 - GR871 - GR/GRE871T - GR880T - GRH880 - GR880 			



O-RING 200X3	61215	194414	
<ul style="list-style-type: none"> ● 3 BUS 			
<ul style="list-style-type: none"> ★ G770/776/777 - GS771/772 			
<ul style="list-style-type: none"> ● 3 TRUCK 			
<ul style="list-style-type: none"> ★ G770 - GS771/772 - GR871 - GR/GRE871T - GR880T - GRH880 - GR880 			

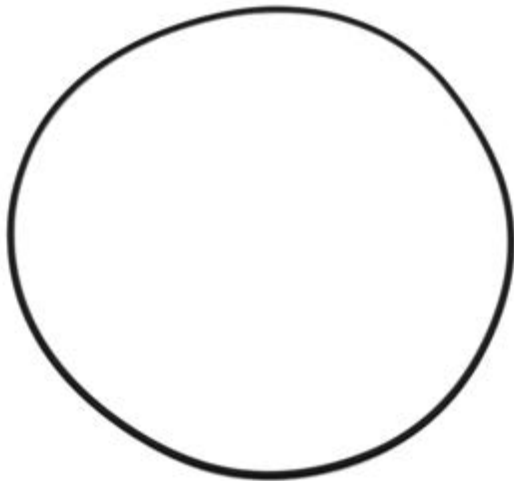

REPAIR SET



- Model
- ★ Application

Code

OEM new

OEM old

63621

63621

- 3 BUS

- ★ G770 - G776/777 - GS771/772 COMPOSED BY: N.1 PC 61214 - N.1 PC 61215 - N.1 PC 61025

- 3 TRUCK

- ★ G770 - GS771/772 - GR871 - GR/GRE871T - GR880T - GRH880 - GR880 COMPOSED BY: N.1 PC 61214 - N.1 PC 61215 - N.1 PC 61025

OIL SEAL 85x105x13/18 (FOR SHAFT WITH CLOCKWISE ROTATION)

63330

1502384

1300974
1380160
1393331

- 3 TRUCK

- ★ 93/143 P300/400/500/600

- 4 TRUCK

- ★ GR801R - GRS890 - GR/GRS900/R - GRSH900/R

- P-G-R-T TRUCK

- ★ GR801R - GRS890 - GR/GRS900/R - GRSH900/R - P602 - GR875 - GRS895 - GR/GRS/GRS0905 - GR875 - GRS895 - GR/GRS/GRS0905 - GR875R - GRS895R - GR/GRS/GRS0905R

- 3 BUS

- ★ K113 GR801 - K93/113 L113 - P40/400/50/500 GR801R

- 4 BUS

- ★ GR801R - GRS890 - GR/GRS900/R - GRSH900/R - GR801R P300/400

- F-K-N BUS

- ★ GR801R - GRS890 - GR/GRS900/R - GRSH900/R - P602 - GR875 - GRS895 - GR/GRS/GRS0905 - GR875 - GRS/GRS0895 - GR875R - GRS/GRS0895R

CONTROL CYLINDER



	Code	OEM new	OEM old
● Model	62469	1484808	1321420 1484807
★ Application			

● 3 TRUCK
★ GR801 - GR/GRS900 - GRH900 - GR/GRS900/R
● 4 TRUCK
★ GR900 - GRS - GRSH - GRS0900/R - GRS920/R - GRS890
● 3 BUS
★ GR801/R
● 4 BUS
★ GR/GRS/R

CONTROL CYLINDER



	Code	OEM new	OEM old
	62470	1484809	1345151

● 3 TRUCK
★ GR801 - GR/GRS900 - TE70 - GRH900 - GR/GRS900R
● 4 TRUCK
★ GR900 - GR - GRSH - GRS0900/R - GRS920/R - GRS890 - OPTICRUISE
● P-G-R-T TRUCK
★ ALSO FOR
● 3 BUS
★ GR801/R - GR801 - K113
● 4 BUS
★ GR - GRS/R - OPTICRUISE CH 1843282 - CH 1843283 - CH 1830944
● F-K-N BUS
★

SLIDING



	Code	OEM new	OEM old
	61333	244090	

● 3 BUS
★ G770/776/777 - GS771/772
● 3 TRUCK
★ G770 - GS771/772 - GR871 - GR/GRE871T

ALL THE COMPONENTS LISTED IN OUR CATALOGUE ARE NOT ORIGINAL, THOUGH PERFECTLY INTERCHANGEABLE. REFERENCE NUMBERS, EITHER ORIGINAL OR OF A DIFFERENT NATURE, ARE FOR INFORMATION PURPOSES ONLY. WHEN PLACING AN ORDER, PLEASE, ALWAYS USE COSIBO REFERENCE NUMBERS AND DO NOT MENTION THE ORIGINAL REFERENCE NUMBERS OF THE TRUCK MANUFACTURERS IN THE INVOICE TO VEHICLE OWNERS OR TO ANYBODY ELSE. THE CUSTOMER TAKES HIS OWN RESPONSIBILITY IF HE DOES NOT COMPLY WITH WHAT ABOVE.

	Code	OEM new	OEM old
SLIDER	63389	1305676	
● Model			
★ Application			
● 3 BUS			
★ K113 - GR801R			
● 3 TRUCK			
★ GR801 - GR/GRH/GRS900			
● 4 BUS			
★ GR801R			
● 4 TRUCK			
★ GR/GRS/GRSO/R - GRS890R - GR801R - GR/GRS900/R - GR/GRS920/R - GRSH900/R			
● F-K-N BUS			
★			
● P-G-R-T TRUCK			
★			



	63331	1472144	804666
O-RING			
● 3 TRUCK			
★ GRS900 - GRS900/R - GR801 - GR/GRS900R - GRH900 - GR801/900 - GRH900 - CP/CR93/113/143 - LHD - GR/GRH900 - CT93 - CP/CR/CT 113/143 - RHD - GR900 - GRS900 - CT 143 - LHD - GR/GRH900 - CT 143 - RHD - GR/GRH900 - CR 143 - LHD - GR900 - CG/CP/CR - RHD - GR/GRH900			
● 4 TRUCK			
★ GRS890/R - GRS920/R - GRS/GRSH900/R - OPTICRUISE - CT - RHD - GR/GRS900/R			
● P-G-R-T TRUCK			
★ GRS895/905/R - GRS0905/R - OPTICRUISE - GRS890/R - GRS920/R - GRS900/R - GRS0900/R - CT - RHD - GR875/R - GRS895/R - GR/GRS/GRSO905/R - OPTICRUISE			
● 3 BUS			
★ GR801/R - GR801 - K113			
● 4 BUS			
★ GR801/R - GR/GRS/R - OPTICRUISE			
● F-K-N BUS			
★ GRS895/905/R - GRS0905/R - OPTICRUISE - XPI - K D11/D12 - GR875/R - GRS/GRS0895/R - OPTICRUISE - GR801/R - K UD6X2			



	Code	OEM new	OEM old
O-RING	63332	1474732	804674
<ul style="list-style-type: none"> ● Model ★ Application 			
<ul style="list-style-type: none"> ● 3 TRUCK ★ GS771/772 - GR801 - GR/GRS900/R - GRH900 - POWER TAKEOFF EK300 - EK310 			
<ul style="list-style-type: none"> ● 4 TRUCK ★ OPTICRUISE - POWER TAKEOFF EK300 - EK310 			
<ul style="list-style-type: none"> ● P-G-R-T TRUCK ★ OPTICRUISE 			
<ul style="list-style-type: none"> ● 3 BUS ★ GS771/772 - GR801/R - K113 			
<ul style="list-style-type: none"> ● 4 BUS ★ GR801/R - GR/GRS/R - OPTICRUISE 			
<ul style="list-style-type: none"> ● F-K-N BUS ★ OPTICRUISE - GR801/R 			



	63333	1472142	804713
O-RING			
<ul style="list-style-type: none"> ● 3 TRUCK ★ GR801 - GR/GRS900/R - GRH900 			
<ul style="list-style-type: none"> ● 4 TRUCK ★ OPTICRUISE 			
<ul style="list-style-type: none"> ● P-G-R-T TRUCK ★ OPTICRUISE 			
<ul style="list-style-type: none"> ● 3 BUS ★ GR801/R - K113 			
<ul style="list-style-type: none"> ● 4 BUS ★ GR801 - GR/GRS/R - OPTICRUISE 			
<ul style="list-style-type: none"> ● F-K-N BUS ★ OPTICRUISE - GR801/R 			

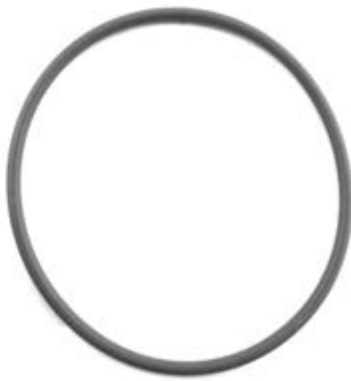

O-RING 200X5

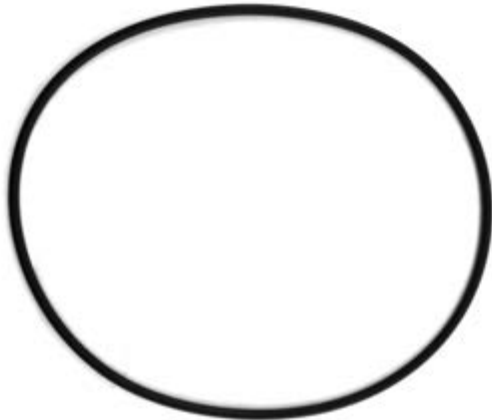

	Code	OEM new	OEM old
● Model	61643	1309563	
★ Application			
● 3 BUS			
★ G770			
● 3 TRUCK			
★ G770 - GR871 - GR/GRE871T - GR880T - GRH880 - GS771/772			

OIL SCRAPER RING



	63334	1515869	1315437
● 3 TRUCK			
★ GR801 - GR/GRS900/R - GRH900			
● 4 TRUCK			
★ OPTICRUISE			
● P-G-R-T TRUCK			
★ OPTICRUISE			
● 3 BUS			
★ GR801/R - K113			
● 4 BUS			
★ GR801/R - GR/GRS/R - OPTICRUISE			
● F-K-N BUS			
★ GR801/R - OPTICRUISE			

ALL THE COMPONENTS LISTED IN OUR CATALOGUE ARE NOT ORIGINAL, THOUGH PERFECTLY INTERCHANGEABLE. REFERENCE NUMBERS, EITHER ORIGINAL OR OF A DIFFERENT NATURE, ARE FOR INFORMATION PURPOSES ONLY. WHEN PLACING AN ORDER, PLEASE, ALWAYS USE COSIBO REFERENCE NUMBERS AND DO NOT MENTION THE ORIGINAL REFERENCE NUMBERS OF THE TRUCK MANUFACTURERS IN THE INVOICE TO VEHICLE OWNERS OR TO ANYBODY ELSE. THE CUSTOMER TAKES HIS OWN RESPONSIBILITY IF HE DOES NOT COMPLY WITH WHAT ABOVE.

	Code	OEM new	OEM old
O-RING	63335	1472145	1303798
<ul style="list-style-type: none"> ● Model ★ Application 			
<ul style="list-style-type: none"> ● 3 TRUCK 			
<ul style="list-style-type: none"> ★ GR801 - GR/GRS900/R - GRH900 			
<ul style="list-style-type: none"> ● 4 TRUCK 			
<ul style="list-style-type: none"> ★ OPTICRUISE 			
<ul style="list-style-type: none"> ● P-G-R-T TRUCK 			
<ul style="list-style-type: none"> ★ OPTICRUISE 			
<ul style="list-style-type: none"> ● 3 BUS 			
<ul style="list-style-type: none"> ★ GR801/R - K113 			
<ul style="list-style-type: none"> ● 4 BUS 			
<ul style="list-style-type: none"> ★ GR801/R - GR/GRS/R - OPTICRUISE 			
<ul style="list-style-type: none"> ● F-K-N BUS 			
<ul style="list-style-type: none"> ★ OPTICRUISE - GR801/R 			





REPAIR SET (VITON BLACK O-RINGS)	63625	63625	
<ul style="list-style-type: none"> ● 4 TRUCK 			
<ul style="list-style-type: none"> ★ OPTICRUISE 			
<ul style="list-style-type: none"> ● P-G-R-T TRUCK 			
<ul style="list-style-type: none"> ★ OPTICRUISE 			



REPAIR SET (VITON GREEN O-RINGS)	64363	1903797	
<ul style="list-style-type: none"> ● 4 TRUCK 			
<ul style="list-style-type: none"> ★ OPTICRUISE 			
<ul style="list-style-type: none"> ● P-G-R-T TRUCK 			
<ul style="list-style-type: none"> ★ OPTICRUISE 			



ALL THE COMPONENTS LISTED IN OUR CATALOGUE ARE NOT ORIGINAL, THOUGH PERFECTLY INTERCHANGEABLE. REFERENCE NUMBERS, EITHER ORIGINAL OR OF A DIFFERENT NATURE, ARE FOR INFORMATION PURPOSES ONLY. WHEN PLACING AN ORDER, PLEASE, ALWAYS USE COSIBO REFERENCE NUMBERS AND DO NOT MENTION THE ORIGINAL REFERENCE NUMBERS OF THE TRUCK MANUFACTURERS IN THE INVOICE TO VEHICLE OWNERS OR TO ANYBODY ELSE. THE CUSTOMER TAKES HIS OWN RESPONSIBILITY IF HE DOES NOT COMPLY WITH WHAT ABOVE.

	Code	OEM new	OEM old
SET O-RING (VITON)	65003	65003	
	<ul style="list-style-type: none"> ● Model ★ Application 		
	<ul style="list-style-type: none"> ● P-G-R-T TRUCK ★ GRS890R - GRS920R - GRS900R - GRS0900R 		
	<ul style="list-style-type: none"> ● 3 TRUCK ★ GRS900 CAG - GRS900R 		
	<ul style="list-style-type: none"> ● 4 TRUCK ★ GRS0900R - GRS/GRSH900R - GRS890R - GRS920R 		
SEAL RING	63344	1515870	1318762
	<ul style="list-style-type: none"> ● P-G-R-T TRUCK ★ GRS890R - GRS920R - GRS900R - GRS0900R 		
	<ul style="list-style-type: none"> ● 3 TRUCK ★ GRS900 CAG - GRS900R 		
	<ul style="list-style-type: none"> ● 4 TRUCK ★ GRS0900R - GRS/GRSH900R - GRS890R - GRS920R 		
O-RING	63339	1472718	804710
	<ul style="list-style-type: none"> ● F-K-N BUS ★ G670 - GR875R GRS/GRS0895R OPTICRUISE 		
	<ul style="list-style-type: none"> ● P-G-R-T TRUCK ★ GRS890R - GRS920R - GRS900R - GRS0900R - GR875R - GRS895R - GR/GRS/GRS0905R OPTICRUISE - G670 		
	<ul style="list-style-type: none"> ● 4 TRUCK ★ GRS890R - GRS920R - GRS0900R - GRS/GRSH900R 		

ALL THE COMPONENTS LISTED IN OUR CATALOGUE ARE NOT ORIGINAL, THOUGH PERFECTLY INTERCHANGEABLE. REFERENCE NUMBERS, EITHER ORIGINAL OR OF A DIFFERENT NATURE, ARE FOR INFORMATION PURPOSES ONLY. WHEN PLACING AN ORDER, PLEASE, ALWAYS USE COSIBO REFERENCE NUMBERS AND DO NOT MENTION THE ORIGINAL REFERENCE NUMBERS OF THE TRUCK MANUFACTURERS IN THE INVOICE TO VEHICLE OWNERS OR TO ANYBODY ELSE. THE CUSTOMER TAKES HIS OWN RESPONSIBILITY IF HE DOES NOT COMPLY WITH WHAT ABOVE.

	Code	OEM new	OEM old
O-RING 15.3x2,4	63338	804658	397920
● Model			
★ Application			
● 3 TRUCK			
★			
● 4 TRUCK			
★			
● P-G-R-T TRUCK			
★			
● 3 BUS			
★			
● 4 BUS			
★			
● F-K-N BUS			
★			



O-RING	63337	804672	390546
● 3 TRUCK			
★ GRS900 CAG - GRS900R - GRS900			



O-RING REPAIR SET (VITON GREEN)	64407/1	1903798	
● 4 TRUCK			
★ GRS890R - GRS920R - GRS0900R - GRS/GRSH900R			
● P-G-R-T TRUCK			
★ GRS890R - GRS920R - GRS900R - GRS0900R			



GEAR BOX BALL JOINT SET



- Model
- ★ Application

Code

OEM new

OEM old

65315

550268

- 4 TRUCK



- P-G-R-T TRUCK



GEAR BOX BALL JOINT



- 4 TRUCK

- ★ CT LHD/RHD - CP/CR LHD - CT RHD GR/GRS900R - CT GRSH900

- P-G-R-T TRUCK

- ★ CT LHD/RHD - CH AWD

60754

1384624

1356022

GEARBOX BALL JOINT



- 3 BUS

- ★ GS771/772 - G770/776 - GR801

- 3 TRUCK

- ★ CR/CT 143 - CG/CP/CR/CT 93/113

61209

350270

ALL THE COMPONENTS LISTED IN OUR CATALOGUE ARE NOT ORIGINAL, THOUGH PERFECTLY INTERCHANGEABLE. REFERENCE NUMBERS, EITHER ORIGINAL OR OF A DIFFERENT NATURE, ARE FOR INFORMATION PURPOSES ONLY. WHEN PLACING AN ORDER, PLEASE, ALWAYS USE COSIBO REFERENCE NUMBERS AND DO NOT MENTION THE ORIGINAL REFERENCE NUMBERS OF THE TRUCK MANUFACTURERS IN THE INVOICE TO VEHICLE OWNERS OR TO ANYBODY ELSE. THE CUSTOMER TAKES HIS OWN RESPONSIBILITY IF HE DOES NOT COMPLY WITH WHAT ABOVE.

GEARBOX BALL JOINT



	Code	OEM new	OEM old
● Model	63329	307443	
★ Application			
● 3 BUS			
★	G770/776 - GS771/772 - GR801		
● 3 TRUCK			
★	CG/CP - CP/CR/CT 93/113 - CR/CT 143 - GR801 - GR/GRS/GRH900 - GR880T - GRH880		

LH GEARBOX BALL JOINT



	60907	1384897	305319 371451
● 3 BUS			
★	G770/776/777 - GS776 - GS771/772 - GR801 - K93/113 - L113 - G776/777 CS/CAG		
● 3 TRUCK			
★	CT93 LHD GR801/GR900 - CT113 LHD GR/GRS900 - CT143 LHD GR/GRS/GRH900 - CT143 GR880T/GRH880 - CG/CP/CR93 LHD/RHD GR801/900 - CG/CP113 LHD GR/GRS900 - CP/CR113 RHD - CP/CR113 LHD 4X4 6X4 6X6 - CP/CR113 RHD 4X4 6X6 - CP/CR113 LHD/RHD GR/GRS900 - CR143 LHD/RHD GR/GRH880 - CG/CP/CR93 RHD - CR113 LHD - CR143 LHD/RHD GR/GRS900R - CR143 EK330/340 - CR143 LHD GRH900 - CR113 RHD GRS900 DTC		
● 4 TRUCK			
★	CT LHD/RHD - CT RHD GR/GRS900R - CT GRSH900		
● P-G-R-T TRUCK			
★	CT LHD/RHD		

ALL THE COMPONENTS LISTED IN OUR CATALOGUE ARE NOT ORIGINAL, THOUGH PERFECTLY INTERCHANGEABLE. REFERENCE NUMBERS, EITHER ORIGINAL OR OF A DIFFERENT NATURE, ARE FOR INFORMATION PURPOSES ONLY. WHEN PLACING AN ORDER, PLEASE, ALWAYS USE COSIBO REFERENCE NUMBERS AND DO NOT MENTION THE ORIGINAL REFERENCE NUMBERS OF THE TRUCK MANUFACTURERS IN THE INVOICE TO VEHICLE OWNERS OR TO ANYBODY ELSE. THE CUSTOMER TAKES HIS OWN RESPONSIBILITY IF HE DOES NOT COMPLY WITH WHAT ABOVE.

	Code	OEM new	OEM old
RH GEARBOX BALL JOINT	60908	1384898	305320 371452
<ul style="list-style-type: none"> ● Model ★ Application 			
			
<ul style="list-style-type: none"> ● 3 BUS ★ G770/776/777 - GS776 - GS771/772 - GR801 - K93/113 - L113 - G776/777 CS/CAG 			
<ul style="list-style-type: none"> ● 3 TRUCK ★ CT93 LHD GR801/GR900 - CT113 LHD GR/GRS900 - CT143 LHD GR/GRS/GRH900 - CT143 GR880T/GRH880 - CG/CP/CR93 LHD/RHD GR801/900 - CG/CP113 LHD GR/GRS900 - CP/CR113 RHD - CP/CR113 LHD 4X4 6X4 6X6 - CP/CR113 RHD 4X4 6X6 - CP/CR113 LHD/RHD GR/GRS900 - CR143 LHD/RHD GR/GRH880 - CG/CP/CR93 RHD - CR113 LHD - CR143 LHD/RHD GR/GRS900R - CR143 EK330/340 - CR143 LHD GRH900 - CR113 RHD GRS900 DTC 			
<ul style="list-style-type: none"> ● 4 TRUCK ★ CT LHD/RHD - CT RHD GR/GRS900R - CT GRSH900 			
<ul style="list-style-type: none"> ● P-G-R-T TRUCK ★ CT LHD/RHD 			
TIE ROD WITH BALL JOINTS	61207	371453	
			
<ul style="list-style-type: none"> ● 3 BUS ★ G776/777 - GS771/772 - G776 RHD - GR801 LHD/RHD 			
TIE ROD WITH BALL JOINTS	61208	1437727	1384896 371448
			
<ul style="list-style-type: none"> ● 3 BUS ★ G770 			
<ul style="list-style-type: none"> ● 3 TRUCK ★ CT93 LHD GR801/900 - CP/CR/CT113 LHD GR/GRS900 - CP/CR113 RHD GR/GRS900 - CT143 LHD GRH900 - GR/GRS900 - CT143 GR880T/GRH880 - CG/CP/CR93 LHD/RHD GR801/900 - CG/CP/CR113 LHD - CG/CP113 GR/GRS900 - CP/CR113 RHD 4X4 6X6 - CP/CR113 LHD 4X4 6X4 - CR143 LHD/RHD - CR143 RHD GR/GRS900R - GR/GRH880 - CR143 LHD GRH900 - GR/GRS900R - CR143 EK330/340 - CR113 RHD GRS900 DTC 			
<ul style="list-style-type: none"> ● 4 TRUCK ★ CP AWD - CP/CR - CP/CR LHD 4X4 6X6 - CP/CR LHD 			
<ul style="list-style-type: none"> ● P-G-R-T TRUCK ★ CG/CP/CR - CP/CR AWD 			

ALL THE COMPONENTS LISTED IN OUR CATALOGUE ARE NOT ORIGINAL, THOUGH PERFECTLY INTERCHANGEABLE. REFERENCE NUMBERS, EITHER ORIGINAL OR OF A DIFFERENT NATURE, ARE FOR INFORMATION PURPOSES ONLY. WHEN PLACING AN ORDER, PLEASE, ALWAYS USE COSIBO REFERENCE NUMBERS AND DO NOT MENTION THE ORIGINAL REFERENCE NUMBERS OF THE TRUCK MANUFACTURERS IN THE INVOICE TO VEHICLE OWNERS OR TO ANYBODY ELSE. THE CUSTOMER TAKES HIS OWN RESPONSIBILITY IF HE DOES NOT COMPLY WITH WHAT ABOVE.

	Code	OEM new	OEM old
UNIVERSAL JOINT	64498	339129	
<ul style="list-style-type: none"> ● Model ★ Application 			
<ul style="list-style-type: none"> ● 3 BUS 			
★ G770			
<ul style="list-style-type: none"> ● 3 TRUCK 			
★ CG/CP/CR 93/113			
<ul style="list-style-type: none"> ● P-G-R-T TRUCK 			
★ CG - CP/CR GR875R GRS895R GR/GRS/GRS0905R			



UNIVERSAL JOINT ASSY	64498/2	64498/2	
<ul style="list-style-type: none"> ● 3 BUS 			
★ G770			
<ul style="list-style-type: none"> ● 3 TRUCK 			
★ CG/CP/CR 93/113			
<ul style="list-style-type: none"> ● P-G-R-T TRUCK 			
★ CG - CP/CR GR875R GRS895R GR/GRS/GRS0905R			



GEAR SHIFT LEVER KNOB	62522	1441235	
<ul style="list-style-type: none"> ● 4 TRUCK 			
★ CP/CR LHD - RHD 4X4 6X6 CH 1287575 - CH 4489426 - CH 9078306 - CP/CR LHD - RHD CH 1287575 - CH 4489426 - CH 9078306 - CP LHD DC12 03 4X4 6X6 CH 1287575 - CH 4489426 - CH 9078306 - CT LHD CH 3548836 - CT LHD - RHD CH 1294873 - CH 4510832 - CH 9087797 - CH 3546890			
<ul style="list-style-type: none"> ● P-G-R-T TRUCK 			
★ CR LHD - RHD - CP LHD - RHD CH 2018247 - CH 2018248 - CH 5150365 - CH 5150366 - CH 9111399 - CH 9111400 - CH 3589353 - CH 3589354 - CT LHD - RHD - CR/CP LHD - RHD GR875/R GR895/R GR/GRS/GRSO 905/R - CG LHD - RHD			



GEAR SHIFT LEVER KNOB



● Model

★ Application

Code

OEM new

OEM old

62527

1919065

1727377
1438702

● 4 TRUCK

- ★ CP/CR LHD/RHD GRS900/920 - CP LHD DC12 03 4X4 6X6 GRS900/920 - CT LHD GRS900/R - CT LHD/RHD GRS900/R

● P-G-R-T TRUCK

- ★ CT LHD GRS900/R GRS900/920/R GRS0900/R - CR LHD/RHD GR875/R GRS895/R GR/GRS/GRS0905/R - GRS900/920 GRS0900 - CP LHD/RHD GR875/R GRS895/R GR/GRS/GRS0905/R - GRS900/920 GRS0900 - CG LHD/RHD

GEAR SHIFT LEVER KNOB



63057

384970

● 3 TRUCK

- ★ CT93/113/143 - CT93 GR871 - CT93 LHD GR801 - CG/CP LHD/RHD - CP/CR93/113 - CT93 LHD GR900 - CP/CR113 LHD 6X4 - CT113 LHD GR/GRS900 - CP113 GR/GRS900 - CP/CR113 LHD/RHD 4X4 6X6 - CT143 LHD GR/GRS900 - GRH900 - CP/CR93/113 RHD - CP/CR113 LHD/RHD G770 - GR871 - GR/GRS900 - CR143 GR880 - GR/GRS900

GEAR SHIFT LEVER KNOB



63326

1485717

1369555

● 3 TRUCK

- ★ CP/CR/CT113 LHD GRS900 - CR/CT143 LHD GRS900 - CP/CR113 RHD GRS900

● 4 TRUCK

- ★ CT RHD GR/GRS900R

ALL THE COMPONENTS LISTED IN OUR CATALOGUE ARE NOT ORIGINAL, THOUGH PERFECTLY INTERCHANGEABLE. REFERENCE NUMBERS, EITHER ORIGINAL OR OF A DIFFERENT NATURE, ARE FOR INFORMATION PURPOSES ONLY. WHEN PLACING AN ORDER, PLEASE, ALWAYS USE COSIBO REFERENCE NUMBERS AND DO NOT MENTION THE ORIGINAL REFERENCE NUMBERS OF THE TRUCK MANUFACTURERS IN THE INVOICE TO VEHICLE OWNERS OR TO ANYBODY ELSE. THE CUSTOMER TAKES HIS OWN RESPONSIBILITY IF HE DOES NOT COMPLY WITH WHAT ABOVE.

GEAR SHIFT LEVER KNOB



	Code	OEM new	OEM old
● Model	63327	1482997	1362071
★ Application			
● 4 TRUCK			
★	CP/CR RHD - CT GRSH900 - CT LHD GRS/GRSH900R - CP/CR LHD GRS900/920 - GRSH900 - RHD GRS900/920		

GEAR SHIFT LEVER KNOB



	64244	1369975	
● 4 TRUCK			
★	CT LHD GR900R - CP/CR LHD GR900 - RHD GR900		

GEAR SHIFT LEVER KNOB SWITCH



	63759	1377386	1317885
● 4 BUS			
★	GR801R		
● F-K-N BUS			
★	GR801R		
● 3 TRUCK			
★	CP/CR113 LHD GR/GRS900 - CR143 GR/GRS900		
● 4 TRUCK			
★	CP/CR LHD/RHD - CT LHD GR/GRS - CT RHD GR/GRS900R - CT GRSH900 - GR/GRS890 - GRS920		

ALL THE COMPONENTS LISTED IN OUR CATALOGUE ARE NOT ORIGINAL, THOUGH PERFECTLY INTERCHANGEABLE. REFERENCE NUMBERS, EITHER ORIGINAL OR OF A DIFFERENT NATURE, ARE FOR INFORMATION PURPOSES ONLY. WHEN PLACING AN ORDER, PLEASE, ALWAYS USE COSIBO REFERENCE NUMBERS AND DO NOT MENTION THE ORIGINAL REFERENCE NUMBERS OF THE TRUCK MANUFACTURERS IN THE INVOICE TO VEHICLE OWNERS OR TO ANYBODY ELSE. THE CUSTOMER TAKES HIS OWN RESPONSIBILITY IF HE DOES NOT COMPLY WITH WHAT ABOVE.

	Code	OEM new	OEM old
GEAR SHIFT ROD	63110	1515117	1428073
● Model			
★ Application			
● 4 TRUCK			
★ CR - DC9 14			



	63112	1515118	1426263
GEAR SHIFT ROD			
● 4 TRUCK			
★ CP			



	64797	1515119	1427669
GEAR SHIFT ROD			
● 4 TRUCK			
★ CR - DC16			



ALL THE COMPONENTS LISTED IN OUR CATALOGUE ARE NOT ORIGINAL, THOUGH PERFECTLY INTERCHANGEABLE. REFERENCE NUMBERS, EITHER ORIGINAL OR OF A DIFFERENT NATURE, ARE FOR INFORMATION PURPOSES ONLY. WHEN PLACING AN ORDER, PLEASE, ALWAYS USE COSIBO REFERENCE NUMBERS AND DO NOT MENTION THE ORIGINAL REFERENCE NUMBERS OF THE TRUCK MANUFACTURERS IN THE INVOICE TO VEHICLE OWNERS OR TO ANYBODY ELSE. THE CUSTOMER TAKES HIS OWN RESPONSIBILITY IF HE DOES NOT COMPLY WITH WHAT ABOVE.

		Code	OEM new	OEM old
GEAR SHIFT ROD	● Model	65431	1762415	1450132
	★ Application			1543603
				1548849
		● P-G-R-T TRUCK		
		★ D9 - D12 - D16		



		63328	339130	
BEARING	● 3 BUS			
	★ G770			
		● 3 TRUCK		
		★ CG/CP - CP/CR/CT 93/113 - CT 143 - GR801 - GR/GRH/GRS900		
		● 4 TRUCK		
		★ CP/CR/CT - DC12 03		
		● P-G-R-T TRUCK		
		★ CG/CP/CR/CT - GR875R - GRS895R - GR/GRS/GRS0905R - G670		



		64357	1325383	
BEARING	● 4 TRUCK			
	★ CP/CR/CT - DC12 03			
		● P-G-R-T TRUCK		
		★ CP/CR/CT		



ALL THE COMPONENTS LISTED IN OUR CATALOGUE ARE NOT ORIGINAL, THOUGH PERFECTLY INTERCHANGEABLE. REFERENCE NUMBERS, EITHER ORIGINAL OR OF A DIFFERENT NATURE, ARE FOR INFORMATION PURPOSES ONLY. WHEN PLACING AN ORDER, PLEASE, ALWAYS USE COSIBO REFERENCE NUMBERS AND DO NOT MENTION THE ORIGINAL REFERENCE NUMBERS OF THE TRUCK MANUFACTURERS IN THE INVOICE TO VEHICLE OWNERS OR TO ANYBODY ELSE. THE CUSTOMER TAKES HIS OWN RESPONSIBILITY IF HE DOES NOT COMPLY WITH WHAT ABOVE.

	Code	OEM new	OEM old
BUSHING	64161	1405402	
	<ul style="list-style-type: none"> ● Model ★ Application 		
	<ul style="list-style-type: none"> ● 4 TRUCK ★ LHD-RHD 		
	<ul style="list-style-type: none"> ● P-G-R-T TRUCK ★ CG/CR LHD-RHD - CP LHD - GR875R - GSR895R - GS/GRS/GSRO905R 		
SCREW M6	64162	1405406	
	<ul style="list-style-type: none"> ● 4 TRUCK ★ LHD-RHD 		
	<ul style="list-style-type: none"> ● P-G-R-T TRUCK ★ CG/CR LHD-RHD - CP LHD - GR875R - GSR895R - GS/GRS/GSRO905R 		
SCREW	64446	1787032	
	<ul style="list-style-type: none"> ● 4 TRUCK ★ 		
	<ul style="list-style-type: none"> ● P-G-R-T TRUCK ★ 		

ALL THE COMPONENTS LISTED IN OUR CATALOGUE ARE NOT ORIGINAL, THOUGH PERFECTLY INTERCHANGEABLE. REFERENCE NUMBERS, EITHER ORIGINAL OR OF A DIFFERENT NATURE, ARE FOR INFORMATION PURPOSES ONLY. WHEN PLACING AN ORDER, PLEASE, ALWAYS USE COSIBO REFERENCE NUMBERS AND DO NOT MENTION THE ORIGINAL REFERENCE NUMBERS OF THE TRUCK MANUFACTURERS IN THE INVOICE TO VEHICLE OWNERS OR TO ANYBODY ELSE. THE CUSTOMER TAKES HIS OWN RESPONSIBILITY IF HE DOES NOT COMPLY WITH WHAT ABOVE.

	Code	OEM new	OEM old
NUT M6	64823	807351	1433099
	<ul style="list-style-type: none"> ● Model ★ Application 		
	<ul style="list-style-type: none"> ● 3 BUS ★ N113 LHD-RHD - K113 - GA7 		
	<ul style="list-style-type: none"> ● 4 BUS ★ GR801R - G701 LHD-RHD - OPTICRUISE - DC9 EDC - DC11 		
	<ul style="list-style-type: none"> ● F-K-N BUS ★ GR801R - GR801 CS 		
	<ul style="list-style-type: none"> ● 4 TRUCK ★ LHD-RHD 		
	<ul style="list-style-type: none"> ● P-G-R-T TRUCK ★ CG/CR LHD-RHD - CP LHD - GR875R - GSR895R - GS/GRS/GSR0905R 		
REPAIR SET	64824	64824	
	<ul style="list-style-type: none"> ● 4 TRUCK ★ LHD-RHD 		
	<ul style="list-style-type: none"> ● P-G-R-T TRUCK ★ CG/CR LHD-RHD - CP LHD - GR875R - GSR895R - GS/GRS/GSR0905R 		
BRACKET	64686	1548318	1412052
	<ul style="list-style-type: none"> ● 4 TRUCK ★ CP AWD - CP/ CR - CP/ CR LHD 4X4 - 6X6 CH 1287575 - CH 4489426 - CH 9078306 - CP/ CR LHD CH 1287574 - CH 9078305 - CH 4489425 		
	<ul style="list-style-type: none"> ● P-G-R-T TRUCK ★ CP/ CR/ CG AWD - CR - CP CH 2018247 - CH 2018248 - CH 5150365 - CH 5150366 - CH 9111399 - CH 9111400 - CH 3589353 - CH 3589354 - CP GRSOH901R 		

ALL THE COMPONENTS LISTED IN OUR CATALOGUE ARE NOT ORIGINAL, THOUGH PERFECTLY INTERCHANGEABLE. REFERENCE NUMBERS, EITHER ORIGINAL OR OF A DIFFERENT NATURE, ARE FOR INFORMATION PURPOSES ONLY. WHEN PLACING AN ORDER, PLEASE, ALWAYS USE COSIBO REFERENCE NUMBERS AND DO NOT MENTION THE ORIGINAL REFERENCE NUMBERS OF THE TRUCK MANUFACTURERS IN THE INVOICE TO VEHICLE OWNERS OR TO ANYBODY ELSE. THE CUSTOMER TAKES HIS OWN RESPONSIBILITY IF HE DOES NOT COMPLY WITH WHAT ABOVE.

REPAIR SET FOR OUR REF 64686



	Code	OEM new	OEM old
● Model ★ Application	64332	64332	
● 4 TRUCK			
★ CP AWD - CP/CR - CP/CR LHD 4X4 - 6X6 CH 1287575 - CH 4489426 - CH 9078306 - CP/CR LHD CH 1287574 - CH 9078305 - CH 4489425			
● P-G-R-T TRUCK			
★ CP/CR/CG AWD - CR - CP CH 2018247 - CH 2018248 - CH 5150365 - CH 5150366 - CH 9111399 - CH 9111400 - CH 3589353 - CH 3589354 - CP GR50H901R			

BOOT



	61628	393107	321297
● 3 TRUCK			
★ CR 93 - CP/CR 113 - CR 143 - GR/GRS900 - GR880 - G770 - GR871			

BOOT



	61629	393108	310243
● 3 TRUCK			
★ CR 93 - CP/CR 113 - CR 143 - GR/GRS900 - GR880 - G770 - GR871			

BOOT



	62229	395634	
● 3 TRUCK			
★ CT 93/113/143 - GR871 - GR801 - GR/GRH/GRS900			

ALL THE COMPONENTS LISTED IN OUR CATALOGUE ARE NOT ORIGINAL, THOUGH PERFECTLY INTERCHANGEABLE. REFERENCE NUMBERS, EITHER ORIGINAL OR OF A DIFFERENT NATURE, ARE FOR INFORMATION PURPOSES ONLY. WHEN PLACING AN ORDER, PLEASE, ALWAYS USE COSIBO REFERENCE NUMBERS AND DO NOT MENTION THE ORIGINAL REFERENCE NUMBERS OF THE TRUCK MANUFACTURERS IN THE INVOICE TO VEHICLE OWNERS OR TO ANYBODY ELSE. THE CUSTOMER TAKES HIS OWN RESPONSIBILITY IF HE DOES NOT COMPLY WITH WHAT ABOVE.

	Code	OEM new	OEM old
BOOT	62230	395635	
<ul style="list-style-type: none"> ● Model ★ Application 			
<ul style="list-style-type: none"> ● 3 TRUCK ★ CT 93/113/143 - GR871 - GR801 - GR/GRH/GRS900 			



BOOT	62231	1102585	
<ul style="list-style-type: none"> ● 3 TRUCK ★ CR 93 - CP/CR 113 - CR 143 - GR/GRS900 - GR880 - G770 - GR871 			



BOOT	65180	287379	
<ul style="list-style-type: none"> ● 3 TRUCK ★ CT 143 GR880T GRH880 			



	Code	OEM new	OEM old
BOOT	65181	287380	
<ul style="list-style-type: none"> ● Model ★ Application 			
<ul style="list-style-type: none"> ● 3 TRUCK ★ CT 143 GR880T GRH880 			



BOOT	65182	339141	248326 302948
<ul style="list-style-type: none"> ● 3 BUS ★ G770 			
<ul style="list-style-type: none"> ● 3 TRUCK ★ CG/CP - CP/CR 93/113 - CT 93 - GR/GRS900 - GR801 			



BOOT	65183	1300097	248325 339140
<ul style="list-style-type: none"> ● 3 BUS ★ G770 			
<ul style="list-style-type: none"> ● 3 TRUCK ★ CG/CP - CP/CR 93/113 - CT 93 - GR/GRS900 - GR801 			



	Code	OEM new	OEM old
BOOT 	65184	349034	
	<ul style="list-style-type: none"> ● Model ★ Application 		
	<ul style="list-style-type: none"> ● 3 BUS ★ GR801 - GR/GRS900 - G770 - GS771 - K 113 		
	<ul style="list-style-type: none"> ● 3 TRUCK ★ CG/CP/CR/CT 93 - CG/CP/CR/CT 113 - CP/CR/CT 143 - GR/GRH880 - GR880T - GR801 - GR/GRH/GRS900 - 		
BOOT 	62232	1356372	
	<ul style="list-style-type: none"> ● 4 TRUCK ★ CP/CR - DC12 03 		
	<ul style="list-style-type: none"> ● P-G-R-T TRUCK ★ CG/CP/CR - GR875R - GRS895R - GR/GRS/GRS0905R - CP G670 		
BOOT 	66585	1346608	
	<ul style="list-style-type: none"> ● 4 TRUCK ★ CP/CR LHD 4X4 6X6 - CP LHD DC12 03 4X4 6X6 		
BOOT 	66583	1346606	
	<ul style="list-style-type: none"> ● 4 TRUCK ★ CP/CR LHD 4X4 6X6 - CP LHD DC12 03 4X4 6X6 		

ALL THE COMPONENTS LISTED IN OUR CATALOGUE ARE NOT ORIGINAL, THOUGH PERFECTLY INTERCHANGEABLE. REFERENCE NUMBERS, EITHER ORIGINAL OR OF A DIFFERENT NATURE, ARE FOR INFORMATION PURPOSES ONLY. WHEN PLACING AN ORDER, PLEASE, ALWAYS USE COSIBO REFERENCE NUMBERS AND DO NOT MENTION THE ORIGINAL REFERENCE NUMBERS OF THE TRUCK MANUFACTURERS IN THE INVOICE TO VEHICLE OWNERS OR TO ANYBODY ELSE. THE CUSTOMER TAKES HIS OWN RESPONSIBILITY IF HE DOES NOT COMPLY WITH WHAT ABOVE.

	Code	OEM new	OEM old
BOOT	66578/1	1346612	
<ul style="list-style-type: none"> ● Model ★ Application 			
<ul style="list-style-type: none"> ● 4 TRUCK ★ CT - GR/GRS900R - GRH900 			
<ul style="list-style-type: none"> ● P-G-R-T TRUCK ★ CT 			





RUBBER BUFFER	66580/1	1514089	1427926
<ul style="list-style-type: none"> ● 4 TRUCK ★ CT - GR/GRS900R 			
<ul style="list-style-type: none"> ● P-G-R-T TRUCK ★ CT 			



GEARBOX ROD	63844	1379621	
<ul style="list-style-type: none"> ● 4 TRUCK ★ CP/CR LHD CH 1273918 - CH 4457600 - CH 9063964 			



ALL THE COMPONENTS LISTED IN OUR CATALOGUE ARE NOT ORIGINAL, THOUGH PERFECTLY INTERCHANGEABLE. REFERENCE NUMBERS, EITHER ORIGINAL OR OF A DIFFERENT NATURE, ARE FOR INFORMATION PURPOSES ONLY. WHEN PLACING AN ORDER, PLEASE, ALWAYS USE COSIBO REFERENCE NUMBERS AND DO NOT MENTION THE ORIGINAL REFERENCE NUMBERS OF THE TRUCK MANUFACTURERS IN THE INVOICE TO VEHICLE OWNERS OR TO ANYBODY ELSE. THE CUSTOMER TAKES HIS OWN RESPONSIBILITY IF HE DOES NOT COMPLY WITH WHAT ABOVE.

	Code	OEM new	OEM old
GEARBOX ROD	63845	1472771	1472879
<ul style="list-style-type: none"> ● Model ★ Application 			
<ul style="list-style-type: none"> ● 4 TRUCK ★ CP/CR CH 1273919 - CP/CR LHD CH 9063964 - CH 4457601 - CH 9063965 			
			
GEARBOX ROD LHD	65430	1469566	
<ul style="list-style-type: none"> ● P-G-R-T TRUCK ★ CG/CP/CR LHD 			
			
GEARBOX ROD RHD	64412	1471133	
<ul style="list-style-type: none"> ● P-G-R-T TRUCK ★ CR RDH/GUIDA DX 			
			

ALL THE COMPONENTS LISTED IN OUR CATALOGUE ARE NOT ORIGINAL, THOUGH PERFECTLY INTERCHANGEABLE. REFERENCE NUMBERS, EITHER ORIGINAL OR OF A DIFFERENT NATURE, ARE FOR INFORMATION PURPOSES ONLY. WHEN PLACING AN ORDER, PLEASE, ALWAYS USE COSIBO REFERENCE NUMBERS AND DO NOT MENTION THE ORIGINAL REFERENCE NUMBERS OF THE TRUCK MANUFACTURERS IN THE INVOICE TO VEHICLE OWNERS OR TO ANYBODY ELSE. THE CUSTOMER TAKES HIS OWN RESPONSIBILITY IF HE DOES NOT COMPLY WITH WHAT ABOVE.

	Code	OEM new	OEM old
O-RING	64790	804670	
<ul style="list-style-type: none"> ● Model ★ Application 			
	● 3 BUS		
	★ GR801 WITH OPTICRUISE - GS771 WITH OPTICRUISE NEOPLAN - K93/113 - L113		
	● 4 BUS		
	★ GR801 WITH OPTICRUISE		
	● F-K-N BUS		
	★ GR801 WITH OPTICRUISE		

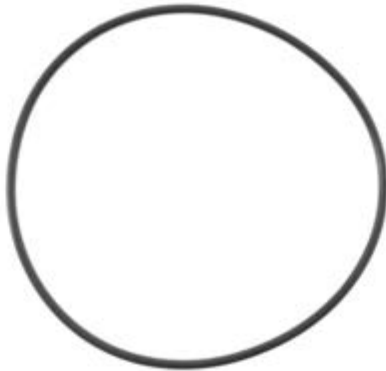

	Code	OEM new	OEM old
RUBBER HOSE	61212	346627	
	<ul style="list-style-type: none"> ● Model ★ Application 		
	<ul style="list-style-type: none"> ● 3 TRUCK ★ GR/GRS900 - GR/GRS/GRH900 - GRE871 - CR/CT143 GRH880 - CT113 		
SILICONE HOSE	63229	412080	
	<ul style="list-style-type: none"> ● 3 BUS ★ GA781R 		
	<ul style="list-style-type: none"> ● 3 TRUCK ★ GR/GRS900R - GA850R 		
RUBBER HOSE	61793	298823	
	<ul style="list-style-type: none"> ● 3 TRUCK ★ CP/CR/CT 113 		
RUBBER HOSE	63176	318364	
	<ul style="list-style-type: none"> ● P-G-R-T TRUCK ★ GR50H 901R 		

ALL THE COMPONENTS LISTED IN OUR CATALOGUE ARE NOT ORIGINAL, THOUGH PERFECTLY INTERCHANGEABLE. REFERENCE NUMBERS, EITHER ORIGINAL OR OF A DIFFERENT NATURE, ARE FOR INFORMATION PURPOSES ONLY. WHEN PLACING AN ORDER, PLEASE, ALWAYS USE COSIBO REFERENCE NUMBERS AND DO NOT MENTION THE ORIGINAL REFERENCE NUMBERS OF THE TRUCK MANUFACTURERS IN THE INVOICE TO VEHICLE OWNERS OR TO ANYBODY ELSE. THE CUSTOMER TAKES HIS OWN RESPONSIBILITY IF HE DOES NOT COMPLY WITH WHAT ABOVE.

	Code	OEM new	OEM old
RUBBER HOSE	64286	1493708	1450536
<ul style="list-style-type: none"> ● Model ★ Application 			
<ul style="list-style-type: none"> ● 4 TRUCK ★ DC16 GRS/GRS0900/920R 			
<ul style="list-style-type: none"> ● P-G-R-T TRUCK ★ DC16 			



RUBBER HOSE	64292	1387044	
<ul style="list-style-type: none"> ● 4 TRUCK ★ DC14 GRSH900 			



RUBBER HOSE	64293	1367972	
<ul style="list-style-type: none"> ● 4 TRUCK ★ DC14 GRS900R GRSH900R 			



RUBBER HOSE	64850	1377996	
<ul style="list-style-type: none"> ● 4 TRUCK ★ DC14 GRS900R 			



ALL THE COMPONENTS LISTED IN OUR CATALOGUE ARE NOT ORIGINAL, THOUGH PERFECTLY INTERCHANGEABLE. REFERENCE NUMBERS, EITHER ORIGINAL OR OF A DIFFERENT NATURE, ARE FOR INFORMATION PURPOSES ONLY. WHEN PLACING AN ORDER, PLEASE, ALWAYS USE COSIBO REFERENCE NUMBERS AND DO NOT MENTION THE ORIGINAL REFERENCE NUMBERS OF THE TRUCK MANUFACTURERS IN THE INVOICE TO VEHICLE OWNERS OR TO ANYBODY ELSE. THE CUSTOMER TAKES HIS OWN RESPONSIBILITY IF HE DOES NOT COMPLY WITH WHAT ABOVE.

	Code	OEM new	OEM old
RETARDER RUBBER HOSE 	64291	1377993	
<ul style="list-style-type: none"> ● Model ★ Application 			
<ul style="list-style-type: none"> ● 4 TRUCK ★ DC14 GRS/GRSH/900R - DC14 GRSH900 			
<ul style="list-style-type: none"> ● P-G-R-T TRUCK ★ GRSOH901R 			
RETARDER RUBBER HOSE 	65122	1541549	1377997 1512422
<ul style="list-style-type: none"> ● 4 TRUCK ★ DC14 GRS/GRSH900R - DC11 01/04/06/07 - DC12 GRS890R - GR/GRS/GRSO900R - DC11 74/75 - OSC11 G03 GRS890R - GR/GRS/GRSO900R - DC9 GRS890R - GR/GRS/GRSO900R - GA750/751R - GA851/852R - DC16 GRS/GRSO900/920R 			
<ul style="list-style-type: none"> ● P-G-R-T TRUCK ★ DC9/11/12/16 - FOR CH 2034902 - CH 5196997 - CH 9129358 - CH 3621168 			
RUBBER HOSE 	63601	1377231	
<ul style="list-style-type: none"> ● 4 BUS ★ F 94 			
RUBBER HOSE 	65129	1374040	
<ul style="list-style-type: none"> ● 4 TRUCK ★ GA750/751R 			

ALL THE COMPONENTS LISTED IN OUR CATALOGUE ARE NOT ORIGINAL, THOUGH PERFECTLY INTERCHANGEABLE. REFERENCE NUMBERS, EITHER ORIGINAL OR OF A DIFFERENT NATURE, ARE FOR INFORMATION PURPOSES ONLY. WHEN PLACING AN ORDER, PLEASE, ALWAYS USE COSIBO REFERENCE NUMBERS AND DO NOT MENTION THE ORIGINAL REFERENCE NUMBERS OF THE TRUCK MANUFACTURERS IN THE INVOICE TO VEHICLE OWNERS OR TO ANYBODY ELSE. THE CUSTOMER TAKES HIS OWN RESPONSIBILITY IF HE DOES NOT COMPLY WITH WHAT ABOVE.

	Code	OEM new	OEM old
RUBBER HOSE	61703	297394	
	<ul style="list-style-type: none"> ● Model ★ Application 		
	<ul style="list-style-type: none"> ● 3 BUS ★ K 113 		
	<ul style="list-style-type: none"> ● 3 TRUCK ★ GRH880 		
	<ul style="list-style-type: none"> ● 4 BUS ★ CN - N 94 		
GASKET	61366	1535698	224915
	<ul style="list-style-type: none"> ● 3 BUS ★ G770 		
	<ul style="list-style-type: none"> ● 3 TRUCK ★ G770 - GS771/772 - GR871 - GR/GRE871T - GR880T - GRH880 - EK330/340/421/422/423 		
	<ul style="list-style-type: none"> ● 4 TRUCK ★ EK330/340/630/640 		
	<ul style="list-style-type: none"> ● P-G-R-T TRUCK ★ EK630/640 		
O-RING DIAM.26,2X3	60635	197800	392661
	<ul style="list-style-type: none"> ● 3 TRUCK ★ EGR882 		
RETARDER RUBBER HOSE	62453	1854058	1380106
	<ul style="list-style-type: none"> ● 4 TRUCK ★ GA750/751R - GA851/852R - GRS890R - GR/GRS900/920R - GRSO920R - DC11 01/04/06/07 - DC12 GRS890R - GR/GRS/GRSO900R - DC14 GRSH900R 		
	<ul style="list-style-type: none"> ● P-G-R-T TRUCK ★ GA750/760R - GA850/860R - DT12 		

ALL THE COMPONENTS LISTED IN OUR CATALOGUE ARE NOT ORIGINAL, THOUGH PERFECTLY INTERCHANGEABLE. REFERENCE NUMBERS, EITHER ORIGINAL OR OF A DIFFERENT NATURE, ARE FOR INFORMATION PURPOSES ONLY. WHEN PLACING AN ORDER, PLEASE, ALWAYS USE COSIBO REFERENCE NUMBERS AND DO NOT MENTION THE ORIGINAL REFERENCE NUMBERS OF THE TRUCK MANUFACTURERS IN THE INVOICE TO VEHICLE OWNERS OR TO ANYBODY ELSE. THE CUSTOMER TAKES HIS OWN RESPONSIBILITY IF HE DOES NOT COMPLY WITH WHAT ABOVE.

RETARDER RUBBER HOSE



	Code	OEM new	OEM old
● Model	62478	1377566	
★ Application			
● 4 TRUCK			
★	DC11 01/04/06/07 - DC12 GRS890R - GR/GRS/GRS0900R - DC14 GRSH900R		
● P-G-R-T TRUCK			
★	DC9/11/12		

RETARDER RUBBER HOSE



	Code	OEM new	OEM old
	62479	1377567	
● 4 TRUCK			
★	DC11 01/04/06/07 - DC12 GRS890R - GR/GRS/GRS0900R - DC9 GRS890R - GR/GRS/GRS0900R - DC14 GRSH/900/900R - GA750/751R - DC16 GRS900/920R		

RETARDER RUBBER HOSE



	Code	OEM new	OEM old
	63867	1797845	1370488
● 4 TRUCK			
★	114/124 CP/CR14 - CPCR19 - GRS890R - GR/GRS/GRS0900/920R - GA750/751R - GA851/852R - DC14 GRSH900/900R		
● P-G-R-T TRUCK			
★	GA750/760R - GA850/860R - GRS0H901R - GR875/905R - GRS895/905R - GRS0905R		

TEMPERATURE SENSOR



	Code	OEM new	OEM old
	65187	1300043	
● 3 TRUCK			
★	GR871 - GR/GRE871T - GR880T		
● 4 TRUCK			
★	GR/GRS/GRS0/R - GRS920R AIR DC16 - 6X2/4 8X2/4		
● P-G-R-T TRUCK			
★	GRS920R - GRS0920R AIR DC16		

ALL THE COMPONENTS LISTED IN OUR CATALOGUE ARE NOT ORIGINAL, THOUGH PERFECTLY INTERCHANGEABLE. REFERENCE NUMBERS, EITHER ORIGINAL OR OF A DIFFERENT NATURE, ARE FOR INFORMATION PURPOSES ONLY. WHEN PLACING AN ORDER, PLEASE, ALWAYS USE COSIBO REFERENCE NUMBERS AND DO NOT MENTION THE ORIGINAL REFERENCE NUMBERS OF THE TRUCK MANUFACTURERS IN THE INVOICE TO VEHICLE OWNERS OR TO ANYBODY ELSE. THE CUSTOMER TAKES HIS OWN RESPONSIBILITY IF HE DOES NOT COMPLY WITH WHAT ABOVE.

	Code	OEM new	OEM old
RUBBER MOUNTING	60142	146526	
<ul style="list-style-type: none"> ● Model ★ Application 			
<ul style="list-style-type: none"> ● 3 TRUCK 			
<ul style="list-style-type: none"> ★ GR871 - GR871/880T - GRE871T - GRH880 - G770 - GS771/772 - GA/GAE770 - GR801/900 - GR/GRS900 - GR900 4X4 6X6 			
<ul style="list-style-type: none"> ● 4 TRUCK 			
<ul style="list-style-type: none"> ★ GRSH900R 			
<ul style="list-style-type: none"> ● P-G-R-T TRUCK 			
<ul style="list-style-type: none"> ★ GRSOH901R 			



RUBBER MOUNTING	60405	332738	137207
<ul style="list-style-type: none"> ● 3 BUS 			
<ul style="list-style-type: none"> ★ G776/777 - GS771/772 - GA773/775/781R - GR801R - GR801 			
<ul style="list-style-type: none"> ● 3 TRUCK 			
<ul style="list-style-type: none"> ★ GRH880/900 - GR880T TE70 - GR/GRS/GRH900 TE70 			



ENGINE & GEARBOX MOUNTING	62040	1336882	
<ul style="list-style-type: none"> ● 4 BUS 			
<ul style="list-style-type: none"> ★ L/K 			
<ul style="list-style-type: none"> ● 4 TRUCK 			
<ul style="list-style-type: none"> ★ GR/GRS/GRSO900R 			



ALL THE COMPONENTS LISTED IN OUR CATALOGUE ARE NOT ORIGINAL, THOUGH PERFECTLY INTERCHANGEABLE. REFERENCE NUMBERS, EITHER ORIGINAL OR OF A DIFFERENT NATURE, ARE FOR INFORMATION PURPOSES ONLY. WHEN PLACING AN ORDER, PLEASE, ALWAYS USE COSIBO REFERENCE NUMBERS AND DO NOT MENTION THE ORIGINAL REFERENCE NUMBERS OF THE TRUCK MANUFACTURERS IN THE INVOICE TO VEHICLE OWNERS OR TO ANYBODY ELSE. THE CUSTOMER TAKES HIS OWN RESPONSIBILITY IF HE DOES NOT COMPLY WITH WHAT ABOVE.

GEARBOX MOUNTING



- Model
- ★ Application

Code

OEM new

OEM old

62439

1921972

1469287
1782203

- 4 BUS

- ★ GR801R

- F-K-N BUS

- ★ GR875R - GRS/GRS0985R - GR/GRS/GRS0905 - GR801R - G701 - N -

- 4 TRUCK

- ★ GRS890R 8X8 WLS - GR/GRS 6X2 ad2900 - GRSH900R - GR/GRS 4X4 6X6 - GR/GRS/GRS0

- P-G-R-T TRUCK

- ★ 4X4 6X6 - GRS0H901R - G670 - GR801R - GRS890R - GR/GRS/GRS0900R - GRS920R - GR875R - GRS/GRS0985R - GR/GRS/GRS0905R

		Code	OEM new	OEM old
CLAMP	● Model	65402	1466075	
	★ Application			
	● 3 BUS			
	★			
	● 3 TRUCK			
	★			
	● F-K-N BUS			
	★			



CLAMP D.6		64082	813933	
	● 3 BUS			
	★			
	● 3 TRUCK			
	★			







CLAMP D.10		64083	813935	
	● 4 BUS			
	★			
	● 3 TRUCK			
	★			







CLAMP D. 16		64084	813937	
	● 4 BUS			
	★			
	● F-K-N BUS			
	★			
	● 3 TRUCK			
	★			



ALL THE COMPONENTS LISTED IN OUR CATALOGUE ARE NOT ORIGINAL, THOUGH PERFECTLY INTERCHANGEABLE. REFERENCE NUMBERS, EITHER ORIGINAL OR OF A DIFFERENT NATURE, ARE FOR INFORMATION PURPOSES ONLY. WHEN PLACING AN ORDER, PLEASE, ALWAYS USE COSIBO REFERENCE NUMBERS AND DO NOT MENTION THE ORIGINAL REFERENCE NUMBERS OF THE TRUCK MANUFACTURERS IN THE INVOICE TO VEHICLE OWNERS OR TO ANYBODY ELSE. THE CUSTOMER TAKES HIS OWN RESPONSIBILITY IF HE DOES NOT COMPLY WITH WHAT ABOVE.

	Code	OEM new	OEM old
<p>CLAMP D.20</p> 	64085	813939	
<ul style="list-style-type: none"> ● Model ★ Application 			
<ul style="list-style-type: none"> ● 3 BUS ★ 			
<ul style="list-style-type: none"> ● 3 TRUCK ★ 			
<p>CLAMP D.25</p> 	64086	813941	
<ul style="list-style-type: none"> ● 3 BUS ★ 			
<ul style="list-style-type: none"> ● 4 BUS ★ 			
<ul style="list-style-type: none"> ● 3 TRUCK ★ 			
<p>CLAMP D.8</p> 	64090	813934	
<ul style="list-style-type: none"> ● F-K-N BUS ★ 			
<ul style="list-style-type: none"> ● 3 TRUCK ★ 			
<p>CLAMP D.13</p> 	64091	813936	
<ul style="list-style-type: none"> ● 3 TRUCK ★ 			
<ul style="list-style-type: none"> ● P-G-R-T TRUCK ★ 			

ALL THE COMPONENTS LISTED IN OUR CATALOGUE ARE NOT ORIGINAL, THOUGH PERFECTLY INTERCHANGEABLE. REFERENCE NUMBERS, EITHER ORIGINAL OR OF A DIFFERENT NATURE, ARE FOR INFORMATION PURPOSES ONLY. WHEN PLACING AN ORDER, PLEASE, ALWAYS USE COSIBO REFERENCE NUMBERS AND DO NOT MENTION THE ORIGINAL REFERENCE NUMBERS OF THE TRUCK MANUFACTURERS IN THE INVOICE TO VEHICLE OWNERS OR TO ANYBODY ELSE. THE CUSTOMER TAKES HIS OWN RESPONSIBILITY IF HE DOES NOT COMPLY WITH WHAT ABOVE.

	Code	OEM new	OEM old
<p>CLAMP D.18</p> 	64092	813938	
<ul style="list-style-type: none"> ● Model ★ Application 			
<ul style="list-style-type: none"> ● F-K-N BUS ★ 			
<ul style="list-style-type: none"> ● IND. MARINE ENGINE 4 ★ 			
<ul style="list-style-type: none"> ● 3 TRUCK ★ 			
<ul style="list-style-type: none"> ● 4 TRUCK ★ 			
<p>CLAMP D.22</p> 	64093	813940	
<ul style="list-style-type: none"> ● 3 BUS ★ 			
<ul style="list-style-type: none"> ● 3 TRUCK ★ 			
<p>CLAMP D. 45</p> 	64094	813942	
<ul style="list-style-type: none"> ● 3 TRUCK ★ 			
<p>CLAMP D.28</p> 	64095	804578	
<ul style="list-style-type: none"> ● 3 TRUCK ★ 			

ALL THE COMPONENTS LISTED IN OUR CATALOGUE ARE NOT ORIGINAL, THOUGH PERFECTLY INTERCHANGEABLE. REFERENCE NUMBERS, EITHER ORIGINAL OR OF A DIFFERENT NATURE, ARE FOR INFORMATION PURPOSES ONLY. WHEN PLACING AN ORDER, PLEASE, ALWAYS USE COSIBO REFERENCE NUMBERS AND DO NOT MENTION THE ORIGINAL REFERENCE NUMBERS OF THE TRUCK MANUFACTURERS IN THE INVOICE TO VEHICLE OWNERS OR TO ANYBODY ELSE. THE CUSTOMER TAKES HIS OWN RESPONSIBILITY IF HE DOES NOT COMPLY WITH WHAT ABOVE.

CLAMP D.32



● Model
★ Application

	Code	OEM new	OEM old
	64100	804583	
● 3 BUS			
★			
● 4 BUS			
★			
● 3 TRUCK			
★			

ALL THE COMPONENTS LISTED IN OUR CATALOGUE ARE NOT ORIGINAL, THOUGH PERFECTLY INTERCHANGEABLE. REFERENCE NUMBERS, EITHER ORIGINAL OR OF A DIFFERENT NATURE, ARE FOR INFORMATION PURPOSES ONLY. WHEN PLACING AN ORDER, PLEASE, ALWAYS USE COSIBO REFERENCE NUMBERS AND DO NOT MENTION THE ORIGINAL REFERENCE NUMBERS OF THE TRUCK MANUFACTURERS IN THE INVOICE TO VEHICLE OWNERS OR TO ANYBODY ELSE. THE CUSTOMER TAKES HIS OWN RESPONSIBILITY IF HE DOES NOT COMPLY WITH WHAT ABOVE.

GEAR LEVER JOINT



- Model
 - ★ Application
-
- P-G-R-T TRUCK
 - ★

Code	OEM new	OEM old
65528	1768957	

ALL THE COMPONENTS LISTED IN OUR CATALOGUE ARE NOT ORIGINAL, THOUGH PERFECTLY INTERCHANGEABLE. REFERENCE NUMBERS, EITHER ORIGINAL OR OF A DIFFERENT NATURE, ARE FOR INFORMATION PURPOSES ONLY. WHEN PLACING AN ORDER, PLEASE, ALWAYS USE COSIBO REFERENCE NUMBERS AND DO NOT MENTION THE ORIGINAL REFERENCE NUMBERS OF THE TRUCK MANUFACTURERS IN THE INVOICE TO VEHICLE OWNERS OR TO ANYBODY ELSE. THE CUSTOMER TAKES HIS OWN RESPONSIBILITY IF HE DOES NOT COMPLY WITH WHAT ABOVE.

CENTER BEARING



	Code	OEM new	OEM old
● Model	64522	294271	
★ Application			
● 3 BUS			
★ PF40/P410			
● 3 TRUCK			
★ PF30/P310 - PF40/P410 - PF50/P510 - PF60/P610 - P510			

CENTER BEARING



	64522/1	294270	
● 3 BUS			
★ PF40/P410			
● 3 TRUCK			
★ PF30/P310 - PF40/P410 - PF50/P510 - PF60/P610 - P510			

CENTER BEARING



	62041	1113033	
● 3 TRUCK			
★ PF30/P310 - PF40/P410 - PF50/P510 - PF60/P610 - PF60/P610 6X2 6X4 8X2 8X4 - P410 - P410 GA750 4X2/Z 6X2B/Z R641/642 93ML/HL - P410 GA750 4X2B R641/642 93MV - P410 GA750 6X2/4B R641/642 93ML - P410 GA850R 4X2B/Z 6X2B/Z R660 93/113 ML/HL			
● 4 TRUCK			
★ P610 4X4 6X6 - P610 124CB6X6NZ ad 6300 GRS890/900R RBP730/832 - P310/410/510 - P510 124CB6X6HZ ad 6300 GRS890/900R RBP730/832			
● P-G-R-T TRUCK			
★ P610 4X4 6X6			
● 3 BUS			
★ PF40/P410 - P410			
● 4 BUS			
★ P310/410			

ALL THE COMPONENTS LISTED IN OUR CATALOGUE ARE NOT ORIGINAL, THOUGH PERFECTLY INTERCHANGEABLE. REFERENCE NUMBERS, EITHER ORIGINAL OR OF A DIFFERENT NATURE, ARE FOR INFORMATION PURPOSES ONLY. WHEN PLACING AN ORDER, PLEASE, ALWAYS USE COSIBO REFERENCE NUMBERS AND DO NOT MENTION THE ORIGINAL REFERENCE NUMBERS OF THE TRUCK MANUFACTURERS IN THE INVOICE TO VEHICLE OWNERS OR TO ANYBODY ELSE. THE CUSTOMER TAKES HIS OWN RESPONSIBILITY IF HE DOES NOT COMPLY WITH WHAT ABOVE.

		Code	OEM new	OEM old
CENTER BEARING	● Model	64524	1113031	
	★ Application			
	● 3 TRUCK			
	★	PF30/P310 - PF40/P410 - PF50/P510 - PF60/P610 - PF60/P610 6X2 6X4 8X2 8X4 - P410 - P410 GA750 4X2/Z 6X2B/Z R641/642 93ML/HL - P410 GA750 4X2B R641/642 93MV - P410 GA750 6X2/4B R641/642 93ML - P410 GA850R 4X2B/Z 6X2B/Z R660 93/113 ML/HL		
	● 4 TRUCK			
	★	P610 4X4 6X6 - P610 124CB6X6NZ ad 6300 GRS890/900R RBP730/832 - P310/410/510 - P510 124CB6X6HZ ad 6300 GRS890/900R RBP730/832		
	● P-G-R-T TRUCK			
	★	P610 4X4 6X6		
	● 3 BUS			
	★	PF40/P410 - P410		
● 4 BUS				
★	P310/410			



CENTER BEARING		64633	1387764	
	● 4 TRUCK			
	★	P310/410/510/610/612		
	● P-G-R-T TRUCK			
	★	P310/410/510/610/612		
	● 4 BUS			
	★	P310/410		



CENTER BEARING		64634	1387794	
	● 4 TRUCK			
	★	P310/410/510/610/612		
	● P-G-R-T TRUCK			
	★	P310/410/510/610/612		
	● 4 BUS			
	★	P310/410		



ALL THE COMPONENTS LISTED IN OUR CATALOGUE ARE NOT ORIGINAL, THOUGH PERFECTLY INTERCHANGEABLE. REFERENCE NUMBERS, EITHER ORIGINAL OR OF A DIFFERENT NATURE, ARE FOR INFORMATION PURPOSES ONLY. WHEN PLACING AN ORDER, PLEASE, ALWAYS USE COSIBO REFERENCE NUMBERS AND DO NOT MENTION THE ORIGINAL REFERENCE NUMBERS OF THE TRUCK MANUFACTURERS IN THE INVOICE TO VEHICLE OWNERS OR TO ANYBODY ELSE. THE CUSTOMER TAKES HIS OWN RESPONSIBILITY IF HE DOES NOT COMPLY WITH WHAT ABOVE.

	Code	OEM new	OEM old
LOCK NUT	65091	315085	
<ul style="list-style-type: none"> ● Model Application ● 3 TRUCK ★ PF30/310 - PF40/P410 - PF50/P510 - PF40 4X2 6X2 TELMA - PF50 GR880T 4X2 6X2 6X4 TELMA - PF50 4X2 6X2 6X4 TELMA - P510 6X4 TELMA ● 3 BUS ★ PF40/P410 			



PROPELLER SHAFT BEARING SLEEVE	63749	304332	
<ul style="list-style-type: none"> ● 3 BUS ★ PF40/P410 CH 1816293 			



LOCK NUT	60836	1525988	387877
<ul style="list-style-type: none"> ● 3 BUS ★ PF40/P410 - PF50/P510 - PF60/P610 ● 3 TRUCK ★ PF30/P310 - PF40/P410 ● 4 BUS ★ P310/410 ● 4 TRUCK ★ P310/410/510/610/612 - R560/660/780 - RB660/662 - RBP730/735/832/835 - RP730/731/735/832/835 ● P-G-R-T TRUCK ★ P310/410/510/610/612 			



ALL THE COMPONENTS LISTED IN OUR CATALOGUE ARE NOT ORIGINAL, THOUGH PERFECTLY INTERCHANGEABLE. REFERENCE NUMBERS, EITHER ORIGINAL OR OF A DIFFERENT NATURE, ARE FOR INFORMATION PURPOSES ONLY. WHEN PLACING AN ORDER, PLEASE, ALWAYS USE COSIBO REFERENCE NUMBERS AND DO NOT MENTION THE ORIGINAL REFERENCE NUMBERS OF THE TRUCK MANUFACTURERS IN THE INVOICE TO VEHICLE OWNERS OR TO ANYBODY ELSE. THE CUSTOMER TAKES HIS OWN RESPONSIBILITY IF HE DOES NOT COMPLY WITH WHAT ABOVE.

UNIVERSAL JOINT DIAM.=38 mm



● Model

★ Application

Code

OEM new

OEM old

60237

1879537

1111745
1422433
1765828
337058

● 4 BUS

★ P300/310

● 3 TRUCK

★ P30 - PF30/P310 - P300

● 4 TRUCK

★ P300/310

● P-G-R-T TRUCK

★ P300/310

UNIVERSAL JOINT DIAM.=48 mm



60238

1797424

1541070
1766466
337059
365901

● 3 BUS

★ P40 GA775/781/781R R642 - P400/410 - PF40/P410

● 4 BUS

★ P400/410

● 3 TRUCK

★ P40 - P400/410 - P400 MK/HK/EK - P420 BETWEEN REAR AXLES 6X4/6X6/8X4 - PF40/P410 - P410 GA750 4X2B/4X2Z/6X2B/6X2Z R641/642 93ML/HL - P410 GA750 4X2B/6X2B R641/642 93MV - P410 GA750 6X2/4B R641/642 93ML - P410 GA850R 4X2B/4X2Z/6X2B/6X2Z R660 93/113 ML/HL - PF40 4X2 - 6X2

● 4 TRUCK

★ P400/460 4X4 6X6 8X6/4 8X8

● P-G-R-T TRUCK

★ P420 RB600/700/800 - P400/460 4X4 6X6 8X6/4 8X8 - RBP735/835 ad1350/1355/1445 mm

ALL THE COMPONENTS LISTED IN OUR CATALOGUE ARE NOT ORIGINAL, THOUGH PERFECTLY INTERCHANGEABLE. REFERENCE NUMBERS, EITHER ORIGINAL OR OF A DIFFERENT NATURE, ARE FOR INFORMATION PURPOSES ONLY. WHEN PLACING AN ORDER, PLEASE, ALWAYS USE COSIBO REFERENCE NUMBERS AND DO NOT MENTION THE ORIGINAL REFERENCE NUMBERS OF THE TRUCK MANUFACTURERS IN THE INVOICE TO VEHICLE OWNERS OR TO ANYBODY ELSE. THE CUSTOMER TAKES HIS OWN RESPONSIBILITY IF HE DOES NOT COMPLY WITH WHAT ABOVE.

UNIVERSAL JOINT DIA.=57 MM



	Code	OEM new	OEM old
● Model	60239	1797425	1541071
★ Application			1750308
			1766467
			337060
			366437
			390225

● 3 TRUCK
★ P50 - P50 TELMA - P500/540 - P520 6X4 6X6 8X4 - P50 GR880T TELMA - P500 TELMA - PF50/P510 - PF50 GR880T 4X2 6X2 6X4 TELMA - P510 6X4 TELMA

● 4 TRUCK
★ P500 4X4 6X6 8X8 - P510 124 CB6X6 HZ ad6300 GRS890/900R RBP730/832 - P520 RB660/662 RBP 832/835 -

● P-G-R-T TRUCK
★ P500 4X4 6X6 8X8 - P420 RB600/660/800 - P420/520 RB600/800 - RBP835

UNIVERSAL JOINT DIAM.=65 mm



	61652	1879541	1422442 1541072 386073
--	--------------	---------	------------------------------

● 3 TRUCK
★ P60/600/610 - PF60

● 4 TRUCK
★ P600/602/610/612/640

● P-G-R-T TRUCK
★ P600/602/610/612

ALL THE COMPONENTS LISTED IN OUR CATALOGUE ARE NOT ORIGINAL, THOUGH PERFECTLY INTERCHANGEABLE. REFERENCE NUMBERS, EITHER ORIGINAL OR OF A DIFFERENT NATURE, ARE FOR INFORMATION PURPOSES ONLY. WHEN PLACING AN ORDER, PLEASE, ALWAYS USE COSIBO REFERENCE NUMBERS AND DO NOT MENTION THE ORIGINAL REFERENCE NUMBERS OF THE TRUCK MANUFACTURERS IN THE INVOICE TO VEHICLE OWNERS OR TO ANYBODY ELSE. THE CUSTOMER TAKES HIS OWN RESPONSIBILITY IF HE DOES NOT COMPLY WITH WHAT ABOVE.

UNIVERSAL JOINT DIAM.48



	Code	OEM new	OEM old
● Model	64335	1765829	1879538
★ Application			
● 4 BUS			
★ P400 - P410			
● F-K-N BUS			
★ P404			
● 4 TRUCK			
★ P400 - P410 - P460			
● P-G-R-T TRUCK			
★ P400 - P410			

SCREW M12X50



	64397	1757877	1344182 1117597 1328597 313228
● 4 BUS			
★ L 94			
● F-K-N BUS			
★			
● P-G-R-T TRUCK			
★ D13			

ALL THE COMPONENTS LISTED IN OUR CATALOGUE ARE NOT ORIGINAL, THOUGH PERFECTLY INTERCHANGEABLE. REFERENCE NUMBERS, EITHER ORIGINAL OR OF A DIFFERENT NATURE, ARE FOR INFORMATION PURPOSES ONLY. WHEN PLACING AN ORDER, PLEASE, ALWAYS USE COSIBO REFERENCE NUMBERS AND DO NOT MENTION THE ORIGINAL REFERENCE NUMBERS OF THE TRUCK MANUFACTURERS IN THE INVOICE TO VEHICLE OWNERS OR TO ANYBODY ELSE. THE CUSTOMER TAKES HIS OWN RESPONSIBILITY IF HE DOES NOT COMPLY WITH WHAT ABOVE.

KING PIN SET



- Model
- ★ Application

Code	OEM new	OEM old
60845	550722	

- **3 TRUCK**
- ★ AM70 UP TO CH 1161721 - CH 4292924

KING PIN SET



- **3 TRUCK**
- ★ AM70 FROM CH 1161722 - CH 4292925

60849	550731	
--------------	--------	--

KING PIN SET



- **3 TRUCK**
- ★ AM/AMA56 - 61/AMI61
- **3 BUS**
- ★ N113CLB - AM/AMA56 - 61/AMI61

60838	550730	550729
--------------	--------	--------

ALL THE COMPONENTS LISTED IN OUR CATALOGUE ARE NOT ORIGINAL, THOUGH PERFECTLY INTERCHANGEABLE. REFERENCE NUMBERS, EITHER ORIGINAL OR OF A DIFFERENT NATURE, ARE FOR INFORMATION PURPOSES ONLY. WHEN PLACING AN ORDER, PLEASE, ALWAYS USE COSIBO REFERENCE NUMBERS AND DO NOT MENTION THE ORIGINAL REFERENCE NUMBERS OF THE TRUCK MANUFACTURERS IN THE INVOICE TO VEHICLE OWNERS OR TO ANYBODY ELSE. THE CUSTOMER TAKES HIS OWN RESPONSIBILITY IF HE DOES NOT COMPLY WITH WHAT ABOVE.

KING PIN SET



● Model

★ Application

Code

OEM new

OEM old

65193

550284

● 4 BUS

★ AM/AMA CH 1219063 - CH 1827102 - CH 4359880 - CH 9014420 - CH 3500760 - AMA860D CH 1223049 - CH 4365790 - CH 9017349 - AMA860 CH 1223050 - CH 4365791 - CH 9017350 - AM860 - ARA860D 6X2/4

● F-K-N BUS

★ AM/AMA CH 1219063 - CH 1827102 - CH 4359880 - CH 9014420 - CH 3500760 - ARA860

● 4 TRUCK

★ AM/AMA CH 1219063 - CH 1827102 - CH 4359880 - CH 9014420 - CH 3500760 - AMA860D CH 1223049 - CH 4365790 - CH 9017349 - AMA860 CH 1223050 - CH 4365791 - CH 9017350 - ARA760/820/900

● P-G-R-T TRUCK

★ AM/AMA CH 1219063 - CH 1827102 - CH 4359880 - CH 9014420 - CH 3500760 - ARA760/820/900

KING PIN SET



65194

550257

● 4 BUS

★ AM/AMA CH 1219062 - CH 1827401 - CH 4359879 - CH 9014419 - CH 3500759

● F-K-N BUS

★ AM/AMA CH 1219062 - CH 1827401 - CH 4359879 - CH 9014419 - CH 3500759

● 3 TRUCK

★ AM800/820 -

● 4 TRUCK

★ AM/AMA CH 1219062 - CH 1827401 - CH 4359879 - CH 9014419 - CH 3500759

● P-G-R-T TRUCK

★ AM/AMA CH 1219062 - CH 1827401 - CH 4359879 - CH 9014419 - CH 3500759

ALL THE COMPONENTS LISTED IN OUR CATALOGUE ARE NOT ORIGINAL, THOUGH PERFECTLY INTERCHANGEABLE. REFERENCE NUMBERS, EITHER ORIGINAL OR OF A DIFFERENT NATURE, ARE FOR INFORMATION PURPOSES ONLY. WHEN PLACING AN ORDER, PLEASE, ALWAYS USE COSIBO REFERENCE NUMBERS AND DO NOT MENTION THE ORIGINAL REFERENCE NUMBERS OF THE TRUCK MANUFACTURERS IN THE INVOICE TO VEHICLE OWNERS OR TO ANYBODY ELSE. THE CUSTOMER TAKES HIS OWN RESPONSIBILITY IF HE DOES NOT COMPLY WITH WHAT ABOVE.

BUSHING DIA.45x50x50



	Code	OEM new	OEM old
● Model	65288	1343373	
★ Application			
● 4 BUS			
★			
● F-K-N BUS			
★			
● 3 TRUCK			
★			
● 4 TRUCK			
★			
● P-G-R-T TRUCK			
★			

DIFFERENTIAL LOCK ASSY



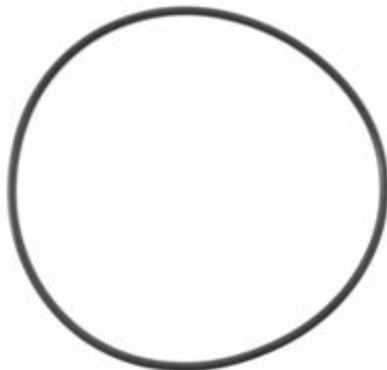

	65460	2030276	1908858
● P-G-R-T TRUCK			
★ RP376 - RBP376			

O-RING





	64790	804670	
● 3 TRUCK			
★ AM800/820			

ALL THE COMPONENTS LISTED IN OUR CATALOGUE ARE NOT ORIGINAL, THOUGH PERFECTLY INTERCHANGEABLE. REFERENCE NUMBERS, EITHER ORIGINAL OR OF A DIFFERENT NATURE, ARE FOR INFORMATION PURPOSES ONLY. WHEN PLACING AN ORDER, PLEASE, ALWAYS USE COSIBO REFERENCE NUMBERS AND DO NOT MENTION THE ORIGINAL REFERENCE NUMBERS OF THE TRUCK MANUFACTURERS IN THE INVOICE TO VEHICLE OWNERS OR TO ANYBODY ELSE. THE CUSTOMER TAKES HIS OWN RESPONSIBILITY IF HE DOES NOT COMPLY WITH WHAT ABOVE.

	Code	OEM new	OEM old
TIE ROD	60985	1897335	1369411 1379168 1385251 1409918 1501030 1723895 1737683
			
● Model			
★ Application			
● 4 TRUCK			
★ AM/AMA740 - AM/AMA740D - AMA740 8X2 8X2/6 8X4			
● P-G-R-T TRUCK			
★ AM740 - AM740D			
TIE ROD	63803	395432	
			
● 3 BUS			
★ AM56 - AM61			
● 3 TRUCK			
★ ARA56 - ARA61 - AM56 - AM61			
● 4 TRUCK			
★ AM620/920 8X2 8X2/6 8X4			
● P-G-R-T TRUCK			
★ AM920			
TIE ROD	64310	2146105	2040254 1361413 1395614 1734019 1897333
			
● 4 BUS			
★ AMA860 - AMA860D - AM860 - AMA780 - AMA780D - ARA860D			
● F-K-N BUS			
★ AMA860 - AMA860D - AMA780 - AMA780D - ARA860D			
● 4 TRUCK			
★ AMA860D - AMA860 - AM860 - ARA900 - ARA900D - ARA760 - ARA760D			
● P-G-R-T TRUCK			
★ AMA860 - AMA860D - AM860 - AM860D - ARA760 - ARA900			

ALL THE COMPONENTS LISTED IN OUR CATALOGUE ARE NOT ORIGINAL, THOUGH PERFECTLY INTERCHANGEABLE. REFERENCE NUMBERS, EITHER ORIGINAL OR OF A DIFFERENT NATURE, ARE FOR INFORMATION PURPOSES ONLY. WHEN PLACING AN ORDER, PLEASE, ALWAYS USE COSIBO REFERENCE NUMBERS AND DO NOT MENTION THE ORIGINAL REFERENCE NUMBERS OF THE TRUCK MANUFACTURERS IN THE INVOICE TO VEHICLE OWNERS OR TO ANYBODY ELSE. THE CUSTOMER TAKES HIS OWN RESPONSIBILITY IF HE DOES NOT COMPLY WITH WHAT ABOVE.

		Code	OEM new	OEM old
TIE ROD 	<ul style="list-style-type: none"> ● Model ★ Application 	61499	2028998	1378435
				1397866
		395350		
		1734020		
	<ul style="list-style-type: none"> ● 3 BUS 			
	<ul style="list-style-type: none"> ★ AM56 - AM61 			
	<ul style="list-style-type: none"> ● 3 TRUCK 			
	<ul style="list-style-type: none"> ★ AM56 - AM61 - AM800 - AM820 - ARA56 - ARA61 			
	<ul style="list-style-type: none"> ● 4 BUS 			
	<ul style="list-style-type: none"> ★ AM920 			
<ul style="list-style-type: none"> ● 4 TRUCK 				
<ul style="list-style-type: none"> ★ AM620 - AM900 - AM920 - AM920D - AM621 - AM820D - ARA820 - ARA820D 				
<ul style="list-style-type: none"> ● F-K-N BUS 				
<ul style="list-style-type: none"> ★ AM920 				
<ul style="list-style-type: none"> ● P-G-R-T TRUCK 				
<ul style="list-style-type: none"> ★ AM620 - AM620D - AM900 - AM920 - AM920D - AM621 - AM820 				

TIE ROD 		65416	1897336	
	<ul style="list-style-type: none"> ● P-G-R-T TRUCK ★ AM950 			

ALL THE COMPONENTS LISTED IN OUR CATALOGUE ARE NOT ORIGINAL, THOUGH PERFECTLY INTERCHANGEABLE. REFERENCE NUMBERS, EITHER ORIGINAL OR OF A DIFFERENT NATURE, ARE FOR INFORMATION PURPOSES ONLY. WHEN PLACING AN ORDER, PLEASE, ALWAYS USE COSIBO REFERENCE NUMBERS AND DO NOT MENTION THE ORIGINAL REFERENCE NUMBERS OF THE TRUCK MANUFACTURERS IN THE INVOICE TO VEHICLE OWNERS OR TO ANYBODY ELSE. THE CUSTOMER TAKES HIS OWN RESPONSIBILITY IF HE DOES NOT COMPLY WITH WHAT ABOVE.

		Code	OEM new	OEM old
LH BALL JOINT	● Model	60521	1738380	1358792 283783 395009
	★ Application			
	● 3 BUS			
	★	AM56 - AM61 - AMA56 - AMA61		
	● 4 BUS			
	★	AM920		
	● F-K-N BUS			
	★	AM920		
	● 3 TRUCK			
	★	AM56 CP/CR 4X2 6X2 6X2/4 6X4 8X4 - AM61 4X2 6X2 6X2/4 6X4 8X2 8X4 - AM800 EK 6X4 8X4 - AM820 4X2 6X2 6X4 8X2 8X4 - AM61 EK/HK 8X4		
	● 4 TRUCK			
	★	AM620 8X2 8X2/6 8X4 - AM621 - AM820D - AM900 8X4 - AM920 8X2 8X2/6 8X4 - AM920D		
● P-G-R-T TRUCK				
★	AM620 - AM620D - AM621 - AM820 - AM900 - AM920 - AM920D			

		60522	1358793	283784 395010
RH BALL JOINT	● 3 BUS			
	★	AM56 - AM61 - AMA56 - AMA61		
	● 4 BUS			
	★	AM920		
	● F-K-N BUS			
	★	AM920		
	● 3 TRUCK			
	★	AM56 CP/CR 4X2 6X2 6X2/4 6X4 8X4 - AM61 4X2 6X2 6X2/4 6X4 8X2 8X4 - AM800 EK 6X4 8X4 - AM820 4X2 6X2 6X4 8X2 8X4 - AM61 EK/HK 8X4		
	● 4 TRUCK			
	★	AM620 8X2 8X2/6 8X4 - AM621 - AM820D - AM900 8X4 - AM920 8X2 8X2/6 8X4 - AM920D		
	● P-G-R-T TRUCK			
	★	AM620 - AM620D - AM621 - AM820 - AM900 - AM920 - AM920D		

ALL THE COMPONENTS LISTED IN OUR CATALOGUE ARE NOT ORIGINAL, THOUGH PERFECTLY INTERCHANGEABLE. REFERENCE NUMBERS, EITHER ORIGINAL OR OF A DIFFERENT NATURE, ARE FOR INFORMATION PURPOSES ONLY. WHEN PLACING AN ORDER, PLEASE, ALWAYS USE COSIBO REFERENCE NUMBERS AND DO NOT MENTION THE ORIGINAL REFERENCE NUMBERS OF THE TRUCK MANUFACTURERS IN THE INVOICE TO VEHICLE OWNERS OR TO ANYBODY ELSE. THE CUSTOMER TAKES HIS OWN RESPONSIBILITY IF HE DOES NOT COMPLY WITH WHAT ABOVE.

	Code	OEM new	OEM old
BALL JOINT	64343	1738379	1357674
<ul style="list-style-type: none"> ● Model ★ Application 			
<ul style="list-style-type: none"> ● 4 BUS ★ AMA780 - AMA780D - AM860 - AMA860 - AMA860D 			
<ul style="list-style-type: none"> ● F-K-N BUS ★ AMA780D - AMA860 - AMA860D 			
<ul style="list-style-type: none"> ● 4 TRUCK ★ AM860 - AMA860 8X2 8X2/6 8X4 - AMA860D 			
<ul style="list-style-type: none"> ● P-G-R-T TRUCK ★ AM860 - AM860D - AMA860 - AMA860D 			



LH BALL JOINT	60861	1337366	352645
<ul style="list-style-type: none"> ● 3 TRUCK ★ AM70 4X2 6X2 6X4 8X2 8X4 			



RH BALL JOINT	60862	1337367	352646
<ul style="list-style-type: none"> ● 3 TRUCK ★ AM70 4X2 6X2 6X4 8X2 8X4 			



LH BALL JOINT



	Code	OEM new	OEM old
● Model	60859	310979	
★ Application			
● 3 BUS			
★ AM61 - AMA56/61			
● 3 TRUCK			
★ AM56 G93 4X2 - CG13 - AM56/61 R113/143 4X2A - AM56/61 P93 4X2A R93 4X2A - AMA56/61 4X2 6X2 6X4			
● 4 BUS			
★ AMA60			

RH BALL JOINT



	Code	OEM new	OEM old
	60860	310980	
● 3 BUS			
★ AM61 - AMA56/61			
● 3 TRUCK			
★ AM56 G93 4X2 - CG13 - AM56/61 R113/143 4X2A - AM56/61 P93 4X2A R93 4X2A - AMA56/61 4X2 6X2 6X4			
● 4 BUS			
★ AMA60			

WHEEL SPEED SENSOR SET



	Code	OEM new	OEM old
	64818	1892053	1530699
● P-G-R-T TRUCK			
★ AND900			

ALL THE COMPONENTS LISTED IN OUR CATALOGUE ARE NOT ORIGINAL, THOUGH PERFECTLY INTERCHANGEABLE. REFERENCE NUMBERS, EITHER ORIGINAL OR OF A DIFFERENT NATURE, ARE FOR INFORMATION PURPOSES ONLY. WHEN PLACING AN ORDER, PLEASE, ALWAYS USE COSIBO REFERENCE NUMBERS AND DO NOT MENTION THE ORIGINAL REFERENCE NUMBERS OF THE TRUCK MANUFACTURERS IN THE INVOICE TO VEHICLE OWNERS OR TO ANYBODY ELSE. THE CUSTOMER TAKES HIS OWN RESPONSIBILITY IF HE DOES NOT COMPLY WITH WHAT ABOVE.

		Code	OEM new	OEM old
MAGNETIC PLUG	● Model	63109	1460812	
	★ Application			
	● 4 TRUCK			
	★	ADA1500P RP832 4X2 6X2 6X4 6X6 8X2 8X4 6X6 CA 4X4 - ADA1300 ELC 1 R780 - AD1300 R560 R660 R780 R782 - ADA1300 R560 R660 RB660/662 R780/782 - AD1300 RB660 RB662 6X4 8X4 - AD1100P RBP730 6X4 6X4 8X4 - RP730 6X4 6X6 8X4 - AD1500P RBP832 6X4 6X6 8X4 BT300 - AD1500P RP832(REAR) 6X4 6X6 8X4 BT300 - AD1500P RP832 CB4X4 - ADA1100 R560 R660/662 RB660 R780/782 - AD1101P RBP735 - AD1101P RP735 (REAR) - ADA1501P RP835 4X2 6X2 8X2 8X2/4 - AD501P RP835 4X2 6X2 8X2 A4X4 - AD1501P RP/RBP835 B4X4 6X6(REAR) - AD1501P RP835 RBP835 6X4 8X4 BT300 - AD1300 R660(REAR) 6X4 8X4		
	● P-G-R-T TRUCK			
	★	AD1300 RB600/662 BT201B/I - R560 R660 - R660(REAR) BT201B/I - R780/782 - AD1100 RB660 - AD1300 R660(REAR) 6X4 8X4 - AD1300 RB660 RB662 6X4 8X4 - ADA1300 RB660/662 R560 R660 - R660(REAR) - R780/782 - ADA1100 R560 R660/662 R660(REAR) R780/782 RB660/662 - AD1101P RBP735 RP735(REAR) - ADA1501P RP835 - AD1501P RP835 - RP835(REAR) RBP835 BT300B - ADA1302 R560 R660 R780/782 - ADA1502P RP835		

		60836	1525988	387877
LOCK NUT	● 4 TRUCK			
	★	RP/731/736		
	● P-G-R-T TRUCK			
	★	RP731/736		

ALL THE COMPONENTS LISTED IN OUR CATALOGUE ARE NOT ORIGINAL, THOUGH PERFECTLY INTERCHANGEABLE. REFERENCE NUMBERS, EITHER ORIGINAL OR OF A DIFFERENT NATURE, ARE FOR INFORMATION PURPOSES ONLY. WHEN PLACING AN ORDER, PLEASE, ALWAYS USE COSIBO REFERENCE NUMBERS AND DO NOT MENTION THE ORIGINAL REFERENCE NUMBERS OF THE TRUCK MANUFACTURERS IN THE INVOICE TO VEHICLE OWNERS OR TO ANYBODY ELSE. THE CUSTOMER TAKES HIS OWN RESPONSIBILITY IF HE DOES NOT COMPLY WITH WHAT ABOVE.

SOLENOID VALVE



- Model
- ★ Application

Code

OEM new

OEM old

65191

2038653

1536304
1340231
1421322

- 3 TRUCK

- ★ RP630 AMD 105

- 4 TRUCK

- ★ RP731 RP736

SOLENOID VALVE



- P-G-R-T TRUCK

- ★ RP731/RP736

65470

1376794

SWITCH



- 4 TRUCK

- ★ RP736

64304

1472738

ALL THE COMPONENTS LISTED IN OUR CATALOGUE ARE NOT ORIGINAL, THOUGH PERFECTLY INTERCHANGEABLE. REFERENCE NUMBERS, EITHER ORIGINAL OR OF A DIFFERENT NATURE, ARE FOR INFORMATION PURPOSES ONLY. WHEN PLACING AN ORDER, PLEASE, ALWAYS USE COSIBO REFERENCE NUMBERS AND DO NOT MENTION THE ORIGINAL REFERENCE NUMBERS OF THE TRUCK MANUFACTURERS IN THE INVOICE TO VEHICLE OWNERS OR TO ANYBODY ELSE. THE CUSTOMER TAKES HIS OWN RESPONSIBILITY IF HE DOES NOT COMPLY WITH WHAT ABOVE.

	Code	OEM new	OEM old
SWITCH	65452	1541086	
<ul style="list-style-type: none"> ● Model ★ Application 			
<ul style="list-style-type: none"> ● 4 TRUCK ★ RP731 			
<ul style="list-style-type: none"> ● P-G-R-T TRUCK ★ PR731 			



CABLE HARNESS	65453	1424221	
<ul style="list-style-type: none"> ● 4 TRUCK ★ RP731 			
<ul style="list-style-type: none"> ● P-G-R-T TRUCK ★ PR731 			



CABLE HARNESS	65454	1549304	
<ul style="list-style-type: none"> ● 4 TRUCK ★ RP731 			
<ul style="list-style-type: none"> ● P-G-R-T TRUCK ★ PR731 			



TUBE L=568



	Code	OEM new	OEM old
● Model	61946	390533	
★ Application			
● 3 BUS			
★ AD90 - ADA90			
● 4 BUS			
★ ADA1300 4X2 6X2 IB/UBI - AD1300 R660 - F94 AD1300 R780 - ADA1300 4X2 6X2 6X2/4 EB/IB - ASA1300 6X2/2			
● F-K-N BUS			
★ ADA1300 4X2 6X2 6X2/4 EB/IB - ADA1300 4X2 6X2 UBI - ASA1300 6X2/2			
● 3 TRUCK			
★ AD90 R642/R660/R770/R780 - ADA90 R642/R660/R770/R780			
● 4 TRUCK			
★ AD1300 R560/R660/R780/782 - AD1300 R660 6X4 8X4 - AD1300 RB660/662 6X4 8X4 - ADA1100 R560/R660/RB660/662/R780/782 - ADA1300 R560/R660/R780/782 - ADA1300 RB660/662			
● P-G-R-T TRUCK			
★ AD1300 R560/R660/R780/782 - AD1300 R660 6X4 8X4 - AD1300 RB660/662 6X4 8X4 - ADA1100 R560/R660/RB660/662/R780/782 - ADA1300 R560/R660/R780/782 - ADA1300 RB660/662			

MAGNETIC PLUG



	63109	1460812	
● 3 BUS			
★ AD90 - ADA90			
● 4 BUS			
★ ASA1300 6X2/2 - ADA1500P RP832 RP835 - ADA1300 4X2 6X2 IB(8X2) - ADA1300 4X2 6X2 UB - AD1300 R660 - F94 AD1300 R780			
● F-K-N BUS			
★ ASA1300 6X2/2 - AD1300 R660 R780 - ADA1300D EB/IB/UB - ADA1300 4X2 6X2 UB - ADA1300 4X2 6X2*4 EB/IB(6X2/2 8X2)			
● 3 TRUCK			
★ AD80 R641 - AD90 R642 R660 - ADA90 RB652 R642 R652 R660			
● 4 TRUCK			
★ ADA1500P RP832 4X2 6X2 6X4 6X6 8X2 8X4 6X6 CA 4X4 - ADA1300 ELC 1 R780 - AD1300 R560 R660 R780 R782 - ADA1300 R560 R660 RB660/662 R780/782 - AD1300 RB660 RB662 6X4 8X4 - AD1100P RBP730 6X4 6X4 8X4 - RP730 6X4 6X6 8X4 - AD1500P RBP832 6X4 6X6 8X4 BT300 - AD1500P RP832(RE)			
● P-G-R-T TRUCK			
★ AD1300 RB600/662 BT201B/I - R560 R660 - R660(REAR) BT201B/I - R780/782 - AD1100 RB660 - AD1300 R660(REAR) 6X4 8X4 - AD1300 RB660 RB662 6X4 8X4 - ADA1300 RB660/662 R560 R660 - R660(REAR) - R780/782 - ADA1100 R560 R660/662 R660(REAR) R780/782 RB660/662 - AD1101P RPB735 RP735(RE)			

ALL THE COMPONENTS LISTED IN OUR CATALOGUE ARE NOT ORIGINAL, THOUGH PERFECTLY INTERCHANGEABLE. REFERENCE NUMBERS, EITHER ORIGINAL OR OF A DIFFERENT NATURE, ARE FOR INFORMATION PURPOSES ONLY. WHEN PLACING AN ORDER, PLEASE, ALWAYS USE COSIBO REFERENCE NUMBERS AND DO NOT MENTION THE ORIGINAL REFERENCE NUMBERS OF THE TRUCK MANUFACTURERS IN THE INVOICE TO VEHICLE OWNERS OR TO ANYBODY ELSE. THE CUSTOMER TAKES HIS OWN RESPONSIBILITY IF HE DOES NOT COMPLY WITH WHAT ABOVE.

		Code	OEM new	OEM old
MAGNETIC PLUG	● Model	61371	235434	153682
	★ Application			
	● 3 BUS			
	★	AD/ADA90		
	● 3 TRUCK			
	★	AD80 R641 R653 RB652 - AD/ADA90 R642 R653 R770 R780 RB652 - AD100 RP831 RP832 RBP831 RBP832 - AD85 RP730 RBP730 - R770		
	● 4 TRUCK			
★	ADA1100/1300 R780/782 - AD1500P RP832 RBP832			
● P-G-R-T TRUCK				
★	ADA1100/1300 R780/782			



ALL THE COMPONENTS LISTED IN OUR CATALOGUE ARE NOT ORIGINAL, THOUGH PERFECTLY INTERCHANGEABLE. REFERENCE NUMBERS, EITHER ORIGINAL OR OF A DIFFERENT NATURE, ARE FOR INFORMATION PURPOSES ONLY. WHEN PLACING AN ORDER, PLEASE, ALWAYS USE COSIBO REFERENCE NUMBERS AND DO NOT MENTION THE ORIGINAL REFERENCE NUMBERS OF THE TRUCK MANUFACTURERS IN THE INVOICE TO VEHICLE OWNERS OR TO ANYBODY ELSE. THE CUSTOMER TAKES HIS OWN RESPONSIBILITY IF HE DOES NOT COMPLY WITH WHAT ABOVE.

		Code	OEM new	OEM old
OIL FILTER	● Model	60434	2002705	1768402 1301696
	★ Application			
	● 4 BUS			
	★	R660 K/L94/114/124 - R660 F94 - RP835		
	● F-K-N BUS			
	★	R660/680		
	● 3 TRUCK			
	★	RBP730		
	● 4 TRUCK			
	★	RB660 6X4 8X4 8X4/4 - RB662 - RBP730/735/835 - R560/660/780/782 - RP735/835		
● P-G-R-T TRUCK				
★	RB660/662 - R650/660/780/782 - RP735/835 - RBP735/835			



OIL SEAL 85x105x13/18 (FOR SHAFT WITH COUNTERCLOCKWISE ROTATION)	63330	1502384	1300974 1380160 1393331
● 4 TRUCK			
★	RP731 - RP736		
● P-G-R-T TRUCK			
★	RP731 - RP736		



OIL SEAL 85x105x13/18 (FOR SHAFT WITH CLOCKWISE ROTATION)	63345	1502385	1383129 1386594
● 4 BUS			
★	RP832 - RP835 - R660 K/L 94/114/124-F 94 - R780 F 94		
● F-K-N BUS			
★	R660 - R680 - R780		
● 4 TRUCK			
★	RB660 - RB660 6X4 8X4 8X4/4 - RB662 - RP832 - R780 - R782 - R660/662(REAR) 6X4 8X4 8X4/4 - R660 - RBP832 - RP832(REAR) 6X4 8X4 6X6 8X6/4 - R560 - RBP730 - RBP735 - RP730(REAR) - RP735(REAR) - RP835(REAR) - RBP835 - RP835(REAR) FOR SHAFT WITH CLOCKWISE ROTATION		
● P-G-R-T TRUCK			
★	RB662 - R660 - RB660(REAR) - RB660 - R780 - RP735(REAR) - RP835(REAR) - RBP735 - RBP835 - R560 - R782		



ALL THE COMPONENTS LISTED IN OUR CATALOGUE ARE NOT ORIGINAL, THOUGH PERFECTLY INTERCHANGEABLE. REFERENCE NUMBERS, EITHER ORIGINAL OR OF A DIFFERENT NATURE, ARE FOR INFORMATION PURPOSES ONLY. WHEN PLACING AN ORDER, PLEASE, ALWAYS USE COSIBO REFERENCE NUMBERS AND DO NOT MENTION THE ORIGINAL REFERENCE NUMBERS OF THE TRUCK MANUFACTURERS IN THE INVOICE TO VEHICLE OWNERS OR TO ANYBODY ELSE. THE CUSTOMER TAKES HIS OWN RESPONSIBILITY IF HE DOES NOT COMPLY WITH WHAT ABOVE.

OIL SEAL 80X100X10



	Code	OEM new	OEM old
● Model	62460	1528991	1680726 388728
★ Application			
● 3 TRUCK			
★ RBP730			
● 4 TRUCK			
★ RP731 - RB660 6X4 8X4 8X4/4 - RBP730/735/835 - RB662			
● P-G-R-T TRUCK			
★ RB660/662 - RBP735/835			

BEARING SET



	62465	550813	
● 4 BUS			
★ F94 R780			
● F-K-N BUS			
★ R780			
● 3 TRUCK			
★ R780			
● 4 TRUCK			
★ R780			
● P-G-R-T TRUCK			
★ R780			

DIFFERENTIAL SPIDER



	65501	1444822	1325066 264906
● 4 BUS			
★ RP832			
● 3 TRUCK			
★ RP831 4X2 4X4 6X2 8X2 - RBP831/832 - RP832 4X2 4X4 6X2 8X2			
● 4 TRUCK			
★ RP832 6X4 8X4 6X6 8X6/4 - RB832 - RBP832			

ALL THE COMPONENTS LISTED IN OUR CATALOGUE ARE NOT ORIGINAL, THOUGH PERFECTLY INTERCHANGEABLE. REFERENCE NUMBERS, EITHER ORIGINAL OR OF A DIFFERENT NATURE, ARE FOR INFORMATION PURPOSES ONLY. WHEN PLACING AN ORDER, PLEASE, ALWAYS USE COSIBO REFERENCE NUMBERS AND DO NOT MENTION THE ORIGINAL REFERENCE NUMBERS OF THE TRUCK MANUFACTURERS IN THE INVOICE TO VEHICLE OWNERS OR TO ANYBODY ELSE. THE CUSTOMER TAKES HIS OWN RESPONSIBILITY IF HE DOES NOT COMPLY WITH WHAT ABOVE.

DIFFERENTIAL SIDE GEAR



	Code	OEM new	OEM old
● Model	65008	164433	
★ Application			
● 4 BUS			
★ RP832			
● 3 TRUCK			
★ RP831 4X2 4X4 6X2 8X2 - RBP831/832 - RP832 4X2 4X4 6X2 8X2			
● 4 TRUCK			
★ RP832 6X4 8X4 6X6 8X6/4 - RB832 - RBP832			

LOCK NUT



	60836	1525988	387877
● 3 BUS			
★ R642/660 - RV654/760/761			
● 3 TRUCK			
★ R641/642/660/770/780 - RP/RBP730/831/832 - RB652/653 AD80 - RB652/653 AD/ADA90			
● 4 BUS			
★ RP832/835 - R660/780 - K/L 94/114/124 - F 94			
● 4 TRUCK			
★ R560/660/662/780/782 - RB660/662 - RP/RBP730/735/832/835			
● F-K-N BUS			
★ R660/680/780			
● P-G-R-T TRUCK			
★ RB660/662 - R560/660/780/782 - RP/RBP735/835			

ALL THE COMPONENTS LISTED IN OUR CATALOGUE ARE NOT ORIGINAL, THOUGH PERFECTLY INTERCHANGEABLE. REFERENCE NUMBERS, EITHER ORIGINAL OR OF A DIFFERENT NATURE, ARE FOR INFORMATION PURPOSES ONLY. WHEN PLACING AN ORDER, PLEASE, ALWAYS USE COSIBO REFERENCE NUMBERS AND DO NOT MENTION THE ORIGINAL REFERENCE NUMBERS OF THE TRUCK MANUFACTURERS IN THE INVOICE TO VEHICLE OWNERS OR TO ANYBODY ELSE. THE CUSTOMER TAKES HIS OWN RESPONSIBILITY IF HE DOES NOT COMPLY WITH WHAT ABOVE.

DIFFERENTIAL HALF HOUSING



- Model
- ★ Application

Code

OEM new

OEM old

61640

1116847

- 3 TRUCK

- ★ R770

CROWN GEAR



65075

184808

- 3 TRUCK

- ★ AD80 RB652 - AD/ADA90 RB652

DIFFERENTIAL LOCK ASSY



65460

2030276

1908858

- 4 TRUCK

- ★ RB622

- F-K-N BUS

- ★ R660 - R665 - R680 - R780

- P-G-R-T TRUCK

- ★ R660 - RB660 - RB662 - R662 - RP735 - R780 - R782 - RBP835 - RP835

ALL THE COMPONENTS LISTED IN OUR CATALOGUE ARE NOT ORIGINAL, THOUGH PERFECTLY INTERCHANGEABLE. REFERENCE NUMBERS, EITHER ORIGINAL OR OF A DIFFERENT NATURE, ARE FOR INFORMATION PURPOSES ONLY. WHEN PLACING AN ORDER, PLEASE, ALWAYS USE COSIBO REFERENCE NUMBERS AND DO NOT MENTION THE ORIGINAL REFERENCE NUMBERS OF THE TRUCK MANUFACTURERS IN THE INVOICE TO VEHICLE OWNERS OR TO ANYBODY ELSE. THE CUSTOMER TAKES HIS OWN RESPONSIBILITY IF HE DOES NOT COMPLY WITH WHAT ABOVE.

OIL SEAL 90X110X13/9.5



	Code	OEM new	OEM old
● Model ★ Application	61010	214008	
● 3 TRUCK			
★ AD80 RB652 - AD/ADA90 RB652			

OIL SEAL 70X85X8



	Code	OEM new	OEM old
	63275	378480	
● 3 TRUCK			
★ RBP831 MK HK EK - RBP832			
● 4 TRUCK			
★ RBP832			

OIL SEAL 42X62X6



	Code	OEM new	OEM old
	63802	202288	
● 3 TRUCK			
★			
● 4 TRUCK			
★			
● P-G-R-T TRUCK			
★			

O-RING DIAM.26,2X3



	Code	OEM new	OEM old
	60635	197800	392661
● 3 TRUCK			
★ RBP730			
● 4 TRUCK			
★ RB660/662 - RBP730/735/835			
● P-G-R-T TRUCK			
★ RBP735/835 - RB660/662			

ALL THE COMPONENTS LISTED IN OUR CATALOGUE ARE NOT ORIGINAL, THOUGH PERFECTLY INTERCHANGEABLE. REFERENCE NUMBERS, EITHER ORIGINAL OR OF A DIFFERENT NATURE, ARE FOR INFORMATION PURPOSES ONLY. WHEN PLACING AN ORDER, PLEASE, ALWAYS USE COSIBO REFERENCE NUMBERS AND DO NOT MENTION THE ORIGINAL REFERENCE NUMBERS OF THE TRUCK MANUFACTURERS IN THE INVOICE TO VEHICLE OWNERS OR TO ANYBODY ELSE. THE CUSTOMER TAKES HIS OWN RESPONSIBILITY IF HE DOES NOT COMPLY WITH WHAT ABOVE.

	Code	OEM new	OEM old
O-RING	64778	1331820	
<ul style="list-style-type: none"> ● Model ★ Application 			
<ul style="list-style-type: none"> ● 3 TRUCK ★ RB652 AD80/AD90/ADA90 			

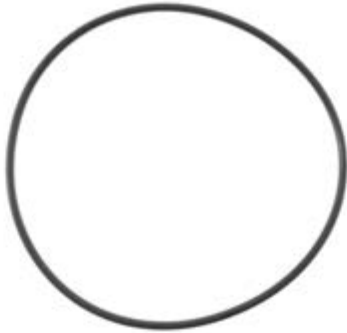

O-RING	63562	812418	182525
<ul style="list-style-type: none"> ● 3 TRUCK ★ 			



SCREW M12X50	64397	1757877	1344182 1117597 1328597 313228
<ul style="list-style-type: none"> ● 4 BUS ★ L 94 			
<ul style="list-style-type: none"> ● F-K-N BUS ★ 			
<ul style="list-style-type: none"> ● P-G-R-T TRUCK ★ D13 			



ALL THE COMPONENTS LISTED IN OUR CATALOGUE ARE NOT ORIGINAL, THOUGH PERFECTLY INTERCHANGEABLE. REFERENCE NUMBERS, EITHER ORIGINAL OR OF A DIFFERENT NATURE, ARE FOR INFORMATION PURPOSES ONLY. WHEN PLACING AN ORDER, PLEASE, ALWAYS USE COSIBO REFERENCE NUMBERS AND DO NOT MENTION THE ORIGINAL REFERENCE NUMBERS OF THE TRUCK MANUFACTURERS IN THE INVOICE TO VEHICLE OWNERS OR TO ANYBODY ELSE. THE CUSTOMER TAKES HIS OWN RESPONSIBILITY IF HE DOES NOT COMPLY WITH WHAT ABOVE.

	Code	OEM new	OEM old
WASHER	61586	1116848	
● Model			
★ Application			
● 3 BUS			
★ RV761			
● 4 BUS			
★ F94 R780			
● F-K-N BUS			
★ R780			
● 3 TRUCK			
★ R770/780			
● 4 TRUCK			
★ R780/782			
● P-G-R-T TRUCK			
★ R780/782			



	61585	1116698	
WASHER			
● 3 BUS			
★ RV761			
● 4 BUS			
★ F94 R780			
● F-K-N BUS			
★ R780			
● 3 TRUCK			
★ R770/780			
● 4 TRUCK			
★ R780/782			
● P-G-R-T TRUCK			
★ R780/782			



	Code	OEM new	OEM old
WASHER	61587	1116699	
● Model			
★ Application			
● 3 BUS			
★ RV761			
● 4 BUS			
★ F94 R780			
● F-K-N BUS			
★ R780			
● 3 TRUCK			
★ R770/780			
● 4 TRUCK			
★ R780/782			
● P-G-R-T TRUCK			
★ R780/782			



		Code	OEM new	OEM old
SWITCH	<ul style="list-style-type: none"> ● Model ★ Application 	61033	314572	
	<ul style="list-style-type: none"> ● 3 TRUCK ★ RBP831 - RBP831 MK/HK/EK 			



SWITCH		61953	1303472	375734
	<ul style="list-style-type: none"> ● 3 BUS ★ R642/660 - RV760/761 			
	<ul style="list-style-type: none"> ● 3 TRUCK ★ R641/642/660/770/780 - RP831 4X2 4X4 6X2 8X2 - RBP730/831/832 - RP832 4X2 4X4 6X2 8X2 			
	<ul style="list-style-type: none"> ● 4 BUS ★ F94 R780 			
	<ul style="list-style-type: none"> ● F-K-N BUS ★ R780 			









SWITCH		64304	1472738	
	<ul style="list-style-type: none"> ● 4 BUS ★ F94 R780 			
	<ul style="list-style-type: none"> ● 4 TRUCK ★ R660/780/782 - RB660/662 - RP735/835 - RBP735/835 			
	<ul style="list-style-type: none"> ● F-K-N BUS ★ R780 			
	<ul style="list-style-type: none"> ● P-G-R-T TRUCK ★ R660/780/782 - RB660/662 - RP735/835 - RBP735/835 			



		Code	OEM new	OEM old
SWITCH	● Model	63055	1303471	370710
	★ Application			
	● 3 TRUCK			
	★	G770 - G770 CAG - GS771 CAG - GR801 - GR801 CAG - GR871 - GR/GRE871T CAG - GR880 - GR880T - GRH880 - GR900 - GRH900 - GR/GRS900 - GRS900 CAG - GRS900 R - GS771/772 - GT811 - GR801/900 - CP/CR 93/113/143 LHD GR/GRH900 - CT93 - CP/CR/CT 113/143 RHD GR900 - CT RHD GR/GRS900R - CT 143 LHD/RHD GR/GRH900 - CR 143 LHD/RHD GR900 - CP 113 CR/CT 113/143 RHD GRS900 - CG/CP/CR RHD GR/GRH900 - EK300/EK310/EK330/EK340/EK422/EK423		
	● 4 TRUCK			
★	RP731			
● P-G-R-T TRUCK				
★	RP731			



	Code	OEM new	OEM old
LH BALL JOINT	60521	1738380	1358792 283783 395009
<ul style="list-style-type: none"> ● Model ★ Application 			
	● 3 TRUCK		
	★ ARA56 - ARA61 - AM61		
	● 4 TRUCK		
	★ ARA820 - ARA820D6X2/4 8X2/4		
	● P-G-R-T TRUCK		
	★ ARA820		
	60522	1358793	283784 395010
	RH BALL JOINT		
	● 3 TRUCK		
	★ ARA56 - ARA61 - AM61		
	● 4 TRUCK		
	★ ARA820 - ARA820D6X2/4 8X2/4		
	● P-G-R-T TRUCK		
	★ ARA820		
	64343	1738379	1357674
	BALL JOINT		
	● 4 BUS		
	★ ARA860D 6X2/4		
	● F-K-N BUS		
	★ ARA860D 6X2/4		
	● 4 TRUCK		
	★ ARA760 - ARA760D 6X2/4 - ARA900 - ARA900D 6X2/4 8X2/6		
	● P-G-R-T TRUCK		
	★ ARA760 - ARA900		

ALL THE COMPONENTS LISTED IN OUR CATALOGUE ARE NOT ORIGINAL, THOUGH PERFECTLY INTERCHANGEABLE. REFERENCE NUMBERS, EITHER ORIGINAL OR OF A DIFFERENT NATURE, ARE FOR INFORMATION PURPOSES ONLY. WHEN PLACING AN ORDER, PLEASE, ALWAYS USE COSIBO REFERENCE NUMBERS AND DO NOT MENTION THE ORIGINAL REFERENCE NUMBERS OF THE TRUCK MANUFACTURERS IN THE INVOICE TO VEHICLE OWNERS OR TO ANYBODY ELSE. THE CUSTOMER TAKES HIS OWN RESPONSIBILITY IF HE DOES NOT COMPLY WITH WHAT ABOVE.

REPAIR SET



- Model
- ★ Application

Code

OEM new

OEM old

63898

552004

- **3 TRUCK**

- ★ AS60/90

- **4 TRUCK**

- ★ AS900

- **P-G-R-T TRUCK**

- ★ AS900

ALL THE COMPONENTS LISTED IN OUR CATALOGUE ARE NOT ORIGINAL, THOUGH PERFECTLY INTERCHANGEABLE. REFERENCE NUMBERS, EITHER ORIGINAL OR OF A DIFFERENT NATURE, ARE FOR INFORMATION PURPOSES ONLY. WHEN PLACING AN ORDER, PLEASE, ALWAYS USE COSIBO REFERENCE NUMBERS AND DO NOT MENTION THE ORIGINAL REFERENCE NUMBERS OF THE TRUCK MANUFACTURERS IN THE INVOICE TO VEHICLE OWNERS OR TO ANYBODY ELSE. THE CUSTOMER TAKES HIS OWN RESPONSIBILITY IF HE DOES NOT COMPLY WITH WHAT ABOVE.

		Code	OEM new	OEM old
SOLENOID VALVE	● Model	65191	2038653	1536304 1340231 1421322
	★ Application			
	● 3 BUS			
	★			
	● 4 BUS			
	★ R660			
	● F-K-N BUS			
	★ OK			
	● 3 TRUCK			
	★ R641 R642 R660 R770 R780 - RBP831+RP831 - RB652+R653 - RP831/2 - 4X4 R642 R660 RP831 RP832 - 6X6 RBP831/RP831 - RBP832/RP832 - MK6X4 8X4 - ML6X4 2XAD80 - HK EK 6X4 8X4 RBP831+RP831 - RBP832+RP832 - HK 6X4 8X4 RBP730+RP730			
	● 4 TRUCK			
	★ RBP/RP832 6X4 6X6 8X4 - RP832 4X4 - RBP/RP730 6X4 6X6 8X4 - RB660/662 6X4 8X4 8X4/4 - RBP/RP735 RBP/RP835 6X4 6X6 8X4 - RP835 4X2 4X4 6X2 8X2 8X2/4			

SOLENOID VALVE	65470	1376794	
	● P-G-R-T TRUCK		
	★		

ALL THE COMPONENTS LISTED IN OUR CATALOGUE ARE NOT ORIGINAL, THOUGH PERFECTLY INTERCHANGEABLE. REFERENCE NUMBERS, EITHER ORIGINAL OR OF A DIFFERENT NATURE, ARE FOR INFORMATION PURPOSES ONLY. WHEN PLACING AN ORDER, PLEASE, ALWAYS USE COSIBO REFERENCE NUMBERS AND DO NOT MENTION THE ORIGINAL REFERENCE NUMBERS OF THE TRUCK MANUFACTURERS IN THE INVOICE TO VEHICLE OWNERS OR TO ANYBODY ELSE. THE CUSTOMER TAKES HIS OWN RESPONSIBILITY IF HE DOES NOT COMPLY WITH WHAT ABOVE.

	Code	OEM new	OEM old
CLAMP D.6	64082	813933	
	<ul style="list-style-type: none"> ● Model ★ Application 		
	<ul style="list-style-type: none"> ● 4 BUS ★ 		
	<ul style="list-style-type: none"> ● F-K-N BUS ★ 		
	<ul style="list-style-type: none"> ● 3 TRUCK ★ 		

CLAMP D.8	64090	813934	
	<ul style="list-style-type: none"> ● 3 TRUCK ★ 		
	<ul style="list-style-type: none"> ● 4 TRUCK ★ 		

CLAMP D.13	64091	813936	
	<ul style="list-style-type: none"> ● 3 TRUCK ★ 		
	<ul style="list-style-type: none"> ● 4 TRUCK ★ 		
	<ul style="list-style-type: none"> ● P-G-R-T TRUCK ★ 		

ALL THE COMPONENTS LISTED IN OUR CATALOGUE ARE NOT ORIGINAL, THOUGH PERFECTLY INTERCHANGEABLE. REFERENCE NUMBERS, EITHER ORIGINAL OR OF A DIFFERENT NATURE, ARE FOR INFORMATION PURPOSES ONLY. WHEN PLACING AN ORDER, PLEASE, ALWAYS USE COSIBO REFERENCE NUMBERS AND DO NOT MENTION THE ORIGINAL REFERENCE NUMBERS OF THE TRUCK MANUFACTURERS IN THE INVOICE TO VEHICLE OWNERS OR TO ANYBODY ELSE. THE CUSTOMER TAKES HIS OWN RESPONSIBILITY IF HE DOES NOT COMPLY WITH WHAT ABOVE.

		Code	OEM new	OEM old
NUT	● Model	64033	1873183	1403618
	★ Application			
	● 4 BUS			
	★	AM820/AM920 - AMA - ABS - AMA/AMI - D - ASA701 - ARA860D		
	● F-K-N BUS			
	★	AMA/AMI - D - AMA/ASA - ABS - AM920 - ARA860 - ARA860D - ASA760		
	● 3 TRUCK			
	★	AM800/AM820		
	● 4 TRUCK			
	★	AM/AMA - EBS - ABS - ARA760/820/900/900D - ASA700D - ASA700		
● P-G-R-T TRUCK				
★	AM/AMA - ABS - EBS - ASA700 - ASA700D - ABS/EBS - ARA760/820/900/900D			



SEEGER		64031	1358497	
	● 4 BUS			
	★	AM820/AM920 - AMA - ABS - AMA/AMI - D - ASA701 - ARA860D		
	● F-K-N BUS			
	★	AMA/AMI - D - AMA/ASA - ABS - AM920 - ARA860 - ARA860D - ASA760		
	● 3 TRUCK			
	★	AM800/AM820		
	● 4 TRUCK			
	★	AM/AMA - EBS - ABS - ARA760/820/900/900D - ASA700D - ASA700		
	● P-G-R-T TRUCK			
★	AM/AMA - ABS - EBS - ASA700 - ASA700D - ABS/EBS - ARA760/820/900/900D			



	Code	OEM new	OEM old
WASHER	64032	1365594	
<ul style="list-style-type: none"> ● Model ★ Application 			
<ul style="list-style-type: none"> ● 4 BUS 			
★ AM820/AM920 - AMA - ABS - AMA/AMI - D - ASA701 - ARA860D			
<ul style="list-style-type: none"> ● F-K-N BUS 			
★ AMA/AMI - D - AMA/ASA - ABS - AM920 - ARA860 - ARA860D - ASA760			
<ul style="list-style-type: none"> ● 3 TRUCK 			
★ AM800/AM820			
<ul style="list-style-type: none"> ● 4 TRUCK 			
★ AM/AMA - EBS - ABS - ARA760/820/900/900D - ASA700D - ASA700			
<ul style="list-style-type: none"> ● P-G-R-T TRUCK 			
★ AM/AMA - ABS - EBS - ASA700 - ASA700D - ABS/EBS - ARA760/820/900/900D			



	Code	OEM new	OEM old
WHEEL FLANGE	60279	1539231	1374305 1414072 273020
<ul style="list-style-type: none"> ● 3 BUS 			
★ AD/ADA90 - AD90 20"			
<ul style="list-style-type: none"> ● 4 BUS 			
★ ADA1300/1300D AND ABS - ASA1300D ABS			
<ul style="list-style-type: none"> ● F-K-N BUS 			
★ AD1300 - AD/ADA/ASA1300 ABS			
<ul style="list-style-type: none"> ● 3 TRUCK 			
★ AD/ADA90 - AD/ADA90 20" 22,5" - AD/ADA90 24"			
<ul style="list-style-type: none"> ● 4 TRUCK 			
★ AD/ADA1300 4X2 6X2 6X2/4 6X4 8X4 AND ABS - ADA DISC BRAKE EBS - AD/ADA1300 20" 22,5" 4X2 6X2 6X2/4 6X4 8X4 AND ABS - AD/ADA1300 24" 4X2 6X2 6X2/4 6X4 8X4 AND ABS - ADA1100 4X2 6X2 6X2/4 6X4 8X4 AND ABS - ADA1100 20" 22,5" 4X2 6X2 6X2/4 6X4 8X4 AND ABS - ADA1100 24" 4X2 6X2 6X2/4 6X4 8X4 AND ABS			
<ul style="list-style-type: none"> ● P-G-R-T TRUCK 			
★ ADA1100 AD/ADA1300 ADA1302 ABS/EBS - AD/ADA1300 20" 22,5" 4X2 6X2 6X2/4 6X4 AND ABS - AD/ADA1300 24" 4X2 6X2 6X2/4 6X4 AND ABS - ADA1100 4X2 6X2 6X2/4 6X4 AND ABS - ADA1100 20" 22,5" 4X2 6X2 6X2/4 6X4 AND ABS - ADA1100 24" 4X2 6X2 6X2/4 6X4 AND ABS - AD/ADA1300 ADA1302 4X2 6X2 6X2/4 6X4 AND ABS - ADA1100 ADA1300 ASA1000			



	Code	OEM new	OEM old
HUB CAP	64720	1762224	
<ul style="list-style-type: none"> ● Model ★ Application 			
<ul style="list-style-type: none"> ● 3 TRUCK ★ 			
<ul style="list-style-type: none"> ● 4 TRUCK ★ 			
<ul style="list-style-type: none"> ● P-G-R-T TRUCK ★ 			
<ul style="list-style-type: none"> ● 4 BUS ★ 			
<ul style="list-style-type: none"> ● F-K-N BUS ★ 			



	Code	OEM new	OEM old
AXLE SHAFT L=1070 MM (3 TEETH)	60299	193136	193137
<ul style="list-style-type: none"> ● 1 TRUCK ★ 111 - 141 			
<ul style="list-style-type: none"> ● 2 TRUCK ★ 112 - 142 			



	Code	OEM new	OEM old
AXLE SHAFT L=1084 MM (2 TEETH)	60301	264310	209152
<ul style="list-style-type: none"> ● 3 BUS ★ AD/ADA90 - AD90 20" 			
<ul style="list-style-type: none"> ● 3 TRUCK ★ AD/ADA90 - LH/RH R770 - R642 4X2 6X2 - RB652 R653 6X4 - AD/ADA90 R652/653 6X4 - AD90 R642 - ADA90 20" 22,5" LH/RH R770 R642 4X2 6X2 - RB652 R653 6X4 - AD/ADA90 24" LH/RH R770 R642 4X2 6X2 - RB652 R653 6X4 			



	Code	OEM new	OEM old
AXLE SHAFT L=1084 MM (3 TEETH)	60302	264311	209153
<ul style="list-style-type: none"> ● 3 TRUCK ★ AD/ADA90 RB652 R653 6X4 - AD/ADA90 20" 22,5" RB652 R653 6X4 - AD/ADA90 24" RB652 R653 6X4 			



ALL THE COMPONENTS LISTED IN OUR CATALOGUE ARE NOT ORIGINAL, THOUGH PERFECTLY INTERCHANGEABLE. REFERENCE NUMBERS, EITHER ORIGINAL OR OF A DIFFERENT NATURE, ARE FOR INFORMATION PURPOSES ONLY. WHEN PLACING AN ORDER, PLEASE, ALWAYS USE COSIBO REFERENCE NUMBERS AND DO NOT MENTION THE ORIGINAL REFERENCE NUMBERS OF THE TRUCK MANUFACTURERS IN THE INVOICE TO VEHICLE OWNERS OR TO ANYBODY ELSE. THE CUSTOMER TAKES HIS OWN RESPONSIBILITY IF HE DOES NOT COMPLY WITH WHAT ABOVE.

AXLE SHAFT L=1093 MM (2 TEETH)



	Code	OEM new	OEM old
● Model	62552	1761195	1315681
★ Application			
● 4 BUS			
★ F94 R780			
● F-K-N BUS			
★ R660 R680 AUTOMATIC GEARBOX - R780			
● 3 TRUCK			
★ AD/ADA90 LH/RH R780 4X2 6X2 - AD/ADA90 20" 22,5" LH/RH R780 4X2 6X2 - AD/ADA90 24" LH/RH R780 4X2 6X2			
● 4 TRUCK			
★ R780 - R782			
● P-G-R-T TRUCK			
★ R780 - R782			

WHEEL BEARING



	64497	1868087	1439070 1476945 1724482
● 3 TRUCK			
★ AM800/820			
● 4 BUS			
★ AM860/920 - ARA860D - ASA701 - AMA/AMI			
● 4 TRUCK			
★ AM/AMA - ARA760/820/900/900D - ASA700/700D			
● F-K-N BUS			
★ AMA/AMI D - AM/AMA/ASA - AM920 - ARA860/860D - ASA760			
● P-G-R-T TRUCK			
★ AM/AMA - ASA700/700D - ARA760/820/900/900D			

ALL THE COMPONENTS LISTED IN OUR CATALOGUE ARE NOT ORIGINAL, THOUGH PERFECTLY INTERCHANGEABLE. REFERENCE NUMBERS, EITHER ORIGINAL OR OF A DIFFERENT NATURE, ARE FOR INFORMATION PURPOSES ONLY. WHEN PLACING AN ORDER, PLEASE, ALWAYS USE COSIBO REFERENCE NUMBERS AND DO NOT MENTION THE ORIGINAL REFERENCE NUMBERS OF THE TRUCK MANUFACTURERS IN THE INVOICE TO VEHICLE OWNERS OR TO ANYBODY ELSE. THE CUSTOMER TAKES HIS OWN RESPONSIBILITY IF HE DOES NOT COMPLY WITH WHAT ABOVE.

	Code	OEM new	OEM old
WASHER	61651	1327413	287449
● Model			
★ Application			
● 3 BUS			
★ AM/AMA56/61 - AMI61 - ASA60			
● 3 TRUCK			
★ AM/AMA56/61 - AM70 - ARA56/61 - AS60 - ASA70 - AM70			
● 4 TRUCK			
★ ASA70			

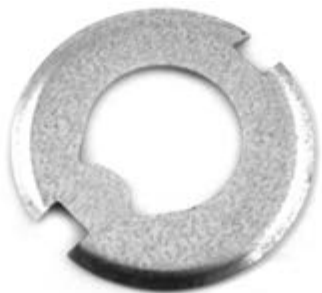

	65213	273024	
NUT			
● 3 BUS			
★ AD/ADA90 - ATA90			
● 3 TRUCK			
★ AD/ADA90 - AS90			
● 4 BUS			
★ ADA1300/1300D - AD1300 - ASA1300D - ASA1000			
● 4 TRUCK			
★ AD/ADA1300 - ADA1100 - ASA1000/1000D - AS1300 - AS900			
● F-K-N BUS			
★ ADA1300			
● P-G-R-T TRUCK			
★ ADA1100 - AD/ADA1300 - ADA1302 - ASA1000/1000D - AS900			



	65214	1104500	
OIL SEAL 50x70x9			
● 3 TRUCK			
★ AD100 RP/RBP831/832			
● 4 TRUCK			
★ AD/ADA1500P RP/RBP832			



ALL THE COMPONENTS LISTED IN OUR CATALOGUE ARE NOT ORIGINAL, THOUGH PERFECTLY INTERCHANGEABLE. REFERENCE NUMBERS, EITHER ORIGINAL OR OF A DIFFERENT NATURE, ARE FOR INFORMATION PURPOSES ONLY. WHEN PLACING AN ORDER, PLEASE, ALWAYS USE COSIBO REFERENCE NUMBERS AND DO NOT MENTION THE ORIGINAL REFERENCE NUMBERS OF THE TRUCK MANUFACTURERS IN THE INVOICE TO VEHICLE OWNERS OR TO ANYBODY ELSE. THE CUSTOMER TAKES HIS OWN RESPONSIBILITY IF HE DOES NOT COMPLY WITH WHAT ABOVE.

	Code	OEM new	OEM old
WASHER	61650	273023	
● Model			
★ Application			
● 3 BUS			
★ AD/ADA/ATA90			
● 3 TRUCK			
★ AD/ADA/AS90			
● 4 BUS			
★ AD/ADA/ASA1300/1300D - ASA1000 - ADA1100			
● 4 TRUCK			
★ AD/ADA/AS1300 - ADA/ASA1000/1000D - AS900 - ADA1100			
● F-K-N BUS			
★ AD/ADA/ASA1300			
● P-G-R-T TRCUK			
★ ADA1100 - AD/ADA1300 - ADA1302 - ASA1000/1000D - AS900			



	Code	OEM new	OEM old
WASHER	61649	301519	
● 1 TRUCK			
★ 111			
● 2 TRUCK			
★ 112			
● 3 TRUCK			
★ 113			



	Code	OEM new	OEM old
WASHER	61761	273022	
<ul style="list-style-type: none"> ● Model ★ Application 			
<ul style="list-style-type: none"> ● 3 BUS 			
<ul style="list-style-type: none"> ★ AD/ADA/ATA90 			
<ul style="list-style-type: none"> ● 3 TRUCK 			
<ul style="list-style-type: none"> ★ AD/ADA/AS90 			
<ul style="list-style-type: none"> ● 4 BUS 			
<ul style="list-style-type: none"> ★ AD/ADA/ASA1300/1300D - ASA1000 - ADA1100 			
<ul style="list-style-type: none"> ● 4 TRUCK 			
<ul style="list-style-type: none"> ★ AD/ADA/AS1300 - ADA/ASA1000/1000D - AS900 - ADA1100 			
<ul style="list-style-type: none"> ● F-K-N BUS 			
<ul style="list-style-type: none"> ★ AD/ADA/ASA1300 			
<ul style="list-style-type: none"> ● P-G-R-T TRUCK 			
<ul style="list-style-type: none"> ★ ADA1100 - AD/ADA1300 - ADA1302 - ASA1000/1000D - AS900 			



OIL SEAL 150,81x177,80x12,7

	60005	159496	
<ul style="list-style-type: none"> ● 3 TRUCK 			
<ul style="list-style-type: none"> ★ AD/ADA90 24" - 4X2 6X2 6X4 FOR BRAKE SHOES 203 mm 			



OIL SEAL 142x170x15/19



● Model

★ Application

	Code	OEM new	OEM old
	61297	1740992	1409889 1534012 370076

● 3 BUS

★ AD90 - ADA90 - AD90 20" - ATA90

● 4 BUS

★ ADA1300/1300 ABS - ADA1300 D ABS - AD1300 - ASA1300 D ABS - ASA1000 - AD/ADA1300 ADA1100 DISC BRAKE

● F-K-N BUS

★ AD/ADA1300 - AD/ADA/ASA1300 ABS

● 3 TRUCK

★ ADA90 - AD90 - AD/ADA90 20" 22,5" - AD90 ABS - AD/ADA90 24" - AS90

● 4 TRUCK

★ AS900 - AD/ADA1300/1300 ABS 4X2 6X2 6X2/4 6X4 8X4 - AD/ADA1300/1300 ABS 20" 22,5" - AD/ADA1300/1300 ABS 24" 4X2 6X2 6X2/4 6X4 8X4 - ADA1100/1100 ABS 4X2 6X2 6X2/4 6X4 8X4 - ADA1100 20" 22,5" 4X2 6X2 6X2/4 6X4 8X4 - ADA1100/1100 ABS 24" 4X2 6X2 6X2/4 6X4 8X4 - ASA1000 A

● P-G-R-T TRUCK

★ ADA1100 AD/ADA1300 ADA1302 ABS/EBS - AD/ADA1300 20" 22,5" AND ABS 4X2 6X2 6X2/4 6X4 - AD/ADA1300 24" 4X2 6X2 6X2/4 6X4 AND ABS - ADA1100 4X2 6X2 6X2/4 6X4 AND ABS - ADA1100 20" 22,5" 4X2 6X2 6X2/4 6X4 - ADA1100 24" 4X2 6X2 6X2/4 6X4 AND ABS

OIL SEAL 112x136,8/131x7,5/10,5



65215

297999

● 3 TRUCK

★ AD80 - ASA80

● 4 TRUCK

★ ASA80

REPAIR SET



● Model

★ Application

Code

OEM new

OEM old

64730

64730

● 3 BUS

★ AD/ADA/ATA90

● 3 TRUCK

★ AD/ADA/AS90

● 4 BUS

★ AD/ADA/ASA1300/1300D - ASA1000 - ADA1100

● 4 TRUCK

★ AD/ADA/AS1300 - ADA/ASA1000/1000D - AS900 - ADA1100

● F-K-N BUS

★ AD/ADA/ASA1300

● P-G-R-T TRUCK

★ ADA1100 - AD/ADA1300 - ADA1302 - ASA1000/1000D - AS900

OIL SEAL 137x161,92x15/20



61020

370074

● 3 TRUCK

★ AD/0 - ASA80

● 4 TRUCK

★ ASA80

OIL SEAL 125x160x15



61196

375086

● 3 BUS

★ AM56 - AM/AMA61 - AMI61

● 3 TRUCK

★ AM/AMA56 - AM/AMA61 6X4 8X4 - AM70 8X2 8X4 - ARA61 - ASA70

● 4 TRUCK

★ ASA70

ALL THE COMPONENTS LISTED IN OUR CATALOGUE ARE NOT ORIGINAL, THOUGH PERFECTLY INTERCHANGEABLE. REFERENCE NUMBERS, EITHER ORIGINAL OR OF A DIFFERENT NATURE, ARE FOR INFORMATION PURPOSES ONLY. WHEN PLACING AN ORDER, PLEASE, ALWAYS USE COSIBO REFERENCE NUMBERS AND DO NOT MENTION THE ORIGINAL REFERENCE NUMBERS OF THE TRUCK MANUFACTURERS IN THE INVOICE TO VEHICLE OWNERS OR TO ANYBODY ELSE. THE CUSTOMER TAKES HIS OWN RESPONSIBILITY IF HE DOES NOT COMPLY WITH WHAT ABOVE.

OIL SEAL 75x100x17



	Code	OEM new	OEM old
● Model	60993	1409890	1313719 33352
★ Application			
● 3 BUS			
★ AD/ADA90 - AD90 20"			
● 4 BUS			
★ AD/ADA1300 ABS - ADA1300D ABS - ASA1300D ABS			
● F-K-N BUS			
★ AD/ADA/ASA1300 ABS			
● 3 TRUCK			
★ AD/ADA90 4X2 6X2 6X4 - AD/ADA90 20"/22.5"/24" 4X2 6X2 6X4			
● 4 TRUCK			
★ AD/ADA1300 AND ABS 4X2 6X2 6X2/4 - AD/ADA1300 AND ABS 20" 22,5" 4X2 6X2 6X2/4 - AD/ADA1300 24" AND ABS 4X2 6X2 6X2/4 - ADA1100 4X2 6X2 6X2/4 - ADA1100 ABS 4X2 6X2 6X2/4 6X4 8X4 - ADA1100 20" 22,5" AND ABS 4X2 6X2 6X2/4 - ADA1100 24" AND ABS 4X2 6X2 6X2/4			
● P-G-R-T TRUCK			
★ AD/ADA1300 20"/22.5"/24" - ADA1100 20"/22.5"24" - ADA1302 - ASA1000			

ALL THE COMPONENTS LISTED IN OUR CATALOGUE ARE NOT ORIGINAL, THOUGH PERFECTLY INTERCHANGEABLE. REFERENCE NUMBERS, EITHER ORIGINAL OR OF A DIFFERENT NATURE, ARE FOR INFORMATION PURPOSES ONLY. WHEN PLACING AN ORDER, PLEASE, ALWAYS USE COSIBO REFERENCE NUMBERS AND DO NOT MENTION THE ORIGINAL REFERENCE NUMBERS OF THE TRUCK MANUFACTURERS IN THE INVOICE TO VEHICLE OWNERS OR TO ANYBODY ELSE. THE CUSTOMER TAKES HIS OWN RESPONSIBILITY IF HE DOES NOT COMPLY WITH WHAT ABOVE.

	Code	OEM new	OEM old
SEAL RING	60994	1765061	120310
<ul style="list-style-type: none"> ● Model ★ Application 			
<ul style="list-style-type: none"> ● 3 BUS 			
★ AD/ADA90 - AD90 20" - ATA90 ABS			
<ul style="list-style-type: none"> ● 4 BUS 			
★ AD/ADA1300 ADA1100 DISC BRAKE - ADA1300 ABS - ADA1300D ABS - AD1300 - ASA1000			
<ul style="list-style-type: none"> ● F-K-N BUS 			
★ AD/ADA1300 - AD/ADA/ASA1300 ABS			
<ul style="list-style-type: none"> ● 3 TRUCK 			
★ AD/ADA90 4X2 6X2 6X4 - AD/ADA90 20" 22,5" 4X2 6X2 6X4 - AD/ADA90 24" 4X2 6X2 6X4 - AS90			
<ul style="list-style-type: none"> ● 4 TRUCK 			
★ AD/ADA1300 ADA1100 DISC BRAKE - AD/ADA1300 4X2 6X2 6X2/4 6X4 8X4 - AD/ADA1300 20"22,2" AND ABS 4X2 6X2 6X2/4 6X4 8X4 - AD/ADA1300 24" AND ABS 4X2 6X2 6X2/4 6X4 8X4 - ADA1100 ANCHE/ANCHE ABS 4X2 6X2 6X2/4 6X4 8X4 - ADA1100 20"22,65" AND ABS 4X2 6X2 6X2/4 6X4 8X4 - ADA1100 24" AND/ANCEH ABS 4X2 6X2 6X2/4 6X4 8X4 - ASA1000 ABS - ASA1000D - AS1300 ABS - AS900			
<ul style="list-style-type: none"> ● P-G-R-T TRUCK 			
★ ADA1100 AD/ADA1300 ADA1302 ABS/EBS - AD/ADA1300 20"22,5" AND ABS 4X2 6X2 6X2/4 6X4 - AD/ADA1300 24" AND ABS 4X2 6X2 6X2/4 6X4 - AD1100 AND ABS 4X2 6X2 6X2/4 6X4 - ADA1100 20" 22,5" AND ABS 4X2 6X2 6X2/4 6X4 - ADA1100 24" AND ABS 4X2X6X2 6X2/4 6X4 - AD/ADA1300 ADA1302 AND ABS 4X2 6X2 6X2/4 6X4 - ADA1100 ADA1300 ASA1000 - ASA1000D ABS/EBS - ASA1000 ABS - AS900 - AD/ADA1300 ADA1100 DISC BRAKE			



	61007	392309	298021
O-RING (NBR BLACK)			
<ul style="list-style-type: none"> ● 4 BUS 			
★ ADA1501P RP835			
<ul style="list-style-type: none"> ● 3 TRUCK 			
★ AD100 20"22,5" RP/RBP831 6X2 6X4 - AD100 RP/RBP832 4X2 6X2 6X4 8X4 - AD100 20"22,5" RP/RBP832 4X2 6X2 6X4 8X4 - AD100 24" RP/RBP832 4X2 6X2 6X4 8X4			
<ul style="list-style-type: none"> ● 4 TRUCK 			
★ AD1101P RP/RBP735 - AD/ADA1500P RP/RBP832 AND ABS 4X2 6X2 6X4 6X6 8X4 - AD/ADA1500P RP/RBP832 20" 22,5" 24" 4X2 6X2 6X4 6X6 8X4 - AD/ADA1501P RP/RBP835			
<ul style="list-style-type: none"> ● P-G-R-T TRUCK 			
★ AD/AD1501P RP/RBP835 - AD1101P RP/RBP735 - ADA1502P RP/RBP835			

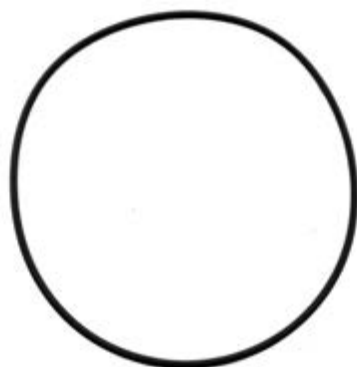

	Code	OEM new	OEM old
O-RING (VITON GREEN)	61007/1	392309	298021
● Model			
★ Application			
● 4 BUS			
★ ADA1501P RP835			
● 3 TRUCK			
★ AD100 20"22,5" RP/RBP831 6X2 6X4 - AD100 RP/RBP832 4X2 6X2 6X4 8X4 - AD100 20"22,5" RP/RBP832 4X2 6X2 6X4 8X4 - AD100 24" RP/RBP832 4X2 6X2 6X4 8X4			
● 4 TRUCK			
★ AD1101P RP/RBP735 - AD/ADA1500P RP/RBP832 AND ABS 4X2 6X2 6X4 6X6 8X4 - AD/ADA1500P RP/RBP832 20" 22,5" 24" 4X2 6X2 6X4 6X6 8X4 - AD/ADA1501P RP/RBP835			
● P-G-R-T TRUCK			
★ AD/ADA1501P RP/RBP835 - AD1101P RP/RBP735 - ADA1502P RP/RBP835			



OIL SEAL 158x188x14,5/19	61851	1907845	1363674 1528043 1786639
● 4 BUS			
★ ADA1501P RP835			
● 3 TRUCK			
★ AD100 RP/RBP831 4X2 6X2 6X4 - AD100 24" RP/RBP831 - AD100 RP/RBP832 4X2 6X2 6X4 8X4 - AD100 24" RP/RBP832 4X2 6X2 6X4 8X4			
● 4 TRUCK			
★ AD1101P RP/RBP735 - AD/ADA1500P RP/RBP832 AND ABS 4X2 6X2 6X4 6X6 8X4 - AD/ADA1500P RP/RBP832 20" 22,5" 24" 4X2 6X2 6X4 6X6 8X4 - AD/ADA1501P RP/RBP835			
● P-G-R-T TRUCK			
★ AD/ADA1501P RP/RBP835 - AD1101P RP/RBP735 - ADA1502P RP/RBP835			



OIL SEAL 149,9X176X16	64301	1342708	
● 4 TRUCK			
★ AMD900 ALSO ABS - AMD901 ALSO ABS -			
● P-G-R-T TRUCK			
★ AMD900A ABS - AMD901 ALSO ABS			



ALL THE COMPONENTS LISTED IN OUR CATALOGUE ARE NOT ORIGINAL, THOUGH PERFECTLY INTERCHANGEABLE. REFERENCE NUMBERS, EITHER ORIGINAL OR OF A DIFFERENT NATURE, ARE FOR INFORMATION PURPOSES ONLY. WHEN PLACING AN ORDER, PLEASE, ALWAYS USE COSIBO REFERENCE NUMBERS AND DO NOT MENTION THE ORIGINAL REFERENCE NUMBERS OF THE TRUCK MANUFACTURERS IN THE INVOICE TO VEHICLE OWNERS OR TO ANYBODY ELSE. THE CUSTOMER TAKES HIS OWN RESPONSIBILITY IF HE DOES NOT COMPLY WITH WHAT ABOVE.

	Code	OEM new	OEM old
O-RING	64163	233275	
<ul style="list-style-type: none"> ● Model ★ Application 			
<ul style="list-style-type: none"> ● 3 TRUCK 			
<ul style="list-style-type: none"> ★ 2XAD85 6X4 8X4 - 2XAD85 20" 6X4 8X4 			
<ul style="list-style-type: none"> ● 4 TRUCK 			
<ul style="list-style-type: none"> ★ AD1100P RP/RBP730 ALSO ABS 6X4 6X6 8X4 - AD1100P RP/RBP730 20" 22,5" 6X4 6X6 8X4 			



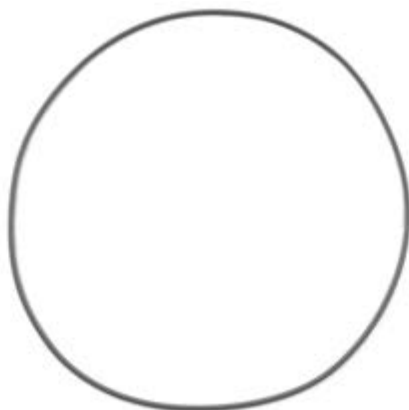

O-RING	64164	1120873	
<ul style="list-style-type: none"> ● 3 TRUCK 			
<ul style="list-style-type: none"> ★ 2XAD85 6X4 8X4 - 2XAD85 20" 6X4 8X4 			
<ul style="list-style-type: none"> ● 4 TRUCK 			
<ul style="list-style-type: none"> ★ AMD900/901 RH731 - AD1100P RP/RBP730 ALSO ABS 6X4 6X6 8X4 - AD1100P RP/RBP730 20" 22,5" 6X4 6X6 8X4 			
<ul style="list-style-type: none"> ● P-G-R-T TRUCK 			
<ul style="list-style-type: none"> ★ AMD900 RH731 - AMS901 RH731 RBP736 			

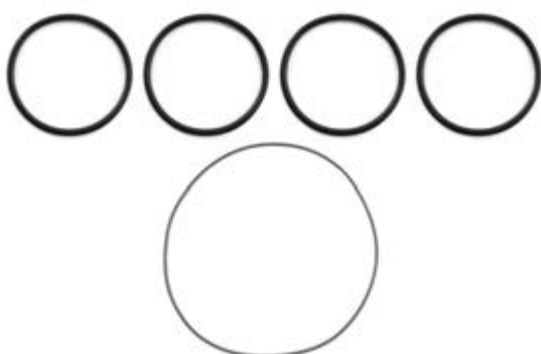

REPAIR SET	64860	64860	
<ul style="list-style-type: none"> ● 3 TRUCK 			
<ul style="list-style-type: none"> ★ 			
<ul style="list-style-type: none"> ● 4 TRUCK 			
<ul style="list-style-type: none"> ★ 			



	Code	OEM new	OEM old
O-RING	63562	812418	182525
	<ul style="list-style-type: none"> ● Model ★ Application 		
	<ul style="list-style-type: none"> ● 3 TRUCK ★ 		
GASKET	64165	1336380	
	<ul style="list-style-type: none"> ● 3 TRUCK ★ 2XAD85 6X4 8X4 - 2XAD85 20" 6X4 8X4 		
	<ul style="list-style-type: none"> ● 4 TRUCK ★ AMD900/901 RH731 - AD1100P RP/RBP730 ALSO ABS 6X4 6X6 8X4 - AD1100P RP/RBP730 20" 22,5" 6X4 6X6 8X4 		
	<ul style="list-style-type: none"> ● P-G-R-T TRUCK ★ AMD900 RH731 - AMS901 RH731 RBP736 		
OIL SEAL 145X170X14,5/18	64166	1736562	1363673
	<ul style="list-style-type: none"> ● 3 TRUCK ★ 2XAD85 6X4 8X4 - 2XAD85 20" 6X4 8X4 		
	<ul style="list-style-type: none"> ● 4 TRUCK ★ AD1100P RP/RBP730 ALSO ABS 6X4 6X6 8X4 - AD1100P RP/RBP730 20" 22,5" 6X 6X6 8X4 		

ALL THE COMPONENTS LISTED IN OUR CATALOGUE ARE NOT ORIGINAL, THOUGH PERFECTLY INTERCHANGEABLE. REFERENCE NUMBERS, EITHER ORIGINAL OR OF A DIFFERENT NATURE, ARE FOR INFORMATION PURPOSES ONLY. WHEN PLACING AN ORDER, PLEASE, ALWAYS USE COSIBO REFERENCE NUMBERS AND DO NOT MENTION THE ORIGINAL REFERENCE NUMBERS OF THE TRUCK MANUFACTURERS IN THE INVOICE TO VEHICLE OWNERS OR TO ANYBODY ELSE. THE CUSTOMER TAKES HIS OWN RESPONSIBILITY IF HE DOES NOT COMPLY WITH WHAT ABOVE.

OIL SEAL 110X140X15



- Model
- ★ Application

Code

OEM new

OEM old

61197

375087

- 3 BUS

- ★ AM/AMA56

- 3 TRUCK

- ★ AM/AMA56 - ARA56

OIL SEAL 155X180X24/29



61017

370075

- 3 TRUCK

- ★ AD100 RP/RBP831 4X2 6X2 6X4 - AD100 20" 22,5" RP/RBP831 6X2 6X4 - AD100 24" RP/RBP831 - AD100 20" 22,5" RP/RBP832 4X2 6X2 6X4 8X4

GASKET



61849

156938

1112702

- 3 BUS

- ★ AM/AMA56/61 - AMI61 - ASA60

- 3 TRUCK

- ★ AM/AMA/ARA56/61 - AM70 - AS60 - ASA70

- 4 TRUCK

- ★ ASA70

ALL THE COMPONENTS LISTED IN OUR CATALOGUE ARE NOT ORIGINAL, THOUGH PERFECTLY INTERCHANGEABLE. REFERENCE NUMBERS, EITHER ORIGINAL OR OF A DIFFERENT NATURE, ARE FOR INFORMATION PURPOSES ONLY. WHEN PLACING AN ORDER, PLEASE, ALWAYS USE COSIBO REFERENCE NUMBERS AND DO NOT MENTION THE ORIGINAL REFERENCE NUMBERS OF THE TRUCK MANUFACTURERS IN THE INVOICE TO VEHICLE OWNERS OR TO ANYBODY ELSE. THE CUSTOMER TAKES HIS OWN RESPONSIBILITY IF HE DOES NOT COMPLY WITH WHAT ABOVE.

WHEEL NUT H=27 MM



	Code	OEM new	OEM old
● Model	60986	1749034	1365510 243956 318690
★ Application			
● 3 BUS			
★ AM/AMA56/61 - AMI61 - AD/ADA90 - ASA60 - ATA90			
● 3 TRUCK			
★ AM/AMA/ARA56/61 - AM70 - AM800/820 - AMD105 - AD80 - AD/ADA90 - AD100 RP/RBP831/832 - 2XAD85 - AS60/90 - ASA70/80			
● 4 BUS			
★ AM860/920 - AMA/AMI/D - AM/AMA60 - ADA1250D/1300/1300D/1350D - AD1300 - ADA1501P RP835 - ASA701 - ASA1000/1150/1300D - ARA860D			
● 4 TRUCK			
★ ADA - AM/AMA - AD1100/1101P - ADA1100 - AD/ADA1300/1500/1501P - AMD900 - ARA760/820/900/D - AS900/1300 - ASA70/80/700/700D/1000/1000D			
● F-K-N BUS			
★ ADA1250D/1350D - ASA760/1150 - AMA/AMI/D - AM/AMA/ASA - AM920 - ARA860 - AD/ADA/ASA1300 - ARA860D			
● P-G-R-T TRUCK			
★ AM/AMA - AMD900/901 - ADA1100 - AD/ADA1300 - ADA1302 - AD/ADA1501P RP/RBP835 - ADA1502P RP/RBP835 - AD1101P RP/RBP735 - ASA700/1000 - ASA700/1000D - ARA760/820/900/D - AS900			

STUD (L=96 MM)



	60983	1368694	272853
● 3 TRUCK			
★ AD100 RP/RBP831 RP/RBP832			
● 4 BUS			
★ ADA1501P RP835 - ASA1300D ABS			
● 4 TRUCK			
★ AD1101P RP/RBP735 - AD/ADA1500P RP/RBP832 AND/E ABS - AD/ADA1501P RP/RBP835 - AMD900 - AMD900/901 ABS - ASA1000D			
● F-K-N BUS			
★ ADA1300			
● P-G-R-T TRUCK			
★ ADA1100 AD/ADA1300ADA1302 ABS/EBS - AD1101P RP/RBP735 - AD/ADA1501P RP/RBP835 - ADA1502P RP/RBP835 - ASA1000D ABS/EBS - ASA1000D - AMD900/901 ABS			

ALL THE COMPONENTS LISTED IN OUR CATALOGUE ARE NOT ORIGINAL, THOUGH PERFECTLY INTERCHANGEABLE. REFERENCE NUMBERS, EITHER ORIGINAL OR OF A DIFFERENT NATURE, ARE FOR INFORMATION PURPOSES ONLY. WHEN PLACING AN ORDER, PLEASE, ALWAYS USE COSIBO REFERENCE NUMBERS AND DO NOT MENTION THE ORIGINAL REFERENCE NUMBERS OF THE TRUCK MANUFACTURERS IN THE INVOICE TO VEHICLE OWNERS OR TO ANYBODY ELSE. THE CUSTOMER TAKES HIS OWN RESPONSIBILITY IF HE DOES NOT COMPLY WITH WHAT ABOVE.

	Code	OEM new	OEM old
STUD (L=70 MM)	60983/1	1368690	290062 397266
● Model			
★ Application			
● 3 BUS			
★ AM/AMA56 - AM/AMA61 - AMI61 - ASA60			
● 3 TRUCK			
★ AM/AMA56 - AM/AMA61 - AM800/820 - ARA56 - ARA61 - AS60			
● 4 BUS			
★ AM860 - AM920 - AMA - AMA ABS - AMA/AMID AND/E ABS - AM60/AMA60			
● 4 TRUCK			
★ AM/AMA - AM/AMA EBS/ABS - ARA760/820/900 AND/E ABS - ARA760/820/900D EBS - ASA700 - ASA700D EBS - ASA700 ABS			
● F-K-N BUS			
★ ASA760			
● P-G-R-T TRUCK			
★ ASA700 AND/ E ABS - ASA700D AND/E ABS/EBS - ARA760/820/900 AND/E ABS - ARA760/820/900D AND/E ABS/EBS - AM/AMA - AM/AMA ABS/EBS			



	Code	OEM new	OEM old
STUD (L=85 MM)	60984	1368693	295953
● 3 BUS			
★ AD/ADA90 - ATA90			
● 3 TRUCK			
★ AD80 - AD85 - AD/AD90 - AMD105 - AS90 - ASA70 - ASA80			
● 4 BUS			
★ ADA1300 AND/E ABS - ADA1300D ABS - AD1300 - ASA1000àASA1300D ABS			
● 4 TRUCK			
★ AD1100P RBP/RP730 AND/E ABS - ADA1100 AND/E ABS - AD/ADA1300 AND/E ABS - AM/AMA - AM/AMA ABS - AMD901 AND/E ABS - ASA70 - AS900 - AS1300 AND/E ABS - ASA80 - ASA1000 AND/E ABS - ASA1000D			
● F-K-N BUS			
★ ADA1300 - AD/ADA/ASA1300 ABS			
● P-G-R-T TRUCK			
★ AM/AMA AND/E ABS - AMD901 AND/E ABS - ADA1100 AD/ADA1300 ADA1302 AND/E ABS/EBS - ASA700 AND/E ABS - ASA1000 AND/E ABS - ASA1000D AND/E ABS/EBS - ARA760/820/900 AND/E ABS - AS900			



ALL THE COMPONENTS LISTED IN OUR CATALOGUE ARE NOT ORIGINAL, THOUGH PERFECTLY INTERCHANGEABLE. REFERENCE NUMBERS, EITHER ORIGINAL OR OF A DIFFERENT NATURE, ARE FOR INFORMATION PURPOSES ONLY. WHEN PLACING AN ORDER, PLEASE, ALWAYS USE COSIBO REFERENCE NUMBERS AND DO NOT MENTION THE ORIGINAL REFERENCE NUMBERS OF THE TRUCK MANUFACTURERS IN THE INVOICE TO VEHICLE OWNERS OR TO ANYBODY ELSE. THE CUSTOMER TAKES HIS OWN RESPONSIBILITY IF HE DOES NOT COMPLY WITH WHAT ABOVE.

RING GEAR (PHONIC WHEEL)



	Code	OEM new	OEM old
● Model	64723	1375382	1339680
★ Application			
● 3 TRUCK			
★ AM800/820			
● 4 BUS			
★ AMA - AMA/AMI/D - ASA701 - ARA860D			
● 4 TRUCK			
★ AM/AMA - ARA760/820/900 - ARA760/820/900D - ASA700/700D			
● F-K-N BUS			
★ ARA860D			
● P-G-R-T TRUCK			
★ ASA700			

ALL THE COMPONENTS LISTED IN OUR CATALOGUE ARE NOT ORIGINAL, THOUGH PERFECTLY INTERCHANGEABLE. REFERENCE NUMBERS, EITHER ORIGINAL OR OF A DIFFERENT NATURE, ARE FOR INFORMATION PURPOSES ONLY. WHEN PLACING AN ORDER, PLEASE, ALWAYS USE COSIBO REFERENCE NUMBERS AND DO NOT MENTION THE ORIGINAL REFERENCE NUMBERS OF THE TRUCK MANUFACTURERS IN THE INVOICE TO VEHICLE OWNERS OR TO ANYBODY ELSE. THE CUSTOMER TAKES HIS OWN RESPONSIBILITY IF HE DOES NOT COMPLY WITH WHAT ABOVE.

ABS & EBS SENSOR



	Code	OEM new	OEM old
● Model ★ Application	63879	1892051	1530696
● 3 BUS			
★ AM/AMA56 - AM/AMA61 - ASA60			
● 3 TRUCK			
★ AM56/AM61/AM70 ABS - ZM ABS			

WHEEL SPEED SENSOR SET



	Code	OEM new	OEM old
	64813	1892060	1530709 2765315
● 3 TRUCK			
★ AM56/AM61/AM70 ABS			

WHEEL SPEED SENSOR SET



	Code	OEM new	OEM old
	64818	1892053	1530699
● 3 BUS			
★ AM/AMA56 - AM/AMA61 - AD/ADA90 ABS			
● 3 TRUCK			
★ AM56/AM61 ABS - AM/AMA56 - AM/AMA61 - AM800/820 ABS - AD80/AD85/AD90/AD100 ABS - AD100			

ALL THE COMPONENTS LISTED IN OUR CATALOGUE ARE NOT ORIGINAL, THOUGH PERFECTLY INTERCHANGEABLE. REFERENCE NUMBERS, EITHER ORIGINAL OR OF A DIFFERENT NATURE, ARE FOR INFORMATION PURPOSES ONLY. WHEN PLACING AN ORDER, PLEASE, ALWAYS USE COSIBO REFERENCE NUMBERS AND DO NOT MENTION THE ORIGINAL REFERENCE NUMBERS OF THE TRUCK MANUFACTURERS IN THE INVOICE TO VEHICLE OWNERS OR TO ANYBODY ELSE. THE CUSTOMER TAKES HIS OWN RESPONSIBILITY IF HE DOES NOT COMPLY WITH WHAT ABOVE.

	Code	OEM new	OEM old
EXHAUST MANIFOLD	61908	1349045	
<ul style="list-style-type: none"> ● Model ★ Application 			
<ul style="list-style-type: none"> ● IND. MARINE ENGINE 4 			
<ul style="list-style-type: none"> ★ D14 81A 40E 			
<ul style="list-style-type: none"> ● 3 TRUCK 			
<ul style="list-style-type: none"> ★ DSC14 			



EXHAUST MANIFOLD	63753	1411774	
<ul style="list-style-type: none"> ● 4 TRUCK 			
<ul style="list-style-type: none"> ★ D11L 			



ENGINE EXHAUST BRAKE	63779	1374413	1360069
<ul style="list-style-type: none"> ● 4 TRUCK 			
<ul style="list-style-type: none"> ★ 144 			



ALL THE COMPONENTS LISTED IN OUR CATALOGUE ARE NOT ORIGINAL, THOUGH PERFECTLY INTERCHANGEABLE. REFERENCE NUMBERS, EITHER ORIGINAL OR OF A DIFFERENT NATURE, ARE FOR INFORMATION PURPOSES ONLY. WHEN PLACING AN ORDER, PLEASE, ALWAYS USE COSIBO REFERENCE NUMBERS AND DO NOT MENTION THE ORIGINAL REFERENCE NUMBERS OF THE TRUCK MANUFACTURERS IN THE INVOICE TO VEHICLE OWNERS OR TO ANYBODY ELSE. THE CUSTOMER TAKES HIS OWN RESPONSIBILITY IF HE DOES NOT COMPLY WITH WHAT ABOVE.

ENGINE EXHAUST BRAKE



- Model
- ★ Application

Code	OEM new	OEM old
65283	1805603	1383863 1412695 1427514 1374889

- 4 BUS

- ★ DC/DSC12 01/02/05 ENG 6195782 - ENG 8023977 - DC11 DC12 ENG 6195783 - ENG 8023978 -

- IND. MARINE ENGINE 4

- ★ D12A EMS ENG 6519002 - ENG 6519003 - D12A ENG 6195783 - ENG 8023978

- 4 TRUCK

- ★ DC/DSC12 01/02/05 ENG 6195782 - ENG 8023977 - DC11 DC12 ENG 6195783 - ENG 8023978 - DC11 01/02 ENG 6195782 - ENG 8023977 - DC12 03 ENG 6195782 - ENG 8023977

ALL THE COMPONENTS LISTED IN OUR CATALOGUE ARE NOT ORIGINAL, THOUGH PERFECTLY INTERCHANGEABLE. REFERENCE NUMBERS, EITHER ORIGINAL OR OF A DIFFERENT NATURE, ARE FOR INFORMATION PURPOSES ONLY. WHEN PLACING AN ORDER, PLEASE, ALWAYS USE COSIBO REFERENCE NUMBERS AND DO NOT MENTION THE ORIGINAL REFERENCE NUMBERS OF THE TRUCK MANUFACTURERS IN THE INVOICE TO VEHICLE OWNERS OR TO ANYBODY ELSE. THE CUSTOMER TAKES HIS OWN RESPONSIBILITY IF HE DOES NOT COMPLY WITH WHAT ABOVE.

ENGINE BRAKE THROTTLE VALVE SET



- Model
- ★ Application

Code	OEM new	OEM old
60893	1313326	301760 377253

- **3 TRUCK**

- ★ DS11 DSC11 ENG 5307760 - ENG 3075634 - ENG 4070104

ENGINE BRAKE THROTTLE VALVE SET



- **3 TRUCK**

- ★ DS11 DSC11 ENG 5307760 - ENG 3075634 - ENG 4070104

60894	1313325	377254
--------------	---------	--------

ENGINE BRAKE THROTTLE VALVE SET



- **IND. MARINE ENGINE 4**

- ★ DI14 81A 40E

- **3 TRUCK**

- ★ DSC14 CH 1193600 - CH 1193601 - CH 4327370 - CH 4327371 - CH 9000981 - CH 9000982

61530	1342121	1117705 385647
--------------	---------	-------------------

ALL THE COMPONENTS LISTED IN OUR CATALOGUE ARE NOT ORIGINAL, THOUGH PERFECTLY INTERCHANGEABLE. REFERENCE NUMBERS, EITHER ORIGINAL OR OF A DIFFERENT NATURE, ARE FOR INFORMATION PURPOSES ONLY. WHEN PLACING AN ORDER, PLEASE, ALWAYS USE COSIBO REFERENCE NUMBERS AND DO NOT MENTION THE ORIGINAL REFERENCE NUMBERS OF THE TRUCK MANUFACTURERS IN THE INVOICE TO VEHICLE OWNERS OR TO ANYBODY ELSE. THE CUSTOMER TAKES HIS OWN RESPONSIBILITY IF HE DOES NOT COMPLY WITH WHAT ABOVE.

ENGINE BRAKE THROTTLE VALVE SET



	Code	OEM new	OEM old
● Model	61531	1103635	1309571
★ Application			
● 3 BUS			
★ DSC 1124 CH 1823420			
● IND. MARINE ENGINE 4			
★ DSC9 47A			
● 3 TRUCK			
★ DS11 DSC11 ENG 5307761 - 5310452 - ENG 3075635 - ENG 4070105 - 4072203 - ENG 5310453 - ENG 4072204 - CH 1193600 - CH 1193601 - CH 4327370 - CH 4327371 - CH 9000981 - CH 9000982 - D11 84dB(A)			

ENGINE BRAKE THROTTLE VALVE SET



	66600	242573	
● 3 TRUCK			
★ DN11 DN9			

ALL THE COMPONENTS LISTED IN OUR CATALOGUE ARE NOT ORIGINAL, THOUGH PERFECTLY INTERCHANGEABLE. REFERENCE NUMBERS, EITHER ORIGINAL OR OF A DIFFERENT NATURE, ARE FOR INFORMATION PURPOSES ONLY. WHEN PLACING AN ORDER, PLEASE, ALWAYS USE COSIBO REFERENCE NUMBERS AND DO NOT MENTION THE ORIGINAL REFERENCE NUMBERS OF THE TRUCK MANUFACTURERS IN THE INVOICE TO VEHICLE OWNERS OR TO ANYBODY ELSE. THE CUSTOMER TAKES HIS OWN RESPONSIBILITY IF HE DOES NOT COMPLY WITH WHAT ABOVE.

ENGINE BRAKE METAL BUSHING



- **Model**
- ★ **Application**

Code	OEM new	OEM old
66606	1403609	1337777 1340548 1345729 207517 231936

- **3 BUS**

- ★ ADA 90 CH 1824259 - DS11 DSC11 DS1134 DS1174 CH 1823419 - DSC1124 CH 1823420 - DSC1104 1124 - DSC1108 - DSC1127

- **IND. MARINE ENGINE 4**

- ★ DSC9

- **3 TRUCK**

- ★ DN9 - DN11 - DSC14 CH 1193600 - CH 1193601 - CH 4327370 - CH 4327371 - CH 9000981 - CH 9000982 - D9/D11 - DS9 DS9 4X4 DSC9 ENG 5100362 - DS11 DSC11 ENG 5307760 - ENG 3075634 - ENG 3075635 - ENG 4070104 - ENG 4070105 - 4072203 - ENG 5307761 - 5310452 - DS11 DSC11 ENG 5310453 - ENG 4072204 - CH 1193600 - CH 1193601 - CH 4327370 - CH 4327371 - CH 9000981 - CH 9000982 - DS9 DS9 4X4 DSC9 DSC9 6X4 ENG 5100363 - CH 1193600 - CH 1193601 - CH 4327370 - CH 4327371 - CH 9000981 - CH 9000982 - DTC11 CH 1193600 - CH 1193601 - CH 4327370 - CH 4327371 - CH 9000981 - CH 9000982 - D11 84dB(A) - D14 84dB(A)

ALL THE COMPONENTS LISTED IN OUR CATALOGUE ARE NOT ORIGINAL, THOUGH PERFECTLY INTERCHANGEABLE. REFERENCE NUMBERS, EITHER ORIGINAL OR OF A DIFFERENT NATURE, ARE FOR INFORMATION PURPOSES ONLY. WHEN PLACING AN ORDER, PLEASE, ALWAYS USE COSIBO REFERENCE NUMBERS AND DO NOT MENTION THE ORIGINAL REFERENCE NUMBERS OF THE TRUCK MANUFACTURERS IN THE INVOICE TO VEHICLE OWNERS OR TO ANYBODY ELSE. THE CUSTOMER TAKES HIS OWN RESPONSIBILITY IF HE DOES NOT COMPLY WITH WHAT ABOVE.

		Code	OEM new	OEM old
EXHAUST BRAKE CYLINDER	● Model	60436	1438902	
	★ Application			
	● IND. MARINE ENGINE 4			
	★	ENG 1018664 - ENG 1018665		
	● 4 TRUCK			
★	DC16 01/02 ENG 1018664 - ENG 1018665			
● P-G-R-T TRUCK				
★	D16			



BRAKE CYLINDER		60413	1112542	363808
	● IND. MARINE ENGINE 4			
	★	DI14 81A 40E		
	● 3 TRUCK			
	★	DN11 - DSC14 - DS11 - DSC11 - D14 84dB(A)		



ENGINE BRAKE CYLINDER		61536	1332503	1348896
	● 3 BUS			
	★	DS11 - DSC11 - DS1134 - DS1174 - DSC1124 - DSC1104/1108/1127		
	● IND. MARINE ENGINE 4			
	★	DSC9 - DSC9 47A		
● 3 TRUCK				
★	DS9 - DSC9 - DS9 4X4 - DS9 - DSC9 6X4 - DN9 - DS11 - DSC11 - DTC11 - DSC14 LHD CR - D11 84dB(A)			



ALL THE COMPONENTS LISTED IN OUR CATALOGUE ARE NOT ORIGINAL, THOUGH PERFECTLY INTERCHANGEABLE. REFERENCE NUMBERS, EITHER ORIGINAL OR OF A DIFFERENT NATURE, ARE FOR INFORMATION PURPOSES ONLY. WHEN PLACING AN ORDER, PLEASE, ALWAYS USE COSIBO REFERENCE NUMBERS AND DO NOT MENTION THE ORIGINAL REFERENCE NUMBERS OF THE TRUCK MANUFACTURERS IN THE INVOICE TO VEHICLE OWNERS OR TO ANYBODY ELSE. THE CUSTOMER TAKES HIS OWN RESPONSIBILITY IF HE DOES NOT COMPLY WITH WHAT ABOVE.

		Code	OEM new	OEM old
EXHAUST BRAKE CYLINDER	● Model	65233	1400769	1376474
	★ Application			
	● 4 BUS			
	★	DC/DSC12 01/02/05 4X4 - 6X6 - 8X8 ENG 6195782 - ENG 8023977 - DC11/DC12 4X4 - 6X6 - 8X8 ENG 6195783 - ENG 8023978 - DSC9 11/15 LHD - RHD - D9L		
	● F-K-N BUS			
	★	DC9 EEV&EURO 5		
	● IND. MARINE ENGINE 4			
	★	D12A EMS ENG 6519002 - D12A ENG 6195783 - ENG 8023978 - DC9 51A		
	● 4 TRUCK			
	★	DC/DSC12 01/02/05 4X4 - 6X6 - 8X8 ENG 6195782 - ENG 8023977 - DC11/DC12 4X4 - 6X6 - 8X8 ENG 6195783 - ENG 8023978 - DT12 02/08 ENG 6195782 - ENG 8023977 - DTC 01 - DC11 01/02 ENG 6195782 - ENG 8023977 - DC12 03 ENG 6195782 - ENG 8023977 - D11L CH 1236756 - CH 1236757 - CH 9029576 - CH 9029577 - CH 4387094 - CH 4387095 - CH 3500183 - CH 3500184 - D9L - DT12 ENG 6195783 - ENG 8023978		
● P-G-R-T TRUCK				
★	DC9 EEV&EURO 5 - D11/D12 - D13			



		64417	1821737	1507790
EXHAUST BRAKE CYLINDER	● 4 BUS			
	★	D9L - DC9 PDE/XPI		
	● 4 TRUCK			
	★	DC9/DC11/DC12 PDE/XPI		
	● F-K-N BUS			
	★	DC9 - DC13 - F/K		
	● IND.MARINE ENGINE 4			
	★	D12A - D12A EMS - DC9 51A		
	● IND.MARINE ENGINE 5			
	★	DC9A EMS - DC09A - DC13A XPI		
● P-G-R-T TRUCK				
★	DC9 - DC13 - DT12			



ALL THE COMPONENTS LISTED IN OUR CATALOGUE ARE NOT ORIGINAL, THOUGH PERFECTLY INTERCHANGEABLE. REFERENCE NUMBERS, EITHER ORIGINAL OR OF A DIFFERENT NATURE, ARE FOR INFORMATION PURPOSES ONLY. WHEN PLACING AN ORDER, PLEASE, ALWAYS USE COSIBO REFERENCE NUMBERS AND DO NOT MENTION THE ORIGINAL REFERENCE NUMBERS OF THE TRUCK MANUFACTURERS IN THE INVOICE TO VEHICLE OWNERS OR TO ANYBODY ELSE. THE CUSTOMER TAKES HIS OWN RESPONSIBILITY IF HE DOES NOT COMPLY WITH WHAT ABOVE.

		Code	OEM new	OEM old
SWITCH	● Model	62398	1353142	
	★ Application			
	● 4 TRUCK			
	★ 94 - 114 - 124 - 144 - 164			
● P-G-R-T TRUCK				
	★			



EXH.BRAKE BALL JOINT		61529	1112539 1112540	
	● 3 BUS			
	★ DS11 DSC11 DS1134 DS1174 CH 1823419 - DSC1124 CH 1823420 - DSC1104 DSC1108 DSC1127 - OSC 11G01 CH 1825273 - K113TLP DSC 1181 CH 1827276			
	● 4 BUS			
	★ DC/DSC12 01/02/05 ENG 6195782 - ENG 8023977 4X4 6X6 8X8 - DC11/DC12 ENG 6195783 - ENG 8023978 - DC11/DC12 PDE HPI ENG 6195783 - ENG 8023978 - DSC9 11/15 LHD - RHD - DL9 - DC9 PDE/HPI ENG 6195783 - ENG 8023978			
	● F-K-N BUS			
	★ F/K/N			
	● IND. MARINE ENGINE 4			
	★ D12A EMS ENG 6519002 - D12A ENG 6195783 - ENG 8023978 - DC9A 51A -			
	● IND. MARINE ENGINE 5			
	★ DC9A EMS ENG 6347185			
	● 3 TRUCK			
	★ DSC9 LHD CABIN P/R - DSC11 DTC11 LHD CABIN P/R 80dB(A) - DSC14 LHD CABIN R 80dB(A) - DSC14 - DS9 4X4 ENG 5100362 - DS11 DSC11 ENG 5307760 - ENG 3075634 - ENG 4070104 - DN9 - DS11 DSC11 ENG 5310453 - ENG 4072204 - DTC11 - DSC14 LHD CABIN R - D11 84dB(A) - D14 84dB(A)			
	● 4 TRUCK			
	★ DC/DSC12 01/02/05 ENG 6195782 - ENG 8023977 4X4 6X6 8X8 - DC11/DC12 ENG 6195783 - ENG 8023978 4X4 6X6 8X8 - 80dB(A) 144 - DC11/DC12 PDE/HPI HAI - DT12 02/08 ENG 6195782 - ENG 8023977 - DTC12 01 - DC11 01/02 ENG 6195782 - ENG 8023977 - DC12 03 ENG 6195782 - ENG 8023977 - D11L CH 1236756 - CH 1236757 - CH 9029576 - CH 9029577 - CH 4387094 - CH 4387095 - CH 3500183 - CH 3500184 - DL9 - DC9 PDE ENG 6195783 - ENG 8023978			
● P-G-R-T TRUCK				
★ K/N - D11/12				

ALL THE COMPONENTS LISTED IN OUR CATALOGUE ARE NOT ORIGINAL, THOUGH PERFECTLY INTERCHANGEABLE. REFERENCE NUMBERS, EITHER ORIGINAL OR OF A DIFFERENT NATURE, ARE FOR INFORMATION PURPOSES ONLY. WHEN PLACING AN ORDER, PLEASE, ALWAYS USE COSIBO REFERENCE NUMBERS AND DO NOT MENTION THE ORIGINAL REFERENCE NUMBERS OF THE TRUCK MANUFACTURERS IN THE INVOICE TO VEHICLE OWNERS OR TO ANYBODY ELSE. THE CUSTOMER TAKES HIS OWN RESPONSIBILITY IF HE DOES NOT COMPLY WITH WHAT ABOVE.

	Code	OEM new	OEM old
CLAMP	64016	1431701	
	<ul style="list-style-type: none"> ● Model ★ Application 		
	<ul style="list-style-type: none"> ● 4 TRUCK 		
	<ul style="list-style-type: none"> ★ D11L CH 1236756 - CH 1236757 - CH 9029576 - CH 9029577 - CH 4387094 - CH 4387095 - CH 3500183 - CH 3500184 - 		

CLAMP	64358	1433190	
	<ul style="list-style-type: none"> ● 4 BUS ★ DC9/DC11/DC12 PDE HPI ENG 6195783 ENG 8023978 - D9L 		
	<ul style="list-style-type: none"> ● F-K-N BUS ★ DC9 EEV & EURO 5 F/K/N 		
	<ul style="list-style-type: none"> ● IND. MARINE ENGINE 5 ★ DC9A EMS ENG 6347185 ENG 6347186 		
	<ul style="list-style-type: none"> ● 4 TRUCK ★ DT12 02/08 ENG 6195782 ENG 8023977 - DC9 PDE ENG 6195783 ENG 8023978 		
	<ul style="list-style-type: none"> ● P-G-R-T TRUCK ★ DC9 EEV & EURO 5 K/N - D11/12 		

CLAMP	65402	1466075	
	<ul style="list-style-type: none"> ● 3 TRUCK ★ 		
	<ul style="list-style-type: none"> ● 4 BUS ★ 		
	<ul style="list-style-type: none"> ● 4 TRUCK ★ 		
	<ul style="list-style-type: none"> ● F-K-N BUS ★ 		
	<ul style="list-style-type: none"> ● P-G-R-T TRUCK ★ 		

ALL THE COMPONENTS LISTED IN OUR CATALOGUE ARE NOT ORIGINAL, THOUGH PERFECTLY INTERCHANGEABLE. REFERENCE NUMBERS, EITHER ORIGINAL OR OF A DIFFERENT NATURE, ARE FOR INFORMATION PURPOSES ONLY. WHEN PLACING AN ORDER, PLEASE, ALWAYS USE COSIBO REFERENCE NUMBERS AND DO NOT MENTION THE ORIGINAL REFERENCE NUMBERS OF THE TRUCK MANUFACTURERS IN THE INVOICE TO VEHICLE OWNERS OR TO ANYBODY ELSE. THE CUSTOMER TAKES HIS OWN RESPONSIBILITY IF HE DOES NOT COMPLY WITH WHAT ABOVE.

	Code	OEM new	OEM old
PEDAL RUBBER COVER	65177	389035	293152
<ul style="list-style-type: none"> ● Model ★ Application 			
<ul style="list-style-type: none"> ● 3 BUS ★ 			
<ul style="list-style-type: none"> ● 4 BUS ★ LHD/RHD - K IM 			
<ul style="list-style-type: none"> ● 3 TRUCK ★ 			
<ul style="list-style-type: none"> ● 4 TRUCK ★ 94 - 114 - 124 - 144 - 164 			



SPRING	65178	1409551	1391676
<ul style="list-style-type: none"> ● 3 BUS ★ 			
<ul style="list-style-type: none"> ● 4 BUS ★ LHD/RHD - K IB 			
<ul style="list-style-type: none"> ● 3 TRUCK ★ 			
<ul style="list-style-type: none"> ● 4 TRUCK ★ 94 - 114 - 124 - 144 - 164 			



ALL THE COMPONENTS LISTED IN OUR CATALOGUE ARE NOT ORIGINAL, THOUGH PERFECTLY INTERCHANGEABLE. REFERENCE NUMBERS, EITHER ORIGINAL OR OF A DIFFERENT NATURE, ARE FOR INFORMATION PURPOSES ONLY. WHEN PLACING AN ORDER, PLEASE, ALWAYS USE COSIBO REFERENCE NUMBERS AND DO NOT MENTION THE ORIGINAL REFERENCE NUMBERS OF THE TRUCK MANUFACTURERS IN THE INVOICE TO VEHICLE OWNERS OR TO ANYBODY ELSE. THE CUSTOMER TAKES HIS OWN RESPONSIBILITY IF HE DOES NOT COMPLY WITH WHAT ABOVE.

RUBBER HOSE



- Model
- ★ Application

Code

OEM new

OEM old

63214

267460

- 3 TRUCK

- ★ CR/CT143

O-RING 114,5x3 (GREEN VITON)

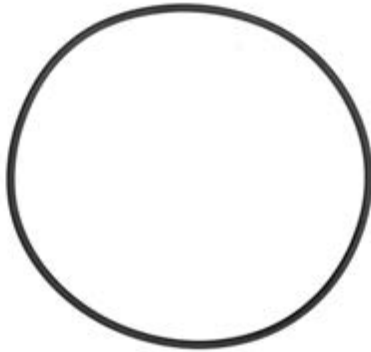

60127

323790

362128

- 3 BUS

- ★ DS11 74 - D9 - D11 - TE70 - GAV771/773/781/783R - GA773/775/781R

- 4 BUS

- ★ D9L - DSC12 02/05 - F/K/L/N94 - D11/12 - TE91 (TELMA F2400)

- F-K-N BUS

- ★ D9 720 - D9L - F

- IND. MARINE ENGINE 4

- ★ D12A - D12A EMS - SG9 A280 - D16A/M 720 CR - D16M

- 3 TRUCK

- ★ DN/DS/DSC - GR/GRS900 TE70

- 4 TRUCK

- ★ DSC12 01/02/03/05 - D11/D12/D14 - DC11/12 - DC11 01/02 - D11/D12 HPI/PDE - D9L

- P-G-R-T TRUCK

- ★ D11/12 - DC11/12 - DC16 600 - DC16 720CR

ALL THE COMPONENTS LISTED IN OUR CATALOGUE ARE NOT ORIGINAL, THOUGH PERFECTLY INTERCHANGEABLE. REFERENCE NUMBERS, EITHER ORIGINAL OR OF A DIFFERENT NATURE, ARE FOR INFORMATION PURPOSES ONLY. WHEN PLACING AN ORDER, PLEASE, ALWAYS USE COSIBO REFERENCE NUMBERS AND DO NOT MENTION THE ORIGINAL REFERENCE NUMBERS OF THE TRUCK MANUFACTURERS IN THE INVOICE TO VEHICLE OWNERS OR TO ANYBODY ELSE. THE CUSTOMER TAKES HIS OWN RESPONSIBILITY IF HE DOES NOT COMPLY WITH WHAT ABOVE.

	Code	OEM new	OEM old
SEAL RING	64210	345083	
<ul style="list-style-type: none"> ● Model ★ Application 			
<ul style="list-style-type: none"> ● 4 BUS ★ D9L - DSC12 02/05 - L/N94 720 - 			
<ul style="list-style-type: none"> ● IND. MARINE ENGINE 4 ★ D12A 			
<ul style="list-style-type: none"> ● 4 TRUCK ★ D9L 			
<ul style="list-style-type: none"> ● P-G-R-T TRUCK ★ D11/12 			



COMPRESSOR REPAIR SET	61878	1374083	1108223 1108227 1327886 319747 551435 551436
<ul style="list-style-type: none"> ● 3 BUS ★ 			
<ul style="list-style-type: none"> ● 3 TRUCK ★ 			

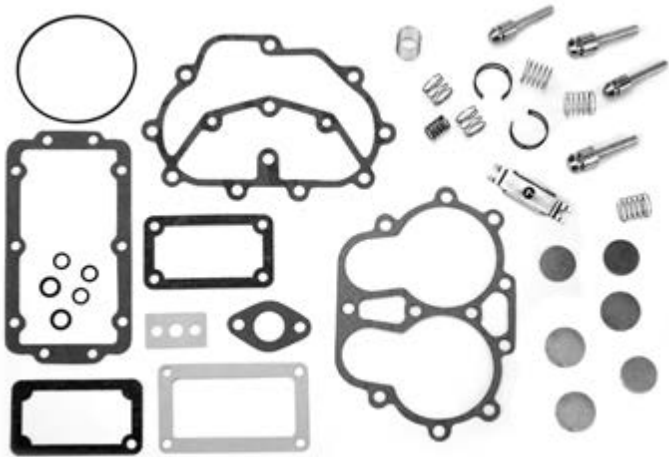

ALL THE COMPONENTS LISTED IN OUR CATALOGUE ARE NOT ORIGINAL, THOUGH PERFECTLY INTERCHANGEABLE. REFERENCE NUMBERS, EITHER ORIGINAL OR OF A DIFFERENT NATURE, ARE FOR INFORMATION PURPOSES ONLY. WHEN PLACING AN ORDER, PLEASE, ALWAYS USE COSIBO REFERENCE NUMBERS AND DO NOT MENTION THE ORIGINAL REFERENCE NUMBERS OF THE TRUCK MANUFACTURERS IN THE INVOICE TO VEHICLE OWNERS OR TO ANYBODY ELSE. THE CUSTOMER TAKES HIS OWN RESPONSIBILITY IF HE DOES NOT COMPLY WITH WHAT ABOVE.

COMPRESSOR REPAIR SET



	Code	OEM new	OEM old
● Model	61790	1542159	1376281
★ Application			
● 4 BUS			
★			
● 4 TRUCK			
★			
● F-K-N BUS			
★			
● IND. MARINE ENGINE 4			
★ D16M			
● IND. MARINE ENGINE 5			
★ DC9A EMS - SG9 A280			
● P-G-R-T TRUCK			
★			

COMPRESSOR REPAIR SET



	61852	1391386	
● 4 BUS			
★			
● 4 TRUCK			
★			

ALL THE COMPONENTS LISTED IN OUR CATALOGUE ARE NOT ORIGINAL, THOUGH PERFECTLY INTERCHANGEABLE. REFERENCE NUMBERS, EITHER ORIGINAL OR OF A DIFFERENT NATURE, ARE FOR INFORMATION PURPOSES ONLY. WHEN PLACING AN ORDER, PLEASE, ALWAYS USE COSIBO REFERENCE NUMBERS AND DO NOT MENTION THE ORIGINAL REFERENCE NUMBERS OF THE TRUCK MANUFACTURERS IN THE INVOICE TO VEHICLE OWNERS OR TO ANYBODY ELSE. THE CUSTOMER TAKES HIS OWN RESPONSIBILITY IF HE DOES NOT COMPLY WITH WHAT ABOVE.

RUBBER HOSE



- Model
- ★ Application

Code

OEM new

OEM old

64249

1115287

- 3 BUS

★

- 3 TRUCK

★

- IND.MARINE ENGINE 4

★

HOSE



- IND.MARINE ENGINE 4

★

64858

1872122

1530826
1724430
1804829

SILICONE HOSE



- 4 TRUCK

★ DSC12 01/02/03/05 - DC11 01/02 - D11

- P-G-R-T TRUCK

★ D11/12

- 4 BUS

★ DSC12 02/05 - D11/12

65371

1379888

ALL THE COMPONENTS LISTED IN OUR CATALOGUE ARE NOT ORIGINAL, THOUGH PERFECTLY INTERCHANGEABLE. REFERENCE NUMBERS, EITHER ORIGINAL OR OF A DIFFERENT NATURE, ARE FOR INFORMATION PURPOSES ONLY. WHEN PLACING AN ORDER, PLEASE, ALWAYS USE COSIBO REFERENCE NUMBERS AND DO NOT MENTION THE ORIGINAL REFERENCE NUMBERS OF THE TRUCK MANUFACTURERS IN THE INVOICE TO VEHICLE OWNERS OR TO ANYBODY ELSE. THE CUSTOMER TAKES HIS OWN RESPONSIBILITY IF HE DOES NOT COMPLY WITH WHAT ABOVE.

COMPRESSOR REPAIR SET



● Model
★ Application

Code

OEM new

OEM old

61830

1376280

● 4 BUS

★

● 4 TRUCK

★

● F-K-N BUS

★

● IND. MARINE ENGINE 4

★ D16M

● IND. MARINE ENGINE 5

★ DC9A EMS - SG9 A280

● P-G-R-T TRUCK

★

COMPRESSOR REPAIR SET



61831

1376279

● 4 BUS

★

● 4 TRUCK

★

● F-K-N BUS

★

● IND. MARINE ENGINE 4

★ D16M

● IND. MARINE ENGINE 5

★ DC9A EMS - SG9 A280

● P-G-R-T TRUCK

★

ALL THE COMPONENTS LISTED IN OUR CATALOGUE ARE NOT ORIGINAL, THOUGH PERFECTLY INTERCHANGEABLE. REFERENCE NUMBERS, EITHER ORIGINAL OR OF A DIFFERENT NATURE, ARE FOR INFORMATION PURPOSES ONLY. WHEN PLACING AN ORDER, PLEASE, ALWAYS USE COSIBO REFERENCE NUMBERS AND DO NOT MENTION THE ORIGINAL REFERENCE NUMBERS OF THE TRUCK MANUFACTURERS IN THE INVOICE TO VEHICLE OWNERS OR TO ANYBODY ELSE. THE CUSTOMER TAKES HIS OWN RESPONSIBILITY IF HE DOES NOT COMPLY WITH WHAT ABOVE.

	Code	OEM new	OEM old
COMPRESSOR HOSE	63068	815454	814346
● Model			
★ Application			
● 3 BUS			
★			
● 3 TRUCK			
★			
● 4 BUS			
★			
● 4 TRUCK			
★			



	62393	815462	
COMPRESSOR HOSE			
● 3 BUS			
★			
● 3 TRUCK			
★			
● 4 BUS			
★			
● 4 TRUCK			
★			



	63071	815457	814349
COMPRESSOR HOSE L= 450 MM			
● 3 BUS			
★			
● 3 TRUCK			
★			
● 4 BUS			
★ D9L			
● 4 TRUCK			
★ D9 - D9L - D11 - D12 - D14 - DSC11			



ALL THE COMPONENTS LISTED IN OUR CATALOGUE ARE NOT ORIGINAL, THOUGH PERFECTLY INTERCHANGEABLE. REFERENCE NUMBERS, EITHER ORIGINAL OR OF A DIFFERENT NATURE, ARE FOR INFORMATION PURPOSES ONLY. WHEN PLACING AN ORDER, PLEASE, ALWAYS USE COSIBO REFERENCE NUMBERS AND DO NOT MENTION THE ORIGINAL REFERENCE NUMBERS OF THE TRUCK MANUFACTURERS IN THE INVOICE TO VEHICLE OWNERS OR TO ANYBODY ELSE. THE CUSTOMER TAKES HIS OWN RESPONSIBILITY IF HE DOES NOT COMPLY WITH WHAT ABOVE.

COMPRESSOR HOSE L=500 MM



	Code	OEM new	OEM old
● Model ★ Application	63073	815458	814350
● 3 BUS ★			
● 3 TRUCK ★			
● 4 BUS ★			
● 4 TRUCK ★			

COMPRESSOR HOSE L=560 MM



	63074	815459	
● 3 BUS ★			
● 3 TRUCK ★			
● 4 BUS ★ K/L			
● 4 TRUCK ★ DSC12 01/05 - DT12 02 - DC11 01/02 - D9 - D11 - D12			

FLEXIBLE HOSE



	65474	1887055	468005
● 3 BUS ★ D11			
● 4 BUS ★ 94E/124E			
● 4 TRUCK ★			
● F-K-N BUS ★ K 4X2 6X2 6X2/2 6X2/4			

ALL THE COMPONENTS LISTED IN OUR CATALOGUE ARE NOT ORIGINAL, THOUGH PERFECTLY INTERCHANGEABLE. REFERENCE NUMBERS, EITHER ORIGINAL OR OF A DIFFERENT NATURE, ARE FOR INFORMATION PURPOSES ONLY. WHEN PLACING AN ORDER, PLEASE, ALWAYS USE COSIBO REFERENCE NUMBERS AND DO NOT MENTION THE ORIGINAL REFERENCE NUMBERS OF THE TRUCK MANUFACTURERS IN THE INVOICE TO VEHICLE OWNERS OR TO ANYBODY ELSE. THE CUSTOMER TAKES HIS OWN RESPONSIBILITY IF HE DOES NOT COMPLY WITH WHAT ABOVE.

COMPRESSOR REPAIR SET



● Model
★ Application

Code

OEM new

OEM old

61852

1391386

● F-K-N BUS

★

● IND. MARINE ENGINE 4

★ D16M

● IND. MARINE ENGINE 5

★ DC9A EMS - SG9 A280

● P-G-R-T TRUCK

★

O-RING



64410

1304914

● 3 BUS

★ GR/GRS/GRSH R

● 4 BUS

★ GR801R

● 3 TRUCK

★ GR/GRS/GRSH R

● 4 TRUCK

★ GR/GRS/GRSH R

● P-G-R-T

★ GR/GRS/GRSH R

ALL THE COMPONENTS LISTED IN OUR CATALOGUE ARE NOT ORIGINAL, THOUGH PERFECTLY INTERCHANGEABLE. REFERENCE NUMBERS, EITHER ORIGINAL OR OF A DIFFERENT NATURE, ARE FOR INFORMATION PURPOSES ONLY. WHEN PLACING AN ORDER, PLEASE, ALWAYS USE COSIBO REFERENCE NUMBERS AND DO NOT MENTION THE ORIGINAL REFERENCE NUMBERS OF THE TRUCK MANUFACTURERS IN THE INVOICE TO VEHICLE OWNERS OR TO ANYBODY ELSE. THE CUSTOMER TAKES HIS OWN RESPONSIBILITY IF HE DOES NOT COMPLY WITH WHAT ABOVE.

		Code	OEM new	OEM old
O-RING	● Model	64411	1349018	
	★ Application			
	● 3 BUS			
	★			
	● 4 BUS			
	★			
	● F-K-N BUS			
	★			
	● 3 TRUCK			
	★			
	● 4 TRUCK			
	★			
● P-G-R-T				
★				



O-RING		64409	1328242	
	● P-G-R-T TRUCK			
	★			



ALL THE COMPONENTS LISTED IN OUR CATALOGUE ARE NOT ORIGINAL, THOUGH PERFECTLY INTERCHANGEABLE. REFERENCE NUMBERS, EITHER ORIGINAL OR OF A DIFFERENT NATURE, ARE FOR INFORMATION PURPOSES ONLY. WHEN PLACING AN ORDER, PLEASE, ALWAYS USE COSIBO REFERENCE NUMBERS AND DO NOT MENTION THE ORIGINAL REFERENCE NUMBERS OF THE TRUCK MANUFACTURERS IN THE INVOICE TO VEHICLE OWNERS OR TO ANYBODY ELSE. THE CUSTOMER TAKES HIS OWN RESPONSIBILITY IF HE DOES NOT COMPLY WITH WHAT ABOVE.

		Code	OEM new	OEM old
O-RING 	● Model	63320	750226	
	★ Application			
	● 3 BUS			
	★			
	● 3 TRUCK			
	★			
	● 4 BUS			
	★			
	● 4 TRUCK			
	★			
	● F-K-N BUS			
	★			
	● P-G-R-T TRUCK			
	★			

		63562	812418	182525
O-RING 	● 3 BUS			
	★			
	● 4 BUS			
	★			
	● 4 TRUCK			
	★			
	● F-K-N BUS			
	★			
	● IND.MARINE ENGINE 4			
	★			
	● IND.MARINE ENGINE 5			
	★			
	● P-G-R-T TRUCK			
	★			

ALL THE COMPONENTS LISTED IN OUR CATALOGUE ARE NOT ORIGINAL, THOUGH PERFECTLY INTERCHANGEABLE. REFERENCE NUMBERS, EITHER ORIGINAL OR OF A DIFFERENT NATURE, ARE FOR INFORMATION PURPOSES ONLY. WHEN PLACING AN ORDER, PLEASE, ALWAYS USE COSIBO REFERENCE NUMBERS AND DO NOT MENTION THE ORIGINAL REFERENCE NUMBERS OF THE TRUCK MANUFACTURERS IN THE INVOICE TO VEHICLE OWNERS OR TO ANYBODY ELSE. THE CUSTOMER TAKES HIS OWN RESPONSIBILITY IF HE DOES NOT COMPLY WITH WHAT ABOVE.

	Code	OEM new	OEM old
RUBBER HOSE	63166	1331309	
<ul style="list-style-type: none"> ● Model ★ Application 			
<ul style="list-style-type: none"> ● 4 BUS 			
<ul style="list-style-type: none"> ★ DSC12 05 			
<ul style="list-style-type: none"> ● 4 TRUCK 			
<ul style="list-style-type: none"> ★ D11/12 HPI PDE - DC11 01/02 - DSC12 05 			
<ul style="list-style-type: none"> ● IND.MARINE ENGINE 4 			
<ul style="list-style-type: none"> ★ D16M 			



COMPRESSOR HOSE	63164	1872753	1379707
<ul style="list-style-type: none"> ● 4 BUS 			
<ul style="list-style-type: none"> ★ D11/12 - DSC12 02 			
<ul style="list-style-type: none"> ● 4 TRUCK 			
<ul style="list-style-type: none"> ★ DSC12 01/02/03 			
<ul style="list-style-type: none"> ● F-K-N BUS 			
<ul style="list-style-type: none"> ★ D9 			
<ul style="list-style-type: none"> ● IND.MARINE ENGINE 4 			
<ul style="list-style-type: none"> ★ D12A - D16M 			
<ul style="list-style-type: none"> ● P-G-R-T TRUCK 			
<ul style="list-style-type: none"> ★ D11/12 			



RUBBER HOSE	64846	1512485	
<ul style="list-style-type: none"> ● P-G-R-T TRUCK 			
<ul style="list-style-type: none"> ★ DC16 600 			



ALL THE COMPONENTS LISTED IN OUR CATALOGUE ARE NOT ORIGINAL, THOUGH PERFECTLY INTERCHANGEABLE. REFERENCE NUMBERS, EITHER ORIGINAL OR OF A DIFFERENT NATURE, ARE FOR INFORMATION PURPOSES ONLY. WHEN PLACING AN ORDER, PLEASE, ALWAYS USE COSIBO REFERENCE NUMBERS AND DO NOT MENTION THE ORIGINAL REFERENCE NUMBERS OF THE TRUCK MANUFACTURERS IN THE INVOICE TO VEHICLE OWNERS OR TO ANYBODY ELSE. THE CUSTOMER TAKES HIS OWN RESPONSIBILITY IF HE DOES NOT COMPLY WITH WHAT ABOVE.

	Code	OEM new	OEM old
RUBBER HOSE	64847	1506273	
<ul style="list-style-type: none"> ● Model ★ Application 			
<ul style="list-style-type: none"> ● P-G-R-T TRUCK ★ DC16 600 			



RUBBER HOSE	64848	1729116	1516514
<ul style="list-style-type: none"> ● 4 TRUCK ★ DC16 600 			
<ul style="list-style-type: none"> ● IND.MARINE ENGINE 4 ★ D16M 			
<ul style="list-style-type: none"> ● P-G-R-T TRUCK ★ DC16 600 			



SOLENOID VALVE	62383	1850567	1736364
<ul style="list-style-type: none"> ● 4 BUS ★ BR801R K/L94 - 124 - CN94 			
<ul style="list-style-type: none"> ● F-K-N BUS ★ 			
<ul style="list-style-type: none"> ● 4 TRUCK ★ GRSH900R - GR/GRS/GRSO R 			
<ul style="list-style-type: none"> ● P-G-R-T TRUCK ★ 			



ALL THE COMPONENTS LISTED IN OUR CATALOGUE ARE NOT ORIGINAL, THOUGH PERFECTLY INTERCHANGEABLE. REFERENCE NUMBERS, EITHER ORIGINAL OR OF A DIFFERENT NATURE, ARE FOR INFORMATION PURPOSES ONLY. WHEN PLACING AN ORDER, PLEASE, ALWAYS USE COSIBO REFERENCE NUMBERS AND DO NOT MENTION THE ORIGINAL REFERENCE NUMBERS OF THE TRUCK MANUFACTURERS IN THE INVOICE TO VEHICLE OWNERS OR TO ANYBODY ELSE. THE CUSTOMER TAKES HIS OWN RESPONSIBILITY IF HE DOES NOT COMPLY WITH WHAT ABOVE.

SOLENOID VALVE



- Model
- ★ Application

Code	OEM new	OEM old
64867	2021084	1756046 1856309

- **P-G-R-T TRUCK**
- ★ D11 - D12 - D16 - DC16 XPI

SOLENOID VALVE



65296	1421599	1364851 1382490
--------------	---------	--------------------

- **3 BUS**
- ★ GR801R K113
- **4 BUS**
- ★ GR801R K/L94 - 124 CN94
- **3 TRUCK**
- ★ GR/GRS900R 113/143
- **4 TRUCK**
- ★ GRS890R - GR/GRS900R - GRSH900R

SOLENOID VALVE



65507	1910461	1773867
--------------	---------	---------

- **F-K-N BUS**
- ★
- **P-G-R-T TRUCK**
- ★
- **F-K-N BUS**
- ★ GR875R - GRS/GRS0895R - GR/GRS/GRS0905R
- **P-G-R-T TRUCK**
- ★ GR875R - GRS875R - GR/GRS/GRS0905R

* To be used with retarder

ALL THE COMPONENTS LISTED IN OUR CATALOGUE ARE NOT ORIGINAL, THOUGH PERFECTLY INTERCHANGEABLE. REFERENCE NUMBERS, EITHER ORIGINAL OR OF A DIFFERENT NATURE, ARE FOR INFORMATION PURPOSES ONLY. WHEN PLACING AN ORDER, PLEASE, ALWAYS USE COSIBO REFERENCE NUMBERS AND DO NOT MENTION THE ORIGINAL REFERENCE NUMBERS OF THE TRUCK MANUFACTURERS IN THE INVOICE TO VEHICLE OWNERS OR TO ANYBODY ELSE. THE CUSTOMER TAKES HIS OWN RESPONSIBILITY IF HE DOES NOT COMPLY WITH WHAT ABOVE.

RETARDER VALVE REPAIR SET



	Code	OEM new	OEM old
● Model	63865	550553	
★ Application			
● 3 BUS			
★ GR/GRS/GRSH.R - GR801R			
● 4 BUS			
★ GR801R CH 1840166 - CH 1840167 - CH 3527416 - CH 3527417 - 3545640 - CH 3545641 - CH 1843282 - CH 1843283 - 1846593 - CH 1846594 -			
● F-K-N BUS			
★ GR801R/GR900R/GRS890R/GRS900R/GRS920R/GRS0900R			
● 3 TRUCK			
★ GR/GRS/GRSH.R - GR/GRS900R			
● 4 TRUCK			
★ GR/GRS/GRSH.R -			
● P-G-R-T TRUCK			
★ GR/GRS/GRSH.R - GR801R/GR900R/GRS890R/GRS900R/GRS920R/GRS0900R			

PISTON REPAIR SET



	63683	550550	
● 4 BUS			
★ GR/GRS/GRSH/GRSO R			
● F-K-N BUS			
★			
● 4 TRUCK			
★ GR/GRS/GRSH/GRSO R			
● P-G-R-T TRUCK			
★			

ALL THE COMPONENTS LISTED IN OUR CATALOGUE ARE NOT ORIGINAL, THOUGH PERFECTLY INTERCHANGEABLE. REFERENCE NUMBERS, EITHER ORIGINAL OR OF A DIFFERENT NATURE, ARE FOR INFORMATION PURPOSES ONLY. WHEN PLACING AN ORDER, PLEASE, ALWAYS USE COSIBO REFERENCE NUMBERS AND DO NOT MENTION THE ORIGINAL REFERENCE NUMBERS OF THE TRUCK MANUFACTURERS IN THE INVOICE TO VEHICLE OWNERS OR TO ANYBODY ELSE. THE CUSTOMER TAKES HIS OWN RESPONSIBILITY IF HE DOES NOT COMPLY WITH WHAT ABOVE.

PISTON RING SET

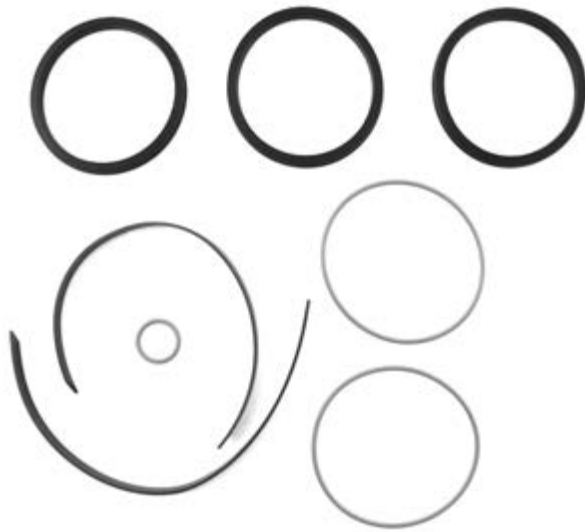

- Model
- ★ Application

Code
63684

OEM new
63684

OEM old

- **4 BUS**

- ★ GR/GRS/GRSH/GRSO R FOR OUR 63683

- **F-K-N BUS**

- ★ FOR OUR 63683

- **4 TRUCK**

- ★ GR/GRS/GRSH/GRSO R FOR OUR 63683

- **P-G-R-T TRUCK**

- ★ FOR OUR 63683

FULL RETARDER REPAIR SET

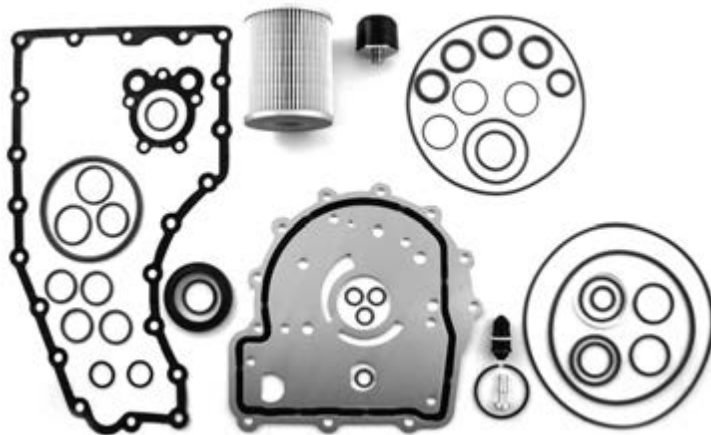

65089

550567

- **3 BUS**

- ★ GR/GRS/GRSH.R

- **4 BUS**

- ★ GR801R

- **3 TRUCK**

- ★ GR/GRS/GRSH.R

- **4 TRUCK**

- ★ GR/GRS/GRSH.R

- **P-G-R-T TRUCK**

- ★ GR/GRS/GRSH.R

ALL THE COMPONENTS LISTED IN OUR CATALOGUE ARE NOT ORIGINAL, THOUGH PERFECTLY INTERCHANGEABLE. REFERENCE NUMBERS, EITHER ORIGINAL OR OF A DIFFERENT NATURE, ARE FOR INFORMATION PURPOSES ONLY. WHEN PLACING AN ORDER, PLEASE, ALWAYS USE COSIBO REFERENCE NUMBERS AND DO NOT MENTION THE ORIGINAL REFERENCE NUMBERS OF THE TRUCK MANUFACTURERS IN THE INVOICE TO VEHICLE OWNERS OR TO ANYBODY ELSE. THE CUSTOMER TAKES HIS OWN RESPONSIBILITY IF HE DOES NOT COMPLY WITH WHAT ABOVE.

FULL RETARDER REPAIR SET W/O FILTER (SAME 550567 BUT W/O FILTER)

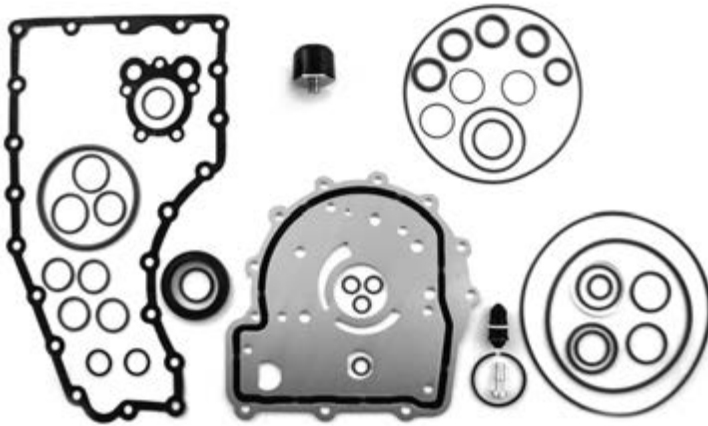

● Model
★ Application

Code

OEM new

OEM old

65089/2

65089/2

● 3 BUS

★ GR/GRS/GRSH.R

● 4 BUS

★ GR801R

● 3 TRUCK

★ GR/GRS/GRSH.R

● 4 TRUCK

★ GR/GRS/GRSH.R

● P-G-R-T TRUCK

★ GR/GRS/GRSH.R

RETARDER OIL FILTER



62361

1381235

1329876

● 3 BUS

★ GR/GRS/GRSH R - GR801R

● 4 BUS

★ GR801R

● F-K-N BUS

★ GR801R/GR900R/GRS890R/GRS900R/GRS920R/GRS0900R - GR875R - GRS/GR-SO895R - GR/GRS/GRSO905R

● 3 TRUCK

★ GR/GRS/GRSH R - GR/GRS900R

● 4 TRUCK

★ GR/GRS/GRSH R - GR/GRS/GRSH/GRSO/R

● P-G-R-T TRUCK

★ GR/GRS/GRSH R - GR801R/GR900R/GRS890R/GRS900R/GRS920R/GRSO900R - GR875R - GRS895R - GR/GRS/GRSO905R -

ALL THE COMPONENTS LISTED IN OUR CATALOGUE ARE NOT ORIGINAL, THOUGH PERFECTLY INTERCHANGEABLE. REFERENCE NUMBERS, EITHER ORIGINAL OR OF A DIFFERENT NATURE, ARE FOR INFORMATION PURPOSES ONLY. WHEN PLACING AN ORDER, PLEASE, ALWAYS USE COSIBO REFERENCE NUMBERS AND DO NOT MENTION THE ORIGINAL REFERENCE NUMBERS OF THE TRUCK MANUFACTURERS IN THE INVOICE TO VEHICLE OWNERS OR TO ANYBODY ELSE. THE CUSTOMER TAKES HIS OWN RESPONSIBILITY IF HE DOES NOT COMPLY WITH WHAT ABOVE.

DRYER FILTER



	Code	OEM new	OEM old
● Model	64118	2081360	1774598
★ Application			
● 4 BUS			
★ 8X8 WLS/ZLS			
● 4 TRUCK			
★ 8X8 WLS/ZLS			
● F-K-N BUS			
★			
● P-G-R-T TRUCK			
★ D16 PDE HPI			

O-RING

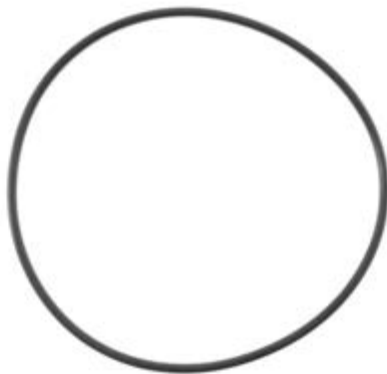

	61632	1312934	323641
● 3 BUS			
★ GR/GRS/GRSH R - GR801R			
● 4 BUS			
★ GR801R - GR801R CN94			
● F-K-N BUS			
★ GR801R/GR900R/GRS890R/GRS900R/GRS920R/GRS0900R			
● 3 TRUCK			
★ GR/GRS/GRSH R - GR/GRS900R			
● 4 TRUCK			
★ GR/GRS/GRSH/GRSO R			
● P-G-R-T TRUCK			
★ GR/GRS/GRSH R - GR801R/GR900R/GRS890R/GRS900R/GRS920R/GRS0900R			

CAP



	62512	1371839	295960
● 3 TRUCK			
★			

ALL THE COMPONENTS LISTED IN OUR CATALOGUE ARE NOT ORIGINAL, THOUGH PERFECTLY INTERCHANGEABLE. REFERENCE NUMBERS, EITHER ORIGINAL OR OF A DIFFERENT NATURE, ARE FOR INFORMATION PURPOSES ONLY. WHEN PLACING AN ORDER, PLEASE, ALWAYS USE COSIBO REFERENCE NUMBERS AND DO NOT MENTION THE ORIGINAL REFERENCE NUMBERS OF THE TRUCK MANUFACTURERS IN THE INVOICE TO VEHICLE OWNERS OR TO ANYBODY ELSE. THE CUSTOMER TAKES HIS OWN RESPONSIBILITY IF HE DOES NOT COMPLY WITH WHAT ABOVE.

		Code	OEM new	OEM old
CAP	● Model	62397	308678	
	★ Application			
	● 3 BUS			
	★			

		63963	1411129	1384116
AIR PLUG	● 3 BUS			
	★ GR/GRS/GRSH R - GR801R			
	● 4 BUS			
	★ GR801R			
	● F-K-N BUS			
	★ GR801R/GR900R/GRS890R/GRS900R/GRS920R/GRSO900R			
	● 3 TRUCK			
	★ GR/GRS/GRSH R - GR/GRS900R			
	● 4 TRUCK			
	★ GR/GRS/GRSH/GRSO R			
	● P-G-R-T TRUCK			
	★ GR/GRS/GRSH R - GR801R/GR900R/GRS890R/GRS900R/GRS920R/GRSO900R			

		63929	1388070	
RUBBER BUFFER	● F-K-N BUS			
	★ N APS - K UD - APS - ADA1300 - K UD 6X2			
	● P-G-R-T TRUCK			
	★ GA750/850/760/860R			

ALL THE COMPONENTS LISTED IN OUR CATALOGUE ARE NOT ORIGINAL, THOUGH PERFECTLY INTERCHANGEABLE. REFERENCE NUMBERS, EITHER ORIGINAL OR OF A DIFFERENT NATURE, ARE FOR INFORMATION PURPOSES ONLY. WHEN PLACING AN ORDER, PLEASE, ALWAYS USE COSIBO REFERENCE NUMBERS AND DO NOT MENTION THE ORIGINAL REFERENCE NUMBERS OF THE TRUCK MANUFACTURERS IN THE INVOICE TO VEHICLE OWNERS OR TO ANYBODY ELSE. THE CUSTOMER TAKES HIS OWN RESPONSIBILITY IF HE DOES NOT COMPLY WITH WHAT ABOVE.

		Code	OEM new	OEM old
LOCK NUT	● Model	60836	1525988	387877
	★ Application			
	● 3 BUS			
	★ TE70			
	● 3 TRUCK			
	★ GR/GRE871/871T - GR/GRS900 TE70			
● 4 BUS				
★ TE91				



		64828	1461416	1114314
LOCK NUT (RETARDER)	● 3 BUS			
	★			
	● 3 TRUCK			
	★			
	● 4 BUS			
	★			
	● 4 TRUCK			
	★			
	● F-K-N BUS			
	★			
● P-G-R-T TRUCK				
★				



ALL THE COMPONENTS LISTED IN OUR CATALOGUE ARE NOT ORIGINAL, THOUGH PERFECTLY INTERCHANGEABLE. REFERENCE NUMBERS, EITHER ORIGINAL OR OF A DIFFERENT NATURE, ARE FOR INFORMATION PURPOSES ONLY. WHEN PLACING AN ORDER, PLEASE, ALWAYS USE COSIBO REFERENCE NUMBERS AND DO NOT MENTION THE ORIGINAL REFERENCE NUMBERS OF THE TRUCK MANUFACTURERS IN THE INVOICE TO VEHICLE OWNERS OR TO ANYBODY ELSE. THE CUSTOMER TAKES HIS OWN RESPONSIBILITY IF HE DOES NOT COMPLY WITH WHAT ABOVE.

	Code	OEM new	OEM old
LOCK NUT	64829	1461417	1302791
● Model			
★ Application			
● 3 BUS			
★			
● 3 TRUCK			
★			
● 4 BUS			
★			
● 4 TRUCK			
★			
● F-K-N BUS			
★			
● P-G-R-T TRUCK			
★			



ALL THE COMPONENTS LISTED IN OUR CATALOGUE ARE NOT ORIGINAL, THOUGH PERFECTLY INTERCHANGEABLE. REFERENCE NUMBERS, EITHER ORIGINAL OR OF A DIFFERENT NATURE, ARE FOR INFORMATION PURPOSES ONLY. WHEN PLACING AN ORDER, PLEASE, ALWAYS USE COSIBO REFERENCE NUMBERS AND DO NOT MENTION THE ORIGINAL REFERENCE NUMBERS OF THE TRUCK MANUFACTURERS IN THE INVOICE TO VEHICLE OWNERS OR TO ANYBODY ELSE. THE CUSTOMER TAKES HIS OWN RESPONSIBILITY IF HE DOES NOT COMPLY WITH WHAT ABOVE.

	Code	OEM new	OEM old
SEAL RING	64103	1871043	1376911
<ul style="list-style-type: none"> ● Model ★ Application 			
	<ul style="list-style-type: none"> ● 4 BUS 		
	<ul style="list-style-type: none"> ★ D9L - DSC12 02/05 - F94 - K94 - D11/D12 		
	<ul style="list-style-type: none"> ● F-K-N BUS 		
	<ul style="list-style-type: none"> ★ D9L - D9 - D12 - DC12 - K D9 720CR - F - N D9 720CR 		
	<ul style="list-style-type: none"> ● IND. MARINE ENGINE 4 		
	<ul style="list-style-type: none"> ★ D16M - SG9 A280 		
	<ul style="list-style-type: none"> ● IND. MARINE ENGINE 5 		
	<ul style="list-style-type: none"> ★ DC9A EMS 		
	<ul style="list-style-type: none"> ● 4 TRUCK 		
	<ul style="list-style-type: none"> ★ DSC12 01/02/03/05 - DC11 01/02 - D11/D12 HPI/PDE - D9L 		
	<ul style="list-style-type: none"> ● P-G-R-T TRUCK 		
	<ul style="list-style-type: none"> ★ D11/D12 - D9 - D13 720CR - DC11/12 - DC16 		



ALL THE COMPONENTS LISTED IN OUR CATALOGUE ARE NOT ORIGINAL, THOUGH PERFECTLY INTERCHANGEABLE. REFERENCE NUMBERS, EITHER ORIGINAL OR OF A DIFFERENT NATURE, ARE FOR INFORMATION PURPOSES ONLY. WHEN PLACING AN ORDER, PLEASE, ALWAYS USE COSIBO REFERENCE NUMBERS AND DO NOT MENTION THE ORIGINAL REFERENCE NUMBERS OF THE TRUCK MANUFACTURERS IN THE INVOICE TO VEHICLE OWNERS OR TO ANYBODY ELSE. THE CUSTOMER TAKES HIS OWN RESPONSIBILITY IF HE DOES NOT COMPLY WITH WHAT ABOVE.

SOLENOID VALVE



	Code	OEM new	OEM old
● Model	65191	2038653	1536304 1340231 1421322
★ Application			
● 3 BUS			
★	DS11 DSC11 - DSC1104 1127 - GR801R K113		
● 4 BUS			
★	ADA1350 ABS&TC&BSB - GR801R K/L94 - 124 CN94		
● 3 TRUCK			
★	DN9 - DN11 - DSC14 - DSC14 LHD CR - DS9 DSC9 - DS9 4X4 - DS11 DSC11 - DS9 DSC9 6X4 - DTC11 - GR/GRS900R		
● 4 TRUCK			
★	8X8 WLS/ZLS - EBS 8X2 8X4 8X2/6 A/B - ABS 4X2 6X2 8X2 6X4 8X4 6X2/4 8X2/4 8X4/4 - 6X2 AD FR ABS		

SOLENOID VALVE



	65470	1376794	
● F-K-N BUS			
★	K/N		
● P-G-R-T TRUCK			
★	4X4 6X2 6X6 8X6 - 6X4 8X4 WITH TC - A6X2A/B WITH EBS		

SWITCH



	61708	288649	
● 3 BUS			
★	MANUAL AND AUTOMATIC GEARBOX		
● 3 TRUCK			
★			

ALL THE COMPONENTS LISTED IN OUR CATALOGUE ARE NOT ORIGINAL, THOUGH PERFECTLY INTERCHANGEABLE. REFERENCE NUMBERS, EITHER ORIGINAL OR OF A DIFFERENT NATURE, ARE FOR INFORMATION PURPOSES ONLY. WHEN PLACING AN ORDER, PLEASE, ALWAYS USE COSIBO REFERENCE NUMBERS AND DO NOT MENTION THE ORIGINAL REFERENCE NUMBERS OF THE TRUCK MANUFACTURERS IN THE INVOICE TO VEHICLE OWNERS OR TO ANYBODY ELSE. THE CUSTOMER TAKES HIS OWN RESPONSIBILITY IF HE DOES NOT COMPLY WITH WHAT ABOVE.

BRAKE VALVE



	Code	OEM new	OEM old
● Model	62459	1324663	1324664
★ Application			
● 4 TRUCK			
★ 94 - 114 - 124 - 144 - 164 WITHOUT RETARDER			
● P-G-R-T TRUCK			
★ WITHOUT RETARDER			

BUSHING



	65179	283650	
● 3 BUS			
★			
● 3 TRUCK			
★			

RELAY



	63447	2077837	1431781 1391322 243460
● 3 BUS			
★ DSC1108 - DSC1108B			

SWITCH



	65237	397946	368851
● 3 BUS			
★			
● 3 TRUCK			
★			
● 4 TRUCK			
★			

ALL THE COMPONENTS LISTED IN OUR CATALOGUE ARE NOT ORIGINAL, THOUGH PERFECTLY INTERCHANGEABLE. REFERENCE NUMBERS, EITHER ORIGINAL OR OF A DIFFERENT NATURE, ARE FOR INFORMATION PURPOSES ONLY. WHEN PLACING AN ORDER, PLEASE, ALWAYS USE COSIBO REFERENCE NUMBERS AND DO NOT MENTION THE ORIGINAL REFERENCE NUMBERS OF THE TRUCK MANUFACTURERS IN THE INVOICE TO VEHICLE OWNERS OR TO ANYBODY ELSE. THE CUSTOMER TAKES HIS OWN RESPONSIBILITY IF HE DOES NOT COMPLY WITH WHAT ABOVE.

	Code	OEM new	OEM old
SWITCH	61195	159656	
<ul style="list-style-type: none"> ● Model ★ Application 			
<ul style="list-style-type: none"> ● 3 BUS ★ 			
<ul style="list-style-type: none"> ● 3 TRUCK ★ DTC11 - DN11 - DSC14 - DS9 - DSC9 - DS11 - DSC11 - DN9 			



SENSOR BULB	64070	1361131	
<ul style="list-style-type: none"> ● 4 BUS ★ 94E/124E - 94U - ASA1000 			
<ul style="list-style-type: none"> ● 4 TRUCK ★ 8X8 WLS/ZLS 			



APS AIR DRYER SOLENOIDE VALVE	64405	1928587	1763423
<ul style="list-style-type: none"> ● F-K-N BUS ★ 			
<ul style="list-style-type: none"> ● P-G-R-T TRUCK ★ 			



SENSOR	65486	1781199	1448083 1541703
<ul style="list-style-type: none"> ● P-G-R-T TRUCK ★ 			
<ul style="list-style-type: none"> ● F-K-N BUS ★ 			
<ul style="list-style-type: none"> ● 4 TRUCK ★ 			
<ul style="list-style-type: none"> ● P-G-R-T TRUCK ★ 			



ALL THE COMPONENTS LISTED IN OUR CATALOGUE ARE NOT ORIGINAL, THOUGH PERFECTLY INTERCHANGEABLE. REFERENCE NUMBERS, EITHER ORIGINAL OR OF A DIFFERENT NATURE, ARE FOR INFORMATION PURPOSES ONLY. WHEN PLACING AN ORDER, PLEASE, ALWAYS USE COSIBO REFERENCE NUMBERS AND DO NOT MENTION THE ORIGINAL REFERENCE NUMBERS OF THE TRUCK MANUFACTURERS IN THE INVOICE TO VEHICLE OWNERS OR TO ANYBODY ELSE. THE CUSTOMER TAKES HIS OWN RESPONSIBILITY IF HE DOES NOT COMPLY WITH WHAT ABOVE.

EBS SENSOR



- Model
- ★ Application

Code

OEM new

OEM old

65425

1362168

- 4 TRUCK

- ★

ALL THE COMPONENTS LISTED IN OUR CATALOGUE ARE NOT ORIGINAL, THOUGH PERFECTLY INTERCHANGEABLE. REFERENCE NUMBERS, EITHER ORIGINAL OR OF A DIFFERENT NATURE, ARE FOR INFORMATION PURPOSES ONLY. WHEN PLACING AN ORDER, PLEASE, ALWAYS USE COSIBO REFERENCE NUMBERS AND DO NOT MENTION THE ORIGINAL REFERENCE NUMBERS OF THE TRUCK MANUFACTURERS IN THE INVOICE TO VEHICLE OWNERS OR TO ANYBODY ELSE. THE CUSTOMER TAKES HIS OWN RESPONSIBILITY IF HE DOES NOT COMPLY WITH WHAT ABOVE.

PROTECTION VALVE



- Model
- ★ Application

Code	OEM new	OEM old
65450	2077976	1763422 1774873 1928588

- P-G-R-T TRUCK

★

- F-K-N BUS

★

DRIVER SET



- P-G-R-T TRUCK

★

- F-K-N BUS

★

64201	1755901	
--------------	---------	--

DRIVER VALVE SET



- P-G-R-T TRUCK

★

- F-K-N BUS

★

64202	1774872	1763421
--------------	---------	---------

ALL THE COMPONENTS LISTED IN OUR CATALOGUE ARE NOT ORIGINAL, THOUGH PERFECTLY INTERCHANGEABLE. REFERENCE NUMBERS, EITHER ORIGINAL OR OF A DIFFERENT NATURE, ARE FOR INFORMATION PURPOSES ONLY. WHEN PLACING AN ORDER, PLEASE, ALWAYS USE COSIBO REFERENCE NUMBERS AND DO NOT MENTION THE ORIGINAL REFERENCE NUMBERS OF THE TRUCK MANUFACTURERS IN THE INVOICE TO VEHICLE OWNERS OR TO ANYBODY ELSE. THE CUSTOMER TAKES HIS OWN RESPONSIBILITY IF HE DOES NOT COMPLY WITH WHAT ABOVE.

BRAKE DRUM



● Model
★ Application

Code	OEM new	OEM old
60743	1414153	1361331

● 3 BUS

★

● 3 TRUCK

★

● 4 BUS

★

● 4 TRUCK

★

● F-K-N BUS

★

● P-G-R-T TRUCK

★

ALL THE COMPONENTS LISTED IN OUR CATALOGUE ARE NOT ORIGINAL, THOUGH PERFECTLY INTERCHANGEABLE. REFERENCE NUMBERS, EITHER ORIGINAL OR OF A DIFFERENT NATURE, ARE FOR INFORMATION PURPOSES ONLY. WHEN PLACING AN ORDER, PLEASE, ALWAYS USE COSIBO REFERENCE NUMBERS AND DO NOT MENTION THE ORIGINAL REFERENCE NUMBERS OF THE TRUCK MANUFACTURERS IN THE INVOICE TO VEHICLE OWNERS OR TO ANYBODY ELSE. THE CUSTOMER TAKES HIS OWN RESPONSIBILITY IF HE DOES NOT COMPLY WITH WHAT ABOVE.

OIL COOLER



	Code	OEM new	OEM old
● Model	64415	1804210	1761517
★ Application			
● F-K-N BUS			
★ GR875R - GRS/GRS0895R - GR/GRS/GRS0905R			
● P-G-R-T TRUCK			
★ GR875R - GRS895R - GR/GRS/GRS0905R			

OIL COOLER

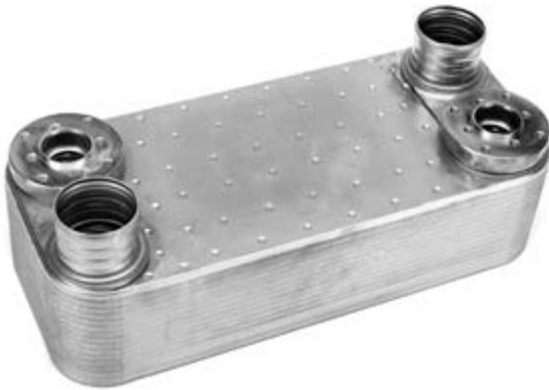

	65309	1414200	
● 4 TRUCK			
★			
● P-G-R-T TRUCK			
★			

ACCUMULATOR



	65440	1502515	1393478
● 4 TRUCK			
★			
● P-G-R-T TRUCK			
★			
● 3 BUS			
★			
● 4 BUS			
★			
● F-K-N BUS			
★			

ALL THE COMPONENTS LISTED IN OUR CATALOGUE ARE NOT ORIGINAL, THOUGH PERFECTLY INTERCHANGEABLE. REFERENCE NUMBERS, EITHER ORIGINAL OR OF A DIFFERENT NATURE, ARE FOR INFORMATION PURPOSES ONLY. WHEN PLACING AN ORDER, PLEASE, ALWAYS USE COSIBO REFERENCE NUMBERS AND DO NOT MENTION THE ORIGINAL REFERENCE NUMBERS OF THE TRUCK MANUFACTURERS IN THE INVOICE TO VEHICLE OWNERS OR TO ANYBODY ELSE. THE CUSTOMER TAKES HIS OWN RESPONSIBILITY IF HE DOES NOT COMPLY WITH WHAT ABOVE.

LH BRAKE CAMSHAFT



	Code	OEM new	OEM old
● Model	64065	1340859	
★ Application			
● 4 BUS			
★ AM860 - AM920 - AMA780 - K124 8X2(AMA60X2) - AMA860 - ASA701			
● F-K-N BUS			
★ AM920 - ASA701 - AMA860 - AMA780 6X2*4 - ARA860 6X2*4 - AMA860/780			
● 3 TRUCK			
★ AM800/AM820			
● 4 TRUCK			
★ AM620 - AM621AM900/920 - AM/AMA740/760/780 - AMA860 - AMFR/AMRE - AM/AMA 8X2 8X4 - ASA700 - ARA900			
● P-G-R-T TRUCK			
★ AM621 - ARA760/820/900 - ASA700			

RH BRAKE CAMSHAFT



	Code	OEM new	OEM old
	64064	1340860	
● 4 BUS			
★ AM860 - AM920 - AMA780 - K124 8X2(AMA60X2) - AMA860 - ASA701			
● F-K-N BUS			
★ AM920 - ASA701 - AMA860 - AMA780 6X2*4 - ARA860 6X2*4 - AMA860/780			
● 3 TRUCK			
★ AM800/AM820			
● 4 TRUCK			
★ AM620 - AM621AM900/920 - AM/AMA740/760/780 - AMA860 - AMFR/AMRE - AM/AMA 8X2 8X4 - ASA700 - ARA900			
● P-G-R-T TRUCK			
★ AM621 - ARA760/820/900 - ASA700			

ALL THE COMPONENTS LISTED IN OUR CATALOGUE ARE NOT ORIGINAL, THOUGH PERFECTLY INTERCHANGEABLE. REFERENCE NUMBERS, EITHER ORIGINAL OR OF A DIFFERENT NATURE, ARE FOR INFORMATION PURPOSES ONLY. WHEN PLACING AN ORDER, PLEASE, ALWAYS USE COSIBO REFERENCE NUMBERS AND DO NOT MENTION THE ORIGINAL REFERENCE NUMBERS OF THE TRUCK MANUFACTURERS IN THE INVOICE TO VEHICLE OWNERS OR TO ANYBODY ELSE. THE CUSTOMER TAKES HIS OWN RESPONSIBILITY IF HE DOES NOT COMPLY WITH WHAT ABOVE.

LH BRAKE CAMSHAFT



	Code	OEM new	OEM old
● Model	64260	1342745	
★ Application			
● 3 BUS			
★	K 113 CLP/TLP - AD/ADA90 - ATA90		
● 3 TRUCK			
★	AD80 R641/653 - RB652 - AD90 R642 4X4 - R770/780 - AD/ADA90 R642/660/770 - RB652 - 6X4 8X4 - AD100 RP831 4X4 6X4 - RP831/832 6X4 6X6 8X4 - AD100 RBP831/832 6X4 6X6 8X4 - ASA80		
● 4 BUS			
★	AD1300 - ASA1300		
● 4 TRUCK			
★	AD/ADA1100/1300/1500 - AD/ADA1500P RP832 - AD/ADA1501P - AD/ADA1300 R660 - AS1300		
● F-K-N BUS			
★	ADA1300 4X2 6X2 6X2/4 - AD1300		
● P-G-R-T TRUCK			
★	4X4 6X4 6X6 8X4 8X4/4 - ADA1100/1300 - AD1300 - AD/1501P - ASA1000		

RH BRAKE CAMSHAFT



	64261	1342746	
● 3 BUS			
★	K 113 CLP/TLP - AD/ADA90 - ATA90		
● 3 TRUCK			
★	AD80 R641/653 - RB652 - AD90 R642 4X4 - R770/780 - AD/ADA90 R642/660/770 - RB652 - 6X4 8X4 - AD100 RP831 4X4 6X4 - RP831/832 6X4 6X6 8X4 - AD100 RBP831/832 6X4 6X6 8X4 - ASA80		
● 4 BUS			
★	AD1300 - ASA1300		
● 4 TRUCK			
★	AD/ADA1100/1300/1500 - AD/ADA1500P RP832 - AD/ADA1501P - AD/ADA1300 R660 - AS1300		
● F-K-N BUS			
★	ADA1300 4X2 6X2 6X2/4 - AD1300		
● P-G-R-T TRUCK			
★	4X4 6X4 6X6 8X4 8X4/4 - ADA1100/1300 - AD1300 - AD/1501P - ASA1000		

ALL THE COMPONENTS LISTED IN OUR CATALOGUE ARE NOT ORIGINAL, THOUGH PERFECTLY INTERCHANGEABLE. REFERENCE NUMBERS, EITHER ORIGINAL OR OF A DIFFERENT NATURE, ARE FOR INFORMATION PURPOSES ONLY. WHEN PLACING AN ORDER, PLEASE, ALWAYS USE COSIBO REFERENCE NUMBERS AND DO NOT MENTION THE ORIGINAL REFERENCE NUMBERS OF THE TRUCK MANUFACTURERS IN THE INVOICE TO VEHICLE OWNERS OR TO ANYBODY ELSE. THE CUSTOMER TAKES HIS OWN RESPONSIBILITY IF HE DOES NOT COMPLY WITH WHAT ABOVE.

	Code	OEM new	OEM old
LH BRAKE CAMSHAFT	64255	1342747	330655
● Model			
★ Application			
● 3 TRUCK			
★			
● 4 BUS			
★			
● 4 TRUCK			
★			
● P-G-R-T TRUCK			
★			



RH BRAKE CAMSHAFT	64254	1342748	
● 3 TRUCK			
★			
● 4 BUS			
★			
● 4 TRUCK			
★			
● P-G-R-T TRUCK			
★			



ALL THE COMPONENTS LISTED IN OUR CATALOGUE ARE NOT ORIGINAL, THOUGH PERFECTLY INTERCHANGEABLE. REFERENCE NUMBERS, EITHER ORIGINAL OR OF A DIFFERENT NATURE, ARE FOR INFORMATION PURPOSES ONLY. WHEN PLACING AN ORDER, PLEASE, ALWAYS USE COSIBO REFERENCE NUMBERS AND DO NOT MENTION THE ORIGINAL REFERENCE NUMBERS OF THE TRUCK MANUFACTURERS IN THE INVOICE TO VEHICLE OWNERS OR TO ANYBODY ELSE. THE CUSTOMER TAKES HIS OWN RESPONSIBILITY IF HE DOES NOT COMPLY WITH WHAT ABOVE.

OIL SEAL 38,1X50X6,80



	Code	OEM new	OEM old
● Model	64800	1349089	
★ Application			
● 3 BUS			
★	AMA56/61 - AMI61 - AM56/61		
● 3 TRUCK			
★	AM800/820		
● 4 BUS			
★	AM780/860/920 - K124 8X2 AMA60X2 - AMA860 - ASA701		
● 4 TRUCK			
★	AM/AMA740/760/780 - AM620/621 - AM900/920 - ASA70/700/900 - ARA900 - AMD900		
● F-K-N BUS			
★	AM920 - ASA701 - AMA780 - AMA860 - AM780 6X2/4 - ARA860 6X2/4 - KIB		
● P-G-R-T TRUCK			
★	AM621 - AMD900 - ARA760/820/900 - ASA700 - AS900		

BRONZE BUSHING



	60547	289336	
● 3 BUS			
★	AM56 - AM61 - AMA56 - AMA61 - AMI61		
● 4 BUS			
★	AM860 - AM920 - AMA780 - AMA860 - K124 8X2(MA60X2) - ASA701		
● F-K-N BUS			
★	AM920 - ASA701 - AMA860 - AM780 6X2*4 - ARA860 6X2*4 - AMA860/780		
● 3 TRUCK			
★	AM56 - AM56 MK8X4 - AM56 HK/MK8X4 - AM61 - AM70 - AM/AMA61 - AM61 MK8X4 - AM61 HK/MK/EK8X4 - AMD105 - AM800/AM820 - AS60 (6X2) - ASA70 (6X2) - AS90 (6X2 8X2) - ARA56 - ARA61		
● 4 TRUCK			
★	AM620 - AM621 - AM900/920 - AM/AMA740/760/780 - AMA860 - ASA 700 - ASA70 (6X2) - AMFR/AMRE AM/AMA 8X2 8X4 - ARA900 - AS900 - AMD900		
● P-G-R-T TRUCK			
★	AM621 - AMD900 - ARA760/820/900 - ASA700 - AS900		

ALL THE COMPONENTS LISTED IN OUR CATALOGUE ARE NOT ORIGINAL, THOUGH PERFECTLY INTERCHANGEABLE. REFERENCE NUMBERS, EITHER ORIGINAL OR OF A DIFFERENT NATURE, ARE FOR INFORMATION PURPOSES ONLY. WHEN PLACING AN ORDER, PLEASE, ALWAYS USE COSIBO REFERENCE NUMBERS AND DO NOT MENTION THE ORIGINAL REFERENCE NUMBERS OF THE TRUCK MANUFACTURERS IN THE INVOICE TO VEHICLE OWNERS OR TO ANYBODY ELSE. THE CUSTOMER TAKES HIS OWN RESPONSIBILITY IF HE DOES NOT COMPLY WITH WHAT ABOVE.

	Code	OEM new	OEM old
METAL BUSHING (OLD TYPE)	60547/1	134494	
● Model			
★ Application			
● 3 BUS			
★ AM56 - AM61 - AMA56 - AMA61 - AMI61			
● 4 BUS			
★ AM860 - AM920 - AMA780 - AMA860 - K124 8X2(MA60X2) - ASA701			
● F-K-N BUS			
★ AM920 - ASA701 - AMA860 - AM780 6X2*4 - ARA860 6X2*4 - AMA860/780			
● 3 TRUCK			
★ AM56 - AM56 MK8X4 - AM56 HK/MK8X4 - AM61 - AM70 - AM/AMA61 - AM61 MK8X4 - AM61 HK/MK/EK8X4 - AMD105 - AM800/AM820 - AS60 (6X2) - ASA70 (6X2) - AS90 (6X2 8X2) - ARA56 - ARA61			
● 4 TRUCK			
★ AM620 - AM621 - AM900/920 - AM/AMA740/760/780 - AMA860 - ASA 700 - ASA70 (6X2) - AMFR/AMRE AM/AMA 8X2 8X4 - ARA900 - AS900 - AMD900			
● P-G-R-T TRUCK			
★ AM621 - AMD900 - ARA760/820/900 - ASA700 - AS900			



	Code	OEM new	OEM old
SEAL RING	64088	1321727	
<ul style="list-style-type: none"> ● Model ★ Application 			
<ul style="list-style-type: none"> ● 3 BUS 			
★ ATA90			
<ul style="list-style-type: none"> ● 4 BUS 			
★ ADA1300 R660 - R780 - AD1300 - ASA1300			
<ul style="list-style-type: none"> ● F-K-N BUS 			
★ ADA1300 4X2 6X2 6X2*4 - F AD1300			
<ul style="list-style-type: none"> ● 3 TRUCK 			
★ AD85 RBP730 6X4HK 8X4HK ADFR ADRE - AD85 RP730 6X4HK 8X4HK ADRE			
<ul style="list-style-type: none"> ● 4 TRUCK 			
★ AD/ADA1501P - RBP/RP832 835 - 4X4 6X6 - AD/ADA1501P ADRE 6X4 8X4 - 8X8 AD1101P - AD1100P 4X4 - 6X4 - 8X4 - 6X6 ADRE - AS1300 - ASA1000 6X2 - 8X2 - 8X2/4 - AD/ADA1500P RP832 - ADRE 6X4 - 8X4 - 6X6 - 8X8 - AD/ADA1500P - 1501P ADFR 6X4 - 6X6 - 8X4 - AD/ADA1300 ADRE R660/ADFR RB660 6X4 - 8X4 - ASA80 6X2 - AD/ADA1100/1300/1500			
<ul style="list-style-type: none"> ● P-G-R-T TRUCK 			
★ 6X4 8X4 8X4*4 - 4X4 6X6 AMRE - 6X6 AD FR - ADA1100/1300 - ADA1501P - AD1501P - ASA1000			



SEAL RING DIAM.45x60x7 (NBR)	60958	120828	
<ul style="list-style-type: none"> ● 3 TRUCK 			
★ AD90 R642 4X2 - AD100 RP831 4X4 - AD80 R641 - AD90 R770/R780 - AD100 RBP831 6X4 AD FR - AD100 RBP831/832 6X4 6X6 8X4 AD FR - AD RE - AD100 RP831 6X4 8X4 E6X4 EL8X4 AD RE - AD/ADA90 R642/660/770 - AD80 RB652 AD FR M6X4fb MK8X4 - AD80 R653 AD RE M6X4fb MK6X4 MK8X4 - AD90 RB652 AD FR 6X4 8X4 - AD90 R653 AD RE 6X4 8X4 - ASA80 MV6X2LB ML6X2A/B MA6X2A			



ALL THE COMPONENTS LISTED IN OUR CATALOGUE ARE NOT ORIGINAL, THOUGH PERFECTLY INTERCHANGEABLE. REFERENCE NUMBERS, EITHER ORIGINAL OR OF A DIFFERENT NATURE, ARE FOR INFORMATION PURPOSES ONLY. WHEN PLACING AN ORDER, PLEASE, ALWAYS USE COSIBO REFERENCE NUMBERS AND DO NOT MENTION THE ORIGINAL REFERENCE NUMBERS OF THE TRUCK MANUFACTURERS IN THE INVOICE TO VEHICLE OWNERS OR TO ANYBODY ELSE. THE CUSTOMER TAKES HIS OWN RESPONSIBILITY IF HE DOES NOT COMPLY WITH WHAT ABOVE.

	Code	OEM new	OEM old
BRAKE PIN	61335	280652	
● Model			
★ Application			
● 3 BUS			
★			
● 3 TRUCK			
★			
● 4 BUS			
★			
● 4 TRUCK			
★			
● F-K-N BUS			
★			
● P-G-R-T TRUCK			
★			



	61622	1852817	1402272
BRAKE DISK			
● 4 BUS			
★ AM/AMA/AMI - ASA1300 - ARA860 - AMA780/860 - AMI700 - ADA1300			
● 4 TRUCK			
★ ASA700/752/1000/1052 - AM/AMA - AD/ADA - ARA760/820/900			
● F-K-N BUS			
★ ARA860 - AM/AMA860 - AMA780 - AMI700 - ASA760/1300			
● P-G-R-T TRUCK			
★ AMA860 - ADA1300 - ASA700/720/752/760/1000/1052			



ALL THE COMPONENTS LISTED IN OUR CATALOGUE ARE NOT ORIGINAL, THOUGH PERFECTLY INTERCHANGEABLE. REFERENCE NUMBERS, EITHER ORIGINAL OR OF A DIFFERENT NATURE, ARE FOR INFORMATION PURPOSES ONLY. WHEN PLACING AN ORDER, PLEASE, ALWAYS USE COSIBO REFERENCE NUMBERS AND DO NOT MENTION THE ORIGINAL REFERENCE NUMBERS OF THE TRUCK MANUFACTURERS IN THE INVOICE TO VEHICLE OWNERS OR TO ANYBODY ELSE. THE CUSTOMER TAKES HIS OWN RESPONSIBILITY IF HE DOES NOT COMPLY WITH WHAT ABOVE.

	Code	OEM new	OEM old
REPAIR SET	63757	280651	
<ul style="list-style-type: none"> ● Model ★ Application 			
<ul style="list-style-type: none"> ● 3 BUS ★ 			
<ul style="list-style-type: none"> ● 3 TRUCK ★ 			
<ul style="list-style-type: none"> ● 4 BUS ★ 			
<ul style="list-style-type: none"> ● 4 TRUCK ★ 			
<ul style="list-style-type: none"> ● F-K-N BUS ★ 			
<ul style="list-style-type: none"> ● P-G-R-T TRUCK ★ 			



BRAKE PAD SET	61906	1856108	1390428 1527633 1734529 1890861
<ul style="list-style-type: none"> ● 4 TRUCK ★ AM/AMA - AD/ADA - ARA - ASA 			



ALL THE COMPONENTS LISTED IN OUR CATALOGUE ARE NOT ORIGINAL, THOUGH PERFECTLY INTERCHANGEABLE. REFERENCE NUMBERS, EITHER ORIGINAL OR OF A DIFFERENT NATURE, ARE FOR INFORMATION PURPOSES ONLY. WHEN PLACING AN ORDER, PLEASE, ALWAYS USE COSIBO REFERENCE NUMBERS AND DO NOT MENTION THE ORIGINAL REFERENCE NUMBERS OF THE TRUCK MANUFACTURERS IN THE INVOICE TO VEHICLE OWNERS OR TO ANYBODY ELSE. THE CUSTOMER TAKES HIS OWN RESPONSIBILITY IF HE DOES NOT COMPLY WITH WHAT ABOVE.

BRAKE PAD WIRE SENSOR



- Model
- ★ Application

Code	OEM new	OEM old
64801	1794440	1731309

- 4 BUS



- 4 TRUCK



- F-K-N BUS



MANUAL SLACK ADJUSTER



- 3 TRUCK

- ★ AMD105 - AD90 R653 6X4 8X4

61163	1448110	218684
--------------	---------	--------

LH MANUAL SLACK ADJUSTER



- 3 BUS



- 3 TRUCK

- ★ AM56/61/70 - AMA61

61166	1448111	276517
--------------	---------	--------

ALL THE COMPONENTS LISTED IN OUR CATALOGUE ARE NOT ORIGINAL, THOUGH PERFECTLY INTERCHANGEABLE. REFERENCE NUMBERS, EITHER ORIGINAL OR OF A DIFFERENT NATURE, ARE FOR INFORMATION PURPOSES ONLY. WHEN PLACING AN ORDER, PLEASE, ALWAYS USE COSIBO REFERENCE NUMBERS AND DO NOT MENTION THE ORIGINAL REFERENCE NUMBERS OF THE TRUCK MANUFACTURERS IN THE INVOICE TO VEHICLE OWNERS OR TO ANYBODY ELSE. THE CUSTOMER TAKES HIS OWN RESPONSIBILITY IF HE DOES NOT COMPLY WITH WHAT ABOVE.

RH MANUAL SLACK ADJUSTER



	Code	OEM new	OEM old
● Model	61167	1448112	276518
★ Application			
● 3 BUS			
★			
● 3 TRUCK			
★ AM56/61/70 - AMA61			

LH MANUAL SLACK ADJUSTER



	Code	OEM new	OEM old
	61169	1448115	278736
● 3 BUS			
★			
● 3 TRUCK			
★			
● 4 BUS			
★ ADA1300 R660/780 - AD1300 - ASA1300			
● 4 TRUCK			
★ AD/ADA1100 - AD/ADA1300 - AD/ADA1500 - AD/ADA1501 - ASA1000 - AS1300			
● F-K-N BUS			
★ ADA1300 4X2 6X2 6X2/4 - AD1300			
● P-G-R-T TRUCK			
★ ADA1100/1300 - AD1300 - AD/ADA1501P - ASA1000			

ALL THE COMPONENTS LISTED IN OUR CATALOGUE ARE NOT ORIGINAL, THOUGH PERFECTLY INTERCHANGEABLE. REFERENCE NUMBERS, EITHER ORIGINAL OR OF A DIFFERENT NATURE, ARE FOR INFORMATION PURPOSES ONLY. WHEN PLACING AN ORDER, PLEASE, ALWAYS USE COSIBO REFERENCE NUMBERS AND DO NOT MENTION THE ORIGINAL REFERENCE NUMBERS OF THE TRUCK MANUFACTURERS IN THE INVOICE TO VEHICLE OWNERS OR TO ANYBODY ELSE. THE CUSTOMER TAKES HIS OWN RESPONSIBILITY IF HE DOES NOT COMPLY WITH WHAT ABOVE.

RH MANUAL SLACK ADJUSTER



	Code	OEM new	OEM old
● Model	61257	1448114	278735
★ Application			
● 3 BUS			
★			
● 3 TRUCK			
★			
● 4 BUS			
★	ADA1300 R660/780 - AD1300 - ASA1300		
● 4 TRUCK			
★	AD/ADA1100 - AD/ADA1300 - AD/ADA1500 - AD/ADA1501 - ASA1000 - AS1300		
● F-K-N BUS			
★	ADA1300 4X2 6X2 6X2/4 - AD1300		
● P-G-R-T TRUCK			
★	ADA1100/1300 - AD1300 - AD/ADA1501P - ASA1000		

LH MANUAL SLACK ADJUSTER



	61260	218831	
● 3 BUS			
★			

RH MANUAL SLACK ADJUSTER



	61259	218832	
● 3 BUS			
★			

ALL THE COMPONENTS LISTED IN OUR CATALOGUE ARE NOT ORIGINAL, THOUGH PERFECTLY INTERCHANGEABLE. REFERENCE NUMBERS, EITHER ORIGINAL OR OF A DIFFERENT NATURE, ARE FOR INFORMATION PURPOSES ONLY. WHEN PLACING AN ORDER, PLEASE, ALWAYS USE COSIBO REFERENCE NUMBERS AND DO NOT MENTION THE ORIGINAL REFERENCE NUMBERS OF THE TRUCK MANUFACTURERS IN THE INVOICE TO VEHICLE OWNERS OR TO ANYBODY ELSE. THE CUSTOMER TAKES HIS OWN RESPONSIBILITY IF HE DOES NOT COMPLY WITH WHAT ABOVE.

LH MANUAL SLACK ADJUSTER



Code	OEM new	OEM old
61266	309421	
<ul style="list-style-type: none"> ● Model ★ Application 		
<ul style="list-style-type: none"> ● 3 TRUCK 		
<ul style="list-style-type: none"> ★ AS60 6X2 - ASA70 6X2 		
<ul style="list-style-type: none"> ● 4 TRUCK 		
<ul style="list-style-type: none"> ★ ASA70 6X2 		

RH MANUAL SLACK ADJUSTER



Code	OEM new	OEM old
61265	309422	
<ul style="list-style-type: none"> ● 3 TRUCK 		
<ul style="list-style-type: none"> ★ AS60 6X2 - ASA70 6X2 		
<ul style="list-style-type: none"> ● 4 TRUCK 		
<ul style="list-style-type: none"> ★ ASA70 6X2 		

LH MANUAL SLACK ADJUSTER



Code	OEM new	OEM old
63791	1865749	1448116 362044
<ul style="list-style-type: none"> ● 3 BUS ★ 		
<ul style="list-style-type: none"> ● 3 TRUCK 		
<ul style="list-style-type: none"> ★ AS90 6X2 8X2 		
<ul style="list-style-type: none"> ● 4 TRUCK 		
<ul style="list-style-type: none"> ★ AS900 		
<ul style="list-style-type: none"> ● P-G-R-T TRUCK 		
<ul style="list-style-type: none"> ★ AS900 		

ALL THE COMPONENTS LISTED IN OUR CATALOGUE ARE NOT ORIGINAL, THOUGH PERFECTLY INTERCHANGEABLE. REFERENCE NUMBERS, EITHER ORIGINAL OR OF A DIFFERENT NATURE, ARE FOR INFORMATION PURPOSES ONLY. WHEN PLACING AN ORDER, PLEASE, ALWAYS USE COSIBO REFERENCE NUMBERS AND DO NOT MENTION THE ORIGINAL REFERENCE NUMBERS OF THE TRUCK MANUFACTURERS IN THE INVOICE TO VEHICLE OWNERS OR TO ANYBODY ELSE. THE CUSTOMER TAKES HIS OWN RESPONSIBILITY IF HE DOES NOT COMPLY WITH WHAT ABOVE.

	Code	OEM new	OEM old
RH MANUAL SLACK ADJUSTER	63792	1448117	362045
<ul style="list-style-type: none"> ● Model ★ Application 			
<ul style="list-style-type: none"> ● 3 TRUCK ★ AS90 6X2 8X2 			
<ul style="list-style-type: none"> ● 4 TRUCK ★ AS900 			
<ul style="list-style-type: none"> ● P-G-R-T TRUCK ★ AS900 			
<ul style="list-style-type: none"> ● 3 BUS ★ 			



MANUAL SLACK ADJUSTER	61168	1448113	278734
<ul style="list-style-type: none"> ● 3 BUS ★ 			
<ul style="list-style-type: none"> ● 3 TRUCK ★ AD80 R641/653 RB652 - AD90 R770/780 RB652 6X4 8X4 - AD/ADA90 R642/660/770 - AD100 RP831 - 			
<ul style="list-style-type: none"> ● 4 BUS ★ 			
<ul style="list-style-type: none"> ● 4 TRUCK ★ AD/ADA1100/1300/1500 			



LH AUTOMATIC SLACK ADJUSTER	63346	1112829	
<ul style="list-style-type: none"> ● 3 BUS ★ 			
<ul style="list-style-type: none"> ● 3 TRUCK ★ AM56/61/70 - AM56 HK/MK8X4 - AM61 EK/HK/MK8X4 - AM/AMA61 			



ALL THE COMPONENTS LISTED IN OUR CATALOGUE ARE NOT ORIGINAL, THOUGH PERFECTLY INTERCHANGEABLE. REFERENCE NUMBERS, EITHER ORIGINAL OR OF A DIFFERENT NATURE, ARE FOR INFORMATION PURPOSES ONLY. WHEN PLACING AN ORDER, PLEASE, ALWAYS USE COSIBO REFERENCE NUMBERS AND DO NOT MENTION THE ORIGINAL REFERENCE NUMBERS OF THE TRUCK MANUFACTURERS IN THE INVOICE TO VEHICLE OWNERS OR TO ANYBODY ELSE. THE CUSTOMER TAKES HIS OWN RESPONSIBILITY IF HE DOES NOT COMPLY WITH WHAT ABOVE.

RH AUTOMATIC SLACK ADJUSTER



	Code	OEM new	OEM old
● Model	63347	1112830	
★ Application			
● 3 BUS			
★			
● 3 TRUCK			
★	AM56/61/70 - AM56 HK/MK8X4 - AM61 EK/HK/MK8X4 - AM/AMAG1		

AUTOMATIC SLACK ADJUSTER



	Code	OEM new	OEM old
	63348	1789560	1112831
● 3 BUS			
★			
● 3 TRUCK			
★	AD80 R641 RB652/653 6X4 - AD90 R770/780 RB652 6X4 8X4 - AD/ADA90 R642/660/770 - AD100 RP831		
● 4 TRUCK			
★	AD/ADA1100/1300/1500		

LH REAR AUTOMATIC SLACK ADJUSTER



	Code	OEM new	OEM old
	63349	1789561	1112833
● 3 BUS			
★			
● 3 TRUCK			
★	AD90 R770/780 - AD/ADA90 R642/660/770 - AD100 RP/RBP831 6X4 8X4 - AD80 RB652 MK 8X4 - AD80 RB653 MK 6X4/8X4 - AD100 RP831 EL6X4/8X4 - ASA80 MV6X2LB ML6X2A/B MA6X2A		
● 4 BUS			
★	ADA1300 R660/780 - AD1300 - ASA1300		
● 4 TRUCK			
★	AD/ADA1100/1300/1500 - AD/ADA1500P RP832 6X4 6X6 8X4 8X8 - ASA80 6X2 - AD/ADA1500/1501P 6X4 6X6 8X4 - AD/ADA1300 R660 6X4/8X4 RB660 - ASA1000 6X2 8X2 8X2/4 - AS1300 - AD/ADA1501P RP/RBP832/835 4X4 6X6		
● F-K-N BUS			
★	ADA1300 4X2 6X2 6X2/4 - F AD1300		
● P-G-R-T TRUCK			
★	6X4 8X4 8X4/4 - 6X6 AD FR - 4X4 6X6 AM RE - ADA1100/1300 - AD1300 - ADA1501P - ASA1000		

ALL THE COMPONENTS LISTED IN OUR CATALOGUE ARE NOT ORIGINAL, THOUGH PERFECTLY INTERCHANGEABLE. REFERENCE NUMBERS, EITHER ORIGINAL OR OF A DIFFERENT NATURE, ARE FOR INFORMATION PURPOSES ONLY. WHEN PLACING AN ORDER, PLEASE, ALWAYS USE COSIBO REFERENCE NUMBERS AND DO NOT MENTION THE ORIGINAL REFERENCE NUMBERS OF THE TRUCK MANUFACTURERS IN THE INVOICE TO VEHICLE OWNERS OR TO ANYBODY ELSE. THE CUSTOMER TAKES HIS OWN RESPONSIBILITY IF HE DOES NOT COMPLY WITH WHAT ABOVE.

RH REAR AUTOMATIC SLACK ADJUSTER



	Code	OEM new	OEM old
● Model	63350	1789562	1112834
★ Application			
● 3 BUS			
★			
● 3 TRUCK			
★	AD90 R770/780 - AD/ADA90 R642/660/770 - AD100 RP/RBP831 6X4 8X4 - AD80 RB652 MK 8X4 - AD80 RB653 MK 6X4/8X4 - AD100 RP831 EL6X4/8X4 - ASA80 MV6X2LB ML6X2A/B MA6X2A		
● 4 BUS			
★	ADA1300 R660/780 - AD1300 - ASA1300		
● 4 TRUCK			
★	AD/ADA1100/1300/1500 - AD/ADA1500P RP832 6X4 6X6 8X4 8X8 - ASA80 6X2 - AD/ADA1500/1501P 6X4 6X6 8X4 - AD/ADA1300 R660 6X4/8X4 RB660 - ASA1000 6X2 8X2 8X2/4 - AS1300 - AD/ADA1501P RP/RBP832/835 4X4 6X6		
● F-K-N BUS			
★	ADA1300 4X2 6X2 6X2/4 - F AD1300		
● P-G-R-T TRUCK			
★	6X4 8X4 8X4/4 - 6X6 AD FR - 4X4 6X6 AM RE - ADA1100/1300 - AD1300 - ADA1501P - ASA1000		

LH FRONT AUTOMATIC SLACK ADJUSTER



	63894	1789567	1358634
● 3 TRUCK			
★	AM800/820		
● 4 BUS			
★	AMA780/860 - K124 8X2 AMA60X2 - AM860/920 - ASA701		
● 4 TRUCK			
★	AM/AMA740/760/780 - AMA860 - AM620/621/900/920 - AMFR - AMRE AM/AMA 8X2 8X4 - ASA700 - ARA900		
● F-K-N BUS			
★	AM920 - ASA701 - AMA780/860 6X2/4 - ARA860 6X2/4		
● P-G-R-T TRUCK			
★	AM621 - ARA760/820/900 - ASA700		

ALL THE COMPONENTS LISTED IN OUR CATALOGUE ARE NOT ORIGINAL, THOUGH PERFECTLY INTERCHANGEABLE. REFERENCE NUMBERS, EITHER ORIGINAL OR OF A DIFFERENT NATURE, ARE FOR INFORMATION PURPOSES ONLY. WHEN PLACING AN ORDER, PLEASE, ALWAYS USE COSIBO REFERENCE NUMBERS AND DO NOT MENTION THE ORIGINAL REFERENCE NUMBERS OF THE TRUCK MANUFACTURERS IN THE INVOICE TO VEHICLE OWNERS OR TO ANYBODY ELSE. THE CUSTOMER TAKES HIS OWN RESPONSIBILITY IF HE DOES NOT COMPLY WITH WHAT ABOVE.

RH FRONT AUTOMATIC SLACK ADJUSTER



	Code	OEM new	OEM old
● Model ★ Application	63893	1789568	1358635
● 4 BUS			
★ AMA780/860 - K124 8X2 AMA60X2 - AM860/920 - ASA701			
● F-K-N BUS			
★ AM920 - ASA701 - AMA780/860 6X2/4 - ARA860 6X2/4			
● 3 TRUCK			
★ AM800/820			
● 4 TRUCK			
★ AM/AMA740/760/780 - AMA860 - AM620/621/900/920 - AMFR - AMRE AM/AMA 8X2 8X4 - ASA700 - ARA900			
● P-G-R-T TRUCK			
★ AM621 - ARA760/820/900 - ASA700			

LH REAR AUTOMATIC SLACK ADJUSTER



	65384	394195	
● 3 TRUCK			
★ AS60 6X2 - ASA70 6X2			
● 4 TRUCK			
★ ASA70 6X2			

RH REAR AUTOMATIC SLACK ADJUSTER



	65385	394196	
● 3 TRUCK			
★ AS60 6X2 - ASA70 6X2			
● 4 TRUCK			
★ ASA70 6X2			

ALL THE COMPONENTS LISTED IN OUR CATALOGUE ARE NOT ORIGINAL, THOUGH PERFECTLY INTERCHANGEABLE. REFERENCE NUMBERS, EITHER ORIGINAL OR OF A DIFFERENT NATURE, ARE FOR INFORMATION PURPOSES ONLY. WHEN PLACING AN ORDER, PLEASE, ALWAYS USE COSIBO REFERENCE NUMBERS AND DO NOT MENTION THE ORIGINAL REFERENCE NUMBERS OF THE TRUCK MANUFACTURERS IN THE INVOICE TO VEHICLE OWNERS OR TO ANYBODY ELSE. THE CUSTOMER TAKES HIS OWN RESPONSIBILITY IF HE DOES NOT COMPLY WITH WHAT ABOVE.

LH REAR AUTOMATIC SLACK ADJUSTER



	Code	OEM new	OEM old
● Model	65386		
★ Application			
● 3 TRUCK			
★ AD85 RBP730 6X4 8X4 HK AD FR - AD85 RP730 6X4 8X4 HK AD RE			
● 4 TRUCK			
★ AD1100P 4X4 6X4 8X4 - 6X6 ADRE - 8X8 WLS/ZLS AD1101P 8X8			

RH REAR AUTOMATIC SLACK ADJUSTER



	65387	1324358	
● 3 TRUCK			
★ AD85 RBP730 6X4 8X4 HK AD FR - AD85 RP730 6X4 8X4 HK AD RE			
● 4 TRUCK			
★ AD1100P 4X4 6X4 8X4 - 6X6 ADRE - 8X8 WLS/ZLS AD1101P 8X8			

LH FRONT AUTOMATIC SLACK ADJUSTER



	65388	1789565	1356695
● 4 TRUCK			
★ AMD900			
● P-G-R-T TRUCK			
★ AMD900			

ALL THE COMPONENTS LISTED IN OUR CATALOGUE ARE NOT ORIGINAL, THOUGH PERFECTLY INTERCHANGEABLE. REFERENCE NUMBERS, EITHER ORIGINAL OR OF A DIFFERENT NATURE, ARE FOR INFORMATION PURPOSES ONLY. WHEN PLACING AN ORDER, PLEASE, ALWAYS USE COSIBO REFERENCE NUMBERS AND DO NOT MENTION THE ORIGINAL REFERENCE NUMBERS OF THE TRUCK MANUFACTURERS IN THE INVOICE TO VEHICLE OWNERS OR TO ANYBODY ELSE. THE CUSTOMER TAKES HIS OWN RESPONSIBILITY IF HE DOES NOT COMPLY WITH WHAT ABOVE.

RH FRONT AUTOMATIC SLACK ADJUSTER



	Code	OEM new	OEM old
● Model	65389	1789566	1356696
★ Application			
● 4 TRUCK			
★ AMD900			
● P-G-R-T TRUCK			
★ AMD900			

AUTOMATIC SLACK ADJUSTER REPAIR SET



	61879	1350817	324728
● 3 BUS			
★			
● 3 TRUCK			
★			
● 4 BUS			
★			
● 4 TRUCK			
★			
● F-K-N BUS			
★			
● P-G-R-T TRUCK			
★			

ALL THE COMPONENTS LISTED IN OUR CATALOGUE ARE NOT ORIGINAL, THOUGH PERFECTLY INTERCHANGEABLE. REFERENCE NUMBERS, EITHER ORIGINAL OR OF A DIFFERENT NATURE, ARE FOR INFORMATION PURPOSES ONLY. WHEN PLACING AN ORDER, PLEASE, ALWAYS USE COSIBO REFERENCE NUMBERS AND DO NOT MENTION THE ORIGINAL REFERENCE NUMBERS OF THE TRUCK MANUFACTURERS IN THE INVOICE TO VEHICLE OWNERS OR TO ANYBODY ELSE. THE CUSTOMER TAKES HIS OWN RESPONSIBILITY IF HE DOES NOT COMPLY WITH WHAT ABOVE.

		Code	OEM new	OEM old
BUSHING	● Model	61323	142575	
	★ Application			
	● 3 BUS			
	★			
	● 3 TRUCK			
	★			
	● 4 TRUCK			
	★			



		60957	1302857	141168 287620
BUSHING	● 3 BUS			
	★	K 113 CLP/TLP - AD/ADA90 - ATA90		
	● 3 TRUCK			
	★	AD80/85/90/100 - ADA90 - ASA80		
	● 4 BUS			
	★	AD/ADA1300 - ASA1300		
	● 4 TRUCK			
	★	ADA1100/1300/1500 - AD/ADA1500P - AD/ADA1501P - AD/ADA1300 - ASA1000 - AS1300 - AD1100P - AD1101P		
	● F-K-N BUS			
	★	AD/ADA1300		
	● P-G-R-T TRUCK			
	★	4X4 6X4 6X6 8X4 8X4/4 - ADA1100/1300 - AD1300 - AD/ADA1501P - ASA1000		



ALL THE COMPONENTS LISTED IN OUR CATALOGUE ARE NOT ORIGINAL, THOUGH PERFECTLY INTERCHANGEABLE. REFERENCE NUMBERS, EITHER ORIGINAL OR OF A DIFFERENT NATURE, ARE FOR INFORMATION PURPOSES ONLY. WHEN PLACING AN ORDER, PLEASE, ALWAYS USE COSIBO REFERENCE NUMBERS AND DO NOT MENTION THE ORIGINAL REFERENCE NUMBERS OF THE TRUCK MANUFACTURERS IN THE INVOICE TO VEHICLE OWNERS OR TO ANYBODY ELSE. THE CUSTOMER TAKES HIS OWN RESPONSIBILITY IF HE DOES NOT COMPLY WITH WHAT ABOVE.

		Code	OEM new	OEM old
PIN 	● Model	61152	1362721	1342340
	★ Application			
	● 3 BUS			
	★	AM/AMA56/61 - AMI61 - AD/ADA90 - ATA90		
	● 3 TRUCK			
	★	AM800/820 - AD85		
	● 4 BUS			
	★	AM920 - AMA780/860 - K124 8X2 AMA60X2 - AM860 - AD/ADA1300 - ASA701 - ASA1300		
	● 4 TRUCK			
	★	AM620/621/900/920 - AM/AMA740/760/780 - AMA860 - AD/ADA1100/1300/1500 - ASA70/80 - AD/ADA1500P - AD/ADA1501P - AS/ASA700 - ARA900 - ASA1000 - ASA1300 - AD1100P - AD1101P		
● F-K-N BUS				
★	AM920 - AMA780/860 - ADA1300 - ASA701 - ARA860			
● P-G-R-T TRUCK				
★	4X4 6X4 6X6 8X4 8X4/4 - ADA1100/1300 - AD1300 - AD/ADA1501P - ARA760/820/900 - ASA700/1000 - AS900 - AM621			

		61153	1338019	381962
O-RING 	● 3 BUS			
	★	AM/AMA56/61 - AMI61 - AD/ADA90 - ATA90		
	● 3 TRUCK			
	★	AM800/820 - AD85		
	● 4 BUS			
	★	AM920 - AMA780/860 - K124 8X2 AMA60X2 - AM860 - AD/ADA1300 - ASA701 - ASA1300		
	● 4 TRUCK			
	★	AM620/621/900/920 - AM/AMA740/760/780 - AMA860 - AD/ADA1100/1300/1500 - ASA70/80 - AD/ADA1500P - AD/ADA1501P - AS/ASA700 - ARA900 - ASA1000 - ASA1300 - AD1100P - AD1101P		
	● F-K-N BUS			
	★	AM920 - AMA780/860 - ADA1300 - ASA701 - ARA860		
● P-G-R-T TRUCK				
★	4X4 6X4 6X6 8X4 8X4/4 - ADA1100/1300 - AD1300 - AD/ADA1501P - ARA760/820/900 - ASA700/1000 - AS900 - AM621			

ALL THE COMPONENTS LISTED IN OUR CATALOGUE ARE NOT ORIGINAL, THOUGH PERFECTLY INTERCHANGEABLE. REFERENCE NUMBERS, EITHER ORIGINAL OR OF A DIFFERENT NATURE, ARE FOR INFORMATION PURPOSES ONLY. WHEN PLACING AN ORDER, PLEASE, ALWAYS USE COSIBO REFERENCE NUMBERS AND DO NOT MENTION THE ORIGINAL REFERENCE NUMBERS OF THE TRUCK MANUFACTURERS IN THE INVOICE TO VEHICLE OWNERS OR TO ANYBODY ELSE. THE CUSTOMER TAKES HIS OWN RESPONSIBILITY IF HE DOES NOT COMPLY WITH WHAT ABOVE.

O-RING DIAM.=59,5X3 mm

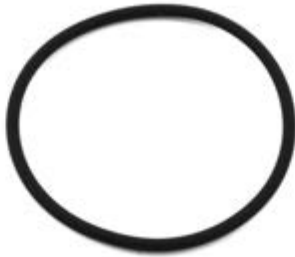

	Code	OEM new	OEM old
● Model	60636	332119	392663
★ Application			
● 3 BUS			
★	GRS/GRSH/R - GR801R		
● 3 TRUCK			
★	GRSH/R - GR/GRS900R		
● 4 BUS			
★	GR801R CN94 - GRS/GRSH/R		
● 4 TRUCK			
★	GR/GRS/GRSH/GRSO/R		
● F-K-N BUS			
★	GR801R/GR900R/GRS890R/GRS900R/GRS920R/GRSO900R		
● P-G-R-T TRUCK			
★	GRSH/R - GR801R/GR900R/GRS890R/GRS900R/GRS920R/GRSO900R		

RETARDER FLEXIBLE HOSE



	61608	1923594	1422701
● 4 TRUCK			
★	GR/GRS/GRH/GRSO/R - GRS890R - GR/GRS900R		
● P-G-R-T TRUCK			
★			

ALL THE COMPONENTS LISTED IN OUR CATALOGUE ARE NOT ORIGINAL, THOUGH PERFECTLY INTERCHANGEABLE. REFERENCE NUMBERS, EITHER ORIGINAL OR OF A DIFFERENT NATURE, ARE FOR INFORMATION PURPOSES ONLY. WHEN PLACING AN ORDER, PLEASE, ALWAYS USE COSIBO REFERENCE NUMBERS AND DO NOT MENTION THE ORIGINAL REFERENCE NUMBERS OF THE TRUCK MANUFACTURERS IN THE INVOICE TO VEHICLE OWNERS OR TO ANYBODY ELSE. THE CUSTOMER TAKES HIS OWN RESPONSIBILITY IF HE DOES NOT COMPLY WITH WHAT ABOVE.

RETARDER HOSE



	Code	OEM new	OEM old
● Model	62518	1923607	1521553 1364902
★ Application			
● 3 BUS			
★ GR801R			
● 4 BUS			
★ GR801R CH 1843282 - CH 1843283 - CH 1838734 - CH 1838735 - CH 3523977 - CH 3523978			

RETARDER FLEXIBLE HOSE



	63764	1923585	1372154 1333735
● 3 TRUCK			
★ GR/GRS900R			
● 4 TRUCK			
★ GRS890R - GR/GRS900R - GRSH900R - GR/GRS/GRSH/GRS0/R -			

RETARDER FLEXIBLE HOSE



	63765	1923586	1372155 1341069
● 3 TRUCK			
★ GR/GRS900R			
● 4 TRUCK			
★ GRS890R GR/GRS900R - GRSH900R			

ALL THE COMPONENTS LISTED IN OUR CATALOGUE ARE NOT ORIGINAL, THOUGH PERFECTLY INTERCHANGEABLE. REFERENCE NUMBERS, EITHER ORIGINAL OR OF A DIFFERENT NATURE, ARE FOR INFORMATION PURPOSES ONLY. WHEN PLACING AN ORDER, PLEASE, ALWAYS USE COSIBO REFERENCE NUMBERS AND DO NOT MENTION THE ORIGINAL REFERENCE NUMBERS OF THE TRUCK MANUFACTURERS IN THE INVOICE TO VEHICLE OWNERS OR TO ANYBODY ELSE. THE CUSTOMER TAKES HIS OWN RESPONSIBILITY IF HE DOES NOT COMPLY WITH WHAT ABOVE.

	Code	OEM new	OEM old
RETARDER FLEXIBLE HOSE	64354	1923599	1452542

- Model
- ★ Application

- P-G-R-T TRUCK

- ★



RETARDER FLEXIBLE HOSE	65026	1923589	1380880
-------------------------------	--------------	---------	---------

- 4 TRUCK

- ★ GRS890R GR/GRS900R - GRSH900R - 4X4 6X6 - GR/GRS/GRSH/GRSO/R

- P-G-R-T TRUCK

- ★



FLEXIBLE HOSE	64438	1923617	1371717
----------------------	--------------	---------	---------

- 4 TRUCK

- ★ GRS890R GR/GRS900R - GRSH900R - GR/GRS/GRSO/R

- P-G-R-T TRUCK

- ★



OIL COOLER FLEXIBLE HOSE	65328	1923608	1521554 1360368
---------------------------------	--------------	---------	--------------------

- 3 BUS

- ★ GR801R

- 4 BUS

- ★ GR801R



ALL THE COMPONENTS LISTED IN OUR CATALOGUE ARE NOT ORIGINAL, THOUGH PERFECTLY INTERCHANGEABLE. REFERENCE NUMBERS, EITHER ORIGINAL OR OF A DIFFERENT NATURE, ARE FOR INFORMATION PURPOSES ONLY. WHEN PLACING AN ORDER, PLEASE, ALWAYS USE COSIBO REFERENCE NUMBERS AND DO NOT MENTION THE ORIGINAL REFERENCE NUMBERS OF THE TRUCK MANUFACTURERS IN THE INVOICE TO VEHICLE OWNERS OR TO ANYBODY ELSE. THE CUSTOMER TAKES HIS OWN RESPONSIBILITY IF HE DOES NOT COMPLY WITH WHAT ABOVE.

BRAKE SHOE 203mm



	Code	OEM new	OEM old
● Model	64248	1104544	1104548
★ Application			
● 3 BUS			
★			
● 4 BUS			
★			
● F-K-N BUS			
★			
● 3 TRUCK			
★			
● 4 TRUCK			
★			
● P-G-R-T TRUCK			
★			

BRAKE SHOE 254mm



	64247	1104545	1104549
● 3 BUS			
★			
● 4 BUS			
★			
● F-K-N BUS			
★			
● 3 TRUCK			
★			
● 4 TRUCK			
★			
● P-G-R-T TRUCK			
★			

ALL THE COMPONENTS LISTED IN OUR CATALOGUE ARE NOT ORIGINAL, THOUGH PERFECTLY INTERCHANGEABLE. REFERENCE NUMBERS, EITHER ORIGINAL OR OF A DIFFERENT NATURE, ARE FOR INFORMATION PURPOSES ONLY. WHEN PLACING AN ORDER, PLEASE, ALWAYS USE COSIBO REFERENCE NUMBERS AND DO NOT MENTION THE ORIGINAL REFERENCE NUMBERS OF THE TRUCK MANUFACTURERS IN THE INVOICE TO VEHICLE OWNERS OR TO ANYBODY ELSE. THE CUSTOMER TAKES HIS OWN RESPONSIBILITY IF HE DOES NOT COMPLY WITH WHAT ABOVE.

BRAKE LINING 413X178 (7") STD (FOR 1 WHEEL)



● Model
★ Application

Code	OEM new	OEM old
65502	1535248	551161

● 3 BUS

★

● 4 BUS

★

● F-K-N BUS

★

● 3 TRUCK

★

● 4 TRUCK

★

● P-G-R-T TRUCK

★

BRAKE LINING 413X203 (8") STD (FOR 1 WHEEL)



65505	1535249	551162
--------------	---------	--------

● 4 BUS

★

● F-K-N BUS

★

● 3 TRUCK

★

● 4 TRUCK

★

● P-G-R-T TRUCK

★

ALL THE COMPONENTS LISTED IN OUR CATALOGUE ARE NOT ORIGINAL, THOUGH PERFECTLY INTERCHANGEABLE. REFERENCE NUMBERS, EITHER ORIGINAL OR OF A DIFFERENT NATURE, ARE FOR INFORMATION PURPOSES ONLY. WHEN PLACING AN ORDER, PLEASE, ALWAYS USE COSIBO REFERENCE NUMBERS AND DO NOT MENTION THE ORIGINAL REFERENCE NUMBERS OF THE TRUCK MANUFACTURERS IN THE INVOICE TO VEHICLE OWNERS OR TO ANYBODY ELSE. THE CUSTOMER TAKES HIS OWN RESPONSIBILITY IF HE DOES NOT COMPLY WITH WHAT ABOVE.

BRAKE LINING 413X254 (10") STD (FOR 1 WHEEL)



● Model
★ Application

Code	OEM new	OEM old
65506	1535250	551163

● 3 BUS

★

● 4 BUS

★

● 3 TRUCK

★

● 4 TRUCK

★

● P-G-R-T TRUCK

★

BRAKE LINING SET STD,413X178 (7")(FOR 2 WHEEL)



65502	1535248	551161
--------------	---------	--------

● 3 BUS

★

● 3 TRUCK

★

● 4 BUS

★

● 4 TRUCK

★

● F-K-N BUS

★

● P-G-R-T TRUCK

★

ALL THE COMPONENTS LISTED IN OUR CATALOGUE ARE NOT ORIGINAL, THOUGH PERFECTLY INTERCHANGEABLE. REFERENCE NUMBERS, EITHER ORIGINAL OR OF A DIFFERENT NATURE, ARE FOR INFORMATION PURPOSES ONLY. WHEN PLACING AN ORDER, PLEASE, ALWAYS USE COSIBO REFERENCE NUMBERS AND DO NOT MENTION THE ORIGINAL REFERENCE NUMBERS OF THE TRUCK MANUFACTURERS IN THE INVOICE TO VEHICLE OWNERS OR TO ANYBODY ELSE. THE CUSTOMER TAKES HIS OWN RESPONSIBILITY IF HE DOES NOT COMPLY WITH WHAT ABOVE.

BRAKE LINING SET STD 413X203 (8") (FOR 2 WHEEL)

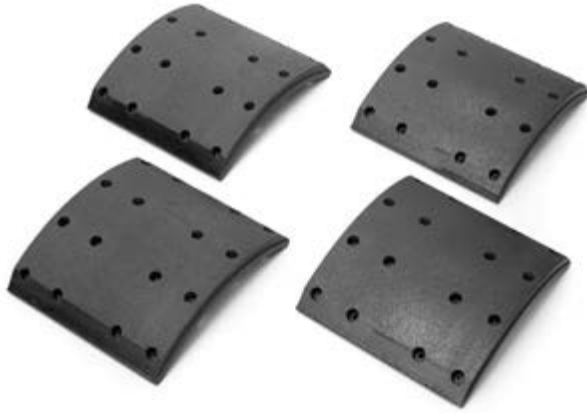

	Code	OEM new	OEM old
● Model ★ Application	65505	1535249	551162
● 3 TRUCK ★			
● 4 BUS ★			
● 4 TRUCK ★			
● F-K-N BUS ★			
● P-G-R-T TRUCK ★			

BRAKE LINING SET STD 413X254 (10") (FOR 2 WHEEL)



	Code	OEM new	OEM old
	65506	1535250	551163
● 3 BUS ★			
● 3 TRUCK ★			
● 4 BUS ★			
● 4 TRUCK ★			
● P-G-R-T TRUCK ★			

ALL THE COMPONENTS LISTED IN OUR CATALOGUE ARE NOT ORIGINAL, THOUGH PERFECTLY INTERCHANGEABLE. REFERENCE NUMBERS, EITHER ORIGINAL OR OF A DIFFERENT NATURE, ARE FOR INFORMATION PURPOSES ONLY. WHEN PLACING AN ORDER, PLEASE, ALWAYS USE COSIBO REFERENCE NUMBERS AND DO NOT MENTION THE ORIGINAL REFERENCE NUMBERS OF THE TRUCK MANUFACTURERS IN THE INVOICE TO VEHICLE OWNERS OR TO ANYBODY ELSE. THE CUSTOMER TAKES HIS OWN RESPONSIBILITY IF HE DOES NOT COMPLY WITH WHAT ABOVE.

		Code	OEM new	OEM old
PIN 	● Model	60536	154262	
	★ Application			
	● 3 BUS			
	★			
	● 3 TRUCK			
	★ AMD105			
	● 4 BUS			
	★			
	● 4 TRUCK			
	★ AM/AMA/AMD - AS/ASA/ARA - AD/ADA			
● F-K-N BUS				
★				
● P-G-R-T TRUCK				
★				

		61154	811768	804958
SPRING PIN 5X36 mm 	● 3 BUS			
	★ FOR OUR 60536			
	● 3 TRUCK			
	★ AMD105 FOR OUR 60536			
	● 4 BUS			
	★ FOR OUR 60536			
	● 4 TRUCK			
	★ AM/AMA/AMD - AS/ASA/ARA - AD/ADA FOR OUR 60536			
	● F-K-N BUS			
	★ FOR OUR 60536			
● P-G-R-T TRUCK				
★ FOR OUR 60536				

ALL THE COMPONENTS LISTED IN OUR CATALOGUE ARE NOT ORIGINAL, THOUGH PERFECTLY INTERCHANGEABLE. REFERENCE NUMBERS, EITHER ORIGINAL OR OF A DIFFERENT NATURE, ARE FOR INFORMATION PURPOSES ONLY. WHEN PLACING AN ORDER, PLEASE, ALWAYS USE COSIBO REFERENCE NUMBERS AND DO NOT MENTION THE ORIGINAL REFERENCE NUMBERS OF THE TRUCK MANUFACTURERS IN THE INVOICE TO VEHICLE OWNERS OR TO ANYBODY ELSE. THE CUSTOMER TAKES HIS OWN RESPONSIBILITY IF HE DOES NOT COMPLY WITH WHAT ABOVE.

	Code	OEM new	OEM old
BUSHING	60540	141163	
● Model			
★ Application			
● 3 BUS			
★			
● 3 TRUCK			
★ AMD105			
● 4 BUS			
★			
● 4 TRUCK			
★ AM/AMA/AMD - AS/ASA/ARA - AD/ADA			
● F-K-N BUS			
★			
● P-G-R-T TRUCK			
★			



	60955	154259	
ROLLER			
● 3 BUS			
★			
● 3 TRUCK			
★ AMD105			
● 4 BUS			
★			
● 4 TRUCK			
★ AM/AMA/AMD - AS/ASA/ARA - AD/ADA			
● F-K-N BUS			
★			
● P-G-R-T TRUCK			
★			



ALL THE COMPONENTS LISTED IN OUR CATALOGUE ARE NOT ORIGINAL, THOUGH PERFECTLY INTERCHANGEABLE. REFERENCE NUMBERS, EITHER ORIGINAL OR OF A DIFFERENT NATURE, ARE FOR INFORMATION PURPOSES ONLY. WHEN PLACING AN ORDER, PLEASE, ALWAYS USE COSIBO REFERENCE NUMBERS AND DO NOT MENTION THE ORIGINAL REFERENCE NUMBERS OF THE TRUCK MANUFACTURERS IN THE INVOICE TO VEHICLE OWNERS OR TO ANYBODY ELSE. THE CUSTOMER TAKES HIS OWN RESPONSIBILITY IF HE DOES NOT COMPLY WITH WHAT ABOVE.

		Code	OEM new	OEM old
BUSHING 	● Model	60535	154261	
	★ Application			
	● 3 BUS			
	★			
	● 3 TRUCK			
	★ AMD105			
	● 4 BUS			
	★			
	● 4 TRUCK			
	★ AM/AMA/AMD - AS/ASA/ARA - AD/ADA			
● F-K-N BUS				
★				
● P-G-R-T TRUCK				
★				

		65226	1338018	1307340
O-RING (RED SILICONE) 	● 3 BUS			
	★			
	● 3 TRUCK			
	★ AMD105			
	● 4 BUS			
	★			
	● 4 TRUCK			
	★ AM/AMA/AMD - AS/ASA/ARA - AD/ADA			
	● F-K-N BUS			
	★			
● P-G-R-T TRUCK				
★				

ALL THE COMPONENTS LISTED IN OUR CATALOGUE ARE NOT ORIGINAL, THOUGH PERFECTLY INTERCHANGEABLE. REFERENCE NUMBERS, EITHER ORIGINAL OR OF A DIFFERENT NATURE, ARE FOR INFORMATION PURPOSES ONLY. WHEN PLACING AN ORDER, PLEASE, ALWAYS USE COSIBO REFERENCE NUMBERS AND DO NOT MENTION THE ORIGINAL REFERENCE NUMBERS OF THE TRUCK MANUFACTURERS IN THE INVOICE TO VEHICLE OWNERS OR TO ANYBODY ELSE. THE CUSTOMER TAKES HIS OWN RESPONSIBILITY IF HE DOES NOT COMPLY WITH WHAT ABOVE.

	Code	OEM new	OEM old
SPRING	61519	1309465	1100816 1305055
● Model			
★ Application			
● 3 BUS			
★			
● 3 TRUCK			
★ AMD105			
● 4 BUS			
★			
● 4 TRUCK			
★ AM/AMA/AMD - AS/ASA/ARA - AD/ADA			
● F-K-N BUS			
★			
● P-G-R-T TRUCK			
★			



BUSHING	60539	141164	
● 3 BUS			
★			
● 3 TRUCK			
★ AMD105 - AS60/90 - ASA70 - ARA56/61			



SPRING	66520	120824	
● 3 BUS			
★			
● 3 TRUCK			
★ AMD105 - AS60/90 - ASA70 - ARA56/61			





O-RING	60538	182930	
● 3 TRUCK			
★ AMD105 - AD90 R770/780 - AD/ADA90 R642/660/770 - AD100 RP831			



ALL THE COMPONENTS LISTED IN OUR CATALOGUE ARE NOT ORIGINAL, THOUGH PERFECTLY INTERCHANGEABLE. REFERENCE NUMBERS, EITHER ORIGINAL OR OF A DIFFERENT NATURE, ARE FOR INFORMATION PURPOSES ONLY. WHEN PLACING AN ORDER, PLEASE, ALWAYS USE COSIBO REFERENCE NUMBERS AND DO NOT MENTION THE ORIGINAL REFERENCE NUMBERS OF THE TRUCK MANUFACTURERS IN THE INVOICE TO VEHICLE OWNERS OR TO ANYBODY ELSE. THE CUSTOMER TAKES HIS OWN RESPONSIBILITY IF HE DOES NOT COMPLY WITH WHAT ABOVE.

		Code	OEM new	OEM old
SNAP RING 	● Model	60543	804782	
	★ Application			
	● 3 BUS			
	★			
	● 3 TRUCK			
	★ AM56/61/70 - AD80/85/90/100			
	● 4 BUS			
	★ AM920 - AMA780/860 - K 124 8X2 AMA60X2 - AM860 - AD/ADA1300			
	● 4 TRUCK			
	★ AM/AMA740/760/780 - AMA860 - AD/ADA1100/1300/1500			
● F-K-N BUS				
★ AM920 - AD/ADA1300 - AMA780/860 - ASA701 - ARA860				
● P-G-R-T TRUCK				
★ ADA1100/1300 - AMD900 - AD1300 - AD/ADA1501P - ARA760/820/900 - ASA700/1000 - AS900				

		60546	123102	
SEAL RING 38x50x7 	● 3 BUS			
	★			
	● 3 TRUCK			
	★ AMD105 - AM56/70 - AM/AMA61 - AS60/90 - ASA70 - ARA56/61			

		60549	180064	
PIN 	● 3 BUS			
	★			
	● 3 TRUCK			
	★ AMD105 - AM56/70 - AM/AMA61 - AS60/90 - ASA70 - ARA56/61			

ALL THE COMPONENTS LISTED IN OUR CATALOGUE ARE NOT ORIGINAL, THOUGH PERFECTLY INTERCHANGEABLE. REFERENCE NUMBERS, EITHER ORIGINAL OR OF A DIFFERENT NATURE, ARE FOR INFORMATION PURPOSES ONLY. WHEN PLACING AN ORDER, PLEASE, ALWAYS USE COSIBO REFERENCE NUMBERS AND DO NOT MENTION THE ORIGINAL REFERENCE NUMBERS OF THE TRUCK MANUFACTURERS IN THE INVOICE TO VEHICLE OWNERS OR TO ANYBODY ELSE. THE CUSTOMER TAKES HIS OWN RESPONSIBILITY IF HE DOES NOT COMPLY WITH WHAT ABOVE.

REPAIR SET



● Model
★ Application

Code	OEM new	OEM old
63336	63336	

● 3 BUS

★

● 3 TRUCK

★ AMD105

● 4 BUS

★

● 4 TRUCK

★ AM/AMA/AMD - AS/ASA/ARA - AD/ADA

● F-K-N BUS

★

● P-G-R-T TRUCK

★



ALL THE COMPONENTS LISTED IN OUR CATALOGUE ARE NOT ORIGINAL, THOUGH PERFECTLY INTERCHANGEABLE. REFERENCE NUMBERS, EITHER ORIGINAL OR OF A DIFFERENT NATURE, ARE FOR INFORMATION PURPOSES ONLY. WHEN PLACING AN ORDER, PLEASE, ALWAYS USE COSIBO REFERENCE NUMBERS AND DO NOT MENTION THE ORIGINAL REFERENCE NUMBERS OF THE TRUCK MANUFACTURERS IN THE INVOICE TO VEHICLE OWNERS OR TO ANYBODY ELSE. THE CUSTOMER TAKES HIS OWN RESPONSIBILITY IF HE DOES NOT COMPLY WITH WHAT ABOVE.

	Code	OEM new	OEM old
CLAMP D.10	64083	813935	
	<ul style="list-style-type: none"> ● Model ★ Application 		
	<ul style="list-style-type: none"> ● 3 BUS ★ 		

CLAMP D. 16	64084	813937	
	<ul style="list-style-type: none"> ● 3 BUS ★ ● 4 BUS ★ ● F-K-N BUS ★ ● IND. MARINE ENGINE 4 ★ ● 3 TRUCK ★ ● 4 TRUCK ★ 		

CLAMP D.20	64085	813939	
	<ul style="list-style-type: none"> ● 3 BUS ★ ● 4 BUS ★ ● 3 TRUCK ★ ● 4 TRUCK ★ 		

ALL THE COMPONENTS LISTED IN OUR CATALOGUE ARE NOT ORIGINAL, THOUGH PERFECTLY INTERCHANGEABLE. REFERENCE NUMBERS, EITHER ORIGINAL OR OF A DIFFERENT NATURE, ARE FOR INFORMATION PURPOSES ONLY. WHEN PLACING AN ORDER, PLEASE, ALWAYS USE COSIBO REFERENCE NUMBERS AND DO NOT MENTION THE ORIGINAL REFERENCE NUMBERS OF THE TRUCK MANUFACTURERS IN THE INVOICE TO VEHICLE OWNERS OR TO ANYBODY ELSE. THE CUSTOMER TAKES HIS OWN RESPONSIBILITY IF HE DOES NOT COMPLY WITH WHAT ABOVE.

	Code	OEM new	OEM old
<p>CLAMP D.25</p> 	64086	813941	
<ul style="list-style-type: none"> ● Model ★ Application 			
<ul style="list-style-type: none"> ● 3 BUS ★ 			
<p>CLAMP D.5</p> 	64089	813932	
<ul style="list-style-type: none"> ● 3 BUS ★ 			
<p>CLAMP D.8</p> 	64090	813934	
<ul style="list-style-type: none"> ● 3 BUS ★ ● F-K-N BUS ★ ● 3 TRUCK ★ ● P-G-R-T TRUCK ★ 			

ALL THE COMPONENTS LISTED IN OUR CATALOGUE ARE NOT ORIGINAL, THOUGH PERFECTLY INTERCHANGEABLE. REFERENCE NUMBERS, EITHER ORIGINAL OR OF A DIFFERENT NATURE, ARE FOR INFORMATION PURPOSES ONLY. WHEN PLACING AN ORDER, PLEASE, ALWAYS USE COSIBO REFERENCE NUMBERS AND DO NOT MENTION THE ORIGINAL REFERENCE NUMBERS OF THE TRUCK MANUFACTURERS IN THE INVOICE TO VEHICLE OWNERS OR TO ANYBODY ELSE. THE CUSTOMER TAKES HIS OWN RESPONSIBILITY IF HE DOES NOT COMPLY WITH WHAT ABOVE.

	Code	OEM new	OEM old
CLAMP D.13	64091	813936	
● Model			
★ Application			
● 3 BUS			
★			
● 4 BUS			
★			
● F-K-N BUS			
★			
● IND. MARINE ENGINE 4			
★			
● 3 TRUCK			
★			





	Code	OEM new	OEM old
CLAMP D.18	64092	813938	
● 3 BUS			
★			
● 4 BUS			
★			
● 3 TRUCK			
★			
● 4 TRUCK			
★			



	Code	OEM new	OEM old
CLAMP D.22	64093	813940	
● 3 BUS			
★			
● 4 BUS			
★			
● 3 TRUCK			
★			
● 4 TRUCK			
★			



ALL THE COMPONENTS LISTED IN OUR CATALOGUE ARE NOT ORIGINAL, THOUGH PERFECTLY INTERCHANGEABLE. REFERENCE NUMBERS, EITHER ORIGINAL OR OF A DIFFERENT NATURE, ARE FOR INFORMATION PURPOSES ONLY. WHEN PLACING AN ORDER, PLEASE, ALWAYS USE COSIBO REFERENCE NUMBERS AND DO NOT MENTION THE ORIGINAL REFERENCE NUMBERS OF THE TRUCK MANUFACTURERS IN THE INVOICE TO VEHICLE OWNERS OR TO ANYBODY ELSE. THE CUSTOMER TAKES HIS OWN RESPONSIBILITY IF HE DOES NOT COMPLY WITH WHAT ABOVE.

	Code	OEM new	OEM old
<p>CLAMP D.35</p> 	64096	804589	
<ul style="list-style-type: none"> ● Model ★ Application 			
<ul style="list-style-type: none"> ● 3 BUS ★ 			
<ul style="list-style-type: none"> ● 3 TRUCK ★ 			
<p>CLAMP D.32</p> 	64100	804583	
<ul style="list-style-type: none"> ● 3 TRUCK ★ 			
<p>CLAMP D.38</p> 	64101	804591	
<ul style="list-style-type: none"> ● F-K-N BUS ★ 			
<ul style="list-style-type: none"> ● 3 TRUCK ★ 			

ALL THE COMPONENTS LISTED IN OUR CATALOGUE ARE NOT ORIGINAL, THOUGH PERFECTLY INTERCHANGEABLE. REFERENCE NUMBERS, EITHER ORIGINAL OR OF A DIFFERENT NATURE, ARE FOR INFORMATION PURPOSES ONLY. WHEN PLACING AN ORDER, PLEASE, ALWAYS USE COSIBO REFERENCE NUMBERS AND DO NOT MENTION THE ORIGINAL REFERENCE NUMBERS OF THE TRUCK MANUFACTURERS IN THE INVOICE TO VEHICLE OWNERS OR TO ANYBODY ELSE. THE CUSTOMER TAKES HIS OWN RESPONSIBILITY IF HE DOES NOT COMPLY WITH WHAT ABOVE.

CLAMP D.6



● Model
★ Application

Code

OEM new

OEM old

64082

813933

● 3 BUS

★

● 4 BUS

★

● 4 TRUCK

★

ALL THE COMPONENTS LISTED IN OUR CATALOGUE ARE NOT ORIGINAL, THOUGH PERFECTLY INTERCHANGEABLE. REFERENCE NUMBERS, EITHER ORIGINAL OR OF A DIFFERENT NATURE, ARE FOR INFORMATION PURPOSES ONLY. WHEN PLACING AN ORDER, PLEASE, ALWAYS USE COSIBO REFERENCE NUMBERS AND DO NOT MENTION THE ORIGINAL REFERENCE NUMBERS OF THE TRUCK MANUFACTURERS IN THE INVOICE TO VEHICLE OWNERS OR TO ANYBODY ELSE. THE CUSTOMER TAKES HIS OWN RESPONSIBILITY IF HE DOES NOT COMPLY WITH WHAT ABOVE.

WIDE ANGLE MIRROR WITH BRACKET



● Model
★ Application

Code	OEM new	OEM old
62136	316920	

● 3 TRUCK

★

● 4 TRUCK

★

MIRROR GLASS



62133	316918	
-------	--------	--

● 3 TRUCK

★

● 4 TRUCK

★

UNHEATED COMPLETE MIRROR



61657	1106953	396851
-------	---------	--------

● 3 TRUCK

★

● 4 TRUCK

★

ALL THE COMPONENTS LISTED IN OUR CATALOGUE ARE NOT ORIGINAL, THOUGH PERFECTLY INTERCHANGEABLE. REFERENCE NUMBERS, EITHER ORIGINAL OR OF A DIFFERENT NATURE, ARE FOR INFORMATION PURPOSES ONLY. WHEN PLACING AN ORDER, PLEASE, ALWAYS USE COSIBO REFERENCE NUMBERS AND DO NOT MENTION THE ORIGINAL REFERENCE NUMBERS OF THE TRUCK MANUFACTURERS IN THE INVOICE TO VEHICLE OWNERS OR TO ANYBODY ELSE. THE CUSTOMER TAKES HIS OWN RESPONSIBILITY IF HE DOES NOT COMPLY WITH WHAT ABOVE.

HEATED MIRROR COMPLETE



- Model
- ★ Application

Code

OEM new

OEM old

61658

1106955

396853

- 3 TRUCK



UNHEATED MIRROR GLASS



- 3 TRUCK



61659

296538

HEATED MIRROR GLASS



- 3 TRUCK



61660

296538/A

ALL THE COMPONENTS LISTED IN OUR CATALOGUE ARE NOT ORIGINAL, THOUGH PERFECTLY INTERCHANGEABLE. REFERENCE NUMBERS, EITHER ORIGINAL OR OF A DIFFERENT NATURE, ARE FOR INFORMATION PURPOSES ONLY. WHEN PLACING AN ORDER, PLEASE, ALWAYS USE COSIBO REFERENCE NUMBERS AND DO NOT MENTION THE ORIGINAL REFERENCE NUMBERS OF THE TRUCK MANUFACTURERS IN THE INVOICE TO VEHICLE OWNERS OR TO ANYBODY ELSE. THE CUSTOMER TAKES HIS OWN RESPONSIBILITY IF HE DOES NOT COMPLY WITH WHAT ABOVE.

MIRROR HEATING ELEMENT

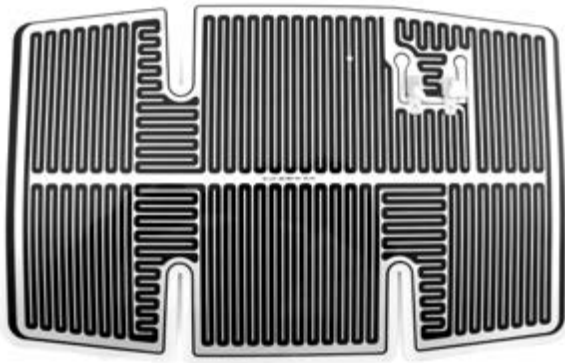

- Model
- ★ Application

62067

376243

OEM old

- 3 TRUCK

- ★

MIRROR GLASS



63712

1442706

1346377

- 4 TRUCK

- ★

- P-G-R-T TRUCK

- ★

MIRROR BRACKET



- Model
- ★ Application

61706

316640

OEM old

- 3 TRUCK

- ★

HEATED MIRROR GLASS



63369

1732776

1442705

- P-G-R-T TRUCK

- ★

- 4 TRUCK

- ★ CP/CR 94 - 114 - 124 - 144 - 164

ALL THE COMPONENTS LISTED IN OUR CATALOGUE ARE NOT ORIGINAL, THOUGH PERFECTLY INTERCHANGEABLE. REFERENCE NUMBERS, EITHER ORIGINAL OR OF A DIFFERENT NATURE, ARE FOR INFORMATION PURPOSES ONLY. WHEN PLACING AN ORDER, PLEASE, ALWAYS USE COSIBO REFERENCE NUMBERS AND DO NOT MENTION THE ORIGINAL REFERENCE NUMBERS OF THE TRUCK MANUFACTURERS IN THE INVOICE TO VEHICLE OWNERS OR TO ANYBODY ELSE. THE CUSTOMER TAKES HIS OWN RESPONSIBILITY IF HE DOES NOT COMPLY WITH WHAT ABOVE.

HEATED WIDE ANGLE MIRROR GLASS



	Code	OEM new	OEM old
● Model	63370	1732778	1346579
★ Application			
● P-G-R-T TRUCK			
★			
● 4 TRUCK			
★ CP/CR 94 - 114 - 124 - 144 - 164			

LH MIRROR BRACKET



	Code	OEM new	OEM old
	62399	1396529	
● P-G-R-T TRUCK			
★			
● 4 TRUCK			
★ CP/CR 94 - 114 - 124 - 144 - 164			

RH MIRROR BRACKET



	Code	OEM new	OEM old
	62400	1396530	
● P-G-R-T TRUCK			
★			
● 4 TRUCK			
★ CP/CR 94 - 114 - 124 - 144 - 164			

ALL THE COMPONENTS LISTED IN OUR CATALOGUE ARE NOT ORIGINAL, THOUGH PERFECTLY INTERCHANGEABLE. REFERENCE NUMBERS, EITHER ORIGINAL OR OF A DIFFERENT NATURE, ARE FOR INFORMATION PURPOSES ONLY. WHEN PLACING AN ORDER, PLEASE, ALWAYS USE COSIBO REFERENCE NUMBERS AND DO NOT MENTION THE ORIGINAL REFERENCE NUMBERS OF THE TRUCK MANUFACTURERS IN THE INVOICE TO VEHICLE OWNERS OR TO ANYBODY ELSE. THE CUSTOMER TAKES HIS OWN RESPONSIBILITY IF HE DOES NOT COMPLY WITH WHAT ABOVE.

LH ELECTRICAL HEATED TWIN MIRROR



"This item may not be available on every market"

- Model
- ★ Application

Code	OEM new	OEM old
64245	1723518 1732782	

- 4 TRUCK
- ★ CP/CR/CT FOR CH 2600 mm

RH ELECTRICAL HEATED TWIN MIRROR



"This item may not be available on every market"

64169	1723519	
-------	---------	--

- 4 TRUCK
- ★ CP/CR/CT FOR CH 2600 mm

ALL THE COMPONENTS LISTED IN OUR CATALOGUE ARE NOT ORIGINAL, THOUGH PERFECTLY INTERCHANGEABLE. REFERENCE NUMBERS, EITHER ORIGINAL OR OF A DIFFERENT NATURE, ARE FOR INFORMATION PURPOSES ONLY. WHEN PLACING AN ORDER, PLEASE, ALWAYS USE COSIBO REFERENCE NUMBERS AND DO NOT MENTION THE ORIGINAL REFERENCE NUMBERS OF THE TRUCK MANUFACTURERS IN THE INVOICE TO VEHICLE OWNERS OR TO ANYBODY ELSE. THE CUSTOMER TAKES HIS OWN RESPONSIBILITY IF HE DOES NOT COMPLY WITH WHAT ABOVE.

LH ELECTRICAL HEATED TWIN MIRROR



"This item may not be available on every market"

- Model
- ★ Application

Code	OEM new	OEM old
64245	1723518 1732782	

- 4 TRUCK
- ★ CP/CR/CT FOR CH 2600 mm

LH ELECTRICAL HEATED SINGLE MIRROR (LONG ARMS)



"This item may not be available on every market"

64170	1723518	
-------	---------	--

- 4 TRUCK
- ★ CP/CR/CT FOR CH 2600 mm

ALL THE COMPONENTS LISTED IN OUR CATALOGUE ARE NOT ORIGINAL, THOUGH PERFECTLY INTERCHANGEABLE. REFERENCE NUMBERS, EITHER ORIGINAL OR OF A DIFFERENT NATURE, ARE FOR INFORMATION PURPOSES ONLY. WHEN PLACING AN ORDER, PLEASE, ALWAYS USE COSIBO REFERENCE NUMBERS AND DO NOT MENTION THE ORIGINAL REFERENCE NUMBERS OF THE TRUCK MANUFACTURERS IN THE INVOICE TO VEHICLE OWNERS OR TO ANYBODY ELSE. THE CUSTOMER TAKES HIS OWN RESPONSIBILITY IF HE DOES NOT COMPLY WITH WHAT ABOVE.

LH ELECTRICAL HEATED TWIN MIRROR (SHORT ARMS)



* LHD - Up to 2007 models
LHD & RHD from 2007 models

"This item may not be available on every market"

● Model
★ Application

Code
65324

OEM new
65324

OEM old

● 4 TRUCK

★ CP/CR 94 - 114 - 124 - 144 - 164 FOR CH 2500/2550 mm

● P-G-R-T TRUCK

★ FOR CH 2500/2550 mm

RH ELECTRICAL HEATED TWIN MIRROR (SHORT ARMS)



* LHD - Up to 2007 models
LHD & RHD from 2007 models

"This item may not be available on every market"

● 4 TRUCK

★ CP/CR 94 - 114 - 124 - 144 - 164 FOR CH 2500/2550 mm

● P-G-R-T TRUCK

★ FOR CH 2500/2550 mm

65321

65321

ALL THE COMPONENTS LISTED IN OUR CATALOGUE ARE NOT ORIGINAL, THOUGH PERFECTLY INTERCHANGEABLE. REFERENCE NUMBERS, EITHER ORIGINAL OR OF A DIFFERENT NATURE, ARE FOR INFORMATION PURPOSES ONLY. WHEN PLACING AN ORDER, PLEASE, ALWAYS USE COSIBO REFERENCE NUMBERS AND DO NOT MENTION THE ORIGINAL REFERENCE NUMBERS OF THE TRUCK MANUFACTURERS IN THE INVOICE TO VEHICLE OWNERS OR TO ANYBODY ELSE. THE CUSTOMER TAKES HIS OWN RESPONSIBILITY IF HE DOES NOT COMPLY WITH WHAT ABOVE.

LH ELECTRICAL HEATED SINGLE MIRROR



"This item may not be available on every market"

- Model
- ★ Application

Code

OEM new

OEM old

65322

65322

- 4 TRUCK

- ★ CP/CR 94 - 114 - 124 - 144 - 164 FOR CH 2500/2550 mm

- P-G-R-T TRUCK

- ★ FOR CH 2500/2550 mm

RHD, RH ELECTRICAL HEATED SINGLE MIRROR



"This item may not be available on every market"

- 4 TRUCK

- ★ CP/CR 94 - 114 - 124 - 144 - 164 FOR CH 2500/2550 mm

- P-G-R-T TRUCK

- ★ FOR CH 2500/2550 mm

65323

65323

ALL THE COMPONENTS LISTED IN OUR CATALOGUE ARE NOT ORIGINAL, THOUGH PERFECTLY INTERCHANGEABLE. REFERENCE NUMBERS, EITHER ORIGINAL OR OF A DIFFERENT NATURE, ARE FOR INFORMATION PURPOSES ONLY. WHEN PLACING AN ORDER, PLEASE, ALWAYS USE COSIBO REFERENCE NUMBERS AND DO NOT MENTION THE ORIGINAL REFERENCE NUMBERS OF THE TRUCK MANUFACTURERS IN THE INVOICE TO VEHICLE OWNERS OR TO ANYBODY ELSE. THE CUSTOMER TAKES HIS OWN RESPONSIBILITY IF HE DOES NOT COMPLY WITH WHAT ABOVE.

LH WIDE ANGLE MIRROR ASSY



"This item may not be available on every market"

	Code	OEM new	OEM old
● Model	63797	1732782	1346381
★ Application			
● 4 TRUCK			
★ CP/CR 94 - 114 - 124 - 144 - 164			
● P-G-R-T TRUCK			
★			

RH WIDE ANGLE MIRROR ASSY



"This item may not be available on every market"

	Code	OEM new	OEM old
	63860	1732783	1346382
● 4 TRUCK			
★ CP/CR 94 - 114 - 124 - 144 - 164			
● P-G-R-T TRUCK			
★			

ALL THE COMPONENTS LISTED IN OUR CATALOGUE ARE NOT ORIGINAL, THOUGH PERFECTLY INTERCHANGEABLE. REFERENCE NUMBERS, EITHER ORIGINAL OR OF A DIFFERENT NATURE, ARE FOR INFORMATION PURPOSES ONLY. WHEN PLACING AN ORDER, PLEASE, ALWAYS USE COSIBO REFERENCE NUMBERS AND DO NOT MENTION THE ORIGINAL REFERENCE NUMBERS OF THE TRUCK MANUFACTURERS IN THE INVOICE TO VEHICLE OWNERS OR TO ANYBODY ELSE. THE CUSTOMER TAKES HIS OWN RESPONSIBILITY IF HE DOES NOT COMPLY WITH WHAT ABOVE.

LH MIRROR CAP



	Code	OEM new	OEM old
● Model ★ Application	63800	1366141	
● 4 TRUCK			
★ CP/CR 94 - 114 - 124 - 144 - 164			
● P-G-R-T TRUCK			
★			

RH MIRROR CAP



	62379	1396542	
● 4 TRUCK			
★ CP/CR 94 - 114 - 124 - 144 - 164			
● P-G-R-T TRUCK			
★			

ALL THE COMPONENTS LISTED IN OUR CATALOGUE ARE NOT ORIGINAL, THOUGH PERFECTLY INTERCHANGEABLE. REFERENCE NUMBERS, EITHER ORIGINAL OR OF A DIFFERENT NATURE, ARE FOR INFORMATION PURPOSES ONLY. WHEN PLACING AN ORDER, PLEASE, ALWAYS USE COSIBO REFERENCE NUMBERS AND DO NOT MENTION THE ORIGINAL REFERENCE NUMBERS OF THE TRUCK MANUFACTURERS IN THE INVOICE TO VEHICLE OWNERS OR TO ANYBODY ELSE. THE CUSTOMER TAKES HIS OWN RESPONSIBILITY IF HE DOES NOT COMPLY WITH WHAT ABOVE.

LH MIRROR CAP ORIGINAL (RHD)



	Code	OEM new	OEM old
● Model ★ Application	63801	1396541	
● 4 TRUCK			
★ CP/CR 94 - 114 - 124 - 144 - 164			
● P-G-R-T TRUCK			
★			

MIRROR REPAIR SET



	63739	581201	
● 4 TRUCK			
★			

LH BRACKET



	64427	1439463	
● 4 TRUCK			
★ CP/CR/CT FOR CH 2500/2550 mm			
● P-G-R-T TRUCK			
★ CP/CR/CT FOR CH 2500/2550 mm			

ALL THE COMPONENTS LISTED IN OUR CATALOGUE ARE NOT ORIGINAL, THOUGH PERFECTLY INTERCHANGEABLE. REFERENCE NUMBERS, EITHER ORIGINAL OR OF A DIFFERENT NATURE, ARE FOR INFORMATION PURPOSES ONLY. WHEN PLACING AN ORDER, PLEASE, ALWAYS USE COSIBO REFERENCE NUMBERS AND DO NOT MENTION THE ORIGINAL REFERENCE NUMBERS OF THE TRUCK MANUFACTURERS IN THE INVOICE TO VEHICLE OWNERS OR TO ANYBODY ELSE. THE CUSTOMER TAKES HIS OWN RESPONSIBILITY IF HE DOES NOT COMPLY WITH WHAT ABOVE.

	Code	OEM new	OEM old
RH BRACKET	64426	1439462	
<ul style="list-style-type: none"> ● Model ★ Application 			
<ul style="list-style-type: none"> ● 4 TRUCK 			
<ul style="list-style-type: none"> ★ CP/CR/CT FOR CH 2500/2550 mm 			
<ul style="list-style-type: none"> ● P-G-R-T TRUCK 			
<ul style="list-style-type: none"> ★ CP/CR/CT FOR CH 2500/2550 mm 			



MIRROR JOINT	65417		
<ul style="list-style-type: none"> ● 4 TRUCK 			
<ul style="list-style-type: none"> ★ CP/CR/CT FOR CH 2500/2550 mm 			
<ul style="list-style-type: none"> ● P-G-R-T TRUCK 			
<ul style="list-style-type: none"> ★ CP/CR/CT FOR CH 2500/2550 mm 			



MIRROR BRACKET COVER	65418	1346380	
<ul style="list-style-type: none"> ● 4 TRUCK 			
<ul style="list-style-type: none"> ★ CP/CR/CT FOR CH 2500/2550 mm 			
<ul style="list-style-type: none"> ● P-G-R-T TRUCK 			
<ul style="list-style-type: none"> ★ CP/CR/CT FOR CH 2500/2550 mm 			



MIRROR ASSY	64173	1916864	1484076
<ul style="list-style-type: none"> ● 4 TRUCK 			
<ul style="list-style-type: none"> ★ 8X8 WLS/ZLS 			
<ul style="list-style-type: none"> ● P-G-R-T TRUCK 			
<ul style="list-style-type: none"> ★ 8X8 WLS/ZLS 			



ALL THE COMPONENTS LISTED IN OUR CATALOGUE ARE NOT ORIGINAL, THOUGH PERFECTLY INTERCHANGEABLE. REFERENCE NUMBERS, EITHER ORIGINAL OR OF A DIFFERENT NATURE, ARE FOR INFORMATION PURPOSES ONLY. WHEN PLACING AN ORDER, PLEASE, ALWAYS USE COSIBO REFERENCE NUMBERS AND DO NOT MENTION THE ORIGINAL REFERENCE NUMBERS OF THE TRUCK MANUFACTURERS IN THE INVOICE TO VEHICLE OWNERS OR TO ANYBODY ELSE. THE CUSTOMER TAKES HIS OWN RESPONSIBILITY IF HE DOES NOT COMPLY WITH WHAT ABOVE.

MIRROR BRACKET



- Model
- ★ Application

Code	OEM new	OEM old
64174	1484081	

- P-G-R-T TRUCK
- ★

ROOF MIRROR WITH BRACKET

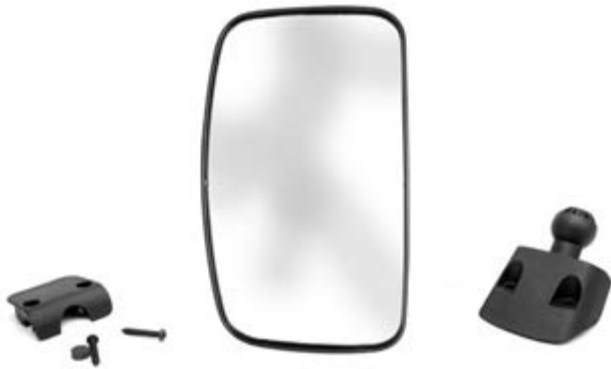

- P-G-R-T TRUCK
- ★ COMPOSED BY N. 1 PC 64173 + N. 1 PC 64174

65378	65378	
-------	-------	--

MIRROR ASSY WITH BRACKET (FRONT VIEW)



- 4 TRUCK
- ★ LOW/STD/HIGH CABIN
- P-G-R-T TRUCK
- ★ LOW/STD/HIGH CABIN

64171	1916864 1484078	1484076+ 1484078
-------	--------------------	---------------------

ALL THE COMPONENTS LISTED IN OUR CATALOGUE ARE NOT ORIGINAL, THOUGH PERFECTLY INTERCHANGEABLE. REFERENCE NUMBERS, EITHER ORIGINAL OR OF A DIFFERENT NATURE, ARE FOR INFORMATION PURPOSES ONLY. WHEN PLACING AN ORDER, PLEASE, ALWAYS USE COSIBO REFERENCE NUMBERS AND DO NOT MENTION THE ORIGINAL REFERENCE NUMBERS OF THE TRUCK MANUFACTURERS IN THE INVOICE TO VEHICLE OWNERS OR TO ANYBODY ELSE. THE CUSTOMER TAKES HIS OWN RESPONSIBILITY IF HE DOES NOT COMPLY WITH WHAT ABOVE.

MIRROR ASSY WITH BRACKET (FRONT VIEW)



- Model
- ★ Application

Code

OEM new

OEM old

641721916864
14840791484076+
1484079

- **4 TRUCK**
- ★ CABIN TOPLINE
- **P-G-R-T TRUCK**
- ★ CABIN TOPLINE

ALL THE COMPONENTS LISTED IN OUR CATALOGUE ARE NOT ORIGINAL, THOUGH PERFECTLY INTERCHANGEABLE. REFERENCE NUMBERS, EITHER ORIGINAL OR OF A DIFFERENT NATURE, ARE FOR INFORMATION PURPOSES ONLY. WHEN PLACING AN ORDER, PLEASE, ALWAYS USE COSIBO REFERENCE NUMBERS AND DO NOT MENTION THE ORIGINAL REFERENCE NUMBERS OF THE TRUCK MANUFACTURERS IN THE INVOICE TO VEHICLE OWNERS OR TO ANYBODY ELSE. THE CUSTOMER TAKES HIS OWN RESPONSIBILITY IF HE DOES NOT COMPLY WITH WHAT ABOVE.

LH UPPER STEP COVER



- Model
- ★ Application

Code

OEM new

OEM old

62327

1390075

- 4 TRUCK

- ★ CP/CR

RH UPPER STEP COVER



- 4 TRUCK

- ★ CP/CR

62339

1390074

LH MIDDLE STEP COVER



- 4 TRUCK

- ★ CP/CR

62328

1354593

"This item may not be available on every market"

ALL THE COMPONENTS LISTED IN OUR CATALOGUE ARE NOT ORIGINAL, THOUGH PERFECTLY INTERCHANGEABLE. REFERENCE NUMBERS, EITHER ORIGINAL OR OF A DIFFERENT NATURE, ARE FOR INFORMATION PURPOSES ONLY. WHEN PLACING AN ORDER, PLEASE, ALWAYS USE COSIBO REFERENCE NUMBERS AND DO NOT MENTION THE ORIGINAL REFERENCE NUMBERS OF THE TRUCK MANUFACTURERS IN THE INVOICE TO VEHICLE OWNERS OR TO ANYBODY ELSE. THE CUSTOMER TAKES HIS OWN RESPONSIBILITY IF HE DOES NOT COMPLY WITH WHAT ABOVE.

	Code	OEM new	OEM old
RH MIDDLE STEP COVER  "This item may not be available on every market"	62338	1354594	
<ul style="list-style-type: none"> ● Model ★ Application 			
<ul style="list-style-type: none"> ● 4 TRUCK ★ CP/CR 			
LH STEP COVER  "This item may not be available on every market"	64700	1512423	
<ul style="list-style-type: none"> ● P-G-R-T TRUCK ★ CP/CG/CR/CT 			
RH STEP COVER  "This item may not be available on every market"	64701	1512424	
<ul style="list-style-type: none"> ● P-G-R-T TRUCK ★ CP/CG/CR 230V - CT 			
LH UPPER SPEP COVER  "This item may not be available on every market"	64702	1442653	
<ul style="list-style-type: none"> ● P-G-R-T TRUCK ★ CR/CT 			

ALL THE COMPONENTS LISTED IN OUR CATALOGUE ARE NOT ORIGINAL, THOUGH PERFECTLY INTERCHANGEABLE. REFERENCE NUMBERS, EITHER ORIGINAL OR OF A DIFFERENT NATURE, ARE FOR INFORMATION PURPOSES ONLY. WHEN PLACING AN ORDER, PLEASE, ALWAYS USE COSIBO REFERENCE NUMBERS AND DO NOT MENTION THE ORIGINAL REFERENCE NUMBERS OF THE TRUCK MANUFACTURERS IN THE INVOICE TO VEHICLE OWNERS OR TO ANYBODY ELSE. THE CUSTOMER TAKES HIS OWN RESPONSIBILITY IF HE DOES NOT COMPLY WITH WHAT ABOVE.

RH UPPER SPEP COVER



"This item may not be available on every market"

- Model
- ★ Application

Code
64703

OEM new
1442654

OEM old

- **P-G-R-T TRUCK**
- ★ CR/CT

LH LOWER STEP COVER



"This item may not be available on every market"

- **P-G-R-T TRUCK**
- ★ CP/CG/CR/CT

Code
64708

OEM new
1779120

OEM old
1486647

RH LOWER STEP COVER



"This item may not be available on every market"

- **P-G-R-T TRUCK**
- ★ CP/CG/CR/CT

Code
64709

OEM new
1779121

OEM old
1486648

ALL THE COMPONENTS LISTED IN OUR CATALOGUE ARE NOT ORIGINAL, THOUGH PERFECTLY INTERCHANGEABLE. REFERENCE NUMBERS, EITHER ORIGINAL OR OF A DIFFERENT NATURE, ARE FOR INFORMATION PURPOSES ONLY. WHEN PLACING AN ORDER, PLEASE, ALWAYS USE COSIBO REFERENCE NUMBERS AND DO NOT MENTION THE ORIGINAL REFERENCE NUMBERS OF THE TRUCK MANUFACTURERS IN THE INVOICE TO VEHICLE OWNERS OR TO ANYBODY ELSE. THE CUSTOMER TAKES HIS OWN RESPONSIBILITY IF HE DOES NOT COMPLY WITH WHAT ABOVE.

SIDE MARKER LAMP ASSY



	Code	OEM new	OEM old
● Model	62524	1770301	1722531
★ Application			
● P-G-R-T TRUCK			
★ CT LH/RH - CP/CG/CR LH/RH			

LH LOWER STEP COVER



"This item may not be available on every market"

	Code	OEM new	OEM old
	65540	1779118	1501342
● P-G-R-T TRUCK			
★ CG/CP/CR LH - CT LH/RH			

RH LOWER STEP COVER



"This item may not be available on every market"

	Code	OEM new	OEM old
	65541	1779119	1501343
● P-G-R-T TRUCK			
★ CG/CP/CR RH - CT LH/RH			

LH STEP



	Code	OEM new	OEM old
	62335	361993	
● 3 TRUCK			
★			

ALL THE COMPONENTS LISTED IN OUR CATALOGUE ARE NOT ORIGINAL, THOUGH PERFECTLY INTERCHANGEABLE. REFERENCE NUMBERS, EITHER ORIGINAL OR OF A DIFFERENT NATURE, ARE FOR INFORMATION PURPOSES ONLY. WHEN PLACING AN ORDER, PLEASE, ALWAYS USE COSIBO REFERENCE NUMBERS AND DO NOT MENTION THE ORIGINAL REFERENCE NUMBERS OF THE TRUCK MANUFACTURERS IN THE INVOICE TO VEHICLE OWNERS OR TO ANYBODY ELSE. THE CUSTOMER TAKES HIS OWN RESPONSIBILITY IF HE DOES NOT COMPLY WITH WHAT ABOVE.

RH STEP



- Model
- ★ Application

Code

OEM new

OEM old

62340

361994

- 3 TRUCK

- ★

LH FOOTSTEP PANEL



- 4 TRUCK

- ★ CP/CR/CT

62414

1515195

1351193

ALL THE COMPONENTS LISTED IN OUR CATALOGUE ARE NOT ORIGINAL, THOUGH PERFECTLY INTERCHANGEABLE. REFERENCE NUMBERS, EITHER ORIGINAL OR OF A DIFFERENT NATURE, ARE FOR INFORMATION PURPOSES ONLY. WHEN PLACING AN ORDER, PLEASE, ALWAYS USE COSIBO REFERENCE NUMBERS AND DO NOT MENTION THE ORIGINAL REFERENCE NUMBERS OF THE TRUCK MANUFACTURERS IN THE INVOICE TO VEHICLE OWNERS OR TO ANYBODY ELSE. THE CUSTOMER TAKES HIS OWN RESPONSIBILITY IF HE DOES NOT COMPLY WITH WHAT ABOVE.

RH FOOTSTEP PANEL



	Code	OEM new	OEM old
● Model	62415	1515194	1351194
★ Application			
● 4 TRUCK			
★ CP/CR/CT			

LH STEP PANEL



	Code	OEM new	OEM old
	65438	1854227	1498179
● P-G-R-T TRUCK			
★ CG/CP/CR/CT			

ALL THE COMPONENTS LISTED IN OUR CATALOGUE ARE NOT ORIGINAL, THOUGH PERFECTLY INTERCHANGEABLE. REFERENCE NUMBERS, EITHER ORIGINAL OR OF A DIFFERENT NATURE, ARE FOR INFORMATION PURPOSES ONLY. WHEN PLACING AN ORDER, PLEASE, ALWAYS USE COSIBO REFERENCE NUMBERS AND DO NOT MENTION THE ORIGINAL REFERENCE NUMBERS OF THE TRUCK MANUFACTURERS IN THE INVOICE TO VEHICLE OWNERS OR TO ANYBODY ELSE. THE CUSTOMER TAKES HIS OWN RESPONSIBILITY IF HE DOES NOT COMPLY WITH WHAT ABOVE.

RH STEP PANEL



- Model
- ★ Application

Code

OEM new

OEM old

65439

1854228

1498180

- P-G-R-T TRUCK

- ★ CG/CP/CR/CT

LH UPPER STEP COVER



- P-G-R-T TRUCK

- ★ CR

64344

1732322

1529885

RH UPPER STEP COVER



- P-G-R-T TRUCK

- ★ CR

64345

1529886

ALL THE COMPONENTS LISTED IN OUR CATALOGUE ARE NOT ORIGINAL, THOUGH PERFECTLY INTERCHANGEABLE. REFERENCE NUMBERS, EITHER ORIGINAL OR OF A DIFFERENT NATURE, ARE FOR INFORMATION PURPOSES ONLY. WHEN PLACING AN ORDER, PLEASE, ALWAYS USE COSIBO REFERENCE NUMBERS AND DO NOT MENTION THE ORIGINAL REFERENCE NUMBERS OF THE TRUCK MANUFACTURERS IN THE INVOICE TO VEHICLE OWNERS OR TO ANYBODY ELSE. THE CUSTOMER TAKES HIS OWN RESPONSIBILITY IF HE DOES NOT COMPLY WITH WHAT ABOVE.

LOWER LH & RH STEP



"This item may not be available on every market"

- Model
- ★ Application

Code

OEM new

OEM old

68888

1535049

1390076

- 4 TRUCK

- ★ CP/CR

FOOT STEP LIGHT



61604

369375

- 3 TRUCK

- ★

MARKING LAMP



62300

1471599

- 3 TRUCK

- ★

- 4 TRUCK

- ★

- F-K-N BUS

- ★ CK/CN - CNUD

- 4 BUS

- ★ CL/CN94

ALL THE COMPONENTS LISTED IN OUR CATALOGUE ARE NOT ORIGINAL, THOUGH PERFECTLY INTERCHANGEABLE. REFERENCE NUMBERS, EITHER ORIGINAL OR OF A DIFFERENT NATURE, ARE FOR INFORMATION PURPOSES ONLY. WHEN PLACING AN ORDER, PLEASE, ALWAYS USE COSIBO REFERENCE NUMBERS AND DO NOT MENTION THE ORIGINAL REFERENCE NUMBERS OF THE TRUCK MANUFACTURERS IN THE INVOICE TO VEHICLE OWNERS OR TO ANYBODY ELSE. THE CUSTOMER TAKES HIS OWN RESPONSIBILITY IF HE DOES NOT COMPLY WITH WHAT ABOVE.

	Code	OEM new	OEM old
MARKING LAMP	62463	2080828	1737413 2000390
● Model			
★ Application			
● P-G-R-T TRUCK			
★			



REFLEX REFLECTOR	65542	1362707	
● 4 TRUCK			
★ T114-124-144 OSC11 - CP/CR/CT - CP19F FRONTLINE			
● P-G-R-T TRUCK			
★ CG/CP/CR/CT LH/RH - B4X2 CG/CP/CR16 ad5300/5500 - CG/CP/CR ad 5700/5900			



CENTRAL LH & RH STEP	62353	1535045	1351203
● 4 TRUCK			
★ CP/CR			



"This item may not be available on every market"

LOWER LH & RH STEP	64104	1535052	
● P-G-R-T TRUCK			
★ CG/CP/CR			



"This item may not be available on every market"

ALL THE COMPONENTS LISTED IN OUR CATALOGUE ARE NOT ORIGINAL, THOUGH PERFECTLY INTERCHANGEABLE. REFERENCE NUMBERS, EITHER ORIGINAL OR OF A DIFFERENT NATURE, ARE FOR INFORMATION PURPOSES ONLY. WHEN PLACING AN ORDER, PLEASE, ALWAYS USE COSIBO REFERENCE NUMBERS AND DO NOT MENTION THE ORIGINAL REFERENCE NUMBERS OF THE TRUCK MANUFACTURERS IN THE INVOICE TO VEHICLE OWNERS OR TO ANYBODY ELSE. THE CUSTOMER TAKES HIS OWN RESPONSIBILITY IF HE DOES NOT COMPLY WITH WHAT ABOVE.

MIDDLE LH & RH STEP



"This item may not be available on every market"

- Model
- ★ Application

Code

OEM new

OEM old

64105

1805447

1535048

- P-G-R-T TRUCK

- ★ CP/CR/CT

BEARING



● Model
★ Application

Code	OEM new	OEM old
64725	1387609	
● 4 BUS		
★		
● 4 TRUCK		
★		
● IND.MARINE ENGINE 4		
★		

ALL THE COMPONENTS LISTED IN OUR CATALOGUE ARE NOT ORIGINAL, THOUGH PERFECTLY INTERCHANGEABLE. REFERENCE NUMBERS, EITHER ORIGINAL OR OF A DIFFERENT NATURE, ARE FOR INFORMATION PURPOSES ONLY. WHEN PLACING AN ORDER, PLEASE, ALWAYS USE COSIBO REFERENCE NUMBERS AND DO NOT MENTION THE ORIGINAL REFERENCE NUMBERS OF THE TRUCK MANUFACTURERS IN THE INVOICE TO VEHICLE OWNERS OR TO ANYBODY ELSE. THE CUSTOMER TAKES HIS OWN RESPONSIBILITY IF HE DOES NOT COMPLY WITH WHAT ABOVE.

SILENCER LATERAL COVER



"This item may not be available on every market"

	Code	OEM new	OEM old
● Model	63962	1496659	1387870
★ Application			
● 4 TRUCK			
★ 114 - 124 - 144 - 164			
● P-G-R-T TRUCK			
★ CG/CP/CR			

BRACKET



	64214	1364103	
● 4 TRUCK			
★ CT 114-124-144 - OSC11 G03			
● P-G-R-T TRUCK			
★ CG/CP/CR/CT			

CLIP



	64213	1364102	
● 4 TRUCK			
★ CT 114-124-144 - OSC11 G03			
● P-G-R-T TRUCK			
★ CG/CP/CR/CT			

ALL THE COMPONENTS LISTED IN OUR CATALOGUE ARE NOT ORIGINAL, THOUGH PERFECTLY INTERCHANGEABLE. REFERENCE NUMBERS, EITHER ORIGINAL OR OF A DIFFERENT NATURE, ARE FOR INFORMATION PURPOSES ONLY. WHEN PLACING AN ORDER, PLEASE, ALWAYS USE COSIBO REFERENCE NUMBERS AND DO NOT MENTION THE ORIGINAL REFERENCE NUMBERS OF THE TRUCK MANUFACTURERS IN THE INVOICE TO VEHICLE OWNERS OR TO ANYBODY ELSE. THE CUSTOMER TAKES HIS OWN RESPONSIBILITY IF HE DOES NOT COMPLY WITH WHAT ABOVE.

LH DOOR FRAME



"This item may not be available on every market"

- Model
- ★ Application

Code	OEM new	OEM old
64391	1476532	1452667

- 4 TRUCK
- ★ CP
- P-G-R-T TRUCK
- ★ CP

RH DOOR FRAME



"This item may not be available on every market"

- 4 TRUCK
- ★ CP
- P-G-R-T TRUCK
- ★ CP

64392	1476533	1452668
-------	---------	---------

ALL THE COMPONENTS LISTED IN OUR CATALOGUE ARE NOT ORIGINAL, THOUGH PERFECTLY INTERCHANGEABLE. REFERENCE NUMBERS, EITHER ORIGINAL OR OF A DIFFERENT NATURE, ARE FOR INFORMATION PURPOSES ONLY. WHEN PLACING AN ORDER, PLEASE, ALWAYS USE COSIBO REFERENCE NUMBERS AND DO NOT MENTION THE ORIGINAL REFERENCE NUMBERS OF THE TRUCK MANUFACTURERS IN THE INVOICE TO VEHICLE OWNERS OR TO ANYBODY ELSE. THE CUSTOMER TAKES HIS OWN RESPONSIBILITY IF HE DOES NOT COMPLY WITH WHAT ABOVE.

LH DOOR FRAME



"This item may not be available on every market"

- Model
- ★ Application

Code

OEM new

OEM old

64393

1476534

- 4 TRUCK

- ★ CR

- P-G-T- TRUCK

- ★ CR

RH DOOR FRAME



"This item may not be available on every market"

- 4 TRUCK

- ★ CR

- P-G-R-T TRUCK

- ★ CR

64394

1476535

ALL THE COMPONENTS LISTED IN OUR CATALOGUE ARE NOT ORIGINAL, THOUGH PERFECTLY INTERCHANGEABLE. REFERENCE NUMBERS, EITHER ORIGINAL OR OF A DIFFERENT NATURE, ARE FOR INFORMATION PURPOSES ONLY. WHEN PLACING AN ORDER, PLEASE, ALWAYS USE COSIBO REFERENCE NUMBERS AND DO NOT MENTION THE ORIGINAL REFERENCE NUMBERS OF THE TRUCK MANUFACTURERS IN THE INVOICE TO VEHICLE OWNERS OR TO ANYBODY ELSE. THE CUSTOMER TAKES HIS OWN RESPONSIBILITY IF HE DOES NOT COMPLY WITH WHAT ABOVE.

LH DOOR PANEL



"This item may not be available on every market"

- Model
- ★ Application

Code	OEM new	OEM old
64429	1769911	1406465

- P-G-R-T TRUCK
- ★ CG/CP/CR/CT

RH DOOR PANEL



"This item may not be available on every market"

- P-G-R-T TRUCK
- ★ C/CP/CR/CT

64428	1769912	1406466
-------	---------	---------

ALL THE COMPONENTS LISTED IN OUR CATALOGUE ARE NOT ORIGINAL, THOUGH PERFECTLY INTERCHANGEABLE. REFERENCE NUMBERS, EITHER ORIGINAL OR OF A DIFFERENT NATURE, ARE FOR INFORMATION PURPOSES ONLY. WHEN PLACING AN ORDER, PLEASE, ALWAYS USE COSIBO REFERENCE NUMBERS AND DO NOT MENTION THE ORIGINAL REFERENCE NUMBERS OF THE TRUCK MANUFACTURERS IN THE INVOICE TO VEHICLE OWNERS OR TO ANYBODY ELSE. THE CUSTOMER TAKES HIS OWN RESPONSIBILITY IF HE DOES NOT COMPLY WITH WHAT ABOVE.

LH DOOR LOCK

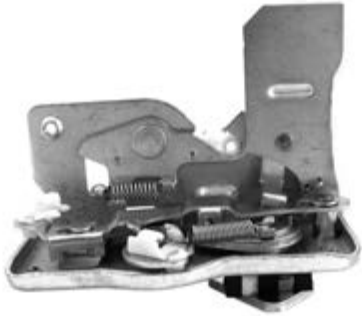

- Model
- ★ Application

Code

OEM new

OEM old

64050

376283

- 3 TRUCK

- ★

RH DOOR LOCK

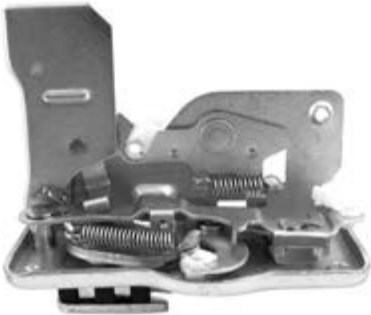

- 3 TRUCK

- ★

64051

376284

LH INTERNAL DOOR LOCK



- 4 TRUCK

- ★ CP/CR/CT

64001

1789305

1406223

RH INTERNAL DOOR LOCK



- 4 TRUCK

- ★ CP/CR/CT

64002

1789306

1406224

ALL THE COMPONENTS LISTED IN OUR CATALOGUE ARE NOT ORIGINAL, THOUGH PERFECTLY INTERCHANGEABLE. REFERENCE NUMBERS, EITHER ORIGINAL OR OF A DIFFERENT NATURE, ARE FOR INFORMATION PURPOSES ONLY. WHEN PLACING AN ORDER, PLEASE, ALWAYS USE COSIBO REFERENCE NUMBERS AND DO NOT MENTION THE ORIGINAL REFERENCE NUMBERS OF THE TRUCK MANUFACTURERS IN THE INVOICE TO VEHICLE OWNERS OR TO ANYBODY ELSE. THE CUSTOMER TAKES HIS OWN RESPONSIBILITY IF HE DOES NOT COMPLY WITH WHAT ABOVE.

	Code	OEM new	OEM old
LH DOOR LOCK (SELF LOCKING)	65489	1867658	1789317
<ul style="list-style-type: none"> ● Model ★ Application 			
<ul style="list-style-type: none"> ● P-G-R-T TRUCK ★ 			



RH DOOR LOCK (SELF LOCKING)	65490	1867659	1789318
<ul style="list-style-type: none"> ● P-G-R-T TRUCK ★ 			







LH DOOR LOCK (SELF LOCKING)	65432	1902973	1406227 1789309
<ul style="list-style-type: none"> ● 4 TRUCK ★ 			



RH DOOR LOCK (SELF LOCKING)	65433	1902974	1406228 1789310
<ul style="list-style-type: none"> ● 4 TRUCK ★ 			

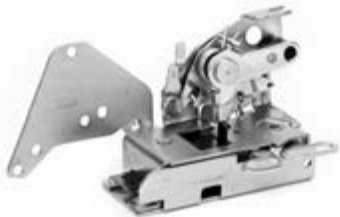

ALL THE COMPONENTS LISTED IN OUR CATALOGUE ARE NOT ORIGINAL, THOUGH PERFECTLY INTERCHANGEABLE. REFERENCE NUMBERS, EITHER ORIGINAL OR OF A DIFFERENT NATURE, ARE FOR INFORMATION PURPOSES ONLY. WHEN PLACING AN ORDER, PLEASE, ALWAYS USE COSIBO REFERENCE NUMBERS AND DO NOT MENTION THE ORIGINAL REFERENCE NUMBERS OF THE TRUCK MANUFACTURERS IN THE INVOICE TO VEHICLE OWNERS OR TO ANYBODY ELSE. THE CUSTOMER TAKES HIS OWN RESPONSIBILITY IF HE DOES NOT COMPLY WITH WHAT ABOVE.

	Code	OEM new	OEM old
RH LOCK	65527	1440781	1404099
 <ul style="list-style-type: none"> ● Model ★ Application 			
<ul style="list-style-type: none"> ● 4 TRUCK ★ 			
LH LOCK	65526	1440780	1393103
 <ul style="list-style-type: none"> ● Model ★ Application 			
<ul style="list-style-type: none"> ● 4 TRUCK ★ 			
LH ELECTRIC LOCK	65489	1867658	1789317
 <ul style="list-style-type: none"> ● Model ★ Application 			
<ul style="list-style-type: none"> ● P-G-R-T TRUCK ★ 			
RH ELECTRIC LOCK	65490	1867659	1789318
 <ul style="list-style-type: none"> ● Model ★ Application 			
<ul style="list-style-type: none"> ● P-G-R-T TRUCK ★ 			

ALL THE COMPONENTS LISTED IN OUR CATALOGUE ARE NOT ORIGINAL, THOUGH PERFECTLY INTERCHANGEABLE. REFERENCE NUMBERS, EITHER ORIGINAL OR OF A DIFFERENT NATURE, ARE FOR INFORMATION PURPOSES ONLY. WHEN PLACING AN ORDER, PLEASE, ALWAYS USE COSIBO REFERENCE NUMBERS AND DO NOT MENTION THE ORIGINAL REFERENCE NUMBERS OF THE TRUCK MANUFACTURERS IN THE INVOICE TO VEHICLE OWNERS OR TO ANYBODY ELSE. THE CUSTOMER TAKES HIS OWN RESPONSIBILITY IF HE DOES NOT COMPLY WITH WHAT ABOVE.

	Code	OEM new	OEM old
WINDOW HANDLE 	62208	376116	
<ul style="list-style-type: none"> ● Model ★ Application 			
<ul style="list-style-type: none"> ● 3 TRUCK ★ 			
WINDOW HANDLE 	64368	1346181	
<ul style="list-style-type: none"> ● 4 TRUCK ★ CP/CR/CT 			
WINDOW HANDLE 	64369	1425659	
<ul style="list-style-type: none"> ● P-G-R-T TRUCK ★ CG/CP/CR/CT 			
LH DOOR HANDLER LEVER 	64023	1346177	
<ul style="list-style-type: none"> ● 4 TRUCK ★ 			

ALL THE COMPONENTS LISTED IN OUR CATALOGUE ARE NOT ORIGINAL, THOUGH PERFECTLY INTERCHANGEABLE. REFERENCE NUMBERS, EITHER ORIGINAL OR OF A DIFFERENT NATURE, ARE FOR INFORMATION PURPOSES ONLY. WHEN PLACING AN ORDER, PLEASE, ALWAYS USE COSIBO REFERENCE NUMBERS AND DO NOT MENTION THE ORIGINAL REFERENCE NUMBERS OF THE TRUCK MANUFACTURERS IN THE INVOICE TO VEHICLE OWNERS OR TO ANYBODY ELSE. THE CUSTOMER TAKES HIS OWN RESPONSIBILITY IF HE DOES NOT COMPLY WITH WHAT ABOVE.

RH DOOR HANDLER LEVER



- Model
- ★ Application

Code

OEM new

OEM old

64024

1346178

- 4 TRUCK

- ★

LH HANDLE LEVER TIEROD



- 4 TRUCK

- ★

63540

1346905

RH HANDLE LEVER TIEROD



- 4 TRUCK

- ★

63541

1346906

PLASTIC PART



- 4 TRUCK

- ★

64826

1346907

ALL THE COMPONENTS LISTED IN OUR CATALOGUE ARE NOT ORIGINAL, THOUGH PERFECTLY INTERCHANGEABLE. REFERENCE NUMBERS, EITHER ORIGINAL OR OF A DIFFERENT NATURE, ARE FOR INFORMATION PURPOSES ONLY. WHEN PLACING AN ORDER, PLEASE, ALWAYS USE COSIBO REFERENCE NUMBERS AND DO NOT MENTION THE ORIGINAL REFERENCE NUMBERS OF THE TRUCK MANUFACTURERS IN THE INVOICE TO VEHICLE OWNERS OR TO ANYBODY ELSE. THE CUSTOMER TAKES HIS OWN RESPONSIBILITY IF HE DOES NOT COMPLY WITH WHAT ABOVE.

LH DOOR HANDLE



This item may not be available on every market

- Model
- ★ Application

Code	OEM new	OEM old
62347	2005369	1423017 1488409 1544330

- 4 TRUCK
- ★ CP/CR/CT
- P-G-R-T TRUCK
- ★

RH DOOR HANDLE



This item may not be available on every market

62348	2005370	1423018 1488410 1544331
-------	---------	-------------------------------

- 4 TRUCK
- ★ CP/CR/CT
- P-G-R-T TRUCK
- ★

LOCK CYLINDER SET



62354	581025	
-------	--------	--

- 4 TRUCK
- ★ 94 - 114 - 124 - 144 - 164
- 4 BUS
- ★ F94H

ALL THE COMPONENTS LISTED IN OUR CATALOGUE ARE NOT ORIGINAL, THOUGH PERFECTLY INTERCHANGEABLE. REFERENCE NUMBERS, EITHER ORIGINAL OR OF A DIFFERENT NATURE, ARE FOR INFORMATION PURPOSES ONLY. WHEN PLACING AN ORDER, PLEASE, ALWAYS USE COSIBO REFERENCE NUMBERS AND DO NOT MENTION THE ORIGINAL REFERENCE NUMBERS OF THE TRUCK MANUFACTURERS IN THE INVOICE TO VEHICLE OWNERS OR TO ANYBODY ELSE. THE CUSTOMER TAKES HIS OWN RESPONSIBILITY IF HE DOES NOT COMPLY WITH WHAT ABOVE.

	Code	OEM new	OEM old
DOOR CYLINDER LOCK SET	62421	62421	
<ul style="list-style-type: none"> ● Model ★ Application 			
<ul style="list-style-type: none"> ● 4 TRUCK ★ 94 - 114 - 124 - 144 - 164 			
<ul style="list-style-type: none"> ● 4 BUS ★ F94H 			



LH DOOR HANDLE SET	65406	65406	
<ul style="list-style-type: none"> ● 4 TRUCK ★ CP/CR/CT 			
<ul style="list-style-type: none"> ● P-G-R-T TRUCK ★ 			



"This item may not be available on every market"

RH DOOR HANDLE SET	65405	65405	
<ul style="list-style-type: none"> ● 4 TRUCK ★ CP/CR/CT 			
<ul style="list-style-type: none"> ● P-G-R-T TRUCK ★ 			



"This item may not be available on every market"

ALL THE COMPONENTS LISTED IN OUR CATALOGUE ARE NOT ORIGINAL, THOUGH PERFECTLY INTERCHANGEABLE. REFERENCE NUMBERS, EITHER ORIGINAL OR OF A DIFFERENT NATURE, ARE FOR INFORMATION PURPOSES ONLY. WHEN PLACING AN ORDER, PLEASE, ALWAYS USE COSIBO REFERENCE NUMBERS AND DO NOT MENTION THE ORIGINAL REFERENCE NUMBERS OF THE TRUCK MANUFACTURERS IN THE INVOICE TO VEHICLE OWNERS OR TO ANYBODY ELSE. THE CUSTOMER TAKES HIS OWN RESPONSIBILITY IF HE DOES NOT COMPLY WITH WHAT ABOVE.

LH WINDOW REGULATOR



- Model
- ★ Application

61363

336979

OEM old

- 3 TRUCK

- ★ 93 - 113 - 143

- 2 TRUCK

- ★ 82 - 92 - 112 - 142

RH WINDOW REGULATOR



61644

336980

- 3 TRUCK

- ★ 93 - 113 - 143

- 2 TRUCK

- ★ 82 - 92 - 112 - 142

LH ELECTRIC WINDOW REGULATOR WITH MOTOR



61606

1406613

376673

- 3 TRUCK

- ★ 93 - 113 - 143

RH ELECTRIC WINDOW REGULATOR WITH MOTOR

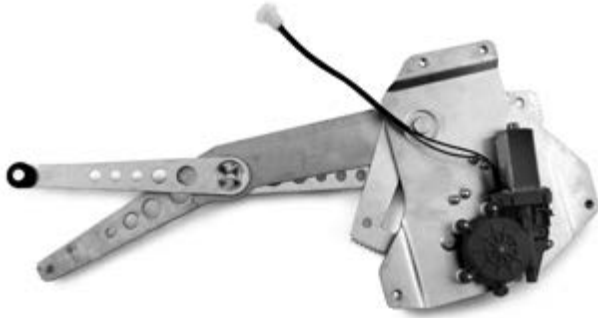

- Model
- ★ Application

Code

OEM new

OEM old

62195

1406614

376674

- 3 TRUCK

- ★ 93 - 113 - 143

GLASS GASKET STD



64433

1865517

1865519

- 4 TRUCK

- ★

- P-G-R-T TRUCK

- ★

LH DOOR HANDLE



61728

1306975

356085

- 3 TRUCK

- ★

RH DOOR HANDLE



61729

1306976

356086

- 3 TRUCK

- ★

ALL THE COMPONENTS LISTED IN OUR CATALOGUE ARE NOT ORIGINAL, THOUGH PERFECTLY INTERCHANGEABLE. REFERENCE NUMBERS, EITHER ORIGINAL OR OF A DIFFERENT NATURE, ARE FOR INFORMATION PURPOSES ONLY. WHEN PLACING AN ORDER, PLEASE, ALWAYS USE COSIBO REFERENCE NUMBERS AND DO NOT MENTION THE ORIGINAL REFERENCE NUMBERS OF THE TRUCK MANUFACTURERS IN THE INVOICE TO VEHICLE OWNERS OR TO ANYBODY ELSE. THE CUSTOMER TAKES HIS OWN RESPONSIBILITY IF HE DOES NOT COMPLY WITH WHAT ABOVE.

RH/LH DOOR STOP TIEROD



- Model
- ★ Application

Code	OEM new	OEM old
62321	356942	356942

- **3 TRUCK**
- ★ 93 - 113 - 143

LH ELECTRIC WINDOW REGULATOR WITH MOTOR

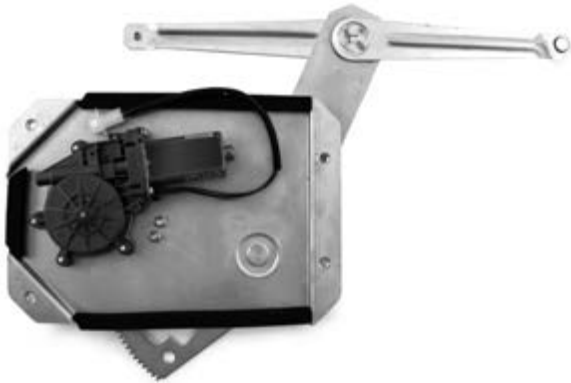

61607	1366849	
--------------	---------	--

- **4 TRUCK**
- ★
- **P-G-R-T TRUCK**
- ★

RH ELECTRIC WINDOW REGULATOR WITH MOTOR

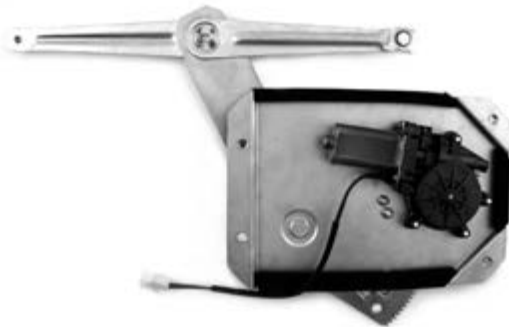

62343	1366850	1366850
--------------	---------	---------

- **4 TRUCK**
- ★
- **P-G-R-T TRUCK**
- ★

ALL THE COMPONENTS LISTED IN OUR CATALOGUE ARE NOT ORIGINAL, THOUGH PERFECTLY INTERCHANGEABLE. REFERENCE NUMBERS, EITHER ORIGINAL OR OF A DIFFERENT NATURE, ARE FOR INFORMATION PURPOSES ONLY. WHEN PLACING AN ORDER, PLEASE, ALWAYS USE COSIBO REFERENCE NUMBERS AND DO NOT MENTION THE ORIGINAL REFERENCE NUMBERS OF THE TRUCK MANUFACTURERS IN THE INVOICE TO VEHICLE OWNERS OR TO ANYBODY ELSE. THE CUSTOMER TAKES HIS OWN RESPONSIBILITY IF HE DOES NOT COMPLY WITH WHAT ABOVE.

LH ELECTRIC WINDOW REGULATOR WITH MOTOR



- Model
- ★ Application

Code	OEM new	OEM old
65365	1442294	

- 4 TRUCK
- ★
- P-G-R-T TRUCK
- ★

RH ELECTRIC WINDOW REGULATOR WITH MOTOR

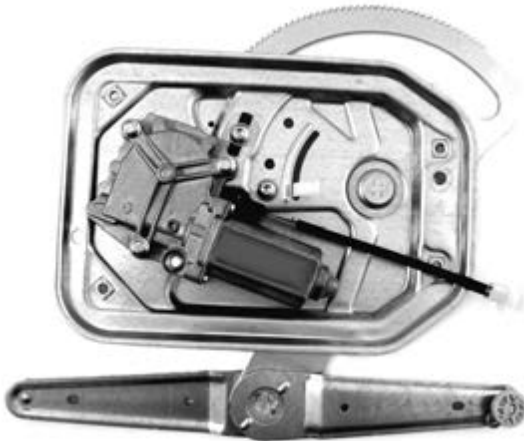

- 4 TRUCK
- ★
- P-G-R-T TRUCK
- ★

65366	1442295	
-------	---------	--

LH WINDOW REGULATOR MOTOR

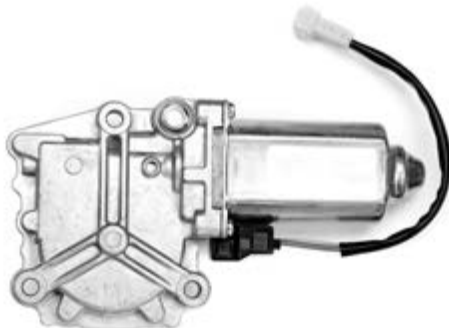

- 4 TRUCK
- ★
- P-G-R-T TRUCK
- ★

63913	1442292	
-------	---------	--

ALL THE COMPONENTS LISTED IN OUR CATALOGUE ARE NOT ORIGINAL, THOUGH PERFECTLY INTERCHANGEABLE. REFERENCE NUMBERS, EITHER ORIGINAL OR OF A DIFFERENT NATURE, ARE FOR INFORMATION PURPOSES ONLY. WHEN PLACING AN ORDER, PLEASE, ALWAYS USE COSIBO REFERENCE NUMBERS AND DO NOT MENTION THE ORIGINAL REFERENCE NUMBERS OF THE TRUCK MANUFACTURERS IN THE INVOICE TO VEHICLE OWNERS OR TO ANYBODY ELSE. THE CUSTOMER TAKES HIS OWN RESPONSIBILITY IF HE DOES NOT COMPLY WITH WHAT ABOVE.

RH WINDOW REGULATOR MOTOR

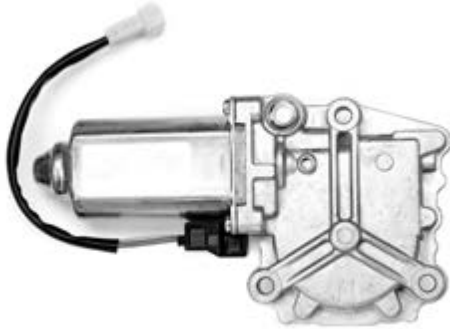

- Model
- ★ Application

Code

OEM new

OEM old

63914

1442293

- 4 TRUCK

★

- P-G-R-T TRUCK

★

SWITCH



- 4 TRUCK

★

62389

1413146

SLIDING GUIDE



- 4 TRUCK

★

- P-G-R-T TRUCK

★

64025

1346119

SLIDING GUIDE



- 4 TRUCK

★

- P-G-R-T TRUCK

★

64026

1366764

ALL THE COMPONENTS LISTED IN OUR CATALOGUE ARE NOT ORIGINAL, THOUGH PERFECTLY INTERCHANGEABLE. REFERENCE NUMBERS, EITHER ORIGINAL OR OF A DIFFERENT NATURE, ARE FOR INFORMATION PURPOSES ONLY. WHEN PLACING AN ORDER, PLEASE, ALWAYS USE COSIBO REFERENCE NUMBERS AND DO NOT MENTION THE ORIGINAL REFERENCE NUMBERS OF THE TRUCK MANUFACTURERS IN THE INVOICE TO VEHICLE OWNERS OR TO ANYBODY ELSE. THE CUSTOMER TAKES HIS OWN RESPONSIBILITY IF HE DOES NOT COMPLY WITH WHAT ABOVE.

	Code	OEM new	OEM old
FRONT PANEL	62280	1383609	
<ul style="list-style-type: none"> ● Model ★ Application 			
<ul style="list-style-type: none"> ● 4 TRUCK ★ CR LHD CH 1227496 - CH 4371634 - CH 9021603 - CH 3500001 - CP/CR RHD CH 1233808 - CH 4382182 - CH 9027044 - CH 3500001 - CP LHD CH 1230215 - CH 4376385 - CH 9023917 - CH 3500001 			



FRONT GRILLE	61971	1397570	1371856
---------------------	--------------	---------	---------



"This item may not be available on every market"

- 4 TRUCK
- ★ CR LHD/RHD

UPPER GRILLE NET	62310	1401929	
-------------------------	--------------	---------	--



- 4 TRUCK
- ★ CR LHD/RHD FOR OUR 61971

MIDDLE GRILLE NET	62311	1371757	
--------------------------	--------------	---------	--







- 4 TRUCK
- ★ CR LHD/RHD FOR OUR 61971

LOWER GRILLE NET	62312	1371758	
-------------------------	--------------	---------	--

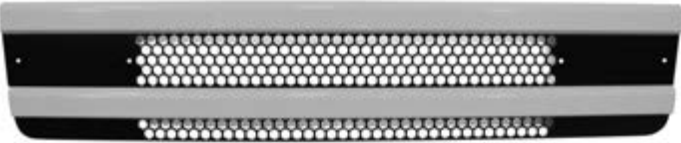

- 4 TRUCK
- ★ CR LHD/RHD FOR OUR 61971

ALL THE COMPONENTS LISTED IN OUR CATALOGUE ARE NOT ORIGINAL, THOUGH PERFECTLY INTERCHANGEABLE. REFERENCE NUMBERS, EITHER ORIGINAL OR OF A DIFFERENT NATURE, ARE FOR INFORMATION PURPOSES ONLY. WHEN PLACING AN ORDER, PLEASE, ALWAYS USE COSIBO REFERENCE NUMBERS AND DO NOT MENTION THE ORIGINAL REFERENCE NUMBERS OF THE TRUCK MANUFACTURERS IN THE INVOICE TO VEHICLE OWNERS OR TO ANYBODY ELSE. THE CUSTOMER TAKES HIS OWN RESPONSIBILITY IF HE DOES NOT COMPLY WITH WHAT ABOVE.

	Code	OEM new	OEM old
RADIATOR GRILLE 	62411	1870689	1366832
<ul style="list-style-type: none"> ● Model ★ Application 			
<ul style="list-style-type: none"> ● 4 TRUCK ★ CP/CR 			
GRILLE  <p style="text-align: center;">"This item may not be available on every market"</p>	62275	1366384	1306198
<ul style="list-style-type: none"> ● 4 TRUCK ★ CP/CR/CT 			
LH GRILLE HINGE 	62364	1381479	1306403
<ul style="list-style-type: none"> ● 4 TRUCK ★ CP/CR FOR OUR 62275 			
RH GRILLE HINGE 	62365	1381480	1306404
<ul style="list-style-type: none"> ● 4 TRUCK ★ CP/CR FOR OUR 62275 			
LH GRILLE HINGE 	62412	1383887	
<ul style="list-style-type: none"> ● 4 TRUCK ★ CR LHD CH 1227496 - CH 4371634 - CH 9021603 - CH 3500001 - CR RHD CH 1233808 - CH 4382182 - CH 9027044 - CH 3500001 - CP LHD CH 1230215 - CH 4376385 - CH 9023917 - CH 3500001 - CP RHD CH 1233808 - CH 4382182 - CH 9027044 - CH 3500001 FOR OUR 61971 			

ALL THE COMPONENTS LISTED IN OUR CATALOGUE ARE NOT ORIGINAL, THOUGH PERFECTLY INTERCHANGEABLE. REFERENCE NUMBERS, EITHER ORIGINAL OR OF A DIFFERENT NATURE, ARE FOR INFORMATION PURPOSES ONLY. WHEN PLACING AN ORDER, PLEASE, ALWAYS USE COSIBO REFERENCE NUMBERS AND DO NOT MENTION THE ORIGINAL REFERENCE NUMBERS OF THE TRUCK MANUFACTURERS IN THE INVOICE TO VEHICLE OWNERS OR TO ANYBODY ELSE. THE CUSTOMER TAKES HIS OWN RESPONSIBILITY IF HE DOES NOT COMPLY WITH WHAT ABOVE.

	Code	OEM new	OEM old
RH GRILLE HINGE	62413	1383888	
<ul style="list-style-type: none"> ● Model ★ Application 			
<ul style="list-style-type: none"> ● 4 TRUCK ★ CR LHD CH 1227496 - CH 4371634 - CH 9021603 - CH 3500001 - CR RHD CH 1233808 - CH 4382182 - CH 9027044 - CH 3500001 - CP LHD CH 1230215 - CH 4376385 - CH 9023917 - CH 3500001 - CP RHD CH 1233808 - CH 4382182 - CH 9027044 - CH 3500001 FOR OUR 61971 			



FRONT GRILLE	61969	1317538	
<ul style="list-style-type: none"> ● 3 TRUCK ★ CABIN CG/CP CH 1189449 - CH 4322041 - CABIN CP 6X4 - 8X4 - CABIN CP CH 1184048 - CH 4316396 			







FRONT GRILLE HANDLE	62363	388536	
<ul style="list-style-type: none"> ● 3 TRUCK ★ 93 - 113 - 143 			



GRILLE HINGE	62366	385159	
<ul style="list-style-type: none"> ● 3 TRUCK ★ 93 - 113 - 143 			

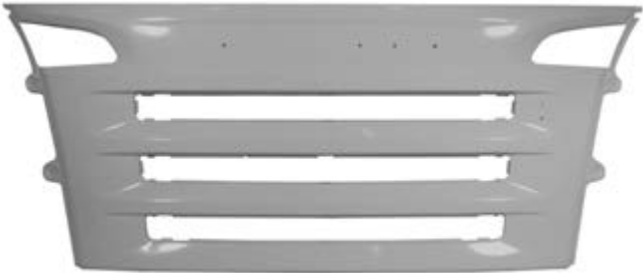





	Code	OEM new	OEM old
GRILLE 	62305	1397571	1371857
<ul style="list-style-type: none"> ● Model ★ Application 			
<ul style="list-style-type: none"> ● 4 TRUCK ★ CP LHD/RHD 			
UPPER GRILLE NET 	63917	1401931	
<ul style="list-style-type: none"> ● 4 TRUCK ★ CP LHD/RHD FOR OUR 62305 			
LOWER GRILLE NET 	63918	1371754	
<ul style="list-style-type: none"> ● 4 TRUCK ★ CP LHD/RHD FOR OUR 62305 			
FRONT GRILLE  <p style="text-align: center;">*This item may not be available on every market*</p>	62480	1755594	1538383
<ul style="list-style-type: none"> ● P-G-R-T TRUCK ★ CG/CR 			
FRONT GRILLE  <p style="text-align: center;">*This item may not be available on every market*</p>	62543	1543607	
<ul style="list-style-type: none"> ● P-G-R-T TRUCK ★ CP 			

ALL THE COMPONENTS LISTED IN OUR CATALOGUE ARE NOT ORIGINAL, THOUGH PERFECTLY INTERCHANGEABLE. REFERENCE NUMBERS, EITHER ORIGINAL OR OF A DIFFERENT NATURE, ARE FOR INFORMATION PURPOSES ONLY. WHEN PLACING AN ORDER, PLEASE, ALWAYS USE COSIBO REFERENCE NUMBERS AND DO NOT MENTION THE ORIGINAL REFERENCE NUMBERS OF THE TRUCK MANUFACTURERS IN THE INVOICE TO VEHICLE OWNERS OR TO ANYBODY ELSE. THE CUSTOMER TAKES HIS OWN RESPONSIBILITY IF HE DOES NOT COMPLY WITH WHAT ABOVE.

	Code	OEM new	OEM old
LH COVER 	64676	1466031	
<ul style="list-style-type: none"> ● Model ★ Application 			
<ul style="list-style-type: none"> ● P-G-R-T TRUCK ★ CG/CR 			
RH COVER 	64677	1466032	
<ul style="list-style-type: none"> ● P-G-R-T TRUCK ★ CG/CR 			
UPPER GRILLE NET 	64691	1459133	
<ul style="list-style-type: none"> ● P-G-R-T TRUCK ★ CG/CR FOR OUR 62480 			
MIDDLE GRILLE NET 	64692	1459134	
<ul style="list-style-type: none"> ● P-G-R-T TRUCK ★ CG/CR FOR OUR 62480 			
LOWER GRILLE NET 	64693	1459135	
<ul style="list-style-type: none"> ● P-G-R-T TRUCK ★ CG/CR FOR OUR 62480 			

ALL THE COMPONENTS LISTED IN OUR CATALOGUE ARE NOT ORIGINAL, THOUGH PERFECTLY INTERCHANGEABLE. REFERENCE NUMBERS, EITHER ORIGINAL OR OF A DIFFERENT NATURE, ARE FOR INFORMATION PURPOSES ONLY. WHEN PLACING AN ORDER, PLEASE, ALWAYS USE COSIBO REFERENCE NUMBERS AND DO NOT MENTION THE ORIGINAL REFERENCE NUMBERS OF THE TRUCK MANUFACTURERS IN THE INVOICE TO VEHICLE OWNERS OR TO ANYBODY ELSE. THE CUSTOMER TAKES HIS OWN RESPONSIBILITY IF HE DOES NOT COMPLY WITH WHAT ABOVE.

	Code	OEM new	OEM old
FRONT GRILLE  *This item may not be available on every market*	64697	1748085	
<ul style="list-style-type: none"> ● Model ★ Application 			
<ul style="list-style-type: none"> ● P-G-R-T TRUCK ★ CR LOW AND HIGH BUMPER 			
CLIP 	64682	1805399	1541484
<ul style="list-style-type: none"> ● P-G-R-T TRUCK ★ CG/CP/CR 			
GRILLE NET 	64696	1459145	
<ul style="list-style-type: none"> ● P-G-R-T TRUCK ★ CR LOW BUMBER FOR OUR 64697 			
FRONT GRILLE  *This item may not be available on every market*	62481	1536807	
<ul style="list-style-type: none"> ● P-G-R-T TRUCK ★ CP/CG/CR LOW BUMPER - CP/CG/CR HIGH BUMPER 			
FRONT GRILLE  *This item may not be available on every market*	64706	1748086	
<ul style="list-style-type: none"> ● P-G-R-T TRUCK ★ CR LOW AND HIGH BUMPER 			

ALL THE COMPONENTS LISTED IN OUR CATALOGUE ARE NOT ORIGINAL, THOUGH PERFECTLY INTERCHANGEABLE. REFERENCE NUMBERS, EITHER ORIGINAL OR OF A DIFFERENT NATURE, ARE FOR INFORMATION PURPOSES ONLY. WHEN PLACING AN ORDER, PLEASE, ALWAYS USE COSIBO REFERENCE NUMBERS AND DO NOT MENTION THE ORIGINAL REFERENCE NUMBERS OF THE TRUCK MANUFACTURERS IN THE INVOICE TO VEHICLE OWNERS OR TO ANYBODY ELSE. THE CUSTOMER TAKES HIS OWN RESPONSIBILITY IF HE DOES NOT COMPLY WITH WHAT ABOVE.

	Code	OEM new	OEM old
LH HINGE	64678	1727263	
	<ul style="list-style-type: none"> ● Model ★ Application 		
	<ul style="list-style-type: none"> ● P-G-R-T TRUCK ★ CG/CP/CR/CT HIGH BUMPER CH 2004860 - CH 5113674 - CH 9095270 		
RH HINGE	64679	1727264	
	<ul style="list-style-type: none"> ● P-G-R-T TRUCK ★ CG/CP/CR/CT HIGH BUMPER CH 2004860 - CH 5113674 - CH 9095270 		
LH GRILLE HINGE	62532	1724264	1543307
	<ul style="list-style-type: none"> ● P-G-R-T TRUCK ★ CP/CG/CR LOW BUMPER - CT LOW BUMPER FOR OUR 62481 		
RH GRILLE HINGE	62531	1742265	1543308
	<ul style="list-style-type: none"> ● P-G-R-T TRUCK ★ CP/CG/CR LOW BUMPER - CT LOW BUMPER FOR OUR 62481 		

ALL THE COMPONENTS LISTED IN OUR CATALOGUE ARE NOT ORIGINAL, THOUGH PERFECTLY INTERCHANGEABLE. REFERENCE NUMBERS, EITHER ORIGINAL OR OF A DIFFERENT NATURE, ARE FOR INFORMATION PURPOSES ONLY. WHEN PLACING AN ORDER, PLEASE, ALWAYS USE COSIBO REFERENCE NUMBERS AND DO NOT MENTION THE ORIGINAL REFERENCE NUMBERS OF THE TRUCK MANUFACTURERS IN THE INVOICE TO VEHICLE OWNERS OR TO ANYBODY ELSE. THE CUSTOMER TAKES HIS OWN RESPONSIBILITY IF HE DOES NOT COMPLY WITH WHAT ABOVE.

CABIN CABLE



- Model
- ★ Application

Code

OEM new

OEM old

65401

1926077

- P-G-R-T TRUCK

- ★ CG/CR LHD

LH DOOR STOP



- P-G-R-T TRUCK

- ★ CG/CP/CR

64319

1800469

1720615

FRONT DOOR LOCK





- P-G-R-T TRUCK

- ★ CG/CR





64864

1787672

ALL THE COMPONENTS LISTED IN OUR CATALOGUE ARE NOT ORIGINAL, THOUGH PERFECTLY INTERCHANGEABLE. REFERENCE NUMBERS, EITHER ORIGINAL OR OF A DIFFERENT NATURE, ARE FOR INFORMATION PURPOSES ONLY. WHEN PLACING AN ORDER, PLEASE, ALWAYS USE COSIBO REFERENCE NUMBERS AND DO NOT MENTION THE ORIGINAL REFERENCE NUMBERS OF THE TRUCK MANUFACTURERS IN THE INVOICE TO VEHICLE OWNERS OR TO ANYBODY ELSE. THE CUSTOMER TAKES HIS OWN RESPONSIBILITY IF HE DOES NOT COMPLY WITH WHAT ABOVE.

	Code	OEM new	OEM old
FRONT DOOR LOCK (RHD)	64865	1801618	
<ul style="list-style-type: none"> ● Model ★ Application 			
<ul style="list-style-type: none"> ● P-G-R-T TRUCK ★ CG/CR 			
			
LH COVER	64862	1479758	
<ul style="list-style-type: none"> ● P-G-R-T TRUCK ★ CG/CP/CR 			
			
RH COVER	64863	1479759	
<ul style="list-style-type: none"> ● P-G-R-T TRUCK ★ CG/CP/CR 			
			
RH DOOR STOP	64318	1800470	1720616
<ul style="list-style-type: none"> ● P-G-R-T TRUCK ★ CG/CP/CR 			
			

ALL THE COMPONENTS LISTED IN OUR CATALOGUE ARE NOT ORIGINAL, THOUGH PERFECTLY INTERCHANGEABLE. REFERENCE NUMBERS, EITHER ORIGINAL OR OF A DIFFERENT NATURE, ARE FOR INFORMATION PURPOSES ONLY. WHEN PLACING AN ORDER, PLEASE, ALWAYS USE COSIBO REFERENCE NUMBERS AND DO NOT MENTION THE ORIGINAL REFERENCE NUMBERS OF THE TRUCK MANUFACTURERS IN THE INVOICE TO VEHICLE OWNERS OR TO ANYBODY ELSE. THE CUSTOMER TAKES HIS OWN RESPONSIBILITY IF HE DOES NOT COMPLY WITH WHAT ABOVE.

	Code	OEM new	OEM old
LH FRAME HINGE 	65412	1451527	
<ul style="list-style-type: none"> ● Model ★ Application 			
<ul style="list-style-type: none"> ● P-G-R-T TRUCK ★ CG/CP/CR 			
RH FRAME HINGE 	65413	1451528	
<ul style="list-style-type: none"> ● P-G-R-T TRUCK ★ CG/CP/CR 			
DOOR STOP 	65421	1930649	1857591
<ul style="list-style-type: none"> ● 4 TRUCK ★ ● P-G-R-T TRUCK ★ 			
UPPER GRILLE NET 	64694	1459141	
<ul style="list-style-type: none"> ● P-G-R-T TRUCK ★ CP/CG/CR LOW BUMPER FOR OUR 62481 			
LOWER GRILLE NET 	64695	1459142	
<ul style="list-style-type: none"> ● P-G-R-T TRUCK ★ CP/CG/CR LOW BUMPER FOR OUR 62481 			

ALL THE COMPONENTS LISTED IN OUR CATALOGUE ARE NOT ORIGINAL, THOUGH PERFECTLY INTERCHANGEABLE. REFERENCE NUMBERS, EITHER ORIGINAL OR OF A DIFFERENT NATURE, ARE FOR INFORMATION PURPOSES ONLY. WHEN PLACING AN ORDER, PLEASE, ALWAYS USE COSIBO REFERENCE NUMBERS AND DO NOT MENTION THE ORIGINAL REFERENCE NUMBERS OF THE TRUCK MANUFACTURERS IN THE INVOICE TO VEHICLE OWNERS OR TO ANYBODY ELSE. THE CUSTOMER TAKES HIS OWN RESPONSIBILITY IF HE DOES NOT COMPLY WITH WHAT ABOVE.

	Code	OEM new	OEM old
GRILLE NET 	64362	1459146	
<ul style="list-style-type: none"> ● Model ★ Application 			
<ul style="list-style-type: none"> ● P-G-R-T TRUCK ★ CP LOW BUMBER FOR OUR 64706 			
FRAME COVER SX (LHD) 	65414	1451270	
<ul style="list-style-type: none"> ● P-G-R-T TRUCK ★ CG/CP/CR (LHD) 			
FRAME COVER DX (LHD) 	65415	1451271	
<ul style="list-style-type: none"> ● P-G-R-T TRUCK ★ CG/CP/CR (LHD) 			
MAIN FRAME 	64364	1804628	1746585
<ul style="list-style-type: none"> ● P-G-R-T TRUCK ★ CG/CR 			

ALL THE COMPONENTS LISTED IN OUR CATALOGUE ARE NOT ORIGINAL, THOUGH PERFECTLY INTERCHANGEABLE. REFERENCE NUMBERS, EITHER ORIGINAL OR OF A DIFFERENT NATURE, ARE FOR INFORMATION PURPOSES ONLY. WHEN PLACING AN ORDER, PLEASE, ALWAYS USE COSIBO REFERENCE NUMBERS AND DO NOT MENTION THE ORIGINAL REFERENCE NUMBERS OF THE TRUCK MANUFACTURERS IN THE INVOICE TO VEHICLE OWNERS OR TO ANYBODY ELSE. THE CUSTOMER TAKES HIS OWN RESPONSIBILITY IF HE DOES NOT COMPLY WITH WHAT ABOVE.

	Code	OEM new	OEM old
LOCK BRACKET	64320	1815227	1722438



- **Model**
 - ★ **Application**
-
- **P-G-R-T TRUCK**
 - ★ CG/CP/CR

HOOD AND GRILLE HINGE	62533	1767631	1431334
------------------------------	--------------	---------	---------



- **4 TRUCK**
 - ★ CT HOOD - CR GRILLE CH 1227023 - CH 4371353 - CH 9020783 - CH 3500001 - CP GRILLE CH 1233805 - CH 4382184 - CH 9027006 - CH 3500089
-
- **P-G-R-T TRUCK**
 - ★ CP/CR GRILLE CH 2025384 - CH 5171872 - CH 9119291 - CH 3604451 - CT HOOD - CP/CG/CR GRILLE CH 2025385 - CH 5171873 - CH 9119292 - CH 3604452

ALL THE COMPONENTS LISTED IN OUR CATALOGUE ARE NOT ORIGINAL, THOUGH PERFECTLY INTERCHANGEABLE. REFERENCE NUMBERS, EITHER ORIGINAL OR OF A DIFFERENT NATURE, ARE FOR INFORMATION PURPOSES ONLY. WHEN PLACING AN ORDER, PLEASE, ALWAYS USE COSIBO REFERENCE NUMBERS AND DO NOT MENTION THE ORIGINAL REFERENCE NUMBERS OF THE TRUCK MANUFACTURERS IN THE INVOICE TO VEHICLE OWNERS OR TO ANYBODY ELSE. THE CUSTOMER TAKES HIS OWN RESPONSIBILITY IF HE DOES NOT COMPLY WITH WHAT ABOVE.

	Code	OEM new	OEM old
FRONT BUMPER 	61988	1303318	1110201
<ul style="list-style-type: none"> ● Model ★ Application 			
<ul style="list-style-type: none"> ● 3 TRUCK ★ 			
LH BUMPER 	61993	1329551	
<ul style="list-style-type: none"> ● 3 TRUCK ★ STREAMLINE 			
RH BUMPER 	61992	1329552	
<ul style="list-style-type: none"> ● 3 TRUCK ★ STREAMLINE 			
CENTRAL BUMPER 	64664	1731206	1422843
<ul style="list-style-type: none"> ● P-G-R-T TRUCK ★ CP/CR/CT 			
LH CORNER BUMPER 	64663	1439788	
<ul style="list-style-type: none"> ● P-G-R-T TRUCK ★ CP/CR/CT 			
This item may not be available on every market			

ALL THE COMPONENTS LISTED IN OUR CATALOGUE ARE NOT ORIGINAL, THOUGH PERFECTLY INTERCHANGEABLE. REFERENCE NUMBERS, EITHER ORIGINAL OR OF A DIFFERENT NATURE, ARE FOR INFORMATION PURPOSES ONLY. WHEN PLACING AN ORDER, PLEASE, ALWAYS USE COSIBO REFERENCE NUMBERS AND DO NOT MENTION THE ORIGINAL REFERENCE NUMBERS OF THE TRUCK MANUFACTURERS IN THE INVOICE TO VEHICLE OWNERS OR TO ANYBODY ELSE. THE CUSTOMER TAKES HIS OWN RESPONSIBILITY IF HE DOES NOT COMPLY WITH WHAT ABOVE.

RH CORNER BUMPER



"This item may not be available on every market"

- Model
- ★ Application

Code

OEM new

OEM old

64662

1439789

- P-G-R-T TRUCK

- ★ CP/CR/CT

LH COVER



64674

1523508

- P-G-R-T TRUCK

- ★ CP/CR/CT

RH COVER



64675

1523509

- P-G-R-T TRUCK

- ★ CP/CR/CT

CENTRAL BUMPER



"This item may not be available on every market"

62434

1504131

- P-G-R-T TRUCK

- ★ CP/CR/CT

ALL THE COMPONENTS LISTED IN OUR CATALOGUE ARE NOT ORIGINAL, THOUGH PERFECTLY INTERCHANGEABLE. REFERENCE NUMBERS, EITHER ORIGINAL OR OF A DIFFERENT NATURE, ARE FOR INFORMATION PURPOSES ONLY. WHEN PLACING AN ORDER, PLEASE, ALWAYS USE COSIBO REFERENCE NUMBERS AND DO NOT MENTION THE ORIGINAL REFERENCE NUMBERS OF THE TRUCK MANUFACTURERS IN THE INVOICE TO VEHICLE OWNERS OR TO ANYBODY ELSE. THE CUSTOMER TAKES HIS OWN RESPONSIBILITY IF HE DOES NOT COMPLY WITH WHAT ABOVE.

LH CORNER BUMPER



"This item may not be available on every market"

- Model
- ★ Application

Code	OEM new	OEM old
62432	1431925	

- P-G-R-T TRUCK
- ★ CP/CR/CT

RH CORNER BUMPER



"This item may not be available on every market"

- P-G-R-T TRUCK
- ★ CP/CR/CT

62433	1431926	
-------	---------	--



METAL BUMPER



- 4 TRUCK
- ★ CR/CR/CT

62250	1515190	1376832 1482069 1499231
-------	---------	-------------------------------

ALL THE COMPONENTS LISTED IN OUR CATALOGUE ARE NOT ORIGINAL, THOUGH PERFECTLY INTERCHANGEABLE. REFERENCE NUMBERS, EITHER ORIGINAL OR OF A DIFFERENT NATURE, ARE FOR INFORMATION PURPOSES ONLY. WHEN PLACING AN ORDER, PLEASE, ALWAYS USE COSIBO REFERENCE NUMBERS AND DO NOT MENTION THE ORIGINAL REFERENCE NUMBERS OF THE TRUCK MANUFACTURERS IN THE INVOICE TO VEHICLE OWNERS OR TO ANYBODY ELSE. THE CUSTOMER TAKES HIS OWN RESPONSIBILITY IF HE DOES NOT COMPLY WITH WHAT ABOVE.

	Code	OEM new	OEM old
INTERNAL REINFORCEMENT BUMPER 	62264	1514093	1395871 1499230
<ul style="list-style-type: none"> ● Model ★ Application 			
	● 4 TRUCK		
	★ CP/CR/CT		
PLASTIC FRONT BUMPER  <p style="text-align: center;">*This item may not be available on every market*</p>	61991	1400213	1324596
	● 4 TRUCK		
	★ CP/CR/CT		
LH PLASTIC CORNER BUMPER  <p style="text-align: center;">*This item may not be available on every market*</p>	61989	1324597	
	● 4 TRUCK		
	★ CP/CR/CT		

ALL THE COMPONENTS LISTED IN OUR CATALOGUE ARE NOT ORIGINAL, THOUGH PERFECTLY INTERCHANGEABLE. REFERENCE NUMBERS, EITHER ORIGINAL OR OF A DIFFERENT NATURE, ARE FOR INFORMATION PURPOSES ONLY. WHEN PLACING AN ORDER, PLEASE, ALWAYS USE COSIBO REFERENCE NUMBERS AND DO NOT MENTION THE ORIGINAL REFERENCE NUMBERS OF THE TRUCK MANUFACTURERS IN THE INVOICE TO VEHICLE OWNERS OR TO ANYBODY ELSE. THE CUSTOMER TAKES HIS OWN RESPONSIBILITY IF HE DOES NOT COMPLY WITH WHAT ABOVE.

	Code	OEM new	OEM old
RH PLASTIC CORNER BUMPER	61990	1324598	
<ul style="list-style-type: none"> ● Model ★ Application 			
<ul style="list-style-type: none"> ● 4 TRUCK ★ CP/CR/CT 			



"This item may not be available on every market"

CENTRAL BUMPER	64747	1482078	
<ul style="list-style-type: none"> ● 4 TRUCK ★ CR/CP/CT 			



"This item may not be available on every market"

LH CORNER BUMPER	64745	1482079	
<ul style="list-style-type: none"> ● 4 TRUCK ★ CP/CR/CT 			



"This item may not be available on every market"

ALL THE COMPONENTS LISTED IN OUR CATALOGUE ARE NOT ORIGINAL, THOUGH PERFECTLY INTERCHANGEABLE. REFERENCE NUMBERS, EITHER ORIGINAL OR OF A DIFFERENT NATURE, ARE FOR INFORMATION PURPOSES ONLY. WHEN PLACING AN ORDER, PLEASE, ALWAYS USE COSIBO REFERENCE NUMBERS AND DO NOT MENTION THE ORIGINAL REFERENCE NUMBERS OF THE TRUCK MANUFACTURERS IN THE INVOICE TO VEHICLE OWNERS OR TO ANYBODY ELSE. THE CUSTOMER TAKES HIS OWN RESPONSIBILITY IF HE DOES NOT COMPLY WITH WHAT ABOVE.

RH CORNER BUMPER



"This item may not be available on every market"

- Model
- ★ Application

- 4 TRUCK

- ★ CP/CR/CT

Code	OEM new	OEM old
64746	1482080	

LH MUDGUARD COVER



"This item may not be available on every market"

- Model
- ★ Application

Code	OEM new	OEM old
62441	1364665	

- 4 TRUCK
- ★ CP/CR19
- P-G-R-T TRUCK
- ★ CG/CP19

RH MUDGUARD COVER



"This item may not be available on every market"

- 4 TRUCK
- ★ CP/CR19
- P-G-R-T TRUCK
- ★ CG/CP19

62440	1364666	
-------	---------	--

LH MUDGUARD COVER



"This item may not be available on every market"

- P-G-R-T TRUCK
- ★ CP/CG/CR - CR19

64698	1431933	
-------	---------	--

ALL THE COMPONENTS LISTED IN OUR CATALOGUE ARE NOT ORIGINAL, THOUGH PERFECTLY INTERCHANGEABLE. REFERENCE NUMBERS, EITHER ORIGINAL OR OF A DIFFERENT NATURE, ARE FOR INFORMATION PURPOSES ONLY. WHEN PLACING AN ORDER, PLEASE, ALWAYS USE COSIBO REFERENCE NUMBERS AND DO NOT MENTION THE ORIGINAL REFERENCE NUMBERS OF THE TRUCK MANUFACTURERS IN THE INVOICE TO VEHICLE OWNERS OR TO ANYBODY ELSE. THE CUSTOMER TAKES HIS OWN RESPONSIBILITY IF HE DOES NOT COMPLY WITH WHAT ABOVE.

RH MUDGUARD COVER



"This item may not be available on every market"

- Model
 - ★ Application
-
- **P-G-R-T TRUCK**
 - ★ CP/CG/CR - CR19

Code	OEM new	OEM old
64699	1431934	

LH MUDGUARD COVER



- **P-G-R-T TRUCK**
- ★ CR

64704	1431931	
--------------	---------	--

RH MUDGUARD COVER



- **P-G-R-T TRUCK**
- ★ CR

64707	1431932	
--------------	---------	--

ALL THE COMPONENTS LISTED IN OUR CATALOGUE ARE NOT ORIGINAL, THOUGH PERFECTLY INTERCHANGEABLE. REFERENCE NUMBERS, EITHER ORIGINAL OR OF A DIFFERENT NATURE, ARE FOR INFORMATION PURPOSES ONLY. WHEN PLACING AN ORDER, PLEASE, ALWAYS USE COSIBO REFERENCE NUMBERS AND DO NOT MENTION THE ORIGINAL REFERENCE NUMBERS OF THE TRUCK MANUFACTURERS IN THE INVOICE TO VEHICLE OWNERS OR TO ANYBODY ELSE. THE CUSTOMER TAKES HIS OWN RESPONSIBILITY IF HE DOES NOT COMPLY WITH WHAT ABOVE.

MUDGUARD HOOK



● Model
★ Application

Code

OEM new

OEM old

62256

2056867

1383520

● 4 TRUCK

★

● P-G-R-T TRUCK

★

ALL THE COMPONENTS LISTED IN OUR CATALOGUE ARE NOT ORIGINAL, THOUGH PERFECTLY INTERCHANGEABLE. REFERENCE NUMBERS, EITHER ORIGINAL OR OF A DIFFERENT NATURE, ARE FOR INFORMATION PURPOSES ONLY. WHEN PLACING AN ORDER, PLEASE, ALWAYS USE COSIBO REFERENCE NUMBERS AND DO NOT MENTION THE ORIGINAL REFERENCE NUMBERS OF THE TRUCK MANUFACTURERS IN THE INVOICE TO VEHICLE OWNERS OR TO ANYBODY ELSE. THE CUSTOMER TAKES HIS OWN RESPONSIBILITY IF HE DOES NOT COMPLY WITH WHAT ABOVE.

LH LATERAL REAR MUDGUARD



"This item may not be available on every market"

	Code	OEM new	OEM old
● Model	60341	1357599	
★ Application			
● 4 TRUCK			
★ 94 - 114 - 124 - 144 - 164			
● P-G-R-T TRUCK			
★			

RH LATERAL REAR MUDGUARD



"This item may not be available on every market"

	Code	OEM new	OEM old
● 4 TRUCK	60340	1357600	
★ 94 - 114 - 124 - 144 - 164			
● P-G-R-T TRUCK			
★			

LH MUDGUARD COVER



"This item may not be available on every market"

	Code	OEM new	OEM old
● 4 TRUCK	62308	1362708	
★ 94 - 114 - 124 - 144 - 164			
● P-G-R-T TRUCK			
★ 6X2 6X2/4 6X4 8X2 8X2/4 8X2/6 8X4 8X4/4			

ALL THE COMPONENTS LISTED IN OUR CATALOGUE ARE NOT ORIGINAL, THOUGH PERFECTLY INTERCHANGEABLE. REFERENCE NUMBERS, EITHER ORIGINAL OR OF A DIFFERENT NATURE, ARE FOR INFORMATION PURPOSES ONLY. WHEN PLACING AN ORDER, PLEASE, ALWAYS USE COSIBO REFERENCE NUMBERS AND DO NOT MENTION THE ORIGINAL REFERENCE NUMBERS OF THE TRUCK MANUFACTURERS IN THE INVOICE TO VEHICLE OWNERS OR TO ANYBODY ELSE. THE CUSTOMER TAKES HIS OWN RESPONSIBILITY IF HE DOES NOT COMPLY WITH WHAT ABOVE.

RH MUDGUARD COVER



"This item may not be available on every market"

- Model
- ★ Application

Code

OEM new

OEM old

62307

1368652

- 4 TRUCK

- ★ 94 - 114 - 124 - 144.164

- P-G-R-T TRUCK

- ★ 6X2 6X2/4 6X4 8X2 8X2/4 8X2/6 8X4 8X4/4

UPPER CENTRAL MUDGUARD



"This item may not be available on every market"

- 3 TRUCK

- ★ MA4X2A - MA4X2A STREAMLINE - MA4X2Z - MA4X2Z STREAMLINE - MW4X2 - MW4X2 STREAMLINE - HA4X2A - HA4X2Z - HA4X2Z STREAMLINE - MA6X2A - MA6X2A STREAMLINE - MA6X2/4A LHD - RHD - MA6X2/4A LHD STREAMLINE

61964

1313592

BRACKET



- 3 TRUCK

- ★

62035

1332320

ALL THE COMPONENTS LISTED IN OUR CATALOGUE ARE NOT ORIGINAL, THOUGH PERFECTLY INTERCHANGEABLE. REFERENCE NUMBERS, EITHER ORIGINAL OR OF A DIFFERENT NATURE, ARE FOR INFORMATION PURPOSES ONLY. WHEN PLACING AN ORDER, PLEASE, ALWAYS USE COSIBO REFERENCE NUMBERS AND DO NOT MENTION THE ORIGINAL REFERENCE NUMBERS OF THE TRUCK MANUFACTURERS IN THE INVOICE TO VEHICLE OWNERS OR TO ANYBODY ELSE. THE CUSTOMER TAKES HIS OWN RESPONSIBILITY IF HE DOES NOT COMPLY WITH WHAT ABOVE.

LATERAL MUDGUARD PANEL



"This item may not be available on every market"

- Model
- ★ Application

Code

OEM new

OEM old

61965

1313594

- 3 TRUCK

- ★ MA4X2A - MA4X2A STREAMLINE - MA4X2Z - MA4X2Z STREAMLINE - MW4X2 - MW4X2 STREAMLINE - HA4X2A - HA4X2Z - HA4X2Z STREAMLINE - MA6X2A - MA6X2A STREAMLINE - MA6X2/4A LHD - RHD - MA6X2/4A LHD STREAMLINE

LH FRONT MUDGUARD



61972

392099

388169

- 3 TRUCK

- ★ CR19 6X4 AM56 - CP19 4X2 6X2 6X4 8X4

RH FRONT MUDGUARD



61973

392100

388170

- 3 TRUCK

- ★ CR19 6X4 AM56 - CP19 4X2 6X2 6X4 8X4

ALL THE COMPONENTS LISTED IN OUR CATALOGUE ARE NOT ORIGINAL, THOUGH PERFECTLY INTERCHANGEABLE. REFERENCE NUMBERS, EITHER ORIGINAL OR OF A DIFFERENT NATURE, ARE FOR INFORMATION PURPOSES ONLY. WHEN PLACING AN ORDER, PLEASE, ALWAYS USE COSIBO REFERENCE NUMBERS AND DO NOT MENTION THE ORIGINAL REFERENCE NUMBERS OF THE TRUCK MANUFACTURERS IN THE INVOICE TO VEHICLE OWNERS OR TO ANYBODY ELSE. THE CUSTOMER TAKES HIS OWN RESPONSIBILITY IF HE DOES NOT COMPLY WITH WHAT ABOVE.

LH MUDGUARD



- Model
- ★ Application

Code	OEM new	OEM old
61974	1302771	

- 3 TRUCK
- ★ CR 13 4X2 6X2 6X4

RH MUDGUARD



- 3 TRUCK
- ★ CR 13 4X2 6X2 6X4

65390	1302772	
-------	---------	--

ALL THE COMPONENTS LISTED IN OUR CATALOGUE ARE NOT ORIGINAL, THOUGH PERFECTLY INTERCHANGEABLE. REFERENCE NUMBERS, EITHER ORIGINAL OR OF A DIFFERENT NATURE, ARE FOR INFORMATION PURPOSES ONLY. WHEN PLACING AN ORDER, PLEASE, ALWAYS USE COSIBO REFERENCE NUMBERS AND DO NOT MENTION THE ORIGINAL REFERENCE NUMBERS OF THE TRUCK MANUFACTURERS IN THE INVOICE TO VEHICLE OWNERS OR TO ANYBODY ELSE. THE CUSTOMER TAKES HIS OWN RESPONSIBILITY IF HE DOES NOT COMPLY WITH WHAT ABOVE.

LH MUDGUARD



- Model
- ★ Application

Code

OEM new

OEM old

61976

1325265

- 3 TRUCK

- ★ STREAMLINE CR 19

RH MUDGUARD



- 3 TRUCK

- ★ STREAMLINE CR 19

Code

OEM new

OEM old

61975

1325266

LH REAR MUDGUARD PANEL



- 3 TRUCK

- ★ CP/CR

Code

OEM new

OEM old

61979

288177

	Code	OEM new	OEM old
RH REAR MUDGUARD PANEL	61980	288178	
	● Model		
	★ Application		
	● 3 TRUCK		
	★ CP/CR		
REAR MUDGUARD	61966	1395276	1378194
	● 4 TRUCK		
	★ 94 - 114 - 124 - 144 - 164		
	● P-G-R-T TRUCK		
	★		
"This item may not be available on every market"			
REAR MUDGUARD	62306	1357602	
	● 4 TRUCK		
	★		
	● P-G-R-T TRUCK		
	★		
"This item may not be available on every market"			
MUDGUARD TENSIONER	61907	1383858	
	● 4 TRUCK		
	★ 94 - 114 - 124 - 144 - 164		
	● P-G-R-T TRUCK		
	★		

ALL THE COMPONENTS LISTED IN OUR CATALOGUE ARE NOT ORIGINAL, THOUGH PERFECTLY INTERCHANGEABLE. REFERENCE NUMBERS, EITHER ORIGINAL OR OF A DIFFERENT NATURE, ARE FOR INFORMATION PURPOSES ONLY. WHEN PLACING AN ORDER, PLEASE, ALWAYS USE COSIBO REFERENCE NUMBERS AND DO NOT MENTION THE ORIGINAL REFERENCE NUMBERS OF THE TRUCK MANUFACTURERS IN THE INVOICE TO VEHICLE OWNERS OR TO ANYBODY ELSE. THE CUSTOMER TAKES HIS OWN RESPONSIBILITY IF HE DOES NOT COMPLY WITH WHAT ABOVE.

	Code	OEM new	OEM old
TENSIONER	61316	335119	
<ul style="list-style-type: none"> ● Model ★ Application 			
<ul style="list-style-type: none"> ● 3 TRUCK ★ 			



	Code	OEM new	OEM old
FRONT LH / REAR RH MUDGUARD	62344	1485485	1408465
<ul style="list-style-type: none"> ● 4 TRUCK ★ CP 6X2/4 8X2 8X4 			
<ul style="list-style-type: none"> ● P-G-R-T TRUCK ★ STD 			



"This item may not be available on every market"

	Code	OEM new	OEM old
FRONT RH / REAR LH MUDGUARD	62345	1485486	1408466
<ul style="list-style-type: none"> ● 4 TRUCK ★ CP 6X2/4 8X2 8X4 			
<ul style="list-style-type: none"> ● P-G-R-T TRUCK ★ STD 			



"This item may not be available on every market"

	Code	OEM new	OEM old
MUDGUARD CLAMP	62442	1390747	
<ul style="list-style-type: none"> ● 4 TRUCK ★ 4X2 4X4 6X2 6X2/4 6X4 6X6 8X2 8X2/4 8X4 8X4/4 8X6/4 8X8 10X4/6 			
<ul style="list-style-type: none"> ● P-G-R-T TRUCK ★ 			



ALL THE COMPONENTS LISTED IN OUR CATALOGUE ARE NOT ORIGINAL, THOUGH PERFECTLY INTERCHANGEABLE. REFERENCE NUMBERS, EITHER ORIGINAL OR OF A DIFFERENT NATURE, ARE FOR INFORMATION PURPOSES ONLY. WHEN PLACING AN ORDER, PLEASE, ALWAYS USE COSIBO REFERENCE NUMBERS AND DO NOT MENTION THE ORIGINAL REFERENCE NUMBERS OF THE TRUCK MANUFACTURERS IN THE INVOICE TO VEHICLE OWNERS OR TO ANYBODY ELSE. THE CUSTOMER TAKES HIS OWN RESPONSIBILITY IF HE DOES NOT COMPLY WITH WHAT ABOVE.

LH REAR MUDGUARD BRACKET



	Code	OEM new	OEM old
● Model	64650	1725671	1400899 1457895
★ Application			

● 4 TRUCK
★ 94 - 114 - 124 - 144 - 164 - M16 - A4X2 - 2 SPRING

● P-G-R-T TRUCK
★ M16 - A4X2 - 2 SPRING

RH REAR MUDGUARD BRACKET



	64651	1725672	1400900 1457896
--	-------	---------	--------------------

● 4 TRUCK
★ 94 - 114 - 124 - 144 - 164 - M16 - A4X2 - 2 SPRING

● P-G-R-T TRUCK
★ M16 - A4X2 - 2 SPRING

LH REAR MUDGUARD BRACKET



	64643	1725675	
--	-------	---------	--

● 4 TRUCK
★ 94 - 114 - 124 - 144 - 164 - M12 - 2 SPRING

● P-G-R-T TRUCK
★ M12 - 2 SPRING

ALL THE COMPONENTS LISTED IN OUR CATALOGUE ARE NOT ORIGINAL, THOUGH PERFECTLY INTERCHANGEABLE. REFERENCE NUMBERS, EITHER ORIGINAL OR OF A DIFFERENT NATURE, ARE FOR INFORMATION PURPOSES ONLY. WHEN PLACING AN ORDER, PLEASE, ALWAYS USE COSIBO REFERENCE NUMBERS AND DO NOT MENTION THE ORIGINAL REFERENCE NUMBERS OF THE TRUCK MANUFACTURERS IN THE INVOICE TO VEHICLE OWNERS OR TO ANYBODY ELSE. THE CUSTOMER TAKES HIS OWN RESPONSIBILITY IF HE DOES NOT COMPLY WITH WHAT ABOVE.

	Code	OEM new	OEM old
RH REAR MUDGUARD BRACKET	64644	1725676	
● Model			
★ Application			
● 4 TRUCK			
★ 94 - 114 - 124 - 144 - 164 - M12 - 2 SPRING			
● P-G-R-T TRUCK			
★ M12 - 2 SPRING			



LH REAR MUDGUARD BRACKET	64350	1732855	
● 4 TRUCK			
★ 94 - 114 - 124 - 144 - 164 - FOR VEHICLE W/O STABILIZER BAR - M16 - 2 MOLLE			
● P-G-R-T TRUCK			
★ FOR VEHICLE W/O STABILIZER BAR - M16 - 2 SPRING			



RH REAR MUDGUARD BRACKET	64349	1732856	
● 4 TRUCK			
★ 94 - 114 - 124 - 144 - 164 - FOR VEHICLE W/O STABILIZER BAR - M16 - 2 SPRING			
● P-G-R-T TRUCK			
★ FOR VEHICLE W/O STABILIZER BAR/PER VEICOLI SENZA BARRA STABILIZZATRICE - M16 - 2 SPRING/2 MOLLE			



LH REAR MUDGUARD BRACKET SET



- Model
- ★ Application

Code

OEM new

OEM old

64106

64106

- 4 TRUCK

★ 94 - 114 - 124 - 144 - 164 - M16 - A4X2 - 2 SPRINGS

- P-G-R-T TRUCK

★ M16 - A4X2 - 2 SPRINGS

RH REAR MUDGUARD BRACKET SET



- 4 TRUCK

★ 94 - 114 - 124 - 144 - 164 - M16 - A4X2 - 2 SPRINGS

- P-G-R-T TRUCK

★ M16 - A4X2 - 2 SPRINGS

LH BRACKET



- 4 TRUCK

★ 94 - 114 - 124 - 144 - 164 - M16 - A4X2 - 2 SPRINGS WITHOUT STABILIZER BAR

- P-G-R-T TRUCK

★ M16 - A4X2 - 2 SPRINGS WITHOUT STABILIZER BAR

RH BRACKET



- 4 TRUCK

★ 94 - 114 - 124 - 144 - 164 - M16 - A4X2 - 2 SPRINGS WITHOUT STABILIZER BAR

- P-G-R-T TRUCK

★ M16 - A4X2 - 2 SPRINGS WITHOUT STABILIZER BAR

ALL THE COMPONENTS LISTED IN OUR CATALOGUE ARE NOT ORIGINAL, THOUGH PERFECTLY INTERCHANGEABLE. REFERENCE NUMBERS, EITHER ORIGINAL OR OF A DIFFERENT NATURE, ARE FOR INFORMATION PURPOSES ONLY. WHEN PLACING AN ORDER, PLEASE, ALWAYS USE COSIBO REFERENCE NUMBERS AND DO NOT MENTION THE ORIGINAL REFERENCE NUMBERS OF THE TRUCK MANUFACTURERS IN THE INVOICE TO VEHICLE OWNERS OR TO ANYBODY ELSE. THE CUSTOMER TAKES HIS OWN RESPONSIBILITY IF HE DOES NOT COMPLY WITH WHAT ABOVE.

LH REAR MUDGUARD BRACKET



	Code	OEM new	OEM old
● Model	63965	1725663	
★ Application			
● 4 TRUCK			
★ B4X2 2 SPRINGS M16			
● P-G-R-T TRUCK			
★ B4X2 2 SPRINGS M16			

RH REAR MUDGUARD BRACKET



	Code	OEM new	OEM old
	63964	1725664	
● 4 TRUCK			
★ B4X2 2 SPRINGS M16			
● P-G-R-T TRUCK			
★ B4X2 2 SPRINGS M16			

BATTERY COVER ASSY



"This item may not be available on every market"

	Code	OEM new	OEM old
	62384	2093721	1785531 1409860 1482405
● 4 TRUCK			
★ CP/CR			
● P-G-R-T TRUCK			
★			

ALL THE COMPONENTS LISTED IN OUR CATALOGUE ARE NOT ORIGINAL, THOUGH PERFECTLY INTERCHANGEABLE. REFERENCE NUMBERS, EITHER ORIGINAL OR OF A DIFFERENT NATURE, ARE FOR INFORMATION PURPOSES ONLY. WHEN PLACING AN ORDER, PLEASE, ALWAYS USE COSIBO REFERENCE NUMBERS AND DO NOT MENTION THE ORIGINAL REFERENCE NUMBERS OF THE TRUCK MANUFACTURERS IN THE INVOICE TO VEHICLE OWNERS OR TO ANYBODY ELSE. THE CUSTOMER TAKES HIS OWN RESPONSIBILITY IF HE DOES NOT COMPLY WITH WHAT ABOVE.

BATTERY COVER



- Model
- ★ Application

Code	OEM new	OEM old
64389	1362693	

- **4 TRUCK**
- ★ 135AH - 140AH - 175AH
- **P-G-R-T TRUCK**
- ★

BATTERY COVER RUBBER STRAP



	65246	1529552	366595
● 3 BUS			
★			
● 3 TRUCK			
★			
● 4 TRUCK			
★			
● P-G-R-T TRUCK			
★			

ALL THE COMPONENTS LISTED IN OUR CATALOGUE ARE NOT ORIGINAL, THOUGH PERFECTLY INTERCHANGEABLE. REFERENCE NUMBERS, EITHER ORIGINAL OR OF A DIFFERENT NATURE, ARE FOR INFORMATION PURPOSES ONLY. WHEN PLACING AN ORDER, PLEASE, ALWAYS USE COSIBO REFERENCE NUMBERS AND DO NOT MENTION THE ORIGINAL REFERENCE NUMBERS OF THE TRUCK MANUFACTURERS IN THE INVOICE TO VEHICLE OWNERS OR TO ANYBODY ELSE. THE CUSTOMER TAKES HIS OWN RESPONSIBILITY IF HE DOES NOT COMPLY WITH WHAT ABOVE.

	Code	OEM new	OEM old
LH CORNER PANEL	65306	280377	
<ul style="list-style-type: none"> ● Model ★ Application 			
<ul style="list-style-type: none"> ● 3 TRUCK ★ CG/CP CH 1189448 - CH 4322040 			

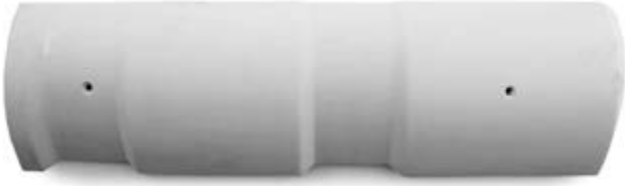

RH CORNER PANEL	65305	280378	
<ul style="list-style-type: none"> ● 3 TRUCK ★ CG/CP CH 1189448 - CH 4322040 			

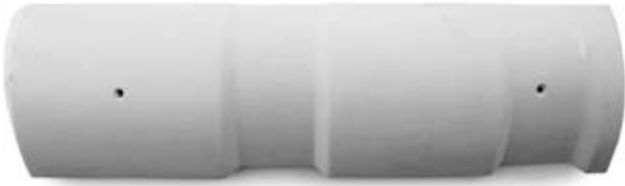

LH CORNER PANEL	65308	388305	
<ul style="list-style-type: none"> ● 3 TRUCK ★ CG/CP CH 1189449 - CH 4322041 			



RH CORNER PANEL	65307	388306	
<ul style="list-style-type: none"> ● 3 TRUCK ★ CG/CP CH 1189449 - CH 4322041 			



ALL THE COMPONENTS LISTED IN OUR CATALOGUE ARE NOT ORIGINAL, THOUGH PERFECTLY INTERCHANGEABLE. REFERENCE NUMBERS, EITHER ORIGINAL OR OF A DIFFERENT NATURE, ARE FOR INFORMATION PURPOSES ONLY. WHEN PLACING AN ORDER, PLEASE, ALWAYS USE COSIBO REFERENCE NUMBERS AND DO NOT MENTION THE ORIGINAL REFERENCE NUMBERS OF THE TRUCK MANUFACTURERS IN THE INVOICE TO VEHICLE OWNERS OR TO ANYBODY ELSE. THE CUSTOMER TAKES HIS OWN RESPONSIBILITY IF HE DOES NOT COMPLY WITH WHAT ABOVE.

LH AIR CONVEYORS



"This item may not be available on every market"

- Model
- ★ Application

Code	OEM new	OEM old
62100	1370329	

- 4 TRUCK
- ★ CR

RH AIR CONVEYORS



"This item may not be available on every market"

- 4 TRUCK
- ★ CR

62101	1370330	
-------	---------	--

ALL THE COMPONENTS LISTED IN OUR CATALOGUE ARE NOT ORIGINAL, THOUGH PERFECTLY INTERCHANGEABLE. REFERENCE NUMBERS, EITHER ORIGINAL OR OF A DIFFERENT NATURE, ARE FOR INFORMATION PURPOSES ONLY. WHEN PLACING AN ORDER, PLEASE, ALWAYS USE COSIBO REFERENCE NUMBERS AND DO NOT MENTION THE ORIGINAL REFERENCE NUMBERS OF THE TRUCK MANUFACTURERS IN THE INVOICE TO VEHICLE OWNERS OR TO ANYBODY ELSE. THE CUSTOMER TAKES HIS OWN RESPONSIBILITY IF HE DOES NOT COMPLY WITH WHAT ABOVE.

LH AIR CONVEYOR CORNER



- Model
- ★ Application

Code	OEM new	OEM old
62431	1381565	

- 4 TRUCK
- ★ CP

RH AIR CONVEYOR CORNER



- 4 TRUCK
- ★ CR

62430	1381566	
-------	---------	--

ALL THE COMPONENTS LISTED IN OUR CATALOGUE ARE NOT ORIGINAL, THOUGH PERFECTLY INTERCHANGEABLE. REFERENCE NUMBERS, EITHER ORIGINAL OR OF A DIFFERENT NATURE, ARE FOR INFORMATION PURPOSES ONLY. WHEN PLACING AN ORDER, PLEASE, ALWAYS USE COSIBO REFERENCE NUMBERS AND DO NOT MENTION THE ORIGINAL REFERENCE NUMBERS OF THE TRUCK MANUFACTURERS IN THE INVOICE TO VEHICLE OWNERS OR TO ANYBODY ELSE. THE CUSTOMER TAKES HIS OWN RESPONSIBILITY IF HE DOES NOT COMPLY WITH WHAT ABOVE.

LH AIR CONVEYOR COVER



- Model
- ★ Application

Code	OEM new	OEM old
62429	1382727	

- 4 TRUCK
- ★ CR

RH AIR CONVEYOR COVER



- 4 TRUCK
- ★ CR

62428	1382728	
-------	---------	--

ALL THE COMPONENTS LISTED IN OUR CATALOGUE ARE NOT ORIGINAL, THOUGH PERFECTLY INTERCHANGEABLE. REFERENCE NUMBERS, EITHER ORIGINAL OR OF A DIFFERENT NATURE, ARE FOR INFORMATION PURPOSES ONLY. WHEN PLACING AN ORDER, PLEASE, ALWAYS USE COSIBO REFERENCE NUMBERS AND DO NOT MENTION THE ORIGINAL REFERENCE NUMBERS OF THE TRUCK MANUFACTURERS IN THE INVOICE TO VEHICLE OWNERS OR TO ANYBODY ELSE. THE CUSTOMER TAKES HIS OWN RESPONSIBILITY IF HE DOES NOT COMPLY WITH WHAT ABOVE.

LH AIR CONVEYOR



"This item may not be available on every market"

- Model
- ★ Application

Code	OEM new	OEM old
62281	1386957	

- 4 TRUCK

- ★ CP

RH AIR CONVEYOR



"This item may not be available on every market"

- 4 TRUCK

- ★ CP

62282	1537675	1386958
-------	---------	---------

ALL THE COMPONENTS LISTED IN OUR CATALOGUE ARE NOT ORIGINAL, THOUGH PERFECTLY INTERCHANGEABLE. REFERENCE NUMBERS, EITHER ORIGINAL OR OF A DIFFERENT NATURE, ARE FOR INFORMATION PURPOSES ONLY. WHEN PLACING AN ORDER, PLEASE, ALWAYS USE COSIBO REFERENCE NUMBERS AND DO NOT MENTION THE ORIGINAL REFERENCE NUMBERS OF THE TRUCK MANUFACTURERS IN THE INVOICE TO VEHICLE OWNERS OR TO ANYBODY ELSE. THE CUSTOMER TAKES HIS OWN RESPONSIBILITY IF HE DOES NOT COMPLY WITH WHAT ABOVE.

LH AIR CONVEYOR CORNER



- Model
- ★ Application

Code	OEM new	OEM old
62446	1386959	

- 4 TRUCK
- ★ CP

RH AIR CONVEYOR CORNER



- 4 TRUCK
- ★ CP

62445	1386960	
-------	---------	--

ALL THE COMPONENTS LISTED IN OUR CATALOGUE ARE NOT ORIGINAL, THOUGH PERFECTLY INTERCHANGEABLE. REFERENCE NUMBERS, EITHER ORIGINAL OR OF A DIFFERENT NATURE, ARE FOR INFORMATION PURPOSES ONLY. WHEN PLACING AN ORDER, PLEASE, ALWAYS USE COSIBO REFERENCE NUMBERS AND DO NOT MENTION THE ORIGINAL REFERENCE NUMBERS OF THE TRUCK MANUFACTURERS IN THE INVOICE TO VEHICLE OWNERS OR TO ANYBODY ELSE. THE CUSTOMER TAKES HIS OWN RESPONSIBILITY IF HE DOES NOT COMPLY WITH WHAT ABOVE.

LH AIR CONVEYOR COVER



- Model
- ★ Application

Code	OEM new	OEM old
62448	1370107	

- 4 TRUCK
- ★ CP

RH AIR CONVEYOR COVER



- 4 TRUCK
- ★ CP

62447	1370108	
-------	---------	--

ALL THE COMPONENTS LISTED IN OUR CATALOGUE ARE NOT ORIGINAL, THOUGH PERFECTLY INTERCHANGEABLE. REFERENCE NUMBERS, EITHER ORIGINAL OR OF A DIFFERENT NATURE, ARE FOR INFORMATION PURPOSES ONLY. WHEN PLACING AN ORDER, PLEASE, ALWAYS USE COSIBO REFERENCE NUMBERS AND DO NOT MENTION THE ORIGINAL REFERENCE NUMBERS OF THE TRUCK MANUFACTURERS IN THE INVOICE TO VEHICLE OWNERS OR TO ANYBODY ELSE. THE CUSTOMER TAKES HIS OWN RESPONSIBILITY IF HE DOES NOT COMPLY WITH WHAT ABOVE.

LH AIR CONVEYOR SET



"This item may not be available on every market"

- Model
- ★ Application

	Code	OEM new	OEM old
	62449	62449	

- 4 TRUCK

★ CP COMPOSED BY: NO.1 PC 62281 - NO.1 PC 62448 - NO.1 PC 62446

RH AIR CONVEYOR SET



"This item may not be available on every market"

- 4 TRUCK

★ CP COMPOSED BY: NO.1 PC 62282 - NO.1 PC 62447 - NO.1 PC 62445

	62450	62450	
--	-------	-------	--

LH AIR CONVEYOR SET



"This item may not be available on every market"

- 4 TRUCK

★ CR COMPOSED BY NO.1 PC 62100 - NO.1 PC 62429 - NO.1 PC62431

	62498	62498	
--	-------	-------	--

ALL THE COMPONENTS LISTED IN OUR CATALOGUE ARE NOT ORIGINAL, THOUGH PERFECTLY INTERCHANGEABLE. REFERENCE NUMBERS, EITHER ORIGINAL OR OF A DIFFERENT NATURE, ARE FOR INFORMATION PURPOSES ONLY. WHEN PLACING AN ORDER, PLEASE, ALWAYS USE COSIBO REFERENCE NUMBERS AND DO NOT MENTION THE ORIGINAL REFERENCE NUMBERS OF THE TRUCK MANUFACTURERS IN THE INVOICE TO VEHICLE OWNERS OR TO ANYBODY ELSE. THE CUSTOMER TAKES HIS OWN RESPONSIBILITY IF HE DOES NOT COMPLY WITH WHAT ABOVE.

RH AIR CONVEYOR SET



"This item may not be available on every market"

	Code	OEM new	OEM old
● Model	62497	62497	
★ Application			
● 4 TRUCK			
★	CR COMPOSED BY NO.1 PC 62101 - NO.1 PC 62428 - NO.1 PC 62430		

LH AIR CONVEYORS



"This item may not be available on every market"

	62483	1538384	
● P-G-R-T TRUCK			
★	CG/CR CH 2040738 - CH 5211086 - CH 9135263 - CH 3635259		

ALL THE COMPONENTS LISTED IN OUR CATALOGUE ARE NOT ORIGINAL, THOUGH PERFECTLY INTERCHANGEABLE. REFERENCE NUMBERS, EITHER ORIGINAL OR OF A DIFFERENT NATURE, ARE FOR INFORMATION PURPOSES ONLY. WHEN PLACING AN ORDER, PLEASE, ALWAYS USE COSIBO REFERENCE NUMBERS AND DO NOT MENTION THE ORIGINAL REFERENCE NUMBERS OF THE TRUCK MANUFACTURERS IN THE INVOICE TO VEHICLE OWNERS OR TO ANYBODY ELSE. THE CUSTOMER TAKES HIS OWN RESPONSIBILITY IF HE DOES NOT COMPLY WITH WHAT ABOVE.

RH AIR CONVEYORS



"This item may not be available on every market"

- Model
- ★ Application

Code

OEM new

OEM old

62482

1538385

- P-G-R-T TRUCK

- ★ CG/CR CH 2040738 - CH 5211086 - CH 9135263 - CH 3635259

LH HINGE



62291

1726850

1381563
1440108

- 4 TRUCK

- ★ CP/CR

ALL THE COMPONENTS LISTED IN OUR CATALOGUE ARE NOT ORIGINAL, THOUGH PERFECTLY INTERCHANGEABLE. REFERENCE NUMBERS, EITHER ORIGINAL OR OF A DIFFERENT NATURE, ARE FOR INFORMATION PURPOSES ONLY. WHEN PLACING AN ORDER, PLEASE, ALWAYS USE COSIBO REFERENCE NUMBERS AND DO NOT MENTION THE ORIGINAL REFERENCE NUMBERS OF THE TRUCK MANUFACTURERS IN THE INVOICE TO VEHICLE OWNERS OR TO ANYBODY ELSE. THE CUSTOMER TAKES HIS OWN RESPONSIBILITY IF HE DOES NOT COMPLY WITH WHAT ABOVE.

RH HINGE



- Model
- ★ Application

Code

OEM new

OEM old

62292

1726851

1381564
1440113

- 4 TRUCK

- ★ CP/CR

LH AIR CONVEYORS



"This item may not be available on every market"

64207

1543608

- P-G-R-T TRUCK

- ★ CP

RH CORNER



"This item may not be available on every market"

- Model
- ★ Application

Code

OEM new

OEM old

64208

1543609

- P-G-R-T TRUCK

- ★ CP

LH AIR CONVEYOR CORNER



64680

1856475

1495956
1749716
1798863

- P-G-R-T TRUCK

- ★ CG/CR

ALL THE COMPONENTS LISTED IN OUR CATALOGUE ARE NOT ORIGINAL, THOUGH PERFECTLY INTERCHANGEABLE. REFERENCE NUMBERS, EITHER ORIGINAL OR OF A DIFFERENT NATURE, ARE FOR INFORMATION PURPOSES ONLY. WHEN PLACING AN ORDER, PLEASE, ALWAYS USE COSIBO REFERENCE NUMBERS AND DO NOT MENTION THE ORIGINAL REFERENCE NUMBERS OF THE TRUCK MANUFACTURERS IN THE INVOICE TO VEHICLE OWNERS OR TO ANYBODY ELSE. THE CUSTOMER TAKES HIS OWN RESPONSIBILITY IF HE DOES NOT COMPLY WITH WHAT ABOVE.

RH AIR CONVEYOR CORNER



- Model
- ★ Application

Code	OEM new	OEM old
64681	1856474	1495957 1749717 1798864

- P-G-R-T TRUCK
- ★ CG/CR

LH AIR CONVEYOR CORNER



- P-G-R-T TRUCK
- ★ CP

64329	1856473	1496293
-------	---------	---------

ALL THE COMPONENTS LISTED IN OUR CATALOGUE ARE NOT ORIGINAL, THOUGH PERFECTLY INTERCHANGEABLE. REFERENCE NUMBERS, EITHER ORIGINAL OR OF A DIFFERENT NATURE, ARE FOR INFORMATION PURPOSES ONLY. WHEN PLACING AN ORDER, PLEASE, ALWAYS USE COSIBO REFERENCE NUMBERS AND DO NOT MENTION THE ORIGINAL REFERENCE NUMBERS OF THE TRUCK MANUFACTURERS IN THE INVOICE TO VEHICLE OWNERS OR TO ANYBODY ELSE. THE CUSTOMER TAKES HIS OWN RESPONSIBILITY IF HE DOES NOT COMPLY WITH WHAT ABOVE.

RH AIR CONVEYOR CORNER



	Code	OEM new	OEM old
● Model	64330	1856472	1496294
★ Application			
● P-G-R-T TRUCK			
★ CP			

LH MUDGUARD PROFILE



	63961	1517649	1429393
● 4 TRUCK			
★ CP/CR - 164			
● P-G-R-T TRUCK			
★ CG/CP/CR			

RH MUDGUARD PROFILE



	63960	1517650	1429394
● 4 TRUCK			
★ CP/CR - 164			
● P-G-R-T TRUCK			
★ CG/CP/CR			

ALL THE COMPONENTS LISTED IN OUR CATALOGUE ARE NOT ORIGINAL, THOUGH PERFECTLY INTERCHANGEABLE. REFERENCE NUMBERS, EITHER ORIGINAL OR OF A DIFFERENT NATURE, ARE FOR INFORMATION PURPOSES ONLY. WHEN PLACING AN ORDER, PLEASE, ALWAYS USE COSIBO REFERENCE NUMBERS AND DO NOT MENTION THE ORIGINAL REFERENCE NUMBERS OF THE TRUCK MANUFACTURERS IN THE INVOICE TO VEHICLE OWNERS OR TO ANYBODY ELSE. THE CUSTOMER TAKES HIS OWN RESPONSIBILITY IF HE DOES NOT COMPLY WITH WHAT ABOVE.

	Code	OEM new	OEM old
RUBBER BUSHING	64114	1355667	
<ul style="list-style-type: none"> ● Model ★ Application 			
<ul style="list-style-type: none"> ● 4 TRUCK ★ CP/CR/CT 14/19 - CP/CR 19L - TOPLINE 			
<ul style="list-style-type: none"> ● P-G-R-T TRUCK ★ CP/CG/CR/CT NORMAL - LOW - CP/CR/CT LOW - CR19 HIGH - CR/CG HIGH - TOPLINE 			



SUN VISOR	61987	316756	330749
------------------	--------------	--------	--------



<ul style="list-style-type: none"> ● 3 TRUCK ★ 			
--	--	--	--

LH CABIN LIGHT	61602	301843	
-----------------------	--------------	--------	--





<ul style="list-style-type: none"> ● 3 TRUCK ★ 			
--	--	--	--

RH CAB LIGHT	61911	301844	
---------------------	--------------	--------	--



<ul style="list-style-type: none"> ● 3 TRUCK ★ 			
--	--	--	--

ALL THE COMPONENTS LISTED IN OUR CATALOGUE ARE NOT ORIGINAL, THOUGH PERFECTLY INTERCHANGEABLE. REFERENCE NUMBERS, EITHER ORIGINAL OR OF A DIFFERENT NATURE, ARE FOR INFORMATION PURPOSES ONLY. WHEN PLACING AN ORDER, PLEASE, ALWAYS USE COSIBO REFERENCE NUMBERS AND DO NOT MENTION THE ORIGINAL REFERENCE NUMBERS OF THE TRUCK MANUFACTURERS IN THE INVOICE TO VEHICLE OWNERS OR TO ANYBODY ELSE. THE CUSTOMER TAKES HIS OWN RESPONSIBILITY IF HE DOES NOT COMPLY WITH WHAT ABOVE.

	Code	OEM new	OEM old
RUBBER PAD 	62240	301845	
<ul style="list-style-type: none"> ● Model ★ Application 			
<ul style="list-style-type: none"> ● 3 TRUCK ★ 			
SUN VISOR WHITE LIGHT 	64069	199846	
<ul style="list-style-type: none"> ● 3 TRUCK ★ TOPLINE 			
SUNVISOR WITH 2 LAMPS  <p style="text-align: center;">"This item may not be available on every market"</p>	62407	1769452	1430533
<ul style="list-style-type: none"> ● 4 TRUCK ★ CP/CR/CT14 - CP/CR19L - CP/CR/CT19 ● P-G-R-T TRUCK ★ CG/CP/CR/CT STD - CG/CP/CR/CT LOW 			
SUN VISOR WITH SPOT LAMP HOLES  <p style="text-align: center;">"This item may not be available on every market"</p>	62496	1539870	1379814
<ul style="list-style-type: none"> ● 4 TRUCK ★ 8X8WLS/ZLS CR - CP/CR/CT 14/19 - CP/CR19L ● P-G-R-T TRUCK ★ CP/CR/CT STD AND LOW - CR 19 HIGH 			
SUN VISOR WITHOUT SPOT LAMP HOLES  <p style="text-align: center;">"This item may not be available on every market"</p>	62550	1539871	1355656
<ul style="list-style-type: none"> ● 4 TRUCK ★ 8X8WLS/ZLS CR - CP/CR/CT 14/19 - CP/CR19L ● P-G-R-T TRUCK ★ CP/CR/CT STD AND LOW - CR19 HIGH 			

ALL THE COMPONENTS LISTED IN OUR CATALOGUE ARE NOT ORIGINAL, THOUGH PERFECTLY INTERCHANGEABLE. REFERENCE NUMBERS, EITHER ORIGINAL OR OF A DIFFERENT NATURE, ARE FOR INFORMATION PURPOSES ONLY. WHEN PLACING AN ORDER, PLEASE, ALWAYS USE COSIBO REFERENCE NUMBERS AND DO NOT MENTION THE ORIGINAL REFERENCE NUMBERS OF THE TRUCK MANUFACTURERS IN THE INVOICE TO VEHICLE OWNERS OR TO ANYBODY ELSE. THE CUSTOMER TAKES HIS OWN RESPONSIBILITY IF HE DOES NOT COMPLY WITH WHAT ABOVE.

SUN VISOR



"This item may not be available on every market"

- Model
- ★ Application

Code

OEM new

OEM old

63733

1355655

- 4 TRUCK

- ★ 8X8WLS/ZLS CR - CP/CR/CT19 - CP/CR14 - CP/CR19L - TOP LINE

- P-G-R-T TRUCK

- ★ CP/CR/CT STD AND LOW - CR19 HIGH - CR19H - TOP LINE

BLUE LENS SPOT LAMP WITH LED



64684

64684

- 4 TRUCK

- ★

BLUE SPOT LAMP



62283

62283

- 4 TRUCK

- ★

WHITE SUN VISOR LIGHT



62341

1326935

- 4 TRUCK

- ★

- P-G-R-T TRUCK

- ★

ALL THE COMPONENTS LISTED IN OUR CATALOGUE ARE NOT ORIGINAL, THOUGH PERFECTLY INTERCHANGEABLE. REFERENCE NUMBERS, EITHER ORIGINAL OR OF A DIFFERENT NATURE, ARE FOR INFORMATION PURPOSES ONLY. WHEN PLACING AN ORDER, PLEASE, ALWAYS USE COSIBO REFERENCE NUMBERS AND DO NOT MENTION THE ORIGINAL REFERENCE NUMBERS OF THE TRUCK MANUFACTURERS IN THE INVOICE TO VEHICLE OWNERS OR TO ANYBODY ELSE. THE CUSTOMER TAKES HIS OWN RESPONSIBILITY IF HE DOES NOT COMPLY WITH WHAT ABOVE.

	Code	OEM new	OEM old
WHITE SUN VISOR LIGHT	64298	2035104	1910437 1798980
<ul style="list-style-type: none"> ● Model ★ Application 			
			
"This item may not be available on every market"			
<ul style="list-style-type: none"> ● P-G-R-T TRUCK ★ 			

AMBER SUN VISOR LIGHT	64299	2035105	1910438 1798981
			
"This item may not be available on every market"			
<ul style="list-style-type: none"> ● P-G-R-T TRUCK ★ 			

AMBER SUN VISOR LIGHT	64382	1372174	
			
<ul style="list-style-type: none"> ● 4 TRUCK ★ ● P-G-R-T TRUCK ★ 			

BULB HOLDER	64348	64348	
			
<ul style="list-style-type: none"> ● 4 TRUCK ★ FOR OUR 62341 & 64382 ● P-G-R-T TRUCK ★ FOR OUR 62341 & 64382 			

ALL THE COMPONENTS LISTED IN OUR CATALOGUE ARE NOT ORIGINAL, THOUGH PERFECTLY INTERCHANGEABLE. REFERENCE NUMBERS, EITHER ORIGINAL OR OF A DIFFERENT NATURE, ARE FOR INFORMATION PURPOSES ONLY. WHEN PLACING AN ORDER, PLEASE, ALWAYS USE COSIBO REFERENCE NUMBERS AND DO NOT MENTION THE ORIGINAL REFERENCE NUMBERS OF THE TRUCK MANUFACTURERS IN THE INVOICE TO VEHICLE OWNERS OR TO ANYBODY ELSE. THE CUSTOMER TAKES HIS OWN RESPONSIBILITY IF HE DOES NOT COMPLY WITH WHAT ABOVE.

	Code	OEM new	OEM old
SUN VISOR SPOT LAMP	62285	1749953	1379997 584085
● Model			
★ Application			
● 4 TRUCK			
★			
● P-G-R-T TRUCK			
★			



AIR DEFLECTOR	63680	1893533	1730221 1780585 1851989 588002
● 4 TRUCK			
★ 94 - 114 - 124 - 144 - 164 - CP/CR			



	Code	OEM new	OEM old
CLAMP D.6	64082	813933	
● Model			
★ Application			
● 3 BUS			
★			
● F-K-N BUS			
★			
● 3 TRUCK			
★			
● 4 TRUCK			
★			
● P-G-R-T TRUCK			
★			



CLAMP D.10	64083	813935	
● 4 BUS			
★			
● F-K-N BUS			
★			
● 3 TRUCK			
★			
● 4 TRUCK			
★			



CLAMP D. 16	64084	813937	
● 3 BUS			
★			
● 4 BUS			
★			
● F-K-N BUS			
★			
● 3 TRUCK			
★			



ALL THE COMPONENTS LISTED IN OUR CATALOGUE ARE NOT ORIGINAL, THOUGH PERFECTLY INTERCHANGEABLE. REFERENCE NUMBERS, EITHER ORIGINAL OR OF A DIFFERENT NATURE, ARE FOR INFORMATION PURPOSES ONLY. WHEN PLACING AN ORDER, PLEASE, ALWAYS USE COSIBO REFERENCE NUMBERS AND DO NOT MENTION THE ORIGINAL REFERENCE NUMBERS OF THE TRUCK MANUFACTURERS IN THE INVOICE TO VEHICLE OWNERS OR TO ANYBODY ELSE. THE CUSTOMER TAKES HIS OWN RESPONSIBILITY IF HE DOES NOT COMPLY WITH WHAT ABOVE.

	Code	OEM new	OEM old
CLAMP D.20	64085	813939	
	<ul style="list-style-type: none"> ● Model ★ Application 		
	<ul style="list-style-type: none"> ● 4 BUS ★ 		
	<ul style="list-style-type: none"> ● F-K-N BUS ★ 		
	<ul style="list-style-type: none"> ● 3 TRUCK ★ 		
	<ul style="list-style-type: none"> ● P-G-R-T TRUCK ★ 		

CLAMP D.25	64086	813941	
	<ul style="list-style-type: none"> ● 3 BUS ★ 		
	<ul style="list-style-type: none"> ● 4 BUS ★ 		
	<ul style="list-style-type: none"> ● F-K-N BUS ★ 		
	<ul style="list-style-type: none"> ● 3 TRUCK ★ 		
	<ul style="list-style-type: none"> ● P-G-R-T TRUCK ★ 		

ALL THE COMPONENTS LISTED IN OUR CATALOGUE ARE NOT ORIGINAL, THOUGH PERFECTLY INTERCHANGEABLE. REFERENCE NUMBERS, EITHER ORIGINAL OR OF A DIFFERENT NATURE, ARE FOR INFORMATION PURPOSES ONLY. WHEN PLACING AN ORDER, PLEASE, ALWAYS USE COSIBO REFERENCE NUMBERS AND DO NOT MENTION THE ORIGINAL REFERENCE NUMBERS OF THE TRUCK MANUFACTURERS IN THE INVOICE TO VEHICLE OWNERS OR TO ANYBODY ELSE. THE CUSTOMER TAKES HIS OWN RESPONSIBILITY IF HE DOES NOT COMPLY WITH WHAT ABOVE.

	Code	OEM new	OEM old
CLAMP D.5	64089	813932	
● Model			
★ Application			
● 3 BUS			
★			
● 4 BUS			
★			
● F-K-N BUS			
★			
● 4 TRUCK			
★			
● P-G-R-T TRUCK			
★			



	Code	OEM new	OEM old
CLAMP D.8	64090	813934	
● F-K-N BUS			
★			
● 3 TRUCK			
★			
● 4 TRUCK			
★			



ALL THE COMPONENTS LISTED IN OUR CATALOGUE ARE NOT ORIGINAL, THOUGH PERFECTLY INTERCHANGEABLE. REFERENCE NUMBERS, EITHER ORIGINAL OR OF A DIFFERENT NATURE, ARE FOR INFORMATION PURPOSES ONLY. WHEN PLACING AN ORDER, PLEASE, ALWAYS USE COSIBO REFERENCE NUMBERS AND DO NOT MENTION THE ORIGINAL REFERENCE NUMBERS OF THE TRUCK MANUFACTURERS IN THE INVOICE TO VEHICLE OWNERS OR TO ANYBODY ELSE. THE CUSTOMER TAKES HIS OWN RESPONSIBILITY IF HE DOES NOT COMPLY WITH WHAT ABOVE.

	Code	OEM new	OEM old
CLAMP D.13	64091	813936	
● Model			
★ Application			
● 3 BUS			
★			
● 4 BUS			
★			
● F-K-N BUS			
★			
● 3 TRUCK			
★			
● 4 TRUCK			
★			
● P-G-R-T TRUCK			
★			



	Code	OEM new	OEM old
CLAMP D.18	64092	813938	
● 4 BUS			
★			
● F-K-N BUS			
★			
● 3 TRUCK			
★			
● 4 TRUCK			
★			



ALL THE COMPONENTS LISTED IN OUR CATALOGUE ARE NOT ORIGINAL, THOUGH PERFECTLY INTERCHANGEABLE. REFERENCE NUMBERS, EITHER ORIGINAL OR OF A DIFFERENT NATURE, ARE FOR INFORMATION PURPOSES ONLY. WHEN PLACING AN ORDER, PLEASE, ALWAYS USE COSIBO REFERENCE NUMBERS AND DO NOT MENTION THE ORIGINAL REFERENCE NUMBERS OF THE TRUCK MANUFACTURERS IN THE INVOICE TO VEHICLE OWNERS OR TO ANYBODY ELSE. THE CUSTOMER TAKES HIS OWN RESPONSIBILITY IF HE DOES NOT COMPLY WITH WHAT ABOVE.

	Code	OEM new	OEM old
CLAMP D.22	64093	813940	
<ul style="list-style-type: none"> ● Model ★ Application 			
<ul style="list-style-type: none"> ● 4 BUS ★ 			
<ul style="list-style-type: none"> ● F-K-N BUS ★ 			
<ul style="list-style-type: none"> ● 3 TRUCK ★ 			
<ul style="list-style-type: none"> ● P-G-R-T TRUCK ★ 			



CLAMP D. 45	64094	813942	
<ul style="list-style-type: none"> ● 3 BUS ★ 			
<ul style="list-style-type: none"> ● F-K-N BUS ★ 			
<ul style="list-style-type: none"> ● 3 TRUCK ★ 			



CLAMP D.28	64095	804578	
<ul style="list-style-type: none"> ● F-K-N BUS ★ 			
<ul style="list-style-type: none"> ● 3 TRUCK ★ 			



ALL THE COMPONENTS LISTED IN OUR CATALOGUE ARE NOT ORIGINAL, THOUGH PERFECTLY INTERCHANGEABLE. REFERENCE NUMBERS, EITHER ORIGINAL OR OF A DIFFERENT NATURE, ARE FOR INFORMATION PURPOSES ONLY. WHEN PLACING AN ORDER, PLEASE, ALWAYS USE COSIBO REFERENCE NUMBERS AND DO NOT MENTION THE ORIGINAL REFERENCE NUMBERS OF THE TRUCK MANUFACTURERS IN THE INVOICE TO VEHICLE OWNERS OR TO ANYBODY ELSE. THE CUSTOMER TAKES HIS OWN RESPONSIBILITY IF HE DOES NOT COMPLY WITH WHAT ABOVE.

	Code	OEM new	OEM old
CLAMP D.35	64096	804589	
<ul style="list-style-type: none"> ● Model ★ Application 			
<ul style="list-style-type: none"> ● 4 BUS ★ 			
<ul style="list-style-type: none"> ● F-K-N BUS ★ 			
<ul style="list-style-type: none"> ● 3 TRUCK ★ 			
<ul style="list-style-type: none"> ● 4 TRUCK ★ 			



CLAMP D.32	64100	804583	
<ul style="list-style-type: none"> ● 4 BUS ★ 			
<ul style="list-style-type: none"> ● F-K-N BUS ★ 			
<ul style="list-style-type: none"> ● 3 TRUCK ★ 			
<ul style="list-style-type: none"> ● 4 TRUCK ★ 			
<ul style="list-style-type: none"> ● P-G-R-T TRUCK ★ 			



CLAMP D.38	64101	804591	
<ul style="list-style-type: none"> ● 4 BUS ★ 			
<ul style="list-style-type: none"> ● F-K-N BUS ★ 			
<ul style="list-style-type: none"> ● 3 TRUCK ★ 			



ALL THE COMPONENTS LISTED IN OUR CATALOGUE ARE NOT ORIGINAL, THOUGH PERFECTLY INTERCHANGEABLE. REFERENCE NUMBERS, EITHER ORIGINAL OR OF A DIFFERENT NATURE, ARE FOR INFORMATION PURPOSES ONLY. WHEN PLACING AN ORDER, PLEASE, ALWAYS USE COSIBO REFERENCE NUMBERS AND DO NOT MENTION THE ORIGINAL REFERENCE NUMBERS OF THE TRUCK MANUFACTURERS IN THE INVOICE TO VEHICLE OWNERS OR TO ANYBODY ELSE. THE CUSTOMER TAKES HIS OWN RESPONSIBILITY IF HE DOES NOT COMPLY WITH WHAT ABOVE.

RUBBER CAP



● Model
★ Application

Code

OEM new

OEM old

62220

303649

● 3 TRUCK

★

● 4 TRUCK

★

● P-G-R-T TRUCK

★

ALL THE COMPONENTS LISTED IN OUR CATALOGUE ARE NOT ORIGINAL, THOUGH PERFECTLY INTERCHANGEABLE. REFERENCE NUMBERS, EITHER ORIGINAL OR OF A DIFFERENT NATURE, ARE FOR INFORMATION PURPOSES ONLY. WHEN PLACING AN ORDER, PLEASE, ALWAYS USE COSIBO REFERENCE NUMBERS AND DO NOT MENTION THE ORIGINAL REFERENCE NUMBERS OF THE TRUCK MANUFACTURERS IN THE INVOICE TO VEHICLE OWNERS OR TO ANYBODY ELSE. THE CUSTOMER TAKES HIS OWN RESPONSIBILITY IF HE DOES NOT COMPLY WITH WHAT ABOVE.

AIR PRESSUR GAUGE 0 - 12 BAR



- Model
 - ★ Application
- | | Code | OEM new | OEM old |
|--|--------------|---------|---------|
| | 62436 | 62436 | |
- **ALL VEHICLES**
 - ★ ALL VEHICLES

TIRE INFLATING GUN



- | | | | |
|--|--------------|-------|--|
| | 65381 | 65381 | |
|--|--------------|-------|--|
- **ALL VEHICLES**
 - ★ ALL VEHICLES

ALL THE COMPONENTS LISTED IN OUR CATALOGUE ARE NOT ORIGINAL, THOUGH PERFECTLY INTERCHANGEABLE. REFERENCE NUMBERS, EITHER ORIGINAL OR OF A DIFFERENT NATURE, ARE FOR INFORMATION PURPOSES ONLY. WHEN PLACING AN ORDER, PLEASE, ALWAYS USE COSIBO REFERENCE NUMBERS AND DO NOT MENTION THE ORIGINAL REFERENCE NUMBERS OF THE TRUCK MANUFACTURERS IN THE INVOICE TO VEHICLE OWNERS OR TO ANYBODY ELSE. THE CUSTOMER TAKES HIS OWN RESPONSIBILITY IF HE DOES NOT COMPLY WITH WHAT ABOVE.

CAB LIFTING PUMP



	Code	OEM new	OEM old
● Model	62346	1549740	1422640 1534976
★ Application			

- 4 TRUCK
- ★ OSC11 G03 - CP/CR NORMAL/LOW - CR HIGH(TOPLINE) - CR 19T
- P-G-R-T TRUCK
- ★ CP/CR 19 NORMAL/LOW - CP/CR 16

CAB LIFTING PUMP



	Code	OEM new	OEM old
	62356	1314653	

- 3 TRUCK
- ★ STREAMLINE LHD

CAB LIFTING PUMP



	Code	OEM new	OEM old
	62406	1375497	1349010

- 4 TRUCK
- ★ 94 - 114 - 124 - 144 - 164

ALL THE COMPONENTS LISTED IN OUR CATALOGUE ARE NOT ORIGINAL, THOUGH PERFECTLY INTERCHANGEABLE. REFERENCE NUMBERS, EITHER ORIGINAL OR OF A DIFFERENT NATURE, ARE FOR INFORMATION PURPOSES ONLY. WHEN PLACING AN ORDER, PLEASE, ALWAYS USE COSIBO REFERENCE NUMBERS AND DO NOT MENTION THE ORIGINAL REFERENCE NUMBERS OF THE TRUCK MANUFACTURERS IN THE INVOICE TO VEHICLE OWNERS OR TO ANYBODY ELSE. THE CUSTOMER TAKES HIS OWN RESPONSIBILITY IF HE DOES NOT COMPLY WITH WHAT ABOVE.

CAB LIFTING PUMP



	Code	OEM new	OEM old
● Model	64110	1549741	1477877
★ Application			
● 4 TRUCK			
★ CR HIGH TOPOLINE - CR 19T			
● P-G-R-T TRUCK			
★ CR 19			

CAB LIFTING PUMP



	65446	1725376	
● P-G-R-T TRUCK			
★ CG/CP/CR16 - CR19 NL			

CAB LIFTING PUMP



	65073	1378527	368926
● 3 TRUCK			
★ 4 POINTS			

ALL THE COMPONENTS LISTED IN OUR CATALOGUE ARE NOT ORIGINAL, THOUGH PERFECTLY INTERCHANGEABLE. REFERENCE NUMBERS, EITHER ORIGINAL OR OF A DIFFERENT NATURE, ARE FOR INFORMATION PURPOSES ONLY. WHEN PLACING AN ORDER, PLEASE, ALWAYS USE COSIBO REFERENCE NUMBERS AND DO NOT MENTION THE ORIGINAL REFERENCE NUMBERS OF THE TRUCK MANUFACTURERS IN THE INVOICE TO VEHICLE OWNERS OR TO ANYBODY ELSE. THE CUSTOMER TAKES HIS OWN RESPONSIBILITY IF HE DOES NOT COMPLY WITH WHAT ABOVE.

CAB LIFTING PUMP



- Model
- ★ Application

Code	OEM new	OEM old
65074	1378531	383524

- 3 TRUCK
- ★ 2 POINTS

CAB LIFTING REPAIR SET



65468	1541978	
-------	---------	--

- 4 TRUCK
- ★ CR HIGH TOPLINE - CR 19T - FOR OUR 64110

- P-G-R-T TRUCK
- ★ CR 19 - FOR OUR 64110

CAB TILT.PUMP REP.SET

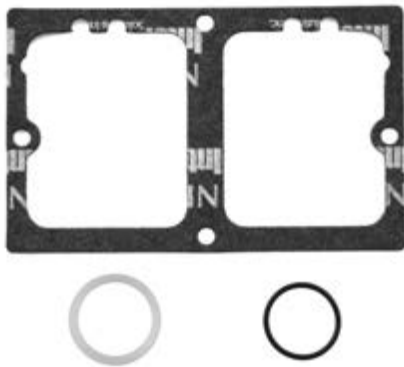

63938	1427794	
-------	---------	--

- 4 TRUCK
- ★ TO REPAIR OUR REFERENCES 62346 - 62356 - 65073 - 65074

- P-G-R-T TRUCK
- ★ TO REPAIR OUR REFERENCES 62346 - 62356 - 65073 - 65074

ALL THE COMPONENTS LISTED IN OUR CATALOGUE ARE NOT ORIGINAL, THOUGH PERFECTLY INTERCHANGEABLE. REFERENCE NUMBERS, EITHER ORIGINAL OR OF A DIFFERENT NATURE, ARE FOR INFORMATION PURPOSES ONLY. WHEN PLACING AN ORDER, PLEASE, ALWAYS USE COSIBO REFERENCE NUMBERS AND DO NOT MENTION THE ORIGINAL REFERENCE NUMBERS OF THE TRUCK MANUFACTURERS IN THE INVOICE TO VEHICLE OWNERS OR TO ANYBODY ELSE. THE CUSTOMER TAKES HIS OWN RESPONSIBILITY IF HE DOES NOT COMPLY WITH WHAT ABOVE.

	Code	OEM new	OEM old
CAB TILT.PUMP REP.SET	63942	1541984	1427793
<ul style="list-style-type: none"> ● Model ★ Application 			
<ul style="list-style-type: none"> ● 3 TRUCK ★ 4 POINTS CABIN - STREAMLINE - ALSO FOR RHD CH 1180589 - CH 4313040 - CH 1256268 - 1292232 - TO REPAIR OUR REFERENCES 62346 - 62356 - 65073 			
<ul style="list-style-type: none"> ● 4 TRUCK ★ CH 1256268 - 1292232 - TO REPAIR OUR REFERENCES 62346 - 62356 - 65073 			
<ul style="list-style-type: none"> ● P-G-R-T TRUCK ★ 			

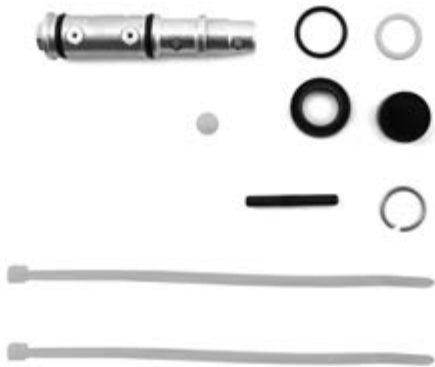

REPAIR SET	64437	1541984 1427794	
<ul style="list-style-type: none"> ● 3 TRUCK ★ 			
<ul style="list-style-type: none"> ● 4 TRUCK ★ 			
<ul style="list-style-type: none"> ● P-G-R-T TRUCK ★ 			



CABIN LIFTING CYLINDER	65316	1549739	1517325
<ul style="list-style-type: none"> ● 4 TRUCK ★ CP 			
<ul style="list-style-type: none"> ● P-G-R-T TRUCK ★ CP/CG/CR 			



ALL THE COMPONENTS LISTED IN OUR CATALOGUE ARE NOT ORIGINAL, THOUGH PERFECTLY INTERCHANGEABLE. REFERENCE NUMBERS, EITHER ORIGINAL OR OF A DIFFERENT NATURE, ARE FOR INFORMATION PURPOSES ONLY. WHEN PLACING AN ORDER, PLEASE, ALWAYS USE COSIBO REFERENCE NUMBERS AND DO NOT MENTION THE ORIGINAL REFERENCE NUMBERS OF THE TRUCK MANUFACTURERS IN THE INVOICE TO VEHICLE OWNERS OR TO ANYBODY ELSE. THE CUSTOMER TAKES HIS OWN RESPONSIBILITY IF HE DOES NOT COMPLY WITH WHAT ABOVE.

CAB LIFTING CYLINDER REPAIR SET

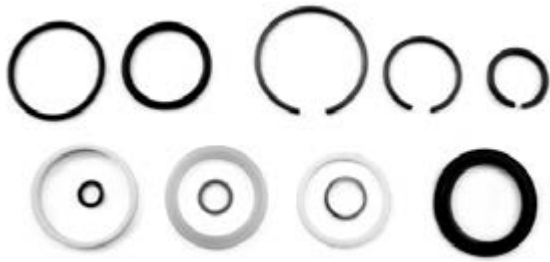

- Model
- ★ Application

Code	OEM new	OEM old
62334	1105803	

- 3 TRUCK



REP. SET FOR CAB TILTING HYDR.CYL.



- 3 TRUCK



62314	385840	
-------	--------	--

CAB LIFTING CYLINDER REPAIR SET

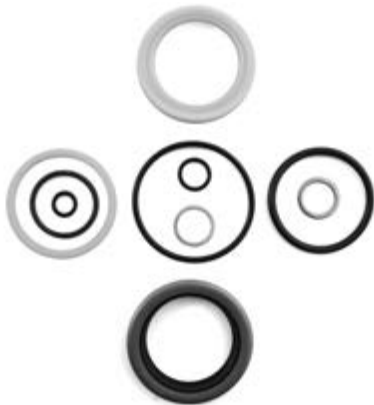

- 4 TRUCK



62455	1369053	
-------	---------	--

ALL THE COMPONENTS LISTED IN OUR CATALOGUE ARE NOT ORIGINAL, THOUGH PERFECTLY INTERCHANGEABLE. REFERENCE NUMBERS, EITHER ORIGINAL OR OF A DIFFERENT NATURE, ARE FOR INFORMATION PURPOSES ONLY. WHEN PLACING AN ORDER, PLEASE, ALWAYS USE COSIBO REFERENCE NUMBERS AND DO NOT MENTION THE ORIGINAL REFERENCE NUMBERS OF THE TRUCK MANUFACTURERS IN THE INVOICE TO VEHICLE OWNERS OR TO ANYBODY ELSE. THE CUSTOMER TAKES HIS OWN RESPONSIBILITY IF HE DOES NOT COMPLY WITH WHAT ABOVE.

	Code	OEM new	OEM old
CAB LIFTING CYLINDER REPAIR SET	62456	1433656	
<ul style="list-style-type: none"> ● Model ★ Application 			
<ul style="list-style-type: none"> ● 4 TRUCK ★ 			
<ul style="list-style-type: none"> ● P-G-R-T TRUCK ★ 			



CAB LIFTING CYLINDER REPAIR SET	62457	1541982	1433655
<ul style="list-style-type: none"> ● 4 TRUCK ★ 			
<ul style="list-style-type: none"> ● P-G-R-T TRUCK ★ 			



CAB LIFTING CYLINDER REPAIR SET	62458	1541983	1433654
<ul style="list-style-type: none"> ● 4 TRUCK ★ 			
<ul style="list-style-type: none"> ● P-G-R-T TRUCK ★ 			



CAB LIFTING CYLINDER REPAIR SET	62477	1524337	1501180
<ul style="list-style-type: none"> ● 4 TRUCK ★ 			
<ul style="list-style-type: none"> ● P-G-R-T TRUCK ★ 			



ALL THE COMPONENTS LISTED IN OUR CATALOGUE ARE NOT ORIGINAL, THOUGH PERFECTLY INTERCHANGEABLE. REFERENCE NUMBERS, EITHER ORIGINAL OR OF A DIFFERENT NATURE, ARE FOR INFORMATION PURPOSES ONLY. WHEN PLACING AN ORDER, PLEASE, ALWAYS USE COSIBO REFERENCE NUMBERS AND DO NOT MENTION THE ORIGINAL REFERENCE NUMBERS OF THE TRUCK MANUFACTURERS IN THE INVOICE TO VEHICLE OWNERS OR TO ANYBODY ELSE. THE CUSTOMER TAKES HIS OWN RESPONSIBILITY IF HE DOES NOT COMPLY WITH WHAT ABOVE.

	Code	OEM new	OEM old
CABIN LIFTING CYLINDER	64371	375350	575171
<ul style="list-style-type: none"> ● Model ★ Application 			
<ul style="list-style-type: none"> ● 3 TRUCK ★ CR 			



CABIN LIFTING CYLINDER	65434	375351	
<ul style="list-style-type: none"> ● 3 TRUCK ★ CG/CP 			



CABIN LIFTING CYLINDER	62357	1549738	1466506 1517324
<ul style="list-style-type: none"> ● 4 TRUCK ★ CR ● P-G-R-T TRUCK ★ CP/CG/CR 			



CABIN LIFTING CYLINDER	62476	1720924	
<ul style="list-style-type: none"> ● P-G-R-T TRUCK ★ CP/CG/CR - CR 19 			



ALL THE COMPONENTS LISTED IN OUR CATALOGUE ARE NOT ORIGINAL, THOUGH PERFECTLY INTERCHANGEABLE. REFERENCE NUMBERS, EITHER ORIGINAL OR OF A DIFFERENT NATURE, ARE FOR INFORMATION PURPOSES ONLY. WHEN PLACING AN ORDER, PLEASE, ALWAYS USE COSIBO REFERENCE NUMBERS AND DO NOT MENTION THE ORIGINAL REFERENCE NUMBERS OF THE TRUCK MANUFACTURERS IN THE INVOICE TO VEHICLE OWNERS OR TO ANYBODY ELSE. THE CUSTOMER TAKES HIS OWN RESPONSIBILITY IF HE DOES NOT COMPLY WITH WHAT ABOVE.

	Code	OEM new	OEM old
CABIN LIFTING CYLINDER	65445	1720925	



- Model
- ★ Application
- **P-G-R-T TRUCK**
- ★ CG/CP/CR - CR16 - CR19 N/L

CABIN LIFTING CYLINDER	64711	1549737	1477876
-------------------------------	--------------	---------	---------



- **4 TRUCK**
- ★ CR HIGH(TOPLINE) CH 1922233 - CH 4501310 - CH 9083649 - CH 3548541

CAB LIFTING LEVER	65317	1386571	
--------------------------	--------------	---------	--



- **4 TRUCK**
- ★ CP/CR LHD/RHD - 8X8 WLS
- **P-G-R-T TRUCK**
- ★ CG/CP/CR

CAB LIFTING LEVER	65318	1325626	
--------------------------	--------------	---------	--



- **3 BUS**
- ★
- **4 BUS**
- ★
- **F-K-N BUS**
- ★
- **3 TRUCK**
- ★
- **4 TRUCK**
- ★
- **P-G-R-T TRUCK**
- ★

ALL THE COMPONENTS LISTED IN OUR CATALOGUE ARE NOT ORIGINAL, THOUGH PERFECTLY INTERCHANGEABLE. REFERENCE NUMBERS, EITHER ORIGINAL OR OF A DIFFERENT NATURE, ARE FOR INFORMATION PURPOSES ONLY. WHEN PLACING AN ORDER, PLEASE, ALWAYS USE COSIBO REFERENCE NUMBERS AND DO NOT MENTION THE ORIGINAL REFERENCE NUMBERS OF THE TRUCK MANUFACTURERS IN THE INVOICE TO VEHICLE OWNERS OR TO ANYBODY ELSE. THE CUSTOMER TAKES HIS OWN RESPONSIBILITY IF HE DOES NOT COMPLY WITH WHAT ABOVE.

	Code	OEM new	OEM old
VIBRATION BUSHING	66584	1357380	
<ul style="list-style-type: none"> ● Model ★ Application 			
<ul style="list-style-type: none"> ● 4 TRUCK 			
<ul style="list-style-type: none"> ★ CP/CR - CR HIGH (TOPLINE) 			
<ul style="list-style-type: none"> ● P-G-R-T TRUCK 			
<ul style="list-style-type: none"> ★ CP/CG/CR 			



ADAPTOR	60361	1804064	1768694
<ul style="list-style-type: none"> ● 4 TRUCK 			
<ul style="list-style-type: none"> ★ OSC11 G03 - CP/CR NORMAL/LOW - CR HIGH(TOPLINE) - CR 19T 			
<ul style="list-style-type: none"> ● P-G-R-T TRUCK 			
<ul style="list-style-type: none"> ★ CP/CR 19 NORMAL/LOW - CP/CR 16 			



CABIN HOSE	62324/1	IT7085	1526569 1371200
<ul style="list-style-type: none"> ● 4 TRUCK 			
<ul style="list-style-type: none"> ★ CP/CR STD LOW - CR HIGH TOPLINE - 8X4 			



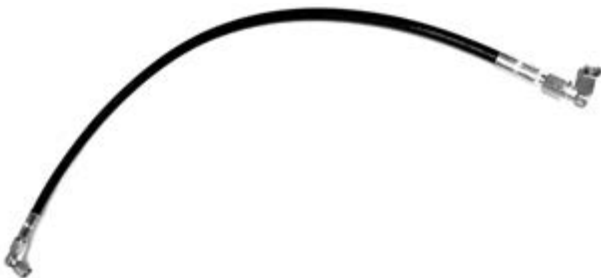

CABIN HOSE	62324/2	IT7086	1526571 1371207
<ul style="list-style-type: none"> ● 4 TRUCK 			
<ul style="list-style-type: none"> ★ CP/CR STD LOW - CR HIGH TOPLINE - 8X4 			



ALL THE COMPONENTS LISTED IN OUR CATALOGUE ARE NOT ORIGINAL, THOUGH PERFECTLY INTERCHANGEABLE. REFERENCE NUMBERS, EITHER ORIGINAL OR OF A DIFFERENT NATURE, ARE FOR INFORMATION PURPOSES ONLY. WHEN PLACING AN ORDER, PLEASE, ALWAYS USE COSIBO REFERENCE NUMBERS AND DO NOT MENTION THE ORIGINAL REFERENCE NUMBERS OF THE TRUCK MANUFACTURERS IN THE INVOICE TO VEHICLE OWNERS OR TO ANYBODY ELSE. THE CUSTOMER TAKES HIS OWN RESPONSIBILITY IF HE DOES NOT COMPLY WITH WHAT ABOVE.

	Code	OEM new	OEM old
CABIN HOSE	62324/3	IT7088	1851213 1371208 1526572
<ul style="list-style-type: none"> ● Model ★ Application 			
			
<ul style="list-style-type: none"> ● 4 TRUCK ★ CP/CR STD LOW - CR HIGH TOPLINE - 8X4 			

CABIN HOSE	62324/4	IT7087	1371201 1526570
<ul style="list-style-type: none"> ● 4 TRUCK ★ CP/CR STD LOW - CR HIGH TOPLINE - 8X4 			
			

CABIN HOSE	62324/5	IT7084	1526573 1426339
<ul style="list-style-type: none"> ● 4 TRUCK ★ CP/CR STD LOW - CR HIGH TOPLINE - 8X4 			
			

ALL THE COMPONENTS LISTED IN OUR CATALOGUE ARE NOT ORIGINAL, THOUGH PERFECTLY INTERCHANGEABLE. REFERENCE NUMBERS, EITHER ORIGINAL OR OF A DIFFERENT NATURE, ARE FOR INFORMATION PURPOSES ONLY. WHEN PLACING AN ORDER, PLEASE, ALWAYS USE COSIBO REFERENCE NUMBERS AND DO NOT MENTION THE ORIGINAL REFERENCE NUMBERS OF THE TRUCK MANUFACTURERS IN THE INVOICE TO VEHICLE OWNERS OR TO ANYBODY ELSE. THE CUSTOMER TAKES HIS OWN RESPONSIBILITY IF HE DOES NOT COMPLY WITH WHAT ABOVE.

	Code	OEM new	OEM old
CABIN HOSE SET	62324	62324	
<ul style="list-style-type: none"> ● Model ★ Application 			
<ul style="list-style-type: none"> ● 4 TRUCK ★ CP/CR STD LOW - CR HIGH TOPLINE - 8X4 COMPOSED BY: NO.1 PC 62324/1 - NO.1 PC 62324/2 - NO.1 PC 62324/3 - NO.1 PC 62324/4 - NO.1 PC 62324/5 			



CABIN HOSE	65447	1851248	1767479
<ul style="list-style-type: none"> ● 4 TRUCK ★ CP14 			
<ul style="list-style-type: none"> ● P-G-R-T TRUCK ★ CG/CP14 - CG/CP14 LH 			



RUBBER HOSE	64356	1790071	
<ul style="list-style-type: none"> ● P-G-R-T TRUCK ★ CG/CP/CR 			



ALL THE COMPONENTS LISTED IN OUR CATALOGUE ARE NOT ORIGINAL, THOUGH PERFECTLY INTERCHANGEABLE. REFERENCE NUMBERS, EITHER ORIGINAL OR OF A DIFFERENT NATURE, ARE FOR INFORMATION PURPOSES ONLY. WHEN PLACING AN ORDER, PLEASE, ALWAYS USE COSIBO REFERENCE NUMBERS AND DO NOT MENTION THE ORIGINAL REFERENCE NUMBERS OF THE TRUCK MANUFACTURERS IN THE INVOICE TO VEHICLE OWNERS OR TO ANYBODY ELSE. THE CUSTOMER TAKES HIS OWN RESPONSIBILITY IF HE DOES NOT COMPLY WITH WHAT ABOVE.

	Code	OEM new	OEM old
RUBBER HOSE	64295	1385836	1380264

- Model
 - ★ Application
-
- 4 TRUCK
 - ★ DC9 11/12/14 CP/CR



RUBBER HOSE	64296	1532223	1425599
--------------------	--------------	---------	---------

- 4 TRUCK
- ★ DC9 11/12/14 CP/CR - DC16 CR







RUBBER HOSE	64297	288893	
--------------------	--------------	--------	--

- 4 TRUCK
- ★ D11/D12/D14 CP/CR/CT



ALL THE COMPONENTS LISTED IN OUR CATALOGUE ARE NOT ORIGINAL, THOUGH PERFECTLY INTERCHANGEABLE. REFERENCE NUMBERS, EITHER ORIGINAL OR OF A DIFFERENT NATURE, ARE FOR INFORMATION PURPOSES ONLY. WHEN PLACING AN ORDER, PLEASE, ALWAYS USE COSIBO REFERENCE NUMBERS AND DO NOT MENTION THE ORIGINAL REFERENCE NUMBERS OF THE TRUCK MANUFACTURERS IN THE INVOICE TO VEHICLE OWNERS OR TO ANYBODY ELSE. THE CUSTOMER TAKES HIS OWN RESPONSIBILITY IF HE DOES NOT COMPLY WITH WHAT ABOVE.

	Code	OEM new	OEM old
WIPER BLADE 	63866	1742920	1323416
<ul style="list-style-type: none"> ● Model ★ Application 			
<ul style="list-style-type: none"> ● 3 TRUCK ★ 			
WIPER BLADE 	63882	1541106	1431178
<ul style="list-style-type: none"> ● 4 TRUCK ★ 			
<ul style="list-style-type: none"> ● P-G-R-T TRUCK ★ 			
WIPER ARM 	64373	1864620	1380034 1431177 1543076 1751403
<ul style="list-style-type: none"> ● 4 TRUCK ★ CP/CR/CT 			
<ul style="list-style-type: none"> ● P-G-R-T TRUCK ★ 			
WINDSCREEN WIPER LEVER HOUSING 	62376	1323400	
<ul style="list-style-type: none"> ● 3 TRUCK ★ STREAMLINE 			

ALL THE COMPONENTS LISTED IN OUR CATALOGUE ARE NOT ORIGINAL, THOUGH PERFECTLY INTERCHANGEABLE. REFERENCE NUMBERS, EITHER ORIGINAL OR OF A DIFFERENT NATURE, ARE FOR INFORMATION PURPOSES ONLY. WHEN PLACING AN ORDER, PLEASE, ALWAYS USE COSIBO REFERENCE NUMBERS AND DO NOT MENTION THE ORIGINAL REFERENCE NUMBERS OF THE TRUCK MANUFACTURERS IN THE INVOICE TO VEHICLE OWNERS OR TO ANYBODY ELSE. THE CUSTOMER TAKES HIS OWN RESPONSIBILITY IF HE DOES NOT COMPLY WITH WHAT ABOVE.

	Code	OEM new	OEM old
WINDSCREEN WIPER LEVER	62377	1323410	
<ul style="list-style-type: none"> ● Model ★ Application 			
<ul style="list-style-type: none"> ● 3 TRUCK ★ STEAMLINE 			



WINDSCREEN WIPER LINK ASSY	62372	1323401	
<ul style="list-style-type: none"> ● 3 TRUCK ★ STREAMLINE 			



WINDSCREEN WIPER LINK	62373	1353735	
<ul style="list-style-type: none"> ● 3 TRUCK ★ STREAMLINE 			



WINDSCREEN WIPER LINK	63365	288212	
<ul style="list-style-type: none"> ● 2 TRUCK ★ 92 - 112 - 142 ● 3 TRUCK ★ 93 - 113 - 143 1ST SERIES 			



WINDSCREEN WIPER LINK	63366	288213	
<ul style="list-style-type: none"> ● 2 TRUCK ★ 92 - 112 - 142 ● 3 TRUCK ★ 93 - 113 - 143 1ST SERIES 			



ALL THE COMPONENTS LISTED IN OUR CATALOGUE ARE NOT ORIGINAL, THOUGH PERFECTLY INTERCHANGEABLE. REFERENCE NUMBERS, EITHER ORIGINAL OR OF A DIFFERENT NATURE, ARE FOR INFORMATION PURPOSES ONLY. WHEN PLACING AN ORDER, PLEASE, ALWAYS USE COSIBO REFERENCE NUMBERS AND DO NOT MENTION THE ORIGINAL REFERENCE NUMBERS OF THE TRUCK MANUFACTURERS IN THE INVOICE TO VEHICLE OWNERS OR TO ANYBODY ELSE. THE CUSTOMER TAKES HIS OWN RESPONSIBILITY IF HE DOES NOT COMPLY WITH WHAT ABOVE.

WINDSCREEN WIPER LINK



- Model
- ★ Application

Code	OEM new	OEM old
63367	288214	

- 2 TRUCK
- ★ 92 - 112 - 142
- 3 TRUCK
- ★ 93 - 113 - 143 1ST SERIES

LH WINDSCREEN WIPER LEVER HOUSING



- 2 TRUCK
- ★ 92 - 112 - 142
- 3 TRUCK
- ★ 93 - 113 - 143 1ST SERIES

62370	375904	288208
-------	--------	--------

RH WINDSCREEN WIPER LEVER HOUSING



- 2 TRUCK
- ★ 92 - 112 - 142
- 3 TRUCK
- ★ 93 - 113 - 143 1ST SERIES

62369	375903	288207
-------	--------	--------

ALL THE COMPONENTS LISTED IN OUR CATALOGUE ARE NOT ORIGINAL, THOUGH PERFECTLY INTERCHANGEABLE. REFERENCE NUMBERS, EITHER ORIGINAL OR OF A DIFFERENT NATURE, ARE FOR INFORMATION PURPOSES ONLY. WHEN PLACING AN ORDER, PLEASE, ALWAYS USE COSIBO REFERENCE NUMBERS AND DO NOT MENTION THE ORIGINAL REFERENCE NUMBERS OF THE TRUCK MANUFACTURERS IN THE INVOICE TO VEHICLE OWNERS OR TO ANYBODY ELSE. THE CUSTOMER TAKES HIS OWN RESPONSIBILITY IF HE DOES NOT COMPLY WITH WHAT ABOVE.

CENTRAL WINDSCREEN WIPER LEVER HOUSING



	Code	OEM new	OEM old
● Model	62371	375905	288209
★ Application			
● 2 TRUCK			
★ 92 - 112 - 142			
● 3 TRUCK			
★ 93 - 113 - 143 1ST SERIES			

WINDSCREEN WIPER LINK



	63362	1525890	1358288
● 4 TRUCK			
★ CP/CR/CT 94 - 114 - 124 - 144 - 164			
● P-G-R-T TRUCK			
★			

WINDSCREEN WIPER LINK



	63363	1525888	1358289
● 4 TRUCK			
★ CP/CR/CT 94 - 114 - 124 - 144 - 164			
● P-G-R-T TRUCK			
★			

WINDSCREEN WIPER LINK (FOR RIGHT HAND DRIVE)



	63364	1525889	1358290
● 4 TRUCK			
★ CP/CR/CT 94 - 114 - 124 - 144 - 164			
● P-G-R-T TRUCK			
★			

ALL THE COMPONENTS LISTED IN OUR CATALOGUE ARE NOT ORIGINAL, THOUGH PERFECTLY INTERCHANGEABLE. REFERENCE NUMBERS, EITHER ORIGINAL OR OF A DIFFERENT NATURE, ARE FOR INFORMATION PURPOSES ONLY. WHEN PLACING AN ORDER, PLEASE, ALWAYS USE COSIBO REFERENCE NUMBERS AND DO NOT MENTION THE ORIGINAL REFERENCE NUMBERS OF THE TRUCK MANUFACTURERS IN THE INVOICE TO VEHICLE OWNERS OR TO ANYBODY ELSE. THE CUSTOMER TAKES HIS OWN RESPONSIBILITY IF HE DOES NOT COMPLY WITH WHAT ABOVE.

WINDSCREEN WIPER LEVER



	Code	OEM new	OEM old
● Model	62375	1358291	1525887
★ Application			
● 4 TRUCK			
★ CP/CR/CT 94 - 114 - 124 - 144 - 164			
● P-G-R-T TRUCK			
★			

LH WINDSCREEN WIPER LEVER HOUSING



	623761	1525891	1337957
● 4 TRUCK			
★ CP/CR/CT 94 - 114 - 124 - 144 - 164			
● P-G-R-T TRUCK			
★			

RH WINDSCREEN WIPER LEVER HOUSING



	62374	1525892	1337958
● 4 TRUCK			
★ CP/CR/CT 94 - 114 - 124 - 144 - 164			
● P-G-R-T TRUCK			
★			

ALL THE COMPONENTS LISTED IN OUR CATALOGUE ARE NOT ORIGINAL, THOUGH PERFECTLY INTERCHANGEABLE. REFERENCE NUMBERS, EITHER ORIGINAL OR OF A DIFFERENT NATURE, ARE FOR INFORMATION PURPOSES ONLY. WHEN PLACING AN ORDER, PLEASE, ALWAYS USE COSIBO REFERENCE NUMBERS AND DO NOT MENTION THE ORIGINAL REFERENCE NUMBERS OF THE TRUCK MANUFACTURERS IN THE INVOICE TO VEHICLE OWNERS OR TO ANYBODY ELSE. THE CUSTOMER TAKES HIS OWN RESPONSIBILITY IF HE DOES NOT COMPLY WITH WHAT ABOVE.

WASHER TANK



	Code	OEM new	OEM old
● Model	64722	1722694	1506330
★ Application			

● 4 TRUCK
★ CP/CR/CT

CAP



	62512	1371839	295960
● 3 TRUCK			
★			
● 4 BUS			
★ CL/CN			
● 4 TRUCK			
★ CP/CR/CT			
● F-K-N BUS			
★ CK/CNUB - CN UD - IKIB			
● P-G-R-T TRUCK			
★			

● 3 TRUCK
★
● 4 BUS
★ CL/CN
● 4 TRUCK
★ CP/CR/CT
● F-K-N BUS
★ CK/CNUB - CN UD - IKIB
● P-G-R-T TRUCK
★

WINDSCREEN WASHER PUMP



	64509	1395994	353546
● 3 TRUCK			
★			
● 4 BUS			
★ CL/CN			
● F-K-N BUS			
★ CK/CNUB/CNUD - IKIB			

● 3 TRUCK
★
● 4 BUS
★ CL/CN
● F-K-N BUS
★ CK/CNUB/CNUD - IKIB

ALL THE COMPONENTS LISTED IN OUR CATALOGUE ARE NOT ORIGINAL, THOUGH PERFECTLY INTERCHANGEABLE. REFERENCE NUMBERS, EITHER ORIGINAL OR OF A DIFFERENT NATURE, ARE FOR INFORMATION PURPOSES ONLY. WHEN PLACING AN ORDER, PLEASE, ALWAYS USE COSIBO REFERENCE NUMBERS AND DO NOT MENTION THE ORIGINAL REFERENCE NUMBERS OF THE TRUCK MANUFACTURERS IN THE INVOICE TO VEHICLE OWNERS OR TO ANYBODY ELSE. THE CUSTOMER TAKES HIS OWN RESPONSIBILITY IF HE DOES NOT COMPLY WITH WHAT ABOVE.

WINDSCREEN WASHER PUMP



	Code	OEM new	OEM old
● Model ★ Application	62475	1548504	
● 4 TRUCK			
★ CP/CR/CT			
● P-G-R-T TRUCK			
★			

5 POLE WIPER MOTOR



	Code	OEM new	OEM old
	64052	1318506	
● 4 TRUCK			
★ CH UP TO 1224448 - CH UP TO 4367630 - CH UP TO 9018490			

6 POLE WIPER MOTOR



	Code	OEM new	OEM old
	64053	1858661	1392755
● 4 TRUCK			
★ CH FROM 1224449 - CH FROM 4367631 - CH FROM 9018491			

ALL THE COMPONENTS LISTED IN OUR CATALOGUE ARE NOT ORIGINAL, THOUGH PERFECTLY INTERCHANGEABLE. REFERENCE NUMBERS, EITHER ORIGINAL OR OF A DIFFERENT NATURE, ARE FOR INFORMATION PURPOSES ONLY. WHEN PLACING AN ORDER, PLEASE, ALWAYS USE COSIBO REFERENCE NUMBERS AND DO NOT MENTION THE ORIGINAL REFERENCE NUMBERS OF THE TRUCK MANUFACTURERS IN THE INVOICE TO VEHICLE OWNERS OR TO ANYBODY ELSE. THE CUSTOMER TAKES HIS OWN RESPONSIBILITY IF HE DOES NOT COMPLY WITH WHAT ABOVE.

		Code	OEM new	OEM old
SWITCH	● Model	62520	1488067	353626
	★ Application			
	● 3 BUS			
	★			
	● 4 BUS			
	★			
	● 3 TRUCK			
	★			
	● 4 TRUCK			
	★			



RELAY		63447	2077837	1431781 1391322 243460
	● F-K-N BUS			
	★ IKIB			
	● 3 TRUCK			
	★			
	● 4 TRUCK			
	★ CP/CR/CT - ADR - WEBASTO ADR			
	● P-G-R-T TRUCK			
	★			





SWITCH		65176	1350317	
	● 3 BUS			
	★ GR801R WITH RETARDER WITH ABS			
	● 3 TRUCK			
	★ GR/GRS900R WITH RETARDER			
	● 4 TRUCK			
	★ GRS890R 8X8 WLS/ZLS - GRS900R - R124 8X8 WLS/ZLS			



ALL THE COMPONENTS LISTED IN OUR CATALOGUE ARE NOT ORIGINAL, THOUGH PERFECTLY INTERCHANGEABLE. REFERENCE NUMBERS, EITHER ORIGINAL OR OF A DIFFERENT NATURE, ARE FOR INFORMATION PURPOSES ONLY. WHEN PLACING AN ORDER, PLEASE, ALWAYS USE COSIBO REFERENCE NUMBERS AND DO NOT MENTION THE ORIGINAL REFERENCE NUMBERS OF THE TRUCK MANUFACTURERS IN THE INVOICE TO VEHICLE OWNERS OR TO ANYBODY ELSE. THE CUSTOMER TAKES HIS OWN RESPONSIBILITY IF HE DOES NOT COMPLY WITH WHAT ABOVE.

		Code	OEM new	OEM old
SWITCH	● Model	62276	1363131	1328177 290950
	★ Application			
	● 3 BUS			
	★			
	● 3 TRUCK			
	★ P113 ML/HL 4X2 6X2			

SPEED SENSOR	65186	1853436	1111459
	● 3 BUS		
	★		
	● 3 TRUCK		
	★ GR871 - GRS900 - GR880		
	● 4 BUS		
	★ GR801R		
	● 4 TRUCK		
	★ 94 - 114 - 124 - 144 - 164		
	● P-G-R-T TRUCK		
	★ GR801		

OIL PRESSURE MONITOR	62295	1434135	
	● 3 TRUCK		
	★ G/P/R/T 93 - P/R/T 113/143 GRS900 GA/GAE770/774		
	● 4 TRUCK		
	★ 94 - 114 - 124 - 144 - 164		

ALL THE COMPONENTS LISTED IN OUR CATALOGUE ARE NOT ORIGINAL, THOUGH PERFECTLY INTERCHANGEABLE. REFERENCE NUMBERS, EITHER ORIGINAL OR OF A DIFFERENT NATURE, ARE FOR INFORMATION PURPOSES ONLY. WHEN PLACING AN ORDER, PLEASE, ALWAYS USE COSIBO REFERENCE NUMBERS AND DO NOT MENTION THE ORIGINAL REFERENCE NUMBERS OF THE TRUCK MANUFACTURERS IN THE INVOICE TO VEHICLE OWNERS OR TO ANYBODY ELSE. THE CUSTOMER TAKES HIS OWN RESPONSIBILITY IF HE DOES NOT COMPLY WITH WHAT ABOVE.

	Code	OEM new	OEM old
SWITCH	63604	1488066	353621
<ul style="list-style-type: none"> ● Model ★ Application 			
<ul style="list-style-type: none"> ● 3 TRUCK ★ 			
<ul style="list-style-type: none"> ● 4 TRUCK ★ 94 - 114 - 124 - 144 - 164 			



WATER VALVE	64180	1741027	1503790
<ul style="list-style-type: none"> ● 4 TRUCK ★ ETC 			
<ul style="list-style-type: none"> ● P-G-R-T TRUCK ★ CP/CR/CT 			



WATER VALVE	64448	1793197	
<ul style="list-style-type: none"> ● P-G-R-T TRUCK ★ CG/CP/CR 			





SWITCH	64134	1327015	
<ul style="list-style-type: none"> ● 4 BUS ★ 			
<ul style="list-style-type: none"> ● 4 TRUCK ★ 			



ALL THE COMPONENTS LISTED IN OUR CATALOGUE ARE NOT ORIGINAL, THOUGH PERFECTLY INTERCHANGEABLE. REFERENCE NUMBERS, EITHER ORIGINAL OR OF A DIFFERENT NATURE, ARE FOR INFORMATION PURPOSES ONLY. WHEN PLACING AN ORDER, PLEASE, ALWAYS USE COSIBO REFERENCE NUMBERS AND DO NOT MENTION THE ORIGINAL REFERENCE NUMBERS OF THE TRUCK MANUFACTURERS IN THE INVOICE TO VEHICLE OWNERS OR TO ANYBODY ELSE. THE CUSTOMER TAKES HIS OWN RESPONSIBILITY IF HE DOES NOT COMPLY WITH WHAT ABOVE.

		Code	OEM new	OEM old
SWITCH	● Model	64493	353623	
	★ Application			
	● 3 TRUCK			
	★			
	● 4 TRUCK			
	★ 94 - 114 - 124 - 144 - 164			

SWITCH		64859	353625	
	● 3 TRUCK			
	★			
	● 4 TRUCK			
	★			

SWITCH		61137	365015	
	● 3 BUS			
	★			
	● 3 TRUCK			
	★			
	● 4 BUS			
	★			
	● 4 TRUCK			
	★ 94 - 114 - 124 - 144 - 164			

TANK LEVEL MONITOR		63644	1434134	1423207
	● 3 TRUCK			
	★ G/P/R/T 93 - P/R/T 113/143 GRS900 GA/GAE770/774			
	● 4 TRUCK			
	★ 94 - 114 - 124 - 144 - 164			





ALL THE COMPONENTS LISTED IN OUR CATALOGUE ARE NOT ORIGINAL, THOUGH PERFECTLY INTERCHANGEABLE. REFERENCE NUMBERS, EITHER ORIGINAL OR OF A DIFFERENT NATURE, ARE FOR INFORMATION PURPOSES ONLY. WHEN PLACING AN ORDER, PLEASE, ALWAYS USE COSIBO REFERENCE NUMBERS AND DO NOT MENTION THE ORIGINAL REFERENCE NUMBERS OF THE TRUCK MANUFACTURERS IN THE INVOICE TO VEHICLE OWNERS OR TO ANYBODY ELSE. THE CUSTOMER TAKES HIS OWN RESPONSIBILITY IF HE DOES NOT COMPLY WITH WHAT ABOVE.

IMPULSE SENSOR



	Code	OEM new	OEM old
● Model	62530	1852113	1742947
★ Application			
● 4 TRUCK			
★			
● P-G-R-T TRUCK			
★			
● 3 BUS			
★			
● 4 BUS			
★			
● F-K-N BUS			
★			

ALL THE COMPONENTS LISTED IN OUR CATALOGUE ARE NOT ORIGINAL, THOUGH PERFECTLY INTERCHANGEABLE. REFERENCE NUMBERS, EITHER ORIGINAL OR OF A DIFFERENT NATURE, ARE FOR INFORMATION PURPOSES ONLY. WHEN PLACING AN ORDER, PLEASE, ALWAYS USE COSIBO REFERENCE NUMBERS AND DO NOT MENTION THE ORIGINAL REFERENCE NUMBERS OF THE TRUCK MANUFACTURERS IN THE INVOICE TO VEHICLE OWNERS OR TO ANYBODY ELSE. THE CUSTOMER TAKES HIS OWN RESPONSIBILITY IF HE DOES NOT COMPLY WITH WHAT ABOVE.

	Code	OEM new	OEM old
<p>GAS SPRING</p> 	61621	353592	341299
<ul style="list-style-type: none"> ● Model ★ Application 			
<ul style="list-style-type: none"> ● 3 TRUCK ★ CG/CP/CR 			
<p>GAS SPRING</p> 	62395	1374642	
<ul style="list-style-type: none"> ● 4 TRUCK ★ CP/CR CH 1232869 - CH 1232870 - CH 4381208 - CH 4381209 - CH 9026437 - CH 9026438 			
<p>GAS SPRING</p> 	63620	1306492	
<ul style="list-style-type: none"> ● 4 TRUCK ★ CP LHD CH 1230214 - CH 1230215 - CH 4376384 - CH 4376385 - CH 9023916 - CH 9023917 - CR LHD CH 1227495 - CH 1227496 - CH 4371633 - CH 4371634 - CH 9021602 - CH 9021603 - CP/CR RHD CH 1233807 - CH 1233808 - CH 4382181 - CH 4382182 - CH 9027043 - CH 9027044 			
<p>GAS SPRING</p> 	64049	1331164	
<ul style="list-style-type: none"> ● 3 TRUCK ★ STREAMLINE 			
<p>GAS SPRING</p> 	64060	1481371	
<ul style="list-style-type: none"> ● P-G-R-T TRUCK ★ CG/CR 			

ALL THE COMPONENTS LISTED IN OUR CATALOGUE ARE NOT ORIGINAL, THOUGH PERFECTLY INTERCHANGEABLE. REFERENCE NUMBERS, EITHER ORIGINAL OR OF A DIFFERENT NATURE, ARE FOR INFORMATION PURPOSES ONLY. WHEN PLACING AN ORDER, PLEASE, ALWAYS USE COSIBO REFERENCE NUMBERS AND DO NOT MENTION THE ORIGINAL REFERENCE NUMBERS OF THE TRUCK MANUFACTURERS IN THE INVOICE TO VEHICLE OWNERS OR TO ANYBODY ELSE. THE CUSTOMER TAKES HIS OWN RESPONSIBILITY IF HE DOES NOT COMPLY WITH WHAT ABOVE.

GAS SPRING



- **Model**
- ★ **Application**

Code	OEM new	OEM old
64062	1369553	

- **4 TRUCK**

- ★ CP LHD CH 1230215 - CH 4376385 - CH 9023917 - CH 3500001 - CR LHD CH 1227496 - CH 4371634 - CH 9021603 - CH 3500001 - CP/CR RHD CH 1233808 - CH 4382182 - CH 9027044 - CH 3500001

ALL THE COMPONENTS LISTED IN OUR CATALOGUE ARE NOT ORIGINAL, THOUGH PERFECTLY INTERCHANGEABLE. REFERENCE NUMBERS, EITHER ORIGINAL OR OF A DIFFERENT NATURE, ARE FOR INFORMATION PURPOSES ONLY. WHEN PLACING AN ORDER, PLEASE, ALWAYS USE COSIBO REFERENCE NUMBERS AND DO NOT MENTION THE ORIGINAL REFERENCE NUMBERS OF THE TRUCK MANUFACTURERS IN THE INVOICE TO VEHICLE OWNERS OR TO ANYBODY ELSE. THE CUSTOMER TAKES HIS OWN RESPONSIBILITY IF HE DOES NOT COMPLY WITH WHAT ABOVE.

RUBBER HOSE



- Model
- ★ Application

61212

346627

OEM old

- 3 TRUCK

- ★ CG/CP

RUBBER HOSE



- 3 TRUCK

- ★ GR900R/GRS900R

61808

142729

V-BELT L=2430

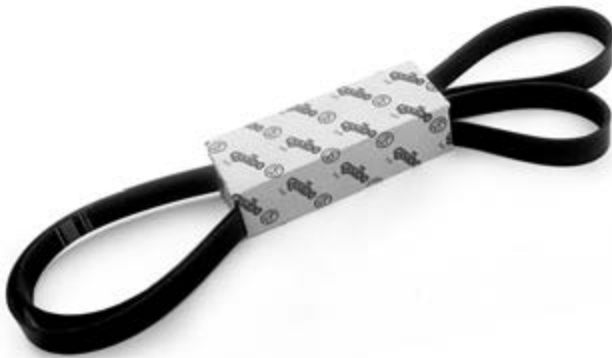

- IND. MARINE ENGINE 4

- ★ D112 40A

63934

1800527

1490821

ALL THE COMPONENTS LISTED IN OUR CATALOGUE ARE NOT ORIGINAL, THOUGH PERFECTLY INTERCHANGEABLE. REFERENCE NUMBERS, EITHER ORIGINAL OR OF A DIFFERENT NATURE, ARE FOR INFORMATION PURPOSES ONLY. WHEN PLACING AN ORDER, PLEASE, ALWAYS USE COSIBO REFERENCE NUMBERS AND DO NOT MENTION THE ORIGINAL REFERENCE NUMBERS OF THE TRUCK MANUFACTURERS IN THE INVOICE TO VEHICLE OWNERS OR TO ANYBODY ELSE. THE CUSTOMER TAKES HIS OWN RESPONSIBILITY IF HE DOES NOT COMPLY WITH WHAT ABOVE.

CABIN HEATER MOTOR



- Model
- ★ Application

Code	OEM new	OEM old
63187	1495692	1401436

- 4 TRUCK

- ★

CABIN HEATER MOTOR



- P-G-R-T- TRUCK

- ★

64803	1854876	
--------------	---------	--

AIR CONDITIONING RADIATOR



- 4 TRUCK

- ★ CR D9/D11/D12/D14/D16 - CR DSC11 - CT DSC11 - CT D12 DC11 - CT D14/D16

62405	1449757	1354110
--------------	---------	---------

ALL THE COMPONENTS LISTED IN OUR CATALOGUE ARE NOT ORIGINAL, THOUGH PERFECTLY INTERCHANGEABLE. REFERENCE NUMBERS, EITHER ORIGINAL OR OF A DIFFERENT NATURE, ARE FOR INFORMATION PURPOSES ONLY. WHEN PLACING AN ORDER, PLEASE, ALWAYS USE COSIBO REFERENCE NUMBERS AND DO NOT MENTION THE ORIGINAL REFERENCE NUMBERS OF THE TRUCK MANUFACTURERS IN THE INVOICE TO VEHICLE OWNERS OR TO ANYBODY ELSE. THE CUSTOMER TAKES HIS OWN RESPONSIBILITY IF HE DOES NOT COMPLY WITH WHAT ABOVE.

	Code	OEM new	OEM old
FLEXIBLE HOSE	65456	1723663	1437264
<ul style="list-style-type: none"> ● Model ★ Application 			
<ul style="list-style-type: none"> ● 4 TRUCK ★ D16 CR 			



CABIN COOLER	64804	1779202	1323821
<ul style="list-style-type: none"> ● 4 TRUCK ★ CP/CR/CT 			
<ul style="list-style-type: none"> ● P-G-R-T TRUCK ★ 			

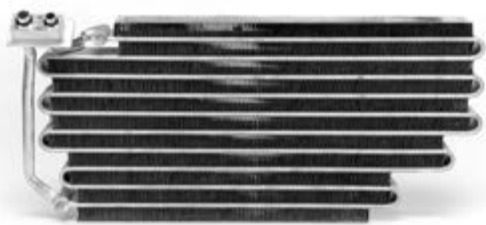

WATER VALVE	64204	1795464	1450166 1789068
<ul style="list-style-type: none"> ● 4 TRUCK ★ 			
<ul style="list-style-type: none"> ● P-G-R-T TRUCK ★ 			



ALL THE COMPONENTS LISTED IN OUR CATALOGUE ARE NOT ORIGINAL, THOUGH PERFECTLY INTERCHANGEABLE. REFERENCE NUMBERS, EITHER ORIGINAL OR OF A DIFFERENT NATURE, ARE FOR INFORMATION PURPOSES ONLY. WHEN PLACING AN ORDER, PLEASE, ALWAYS USE COSIBO REFERENCE NUMBERS AND DO NOT MENTION THE ORIGINAL REFERENCE NUMBERS OF THE TRUCK MANUFACTURERS IN THE INVOICE TO VEHICLE OWNERS OR TO ANYBODY ELSE. THE CUSTOMER TAKES HIS OWN RESPONSIBILITY IF HE DOES NOT COMPLY WITH WHAT ABOVE.

		Code	OEM new	OEM old
COMPRESSOR	● Model	65535	1888034	1412263
	★ Application			
	● 4 BUS			
	★ F114			
	● 4 TRUCK			
	★ D12 - DC11 CR/CT - D14 - D16 - DSC11			
	● IND.MARINE ENGINE 4			
	★ D16A/M			
	● IND.MARINE ENGINE 5			
	★ DC9A EMS			
● P-G-R-T TRUCK				
★ D16 - 1st SERIES/PRIMA SERIE				



		64805	1846702	1437263
CABIN COOLER	● 4 TRUCK			
	★			
	● P-G-R-T TRUCK			
	★			



		64027	1738098	1425070
FAN HEATING SENSOR	● 4 TRUCK			
	★ CP/CR/CT			



ALL THE COMPONENTS LISTED IN OUR CATALOGUE ARE NOT ORIGINAL, THOUGH PERFECTLY INTERCHANGEABLE. REFERENCE NUMBERS, EITHER ORIGINAL OR OF A DIFFERENT NATURE, ARE FOR INFORMATION PURPOSES ONLY. WHEN PLACING AN ORDER, PLEASE, ALWAYS USE COSIBO REFERENCE NUMBERS AND DO NOT MENTION THE ORIGINAL REFERENCE NUMBERS OF THE TRUCK MANUFACTURERS IN THE INVOICE TO VEHICLE OWNERS OR TO ANYBODY ELSE. THE CUSTOMER TAKES HIS OWN RESPONSIBILITY IF HE DOES NOT COMPLY WITH WHAT ABOVE.

HEATING CONTROL SWITCH



	Code	OEM new	OEM old
● Model	65471	1422615	
★ Application			
● P-G-R-T TRUCK			
★ AUTOMATIC RECORDING			

AIR CONDENSOR

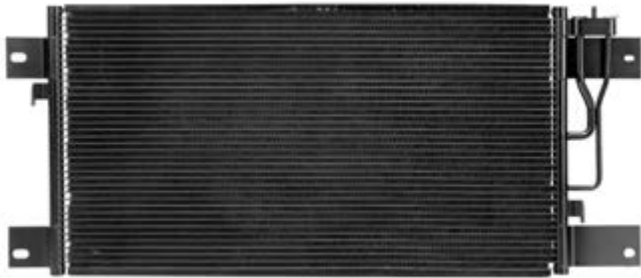

	64422	1790840	1446258 1782207
● P-G-R-T TRUCK			
★ D16 CR/CT - D11/D12 CR/CT - D9 CR - D9 D11 D12 CP			

CABIN RADIATOR



	65437	1752264	
● P-G-R-T TRUCK			
★ CP/CR D0-D11-D12-D13 - CG D9-D11-D12 - CR D16			

PRESSURE SWITCH



	64258	1449771	
● 4 TRUCK			
★ D9 CP/CR - D12 DC11 CP/CR/CT - CP19 F FRONTLINE - D14 CR/CT - DSC11 CR/CT - DSC11 OSC11 CP - D16 CR/CT			
● P-G-R-T TRUCK			
★ D16 CR/CT - D11 D12 CR/CT - D9 CR - D9 D11 D12 CP			

ALL THE COMPONENTS LISTED IN OUR CATALOGUE ARE NOT ORIGINAL, THOUGH PERFECTLY INTERCHANGEABLE. REFERENCE NUMBERS, EITHER ORIGINAL OR OF A DIFFERENT NATURE, ARE FOR INFORMATION PURPOSES ONLY. WHEN PLACING AN ORDER, PLEASE, ALWAYS USE COSIBO REFERENCE NUMBERS AND DO NOT MENTION THE ORIGINAL REFERENCE NUMBERS OF THE TRUCK MANUFACTURERS IN THE INVOICE TO VEHICLE OWNERS OR TO ANYBODY ELSE. THE CUSTOMER TAKES HIS OWN RESPONSIBILITY IF HE DOES NOT COMPLY WITH WHAT ABOVE.

ELECTRIC HEATER MODIFICATION SET



- Model
- ★ Application

Code	OEM new	OEM old
64825	1537771	

- 4 TRUCK

- ★

CABIN AIR FILTER

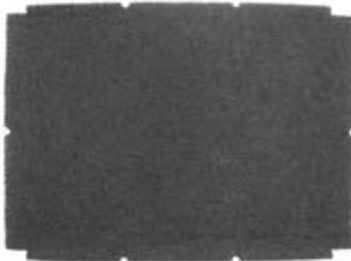

60922	303520	
--------------	--------	--

- 3 TRUCK

- ★

CABIN AIR FILTER



60631	1913503	1420197 1379952
--------------	---------	--------------------

- 4 BUS

- ★ D9/DC11/D12/D14 12.2 BAR

- 4 TRUCK

- ★ D9/DC11/D12/D14 9,3/12,2 BAR - D16 9,3/12,2 BAR - D12 HPI 9,3/12,2 BAR - CP/CR/CT

- F-K-N BUS

- ★ D12 HPI - D9/D11/D12 PDE

- P-G-R-T TRUCK

- ★ D16 - HPI - D9/D11D12 PDE - CG/CP/CR

ALL THE COMPONENTS LISTED IN OUR CATALOGUE ARE NOT ORIGINAL, THOUGH PERFECTLY INTERCHANGEABLE. REFERENCE NUMBERS, EITHER ORIGINAL OR OF A DIFFERENT NATURE, ARE FOR INFORMATION PURPOSES ONLY. WHEN PLACING AN ORDER, PLEASE, ALWAYS USE COSIBO REFERENCE NUMBERS AND DO NOT MENTION THE ORIGINAL REFERENCE NUMBERS OF THE TRUCK MANUFACTURERS IN THE INVOICE TO VEHICLE OWNERS OR TO ANYBODY ELSE. THE CUSTOMER TAKES HIS OWN RESPONSIBILITY IF HE DOES NOT COMPLY WITH WHAT ABOVE.

CABIN AIR FILTER, ACTIVATED CARBONS



	Code	OEM new	OEM old
● Model	60631/1	1420197/1	
★ Application			
● 4 BUS			
★	D9/DC11/D12/D14 12.2 BAR		
● 4 TRUCK			
★	D9/DC11/D12/D14 9,3/12,2 BAR - D16 9,3/12,2 BAR - D12 HPI 9,3/12,2 BAR - CP/CR/CT		
● F-K-N BUS			
★	D12 HPI - D9/D11/D12 PDE		
● P-G-R-T TRUCK			
★	D16 - HPI - D9/D11/D12 PDE - CG/CP/CR		

CABIN AIR FILTER

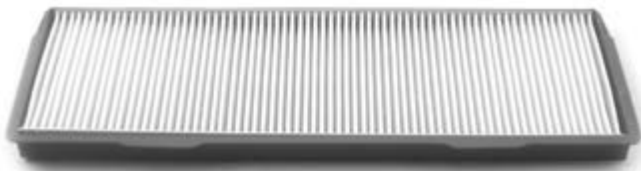

	Code	OEM new	OEM old
	64209	1913500	1770813
● P-G-R-T TRUCK			
★	D16 - HPI - D9/D11/D12 PDE -		

ALL THE COMPONENTS LISTED IN OUR CATALOGUE ARE NOT ORIGINAL, THOUGH PERFECTLY INTERCHANGEABLE. REFERENCE NUMBERS, EITHER ORIGINAL OR OF A DIFFERENT NATURE, ARE FOR INFORMATION PURPOSES ONLY. WHEN PLACING AN ORDER, PLEASE, ALWAYS USE COSIBO REFERENCE NUMBERS AND DO NOT MENTION THE ORIGINAL REFERENCE NUMBERS OF THE TRUCK MANUFACTURERS IN THE INVOICE TO VEHICLE OWNERS OR TO ANYBODY ELSE. THE CUSTOMER TAKES HIS OWN RESPONSIBILITY IF HE DOES NOT COMPLY WITH WHAT ABOVE.

SOLENOID VALVE



	Code	OEM new	OEM old
● Model ★ Application	62342	1536307	1421325
● 4 BUS			
★ CL/CN - CN94UA			
● F-K-N BUS			
★ IKIB			

RUBBER SPACER



	65254	302200	
● 3 BUS			
★			
● 3 TRUCK			
★			

O-RING DIAM.=59,5X3 mm

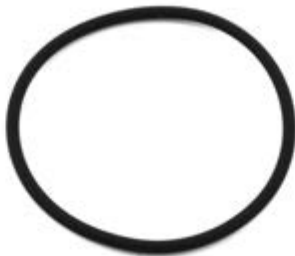

	60636	332119	392663
● F-K-N BUS			
★ K UD 6X2			

SPACER



	63608	370640	
● 3 TRUCK			
★			

ALL THE COMPONENTS LISTED IN OUR CATALOGUE ARE NOT ORIGINAL, THOUGH PERFECTLY INTERCHANGEABLE. REFERENCE NUMBERS, EITHER ORIGINAL OR OF A DIFFERENT NATURE, ARE FOR INFORMATION PURPOSES ONLY. WHEN PLACING AN ORDER, PLEASE, ALWAYS USE COSIBO REFERENCE NUMBERS AND DO NOT MENTION THE ORIGINAL REFERENCE NUMBERS OF THE TRUCK MANUFACTURERS IN THE INVOICE TO VEHICLE OWNERS OR TO ANYBODY ELSE. THE CUSTOMER TAKES HIS OWN RESPONSIBILITY IF HE DOES NOT COMPLY WITH WHAT ABOVE.

SOLENOID VALVE



- **Model**
- ★ **Application**

Code	OEM new	OEM old
65191	2038653	1536304 1340231 1421322

- **4 BUS**
- ★ CL/CN - CN LHD/RHD
- **F-K-N BUS**
- ★

ALL THE COMPONENTS LISTED IN OUR CATALOGUE ARE NOT ORIGINAL, THOUGH PERFECTLY INTERCHANGEABLE. REFERENCE NUMBERS, EITHER ORIGINAL OR OF A DIFFERENT NATURE, ARE FOR INFORMATION PURPOSES ONLY. WHEN PLACING AN ORDER, PLEASE, ALWAYS USE COSIBO REFERENCE NUMBERS AND DO NOT MENTION THE ORIGINAL REFERENCE NUMBERS OF THE TRUCK MANUFACTURERS IN THE INVOICE TO VEHICLE OWNERS OR TO ANYBODY ELSE. THE CUSTOMER TAKES HIS OWN RESPONSIBILITY IF HE DOES NOT COMPLY WITH WHAT ABOVE.

		Code	OEM new	OEM old
LH SEAT SWITCH	● Model	62472	1391425	
	★ Application			
	● 4 TRUCK			
	★	LUXURY TYPE CH 1239401 - CH 1239402 - 1254179 - CH 4391862 - CH 4391863 - 4420246 - CH 9031835 - CH 9031836 - 9046286 - CH 3500759 - CH 3500760 - 3513489 - MEDIUM TYPE A CH 1239401 - CH 1239402 - 1254179 - CH 4391862 - CH 4391863 - 4420246 - CH 9031835 - CH 9031836 - 9046286 - CH 3500759 - CH 3500760 - 3513489		

RH SEAT SWITCH	62471	1391426	
	● 4 TRUCK		
	★	LUXURY TYPE CH 1239401 - CH 1239402 - 1254179 - CH 4391862 - CH 4391863 - 4420246 - CH 9031835 - CH 9031836 - 9046286 - CH 3500759 - CH 3500760 - 3513489 - MEDIUM TYPE A CH 1239401 - CH 1239402 - 1254179 - CH 4391862 - CH 4391863 - 4420246 - CH 9031835 - CH 9031836 - 9046286 - CH 3500759 - CH 3500760 - 3513489	

LH SEAT SWITCH	62474	1440370	
	● 4 TRUCK		
	★	MEDIUM TYPE A CH 1254180 - CH 4420247 - CH 9046287 - CH 3513490 - LUXURY TYPE CH 1254180 - CH 4420247 - CH 9046287 - CH 3513490	

ALL THE COMPONENTS LISTED IN OUR CATALOGUE ARE NOT ORIGINAL, THOUGH PERFECTLY INTERCHANGEABLE. REFERENCE NUMBERS, EITHER ORIGINAL OR OF A DIFFERENT NATURE, ARE FOR INFORMATION PURPOSES ONLY. WHEN PLACING AN ORDER, PLEASE, ALWAYS USE COSIBO REFERENCE NUMBERS AND DO NOT MENTION THE ORIGINAL REFERENCE NUMBERS OF THE TRUCK MANUFACTURERS IN THE INVOICE TO VEHICLE OWNERS OR TO ANYBODY ELSE. THE CUSTOMER TAKES HIS OWN RESPONSIBILITY IF HE DOES NOT COMPLY WITH WHAT ABOVE.

RH SEAT SWITCH



	Code	OEM new	OEM old
● Model	62473	1440371	
★ Application			
● 4 TRUCK			
★	MEDIUM TYPE A CH 1254180 - CH 4420247 - CH 9046287 - CH 3513490 - LUXURY TYPE CH 1254180 - CH 4420247 - CH 9046287 - CH 3513490		

CONTROL CYLINDER SEAT



	62525	1440365	
● 4 TRUCK			
★	MEDIUM TYPE A & LUXURY TYPE CH 1254180 - CH 4420247 - CH 9046287 - CH 3513490		

SEAT LEVELING VALVE



	62538	1440367	
● 4 TRUCK			
★	MEDIUM TYPE A - LUXURY TYPE CH 1254180 - CH 4420247 - CH 9046287 - CH 3513490		

ALL THE COMPONENTS LISTED IN OUR CATALOGUE ARE NOT ORIGINAL, THOUGH PERFECTLY INTERCHANGEABLE. REFERENCE NUMBERS, EITHER ORIGINAL OR OF A DIFFERENT NATURE, ARE FOR INFORMATION PURPOSES ONLY. WHEN PLACING AN ORDER, PLEASE, ALWAYS USE COSIBO REFERENCE NUMBERS AND DO NOT MENTION THE ORIGINAL REFERENCE NUMBERS OF THE TRUCK MANUFACTURERS IN THE INVOICE TO VEHICLE OWNERS OR TO ANYBODY ELSE. THE CUSTOMER TAKES HIS OWN RESPONSIBILITY IF HE DOES NOT COMPLY WITH WHAT ABOVE.

SEAT LINK



- Model
- ★ Application

Code	OEM new	OEM old
62539	1440364	

- 4 TRUCK

- ★ MEDIUM TYPE A - LUXURY TYPE CH 1254180 - CH 4420247 - CH 9046287 - CH 3513490

ALL THE COMPONENTS LISTED IN OUR CATALOGUE ARE NOT ORIGINAL, THOUGH PERFECTLY INTERCHANGEABLE. REFERENCE NUMBERS, EITHER ORIGINAL OR OF A DIFFERENT NATURE, ARE FOR INFORMATION PURPOSES ONLY. WHEN PLACING AN ORDER, PLEASE, ALWAYS USE COSIBO REFERENCE NUMBERS AND DO NOT MENTION THE ORIGINAL REFERENCE NUMBERS OF THE TRUCK MANUFACTURERS IN THE INVOICE TO VEHICLE OWNERS OR TO ANYBODY ELSE. THE CUSTOMER TAKES HIS OWN RESPONSIBILITY IF HE DOES NOT COMPLY WITH WHAT ABOVE.

	Code	OEM new	OEM old
RUBBER DAMPER	65272	384595	
 <ul style="list-style-type: none"> ● Model ★ Application 	<ul style="list-style-type: none"> ● 3 TRUCK ★ DN/DS/DSC 		

RUBBER BUFFER	65273	1358828	1332090
 <ul style="list-style-type: none"> ● 3 TRUCK ★ DN/DS/DSC 			

RUBBER DAMPER	62242	348764	
 <ul style="list-style-type: none"> ● 3 TRUCK ★ CH 1144377 - CH 4277346 			

RUBBER DAMPER	61222	390358	347241
 <ul style="list-style-type: none"> ● 3 TRUCK ★ 			

ALL THE COMPONENTS LISTED IN OUR CATALOGUE ARE NOT ORIGINAL, THOUGH PERFECTLY INTERCHANGEABLE. REFERENCE NUMBERS, EITHER ORIGINAL OR OF A DIFFERENT NATURE, ARE FOR INFORMATION PURPOSES ONLY. WHEN PLACING AN ORDER, PLEASE, ALWAYS USE COSIBO REFERENCE NUMBERS AND DO NOT MENTION THE ORIGINAL REFERENCE NUMBERS OF THE TRUCK MANUFACTURERS IN THE INVOICE TO VEHICLE OWNERS OR TO ANYBODY ELSE. THE CUSTOMER TAKES HIS OWN RESPONSIBILITY IF HE DOES NOT COMPLY WITH WHAT ABOVE.

	Code	OEM new	OEM old
RUBBER DAMPER 	61223	390359	347245
<ul style="list-style-type: none"> ● Model ★ Application 			
<ul style="list-style-type: none"> ● 3 TRUCK ★ 			
RUBBER BUSHING 	62245	716360	
<ul style="list-style-type: none"> ● 3 TRUCK ★ CT13/CT19 			
CAB BUSHING 	61743	385266	
<ul style="list-style-type: none"> ● 3 TRUCK ★ CT13/CT19 			
PLASTIC BUSHING 	62027	346085	
<ul style="list-style-type: none"> ● 3 TRUCK ★ 			
PLASTIC BUSHING 	62015	311757	
<ul style="list-style-type: none"> ● 2 TRUCK ★ 92 - 112 - 142 FIRST SERIES 			

ALL THE COMPONENTS LISTED IN OUR CATALOGUE ARE NOT ORIGINAL, THOUGH PERFECTLY INTERCHANGEABLE. REFERENCE NUMBERS, EITHER ORIGINAL OR OF A DIFFERENT NATURE, ARE FOR INFORMATION PURPOSES ONLY. WHEN PLACING AN ORDER, PLEASE, ALWAYS USE COSIBO REFERENCE NUMBERS AND DO NOT MENTION THE ORIGINAL REFERENCE NUMBERS OF THE TRUCK MANUFACTURERS IN THE INVOICE TO VEHICLE OWNERS OR TO ANYBODY ELSE. THE CUSTOMER TAKES HIS OWN RESPONSIBILITY IF HE DOES NOT COMPLY WITH WHAT ABOVE.

CAB BUSHING FULL RUBBERD INSIDE



	Code	OEM new	OEM old
● Model	60482	1394544	
★ Application			
● 4 TRUCK			
★	CR CH 1291876 - CH 1291877 - CH 4500364 - CH 4500365 - CH 9083194 - CH 9083195 - CH 3544687 - CH 3544688 - CP19 - CP CH 1291876 - CH 1291877 - CH 4500364 - CH 4500365 - CH 9083194 - CH 9083195 - CH 3544687 - CH 3544688 - CP19 CH 3555849 - CP14 CH 3555849		
● P-G-R-T TRUCK			
★	CR16/ 19 - CP16/ 19 - CP14 - CG		

RUBBER BUSHING



	62028	283295	
● 3 TRUCK			
★			

RUBBER DUMPER



	65265	283296	
● 3 TRUCK			
★			

RUBBER BUFFER



	65266	1116362	
● 3 TRUCK			
★	CG/CP/CR - CP/CR/CT13 - CT19		

ALL THE COMPONENTS LISTED IN OUR CATALOGUE ARE NOT ORIGINAL, THOUGH PERFECTLY INTERCHANGEABLE. REFERENCE NUMBERS, EITHER ORIGINAL OR OF A DIFFERENT NATURE, ARE FOR INFORMATION PURPOSES ONLY. WHEN PLACING AN ORDER, PLEASE, ALWAYS USE COSIBO REFERENCE NUMBERS AND DO NOT MENTION THE ORIGINAL REFERENCE NUMBERS OF THE TRUCK MANUFACTURERS IN THE INVOICE TO VEHICLE OWNERS OR TO ANYBODY ELSE. THE CUSTOMER TAKES HIS OWN RESPONSIBILITY IF HE DOES NOT COMPLY WITH WHAT ABOVE.

BEARING



- Model
- ★ Application

Code	OEM new	OEM old
62029	348694	

- 3 TRUCK
- ★

RUBBER DAMPER



- 3 TRUCK
- ★

62030	1302008	
-------	---------	--

SPACER



- 3 TRUCK
- ★

62031	325014	
-------	--------	--

SPACER



- 3 TRUCK
- ★

62032	311755	
-------	--------	--

ALL THE COMPONENTS LISTED IN OUR CATALOGUE ARE NOT ORIGINAL, THOUGH PERFECTLY INTERCHANGEABLE. REFERENCE NUMBERS, EITHER ORIGINAL OR OF A DIFFERENT NATURE, ARE FOR INFORMATION PURPOSES ONLY. WHEN PLACING AN ORDER, PLEASE, ALWAYS USE COSIBO REFERENCE NUMBERS AND DO NOT MENTION THE ORIGINAL REFERENCE NUMBERS OF THE TRUCK MANUFACTURERS IN THE INVOICE TO VEHICLE OWNERS OR TO ANYBODY ELSE. THE CUSTOMER TAKES HIS OWN RESPONSIBILITY IF HE DOES NOT COMPLY WITH WHAT ABOVE.

	Code	OEM new	OEM old
SPACER	62033	1121763	297571



- Model
- ★ Application

● 3 TRUCK

★

CAB BUSHING	62145	1356668	320775
--------------------	--------------	---------	--------



● 3 TRUCK

★

SPRING	63746	346568	
---------------	--------------	--------	--



● 3 TRUCK

★ CG/CP/CR13

ALL THE COMPONENTS LISTED IN OUR CATALOGUE ARE NOT ORIGINAL, THOUGH PERFECTLY INTERCHANGEABLE. REFERENCE NUMBERS, EITHER ORIGINAL OR OF A DIFFERENT NATURE, ARE FOR INFORMATION PURPOSES ONLY. WHEN PLACING AN ORDER, PLEASE, ALWAYS USE COSIBO REFERENCE NUMBERS AND DO NOT MENTION THE ORIGINAL REFERENCE NUMBERS OF THE TRUCK MANUFACTURERS IN THE INVOICE TO VEHICLE OWNERS OR TO ANYBODY ELSE. THE CUSTOMER TAKES HIS OWN RESPONSIBILITY IF HE DOES NOT COMPLY WITH WHAT ABOVE.

SPRING



- **Model**
 - ★ **Application**
-
- **3 TRUCK**
 - ★ CP19 4X2 6X2 6X4

Code	OEM new	OEM old
63747	383523	

RUBBER MOUNTING



- **3 TRUCK**
- ★ DN/DS/DSC

61226	329583	305345
--------------	--------	--------

CAB BALL JOINT W/SEAL RINGS



- **P-G-R-T TRUCK**
 - ★ CP - CT14 - CT19 - CT - CP 16/19 - CP14
-
- **4 TRUCK**
 - ★ CP19 - CR CH 1291876 - CH 1291877 - CH 4500364 - CH 4500365 - CH 9083194 - CH 9083195 - CH 3544687 - CH 3544688 - CP CH 1291876 - CH 1291877 - CH 4500364 - CH 4500365 - CH 9083194 - CH 9083195 - CH 3544687 - CH 3544688 - CT CH 1290103CH 1290104 - CH 4498394 - CH 4498395 - CH 9082906 - CH 9082907 - CT14 - CP19 CH 3555849 - CP14 CH 3555849

64270	2171712	
--------------	---------	--

ALL THE COMPONENTS LISTED IN OUR CATALOGUE ARE NOT ORIGINAL, THOUGH PERFECTLY INTERCHANGEABLE. REFERENCE NUMBERS, EITHER ORIGINAL OR OF A DIFFERENT NATURE, ARE FOR INFORMATION PURPOSES ONLY. WHEN PLACING AN ORDER, PLEASE, ALWAYS USE COSIBO REFERENCE NUMBERS AND DO NOT MENTION THE ORIGINAL REFERENCE NUMBERS OF THE TRUCK MANUFACTURERS IN THE INVOICE TO VEHICLE OWNERS OR TO ANYBODY ELSE. THE CUSTOMER TAKES HIS OWN RESPONSIBILITY IF HE DOES NOT COMPLY WITH WHAT ABOVE.

	Code	OEM new	OEM old
CAB BALL JOINT W/SEAL RINGS	64271	2171712	
<ul style="list-style-type: none"> ● Model ★ Application 			
<ul style="list-style-type: none"> ● P-G-R-T TRUCK ★ CR 16/19 - CG 			



CAB BUSHING PARTIAL RUBBERD INSIDE	60482/T	1377562	
<ul style="list-style-type: none"> ● 4 TRUCK ★ CR CH 1291876 - CH 1291877 - CH 4500364 - CH 4500365 - CH 9083194 - CH 9083195 - CH 3544687 - CH 3544688 - CP19 - CP CH 1291876 - CH 1291877 - CH 4500364 - CH 4500365 - CH 9083194 - CH 9083195 - CH 3544687 - CH 3544688 - CP19 CH 3555849 - CP14 CH 3555849 			
<ul style="list-style-type: none"> ● P-G-R-T TRUCK ★ CR16/ 19 - CP16/ 19 - CP14 - CG 			



WASHER IN POLYURETHANE BLACK	60490	1385170	
<ul style="list-style-type: none"> ● 4 TRUCK ★ CR CH 1291876 - CH 1291877 - CH 4500364 - CH 4500365 - CH 9083194 - CH 9083195 - CH 3544687 - CH 3544688 - CP19 - CP CH 1291876 - CH 1291877 - CH 4500364 - CH 4500365 - CH 9083194 - CH 9083195 - CH 3544687 - CH 3544688 - CP19 CH 3555849 - CP14 CH 3555849 			
<ul style="list-style-type: none"> ● P-G-R-T TRUCK ★ CR16/ 19 - CP16/ 19 - CP14 - CG 			



CABIN WASHER	64439	1782290	
<ul style="list-style-type: none"> ● P-G-R-T TRUCK ★ CR16/19 			



ALL THE COMPONENTS LISTED IN OUR CATALOGUE ARE NOT ORIGINAL, THOUGH PERFECTLY INTERCHANGEABLE. REFERENCE NUMBERS, EITHER ORIGINAL OR OF A DIFFERENT NATURE, ARE FOR INFORMATION PURPOSES ONLY. WHEN PLACING AN ORDER, PLEASE, ALWAYS USE COSIBO REFERENCE NUMBERS AND DO NOT MENTION THE ORIGINAL REFERENCE NUMBERS OF THE TRUCK MANUFACTURERS IN THE INVOICE TO VEHICLE OWNERS OR TO ANYBODY ELSE. THE CUSTOMER TAKES HIS OWN RESPONSIBILITY IF HE DOES NOT COMPLY WITH WHAT ABOVE.

CABIN SUSPENSION REPAIR SET



- Model
- ★ Application

Code

OEM new

OEM old

63808

63808

- 4 TRUCK

- ★ CP/ CR CABIN

- P-G-R-T TRUCK

- ★ CP/ CR CABIN

PARTIAL CABIN SUSPENSION REPAIR SET



- 4 TRUCK

- ★ CP/CR CABIN

- P-G-R-T TRUCK

- ★ CP/CR CABIN

63811

63811

CABIN LOCK



- 4 TRUCK

- ★ CP19/CP19F - CR19 - CP/CR14 - CP28/31

64067

1383496

ALL THE COMPONENTS LISTED IN OUR CATALOGUE ARE NOT ORIGINAL, THOUGH PERFECTLY INTERCHANGEABLE. REFERENCE NUMBERS, EITHER ORIGINAL OR OF A DIFFERENT NATURE, ARE FOR INFORMATION PURPOSES ONLY. WHEN PLACING AN ORDER, PLEASE, ALWAYS USE COSIBO REFERENCE NUMBERS AND DO NOT MENTION THE ORIGINAL REFERENCE NUMBERS OF THE TRUCK MANUFACTURERS IN THE INVOICE TO VEHICLE OWNERS OR TO ANYBODY ELSE. THE CUSTOMER TAKES HIS OWN RESPONSIBILITY IF HE DOES NOT COMPLY WITH WHAT ABOVE.

	Code	OEM new	OEM old
SEAL RING	63873	1780108	1343149 1459188
<ul style="list-style-type: none"> ● Model ★ Application 			
<ul style="list-style-type: none"> ● 4 TRUCK ★ CP19 - CR CH 1291876 - CH 1291877 - CH 4500364 - CH 4500365 - CH 9083194 - CH 9083195 - CH 3544687 - CH 3544688 - CP CH 1291876CH 1291877 - CH 4500364 - CH 4500365 - CH 9083194 - CH 9083195 - CH 3544687 - CH 3544688 - CT CH 1290103 - CH 1290104 - CH 4498394 - CH 4498395 - CH - CH 9082906 - CH 9082907 - CT14 - CP19 CH 3555849 - CP14 CH 3555849 ● P-G-R-T TRUCK ★ CR16/ 19 - CP - CT14 - CP19 - CT - CP14 - CT19 - CG 			



CABIN BALL JOINT	63361	1744210	1443114 1504160
<ul style="list-style-type: none"> ● 4 TRUCK ★ CP19 - CR CH 1291876 - CH 1291877 - CH 4500364 - CH 4500365 - CH 9083194 - CH 9083195 - CH 3544687 - CH 3544688 - CP CH 1291876 - CH 1291877 - CH 4500364 - CH 4500365 - CH 9083194 - CH 9083195 - CH 3544687 - CH 3544688 - CT CH 1290103CH 1290104 - CH 4498394 - CH 4498395 - CH 9082906 - CH 9082907 - CT14 - CP19 CH 3555849 - CP14 CH 3555849 ● P-G-R-T TRUCK ★ CP - CT14 - CT19 - CT - CP 16/ 19 - CP14 			



CABIN BALL JOINT	63927	1744211	
<ul style="list-style-type: none"> ● P-G-R-T TRUCK ★ CR 16/ 19 - CG 			



ALL THE COMPONENTS LISTED IN OUR CATALOGUE ARE NOT ORIGINAL, THOUGH PERFECTLY INTERCHANGEABLE. REFERENCE NUMBERS, EITHER ORIGINAL OR OF A DIFFERENT NATURE, ARE FOR INFORMATION PURPOSES ONLY. WHEN PLACING AN ORDER, PLEASE, ALWAYS USE COSIBO REFERENCE NUMBERS AND DO NOT MENTION THE ORIGINAL REFERENCE NUMBERS OF THE TRUCK MANUFACTURERS IN THE INVOICE TO VEHICLE OWNERS OR TO ANYBODY ELSE. THE CUSTOMER TAKES HIS OWN RESPONSIBILITY IF HE DOES NOT COMPLY WITH WHAT ABOVE.

	Code	OEM new	OEM old
CAB BUSHING	61324	1514505	1105972
<ul style="list-style-type: none"> ● Model ★ Application 			
<ul style="list-style-type: none"> ● 3 TRUCK ★ 			
<ul style="list-style-type: none"> ● 4 TRUCK ★ CT 			
<ul style="list-style-type: none"> ● P-G-R-T TRUCK ★ CT 			



CAB BUSHING	64111	1368039	
<ul style="list-style-type: none"> ● 4 TRUCK ★ CT 			
<ul style="list-style-type: none"> ● P-G-R-T TRUCK ★ CT 			



WASHER	65269	1353965	
<ul style="list-style-type: none"> ● 4 TRUCK ★ CT 			
<ul style="list-style-type: none"> ● P-G-R-T TRUCK ★ CT 			





RUBBER BUSHING	62239	1379244	
<ul style="list-style-type: none"> ● 4 TRUCK ★ CT 			
<ul style="list-style-type: none"> ● P-G-R-T TRUCK ★ CT 			



ALL THE COMPONENTS LISTED IN OUR CATALOGUE ARE NOT ORIGINAL, THOUGH PERFECTLY INTERCHANGEABLE. REFERENCE NUMBERS, EITHER ORIGINAL OR OF A DIFFERENT NATURE, ARE FOR INFORMATION PURPOSES ONLY. WHEN PLACING AN ORDER, PLEASE, ALWAYS USE COSIBO REFERENCE NUMBERS AND DO NOT MENTION THE ORIGINAL REFERENCE NUMBERS OF THE TRUCK MANUFACTURERS IN THE INVOICE TO VEHICLE OWNERS OR TO ANYBODY ELSE. THE CUSTOMER TAKES HIS OWN RESPONSIBILITY IF HE DOES NOT COMPLY WITH WHAT ABOVE.

	Code	OEM new	OEM old
RUBBER BUSHING	62243	1372432	
	<ul style="list-style-type: none"> ● Model ★ Application 		
	<ul style="list-style-type: none"> ● 4 TRUCK 		
	<ul style="list-style-type: none"> ★ CP/CR/CT 		
	<ul style="list-style-type: none"> ● P-G-R-T TRUCK 		
	<ul style="list-style-type: none"> ★ CT - CP 14/16/19 		

RUBBER BUFFER	62274	1795583	397308
	<ul style="list-style-type: none"> ● 3 TRUCK 		
	<ul style="list-style-type: none"> ★ CR143 - DSC11 18 - CABIN CP/CR113 - CABIN CR13/19 D11 - CABIN CP/CR DSC11 21 - DSC11 21/22 (EDC/23) DTC11 		
	<ul style="list-style-type: none"> ● 4 TRUCK 		
	<ul style="list-style-type: none"> ★ CABIN CP14/CR14 - R164 		
	<ul style="list-style-type: none"> ● P-G-R-T TRUCK 		
	<ul style="list-style-type: none"> ★ CABIN CP/CG/CR 19M - CABIN CP/CR/CG 16/19 - CABIN CR16 D16 - CABIN CP/CG14 		
	<ul style="list-style-type: none"> ● 3 BUS 		
	<ul style="list-style-type: none"> ★ F113 RH 		
	<ul style="list-style-type: none"> ● IND. MARINE ENGINE 4 		
	<ul style="list-style-type: none"> ★ DC9 - DI16 50M - D16M 		

CAB BUSHING	65282	1353959	
	<ul style="list-style-type: none"> ● 4 TRUCK 		
	<ul style="list-style-type: none"> ★ 		

ALL THE COMPONENTS LISTED IN OUR CATALOGUE ARE NOT ORIGINAL, THOUGH PERFECTLY INTERCHANGEABLE. REFERENCE NUMBERS, EITHER ORIGINAL OR OF A DIFFERENT NATURE, ARE FOR INFORMATION PURPOSES ONLY. WHEN PLACING AN ORDER, PLEASE, ALWAYS USE COSIBO REFERENCE NUMBERS AND DO NOT MENTION THE ORIGINAL REFERENCE NUMBERS OF THE TRUCK MANUFACTURERS IN THE INVOICE TO VEHICLE OWNERS OR TO ANYBODY ELSE. THE CUSTOMER TAKES HIS OWN RESPONSIBILITY IF HE DOES NOT COMPLY WITH WHAT ABOVE.

	Code	OEM new	OEM old
RUBBER BUFFER	66582	1357381	
 <ul style="list-style-type: none"> ● Model ★ Application 			
<ul style="list-style-type: none"> ● 4 TRUCK ★ 			
<ul style="list-style-type: none"> ● P-G-R-T TRUCK ★ 			

CAB BUSHING	65282	1353959	
 <ul style="list-style-type: none"> ● P-G-R-T TRUCK ★ 			

RUBBER BUFFER	61731	285248	
 <ul style="list-style-type: none"> ● 3 TRUCK ★ DN/DS 			

CABIN REPAIR SET	64152	1755638	
 <ul style="list-style-type: none"> ● 4 TRUCK ★ CP19 - CR CH 1291876 - CH 1291877 - CH 4500364 - CH 4500365 - CH 9083194 - CH 9083195 - CH 3544687 - CH 3544688 - CP CH 1291876 - CH 1291877 - CH 4500364 - CH 4500365 - CH 9083194 - CH 983195 - CH 3544687 - CH 3544688 - CP19 CH 3555849 - CP14 CH 3555849 ● P-G-R-T TRUCK ★ CR 16/ 19 - CP - CP14 			

ALL THE COMPONENTS LISTED IN OUR CATALOGUE ARE NOT ORIGINAL, THOUGH PERFECTLY INTERCHANGEABLE. REFERENCE NUMBERS, EITHER ORIGINAL OR OF A DIFFERENT NATURE, ARE FOR INFORMATION PURPOSES ONLY. WHEN PLACING AN ORDER, PLEASE, ALWAYS USE COSIBO REFERENCE NUMBERS AND DO NOT MENTION THE ORIGINAL REFERENCE NUMBERS OF THE TRUCK MANUFACTURERS IN THE INVOICE TO VEHICLE OWNERS OR TO ANYBODY ELSE. THE CUSTOMER TAKES HIS OWN RESPONSIBILITY IF HE DOES NOT COMPLY WITH WHAT ABOVE.

	Code	OEM new	OEM old
BOLT	65262	1768269	1375299
<ul style="list-style-type: none"> ● Model ★ Application 			
<ul style="list-style-type: none"> ● 4 TRUCK ★ CR19 - CR CH 1291876 - CH 1291877 - CH 4500364 - CH 4500365 - CH 9083194 - CH 9083195 - CH 3544687 - CH 3544688 - CP CH 1291876 - CH 1291877 - CH 4500364 - CH 4500365 - CH 9083194 - CH 983195 - CH 3544687 - CH 3544688 - CP19 CH 3555849 - CP14 CH 3555849 			
<ul style="list-style-type: none"> ● P-G-R-T TRUCK ★ CR 16/19 - CP - CP14 			



	65326	1742449	
CABIN REPAIR SET			
<ul style="list-style-type: none"> ● 4 TRUCK ★ CP19 CH 3555849 - CR CH 1291876 - CH 1291877 - CH 4500364 - CH 4500365 - CH 9083194 - CH 9083195 - CH 3544687 - CH 3544688 - CP CH 1291876 - CH 1291877 - CH 4500364 - CH 4500365 - CH 9083194 - CH 9083195 - CH 3544687 - CH 3544688 - CP14 CH 3555849 			
<ul style="list-style-type: none"> ● P-G-R-T TRUCK ★ CR 16/ 19 - CP - CP14 			



	65261	1324713	
BEARING			
<ul style="list-style-type: none"> ● 4 TRUCK ★ CR CH 1291876 - CH 1291877 - CH 4500364 - CH 4500365 - CH 9083194 - CH 9083195 - CH 3544687 - CH 3544688 - CP19 - CP CH 1291876 - CH 1291877 - CH 4500364 - CH 4500365 - CH 9083194 - CH 9083195 - CH 3544687 - CH 3544688 - CP19 CH 3555849 - CP14 CH 3555849 			
<ul style="list-style-type: none"> ● P-G-R-T TRUCK ★ CR16/ 19 - CP16/ 19 - CP14 - CG 			



ALL THE COMPONENTS LISTED IN OUR CATALOGUE ARE NOT ORIGINAL, THOUGH PERFECTLY INTERCHANGEABLE. REFERENCE NUMBERS, EITHER ORIGINAL OR OF A DIFFERENT NATURE, ARE FOR INFORMATION PURPOSES ONLY. WHEN PLACING AN ORDER, PLEASE, ALWAYS USE COSIBO REFERENCE NUMBERS AND DO NOT MENTION THE ORIGINAL REFERENCE NUMBERS OF THE TRUCK MANUFACTURERS IN THE INVOICE TO VEHICLE OWNERS OR TO ANYBODY ELSE. THE CUSTOMER TAKES HIS OWN RESPONSIBILITY IF HE DOES NOT COMPLY WITH WHAT ABOVE.

OIL SEAL 36x52x7



	Code	OEM new	OEM old
● Model	65263	1324712	
★ Application			
● 4 TRUCK			
★	CR CH 1291876 - CH 1291877 - CH 4500364 - CH 4500365 - CH 9083194 - CH 9083195 - CH 3544687 - CH 3544688 - CP19 - CP CH 1291876 - CH 1291877 - CH 4500364 - CH 4500365 - CH 9083194 - CH 9083195 - CH 3544687 - CH 3544688 - CP19 CH 3555849 - CP14 CH 3555849		
● P-G-R-T TRUCK			
★	CR16/ 19 - CP16/ 19 - CP14 - CG		

POLIURETHANE DAMPER



	60481	1923654	1349805
● 4 TRUCK			
★	CP 19F - CP/CR/CT 19 - CR 19 8X8 WLS/ZLS - CP/CR 14		
● P-G-R-T TRUCK			
★	CP/CG/CR 16/19 - CP - CT 19 - CP/CG 14		

RUBBER DAMPER



	60481/1	1349805/1	
● 4 TRUCK			
★	CP 19F - CP/CR/CT 19 - CR 19 8X8 WLS/ZLS - CP/CR 14		
● P-G-R-T TRUCK			
★	CP/CG/CR 16/19 - CP - CT 19 - CP/CG 14		

VIBRATION DAMPER



	60488	1349810	
● 4 TRUCK			
★	CP/CR 19 - CP 14 - CP/CR/CT - CR 8X8 WLS/ZLS		
● P-G-R-T TRUCK			
★	CP/CR/CG 16/19 - CP/CG/CT - CP/CG 14		

ALL THE COMPONENTS LISTED IN OUR CATALOGUE ARE NOT ORIGINAL, THOUGH PERFECTLY INTERCHANGEABLE. REFERENCE NUMBERS, EITHER ORIGINAL OR OF A DIFFERENT NATURE, ARE FOR INFORMATION PURPOSES ONLY. WHEN PLACING AN ORDER, PLEASE, ALWAYS USE COSIBO REFERENCE NUMBERS AND DO NOT MENTION THE ORIGINAL REFERENCE NUMBERS OF THE TRUCK MANUFACTURERS IN THE INVOICE TO VEHICLE OWNERS OR TO ANYBODY ELSE. THE CUSTOMER TAKES HIS OWN RESPONSIBILITY IF HE DOES NOT COMPLY WITH WHAT ABOVE.

CAB BUSHING



	Code	OEM new	OEM old
● Model ★ Application	62010	1894408	1343134 1481245
● 4 TRUCK			
★	CP 19F - CP/CR 19 - CP/CR 14 - CT 14 - CT 19		
● P-G-R-T TRUCK			
★	CP/CR 19 - CP/CR 16 - CP 14 - CT 14 - CT 19 - CG 14 - CG 16 - CG 19		

CAB. VIBRATION DAMPER



	65255	1343100	
● 4 TRUCK			
★	CP 19F - CP/CR 19 - CP/CR 14 - CT 14 - CT 19		
● P-G-R-T TRUCK			
★	CP/CR 16/19 - CP/CR 19 - CP/CR 16 - CT 14 - CT 19 - CP 14 - CG 14 - CG 16 - CG 19		

CABIN LOCK



	64377	1810345	1519436
● 4 TRUCK			
★			
● P-G-R-T TRUCK			
★			

SUP. CAB. LINK ROD



	64072	1781929	1343131
● 4 TRUCK			
★	CP 19F - CP/CR 19 - CP/CR 14		
● P-G-R-T TRUCK			
★	CP/CR 19 - CP/CR 16 - CP 14 - CG 14 - CG 16 - CG 19		

ALL THE COMPONENTS LISTED IN OUR CATALOGUE ARE NOT ORIGINAL, THOUGH PERFECTLY INTERCHANGEABLE. REFERENCE NUMBERS, EITHER ORIGINAL OR OF A DIFFERENT NATURE, ARE FOR INFORMATION PURPOSES ONLY. WHEN PLACING AN ORDER, PLEASE, ALWAYS USE COSIBO REFERENCE NUMBERS AND DO NOT MENTION THE ORIGINAL REFERENCE NUMBERS OF THE TRUCK MANUFACTURERS IN THE INVOICE TO VEHICLE OWNERS OR TO ANYBODY ELSE. THE CUSTOMER TAKES HIS OWN RESPONSIBILITY IF HE DOES NOT COMPLY WITH WHAT ABOVE.

	Code	OEM new	OEM old
LEVEL VALVE	61903	1118884	
<ul style="list-style-type: none"> ● Model ★ Application 			
<ul style="list-style-type: none"> ● 3 TRUCK ★ CG/CP/CR/CT 13 - CP 4X4 8X4 - CP/CR 19 4X2 6X2/4 6X4 8X4 - CT 19 - STRE-AMLINE 			



LEVEL VALVE	63646	1430545	1407139 1451839 1399776 1934939
<ul style="list-style-type: none"> ● 4 TRUCK ★ CP/CR/CT - CP/CR 14 - CP/CR 19 			
<ul style="list-style-type: none"> ● P-G-R-T TRUCK ★ CP/CG 14/16/19 - CR16/16 - CP/CT 			



CABIN LEVEL VALVE LINK L=125,50 MM	61648	2000089	1386423
<ul style="list-style-type: none"> ● 4 TRUCK ★ CR CH 1219154 - 2011266 - CH 4366923 - 5131637 - CH 9016603 - 9103389 - CH 3576359 			
<ul style="list-style-type: none"> ● P-G-R-T TRUCK ★ CR CH 3604200 			



ALL THE COMPONENTS LISTED IN OUR CATALOGUE ARE NOT ORIGINAL, THOUGH PERFECTLY INTERCHANGEABLE. REFERENCE NUMBERS, EITHER ORIGINAL OR OF A DIFFERENT NATURE, ARE FOR INFORMATION PURPOSES ONLY. WHEN PLACING AN ORDER, PLEASE, ALWAYS USE COSIBO REFERENCE NUMBERS AND DO NOT MENTION THE ORIGINAL REFERENCE NUMBERS OF THE TRUCK MANUFACTURERS IN THE INVOICE TO VEHICLE OWNERS OR TO ANYBODY ELSE. THE CUSTOMER TAKES HIS OWN RESPONSIBILITY IF HE DOES NOT COMPLY WITH WHAT ABOVE.

	Code	OEM new	OEM old
CABIN LEVEL VALVE LINK L=40,5 MM	61710	1372510	
<ul style="list-style-type: none"> ● Model ★ Application 			
<ul style="list-style-type: none"> ● 4 TRUCK 			
<ul style="list-style-type: none"> ★ CP/CR14 CH 1243900 - 1265600 - CH 1265601 - 1280017 - CH 1280018 - CH 4400140 - 4442316 - CH 4442317 - 4471115 - CH 4471116 - CH 9036062 - 9057386 - CH 9057387 - 9069754 - CH 9069755 - CH 3508954 - 3524802 - CH 3524803 - 3533535 - CH 3533536 - CH 1294234 - CH 4508397 - CH 9086730 - CT CH 1243899 - CH 4400139 - CH 9036061 - CH 3508953 - CP/CR19 CT CH 1243900 - 1265600 - CH 1265601 - 1280017 - CH 4400140 - 4442316 - CH 4442317 - 4471115 - CH 9036062 - 9057386 - CH 9057387 - 9069754 - CH 3508954 - 3524802 - CH 3524803 - 3533535 			
<ul style="list-style-type: none"> ● P-G-R-T TRUCK 			
<ul style="list-style-type: none"> ★ CT CABIN 			



CABIN LEVEL VALVE LINK L=55 MM	64206	2000090	1386424
<ul style="list-style-type: none"> ● 4 TRUCK 			
<ul style="list-style-type: none"> ★ CP/CR CH 2011266 - CH 5131637 - CH 9103389 - CH 3576359 			
<ul style="list-style-type: none"> ● P-G-R-T TRUCK 			
<ul style="list-style-type: none"> ★ CP/CG 14/16/19 CR 16/19 CH 3604200 - CT 			



ALL THE COMPONENTS LISTED IN OUR CATALOGUE ARE NOT ORIGINAL, THOUGH PERFECTLY INTERCHANGEABLE. REFERENCE NUMBERS, EITHER ORIGINAL OR OF A DIFFERENT NATURE, ARE FOR INFORMATION PURPOSES ONLY. WHEN PLACING AN ORDER, PLEASE, ALWAYS USE COSIBO REFERENCE NUMBERS AND DO NOT MENTION THE ORIGINAL REFERENCE NUMBERS OF THE TRUCK MANUFACTURERS IN THE INVOICE TO VEHICLE OWNERS OR TO ANYBODY ELSE. THE CUSTOMER TAKES HIS OWN RESPONSIBILITY IF HE DOES NOT COMPLY WITH WHAT ABOVE.

	Code	OEM new	OEM old
SHOCK ABSORBER	64168	1348121	
<ul style="list-style-type: none"> ● Model ★ Application 			
<ul style="list-style-type: none"> ● 3 TRUCK ★ CT13/19 - CR13 			



4 POINTS CAB FRONT SHOCK ABSORBER FOR TRACTOR	62266	1424227	1363120
<ul style="list-style-type: none"> ● 4 TRUCK ★ CR CH 1291876 - CH 1291877 - CH 4500364 - CH 4500365 - CH 9083194 - CH 9083195 - CH 3544687 - CH 3544688 - CP CH 1291876 - CH 4500364 - CH 9083194 - CH 3544687 ● P-G-R-T TRUCK ★ CR16/ 19 - CG 			



4 POINTS REAR CAB SHOCK ABSORBER	62267	1435856	
<ul style="list-style-type: none"> ● 4 TRUCK ★ CR14 CH 1292428 - CH 4501900 - CH 9083916 - CH 3547307 - CR19 CH 1292428 - CH 4501900 - CH 9083916 - CH 3547307 			



ALL THE COMPONENTS LISTED IN OUR CATALOGUE ARE NOT ORIGINAL, THOUGH PERFECTLY INTERCHANGEABLE. REFERENCE NUMBERS, EITHER ORIGINAL OR OF A DIFFERENT NATURE, ARE FOR INFORMATION PURPOSES ONLY. WHEN PLACING AN ORDER, PLEASE, ALWAYS USE COSIBO REFERENCE NUMBERS AND DO NOT MENTION THE ORIGINAL REFERENCE NUMBERS OF THE TRUCK MANUFACTURERS IN THE INVOICE TO VEHICLE OWNERS OR TO ANYBODY ELSE. THE CUSTOMER TAKES HIS OWN RESPONSIBILITY IF HE DOES NOT COMPLY WITH WHAT ABOVE.

CABIN SHOCK ABSORBER



- Model
- ★ Application

Code

OEM new

OEM old

60438

1348117

- 3 TRUCK

- ★

SHOCK ABSORBER



- 4 TRUCK

- ★ CP19/CP19F - CP/CR14 - CR19

62211

1382827

SHOCK ABSORBER



- 4 TRUCK

- ★ CP/CR14 - CP/CR19 - 8X8 WLS/ZLS CR19

- P-G-R-T TRUCK

- ★ CP/CR16 - CP19 LOW-NORMAL-HIGH-TIOPLINE CABIN/CABINA BASSA-NORMALE-ALTA-TIOPLINE - CG14/16/19

64743

1505563

ALL THE COMPONENTS LISTED IN OUR CATALOGUE ARE NOT ORIGINAL, THOUGH PERFECTLY INTERCHANGEABLE. REFERENCE NUMBERS, EITHER ORIGINAL OR OF A DIFFERENT NATURE, ARE FOR INFORMATION PURPOSES ONLY. WHEN PLACING AN ORDER, PLEASE, ALWAYS USE COSIBO REFERENCE NUMBERS AND DO NOT MENTION THE ORIGINAL REFERENCE NUMBERS OF THE TRUCK MANUFACTURERS IN THE INVOICE TO VEHICLE OWNERS OR TO ANYBODY ELSE. THE CUSTOMER TAKES HIS OWN RESPONSIBILITY IF HE DOES NOT COMPLY WITH WHAT ABOVE.

FRONT AND REAR CAB SHOCK ABSORBER



	Code	OEM new	OEM old
● Model	62296	1424231	1349840
★ Application			
● 4 TRUCK			
★	CP19F - 2 POINTS - REAR - CR CH 1291876 - CH 1291877 - CH 4500364 - CH 4500365 - CH 9083194 - CH 9083195 - CH 3544687 - CH 3544688 - 4 POINTS - FRONT - CP19 CH 1292428 - CH 4501900 - CH 9083916 - CH 3547307 - 52 POINTS - REAR - CP14 CH 1292428 - CH 4501900 - CH 9083916 - CH 3547307 - 2 POINTS - REAR - CP14/CR14 CH 1292429 - CH 4501901 - CH 9083917 - CH 3547308 - 4 POINTS - REAR - CP/CR19 CH 1292429 - CH 4501901 - CH 9083917 - CH 3547308 - 4 POINTS - REAR - CR14 CH 1292428 - CH 4501900 - CH 9083916 - CH 3547307 4 POINTS - REAR - CR19 CH 1292428 - CH 4501900 - CH 9083916 - CH 3547308 2 & 4 POINTS/2 & 4 PUNTI - REAR		
● P-G-R-T TRUCK			
★	CR16/19 4 POINTS - FRONT - CP/CR16 4 POINTS - REAR - CP19 LOW - NORMAL - HIGH - CR19 LOW - NORMAL 4 POINTS - REAR - CP14 4 POINTS - REAR - CG 4 POINTS - FRONT - CG14 4 POINTS - REAR - CG16 4 POINTS REAR - CG19 4 POINTS - REAR		

SHOCK ABSORBER



	Code	OEM new	OEM old
	62268	1382829	1382826
● 4 TRUCK			
★	CP14/19		

CABIN SHOCK ABSORBER



	Code	OEM new	OEM old
	62322	1476415	
● 4 TRUCK			
★	CP/CR/CT 19F - CP/CR/CT 14		
● P-G-R-T TRUCK			
★	CP/CR 16/19 - CT 14/19 - CG		

ALL THE COMPONENTS LISTED IN OUR CATALOGUE ARE NOT ORIGINAL, THOUGH PERFECTLY INTERCHANGEABLE. REFERENCE NUMBERS, EITHER ORIGINAL OR OF A DIFFERENT NATURE, ARE FOR INFORMATION PURPOSES ONLY. WHEN PLACING AN ORDER, PLEASE, ALWAYS USE COSIBO REFERENCE NUMBERS AND DO NOT MENTION THE ORIGINAL REFERENCE NUMBERS OF THE TRUCK MANUFACTURERS IN THE INVOICE TO VEHICLE OWNERS OR TO ANYBODY ELSE. THE CUSTOMER TAKES HIS OWN RESPONSIBILITY IF HE DOES NOT COMPLY WITH WHAT ABOVE.

	Code	OEM new	OEM old
CABIN SHOCK ABSORBER	61368	1435859	
<ul style="list-style-type: none"> ● Model ★ Application 			
<ul style="list-style-type: none"> ● 4 TRUCK ★ CR 			
<ul style="list-style-type: none"> ● P-G-R-T TRUCK ★ CR 16/19 - CG 			



CABIN SHOCK ABSORBER	64061	1444016	312465
<ul style="list-style-type: none"> ● 4 TRUCK ★ 8X8 WLS/ZLS CR19 - CP 28/31 			
<ul style="list-style-type: none"> ● P-G-R-T TRUCK ★ CR 16/19 - CR 19 - CP 28/31 - CG 19 			



SHOCK ABSORBER	64741	1502468	
<ul style="list-style-type: none"> ● 4 TRUCK ★ CP/CR 14/19 CH 1292429 - CH 4501901 - CH 9083917 - CH 3547308 			
<ul style="list-style-type: none"> ● P-G-R-T TRUCK ★ CR16/19 - CP/CR16 - CP19 LOW - NORMAL - HIGH - CR19 LOW - NORMAL - CG/CP14 - CG16/19 			



ALL THE COMPONENTS LISTED IN OUR CATALOGUE ARE NOT ORIGINAL, THOUGH PERFECTLY INTERCHANGEABLE. REFERENCE NUMBERS, EITHER ORIGINAL OR OF A DIFFERENT NATURE, ARE FOR INFORMATION PURPOSES ONLY. WHEN PLACING AN ORDER, PLEASE, ALWAYS USE COSIBO REFERENCE NUMBERS AND DO NOT MENTION THE ORIGINAL REFERENCE NUMBERS OF THE TRUCK MANUFACTURERS IN THE INVOICE TO VEHICLE OWNERS OR TO ANYBODY ELSE. THE CUSTOMER TAKES HIS OWN RESPONSIBILITY IF HE DOES NOT COMPLY WITH WHAT ABOVE.

SHOCK ABSORBER



- Model
- ★ Application

Code

OEM new

OEM old

65097

1502472

- 4 TRUCK

- ★ CP/CR 14/19

ALL THE COMPONENTS LISTED IN OUR CATALOGUE ARE NOT ORIGINAL, THOUGH PERFECTLY INTERCHANGEABLE. REFERENCE NUMBERS, EITHER ORIGINAL OR OF A DIFFERENT NATURE, ARE FOR INFORMATION PURPOSES ONLY. WHEN PLACING AN ORDER, PLEASE, ALWAYS USE COSIBO REFERENCE NUMBERS AND DO NOT MENTION THE ORIGINAL REFERENCE NUMBERS OF THE TRUCK MANUFACTURERS IN THE INVOICE TO VEHICLE OWNERS OR TO ANYBODY ELSE. THE CUSTOMER TAKES HIS OWN RESPONSIBILITY IF HE DOES NOT COMPLY WITH WHAT ABOVE.

	Code	OEM new	OEM old
SLIDER	62540	1877664	
<ul style="list-style-type: none"> ● Model ★ Application 			
<ul style="list-style-type: none"> ● 4 TRUCK ★ 			



LH CAB MOLDING	62484	1504019	1366837
<ul style="list-style-type: none"> ● 4 TRUCK ★ CT 			
<ul style="list-style-type: none"> ● P-G-R-T TRUCK ★ CT 			



RH CAB MOLDING	62485	1504020	1366838
<ul style="list-style-type: none"> ● 4 TRUCK ★ CT 			
<ul style="list-style-type: none"> ● P-G-R-T TRUCK ★ CT 			



HOOD RUBBER RING	64102	1520867	1366836 1441240
<ul style="list-style-type: none"> ● 4 TRUCK ★ CT 			
<ul style="list-style-type: none"> ● P-G-R-T TRUCK ★ CT 			



ALL THE COMPONENTS LISTED IN OUR CATALOGUE ARE NOT ORIGINAL, THOUGH PERFECTLY INTERCHANGEABLE. REFERENCE NUMBERS, EITHER ORIGINAL OR OF A DIFFERENT NATURE, ARE FOR INFORMATION PURPOSES ONLY. WHEN PLACING AN ORDER, PLEASE, ALWAYS USE COSIBO REFERENCE NUMBERS AND DO NOT MENTION THE ORIGINAL REFERENCE NUMBERS OF THE TRUCK MANUFACTURERS IN THE INVOICE TO VEHICLE OWNERS OR TO ANYBODY ELSE. THE CUSTOMER TAKES HIS OWN RESPONSIBILITY IF HE DOES NOT COMPLY WITH WHAT ABOVE.

	Code	OEM new	OEM old
SEALING	62488	1346601	
			
● Model			
★ Application			
● 4 TRUCK			
★ CT			
● P-G-R-T TRUCK			
★ CT			

MOLDING	62536	1366781	
			
● 4 TRUCK			
★			
● P-G-R-T TRUCK			
★			

MOLDING	62537	1366735	
			
● 4 TRUCK			
★			
● P-G-R-T TRUCK			
★ CG/CP/CR/CT			

RUBBER BUFFER	62486	1341110	
			
● 4 TRUCK			
★ CP - CR			
● P-G-R-T TRUCK			
★ CP - CG - CR			

ALL THE COMPONENTS LISTED IN OUR CATALOGUE ARE NOT ORIGINAL, THOUGH PERFECTLY INTERCHANGEABLE. REFERENCE NUMBERS, EITHER ORIGINAL OR OF A DIFFERENT NATURE, ARE FOR INFORMATION PURPOSES ONLY. WHEN PLACING AN ORDER, PLEASE, ALWAYS USE COSIBO REFERENCE NUMBERS AND DO NOT MENTION THE ORIGINAL REFERENCE NUMBERS OF THE TRUCK MANUFACTURERS IN THE INVOICE TO VEHICLE OWNERS OR TO ANYBODY ELSE. THE CUSTOMER TAKES HIS OWN RESPONSIBILITY IF HE DOES NOT COMPLY WITH WHAT ABOVE.

	Code	OEM new	OEM old
RUBBER BUFFER	62487	1522464	1385829
<ul style="list-style-type: none"> ● Model ★ Application 			
<ul style="list-style-type: none"> ● 4 TRUCK ★ 			
<ul style="list-style-type: none"> ● P-G-R-T TRUCK ★ 			



DOOR SEALING	62294	1346425	1306379
<ul style="list-style-type: none"> ● 3 TRUCK ★ 			



DOOR SEALING	62319	336590	
<ul style="list-style-type: none"> ● 3 TRUCK ★ 			



ALL THE COMPONENTS LISTED IN OUR CATALOGUE ARE NOT ORIGINAL, THOUGH PERFECTLY INTERCHANGEABLE. REFERENCE NUMBERS, EITHER ORIGINAL OR OF A DIFFERENT NATURE, ARE FOR INFORMATION PURPOSES ONLY. WHEN PLACING AN ORDER, PLEASE, ALWAYS USE COSIBO REFERENCE NUMBERS AND DO NOT MENTION THE ORIGINAL REFERENCE NUMBERS OF THE TRUCK MANUFACTURERS IN THE INVOICE TO VEHICLE OWNERS OR TO ANYBODY ELSE. THE CUSTOMER TAKES HIS OWN RESPONSIBILITY IF HE DOES NOT COMPLY WITH WHAT ABOVE.

	Code	OEM new	OEM old
WINDSCREEN SEALING	62422	1366851	

- Model
- ★ Application

● 4 TRUCK

★



ALL THE COMPONENTS LISTED IN OUR CATALOGUE ARE NOT ORIGINAL, THOUGH PERFECTLY INTERCHANGEABLE. REFERENCE NUMBERS, EITHER ORIGINAL OR OF A DIFFERENT NATURE, ARE FOR INFORMATION PURPOSES ONLY. WHEN PLACING AN ORDER, PLEASE, ALWAYS USE COSIBO REFERENCE NUMBERS AND DO NOT MENTION THE ORIGINAL REFERENCE NUMBERS OF THE TRUCK MANUFACTURERS IN THE INVOICE TO VEHICLE OWNERS OR TO ANYBODY ELSE. THE CUSTOMER TAKES HIS OWN RESPONSIBILITY IF HE DOES NOT COMPLY WITH WHAT ABOVE.

	Code	OEM new	OEM old
SHOCK ABSORBER	64646	1110588	1111056 395063
● Model			
★ Application			
● 3 TRUCK			
★			



SHOCK ABSORBER	61850	272400	
● 3 TRUCK			
★ HK 4X4 6X6 - ADA 4X2A 6X2/4A - ADA+ASA 6X2A/B			



SHOCK ABSORBER	66623	258420	
● 3 TRUCK			
★ 4X2 6X2 6X2/4 AD - AD90 HL 4X2 6X2			



ALL THE COMPONENTS LISTED IN OUR CATALOGUE ARE NOT ORIGINAL, THOUGH PERFECTLY INTERCHANGEABLE. REFERENCE NUMBERS, EITHER ORIGINAL OR OF A DIFFERENT NATURE, ARE FOR INFORMATION PURPOSES ONLY. WHEN PLACING AN ORDER, PLEASE, ALWAYS USE COSIBO REFERENCE NUMBERS AND DO NOT MENTION THE ORIGINAL REFERENCE NUMBERS OF THE TRUCK MANUFACTURERS IN THE INVOICE TO VEHICLE OWNERS OR TO ANYBODY ELSE. THE CUSTOMER TAKES HIS OWN RESPONSIBILITY IF HE DOES NOT COMPLY WITH WHAT ABOVE.

FRONT AXLE SHOCK ABSORBER



● Model

★ Application

Code

OEM new

OEM old

63769

1861118

1388417
1420474
1421062
1861117

● 4 TRUCK

★ P/R 8X2/8X4 (2X30 2X32 3X29) PARABOLIC SPRING - P/R 8X2*6 (2X30 2X32 3X29) PARABOLIC SPRING - P/R AM620 - AM920 - B4X2 - B6X4 PARABOLIC SPRING

● P-G-R-T TRUCK

★ P/R.8X2*6 2X30.2X32.3X29 PARABOLIC SPRING

SHOCK ABSORBER



63019

1519631

1478507
1397523

● 4 TRUCK

★ ADA1100 4X2 6X2 6X2/4 6X4 - ADA1300 4X2 6X2/4 6X4 8X2/6 8X4 8X4/4 - ADA1500P+ASA700 - ASA1000 - ADA1300+ASA700 - ARA900 6X2 6X2/4

● P-G-R-T TRUCK

★ LA/LB - NA/NB - HA/HB - ASA 6X2 - ARA 6X2/4

SHOCK ABSORBER



62062

1867874

1370267

● 4 TRUCK

★

● P-G-R-T TRUCK

★

ALL THE COMPONENTS LISTED IN OUR CATALOGUE ARE NOT ORIGINAL, THOUGH PERFECTLY INTERCHANGEABLE. REFERENCE NUMBERS, EITHER ORIGINAL OR OF A DIFFERENT NATURE, ARE FOR INFORMATION PURPOSES ONLY. WHEN PLACING AN ORDER, PLEASE, ALWAYS USE COSIBO REFERENCE NUMBERS AND DO NOT MENTION THE ORIGINAL REFERENCE NUMBERS OF THE TRUCK MANUFACTURERS IN THE INVOICE TO VEHICLE OWNERS OR TO ANYBODY ELSE. THE CUSTOMER TAKES HIS OWN RESPONSIBILITY IF HE DOES NOT COMPLY WITH WHAT ABOVE.

	Code	OEM new	OEM old
SHOCK ABSORBER	65514	1861121	1478511
<ul style="list-style-type: none"> ● Model ★ Application 			
<ul style="list-style-type: none"> ● 4 TRUCK ★ 			
<ul style="list-style-type: none"> ● P-G-R-T TRUCK ★ 			



SHOCK ABSORBER	65515	1519633	1478509
<ul style="list-style-type: none"> ● 4 TRUCK ★ 			
<ul style="list-style-type: none"> ● P-G-R-T TRUCK ★ 			



SHOCK ABSORBER	62062	1867874	1370267
<ul style="list-style-type: none"> ● 4 TRUCK ★ 			
<ul style="list-style-type: none"> ● P-G-R-T TRUCK ★ 			



SHOCK ABSORBER	65514	1861121	1478511
<ul style="list-style-type: none"> ● 4 TRUCK ★ 			
<ul style="list-style-type: none"> ● P-G-R-T TRUCK ★ 			



ALL THE COMPONENTS LISTED IN OUR CATALOGUE ARE NOT ORIGINAL, THOUGH PERFECTLY INTERCHANGEABLE. REFERENCE NUMBERS, EITHER ORIGINAL OR OF A DIFFERENT NATURE, ARE FOR INFORMATION PURPOSES ONLY. WHEN PLACING AN ORDER, PLEASE, ALWAYS USE COSIBO REFERENCE NUMBERS AND DO NOT MENTION THE ORIGINAL REFERENCE NUMBERS OF THE TRUCK MANUFACTURERS IN THE INVOICE TO VEHICLE OWNERS OR TO ANYBODY ELSE. THE CUSTOMER TAKES HIS OWN RESPONSIBILITY IF HE DOES NOT COMPLY WITH WHAT ABOVE.

	Code	OEM new	OEM old
SHOCK ABSORBER	65515	1519633	1478509
<ul style="list-style-type: none"> ● Model ★ Application 			
<ul style="list-style-type: none"> ● 4 TRUCK ★ 			
<ul style="list-style-type: none"> ● P-G-R-T TRUCK ★ 			



SHOCK ABSORBER	64646	1110588	1111056 395063
-----------------------	--------------	---------	-------------------



<ul style="list-style-type: none"> ● 3 TRUCK ★
--

SHOCK ABSORBER	63700	1478502	1377056
-----------------------	--------------	---------	---------



<ul style="list-style-type: none"> ● 3 TRUCK ★
<ul style="list-style-type: none"> ● 3 TRUCK ★

ALL THE COMPONENTS LISTED IN OUR CATALOGUE ARE NOT ORIGINAL, THOUGH PERFECTLY INTERCHANGEABLE. REFERENCE NUMBERS, EITHER ORIGINAL OR OF A DIFFERENT NATURE, ARE FOR INFORMATION PURPOSES ONLY. WHEN PLACING AN ORDER, PLEASE, ALWAYS USE COSIBO REFERENCE NUMBERS AND DO NOT MENTION THE ORIGINAL REFERENCE NUMBERS OF THE TRUCK MANUFACTURERS IN THE INVOICE TO VEHICLE OWNERS OR TO ANYBODY ELSE. THE CUSTOMER TAKES HIS OWN RESPONSIBILITY IF HE DOES NOT COMPLY WITH WHAT ABOVE.

SHACKLE SPRING W/BUSHING



	Code	OEM new	OEM old
● Model	63556/1	1377739	1103026
★ Application			
● 3 BUS			
★ (TRAPEZOIDAL FRONT SPRING) AM 7X15			
● 3 TRUCK			
★ (TRAPEZOIDAL FRONT SPRING) 6X15 7X15 8X2 8X4 8X15 9X13 9X15 AM56 AM61 AM70 - MK HK 4X4 6X4 8X15 - HK 4X4 HK 6X6 AMD105 - EK 6X4 8X2 8X4 8X15 9X15 AM61 AM70 AM800 AM820 - (PARABOLIC FRONT SPRING) 2X28 2X30 2X32 3X29 AM - HK EK 6X4 3X29 2X30 2X32 AM - ML 8X4 4X22 AM - 3X29 EL 6X4 AM61 AM70 AM820 - 4X22 HL 8X2 AM - HK 8X4 EK 8X4 4X22 - 4X22 HL/EL 8X2 8X4 AM - EK 8X4 AM800 4X22 - MK 8X4 AM56 AM61 4X22 - MW 4X2A 2X30 AM			
● 4 BUS			
★ (TRAPEZOIDAL FRONT SPRING) 8X15 9X15 AM			
● 4 TRUCK			
★ (SUSPENSION SPRING) 2X30/32 3X29 4X28 7/9X15 8X2 8X4 8X2/6 ALSO 8X2/6 REAR - (PARABOLIC SPRING) 2X32 3X29 AMD900 AM901 - 8X8 WLS/ZLS 3X29 AMD900 FR AMD900 RE - 8X8 2X32 AMD900 AMD901 FR - 8X8 2X32 AMD900 RE - (TRAPEZOIDAL SPRING) 7X15 AMD900 AMD901			
● F-K-N BUS			
★ (TRAPEZOIDAL FRONT SPRING) 8X15 9X15 AM			
● P-G-R-T TRUCK			
★ (PARABOLIC FRONT SPRING) 2X30 2X32 3X29 4X28 - 2X32 3X29 AMD900 AMD901 - (SUSPENSION SPRING) 2X30/32 3X29 4X28 7/9X15 8X2 8X4 8X2/6 ALSO REAR - (TRAPEZOIDAL FRONT SPRING) 7X15 9X15 - 7X15 AMD900 AMD901			

ALL THE COMPONENTS LISTED IN OUR CATALOGUE ARE NOT ORIGINAL, THOUGH PERFECTLY INTERCHANGEABLE. REFERENCE NUMBERS, EITHER ORIGINAL OR OF A DIFFERENT NATURE, ARE FOR INFORMATION PURPOSES ONLY. WHEN PLACING AN ORDER, PLEASE, ALWAYS USE COSIBO REFERENCE NUMBERS AND DO NOT MENTION THE ORIGINAL REFERENCE NUMBERS OF THE TRUCK MANUFACTURERS IN THE INVOICE TO VEHICLE OWNERS OR TO ANYBODY ELSE. THE CUSTOMER TAKES HIS OWN RESPONSIBILITY IF HE DOES NOT COMPLY WITH WHAT ABOVE.

SHACKLE SPRING W/O BUSH



	Code	OEM new	OEM old
● Model	63556/2	63556/2	
★ Application			
● P-G-R-T TRUCK			
★	(PARABOLIC FRONT SPRING) 2X30 2X32 3X29 4X28 - 2X32 3X29 AMD900 AMD901 - (SUSPENSION SPRING) 2X30/32 3X29 4X28 7/9X15 8X2 8X4 8X2/6 ALSO REAR - (TRAPEZOIDAL FRONT SPRING) 7X15 9X15 - 7X15 AMD900 AMD901		
● F-K-N BUS			
★	(TRAPEZOIDAL FRONT SPRING) 8X15 9X15 AM		
● 3 TRUCK			
★	(TRAPEZOIDAL FRONT SPRING) 6X15 7X15 8X2 8X4 8X15 9X13 9X15 AM56 AM61 AM70 - MK HK 4X4 6X4 8X15 - HK 4X4 HK 6X6 AMD105 - EK 6X4 8X2 8X4 8X15 9X15 AM61 AM70 AM800 AM820 - (PARABOLIC FRONT SPRING) 2X28 2X30 2X32 3X29 AM - HK EK 6X4 3X29 2X30 2X32 AM - ML 8X4 4X22 AM - 3X29 EL 6X4 AM61 AM70 AM820 - 4X22 HL 8X2 AM - HK 8X4 EK 8X4 4X22 - 4X22 HL/EL 8X2 8X4 AM - EK 8X4 AM800 4X22 - MK 8X4 AM56 AM61 4X22 - MW 4X2A 2X30 AM		
● 4 TRUCK			
★	(SUSPENSION SPRING) 2X30/32 3X29 4X28 7/9X15 8X2 8X4 8X2/6 ALSO 8X2/6 REAR - (PARABOLIC SPRING) 2X32 3X29 AMD900 AM901 - 8X8 WLS/ZLS 3X29 AMD900 FR AMD900 RE - 8X8 2X32 AMD900 AMD901 FR - 8X8 2X32 AMD900 RE - (TRAPEZOIDAL SPRING) 7X15 AMD900 AMD901		
● 4 BUS			
★	(TRAPEZOIDAL FRONT SPRING) 8X15 9X15 AM		
● 3 BUS			
★	(TRAPEZOIDAL FRONT SPRING) AM 7X15		

ALL THE COMPONENTS LISTED IN OUR CATALOGUE ARE NOT ORIGINAL, THOUGH PERFECTLY INTERCHANGEABLE. REFERENCE NUMBERS, EITHER ORIGINAL OR OF A DIFFERENT NATURE, ARE FOR INFORMATION PURPOSES ONLY. WHEN PLACING AN ORDER, PLEASE, ALWAYS USE COSIBO REFERENCE NUMBERS AND DO NOT MENTION THE ORIGINAL REFERENCE NUMBERS OF THE TRUCK MANUFACTURERS IN THE INVOICE TO VEHICLE OWNERS OR TO ANYBODY ELSE. THE CUSTOMER TAKES HIS OWN RESPONSIBILITY IF HE DOES NOT COMPLY WITH WHAT ABOVE.

REPAIR SET



- Model
- ★ Application

Code	OEM new	OEM old
63898	552004	

- 3 TRUCK
- ★ AS90

U BOLT



- 3 BUS
- ★ AM 7X15

65298	276228	
-------	--------	--

- 3 TRUCK
- ★ AM56/61 - AM70 - AM800

U BOLT



- 3 TRUCK
- ★ AM56/61
- 4 TRUCK
- ★ 2X30/32 3X29 4X28 7/9X15 8X2 8X4 8X2/6
- P-G-R-T TRUCK
- ★ 2X30/32 3X29 4X28 7/9X15 8X2 8X4 8X2/6

64068	1726130	1384353
-------	---------	---------

ALL THE COMPONENTS LISTED IN OUR CATALOGUE ARE NOT ORIGINAL, THOUGH PERFECTLY INTERCHANGEABLE. REFERENCE NUMBERS, EITHER ORIGINAL OR OF A DIFFERENT NATURE, ARE FOR INFORMATION PURPOSES ONLY. WHEN PLACING AN ORDER, PLEASE, ALWAYS USE COSIBO REFERENCE NUMBERS AND DO NOT MENTION THE ORIGINAL REFERENCE NUMBERS OF THE TRUCK MANUFACTURERS IN THE INVOICE TO VEHICLE OWNERS OR TO ANYBODY ELSE. THE CUSTOMER TAKES HIS OWN RESPONSIBILITY IF HE DOES NOT COMPLY WITH WHAT ABOVE.

U BOLT



	Code	OEM new	OEM old
● Model	61550	1377799	363990
★ Application			
● 3 TRUCK			
★ ASA70/80 - ADA90			
● 4 TRUCK			
★ ADA1300 4X2 6X2 - ASA70 6X2 - ASA80			

REPAIR SET



	65380	65380	
● 3 TRUCK			
★ ASA70/80 - ADA90			
● 4 TRUCK			
★ ADA1300 4X2 6X2 - ASA70 6X2 - ASA80			

ALL THE COMPONENTS LISTED IN OUR CATALOGUE ARE NOT ORIGINAL, THOUGH PERFECTLY INTERCHANGEABLE. REFERENCE NUMBERS, EITHER ORIGINAL OR OF A DIFFERENT NATURE, ARE FOR INFORMATION PURPOSES ONLY. WHEN PLACING AN ORDER, PLEASE, ALWAYS USE COSIBO REFERENCE NUMBERS AND DO NOT MENTION THE ORIGINAL REFERENCE NUMBERS OF THE TRUCK MANUFACTURERS IN THE INVOICE TO VEHICLE OWNERS OR TO ANYBODY ELSE. THE CUSTOMER TAKES HIS OWN RESPONSIBILITY IF HE DOES NOT COMPLY WITH WHAT ABOVE.

	Code	OEM new	OEM old
SPRING BOLT	61313	1548054	255315
● Model			
★ Application			
● 3 TRUCK			
★	ASA80 ELC - 4X2A 6X2/4A ADA CH 1159364 - CH 4290503 - ML4X2A/B 6X2A/B 6X2/4A ADA ASA CH 1159365 - CH 4292504 - ML6X2A ADA ASA70 CH 1159364 - CH 4290503 - MA/MV4X2A MV4X2B ADA90 - MW4X2A/B ADA90 CH 1217086 - CH 1217087 - CH 4356549 - CH 4356550 - CH 9012600 - CH 9012601 - ML6X4A/B ADA ASA - MV6X2B ADA ASA - MA6X2A ADA90 ASA70 ASA80 - 6X2/4 ADA CH 1185688 - CH 4318985 - HL6X2A/B 6X4A/B 8X2A ADA ASA - ALL FOR PNEUMATIC SUSPENSION		
● 4 TRUCK			
★	ASA80 ELC - ADA1300 ELC 1.LA4X2NA.NB - 1.LB6X2NA.NB - ASA70 ELC LB6X2NA.NB - ADA1300/1500/1501 4X2 6X2 6X2*4 8X2 8X2/4 8X2*6 - ASA700 6X2 8X2 - ASA100 6X2 8X2 8X2/4 - ARA900 6X2*4 8X2*6 8X4*4 - ADA1100 6X2 4X2 CH 1247519 - CH 4406944 - CH 9039630 - CH 3507980 - ADA1100 4X2 CH 1247518 - CH 4406943 - CH 9039629 - CH 3507979 - ADA1100 6X2 CH 1247518 - CH 1247519 - CH 4406943 - CH 4406944 - CH 9039629 - CH 9039630 - CH 3507979 - CH 3507980 - 6X2/4L,REAR CH 1247518 - CH 4406943 - CH 9039629 - CH 3507979 ALL FOR PNEUMATIC SUSPENSION		
● P-G-R-T TRUCK			
★	ADA 4X2 6X2 6X4 6X2*4 8X2 8X2*6 8X4 8X4*4 - ASA 6X2 - ARA 6X2*4 8X2*6 ALL FOR PNEUMATIC SUSPENSION		
● 3 BUS			
★	ASA - ATA90 -		



	Code	OEM new	OEM old
U BOLT NUT M22	60915	1388823	265768 302768
<ul style="list-style-type: none"> ● Model ★ Application 			
<ul style="list-style-type: none"> ● 3 BUS 			
<ul style="list-style-type: none"> ★ 7X15+6X14/9X15+6X14 AD90 - 9X15 AD90 			
<ul style="list-style-type: none"> ● 3 TRUCK 			
<ul style="list-style-type: none"> ★ 4X2 5X17+5X15 AD - 4X2 7X15+6X14 AD80/AD90/AD100 - 4X2 9X15+6X14 AD80/AD90/AD100 - 4X2 3X24+2X26 AD80/AD90/AD100 - 4X2 3X26+2X26 AD80/AD90/AD100 - 4X2 2X34+1X34 AD80/AD90/AD100 - MA4X2 3X24+2X26 AD - MA4X2 2X34+1X34 AD80/AD90/AD100 - MA4X2 7X15+6X14 AD80/AD90/AD100 - MA4X2 9X15+6X14 AD90/AD100 - MA4X2 3X26+2X26 AD90/AD100 - HK4X4 7X15+6X14 AD - HK4X4 9X15+6X14 AD - 			
<ul style="list-style-type: none"> ● 4 BUS 			
<ul style="list-style-type: none"> ★ 9X15 AD 1300 - 10X15 AD 			
<ul style="list-style-type: none"> ● 4 TRUCK 			
<ul style="list-style-type: none"> ★ 4X2 3X26+2X26 AD1300 - 4X2 7X15+6X14 AD1300 - 4X2 9X15+6X14 AD1300/AD1500P/AD1501P - 4X4 9X15+6X14 AD1500P/AD1501P - 6X2 8X2 1X15+10X13 AD - 6X2 8X2 5X22 AD - 4X4 3X26+2X26 AD1500P 			
<ul style="list-style-type: none"> ● F-K-N BUS 			
<ul style="list-style-type: none"> ★ 9X15/10X15 AD 			
<ul style="list-style-type: none"> ● P-G-R-T TRUCK 			
<ul style="list-style-type: none"> ★ 1X15+10X13 - 3X26+2X26 - 4X4 3X26+2X26 AD1500P - 4X4 9X15+6X14 AD1500P - 5X22 - 6X2 8X2 1X15+10X13 AD - 7X15+6X14 - 9X15+6X14 - 12X15+6X14 			



	Code	OEM new	OEM old
U BOLT NUT M24	65027	1805380	1369806
<ul style="list-style-type: none"> ● 3 BUS 			
<ul style="list-style-type: none"> ★ AD 11X15 - ADA - ADA90 OSC11 			
<ul style="list-style-type: none"> ● 4 BUS 			
<ul style="list-style-type: none"> ★ ADA1300 IB/EB/UB - ASA1300 			
<ul style="list-style-type: none"> ● F-K-N BUS 			
<ul style="list-style-type: none"> ★ ADA1300 - ASA1300 			
<ul style="list-style-type: none"> ● 3 TRUCK 			
<ul style="list-style-type: none"> ★ AD - ADA - ADA90 - ASA - ASA70 - ASA80 			
<ul style="list-style-type: none"> ● 4 TRUCK 			
<ul style="list-style-type: none"> ★ ADA1300 - ASA 80 - 6X2 8X2 1X15+10X13 AD 			



SPRING BOLT L=248 mm



	Code	OEM new	OEM old
● Model	64726	1548055	1338491
★ Application			
● 3 TRUCK			
★ ADA - ASA			
● 4 TRUCK			
★ ADA1300/1500/1501 - ASA700/1000 - ARA900 - ADA1100 - ADA1100 F958			
● P-G-R-T TRUCK			
★ ADA 4X2 6X2 6X2/4 6X4 8X2 8X2/6 8X4 8X4/4 - ASA 6X2 - ARA6X2/4 8X2/6 8X4/4 - ADA1300 8X4/4 F950/F958 AD FR - AD F RE - ADA1100 6X4 8X4 AD FR - AD RE - ADA1501P 6X4 8X4 8X4/4 AD FR - AD RE - ASA 8X2/4			
● 4 BUS			
★ F94 6X2			

RUBBER BUFFER



	Code	OEM new	OEM old
	60962	241922	
● 3 TRUCK			
★ AM - ADA - ADA+ASA - ARA			

RUBBER BUFFER



	Code	OEM new	OEM old
	60961	153287	
● 3 TRUCK			
★ AM - AD/AS90 - ADA - ASA - ADA+ASA - AS60 - ARA			

ALL THE COMPONENTS LISTED IN OUR CATALOGUE ARE NOT ORIGINAL, THOUGH PERFECTLY INTERCHANGEABLE. REFERENCE NUMBERS, EITHER ORIGINAL OR OF A DIFFERENT NATURE, ARE FOR INFORMATION PURPOSES ONLY. WHEN PLACING AN ORDER, PLEASE, ALWAYS USE COSIBO REFERENCE NUMBERS AND DO NOT MENTION THE ORIGINAL REFERENCE NUMBERS OF THE TRUCK MANUFACTURERS IN THE INVOICE TO VEHICLE OWNERS OR TO ANYBODY ELSE. THE CUSTOMER TAKES HIS OWN RESPONSIBILITY IF HE DOES NOT COMPLY WITH WHAT ABOVE.

	Code	OEM new	OEM old
WASHER	61315	272449	
	<ul style="list-style-type: none"> ● Model ★ Application 		
	<ul style="list-style-type: none"> ● 3 TRUCK ★ ADA+ASA70 		
RUBBER BUFFER	65242	423730	
	<ul style="list-style-type: none"> ● 3 BUS ★ AD90 - ADA90 OSC11 - ADA90 		
	<ul style="list-style-type: none"> ● 4 BUS ★ ADA1300 IB/EB 		
RUBBER RING	62238	307113	
	<ul style="list-style-type: none"> ● 3 BUS ★ AD - AM 		
	<ul style="list-style-type: none"> ● 3 TRUCK ★ AM - AMA - AD90 - AD/ADA - ADA+ASA - ARA 		
	<ul style="list-style-type: none"> ● 4 TRUCK ★ 94 - 114 - 124 - 144 - 164 		
	<ul style="list-style-type: none"> ● F-K-N BUS ★ 		
	<ul style="list-style-type: none"> ● P-G-R-T TRUCK ★ 		

ALL THE COMPONENTS LISTED IN OUR CATALOGUE ARE NOT ORIGINAL, THOUGH PERFECTLY INTERCHANGEABLE. REFERENCE NUMBERS, EITHER ORIGINAL OR OF A DIFFERENT NATURE, ARE FOR INFORMATION PURPOSES ONLY. WHEN PLACING AN ORDER, PLEASE, ALWAYS USE COSIBO REFERENCE NUMBERS AND DO NOT MENTION THE ORIGINAL REFERENCE NUMBERS OF THE TRUCK MANUFACTURERS IN THE INVOICE TO VEHICLE OWNERS OR TO ANYBODY ELSE. THE CUSTOMER TAKES HIS OWN RESPONSIBILITY IF HE DOES NOT COMPLY WITH WHAT ABOVE.

	Code	OEM new	OEM old
RUBBER BUFFER	61220	213604	
<ul style="list-style-type: none"> ● Model ★ Application 			
<ul style="list-style-type: none"> ● 3 BUS ★ AM/AMA 			
<ul style="list-style-type: none"> ● 3 TRUCK ★ AM56/61/70 - AMD105 			
<ul style="list-style-type: none"> ● 4 TRUCK ★ AMD900/901 - AMA 			
<ul style="list-style-type: none"> ● P-G-R-T TRUCK ★ 			



RUBBER BUFFER	61303	228483	
<ul style="list-style-type: none"> ● 3 BUS ★ AM/AMA 			
<ul style="list-style-type: none"> ● 3 TRUCK ★ AM56/61/70 - AMD105 			
<ul style="list-style-type: none"> ● 4 TRUCK ★ AMD900/901 - AMA 			
<ul style="list-style-type: none"> ● P-G-R-T TRUCK ★ 			



RUBBER BUSHING



	Code	OEM new	OEM old
● Model	61305	1477867	1429110
★ Application			310808
● 3 BUS			
★	AM56/61 - AD - ADA - AD90		
● 3 TRUCK			
★	AMA - AM56/61		
● 4 BUS			
★	ADA1300D EB - ADA1300 4X2 IB/UD - AD1300 - ADA1300 6X2 IB/UB 8X2 IB - AM - ASA701		
● 4 TRUCK			
★	AMA		
● F-K-N BUS			
★			
● P-G-R-T TRUCK			
★	4X2 6X2 6X2/2 8X2 - 6X4 8X4 BT201/300		

RUBBER BUFFER



	63287	295751	
● 3 BUS			
★			
● 3 TRUCK			
★			
● 4 TRUCK			
★			
● P-G-R-T TRUCK			
★			

ALL THE COMPONENTS LISTED IN OUR CATALOGUE ARE NOT ORIGINAL, THOUGH PERFECTLY INTERCHANGEABLE. REFERENCE NUMBERS, EITHER ORIGINAL OR OF A DIFFERENT NATURE, ARE FOR INFORMATION PURPOSES ONLY. WHEN PLACING AN ORDER, PLEASE, ALWAYS USE COSIBO REFERENCE NUMBERS AND DO NOT MENTION THE ORIGINAL REFERENCE NUMBERS OF THE TRUCK MANUFACTURERS IN THE INVOICE TO VEHICLE OWNERS OR TO ANYBODY ELSE. THE CUSTOMER TAKES HIS OWN RESPONSIBILITY IF HE DOES NOT COMPLY WITH WHAT ABOVE.

	Code	OEM new	OEM old
RUBBER BUFFER	60580	306902	
● Model			
★ Application			
● 3 BUS			
★ ADA - AMA - ADA90 OSC11			
● 3 TRUCK			
★ AM56/61/70 - AMD105 - AM800/820			
● 4 BUS			
★ ADA1300 IB/EB/UB - ASA1300			
● F-K-N BUS			
★ ADA/ASA1300			



	64791	1373793	
SEAL RING			
● F-K-N BUS			
★			
● P-G-R-T TRUCK			
★			



	61734	339188	
RUBBER RING			
● 3 BUS			
★ AM - AMI - ASA			
● 3 TRUCK			
★ AM/AMA - ADA - ADA+ASA			
● 4 BUS			
★ AM			
● 4 TRUCK			
★ AMD900/901 - AM620/621/740/820/900/920 - ADA1300 - ASA70/80 - AD1300 BT 200I/B BT201I/B - AD1100P/1500P - AD1100P BT200I/B BT201I/B			
● P-G-R-T TRUCK			
★ P/R			



ALL THE COMPONENTS LISTED IN OUR CATALOGUE ARE NOT ORIGINAL, THOUGH PERFECTLY INTERCHANGEABLE. REFERENCE NUMBERS, EITHER ORIGINAL OR OF A DIFFERENT NATURE, ARE FOR INFORMATION PURPOSES ONLY. WHEN PLACING AN ORDER, PLEASE, ALWAYS USE COSIBO REFERENCE NUMBERS AND DO NOT MENTION THE ORIGINAL REFERENCE NUMBERS OF THE TRUCK MANUFACTURERS IN THE INVOICE TO VEHICLE OWNERS OR TO ANYBODY ELSE. THE CUSTOMER TAKES HIS OWN RESPONSIBILITY IF HE DOES NOT COMPLY WITH WHAT ABOVE.

	Code	OEM new	OEM old
RUBBER BUFFER	62233	1344190	
<ul style="list-style-type: none"> ● Model ★ Application 			
<ul style="list-style-type: none"> ● 3 TRUCK ★ AMA - AD 			
<ul style="list-style-type: none"> ● 4 BUS ★ AMA860 			
<ul style="list-style-type: none"> ● 4 TRUCK ★ AMA - ARA820 - AMD900/901 - BT200I/B BT201I/B BT300I/B - BT300I 6X6 			
<ul style="list-style-type: none"> ● P-G-R-T TRUCK ★ BT201/300 6X4 8X4 - 6X2/4 8X2/4 			



	62235	423736	
RUBBER BUFFER			
<ul style="list-style-type: none"> ● 3 BUS ★ AM/AMA 			
<ul style="list-style-type: none"> ● 4 BUS ★ AMA - AMA FR RE 8X2 			



	62236	1322341	
LH RUBBER BUFFER			
<ul style="list-style-type: none"> ● 4 TRUCK ★ 2X30/32 3X29 4X28 7/9X15 8X2 8X4 8X2/6 - 2X3 3X29 7X15 AMD900/901 - 8X8 WLS/ZLS 3X29 AMD900 FR/RE - 8X8 2X32 AMD900/901 FR/RE 			
<ul style="list-style-type: none"> ● P-G-R-T TRUCK ★ 2X30 2X32 3X29 4X28 7X15 8X2 8X4 8X2/6 9X15 - 2X32 3X29 7X15 AMD900/901 			



RH RUBBER BUFFER



	Code	OEM new	OEM old
● Model ★ Application	62237	1324366	
● 4 TRUCK			
★	2X30/32 3X29 4X28 7/9X15 8X2 8X4 8X2/6 - 2X3 3X29 7X15 AMD900/901 - 8X8 WLS/ZLS 3X29 AMD900 FR/RE - 8X8 2X32 AMD900/901 FR/RE		
● P-G-R-T TRUCK			
★	2X30 2X32 3X29 4X28 7X15 8X2 8X4 8X2/6 9X15 - 2X32 3X29 7X15 AMD900/901		

SPACER TUBE



	61306	213606	
● 3 BUS			
★	AM56/61		
● 3 TRUCK			
★	AM56/61/70 - AMD105		
● 4 BUS			
★	AM		
● F-K-N BUS			
★	AM		

BUSHING



	61307	213607	
● 3 BUS			
★	AM56/61		
● 3 TRUCK			
★	AM56/61/70 - AMD105		
● 4 BUS			
★	AM		

ALL THE COMPONENTS LISTED IN OUR CATALOGUE ARE NOT ORIGINAL, THOUGH PERFECTLY INTERCHANGEABLE. REFERENCE NUMBERS, EITHER ORIGINAL OR OF A DIFFERENT NATURE, ARE FOR INFORMATION PURPOSES ONLY. WHEN PLACING AN ORDER, PLEASE, ALWAYS USE COSIBO REFERENCE NUMBERS AND DO NOT MENTION THE ORIGINAL REFERENCE NUMBERS OF THE TRUCK MANUFACTURERS IN THE INVOICE TO VEHICLE OWNERS OR TO ANYBODY ELSE. THE CUSTOMER TAKES HIS OWN RESPONSIBILITY IF HE DOES NOT COMPLY WITH WHAT ABOVE.

	Code	OEM new	OEM old
NUT M30X3,5	61314	811911	816089
<ul style="list-style-type: none"> ● Model ★ Application 			
<ul style="list-style-type: none"> ● 3 TRUCK 			
★ ASA80 ELC 1.19 TONS - ADA - ADA90 - ASA70/80 - R113/143			
<ul style="list-style-type: none"> ● 4 TRUCK 			
★ ADA1300 ELC 1.LA4X2NA NB - 1LB6X2NA NB - ASA80 ELC 1.19 TONS - ASA70 ELC 1.19 9 TONS LB6X2 NA NB - ADA1300/1500/1501 4X2 6X2/4 6X4 8X4 - ASA700 6X2 8X2 - ASA1000 6X2 8X2 8X2/4 - ARA900 6X2/4 8X2/6 8X4/4 - ADA1100 4X2 6X2 - ADA1300 8X4/4 F958 AD FR - AD RE - ADA1100 6X4 8X4 F958 AD FR - AD RE			
<ul style="list-style-type: none"> ● P-G-R-T TRUCK 			
★ ADA 4X2 6X2 6X2/4 6X4 8X2 8X2/6 8X4 8X4/4 - ASA 6X2 8X2/4 - ARA 6X2/4 8X2/6 8X4/X4 - ADA1300 8X4/4 F950/F958 AD FR - AD RE - ADA1100 6X4 8X4 AD FR - AD RE - ADA1300 6X4 8X4 AD FR - AD R - ADA1501P 6X4 8X4 8X4/4 AD FR - AD RE			
<ul style="list-style-type: none"> ● 3 BUS 			
★ ASA - ATA90			
<ul style="list-style-type: none"> ● 4 BUS 			
★ F94 6X2			



	64739	64739	
MOUNTING SET			
<ul style="list-style-type: none"> ● 3 BUS 			
★ ASA - ATA90 -			
<ul style="list-style-type: none"> ● 3 TRUCK 			
★ ASA80 ELC - 4X2A 6X2/4A ADA CH 1159364 - CH 4290503 - ML4X2A/B 6X2A/B 6X2/4A ADA ASA CH 1159365 - CH 4292504 - ML6X2A ADA ASA70 CH 1159364 - CH 4290503 - MA/MV4X2A MV4X2B ADA90 - MW4X2A/B ADA90 CH 1217086 - CH 1217087 - CH 4356549 - CH 4356550 - CH 9012600 - CH 9012601 - ML6X4A/B ADA ASA - MV6X2B ADA ASA - MA6X2A ADA90 ASA70 ASA80 - 6X2/4 ADA CH 1185688 - CH 4318985 - HL6X2A/B 6X4A/B 8X2A ADA ASA - ALL FOR PNEUMATIC SUSPENSION			
<ul style="list-style-type: none"> ● 4 TRUCK 			
★ ASA80 ELC - ADA1300 ELC 1.LA4X2NA.NB - 1.LB6X2NA.NB - ASA70 ELC LB6X2NA.NB - ADA1300/1500/1501 4X2 6X2 6X2*4 8X2 8X2/4 8X2*6 - ASA700 6X2 8X2 - ASA100 6X2 8X2 8X2/4 - ARA900 6X2*4 8X2*6 8X4*4 - ADA1100 6X2 4X2 CH 1247519 - CH 4406944 - CH 9039630 - CH 3507980 - ADA1100 4X2 CH 1247518 - CH 4406943 - CH 9039629 - CH 3507979 - ADA1100 6X2 CH 1247518 - CH 1247519 - CH 4406943 - CH 4406944 - CH 9039629 - CH 9039630 - CH 3507979 - CH 3507980 - 6X2/4L, REAR CH 1247518 - CH 4406943 - CH 9039629 - CH 3507979 ALL FOR PNEUMATIC SUSPENSION			
<ul style="list-style-type: none"> ● P-G-R-T TRUCK 			
★ ADA 4X2 6X2 6X4 6X2*4 8X2 8X2*6 8X4 8X4*4 - ASA 6X2 - ARA 6X2*4 8X2*6 ALL FOR PNEUMATIC SUSPENSION			



ALL THE COMPONENTS LISTED IN OUR CATALOGUE ARE NOT ORIGINAL, THOUGH PERFECTLY INTERCHANGEABLE. REFERENCE NUMBERS, EITHER ORIGINAL OR OF A DIFFERENT NATURE, ARE FOR INFORMATION PURPOSES ONLY. WHEN PLACING AN ORDER, PLEASE, ALWAYS USE COSIBO REFERENCE NUMBERS AND DO NOT MENTION THE ORIGINAL REFERENCE NUMBERS OF THE TRUCK MANUFACTURERS IN THE INVOICE TO VEHICLE OWNERS OR TO ANYBODY ELSE. THE CUSTOMER TAKES HIS OWN RESPONSIBILITY IF HE DOES NOT COMPLY WITH WHAT ABOVE.

MOUNTING SET



	Code	OEM new	OEM old
● Model	64738	64738	
★ Application			
● 3 TRUCK			
★ ADA - ASA			
● 4 TRUCK			
★ ADA1300/1500/1501 - ASA700/1000 - ARA900 - ADA1100 - ADA1100 F958			
● P-G-R-T TRUCK			
★ ADA 4X2 6X2 6X2/4 6X4 8X2 8X2/6 8X4 8X4/4 - ASA 6X2 - ARA6X2/4 8X2/6 8X4/4 - ADA1300 8X4/4 F950/F958 AD FR - AD F RE - ADA1100 6X4 8X4 AD FR - AD RE - ADA1501P 6X4 8X4 8X4/4 AD FR - AD RE - ASA 8X2/4			
● 4 BUS			
★ F94 6X2			

WASHER



	61858	1367370	
● 3 TRUCK			
★ ADA - ASA			
● 4 TRUCK			
★ ADA1300/1500/1501 - ASA700/1000 - ARA900 - ADA1100 - ADA1100 F958			
● P-G-R-T TRUCK			
★ ADA 4X2 6X2 6X2/4 6X4 8X2 8X2/6 8X4 8X4/4 - ASA 6X2 - ARA6X2/4 8X2/6 8X4/4 - ADA1300 8X4/4 F950/F958 AD FR - AD F RE - ADA1100 6X4 8X4 AD FR - AD RE - ADA1501P 6X4 8X4 8X4/4 AD FR - AD RE - ASA 8X2/4			
● 4 BUS			
★ F94 6X2			

ALL THE COMPONENTS LISTED IN OUR CATALOGUE ARE NOT ORIGINAL, THOUGH PERFECTLY INTERCHANGEABLE. REFERENCE NUMBERS, EITHER ORIGINAL OR OF A DIFFERENT NATURE, ARE FOR INFORMATION PURPOSES ONLY. WHEN PLACING AN ORDER, PLEASE, ALWAYS USE COSIBO REFERENCE NUMBERS AND DO NOT MENTION THE ORIGINAL REFERENCE NUMBERS OF THE TRUCK MANUFACTURERS IN THE INVOICE TO VEHICLE OWNERS OR TO ANYBODY ELSE. THE CUSTOMER TAKES HIS OWN RESPONSIBILITY IF HE DOES NOT COMPLY WITH WHAT ABOVE.

	Code	OEM new	OEM old
RUBBERED BUSHING	61859	1362710	255669
<ul style="list-style-type: none"> ● Model ★ Application 			
<ul style="list-style-type: none"> ● 3 TRUCK ★ ASA80 ELC - 4X2A 6X2/4A ADA - ML4X2A/B 6X2A/B 6X2/4A ADA ASA - ML6X2A ADA ASA70 - MA/MV4X2A MV4X2B ADA90 - MW4X2A/B ADA90 - ML6X4A/B ADA ASA - MV6X2B ADA ASA - MA6X2A ADA90 ASA70 ASA80 - 6X2/4 ADA - HL6X2A/B 6X4A/B 8X2A ADA ASA - ALL FOR PNEUMATIC SUSPENSION 			
<ul style="list-style-type: none"> ● 4 TRUCK ★ ASA80 ELC - ADA1300 ELC 1.LA4X2NA.NB - 1.LB6X2NA.NB - ASA70 ELC LB6X2NA.NB - ADA1300/1500/1501 4X2 6X2 6X2*4 8X2 8X2/4 8X2*6 - ASA700 6X2 8X2 - ASA100 6X2 8X2 8X2/4 - ARA900 6X2*4 8X2*6 8X4*4 - ADA1100 6X2 4X2 - ADA1100 4X2 - ADA1100 6X2 - 6X2/4L,REAR ALL FOR PNEUMATIC SUSPENSION 			
<ul style="list-style-type: none"> ● P-G-R-T TRUCK ★ ADA 4X2 6X2 6X4 6X2*4 8X2 8X2*6 8X4 8X4*4 - ASA 6X2 - ARA 6X2*4 8X2*6 ALL FOR PNEUMATIC SUSPENSION 			
<ul style="list-style-type: none"> ● 3 BUS ★ ASA - ATA90 			



RUBBERED BUSHING	60252	362385	
<ul style="list-style-type: none"> ● 3 TRUCK ★ ML6X2A ADA - ASA70 			



SPRING BRACKET	60912	1377728	202335
<ul style="list-style-type: none"> ● 3 TRUCK ★ PARABOLIC SPRING 4X23 5X22 AD6X2 8X2 			



ALL THE COMPONENTS LISTED IN OUR CATALOGUE ARE NOT ORIGINAL, THOUGH PERFECTLY INTERCHANGEABLE. REFERENCE NUMBERS, EITHER ORIGINAL OR OF A DIFFERENT NATURE, ARE FOR INFORMATION PURPOSES ONLY. WHEN PLACING AN ORDER, PLEASE, ALWAYS USE COSIBO REFERENCE NUMBERS AND DO NOT MENTION THE ORIGINAL REFERENCE NUMBERS OF THE TRUCK MANUFACTURERS IN THE INVOICE TO VEHICLE OWNERS OR TO ANYBODY ELSE. THE CUSTOMER TAKES HIS OWN RESPONSIBILITY IF HE DOES NOT COMPLY WITH WHAT ABOVE.

SPRING BRACKET



- Model
- ★ Application

Code

OEM new

OEM old

60909

275460

- **3 TRUCK**

- ★ AM61/70 - AM800/820

SPRING BRACKET



- **3 TRUCK**

- ★ F700 - F800 - F950 - F954

- **3 BUS**

- ★ F950

60554

283642

	Code	OEM new	OEM old
SPRING BOLT	60914	355145	128681
● Model			
★ Application			
● 3 TRUCK			
★ AM56/61/70 - AMD105 - AM800/820			
● 4 TRUCK			
★ 8X2 8X4 8X2/6 8X8 - AMD900/901			
● P-G-R-T TRUCK			
★ 2X30 2X32 3X29 4X28 7X15 8X2 8X4 8X2/6 9X15 - 2X32 3X29 7X15 AMD900/901			
● 3 BUS			
★ AM56/61			
● 4 BUS			
★ 8X15 9X15 AM			
● F-K-N BUS			
★ 8X15 9X15 AM			



	60916	128680	
SPRING BUSHING			
● 3 TRUCK			
★ AM56/61/70 - AMD105 - AM800/820			
● 4 TRUCK			
★ 8X2 8X4 8X2/6 8X8 - AMD900/901			
● P-G-R-T TRUCK			
★ 2X30 2X32 3X29 4X28 7X15 8X2 8X4 8X2/6 9X15 - 2X32 3X29 7X15 AMD900/901			
● 3 BUS			
★ AM56/61			
● 4 BUS			
★ 8X15 9X15 AM			
● F-K-N BUS			
★ 8X15 9X15 AM			



	Code	OEM new	OEM old
SPRING BOLT	60913	355147	135035
● Model			
★ Application			
● 3 TRUCK			
★ AD80/90/100 - AD1500P - ARA			
● 4 TRUCK			
★ AD1300 4X2 - AD1500P 4X2 4X4 - AD1501P 4X2 4X4 - ARA820 ARA760 6X2/4 8X2/4			
● P-G-R-T TRUCK			
★ 3X26 2X26 - 7X15 6X14 - 9X15 6X14 - 12X15.6X14 - 4X4 3X26.2X26 AD1500P - 4X4 9X15.6X14 AD1500P - ASA 6X2/2 ARA 6X2/4 - 8X2/4			
● 3 BUS			
★ AD 11X15 - AD90 9X15			
● 4 BUS			
★ 10X15 AD - AD1300 9X15			
● F-K-N BUS			
★ 9X15 10X15 AD			



	60917	135036	
SPRING BUSHING			
● 3 TRUCK			
★ AD80/90/100 - AD1500P - ARA			
● 4 TRUCK			
★ AD1300 4X2 - AD1500P 4X2 4X4 - AD1501P 4X2 4X4 - ARA820 ARA760 6X2/4 8X2/4			
● P-G-R-T TRUCK			
★ 3X26 2X26 - 7X15 6X14 - 9X15 6X14 - 12X15.6X14 - 4X4 3X26.2X26 AD1500P - 4X4 9X15.6X14 AD1500P - ASA 6X2/2 ARA 6X2/4 - 8X2/4			
● 3 BUS			
★ AD 11X15 - AD90 9X15			
● 4 BUS			
★ 10X15 AD - AD1300 9X15			
● F-K-N BUS			
★ 9X15 10X15 AD			



SPRING BOLT



	Code	OEM new	OEM old
● Model	60920	355148	202333
★ Application			
● 3 TRUCK			
★ AD 6X2 8X2			
● 4 TRUCK			
★ AD 6X2 8X2			
● P-G-R-T TRUCK			
★ 5X22 - 1X15.10X13 - AD 6X2 8X2			

SPRING BUSHING



	60921	135698	
● 3 TRUCK			
★ AD 6X2 8X2			
● 4 TRUCK			
★ AD 6X2 8X2			
● P-G-R-T TRUCK			
★ 5X22 - 1X15.10X13 - AD 6X2 8X2			

O-RING



	60918	182929	
● 3 TRUCK			
★ AM56/61/70 - AMD105 HK4X4 HK6X6 - AM800/820 - 8X2 8X4			
● 4 TRUCK			
★ 2X30/32 3X29 4X28 7/9X15 8X2 8X4 8X2/6 - 2X32 3X29 7X15 8X8 AMD900/901 - 8X8 WLS/ZLS 3X29 AMD900			
● P-G-R-T TRUCK			
★ 2X30 2X32 3X29 4X28 7X15 8X2 8X4 8X2/6 9X15 - 2X32 3X29 7X15 AMD900/901			
● 3 BUS			
★ AM56/61 - AM 7X15 8X15			
● 4 BUS			
★ 8X15 9X15 AM			
● F-K-N BUS			
★ 8X15 9X15 AM			

ALL THE COMPONENTS LISTED IN OUR CATALOGUE ARE NOT ORIGINAL, THOUGH PERFECTLY INTERCHANGEABLE. REFERENCE NUMBERS, EITHER ORIGINAL OR OF A DIFFERENT NATURE, ARE FOR INFORMATION PURPOSES ONLY. WHEN PLACING AN ORDER, PLEASE, ALWAYS USE COSIBO REFERENCE NUMBERS AND DO NOT MENTION THE ORIGINAL REFERENCE NUMBERS OF THE TRUCK MANUFACTURERS IN THE INVOICE TO VEHICLE OWNERS OR TO ANYBODY ELSE. THE CUSTOMER TAKES HIS OWN RESPONSIBILITY IF HE DOES NOT COMPLY WITH WHAT ABOVE.

	Code	OEM new	OEM old
O-RING	60919	182931	
<ul style="list-style-type: none"> ● Model ★ Application 			
<ul style="list-style-type: none"> ● 3 TRUCK 			
<ul style="list-style-type: none"> ★ AM56/61/70 - AMD105 HK4X4 HK6X6 - AM800/820 - 8X2 8X4 			
<ul style="list-style-type: none"> ● 4 TRUCK 			
<ul style="list-style-type: none"> ★ 2X30/32 3X29 4X28 7/9X15 8X2 8X4 8X2/6 - 2X32 3X29 7X15 8X8 AMD900/901 - 8X8 WLS/ZLS 3X29 AMD900 			
<ul style="list-style-type: none"> ● P-G-R-T TRUCK 			
<ul style="list-style-type: none"> ★ 2X30 2X32 3X29 4X28 7X15 8X2 8X4 8X2/6 9X15 - 2X32 3X29 7X15 AMD900/901 			
<ul style="list-style-type: none"> ● 3 BUS 			
<ul style="list-style-type: none"> ★ AM56/61 - AM 7X15 8X15 			
<ul style="list-style-type: none"> ● 4 BUS 			
<ul style="list-style-type: none"> ★ 8X15 9X15 AM 			
<ul style="list-style-type: none"> ● F-K-N BUS 			
<ul style="list-style-type: none"> ★ 8X15 9X15 AM 			



RUBBER BUFFER	62134	275698	
<ul style="list-style-type: none"> ● 3 TRUCK 			
<ul style="list-style-type: none"> ★ 			
<ul style="list-style-type: none"> ● 4 BUS 			
<ul style="list-style-type: none"> ★ 			
<ul style="list-style-type: none"> ● 4 TRUCK 			
<ul style="list-style-type: none"> ★ 			
<ul style="list-style-type: none"> ● F-K-N BUS 			
<ul style="list-style-type: none"> ★ 			
<ul style="list-style-type: none"> ● P-G-R-T TRUCK 			
<ul style="list-style-type: none"> ★ 			



ALL THE COMPONENTS LISTED IN OUR CATALOGUE ARE NOT ORIGINAL, THOUGH PERFECTLY INTERCHANGEABLE. REFERENCE NUMBERS, EITHER ORIGINAL OR OF A DIFFERENT NATURE, ARE FOR INFORMATION PURPOSES ONLY. WHEN PLACING AN ORDER, PLEASE, ALWAYS USE COSIBO REFERENCE NUMBERS AND DO NOT MENTION THE ORIGINAL REFERENCE NUMBERS OF THE TRUCK MANUFACTURERS IN THE INVOICE TO VEHICLE OWNERS OR TO ANYBODY ELSE. THE CUSTOMER TAKES HIS OWN RESPONSIBILITY IF HE DOES NOT COMPLY WITH WHAT ABOVE.

SPRING BRACKET SET



	Code	OEM new	OEM old
● Model	63813	63813	
★ Application			
● P-G-R-T TRUCK			
★ 2X30 2X32 3X29 4X28 7X15 8X2 8X4 8X2/6 9X15 - 2X32 3X29 7X15 AMD900/901 COMPOSED BY: NO.1 PC 60914 - NO.1 PC 60916 - NO.2 PCS 60918			
● F-K-N BUS			
★ 8X15 9X15 AM COMPOSED BY: NO.1 PC 60914 - NO.1 PC 60916 - NO.2 PCS 60918			
● 4 BUS			
★ 8X15 9X15 AM COMPOSED BY: NO.1 PC 60914 - NO.1 PC 60916 - NO.2 PCS 60918			
● 4 TRUCK			
★ 8X2 8X4 8X2/6 8X8 - AMD900/901 COMPOSED BY: NO.1 PC 60914 - NO.1 PC 60916 - NO.2 PCS 60918			
● 3 BUS			
★ AM56/61 COMPOSED BY: NO.1 PC 60914 - NO.1 PC 60916 - NO.2 PCS 60918			
● 3 TRUCK			
★ AM56/61/70 - AMD105 - AM800/820 COMPOSED BY: NO.1 PC 60914 - NO.1 PC 60916 - NO.2 PCS 60918			

SPRING BRACKET SET



	63812	63812	
● 4 BUS			
★ 10X15 AD - AD1300 9X15 COMPOSED BY: NO.1 PC 60913 - NO.1 PC 60917 - NO.2 PCS 60919			
● P-G-R-T TRUCK			
★ 3X26 2X26 - 7X15 6X14 - 9X15 6X14 - 12X15.6X14 - 4X4 3X26.2X26 AD1500P - 4X4 9X15.6X14 AD1500P - ASA 6X2/2 ARA 6X2/4 - 8X2/4 COMPOSED BY: NO.1 PC 60913 - NO.1 PC 60917 - NO.2 PCS 60919			
● F-K-N BUS			
★ 9X15 10X15 AD COMPOSED BY: NO.1 PC 60913 - NO.1 PC 60917 - NO.2 PCS 60919			
● 3 BUS			
★ AD 11X15 - AD90 9X15 COMPOSED BY: NO.1 PC 60913 - NO.1 PC 60917 - NO.2 PCS 60919			
● 4 TRUCK			
★ AD1300 4X2 - AD1500P 4X2 4X4 - AD1501P 4X2 4X4 - ARA820 ARA760 6X2/4 8X2/4 COMPOSED BY: NO.1 PC 60913 - NO.1 PC 60917 - NO.2 PCS 60919			
● 3 TRUCK			
★ AD80/90/100 - AD1500P - ARA COMPOSED BY: NO.1 PC 60913 - NO.1 PC 60917 - NO.2 PCS 60919			

ALL THE COMPONENTS LISTED IN OUR CATALOGUE ARE NOT ORIGINAL, THOUGH PERFECTLY INTERCHANGEABLE. REFERENCE NUMBERS, EITHER ORIGINAL OR OF A DIFFERENT NATURE, ARE FOR INFORMATION PURPOSES ONLY. WHEN PLACING AN ORDER, PLEASE, ALWAYS USE COSIBO REFERENCE NUMBERS AND DO NOT MENTION THE ORIGINAL REFERENCE NUMBERS OF THE TRUCK MANUFACTURERS IN THE INVOICE TO VEHICLE OWNERS OR TO ANYBODY ELSE. THE CUSTOMER TAKES HIS OWN RESPONSIBILITY IF HE DOES NOT COMPLY WITH WHAT ABOVE.

SPRING BRACKET SET



	Code	OEM new	OEM old
● Model	63814	63814	
★ Application			
● P-G-R-T TRUCK			
★ 5X22 - 1X15.10X13 - AD 6X2 8X2 COMPOSED BY: NO.1 PC 60920 - NO.1 PC 60921 - NO.2 PCS 60919			
● 3 TRUCK			
★ AD 6X2 8X2 COMPOSED BY: NO.1 PC 60920 - NO.1 PC 60921 - NO.2 PCS 60919			
● 4 TRUCK			
★ AD 6X2 8X2 COMPOSED BY: NO.1 PC 60920 - NO.1 PC 60921 - NO.2 PCS 60919			

SPRING BOLT



	62111	1364140	
● 4 BUS			
★ 10X15 AD - AD1300			
● F-K-N BUS			
★ 9X15 10X15 AD			
● 4 TRUCK			
★ AD1300 4X2 - AD1500P 4X2 4X4			
● P-G-R-T TRUCK			
★ AD1500P - 4X4			
● 3 TRUCK			
★ AD80/90/100			
● 3 BUS			
★ AD90			

RUBBER BUFFER



	61319	237884	
● 3 TRUCK			
★ AD1500P - ADA - ASA70			
● 4 TRUCK			
★ AD1300 - AD1500P - AD1501P			
● P-G-R-T TRUCK			
★ AD1500P			

ALL THE COMPONENTS LISTED IN OUR CATALOGUE ARE NOT ORIGINAL, THOUGH PERFECTLY INTERCHANGEABLE. REFERENCE NUMBERS, EITHER ORIGINAL OR OF A DIFFERENT NATURE, ARE FOR INFORMATION PURPOSES ONLY. WHEN PLACING AN ORDER, PLEASE, ALWAYS USE COSIBO REFERENCE NUMBERS AND DO NOT MENTION THE ORIGINAL REFERENCE NUMBERS OF THE TRUCK MANUFACTURERS IN THE INVOICE TO VEHICLE OWNERS OR TO ANYBODY ELSE. THE CUSTOMER TAKES HIS OWN RESPONSIBILITY IF HE DOES NOT COMPLY WITH WHAT ABOVE.

	Code	OEM new	OEM old
RUBBER BUFFER	65028	1377692	1370142
	<ul style="list-style-type: none"> ● Model ★ Application 		
	<ul style="list-style-type: none"> ● 3 TRUCK ★ AD80/90/100 - AD1500P 		
	<ul style="list-style-type: none"> ● 4 TRUCK ★ AD1300 - AD1500P - AD1501P - ADA1300/1500/1501 - ADA1100 - ADA1100 F958 		
	<ul style="list-style-type: none"> ● P-G-R-T TRUCK ★ AD/ADA - AD1500P - ADA1300 F950/958 - ADA1100 - ADA1501P 		

	62219	120252	
RUBBER BUFFER			
	<ul style="list-style-type: none"> ● 4 TRUCK ★ AD 		
	<ul style="list-style-type: none"> ● P-G-R-T TRUCK ★ AD 		

	65244	285493	
RUBBER BUFFER			
	<ul style="list-style-type: none"> ● 3 TRUCK ★ AD80/90/100 - ADA90 - ASA - ASA80 ELC 1.19 TONS 		
	<ul style="list-style-type: none"> ● 4 TRUCK ★ ASA80 ELC 1.19 TONS - ADA1300 ELC 1.LA4X2NA NB - 1.LB6X2NA NB - ASA70 ELC 1.19.9 TONS LB6X2NA NB 		
	<ul style="list-style-type: none"> ● 3 BUS ★ AD90 - ASA 		
	<ul style="list-style-type: none"> ● 4 BUS ★ AD1300 - F94 6X2 		
	<ul style="list-style-type: none"> ● F-K-N BUS ★ AD 		

ALL THE COMPONENTS LISTED IN OUR CATALOGUE ARE NOT ORIGINAL, THOUGH PERFECTLY INTERCHANGEABLE. REFERENCE NUMBERS, EITHER ORIGINAL OR OF A DIFFERENT NATURE, ARE FOR INFORMATION PURPOSES ONLY. WHEN PLACING AN ORDER, PLEASE, ALWAYS USE COSIBO REFERENCE NUMBERS AND DO NOT MENTION THE ORIGINAL REFERENCE NUMBERS OF THE TRUCK MANUFACTURERS IN THE INVOICE TO VEHICLE OWNERS OR TO ANYBODY ELSE. THE CUSTOMER TAKES HIS OWN RESPONSIBILITY IF HE DOES NOT COMPLY WITH WHAT ABOVE.

SHOCK ABSORBER REPAIR SET



● Model
★ Application

Code

OEM new

OEM old

64036

550282

● 3 TRUCK

★

● 4 TRUCK

★

SHOCK ABSORBER REPAIR SET



● 3 TRUCK

★

● 4 TRUCK

★

64309

550283

ALL THE COMPONENTS LISTED IN OUR CATALOGUE ARE NOT ORIGINAL, THOUGH PERFECTLY INTERCHANGEABLE. REFERENCE NUMBERS, EITHER ORIGINAL OR OF A DIFFERENT NATURE, ARE FOR INFORMATION PURPOSES ONLY. WHEN PLACING AN ORDER, PLEASE, ALWAYS USE COSIBO REFERENCE NUMBERS AND DO NOT MENTION THE ORIGINAL REFERENCE NUMBERS OF THE TRUCK MANUFACTURERS IN THE INVOICE TO VEHICLE OWNERS OR TO ANYBODY ELSE. THE CUSTOMER TAKES HIS OWN RESPONSIBILITY IF HE DOES NOT COMPLY WITH WHAT ABOVE.

	Code	OEM new	OEM old
RUBBER BUSHING	62491	1516496	
<ul style="list-style-type: none"> ● Model ★ Application 			
<ul style="list-style-type: none"> ● 4 BUS 			
<ul style="list-style-type: none"> ★ ADA1300 4X2 - 6X2 IB/UB - 8X2 IB - ASA701 CH 1848800 - CH 3556770 - AM CH 3550362 			
<ul style="list-style-type: none"> ● F-K-N BUS 			
<ul style="list-style-type: none"> ★ ADA1300 4X2 - 6X2 IB/UB - 8X2 IB - ASA701 CH 1848800 - CH 3556770 - AM - ADA1300 6X2/2 KIA 			
<ul style="list-style-type: none"> ● 4 TRUCK 			
<ul style="list-style-type: none"> ★ AMA AMD900 - AMD901 CH 1292429 - CH 4501901 - CH 9083917 - CH 3545542 - ARA 8X20 - 6X2/4N REAR - 			
<ul style="list-style-type: none"> ● P-G-R-T TRUCK 			
<ul style="list-style-type: none"> ★ 6X2/4 - 8X2/4 			



RUBBER BUFFER	64099	1370141	
<ul style="list-style-type: none"> ● 4 TRUCK 			
<ul style="list-style-type: none"> ★ BT201 AD1101P - BT201 2XAD1100P - BT201I 2XAD1300 - BT300B - BT201B/10X20/90 2XAD1300 			
<ul style="list-style-type: none"> ● P-G-R-T TRUCK 			
<ul style="list-style-type: none"> ★ BT201 AD1101P - BT201 2XAD1100P - BT300 - BT300I - BT300 6X4 8X4 - BT201 AD1300 - 			



TORQUE ROD



- Model
- ★ Application

Code

OEM new

OEM old

63852

1399180

1338769

- 3 TRUCK

★ AD80 6X4 8X4 - AD85 6X4 8X4 - AD90 6X4 8X4

- 4 TRUCK

★ BT200B/I 4X30 F950/958 - BT200B/I 4X41 F950/958

TORQUE ROD REPAIR SET



65239

550806

- 3 BUS

★ AMA

- 3 TRUCK

★ AD80/85/90 6X4 8X4

- 4 TRUCK

★ 94 - 114 - 124 - 144 - 164

- P-G-R-T TRUCK

★ BT300I/B 2XAD1100P

TORQUE ROD REPAIR SET



65240

550807

- 3 TRUCK

★ AMA

- 4 TRUCK

★ 94 - 114 - 124 - 144 - 164

- P-G-R-T TRUCK

★

ALL THE COMPONENTS LISTED IN OUR CATALOGUE ARE NOT ORIGINAL, THOUGH PERFECTLY INTERCHANGEABLE. REFERENCE NUMBERS, EITHER ORIGINAL OR OF A DIFFERENT NATURE, ARE FOR INFORMATION PURPOSES ONLY. WHEN PLACING AN ORDER, PLEASE, ALWAYS USE COSIBO REFERENCE NUMBERS AND DO NOT MENTION THE ORIGINAL REFERENCE NUMBERS OF THE TRUCK MANUFACTURERS IN THE INVOICE TO VEHICLE OWNERS OR TO ANYBODY ELSE. THE CUSTOMER TAKES HIS OWN RESPONSIBILITY IF HE DOES NOT COMPLY WITH WHAT ABOVE.

TORQUE ROD REPAIR SET



● Model
★ Application

Code

OEM new

OEM old

65241

550808

● 3 TRUCK

★ AMA

● 4 TRUCK

★ 94 - 114 - 124 - 144 - 164

● P-G-R-T TRUCK

★

LEVELING VALVE



● 3 TRUCK

★ ASA70

● 4 TRUCK

★ 94 - 114 - 124 - 144 - 164

64189

1380814

322368

ALL THE COMPONENTS LISTED IN OUR CATALOGUE ARE NOT ORIGINAL, THOUGH PERFECTLY INTERCHANGEABLE. REFERENCE NUMBERS, EITHER ORIGINAL OR OF A DIFFERENT NATURE, ARE FOR INFORMATION PURPOSES ONLY. WHEN PLACING AN ORDER, PLEASE, ALWAYS USE COSIBO REFERENCE NUMBERS AND DO NOT MENTION THE ORIGINAL REFERENCE NUMBERS OF THE TRUCK MANUFACTURERS IN THE INVOICE TO VEHICLE OWNERS OR TO ANYBODY ELSE. THE CUSTOMER TAKES HIS OWN RESPONSIBILITY IF HE DOES NOT COMPLY WITH WHAT ABOVE.

	Code	OEM new	OEM old
BOOT	65243	639320	
<ul style="list-style-type: none"> ● Model ★ Application 			
<ul style="list-style-type: none"> ● 3 BUS ★ 			
<ul style="list-style-type: none"> ● 3 TRUCK ★ 			
<ul style="list-style-type: none"> ● 4 BUS ★ 			
<ul style="list-style-type: none"> ● 4 TRUCK ★ 			



	62521	475110	468568
LEVELING VALVE			
<ul style="list-style-type: none"> ● 3 BUS ★ 			
<ul style="list-style-type: none"> ● 4 BUS ★ 			



	64070	1361131	
SENSOR BULB			
<ul style="list-style-type: none"> ● 4 TRUCK ★ B6X2NA/NB 			



ALL THE COMPONENTS LISTED IN OUR CATALOGUE ARE NOT ORIGINAL, THOUGH PERFECTLY INTERCHANGEABLE. REFERENCE NUMBERS, EITHER ORIGINAL OR OF A DIFFERENT NATURE, ARE FOR INFORMATION PURPOSES ONLY. WHEN PLACING AN ORDER, PLEASE, ALWAYS USE COSIBO REFERENCE NUMBERS AND DO NOT MENTION THE ORIGINAL REFERENCE NUMBERS OF THE TRUCK MANUFACTURERS IN THE INVOICE TO VEHICLE OWNERS OR TO ANYBODY ELSE. THE CUSTOMER TAKES HIS OWN RESPONSIBILITY IF HE DOES NOT COMPLY WITH WHAT ABOVE.

SOLENOID VALVE



	Code	OEM new	OEM old
● Model ★ Application	62342	1536307	1421325
● 3 BUS			
★			
● 3 TRUCK			
★ ASA70			
● 4 TRUCK			
★			

SOLENOID VALVE



	Code	OEM new	OEM old
	65191	2038653	1536304 1340231 1421322
● 3 TRUCK			
★ ML 6X2/4 MA 6X2/4 - 4X2A 6X2A - 6X2A ASA70 - 6X2B			
● 4 TRUCK			
★ 4X2A - A4X2NA - 8X2/4 - 8X4/4 - NA/NB			
● 4 BUS			
★			

SOLENOID VALVE



	Code	OEM new	OEM old
	65436	1383956	
● 4 TRUCK			
★			

ALL THE COMPONENTS LISTED IN OUR CATALOGUE ARE NOT ORIGINAL, THOUGH PERFECTLY INTERCHANGEABLE. REFERENCE NUMBERS, EITHER ORIGINAL OR OF A DIFFERENT NATURE, ARE FOR INFORMATION PURPOSES ONLY. WHEN PLACING AN ORDER, PLEASE, ALWAYS USE COSIBO REFERENCE NUMBERS AND DO NOT MENTION THE ORIGINAL REFERENCE NUMBERS OF THE TRUCK MANUFACTURERS IN THE INVOICE TO VEHICLE OWNERS OR TO ANYBODY ELSE. THE CUSTOMER TAKES HIS OWN RESPONSIBILITY IF HE DOES NOT COMPLY WITH WHAT ABOVE.

SOLENOID VALVE



- Model
- ★ Application

Code	OEM new	OEM old
65483	1347572	

- 4 TRUCK

- ★

ALL THE COMPONENTS LISTED IN OUR CATALOGUE ARE NOT ORIGINAL, THOUGH PERFECTLY INTERCHANGEABLE. REFERENCE NUMBERS, EITHER ORIGINAL OR OF A DIFFERENT NATURE, ARE FOR INFORMATION PURPOSES ONLY. WHEN PLACING AN ORDER, PLEASE, ALWAYS USE COSIBO REFERENCE NUMBERS AND DO NOT MENTION THE ORIGINAL REFERENCE NUMBERS OF THE TRUCK MANUFACTURERS IN THE INVOICE TO VEHICLE OWNERS OR TO ANYBODY ELSE. THE CUSTOMER TAKES HIS OWN RESPONSIBILITY IF HE DOES NOT COMPLY WITH WHAT ABOVE.

REAR AXLE SHAFT



- Model
- ★ Application

Code

OEM new

OEM old

61218

252497

- 3 TRUCK

- ★ D1500P HE - 2X AD90/AD100 - 2X AD100 6X4 8X4 6X6

- 4 TRUCK

- ★ D1500P HE

RING NUT



61227

1343178

204724

- 3 TRUCK

- ★ AD1500P HE - 2X AD90 - 2X AD100 6X4 8X4 6X6

- 4 TRUCK

- ★ BT201 B/I 4X30 4X41 10X20/90 - BT300 B/I - 8X8WLS/ZLS BT300 I - AD1500P HE

- P-G-R-T TRUCK

- ★ BT 201 - BT 300 - BT300 B/I

GASKET



61501

204750

- 3 TRUCK

- ★ AD 1500P HE - 2X AD90 - 2X AD100 6X4 8X4 6X6

- 4 TRUCK

- ★ AD 1500P HE

ALL THE COMPONENTS LISTED IN OUR CATALOGUE ARE NOT ORIGINAL, THOUGH PERFECTLY INTERCHANGEABLE. REFERENCE NUMBERS, EITHER ORIGINAL OR OF A DIFFERENT NATURE, ARE FOR INFORMATION PURPOSES ONLY. WHEN PLACING AN ORDER, PLEASE, ALWAYS USE COSIBO REFERENCE NUMBERS AND DO NOT MENTION THE ORIGINAL REFERENCE NUMBERS OF THE TRUCK MANUFACTURERS IN THE INVOICE TO VEHICLE OWNERS OR TO ANYBODY ELSE. THE CUSTOMER TAKES HIS OWN RESPONSIBILITY IF HE DOES NOT COMPLY WITH WHAT ABOVE.





		Code	OEM new	OEM old
WASHER	● Model	61502	204723	
	★ Application			
	● 3 TRUCK			
	★ AD 1500P HE - 2XAD90 - 2XAD100 6X4 8X4 6X6			
	● 4 TRUCK			
	★ BT 201 B/I 4X30 4X41 10X20/90 - BT 300 B/I - 8X8 WLS/ZLS BT300 I - AD 1500P HE			
	● P-G-R-T TRUCK			
	★ BT 201 - BT 300 - BT 300 B/I			

		61503	204737	
WASHER	● 3 TRUCK			
	★ AD1500P HE - 2XAD90 - 2XAD100 6X4 8X4 6X6			
	● 4 TRUCK			
	★ BT 201 B/I 4X30 4X41 10X20/90 - BT 300 B/I - AD1500P HE - 8X8 WLS/ZLS BT300 I			
	● P-G-R-T TRUCK			
	★ BT 201 - BT 300 B/I			

		61504	204735	
WASHER	● 3 TRUCK			
	★ AD1500P HE - 2X AD90 - 2X AD100 6X4 8X4 6X6			
	● 4 TRUCK			
	★ AD1500P HE			

		61505	204736	
WASHER	● 3 TRUCK			
	★ AD1500P HE - 2X AD90 - 2X AD100 6X4 8X4 6X6			
	● 4 TRUCK			
	★ AD1500P HE			

ALL THE COMPONENTS LISTED IN OUR CATALOGUE ARE NOT ORIGINAL, THOUGH PERFECTLY INTERCHANGEABLE. REFERENCE NUMBERS, EITHER ORIGINAL OR OF A DIFFERENT NATURE, ARE FOR INFORMATION PURPOSES ONLY. WHEN PLACING AN ORDER, PLEASE, ALWAYS USE COSIBO REFERENCE NUMBERS AND DO NOT MENTION THE ORIGINAL REFERENCE NUMBERS OF THE TRUCK MANUFACTURERS IN THE INVOICE TO VEHICLE OWNERS OR TO ANYBODY ELSE. THE CUSTOMER TAKES HIS OWN RESPONSIBILITY IF HE DOES NOT COMPLY WITH WHAT ABOVE.

	Code	OEM new	OEM old
WASHER	61506	1118446	204731
	<ul style="list-style-type: none"> ● Model ★ Application 		
	<ul style="list-style-type: none"> ● 3 TRUCK ★ AD1500P HE - 2X AD80 MK6X4/MK8X4/ML6X4 - 2X AD 85 HK 6X4 /8X4 - 2X AD90 - 2X AD100 6X4 8X4 6X6 - 2X AD90 HL 6X4 8X4 		
	<ul style="list-style-type: none"> ● 4TRUCK ★ AD1500P HE - BT200 B/I 		
WASHER	63998	1474065	
	<ul style="list-style-type: none"> ● 4 TRUCK ★ BT300 B/I - 8X8 WLS/ZLS BT300I - BT201 B/I 		
	<ul style="list-style-type: none"> ● P-G-R-T TRUCK ★ BT201 - BT300 - BT300B/I 		
O-RING 139,2X5,7	63999	804690	
	<ul style="list-style-type: none"> ● 4 TRUCK ★ BT300 B/I - 8X8 WLS/ZLS BT300I - BT201 B/I 		
	<ul style="list-style-type: none"> ● P-G-R-T TRUCK ★ BT201 - BT300 - BT300B/I 		
SPACER RING	61507	204746	
	<ul style="list-style-type: none"> ● 3 TRUCK ★ AD1500P HE - 2X AD80 MK6X4/MK8X4/ML6X4 - 2X AD 85 HK 6X4 /8X4 - 2X AD90 - 2X AD100 6X4 8X4 6X6 - 2X AD90 HL 6X4 8X4 		
	<ul style="list-style-type: none"> ● 4 TRUCK ★ AD1500P HE - BT200 B/I 		

ALL THE COMPONENTS LISTED IN OUR CATALOGUE ARE NOT ORIGINAL, THOUGH PERFECTLY INTERCHANGEABLE. REFERENCE NUMBERS, EITHER ORIGINAL OR OF A DIFFERENT NATURE, ARE FOR INFORMATION PURPOSES ONLY. WHEN PLACING AN ORDER, PLEASE, ALWAYS USE COSIBO REFERENCE NUMBERS AND DO NOT MENTION THE ORIGINAL REFERENCE NUMBERS OF THE TRUCK MANUFACTURERS IN THE INVOICE TO VEHICLE OWNERS OR TO ANYBODY ELSE. THE CUSTOMER TAKES HIS OWN RESPONSIBILITY IF HE DOES NOT COMPLY WITH WHAT ABOVE.

	Code	OEM new	OEM old
BUSHING	60866	1754546	204733 378277
<ul style="list-style-type: none"> ● Model ★ Application 			
<ul style="list-style-type: none"> ● 3 TRUCK ★ AD1500P HE - 2X AD80 MK6X4/MK8X4/ML6X4 - 2X AD 85 HK 6X4 /8X4 - 2X AD90 - 2X AD100 6X4 8X4 6X6 - 2X AD90 HL 6X4 8X4 			
<ul style="list-style-type: none"> ● 4 TRUCK ★ AD1500P HE - BT200 B/I 			



	61508	368033	
O-RING (RED SILICONE)			
<ul style="list-style-type: none"> ● 3 TRUCK ★ AD1500P HE - 2X AD100 			
<ul style="list-style-type: none"> ● 4 TRUCK ★ AD1500P HE - R560/660/780/782 - RP735/835 			
<ul style="list-style-type: none"> ● P-G-R-T TRUCK ★ R560/660/780/782 - RP735/835 - RBP735 			
<ul style="list-style-type: none"> ● 3 BUS ★ 			
<ul style="list-style-type: none"> ● 4 BUS ★ K/L94 - 114 - 124 R660 - RP835 			
<ul style="list-style-type: none"> ● IND. MARINE ENGINE 4 ★ 			
<ul style="list-style-type: none"> ● F-K-N BUS ★ R660/680 			

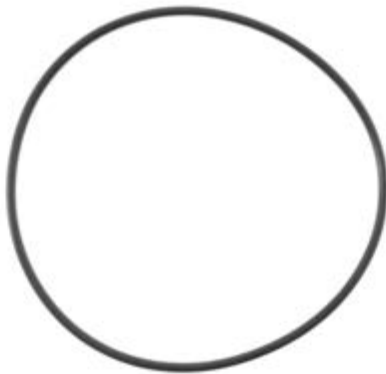

	61509	204727	
FLANGE			
<ul style="list-style-type: none"> ● 3 TRUCK ★ AD1500P HE - 2X AD90 - 2X AD100 6X4 8X4 6X6 			
<ul style="list-style-type: none"> ● 4 TRUCK ★ AD1500P HE 			



ALL THE COMPONENTS LISTED IN OUR CATALOGUE ARE NOT ORIGINAL, THOUGH PERFECTLY INTERCHANGEABLE. REFERENCE NUMBERS, EITHER ORIGINAL OR OF A DIFFERENT NATURE, ARE FOR INFORMATION PURPOSES ONLY. WHEN PLACING AN ORDER, PLEASE, ALWAYS USE COSIBO REFERENCE NUMBERS AND DO NOT MENTION THE ORIGINAL REFERENCE NUMBERS OF THE TRUCK MANUFACTURERS IN THE INVOICE TO VEHICLE OWNERS OR TO ANYBODY ELSE. THE CUSTOMER TAKES HIS OWN RESPONSIBILITY IF HE DOES NOT COMPLY WITH WHAT ABOVE.

	Code	OEM new	OEM old
CONIC RING	61510	204719	
	<ul style="list-style-type: none"> ● Model ★ Application 		
	<ul style="list-style-type: none"> ● 3 TRUCK ★ AD1500P HE - 2X AD90 - 2X AD100 6X4 8X4 6X6 		
	<ul style="list-style-type: none"> ● 4 TRUCK ★ AD1500P HE 		
WASHER	61511	204722	
	<ul style="list-style-type: none"> ● 3 TRUCK ★ AD1500P HE - 2X AD90 - 2X AD100 6X4 8X4 6X6 		
	<ul style="list-style-type: none"> ● 4 TRUCK ★ AD1500P HE 		
OIL SEAL	60867	204728	
	<ul style="list-style-type: none"> ● 3 TRUCK ★ AD1500P HE - 2X AD90 - 2X AD100 6X4 8X4 6X6 		
	<ul style="list-style-type: none"> ● 4 TRUCK ★ AD1500P HE 		
PIN	61960	132650	
	<ul style="list-style-type: none"> ● 3 TRUCK ★ 2XAD80 ML6X4 - 2XAD90 - 2XAD100 6X4/8X4/6X6 - 2XAD90 HL 6X4/8X4 - 2XAD85 HK6X4/8X4 - AD 1500PHE 		
	<ul style="list-style-type: none"> ● 4 TRUCK ★ BT 200B/I - AD 1500PHE 		

ALL THE COMPONENTS LISTED IN OUR CATALOGUE ARE NOT ORIGINAL, THOUGH PERFECTLY INTERCHANGEABLE. REFERENCE NUMBERS, EITHER ORIGINAL OR OF A DIFFERENT NATURE, ARE FOR INFORMATION PURPOSES ONLY. WHEN PLACING AN ORDER, PLEASE, ALWAYS USE COSIBO REFERENCE NUMBERS AND DO NOT MENTION THE ORIGINAL REFERENCE NUMBERS OF THE TRUCK MANUFACTURERS IN THE INVOICE TO VEHICLE OWNERS OR TO ANYBODY ELSE. THE CUSTOMER TAKES HIS OWN RESPONSIBILITY IF HE DOES NOT COMPLY WITH WHAT ABOVE.

REPAIR SET



- Model
- ★ Application

Code

OEM new

OEM old

62467

62467

- 3 TRUCK

- ★ AD1500P HE - 2X AD90 - 2X AD100 6X4 8X4 6X6

- 4 TRUCK

- ★ AD1500P HE

REPAIR SET



- 3 TRUCK

- ★ AD1500P HE - 2X AD90 - 2X AD100 6X4 8X4 6X6

- 4 TRUCK

- ★ AD1500P HE

62468

62468

RUBBER RING



- 4 TRUCK

- ★ BT 201 B/I 4X30 4X41 10/20/90 - BT 300 B/I - 8X8 WLS/ZLS BT300 I

- P-G-R-T TRUCK

- ★ BT 201 - BT 300 - BT 300 B/I

62466

1386104

ALL THE COMPONENTS LISTED IN OUR CATALOGUE ARE NOT ORIGINAL, THOUGH PERFECTLY INTERCHANGEABLE. REFERENCE NUMBERS, EITHER ORIGINAL OR OF A DIFFERENT NATURE, ARE FOR INFORMATION PURPOSES ONLY. WHEN PLACING AN ORDER, PLEASE, ALWAYS USE COSIBO REFERENCE NUMBERS AND DO NOT MENTION THE ORIGINAL REFERENCE NUMBERS OF THE TRUCK MANUFACTURERS IN THE INVOICE TO VEHICLE OWNERS OR TO ANYBODY ELSE. THE CUSTOMER TAKES HIS OWN RESPONSIBILITY IF HE DOES NOT COMPLY WITH WHAT ABOVE.

	Code	OEM new	OEM old
OIL SEAL 140X170X15	63997	1386227	
<ul style="list-style-type: none"> ● Model ★ Application 			
<ul style="list-style-type: none"> ● 4 TRUCK 			
<ul style="list-style-type: none"> ★ BT 201 B/I 4X30 4X41 10X20/90 - BT 300 B/I - 8X8 WLS/ZLS BT 300 I 			
<ul style="list-style-type: none"> ● P-G-R-T TRUCK 			
<ul style="list-style-type: none"> ★ BT 201 - BT 300 - BT 300 B/I 			



OIL SEAL 140X170X13,6/17,4	64117	1431199	1357942 1380324 1390097
<ul style="list-style-type: none"> ● 3 TRUCK 			
<ul style="list-style-type: none"> ★ 2X AD80 MK6X4/MK8X4/ML6X4 - 2X AD90 HL 6X4 8X4 - 2X AD85 HK6X4 8X4 			
<ul style="list-style-type: none"> ● 4 TRUCK 			
<ul style="list-style-type: none"> ★ BT 200 B/I 			



REAR AXLE RUBBER MOUNTING	65310	1368681	204749
<ul style="list-style-type: none"> ● 3 TRUCK 			
<ul style="list-style-type: none"> ★ AD1500P HE - 2X AD90 - 2X AD100 6X4 8X4 6X6 			
<ul style="list-style-type: none"> ● 4 TRUCK 			
<ul style="list-style-type: none"> ★ AD1500P HE 			



REAR AXLE RUBBER MOUNTING DIA.18.5 MM	65302	1368682	349254
<ul style="list-style-type: none"> ● 3 TRUCK 			
<ul style="list-style-type: none"> ★ AD1500P HE - 2X AD90 - 2X AD100 6X4 8X4 6X6 			
<ul style="list-style-type: none"> ● 4 TRUCK 			
<ul style="list-style-type: none"> ★ AD1500P HE 			



ALL THE COMPONENTS LISTED IN OUR CATALOGUE ARE NOT ORIGINAL, THOUGH PERFECTLY INTERCHANGEABLE. REFERENCE NUMBERS, EITHER ORIGINAL OR OF A DIFFERENT NATURE, ARE FOR INFORMATION PURPOSES ONLY. WHEN PLACING AN ORDER, PLEASE, ALWAYS USE COSIBO REFERENCE NUMBERS AND DO NOT MENTION THE ORIGINAL REFERENCE NUMBERS OF THE TRUCK MANUFACTURERS IN THE INVOICE TO VEHICLE OWNERS OR TO ANYBODY ELSE. THE CUSTOMER TAKES HIS OWN RESPONSIBILITY IF HE DOES NOT COMPLY WITH WHAT ABOVE.

REAR AXLE RUBBER MOUNTING DIA.17 MM



	Code	OEM new	OEM old
● Model ★ Application	65300	1372786	248953
● 3 TRUCK			
★ AD1500P HE - 2X AD90 - 2X AD100 6X4 8X4 6X6			
● 4 TRUCK			
★ AD1500P HE			

REAR AXLE RUBBER MOUNTING DIA.17.5 MM



	Code	OEM new	OEM old
	65206	1386753	
● 4 TRUCK			
★			
● 4 BUS			
★			

RUBBER BUFFER



	Code	OEM new	OEM old
	65231	222095	
● 3 TRUCK			
★ AD1500P HE - 2X AD80 MK6X4/MK8X4/ML6X4 - 2X AD85 HK6X4 8X4 - 2X AD90 HL6X4 8X4 - 2X AD100 6X4 8X4 6X6			
● 4 TRUCK			
★ AD1500P HE - BT 200 B/I 4X30 F950/F958 - BT 200 B/I 4X41 F950/F958 - 8X8 WLS/ZLS BT300I AD1101P - BT300I 2X AD1100P/AD1500P/AD1501P - BT300B/I 2X AD1500P/1501P			
● P-G-R-T TRUCK			
★ BT200 B/I 4X41 F950/F958 - BT200 B/I 4X30 F950/F958 - BT 300 I/B - AD1101P - BT 300 6X6 - BT300I/B 2X AD1100P - BT300I 2X AD1501P			

ALL THE COMPONENTS LISTED IN OUR CATALOGUE ARE NOT ORIGINAL, THOUGH PERFECTLY INTERCHANGEABLE. REFERENCE NUMBERS, EITHER ORIGINAL OR OF A DIFFERENT NATURE, ARE FOR INFORMATION PURPOSES ONLY. WHEN PLACING AN ORDER, PLEASE, ALWAYS USE COSIBO REFERENCE NUMBERS AND DO NOT MENTION THE ORIGINAL REFERENCE NUMBERS OF THE TRUCK MANUFACTURERS IN THE INVOICE TO VEHICLE OWNERS OR TO ANYBODY ELSE. THE CUSTOMER TAKES HIS OWN RESPONSIBILITY IF HE DOES NOT COMPLY WITH WHAT ABOVE.

O-RING

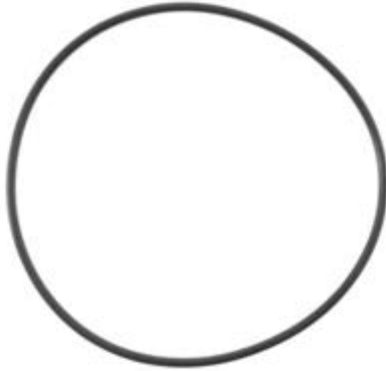

- Model
- ★ Application

- 3 TRUCK
- ★ AS60/AS90

Code	OEM new	OEM old
64790	804670	

ALL THE COMPONENTS LISTED IN OUR CATALOGUE ARE NOT ORIGINAL, THOUGH PERFECTLY INTERCHANGEABLE. REFERENCE NUMBERS, EITHER ORIGINAL OR OF A DIFFERENT NATURE, ARE FOR INFORMATION PURPOSES ONLY. WHEN PLACING AN ORDER, PLEASE, ALWAYS USE COSIBO REFERENCE NUMBERS AND DO NOT MENTION THE ORIGINAL REFERENCE NUMBERS OF THE TRUCK MANUFACTURERS IN THE INVOICE TO VEHICLE OWNERS OR TO ANYBODY ELSE. THE CUSTOMER TAKES HIS OWN RESPONSIBILITY IF HE DOES NOT COMPLY WITH WHAT ABOVE.

AIR SPRING



- Model
- ★ Application

Code	OEM new	OEM old
60744	1543691	1440294 1510195 1731113

- 3 TRUCK



- 4 TRUCK



- P-G-R-T TRUCK



AIR BELLOW



65549	1386200	
--------------	---------	--

- 4 TRUCK

- ★ AMA740 - AMA860 - AMA RE 8X2B 8X4B 8X6B

- P-G-R-T TRUCK



ALL THE COMPONENTS LISTED IN OUR CATALOGUE ARE NOT ORIGINAL, THOUGH PERFECTLY INTERCHANGEABLE. REFERENCE NUMBERS, EITHER ORIGINAL OR OF A DIFFERENT NATURE, ARE FOR INFORMATION PURPOSES ONLY. WHEN PLACING AN ORDER, PLEASE, ALWAYS USE COSIBO REFERENCE NUMBERS AND DO NOT MENTION THE ORIGINAL REFERENCE NUMBERS OF THE TRUCK MANUFACTURERS IN THE INVOICE TO VEHICLE OWNERS OR TO ANYBODY ELSE. THE CUSTOMER TAKES HIS OWN RESPONSIBILITY IF HE DOES NOT COMPLY WITH WHAT ABOVE.

AIR BELLOW



	Code	OEM new	OEM old
● Model	65548	1386199	
★ Application			
● 4 TRUCK			
★ AMA740 - AMA860 - AMA RE 8X2B 8X4B 8X2 6B			
● P-G-R-T-TRUCK			
★			

AIR SPRING



	65516	1865759	1402423
● 3 TRUCK			
★			
● 4 TRUCK			
★			
● P-G-R-T TRUCK			
★			

AIR SPRING



	65517	1863244	1387283
● 3 TRUCK			
★			
● 4 TRUCK			
★			
● P-G-R-T TRUCK			
★			

ALL THE COMPONENTS LISTED IN OUR CATALOGUE ARE NOT ORIGINAL, THOUGH PERFECTLY INTERCHANGEABLE. REFERENCE NUMBERS, EITHER ORIGINAL OR OF A DIFFERENT NATURE, ARE FOR INFORMATION PURPOSES ONLY. WHEN PLACING AN ORDER, PLEASE, ALWAYS USE COSIBO REFERENCE NUMBERS AND DO NOT MENTION THE ORIGINAL REFERENCE NUMBERS OF THE TRUCK MANUFACTURERS IN THE INVOICE TO VEHICLE OWNERS OR TO ANYBODY ELSE. THE CUSTOMER TAKES HIS OWN RESPONSIBILITY IF HE DOES NOT COMPLY WITH WHAT ABOVE.

		Code	OEM new	OEM old
AIR SPRING	● Model	65516	1865759	1402423
	★ Application			
	● 3 TRUCK			
	★			
	● 4 TRUCK			
★				
	● P-G-R-T TRUCK			
	★			





AIR SPRING		65517	1863244	1387283
	● 3 TRUCK			
	★			
	● 4 TRUCK			
	★			
	● P-G-R-T TRUCK			
	★			







ALL THE COMPONENTS LISTED IN OUR CATALOGUE ARE NOT ORIGINAL, THOUGH PERFECTLY INTERCHANGEABLE. REFERENCE NUMBERS, EITHER ORIGINAL OR OF A DIFFERENT NATURE, ARE FOR INFORMATION PURPOSES ONLY. WHEN PLACING AN ORDER, PLEASE, ALWAYS USE COSIBO REFERENCE NUMBERS AND DO NOT MENTION THE ORIGINAL REFERENCE NUMBERS OF THE TRUCK MANUFACTURERS IN THE INVOICE TO VEHICLE OWNERS OR TO ANYBODY ELSE. THE CUSTOMER TAKES HIS OWN RESPONSIBILITY IF HE DOES NOT COMPLY WITH WHAT ABOVE.

		Code	OEM new	OEM old
SENSOR	● Model	65449	2099046	1495828
	★ Application			
	● P-G-R-T TRUCK			
	★			





RELAY		65207	1519488	1372850 1407661
	● 3 TRUCK			
	★ AS60 - AS90 - ADR			
	● 4 TRUCK			
	★ AS900 6X2Z 8X2Z - ADR			
	● P-G-R-T TRUCK			
	★ AS900			

SENSOR		65486	1781199	1448083 1541703
	● 4 TRUCK			
	★			
	● F-K-N BUS			
	★			
	● P-G-R-T TRUCK			
	★			
	● F-K-N BUS			
	★			
	● 4 TRUCK			
	★			
	● P-G-R-T TRUCK			
	★			

ALL THE COMPONENTS LISTED IN OUR CATALOGUE ARE NOT ORIGINAL, THOUGH PERFECTLY INTERCHANGEABLE. REFERENCE NUMBERS, EITHER ORIGINAL OR OF A DIFFERENT NATURE, ARE FOR INFORMATION PURPOSES ONLY. WHEN PLACING AN ORDER, PLEASE, ALWAYS USE COSIBO REFERENCE NUMBERS AND DO NOT MENTION THE ORIGINAL REFERENCE NUMBERS OF THE TRUCK MANUFACTURERS IN THE INVOICE TO VEHICLE OWNERS OR TO ANYBODY ELSE. THE CUSTOMER TAKES HIS OWN RESPONSIBILITY IF HE DOES NOT COMPLY WITH WHAT ABOVE.

	Code	OEM new	OEM old
<p>CLAMP D.6</p> 	64082	813933	
<ul style="list-style-type: none"> ● Model ★ Application 			
<ul style="list-style-type: none"> ● 3 BUS ★ 			
<p>CLAMP D.10</p> 	64083	813935	
<ul style="list-style-type: none"> ● 3 TRUCK ★ 			
<p>CLAMP D. 16</p> 	64084	813937	
<ul style="list-style-type: none"> ● 3 BUS ★ 			
<p>CLAMP D.8</p> 	64090	813934	
<ul style="list-style-type: none"> ● 3 TRUCK ★ 			

ALL THE COMPONENTS LISTED IN OUR CATALOGUE ARE NOT ORIGINAL, THOUGH PERFECTLY INTERCHANGEABLE. REFERENCE NUMBERS, EITHER ORIGINAL OR OF A DIFFERENT NATURE, ARE FOR INFORMATION PURPOSES ONLY. WHEN PLACING AN ORDER, PLEASE, ALWAYS USE COSIBO REFERENCE NUMBERS AND DO NOT MENTION THE ORIGINAL REFERENCE NUMBERS OF THE TRUCK MANUFACTURERS IN THE INVOICE TO VEHICLE OWNERS OR TO ANYBODY ELSE. THE CUSTOMER TAKES HIS OWN RESPONSIBILITY IF HE DOES NOT COMPLY WITH WHAT ABOVE.

	Code	OEM new	OEM old
<p>CLAMP D.13</p> 	64091	813936	
<ul style="list-style-type: none"> ● Model ★ Application 			
<ul style="list-style-type: none"> ● 3 BUS ★ 			
<p>CLAMP D.18</p> 	64092	813938	
<ul style="list-style-type: none"> ● 3 BUS ★ 			
<p>CLAMP D.22</p> 	64093	813940	
<ul style="list-style-type: none"> ● 3 TRUCK ★ 			
<p>CLAMP D.28</p> 	64095	804578	
<ul style="list-style-type: none"> ● 3 BUS ★ 			

ALL THE COMPONENTS LISTED IN OUR CATALOGUE ARE NOT ORIGINAL, THOUGH PERFECTLY INTERCHANGEABLE. REFERENCE NUMBERS, EITHER ORIGINAL OR OF A DIFFERENT NATURE, ARE FOR INFORMATION PURPOSES ONLY. WHEN PLACING AN ORDER, PLEASE, ALWAYS USE COSIBO REFERENCE NUMBERS AND DO NOT MENTION THE ORIGINAL REFERENCE NUMBERS OF THE TRUCK MANUFACTURERS IN THE INVOICE TO VEHICLE OWNERS OR TO ANYBODY ELSE. THE CUSTOMER TAKES HIS OWN RESPONSIBILITY IF HE DOES NOT COMPLY WITH WHAT ABOVE.

	Code	OEM new	OEM old
SWITCH	62390	1425019	
<ul style="list-style-type: none"> ● Model ★ Application 			
<ul style="list-style-type: none"> ● 4 BUS ★ 			
<ul style="list-style-type: none"> ● 4 TRUCK ★ 94 - 114 - 124 - 144 - 164 			



SWITCH	62297	371910	
<ul style="list-style-type: none"> ● 3 BUS ★ 			
<ul style="list-style-type: none"> ● 3 TRUCK ★ 			



STEERING SHAFT	60532	391496	
<ul style="list-style-type: none"> ● 2 TRUCK ★ 92-112-142 			
<ul style="list-style-type: none"> ● 2 TRUCK ★ 92-112-142 			



STEERING SHAFT	63354	1541653	1439270 1462613 1489734 1490913
<ul style="list-style-type: none"> ● 4 TRUCK ★ CR 			
<ul style="list-style-type: none"> ● P-G-R-T TRUCK ★ 			
<ul style="list-style-type: none"> ● 4 BUS ★ 			
<ul style="list-style-type: none"> ● F-K-N BUS ★ 			



ALL THE COMPONENTS LISTED IN OUR CATALOGUE ARE NOT ORIGINAL, THOUGH PERFECTLY INTERCHANGEABLE. REFERENCE NUMBERS, EITHER ORIGINAL OR OF A DIFFERENT NATURE, ARE FOR INFORMATION PURPOSES ONLY. WHEN PLACING AN ORDER, PLEASE, ALWAYS USE COSIBO REFERENCE NUMBERS AND DO NOT MENTION THE ORIGINAL REFERENCE NUMBERS OF THE TRUCK MANUFACTURERS IN THE INVOICE TO VEHICLE OWNERS OR TO ANYBODY ELSE. THE CUSTOMER TAKES HIS OWN RESPONSIBILITY IF HE DOES NOT COMPLY WITH WHAT ABOVE.

	Code	OEM new	OEM old
STEERING COLUMN	63617	470391	
<ul style="list-style-type: none"> ● Model ★ Application 			
<ul style="list-style-type: none"> ● 3 BUS ★ 			



STEERING SHAFT	63355	1540425	1462612 1490912 1491834
<ul style="list-style-type: none"> ● 4 TRUCK ★ CP 			
<ul style="list-style-type: none"> ● P-G-R-T TRUCK ★ 			
<ul style="list-style-type: none"> ● 4 BUS ★ 			
<ul style="list-style-type: none"> ● F-K-N BUS ★ 			



STEERING SHAFT	64802	1540426	
<ul style="list-style-type: none"> ● P-G-R-T TRUCK ★ 			







STARTER AND LOCK STEERING CYLINDER	62138	389500	
<ul style="list-style-type: none"> ● 3 TRUCK ★ 			
<ul style="list-style-type: none"> ● 4 TRUCK ★ 			



ALL THE COMPONENTS LISTED IN OUR CATALOGUE ARE NOT ORIGINAL, THOUGH PERFECTLY INTERCHANGEABLE. REFERENCE NUMBERS, EITHER ORIGINAL OR OF A DIFFERENT NATURE, ARE FOR INFORMATION PURPOSES ONLY. WHEN PLACING AN ORDER, PLEASE, ALWAYS USE COSIBO REFERENCE NUMBERS AND DO NOT MENTION THE ORIGINAL REFERENCE NUMBERS OF THE TRUCK MANUFACTURERS IN THE INVOICE TO VEHICLE OWNERS OR TO ANYBODY ELSE. THE CUSTOMER TAKES HIS OWN RESPONSIBILITY IF HE DOES NOT COMPLY WITH WHAT ABOVE.

	Code	OEM new	OEM old
<p>STEERING DRAG LINK</p> 	61549	278665	278666
<ul style="list-style-type: none"> ● Model ★ Application 			
<ul style="list-style-type: none"> ● 3 TRUCK ★ G/P/R 93 - P/R 113 - R 143 			
<p>STEERING DRAGLINK RHD</p> 	61924	352635	278663 278664
<ul style="list-style-type: none"> ● 3 TRUCK ★ P93 DN/DS/DSC - P/R113 - R143 			
<p>STEERING DRAG LINK</p> 	61933	1308643	
<ul style="list-style-type: none"> ● 3 TRUCK ★ R143 - P/R113 - P93 			
<p>STEERING DRAGLINK RHD</p> 	61923	1304571	381339
<ul style="list-style-type: none"> ● 3 TRUCK ★ P93 - P/R113 - R143 			
<p>STEERING DRAG LINK</p> 	62135	1369917	300308 306913 382774
<ul style="list-style-type: none"> ● 3 TRUCK ★ T93/113/143 			

ALL THE COMPONENTS LISTED IN OUR CATALOGUE ARE NOT ORIGINAL, THOUGH PERFECTLY INTERCHANGEABLE. REFERENCE NUMBERS, EITHER ORIGINAL OR OF A DIFFERENT NATURE, ARE FOR INFORMATION PURPOSES ONLY. WHEN PLACING AN ORDER, PLEASE, ALWAYS USE COSIBO REFERENCE NUMBERS AND DO NOT MENTION THE ORIGINAL REFERENCE NUMBERS OF THE TRUCK MANUFACTURERS IN THE INVOICE TO VEHICLE OWNERS OR TO ANYBODY ELSE. THE CUSTOMER TAKES HIS OWN RESPONSIBILITY IF HE DOES NOT COMPLY WITH WHAT ABOVE.

	Code	OEM new	OEM old
<p>DRAG LINK</p> 	61932	352637	
<ul style="list-style-type: none"> ● Model ★ Application 			
<ul style="list-style-type: none"> ● 3 TRUCK ★ P93 RHD DN/DS/DSC - P/R113 RHD AM56/61 - R143 RHD AM56/61 			
<p>STEERING DRAG LINK</p> 	61119	1912757	1379071 1384025 1768898
<ul style="list-style-type: none"> ● 4 TRUCK ★ 94 - 114 - 124 - 144 - 164 ● P-G-R-T TRUCK ★ 			
<p>STEERING DRAG LINK RHD</p> 	63306	1912758	1847312 1384027 1769597
<ul style="list-style-type: none"> ● 4 TRUCK ★ 94 - 114 - 124 - 144 - 164 ● P-G-R-T TRUCK ★ 			
<p>STEERING DRAG LINK</p> 	60255	470272	
<ul style="list-style-type: none"> ● 3 BUS ★ RHD 			

ALL THE COMPONENTS LISTED IN OUR CATALOGUE ARE NOT ORIGINAL, THOUGH PERFECTLY INTERCHANGEABLE. REFERENCE NUMBERS, EITHER ORIGINAL OR OF A DIFFERENT NATURE, ARE FOR INFORMATION PURPOSES ONLY. WHEN PLACING AN ORDER, PLEASE, ALWAYS USE COSIBO REFERENCE NUMBERS AND DO NOT MENTION THE ORIGINAL REFERENCE NUMBERS OF THE TRUCK MANUFACTURERS IN THE INVOICE TO VEHICLE OWNERS OR TO ANYBODY ELSE. THE CUSTOMER TAKES HIS OWN RESPONSIBILITY IF HE DOES NOT COMPLY WITH WHAT ABOVE.

STEERING DRAG LINK



	Code	OEM new	OEM old
● Model ★ Application	63587	1759691	1343283
● 4 TRUCK			
★ 94 - 114 - 124 - 144 - 164			
● P-G-R-T TRUCK			
★ P/G/R			

STEERING DRAG LINK RHD



	Code	OEM new	OEM old
	63585	1394884	
● 4 TRUCK			
★ 94 - 114 - 124 - 144 - 164			
● P-G-R-T TRUCK			
★ P/G/R			

STEERING DRAG LINK LHD/RHD



	Code	OEM new	OEM old
	63589	1759690	1343266
● 4 TRUCK			
★ 8X2 8X4 8X6			
● P-G-R-T TRUCK			
★ P/R/G			

ALL THE COMPONENTS LISTED IN OUR CATALOGUE ARE NOT ORIGINAL, THOUGH PERFECTLY INTERCHANGEABLE. REFERENCE NUMBERS, EITHER ORIGINAL OR OF A DIFFERENT NATURE, ARE FOR INFORMATION PURPOSES ONLY. WHEN PLACING AN ORDER, PLEASE, ALWAYS USE COSIBO REFERENCE NUMBERS AND DO NOT MENTION THE ORIGINAL REFERENCE NUMBERS OF THE TRUCK MANUFACTURERS IN THE INVOICE TO VEHICLE OWNERS OR TO ANYBODY ELSE. THE CUSTOMER TAKES HIS OWN RESPONSIBILITY IF HE DOES NOT COMPLY WITH WHAT ABOVE.

	Code	OEM new	OEM old
STEERING DRAG LINK	65477	1530503	486317
<ul style="list-style-type: none"> ● Model ★ Application 			
<ul style="list-style-type: none"> ● 4 BUS ★ F94 H LHD RHD 			



STEERING DRAG LINK	65478	1796883	1432591
<ul style="list-style-type: none"> ● 4 BUS ★ F94 H LHD RHD 			



LH BALL JOINT	60521	1738380	1358792 283783 395009
<ul style="list-style-type: none"> ● 3 TRUCK ★ P93 6X2/4 LHD/RHD - P - R113 6X2/4 LHD/RHD - R143 6X2/4 LHD/RHD ● 4 TRUCK ★ 94/114/124/144/164 LHD/RHD ● P-G-R-T TRUCK ★ P/R/G 6X2/4 8X2 8X4 8X2/4 8X2/6 ● 3 BUS ★ N113 CLB 			



ALL THE COMPONENTS LISTED IN OUR CATALOGUE ARE NOT ORIGINAL, THOUGH PERFECTLY INTERCHANGEABLE. REFERENCE NUMBERS, EITHER ORIGINAL OR OF A DIFFERENT NATURE, ARE FOR INFORMATION PURPOSES ONLY. WHEN PLACING AN ORDER, PLEASE, ALWAYS USE COSIBO REFERENCE NUMBERS AND DO NOT MENTION THE ORIGINAL REFERENCE NUMBERS OF THE TRUCK MANUFACTURERS IN THE INVOICE TO VEHICLE OWNERS OR TO ANYBODY ELSE. THE CUSTOMER TAKES HIS OWN RESPONSIBILITY IF HE DOES NOT COMPLY WITH WHAT ABOVE.

	Code	OEM new	OEM old
RH BALL JOINT	60522	1358793	283784 395010
<ul style="list-style-type: none"> ● Model ★ Application 			
<ul style="list-style-type: none"> ● 3 TRUCK ★ P93 6X2/4 LHD/RHD - P - R113 6X2/4 LHD/RHD - R143 6X2/4 LHD/RHD 			
<ul style="list-style-type: none"> ● 4 TRUCK ★ 94/114/124/144/164 LHD/RHD 			
<ul style="list-style-type: none"> ● P-G-R-T TRUCK ★ P/R/G 6X2/4 8X2 8X4 8X2/4 8X2/6 			
<ul style="list-style-type: none"> ● 3 BUS ★ N113 CLB 			



	Code	OEM new	OEM old
BALL JOINT	64343	1738379	1357674
<ul style="list-style-type: none"> ● 4 TRUCK ★ P/R GB8X2/4 NA/NB LHD - P/R LA6X2/4 LHD/RHD - P/R LB6X2/4 NA/NB LHD/RHD - P DB6X2/4 NA/NB LHD/RHD OSC11 G03 - P114 GB6X2/4 NA LHD 			
<ul style="list-style-type: none"> ● P-G-R-T TRUCK ★ P/R/G 6X2/4 8X2/4 			



	Code	OEM new	OEM old
BALL JOINT	63591	1375228	
<ul style="list-style-type: none"> ● 3 TRUCK ★ R143 EK8X4L AM61 AM70 - 8X2 8X4 LHD - R143 8X2 8X4 LHD/RHD - P93 8X4 RHD - P93 8X2 8X4 LHD - P93 MK8X4R - P - R113 HK8X4L AM61 - MK8X4L AM56/AM61 - EK8X4L AM61/AM70 - P113 MK8X4R AM56/AM61 - EK8X4R AM61 - 8X2 8X4 LHD AM56 AM61 AM70 AM800 AM820 - 8X4 RHD - P - R113 8X2 8X4 LHD AM56 AM61 AM70 AM800 AM820 - P - R113 8X4 RHD 			
<ul style="list-style-type: none"> ● 4 TRUCK ★ P/R CB 8X4 LHD/RHD - P/R GB 8X2 8X4 LHD/RHD - P/R CB 8X4 LHD DSC12 05 - P/R GB 8X2 8X4 LHD/RHD DSC12 05 - P CB 8X4 N RHD FRONTLINE - P CB 8X8 LHD - 8X8 WLS/ZLS 			
<ul style="list-style-type: none"> ● P-G-R-T TRUCK ★ P/R/G CB 8X4 LHD - P/R/G L/D/CB 8X2 - L/CB 8X4 LHD/RHD - R L/C 8X2 - 8X4 LHD/RHD - R L/CB 8X2 8X4 LHD 			



ALL THE COMPONENTS LISTED IN OUR CATALOGUE ARE NOT ORIGINAL, THOUGH PERFECTLY INTERCHANGEABLE. REFERENCE NUMBERS, EITHER ORIGINAL OR OF A DIFFERENT NATURE, ARE FOR INFORMATION PURPOSES ONLY. WHEN PLACING AN ORDER, PLEASE, ALWAYS USE COSIBO REFERENCE NUMBERS AND DO NOT MENTION THE ORIGINAL REFERENCE NUMBERS OF THE TRUCK MANUFACTURERS IN THE INVOICE TO VEHICLE OWNERS OR TO ANYBODY ELSE. THE CUSTOMER TAKES HIS OWN RESPONSIBILITY IF HE DOES NOT COMPLY WITH WHAT ABOVE.

DRAG LINK LHD



	Code	OEM new	OEM old
● Model	64003	1343262	
★ Application			
● 4 TRUCK			
★ 6X2/4 - 8X2/4 - 8X8			
● P-G-R-T TRUCK			
★ 6X2/4 - 8X2 - 8X2/4 - 8X2*6 - 8X4			

DRAG LINK



	Code	OEM new	OEM old
	64186	1765382	
● 4 TRUCK			
★			
● P-G-R-T TRUCK			
★			

STEERING DRAG LINK



	Code	OEM new	OEM old
	61654	370875	370875
● 3 TRUCK			
★ R93 LHD AM56/61 - P/R113 LHD AM56/61 - R143 LHD AM56/61			

ALL THE COMPONENTS LISTED IN OUR CATALOGUE ARE NOT ORIGINAL, THOUGH PERFECTLY INTERCHANGEABLE. REFERENCE NUMBERS, EITHER ORIGINAL OR OF A DIFFERENT NATURE, ARE FOR INFORMATION PURPOSES ONLY. WHEN PLACING AN ORDER, PLEASE, ALWAYS USE COSIBO REFERENCE NUMBERS AND DO NOT MENTION THE ORIGINAL REFERENCE NUMBERS OF THE TRUCK MANUFACTURERS IN THE INVOICE TO VEHICLE OWNERS OR TO ANYBODY ELSE. THE CUSTOMER TAKES HIS OWN RESPONSIBILITY IF HE DOES NOT COMPLY WITH WHAT ABOVE.

STEERING DRAG LINK



- Model
- ★ Application

Code	OEM new	OEM old
61656	390784	

- 3 TRUCK
- ★ R93/113/143

NUT



- 3 TRUCK
- ★
- 4 TRUCK
- ★
- P-G-R-T TRUCK
- ★

64727	1345206	
-------	---------	--

ALL THE COMPONENTS LISTED IN OUR CATALOGUE ARE NOT ORIGINAL, THOUGH PERFECTLY INTERCHANGEABLE. REFERENCE NUMBERS, EITHER ORIGINAL OR OF A DIFFERENT NATURE, ARE FOR INFORMATION PURPOSES ONLY. WHEN PLACING AN ORDER, PLEASE, ALWAYS USE COSIBO REFERENCE NUMBERS AND DO NOT MENTION THE ORIGINAL REFERENCE NUMBERS OF THE TRUCK MANUFACTURERS IN THE INVOICE TO VEHICLE OWNERS OR TO ANYBODY ELSE. THE CUSTOMER TAKES HIS OWN RESPONSIBILITY IF HE DOES NOT COMPLY WITH WHAT ABOVE.

FLEXIBLE HOSE



- Model
- ★ Application

Code

OEM new

OEM old

63353

346077

- 3 TRUCK

- ★ R113/143

- 4 TRUCK

- ★

- P-G-R-T TRUCK

- ★ P/G/R

RUBBER HOSE



65359

1375391

- 4 TRUCK

- ★ 94 - 114 - 124 - 144 - 164

- P-G-R-T TRUCK

- ★ P/R/G

RUBBER HOSE



64721

1375390

- 4 TRUCK

- ★ 94 - 114 - 124 - 144 - 164

- P-G-R-T TRUCK

- ★ P/R/G

ALL THE COMPONENTS LISTED IN OUR CATALOGUE ARE NOT ORIGINAL, THOUGH PERFECTLY INTERCHANGEABLE. REFERENCE NUMBERS, EITHER ORIGINAL OR OF A DIFFERENT NATURE, ARE FOR INFORMATION PURPOSES ONLY. WHEN PLACING AN ORDER, PLEASE, ALWAYS USE COSIBO REFERENCE NUMBERS AND DO NOT MENTION THE ORIGINAL REFERENCE NUMBERS OF THE TRUCK MANUFACTURERS IN THE INVOICE TO VEHICLE OWNERS OR TO ANYBODY ELSE. THE CUSTOMER TAKES HIS OWN RESPONSIBILITY IF HE DOES NOT COMPLY WITH WHAT ABOVE.

	Code	OEM new	OEM old
O-RING DIAM.=59,5X3 mm	60636	332119	392663
<ul style="list-style-type: none"> ● Model ★ Application 			
<ul style="list-style-type: none"> ● 3 BUS ★ 			
<ul style="list-style-type: none"> ● 4 TRUCK ★ 			
<ul style="list-style-type: none"> ● F-K-N BUS ★ K UD 6X2 			
<ul style="list-style-type: none"> ● P-G-R-T TRUCK ★ 			

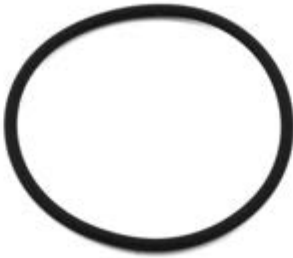

O-RING	64408	804664	
<ul style="list-style-type: none"> ● 4 BUS ★ F94 H 			
<ul style="list-style-type: none"> ● 4 TRUCK ★ 			
<ul style="list-style-type: none"> ● P-G-R-T TRUCK ★ 			



O-RING	63562	812418	182525
<ul style="list-style-type: none"> ● 3 BUS ★ 			
<ul style="list-style-type: none"> ● 3 TRUCK ★ 			
<ul style="list-style-type: none"> ● IND.MARINE ENGINE 4 ★ 			



ALL THE COMPONENTS LISTED IN OUR CATALOGUE ARE NOT ORIGINAL, THOUGH PERFECTLY INTERCHANGEABLE. REFERENCE NUMBERS, EITHER ORIGINAL OR OF A DIFFERENT NATURE, ARE FOR INFORMATION PURPOSES ONLY. WHEN PLACING AN ORDER, PLEASE, ALWAYS USE COSIBO REFERENCE NUMBERS AND DO NOT MENTION THE ORIGINAL REFERENCE NUMBERS OF THE TRUCK MANUFACTURERS IN THE INVOICE TO VEHICLE OWNERS OR TO ANYBODY ELSE. THE CUSTOMER TAKES HIS OWN RESPONSIBILITY IF HE DOES NOT COMPLY WITH WHAT ABOVE.

OIL FILTER

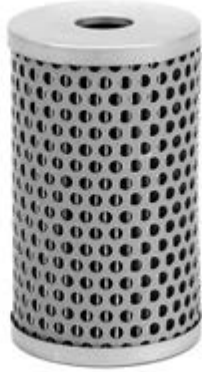

● Model
★ Application

	Code	OEM new	OEM old
	61758	153468	
● 3 BUS ★			
● 3 TRUCK ★			
● 4 BUS ★			
● 4 TRUCK ★			
● F-K-N BUS ★			
● P-G-R-T TRUCK ★			

ALL THE COMPONENTS LISTED IN OUR CATALOGUE ARE NOT ORIGINAL, THOUGH PERFECTLY INTERCHANGEABLE. REFERENCE NUMBERS, EITHER ORIGINAL OR OF A DIFFERENT NATURE, ARE FOR INFORMATION PURPOSES ONLY. WHEN PLACING AN ORDER, PLEASE, ALWAYS USE COSIBO REFERENCE NUMBERS AND DO NOT MENTION THE ORIGINAL REFERENCE NUMBERS OF THE TRUCK MANUFACTURERS IN THE INVOICE TO VEHICLE OWNERS OR TO ANYBODY ELSE. THE CUSTOMER TAKES HIS OWN RESPONSIBILITY IF HE DOES NOT COMPLY WITH WHAT ABOVE.

CABLE HARNESS



- Model
- ★ Application

Code

OEM new

OEM old

65426

1525357

- P-G-R-T TRUCK

- ★

CABLE HARNESS



- P-G-R-T TRUCK

- ★

65427

1524331

SWITCH



- F-K-N BUS

- ★

- P-G-R-T TRUCK

- ★

65539

1486287

ALL THE COMPONENTS LISTED IN OUR CATALOGUE ARE NOT ORIGINAL, THOUGH PERFECTLY INTERCHANGEABLE. REFERENCE NUMBERS, EITHER ORIGINAL OR OF A DIFFERENT NATURE, ARE FOR INFORMATION PURPOSES ONLY. WHEN PLACING AN ORDER, PLEASE, ALWAYS USE COSIBO REFERENCE NUMBERS AND DO NOT MENTION THE ORIGINAL REFERENCE NUMBERS OF THE TRUCK MANUFACTURERS IN THE INVOICE TO VEHICLE OWNERS OR TO ANYBODY ELSE. THE CUSTOMER TAKES HIS OWN RESPONSIBILITY IF HE DOES NOT COMPLY WITH WHAT ABOVE.

		Code	OEM new	OEM old
CLAMP	● Model	65402	1466075	
	★ Application			
	● 3 TRUCK			
	★			
	● 4 BUS			
	★			
	● 4 TRUCK			
	★			
	● F-K-N BUS			
	★			
● P-G-R-T TRUCK				
★				



CLAMP D. 16		64084	813937	
	● 3 BUS			
	★			
	● 4 BUS			
	★			
	● F-K-N BUS			
	★			
	● 3 TRUCK			
	★			



ALL THE COMPONENTS LISTED IN OUR CATALOGUE ARE NOT ORIGINAL, THOUGH PERFECTLY INTERCHANGEABLE. REFERENCE NUMBERS, EITHER ORIGINAL OR OF A DIFFERENT NATURE, ARE FOR INFORMATION PURPOSES ONLY. WHEN PLACING AN ORDER, PLEASE, ALWAYS USE COSIBO REFERENCE NUMBERS AND DO NOT MENTION THE ORIGINAL REFERENCE NUMBERS OF THE TRUCK MANUFACTURERS IN THE INVOICE TO VEHICLE OWNERS OR TO ANYBODY ELSE. THE CUSTOMER TAKES HIS OWN RESPONSIBILITY IF HE DOES NOT COMPLY WITH WHAT ABOVE.



	Code	OEM new	OEM old
CLAMP D.20	64085	813939	
● Model			
★ Application			
● 3 BUS			
★			
● 4 BUS			
★			
● F-K-N BUS			
★			
● 3 TRUCK			
★			
● 4 TRUCK			
★			
● P-G-R-T TRUCK			
★			



	Code	OEM new	OEM old
CLAMP D.25	64086	813941	
● 3 BUS			
★			
● 4 BUS			
★			
● F-K-N BUS			
★			
● 3 TRUCK			
★			
● 4 TRUCK			
★			



ALL THE COMPONENTS LISTED IN OUR CATALOGUE ARE NOT ORIGINAL, THOUGH PERFECTLY INTERCHANGEABLE. REFERENCE NUMBERS, EITHER ORIGINAL OR OF A DIFFERENT NATURE, ARE FOR INFORMATION PURPOSES ONLY. WHEN PLACING AN ORDER, PLEASE, ALWAYS USE COSIBO REFERENCE NUMBERS AND DO NOT MENTION THE ORIGINAL REFERENCE NUMBERS OF THE TRUCK MANUFACTURERS IN THE INVOICE TO VEHICLE OWNERS OR TO ANYBODY ELSE. THE CUSTOMER TAKES HIS OWN RESPONSIBILITY IF HE DOES NOT COMPLY WITH WHAT ABOVE.

	Code	OEM new	OEM old
<p>CLAMP D.13</p> 	64091	813936	
<ul style="list-style-type: none"> ● Model ★ Application 			
<ul style="list-style-type: none"> ● 4 BUS ★ 			
<ul style="list-style-type: none"> ● F-K-N BUS ★ 			
<ul style="list-style-type: none"> ● 3 TRUCK ★ 			
<ul style="list-style-type: none"> ● 4 TRUCK ★ 			
<ul style="list-style-type: none"> ● P-G-R-T TRUCK ★ 			
<p>CLAMP D.18</p> 	64092	813938	
<ul style="list-style-type: none"> ● 3 BUS ★ 			
<ul style="list-style-type: none"> ● 3 TRUCK ★ 			
<p>CLAMP D.28</p> 	64095	804578	
<ul style="list-style-type: none"> ● 4 BUS ★ 			
<ul style="list-style-type: none"> ● 3 TRUCK ★ 			
<ul style="list-style-type: none"> ● 4 TRUCK ★ 			
<ul style="list-style-type: none"> ● P-G-R-T TRUCK ★ 			

ALL THE COMPONENTS LISTED IN OUR CATALOGUE ARE NOT ORIGINAL, THOUGH PERFECTLY INTERCHANGEABLE. REFERENCE NUMBERS, EITHER ORIGINAL OR OF A DIFFERENT NATURE, ARE FOR INFORMATION PURPOSES ONLY. WHEN PLACING AN ORDER, PLEASE, ALWAYS USE COSIBO REFERENCE NUMBERS AND DO NOT MENTION THE ORIGINAL REFERENCE NUMBERS OF THE TRUCK MANUFACTURERS IN THE INVOICE TO VEHICLE OWNERS OR TO ANYBODY ELSE. THE CUSTOMER TAKES HIS OWN RESPONSIBILITY IF HE DOES NOT COMPLY WITH WHAT ABOVE.

CLAMP D.32



- Model
- ★ Application

Code	OEM new	OEM old
64100	804583	

- 3 TRUCK

- ★

ALL THE COMPONENTS LISTED IN OUR CATALOGUE ARE NOT ORIGINAL, THOUGH PERFECTLY INTERCHANGEABLE. REFERENCE NUMBERS, EITHER ORIGINAL OR OF A DIFFERENT NATURE, ARE FOR INFORMATION PURPOSES ONLY. WHEN PLACING AN ORDER, PLEASE, ALWAYS USE COSIBO REFERENCE NUMBERS AND DO NOT MENTION THE ORIGINAL REFERENCE NUMBERS OF THE TRUCK MANUFACTURERS IN THE INVOICE TO VEHICLE OWNERS OR TO ANYBODY ELSE. THE CUSTOMER TAKES HIS OWN RESPONSIBILITY IF HE DOES NOT COMPLY WITH WHAT ABOVE.

LH SPOT LAMP CLEAR LENS



- Model
- ★ Application

Code	OEM new	OEM old
62425	1852569	1446353

- P-G-R-T TRUCK
- ★ LOW & HIGH BUMPER

RH SPOT LAMP CLEAR LENS



- P-G-R-T TRUCK
- ★ LOW & HIGH BUMPER

62424	1852570	1446354
-------	---------	---------

LH FOG LAMP CLEAR LENS



- P-G-R-T TRUCK
- ★ LOW & HIGH BUMPER

62426	1852572	1446355
-------	---------	---------

ALL THE COMPONENTS LISTED IN OUR CATALOGUE ARE NOT ORIGINAL, THOUGH PERFECTLY INTERCHANGEABLE. REFERENCE NUMBERS, EITHER ORIGINAL OR OF A DIFFERENT NATURE, ARE FOR INFORMATION PURPOSES ONLY. WHEN PLACING AN ORDER, PLEASE, ALWAYS USE COSIBO REFERENCE NUMBERS AND DO NOT MENTION THE ORIGINAL REFERENCE NUMBERS OF THE TRUCK MANUFACTURERS IN THE INVOICE TO VEHICLE OWNERS OR TO ANYBODY ELSE. THE CUSTOMER TAKES HIS OWN RESPONSIBILITY IF HE DOES NOT COMPLY WITH WHAT ABOVE.

RH FOG LAMP CLEAR LENS



- Model
- ★ Application
- P-G-R-T TRUCK
- ★ LOW & HIGH BUMPER

Code	OEM new	OEM old
62427	1852573	1446356

LH LAMP HOUSING



- P-G-R-T TRUCK
- ★ LOW & HIGH BUMPER

64672	1786692	1523881
-------	---------	---------

RH LAMP HOUSING



- P-G-R-T TRUCK
- ★ LOW & HIGH BUMPER

64673	1786693	1523882
-------	---------	---------

LH FOG LAMP



- 4 TRUCK
- ★ 94 - 114 - 124 - 144 - 164

62261	1529070	1422991
-------	---------	---------

ALL THE COMPONENTS LISTED IN OUR CATALOGUE ARE NOT ORIGINAL, THOUGH PERFECTLY INTERCHANGEABLE. REFERENCE NUMBERS, EITHER ORIGINAL OR OF A DIFFERENT NATURE, ARE FOR INFORMATION PURPOSES ONLY. WHEN PLACING AN ORDER, PLEASE, ALWAYS USE COSIBO REFERENCE NUMBERS AND DO NOT MENTION THE ORIGINAL REFERENCE NUMBERS OF THE TRUCK MANUFACTURERS IN THE INVOICE TO VEHICLE OWNERS OR TO ANYBODY ELSE. THE CUSTOMER TAKES HIS OWN RESPONSIBILITY IF HE DOES NOT COMPLY WITH WHAT ABOVE.

RH FOG LAMP



- Model
- ★ Application

Code	OEM new	OEM old
62262	1529071	1422992

- 4 TRUCK
- ★ 94 - 114 - 124 - 144 - 164

FOG LIGHT BRACKET



- 4 TRUCK
- ★
- P-G-R-T TRUCK
- ★

65411	1520919	1358833
-------	---------	---------

FOG LAMP BULB HOLDER



- 4 TRUCK
- ★
- P-G-R-T TRUCK
- ★

62234	1400209	
-------	---------	--

LHD,LH HEADLAMP ASSY



"This item may not be available on every market"

- 4 TRUCK
- ★ 94 - 114 - 124 - 144 - 164
- P-G-R-T TRUCK
- ★

62258	1732509	1431257 1446587 1467000
-------	---------	-------------------------------

ALL THE COMPONENTS LISTED IN OUR CATALOGUE ARE NOT ORIGINAL, THOUGH PERFECTLY INTERCHANGEABLE. REFERENCE NUMBERS, EITHER ORIGINAL OR OF A DIFFERENT NATURE, ARE FOR INFORMATION PURPOSES ONLY. WHEN PLACING AN ORDER, PLEASE, ALWAYS USE COSIBO REFERENCE NUMBERS AND DO NOT MENTION THE ORIGINAL REFERENCE NUMBERS OF THE TRUCK MANUFACTURERS IN THE INVOICE TO VEHICLE OWNERS OR TO ANYBODY ELSE. THE CUSTOMER TAKES HIS OWN RESPONSIBILITY IF HE DOES NOT COMPLY WITH WHAT ABOVE.

LHD,RH HEADLAMP ASSY

- Model
- ★ Application

Code	OEM new	OEM old
62257	1732510	1431256 1446588 1467003

- 4 TRUCK
- ★ 94 - 114 - 124 - 144 - 164

- P-G-R-T TRUCK
- ★



"This item may not be available on every market"

LH LENS

62278 1446583

- 4 TRUCK
- ★ 94 - 114 - 124 - 144 - 164 FOR OUR 62258

- P-G-R-T TRUCK
- ★ FOR OUR 62258



"This item may not be available on every market"

RH LENS

62279 1446584

- 4 TRUCK
- ★ 94 - 114 - 124 - 144 - 164 FOR OUR 62257

- P-G-R-T TRUCK
- ★ FOR OUR 62257



"This item may not be available on every market"

LHD,LH HEADLAMP REFLECTOR

62358 1385406

- 4 TRUCK
- ★ 94 - 114 - 124 - 144 - 164 FOR OUR 62258

- P-G-R-T TRUCK
- ★ FOR OUR 62258



ALL THE COMPONENTS LISTED IN OUR CATALOGUE ARE NOT ORIGINAL, THOUGH PERFECTLY INTERCHANGEABLE. REFERENCE NUMBERS, EITHER ORIGINAL OR OF A DIFFERENT NATURE, ARE FOR INFORMATION PURPOSES ONLY. WHEN PLACING AN ORDER, PLEASE, ALWAYS USE COSIBO REFERENCE NUMBERS AND DO NOT MENTION THE ORIGINAL REFERENCE NUMBERS OF THE TRUCK MANUFACTURERS IN THE INVOICE TO VEHICLE OWNERS OR TO ANYBODY ELSE. THE CUSTOMER TAKES HIS OWN RESPONSIBILITY IF HE DOES NOT COMPLY WITH WHAT ABOVE.

	Code	OEM new	OEM old
LHD,RH HEADLAMP REFLECTOR	62359	1385407	
<ul style="list-style-type: none"> ● Model ★ Application 			
<ul style="list-style-type: none"> ● 4 TRUCK ★ 94 - 114 - 124 - 144 - 164 FOR OUR 62257 			
<ul style="list-style-type: none"> ● P-G-R-T TRUCK ★ FOR OUR 62257 			



LH HEADLAMP FRAME	62387	1385402	
<ul style="list-style-type: none"> ● 4 TRUCK ★ 94 - 114 - 124 - 144 - 164 FOR OUR 62257 & 62258 - 63915 & 63916 			
<ul style="list-style-type: none"> ● P-G-R-T TRUCK ★ FOR OUR 62257 & 62258 - 63915 & 63916 			



RH HEADLAMP FRAME	62388	1385403	
<ul style="list-style-type: none"> ● 4 TRUCK ★ 94 - 114 - 124 - 144 - 164 FOR OUR 62257 & 62258 - 63915 & 63916 			
<ul style="list-style-type: none"> ● P-G-R-T TRUCK ★ FOR OUR 62257 & 62258 - 63915 & 63916 			



LH/RH BULB HOLDER	62404	1732515	1467007
<ul style="list-style-type: none"> ● 4 TRUCK ★ 94 - 114 - 124 - 144 - 164 FOR OUR 62257 & 62258 - 63915 & 63916 			
<ul style="list-style-type: none"> ● P-G-R-T TRUCK ★ FOR OUR 62257 & 62258 - 63915 & 63916 			



ALL THE COMPONENTS LISTED IN OUR CATALOGUE ARE NOT ORIGINAL, THOUGH PERFECTLY INTERCHANGEABLE. REFERENCE NUMBERS, EITHER ORIGINAL OR OF A DIFFERENT NATURE, ARE FOR INFORMATION PURPOSES ONLY. WHEN PLACING AN ORDER, PLEASE, ALWAYS USE COSIBO REFERENCE NUMBERS AND DO NOT MENTION THE ORIGINAL REFERENCE NUMBERS OF THE TRUCK MANUFACTURERS IN THE INVOICE TO VEHICLE OWNERS OR TO ANYBODY ELSE. THE CUSTOMER TAKES HIS OWN RESPONSIBILITY IF HE DOES NOT COMPLY WITH WHAT ABOVE.

RHD,LH HEADLAMP ASSY



"This item may not be available on every market"

- Model
- ★ Application

Code	OEM new	OEM old
63915	1732507	1348539 1431255 1446585 1467001

- 4 TRUCK
- ★ 94 - 114 - 124 - 144 - 164

- P-G-R-T TRUCK
- ★

RHD,RH HEADLAMP ASSY



"This item may not be available on every market"

- 4 TRUCK
- ★ 94 - 114 - 124 - 144 - 164

- P-G-R-T TRUCK
- ★

63916	1732508	1348540 1431254 1446586 1467002
--------------	---------	--

LH LENS





"This item may not be available on every market"

- 4 TRUCK
- ★ 94 - 114 - 124 - 144 - 164 FOR OUR 63915
- P-G-R-T TRUCK
- ★ FOR OUR 63915

65373	1446581	1349781
--------------	---------	---------

ALL THE COMPONENTS LISTED IN OUR CATALOGUE ARE NOT ORIGINAL, THOUGH PERFECTLY INTERCHANGEABLE. REFERENCE NUMBERS, EITHER ORIGINAL OR OF A DIFFERENT NATURE, ARE FOR INFORMATION PURPOSES ONLY. WHEN PLACING AN ORDER, PLEASE, ALWAYS USE COSIBO REFERENCE NUMBERS AND DO NOT MENTION THE ORIGINAL REFERENCE NUMBERS OF THE TRUCK MANUFACTURERS IN THE INVOICE TO VEHICLE OWNERS OR TO ANYBODY ELSE. THE CUSTOMER TAKES HIS OWN RESPONSIBILITY IF HE DOES NOT COMPLY WITH WHAT ABOVE.

	Code	OEM new	OEM old
RH LENS	65374	1446582	1349782
<ul style="list-style-type: none"> ● Model ★ Application 			
<ul style="list-style-type: none"> ● 4 TRUCK ★ 94 - 114 - 124 - 144 - 164 FOR OUR 63916 			
<ul style="list-style-type: none"> ● P-G-R-T TRUCK ★ FOR OUR NS. 63916 			
 <p>"This item may not be available on every market"</p>			

LH HEADLAMP ASSY	63600	1308473	
<ul style="list-style-type: none"> ● 2 TRUCK ★ 82 - 92 - 112 - 142 			
<ul style="list-style-type: none"> ● 3 TRUCK ★ STREAMLINE - 93 - 113 - 143 			
			

RH HEADLAMP ASSY	63599	1308474	
<ul style="list-style-type: none"> ● 2 TRUCK ★ 82 - 92 - 112 - 142 			
<ul style="list-style-type: none"> ● 2 TRUCK ★ 82 - 92 - 112 - 142 			
<ul style="list-style-type: none"> ● 3 TRUCK ★ STREAMLINE - 93 - 113 - 143 			
<ul style="list-style-type: none"> ● 3 TRUCK ★ STREAMLINE - 93 - 113 - 143 			
			

ALL THE COMPONENTS LISTED IN OUR CATALOGUE ARE NOT ORIGINAL, THOUGH PERFECTLY INTERCHANGEABLE. REFERENCE NUMBERS, EITHER ORIGINAL OR OF A DIFFERENT NATURE, ARE FOR INFORMATION PURPOSES ONLY. WHEN PLACING AN ORDER, PLEASE, ALWAYS USE COSIBO REFERENCE NUMBERS AND DO NOT MENTION THE ORIGINAL REFERENCE NUMBERS OF THE TRUCK MANUFACTURERS IN THE INVOICE TO VEHICLE OWNERS OR TO ANYBODY ELSE. THE CUSTOMER TAKES HIS OWN RESPONSIBILITY IF HE DOES NOT COMPLY WITH WHAT ABOVE.

LH/RH HEADLAMP LENS



	Code	OEM new	OEM old
● Model	62298	280553	
★ Application			
● 2 TRUCK			
★ 82 - 92 - 112 - 142 FOR OUR 63600 & 63599			
● 3 TRUCK			
★ STREAMLINE - 93 - 113 - 143 FOR OUR 63600 & 63599			

LH/RH XENON SET



"This item may not be available on every market"

	Code	OEM new	OEM old
	64669	1746246	
● 4 TRUCK			
★ 94-114-124-144-164			
● P-G-R-T TRUCK			
★			

BRAKET



	Code	OEM new	OEM old
	65472	1493381	
● P-G-R-T TRUCK			
★ LOW BUMPER - HIGH BUMPER			

LH XENON LAMP LENS



	Code	OEM new	OEM old
	65419	1549814	1521565
● 4 TRUCK			
★ 94-114-124-144-164			
● P-G-R-T TRUCK			
★			

ALL THE COMPONENTS LISTED IN OUR CATALOGUE ARE NOT ORIGINAL, THOUGH PERFECTLY INTERCHANGEABLE. REFERENCE NUMBERS, EITHER ORIGINAL OR OF A DIFFERENT NATURE, ARE FOR INFORMATION PURPOSES ONLY. WHEN PLACING AN ORDER, PLEASE, ALWAYS USE COSIBO REFERENCE NUMBERS AND DO NOT MENTION THE ORIGINAL REFERENCE NUMBERS OF THE TRUCK MANUFACTURERS IN THE INVOICE TO VEHICLE OWNERS OR TO ANYBODY ELSE. THE CUSTOMER TAKES HIS OWN RESPONSIBILITY IF HE DOES NOT COMPLY WITH WHAT ABOVE.

	Code	OEM new	OEM old
RH XENON LAMP LENS	65420	1549815	1521566
<ul style="list-style-type: none"> ● Model ★ Application 			
<ul style="list-style-type: none"> ● 4 TRUCK ★ 94-114-124-144-164 			
<ul style="list-style-type: none"> ● P-G-R-T TRUCK ★ 			



LH XENON LAMP WIPER	65410	1733180	
<ul style="list-style-type: none"> ● 4 TRUCK ★ 94-114-124-144-164 			
<ul style="list-style-type: none"> ● P-G-R-T TRUCK ★ 			



XENON LAMP BRUSH	65409	1725593	
<ul style="list-style-type: none"> ● 4 TRUCK ★ 94-114-124-144-164 			
<ul style="list-style-type: none"> ● P-G-R-T TRUCK ★ 			



RH XENON LAMP WIPER	64328	1733181	
<ul style="list-style-type: none"> ● 4 TRUCK ★ 94-114-124-144-164 			
<ul style="list-style-type: none"> ● P-G-R-T TRUCK ★ 			



ALL THE COMPONENTS LISTED IN OUR CATALOGUE ARE NOT ORIGINAL, THOUGH PERFECTLY INTERCHANGEABLE. REFERENCE NUMBERS, EITHER ORIGINAL OR OF A DIFFERENT NATURE, ARE FOR INFORMATION PURPOSES ONLY. WHEN PLACING AN ORDER, PLEASE, ALWAYS USE COSIBO REFERENCE NUMBERS AND DO NOT MENTION THE ORIGINAL REFERENCE NUMBERS OF THE TRUCK MANUFACTURERS IN THE INVOICE TO VEHICLE OWNERS OR TO ANYBODY ELSE. THE CUSTOMER TAKES HIS OWN RESPONSIBILITY IF HE DOES NOT COMPLY WITH WHAT ABOVE.

	Code	OEM new	OEM old
RHD,LH HEADLAMP REFLECTOR	65375	1385413	
<ul style="list-style-type: none"> ● Model ★ Application 			
<ul style="list-style-type: none"> ● 4 TRUCK 			
<ul style="list-style-type: none"> ★ 94 - 114 - 124 - 144 - 164 FOR OUR 63915 			
<ul style="list-style-type: none"> ● P-G-R-T TRUCK 			
<ul style="list-style-type: none"> ★ FOR OUR 63915 			



RHD,RH HEADLAMP REFLECTOR	65376	138414	
<ul style="list-style-type: none"> ● 4 TRUCK 			
<ul style="list-style-type: none"> ★ 94 - 114 - 124 - 144 - 164 FOR OUR 63916 			
<ul style="list-style-type: none"> ● P-G-R-T TRUCK 			
<ul style="list-style-type: none"> ★ FOR OUR 63916 			



HADLAMP SEAL	65377	1385409	
<ul style="list-style-type: none"> ● 4 TRUCK 			
<ul style="list-style-type: none"> ★ 94 - 114 - 124 - 144 - 164 FOR OUR 62257 & 62258 - 63915 & 63916 			
<ul style="list-style-type: none"> ● P-G-R-T TRUCK 			
<ul style="list-style-type: none"> ★ FOR OUR 62257 & 62258 - 63915 & 63916 			



LIGHT HOUSING	64683	1300831	370990
<ul style="list-style-type: none"> ● 3 TRUCK 			
<ul style="list-style-type: none"> ★ 			

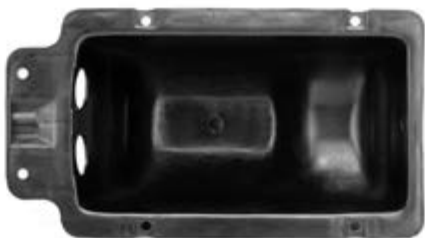

ALL THE COMPONENTS LISTED IN OUR CATALOGUE ARE NOT ORIGINAL, THOUGH PERFECTLY INTERCHANGEABLE. REFERENCE NUMBERS, EITHER ORIGINAL OR OF A DIFFERENT NATURE, ARE FOR INFORMATION PURPOSES ONLY. WHEN PLACING AN ORDER, PLEASE, ALWAYS USE COSIBO REFERENCE NUMBERS AND DO NOT MENTION THE ORIGINAL REFERENCE NUMBERS OF THE TRUCK MANUFACTURERS IN THE INVOICE TO VEHICLE OWNERS OR TO ANYBODY ELSE. THE CUSTOMER TAKES HIS OWN RESPONSIBILITY IF HE DOES NOT COMPLY WITH WHAT ABOVE.

LIGHT DAMPER



- Model
 - ★ Application
-
- P-G-R-T TRUCK
 - ★

Code	OEM new	OEM old
60023	1412265	1327274

ALL THE COMPONENTS LISTED IN OUR CATALOGUE ARE NOT ORIGINAL, THOUGH PERFECTLY INTERCHANGEABLE. REFERENCE NUMBERS, EITHER ORIGINAL OR OF A DIFFERENT NATURE, ARE FOR INFORMATION PURPOSES ONLY. WHEN PLACING AN ORDER, PLEASE, ALWAYS USE COSIBO REFERENCE NUMBERS AND DO NOT MENTION THE ORIGINAL REFERENCE NUMBERS OF THE TRUCK MANUFACTURERS IN THE INVOICE TO VEHICLE OWNERS OR TO ANYBODY ELSE. THE CUSTOMER TAKES HIS OWN RESPONSIBILITY IF HE DOES NOT COMPLY WITH WHAT ABOVE.

LH INDICATOR



"This item may not be available on every market"

- Model
- ★ Application

Code	OEM new	OEM old
60511	1385410	

- 4 TRUCK

- ★ 94 - 114 - 124 - 144 - 164 FOR OUR 62258 - 63915

- P-G-R-T TRUCK

- ★ FOR OUR 62258 - 63915

RH INDICATOR



"This item may not be available on every market"

- 4 TRUCK

- ★ 94 - 114 - 124 - 144 - 164 FOR OUR 62257 - 63916

- P-G-R-T TRUCK

- ★ FOR OUR 62257 - 63916

60512	1387155	
-------	---------	--

LH/RH CORNER LAMP



- P-G-R-T TRUCK

- ★ FOR XENON LIGHT LHD & RHD

64653	1747981	1521683
-------	---------	---------

ALL THE COMPONENTS LISTED IN OUR CATALOGUE ARE NOT ORIGINAL, THOUGH PERFECTLY INTERCHANGEABLE. REFERENCE NUMBERS, EITHER ORIGINAL OR OF A DIFFERENT NATURE, ARE FOR INFORMATION PURPOSES ONLY. WHEN PLACING AN ORDER, PLEASE, ALWAYS USE COSIBO REFERENCE NUMBERS AND DO NOT MENTION THE ORIGINAL REFERENCE NUMBERS OF THE TRUCK MANUFACTURERS IN THE INVOICE TO VEHICLE OWNERS OR TO ANYBODY ELSE. THE CUSTOMER TAKES HIS OWN RESPONSIBILITY IF HE DOES NOT COMPLY WITH WHAT ABOVE.

	Code	OEM new	OEM old
LH INDICATOR LAMP ASSY	61661	1365968	394766
<ul style="list-style-type: none"> ● Model ★ Application 			
<ul style="list-style-type: none"> ● 2 TRUCK 			
<ul style="list-style-type: none"> ★ 92 - 112 - 142 			
<ul style="list-style-type: none"> ● 3 TRUCK 			
<ul style="list-style-type: none"> ★ 93 - 113 - 143 			

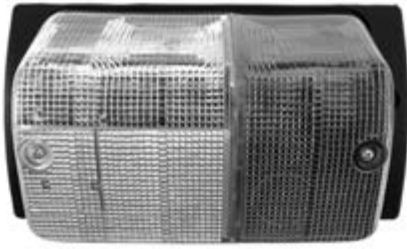

RH INDICATOR LAMP ASSY	61662	1365969	394767
<ul style="list-style-type: none"> ● 2 TRUCK 			
<ul style="list-style-type: none"> ★ 92 - 112 - 142 			
<ul style="list-style-type: none"> ● 3 TRUCK 			
<ul style="list-style-type: none"> ★ 93 - 113 - 143 			

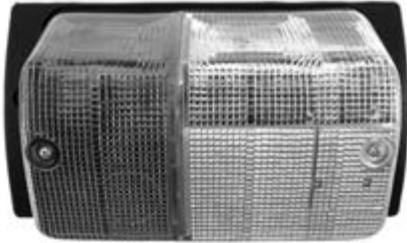

LH INDICATOR LAMP ASSY	62270	394768	
<ul style="list-style-type: none"> ● 2 TRUCK 			
<ul style="list-style-type: none"> ★ 92 - 112 - 142 			
<ul style="list-style-type: none"> ● 3 TRUCK 			
<ul style="list-style-type: none"> ★ 93 - 113 - 143 			



RH INDICATOR LAMP ASSY	62271	394769	
<ul style="list-style-type: none"> ● 2 TRUCK 			
<ul style="list-style-type: none"> ★ 92 - 112 - 142 			
<ul style="list-style-type: none"> ● 3 TRUCK 			
<ul style="list-style-type: none"> ★ 93 - 113 - 143 			

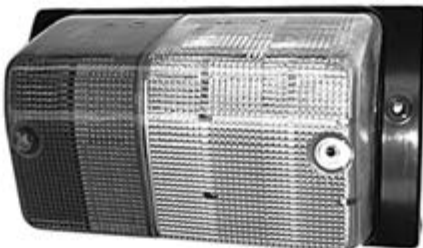

ALL THE COMPONENTS LISTED IN OUR CATALOGUE ARE NOT ORIGINAL, THOUGH PERFECTLY INTERCHANGEABLE. REFERENCE NUMBERS, EITHER ORIGINAL OR OF A DIFFERENT NATURE, ARE FOR INFORMATION PURPOSES ONLY. WHEN PLACING AN ORDER, PLEASE, ALWAYS USE COSIBO REFERENCE NUMBERS AND DO NOT MENTION THE ORIGINAL REFERENCE NUMBERS OF THE TRUCK MANUFACTURERS IN THE INVOICE TO VEHICLE OWNERS OR TO ANYBODY ELSE. THE CUSTOMER TAKES HIS OWN RESPONSIBILITY IF HE DOES NOT COMPLY WITH WHAT ABOVE.

LH DIRECTION LAMP LENS

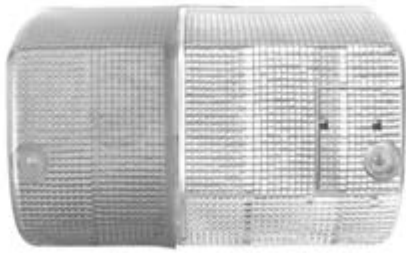

	Code	OEM new	OEM old
● Model	61663	1371292	313657
★ Application			
● 2 TRUCK			
★ 92 - 112 - 142			
● 3 TRUCK			
★ 93 - 113 - 143			

RH DIRECTION LAMP LENS

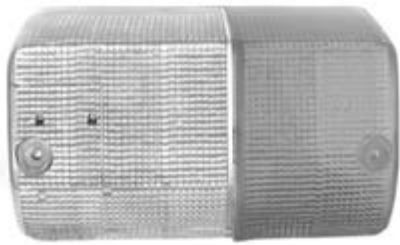

	Code	OEM new	OEM old
	61664	1371293	313658
● 2 TRUCK			
★ 92 - 112 - 142			
● 3 TRUCK			
★ 93 - 113 - 143			

INDICATOR AND PARKING LAMP



	Code	OEM new	OEM old
	62523	1304786	
● 3 TRUCK			
★ STREAMLINE			

SIDE INDICATOR



	Code	OEM new	OEM old
	62420	1304787	
● 3 TRUCK			
★ STREAMLINE			

ALL THE COMPONENTS LISTED IN OUR CATALOGUE ARE NOT ORIGINAL, THOUGH PERFECTLY INTERCHANGEABLE. REFERENCE NUMBERS, EITHER ORIGINAL OR OF A DIFFERENT NATURE, ARE FOR INFORMATION PURPOSES ONLY. WHEN PLACING AN ORDER, PLEASE, ALWAYS USE COSIBO REFERENCE NUMBERS AND DO NOT MENTION THE ORIGINAL REFERENCE NUMBERS OF THE TRUCK MANUFACTURERS IN THE INVOICE TO VEHICLE OWNERS OR TO ANYBODY ELSE. THE CUSTOMER TAKES HIS OWN RESPONSIBILITY IF HE DOES NOT COMPLY WITH WHAT ABOVE.

REFLEX REFLECTOR



- Model
- ★ Application

Code	OEM new	OEM old
65542	1362707	

- P-G-R-T TRUCK
- ★

SIDE MARKER LAMP ASSY



- P-G-R-T TRUCK
- ★

62524	1770301	1722531
-------	---------	---------

ALL THE COMPONENTS LISTED IN OUR CATALOGUE ARE NOT ORIGINAL, THOUGH PERFECTLY INTERCHANGEABLE. REFERENCE NUMBERS, EITHER ORIGINAL OR OF A DIFFERENT NATURE, ARE FOR INFORMATION PURPOSES ONLY. WHEN PLACING AN ORDER, PLEASE, ALWAYS USE COSIBO REFERENCE NUMBERS AND DO NOT MENTION THE ORIGINAL REFERENCE NUMBERS OF THE TRUCK MANUFACTURERS IN THE INVOICE TO VEHICLE OWNERS OR TO ANYBODY ELSE. THE CUSTOMER TAKES HIS OWN RESPONSIBILITY IF HE DOES NOT COMPLY WITH WHAT ABOVE.

LH/RH REAR TAIL LAMP



- Model
- ★ Application

Code	OEM new	OEM old
63438	1368123	371894 371896

- **3 TRUCK**
- ★ MA - MK8X4

LH/RH REAR LENS



- **3 TRUCK**
- ★ MA - MK8X4

60496	297568	
--------------	--------	--

LH REAR LIGHT



- **3 TRUCK**
- ★ STD - MA6X2Z

63357	1386272	1365958 1365960
--------------	---------	--------------------

ALL THE COMPONENTS LISTED IN OUR CATALOGUE ARE NOT ORIGINAL, THOUGH PERFECTLY INTERCHANGEABLE. REFERENCE NUMBERS, EITHER ORIGINAL OR OF A DIFFERENT NATURE, ARE FOR INFORMATION PURPOSES ONLY. WHEN PLACING AN ORDER, PLEASE, ALWAYS USE COSIBO REFERENCE NUMBERS AND DO NOT MENTION THE ORIGINAL REFERENCE NUMBERS OF THE TRUCK MANUFACTURERS IN THE INVOICE TO VEHICLE OWNERS OR TO ANYBODY ELSE. THE CUSTOMER TAKES HIS OWN RESPONSIBILITY IF HE DOES NOT COMPLY WITH WHAT ABOVE.

RH REAR LIGHT



- Model
- ★ Application

Code	OEM new	OEM old
63356	1386271	1365959 1365961

- 3 TRUCK
- ★ STD - MA6X2Z

LIGHT DAMPER



- 3 TRUCK
- ★ MA - MK8X4

61317	366006	
-------	--------	--

LIGHT DAMPER



- 3 TRUCK
- ★ 4X4 6X6 HK6X4 - 8X4 TIPPER - MA HA MW 4X2 6X2 6X2/4 - STREAMLINE
- 4 TRUCK
- ★ 94 - 114 - 124 - 144 - 164

60023	1412265	1327274
-------	---------	---------

ALL THE COMPONENTS LISTED IN OUR CATALOGUE ARE NOT ORIGINAL, THOUGH PERFECTLY INTERCHANGEABLE. REFERENCE NUMBERS, EITHER ORIGINAL OR OF A DIFFERENT NATURE, ARE FOR INFORMATION PURPOSES ONLY. WHEN PLACING AN ORDER, PLEASE, ALWAYS USE COSIBO REFERENCE NUMBERS AND DO NOT MENTION THE ORIGINAL REFERENCE NUMBERS OF THE TRUCK MANUFACTURERS IN THE INVOICE TO VEHICLE OWNERS OR TO ANYBODY ELSE. THE CUSTOMER TAKES HIS OWN RESPONSIBILITY IF HE DOES NOT COMPLY WITH WHAT ABOVE.

LH/RH REAR LIGHT LENS



	Code	OEM new	OEM old
● Model	63359	1350343	
★ Application			
● 3 TRUCK			
★ ATTENDERE ISTRUZIONI IN VALUTAZIONE			

LH TAIL LAMP (LHD/RHD)



	Code	OEM new	OEM old
	60501	1504608	1387877 1436867
● 4 TRUCK			
★			

RH TAIL LAMP (LHD/RHD)



	Code	OEM new	OEM old
	60500	1504609	1387878 1436868
● 4 TRUCK			
★			

RH/LH LENS REAR LENS



	Code	OEM new	OEM old
	60492	1380819	
● 4 TRUCK			
★			

ALL THE COMPONENTS LISTED IN OUR CATALOGUE ARE NOT ORIGINAL, THOUGH PERFECTLY INTERCHANGEABLE. REFERENCE NUMBERS, EITHER ORIGINAL OR OF A DIFFERENT NATURE, ARE FOR INFORMATION PURPOSES ONLY. WHEN PLACING AN ORDER, PLEASE, ALWAYS USE COSIBO REFERENCE NUMBERS AND DO NOT MENTION THE ORIGINAL REFERENCE NUMBERS OF THE TRUCK MANUFACTURERS IN THE INVOICE TO VEHICLE OWNERS OR TO ANYBODY ELSE. THE CUSTOMER TAKES HIS OWN RESPONSIBILITY IF HE DOES NOT COMPLY WITH WHAT ABOVE.

	Code	OEM new	OEM old
REAR PLATE LIGHT	62269	1379384	
<ul style="list-style-type: none"> ● Model ★ Application 			
<ul style="list-style-type: none"> ● 4 TRUCK ★ 			
<ul style="list-style-type: none"> ● P-G-R-T TRUCK ★ 			
<ul style="list-style-type: none"> ● F-K-N BUS ★ CNUB 			



LH REAR LIGHT W/O PLATE LIGHT	64641	1504602	
--------------------------------------	--------------	---------	--



<ul style="list-style-type: none"> ● 4 TRUCK ★
--

RH REAR LIGHT W/O PLATE LIGHT	64642	1504603	
--------------------------------------	--------------	---------	--



<ul style="list-style-type: none"> ● 4 TRUCK ★
--

ALL THE COMPONENTS LISTED IN OUR CATALOGUE ARE NOT ORIGINAL, THOUGH PERFECTLY INTERCHANGEABLE. REFERENCE NUMBERS, EITHER ORIGINAL OR OF A DIFFERENT NATURE, ARE FOR INFORMATION PURPOSES ONLY. WHEN PLACING AN ORDER, PLEASE, ALWAYS USE COSIBO REFERENCE NUMBERS AND DO NOT MENTION THE ORIGINAL REFERENCE NUMBERS OF THE TRUCK MANUFACTURERS IN THE INVOICE TO VEHICLE OWNERS OR TO ANYBODY ELSE. THE CUSTOMER TAKES HIS OWN RESPONSIBILITY IF HE DOES NOT COMPLY WITH WHAT ABOVE.

LH REAR LIGHT W/O PLATE LIGHT



- Model
- ★ Application

65530

1792387

OEM old

- P-G-R-T TRUCK

- ★

RH REAR LIGHT W/O PLATE LIGHT



- P-G-R-T TRUCK

- ★

65531

1792388

REVERSING ALARM



- P-G-R-T TRUCK

- ★

65532

65532

ALL THE COMPONENTS LISTED IN OUR CATALOGUE ARE NOT ORIGINAL, THOUGH PERFECTLY INTERCHANGEABLE. REFERENCE NUMBERS, EITHER ORIGINAL OR OF A DIFFERENT NATURE, ARE FOR INFORMATION PURPOSES ONLY. WHEN PLACING AN ORDER, PLEASE, ALWAYS USE COSIBO REFERENCE NUMBERS AND DO NOT MENTION THE ORIGINAL REFERENCE NUMBERS OF THE TRUCK MANUFACTURERS IN THE INVOICE TO VEHICLE OWNERS OR TO ANYBODY ELSE. THE CUSTOMER TAKES HIS OWN RESPONSIBILITY IF HE DOES NOT COMPLY WITH WHAT ABOVE.

	Code	OEM new	OEM old
<p>LH REAR LIGHT WITH PLATE LIGHT</p> 	64639	1498102	
<ul style="list-style-type: none"> ● Model ★ Application 			
<ul style="list-style-type: none"> ● P-G-R-T TRUCK ★ 			
<p>RH REAR LIGHT W/O PLATE LIGHT</p> 	64640	1498103	
<ul style="list-style-type: none"> ● P-G-R-T TRUCK ★ 			
<p>RH TAIL LAMP W/O ALARM</p> 	64252	1792374	
<ul style="list-style-type: none"> ● 4 TRUCK ★ 			
<ul style="list-style-type: none"> ● P-G-R-T TRUCK ★ 			
<p>LH TAIL LAMP WITH PLATE LIGHT</p> 	64253	1792375	
<ul style="list-style-type: none"> ● 4 TRUCK ★ 			
<ul style="list-style-type: none"> ● P-G-R-T TRUCK ★ 			

ALL THE COMPONENTS LISTED IN OUR CATALOGUE ARE NOT ORIGINAL, THOUGH PERFECTLY INTERCHANGEABLE. REFERENCE NUMBERS, EITHER ORIGINAL OR OF A DIFFERENT NATURE, ARE FOR INFORMATION PURPOSES ONLY. WHEN PLACING AN ORDER, PLEASE, ALWAYS USE COSIBO REFERENCE NUMBERS AND DO NOT MENTION THE ORIGINAL REFERENCE NUMBERS OF THE TRUCK MANUFACTURERS IN THE INVOICE TO VEHICLE OWNERS OR TO ANYBODY ELSE. THE CUSTOMER TAKES HIS OWN RESPONSIBILITY IF HE DOES NOT COMPLY WITH WHAT ABOVE.

RH REAR LAMP WITH ALARM



- Model
- ★ Application

Code	OEM new	OEM old
65428	1870767	1546618

- P-G-R-T TRUCK

- ★

ALL THE COMPONENTS LISTED IN OUR CATALOGUE ARE NOT ORIGINAL, THOUGH PERFECTLY INTERCHANGEABLE. REFERENCE NUMBERS, EITHER ORIGINAL OR OF A DIFFERENT NATURE, ARE FOR INFORMATION PURPOSES ONLY. WHEN PLACING AN ORDER, PLEASE, ALWAYS USE COSIBO REFERENCE NUMBERS AND DO NOT MENTION THE ORIGINAL REFERENCE NUMBERS OF THE TRUCK MANUFACTURERS IN THE INVOICE TO VEHICLE OWNERS OR TO ANYBODY ELSE. THE CUSTOMER TAKES HIS OWN RESPONSIBILITY IF HE DOES NOT COMPLY WITH WHAT ABOVE.

LH HEADLIGHT HOUSING



	Code	OEM new	OEM old
● Model	62255	1543634	1324599
★ Application			
● 4 TRUCK			
★ 94 - 114 - 124 - 144 - 164			

RH HEADLIGHT HOUSING



	Code	OEM new	OEM old
	62254	1543635	1324600
● 4 TRUCK			
★ 94 - 114 - 124 - 144 - 164			

ALL THE COMPONENTS LISTED IN OUR CATALOGUE ARE NOT ORIGINAL, THOUGH PERFECTLY INTERCHANGEABLE. REFERENCE NUMBERS, EITHER ORIGINAL OR OF A DIFFERENT NATURE, ARE FOR INFORMATION PURPOSES ONLY. WHEN PLACING AN ORDER, PLEASE, ALWAYS USE COSIBO REFERENCE NUMBERS AND DO NOT MENTION THE ORIGINAL REFERENCE NUMBERS OF THE TRUCK MANUFACTURERS IN THE INVOICE TO VEHICLE OWNERS OR TO ANYBODY ELSE. THE CUSTOMER TAKES HIS OWN RESPONSIBILITY IF HE DOES NOT COMPLY WITH WHAT ABOVE.

	Code	OEM new	OEM old
LH BRACKET	62444	1375427	

- Model
- ★ Application

- 4 TRUCK
- ★ 94 - 114 - 124 - 144 - 164



RH BRACKET	62443	1375428	
-------------------	--------------	---------	--

- 4 TRUCK
- ★ 94 - 114 - 124 - 144 - 164



LH HEADLIGHT FRAME	64655	1727991	1438557
---------------------------	--------------	---------	---------

- P-G-R-T TRUCK
- ★ CG/CP/CR



ALL THE COMPONENTS LISTED IN OUR CATALOGUE ARE NOT ORIGINAL, THOUGH PERFECTLY INTERCHANGEABLE. REFERENCE NUMBERS, EITHER ORIGINAL OR OF A DIFFERENT NATURE, ARE FOR INFORMATION PURPOSES ONLY. WHEN PLACING AN ORDER, PLEASE, ALWAYS USE COSIBO REFERENCE NUMBERS AND DO NOT MENTION THE ORIGINAL REFERENCE NUMBERS OF THE TRUCK MANUFACTURERS IN THE INVOICE TO VEHICLE OWNERS OR TO ANYBODY ELSE. THE CUSTOMER TAKES HIS OWN RESPONSIBILITY IF HE DOES NOT COMPLY WITH WHAT ABOVE.

RH HEADLIGHT FRAME



- Model
- ★ Application

Code

OEM new

OEM old

64654

1727992

1438558

- P-G-R-T TRUCK

- ★ CG/CP/CR

LH HEADLAMP HOUSING



- P-G-R-T TRUCK

- ★ CG/CP/CR

64661

1936674

1431920
1790006

RH HEADLAMP HOUSING



- P-G-R-T TRUCK

- ★ CG/CP/CR

64660

1936675

1431921
1790007

ALL THE COMPONENTS LISTED IN OUR CATALOGUE ARE NOT ORIGINAL, THOUGH PERFECTLY INTERCHANGEABLE. REFERENCE NUMBERS, EITHER ORIGINAL OR OF A DIFFERENT NATURE, ARE FOR INFORMATION PURPOSES ONLY. WHEN PLACING AN ORDER, PLEASE, ALWAYS USE COSIBO REFERENCE NUMBERS AND DO NOT MENTION THE ORIGINAL REFERENCE NUMBERS OF THE TRUCK MANUFACTURERS IN THE INVOICE TO VEHICLE OWNERS OR TO ANYBODY ELSE. THE CUSTOMER TAKES HIS OWN RESPONSIBILITY IF HE DOES NOT COMPLY WITH WHAT ABOVE.

LH SUPPORT



"This item may not be available on every market"

- Model
- ★ Application

Code

OEM new

OEM old

64657

2124015

1431922

- P-G-R-T TRUCK

- ★ CR/CT D16

RH SUPPORT



"This item may not be available on every market"

- P-G-R-T TRUCK

- ★ CR/CT D16

64656

1431923

LH SUPPORT



"This item may not be available on every market"

- P-G-R-T TRUCK

- ★ CG/CP/CT D9/11/12

64659

1438563

ALL THE COMPONENTS LISTED IN OUR CATALOGUE ARE NOT ORIGINAL, THOUGH PERFECTLY INTERCHANGEABLE. REFERENCE NUMBERS, EITHER ORIGINAL OR OF A DIFFERENT NATURE, ARE FOR INFORMATION PURPOSES ONLY. WHEN PLACING AN ORDER, PLEASE, ALWAYS USE COSIBO REFERENCE NUMBERS AND DO NOT MENTION THE ORIGINAL REFERENCE NUMBERS OF THE TRUCK MANUFACTURERS IN THE INVOICE TO VEHICLE OWNERS OR TO ANYBODY ELSE. THE CUSTOMER TAKES HIS OWN RESPONSIBILITY IF HE DOES NOT COMPLY WITH WHAT ABOVE.

RH SUPPORT



"This item may not be available on every market"

- Model
 - ★ Application
-
- P-G-R-T TRUCK
 - ★ CG/CP/CT D9/11/12

Code	OEM new	OEM old
64658	1438564	

ALL THE COMPONENTS LISTED IN OUR CATALOGUE ARE NOT ORIGINAL, THOUGH PERFECTLY INTERCHANGEABLE. REFERENCE NUMBERS, EITHER ORIGINAL OR OF A DIFFERENT NATURE, ARE FOR INFORMATION PURPOSES ONLY. WHEN PLACING AN ORDER, PLEASE, ALWAYS USE COSIBO REFERENCE NUMBERS AND DO NOT MENTION THE ORIGINAL REFERENCE NUMBERS OF THE TRUCK MANUFACTURERS IN THE INVOICE TO VEHICLE OWNERS OR TO ANYBODY ELSE. THE CUSTOMER TAKES HIS OWN RESPONSIBILITY IF HE DOES NOT COMPLY WITH WHAT ABOVE.

	Code	OEM new	OEM old
LIGHT INDICATOR	60517	1358175	360248
<ul style="list-style-type: none"> ● Model ★ Application 			
<ul style="list-style-type: none"> ● 3 BUS ★ 			
<ul style="list-style-type: none"> ● 3 TRUCK ★ 			



INDICATOR STALK	61645	367326	347893
<ul style="list-style-type: none"> ● 3 BUS ★ 			



WIPER INDICATOR	65248	360247	
<ul style="list-style-type: none"> ● 3 BUS ★ 			
<ul style="list-style-type: none"> ● 3 TRUCK ★ 			



ALL THE COMPONENTS LISTED IN OUR CATALOGUE ARE NOT ORIGINAL, THOUGH PERFECTLY INTERCHANGEABLE. REFERENCE NUMBERS, EITHER ORIGINAL OR OF A DIFFERENT NATURE, ARE FOR INFORMATION PURPOSES ONLY. WHEN PLACING AN ORDER, PLEASE, ALWAYS USE COSIBO REFERENCE NUMBERS AND DO NOT MENTION THE ORIGINAL REFERENCE NUMBERS OF THE TRUCK MANUFACTURERS IN THE INVOICE TO VEHICLE OWNERS OR TO ANYBODY ELSE. THE CUSTOMER TAKES HIS OWN RESPONSIBILITY IF HE DOES NOT COMPLY WITH WHAT ABOVE.

	Code	OEM new	OEM old
DIRECTION INDICATOR	65249	1402448	
● Model			
★ Application			
● 4 BUS			
★ K/L/N 94			
● 4 TRUCK			
★ 94 - 114 - 124 - 144 - 164			



DIRECTION INDICATOR WITH CRUISE CONTROL	63809	1402449	
● 4 BUS			
★ K/L/N 94			
● 4 TRUCK			
★ 94 - 114 - 124 - 144 - 164			



WIPER INDICATOR	64184	1424970	1402450
● 4 BUS			
★ K/L/N 94			
● 4 TRUCK			
★ 94 - 114 - 124 - 144 - 164			



"This item may not be available on every market"

ALL THE COMPONENTS LISTED IN OUR CATALOGUE ARE NOT ORIGINAL, THOUGH PERFECTLY INTERCHANGEABLE. REFERENCE NUMBERS, EITHER ORIGINAL OR OF A DIFFERENT NATURE, ARE FOR INFORMATION PURPOSES ONLY. WHEN PLACING AN ORDER, PLEASE, ALWAYS USE COSIBO REFERENCE NUMBERS AND DO NOT MENTION THE ORIGINAL REFERENCE NUMBERS OF THE TRUCK MANUFACTURERS IN THE INVOICE TO VEHICLE OWNERS OR TO ANYBODY ELSE. THE CUSTOMER TAKES HIS OWN RESPONSIBILITY IF HE DOES NOT COMPLY WITH WHAT ABOVE.

	Code	OEM new	OEM old
RELAY	65250	363712	331881
<ul style="list-style-type: none"> ● Model ★ Application 			
<ul style="list-style-type: none"> ● 3 BUS ★ LHD/RHD 			
<ul style="list-style-type: none"> ● 3 TRUCK ★ LHD/RHD 			



RELAY	65278	1334196	289929 334470 365559
<ul style="list-style-type: none"> ● 3 BUS ★ 			
<ul style="list-style-type: none"> ● 3 TRUCK ★ 			



SWITCH	61865	353628	
<ul style="list-style-type: none"> ● 3 TRUCK ★ 			
<ul style="list-style-type: none"> ● 4 TRUCK ★ 94 - 114 - 124 - 144 - 164 			





SWITCH	62398	1353142	
<ul style="list-style-type: none"> ● 4 TRUCK ★ 94 - 114 - 124 - 144 - 164 - GA750R 			



ALL THE COMPONENTS LISTED IN OUR CATALOGUE ARE NOT ORIGINAL, THOUGH PERFECTLY INTERCHANGEABLE. REFERENCE NUMBERS, EITHER ORIGINAL OR OF A DIFFERENT NATURE, ARE FOR INFORMATION PURPOSES ONLY. WHEN PLACING AN ORDER, PLEASE, ALWAYS USE COSIBO REFERENCE NUMBERS AND DO NOT MENTION THE ORIGINAL REFERENCE NUMBERS OF THE TRUCK MANUFACTURERS IN THE INVOICE TO VEHICLE OWNERS OR TO ANYBODY ELSE. THE CUSTOMER TAKES HIS OWN RESPONSIBILITY IF HE DOES NOT COMPLY WITH WHAT ABOVE.

		Code	OEM new	OEM old
RELAY	● Model	63450	1318306	278263
	★ Application			
	● 3 TRUCK			
	★			
				
	● 4 TRUCK			
	★			

RELAY		63447	2077837	1431781 1391322 243460
	● 3 TRUCK			
	★	LHD/RHD - EDC - RHD EDC G880 G900 - ABS CG/CP/CR/CT13 - ABS CR CT13 EDC ASR - CP CR CT13 ABS - ABS/ASR - ABS CP CR CT19 - ABS CR CT19 EDC/ASR - CP CR CT19 ABS - ABS/ASR - GA750 - 850CP13/19		
	● 4 TRUCK			
	★	ALLISON GA750 750R - GA751 751R - GA851 851R - GA852 852R LHD/RHD - ADR - WEBASTO ADR - CR19 TOPLINE		
	● P-G-R-T TRUCK			
	★			
	● 3 BUS			
	★	ABS/ASR		
	● 4 BUS			
★	N94 UD 4X2 - 6X2/4			
● F-K-N BUS				
★	CK/CN - IKIB - P2 - K/N - CNUD P700			
				

RELAY		63465	1902698	1327013 1401788 1504270
	● 4 TRUCK			
	★			
	● 4 BUS			
				
	★			

ALL THE COMPONENTS LISTED IN OUR CATALOGUE ARE NOT ORIGINAL, THOUGH PERFECTLY INTERCHANGEABLE. REFERENCE NUMBERS, EITHER ORIGINAL OR OF A DIFFERENT NATURE, ARE FOR INFORMATION PURPOSES ONLY. WHEN PLACING AN ORDER, PLEASE, ALWAYS USE COSIBO REFERENCE NUMBERS AND DO NOT MENTION THE ORIGINAL REFERENCE NUMBERS OF THE TRUCK MANUFACTURERS IN THE INVOICE TO VEHICLE OWNERS OR TO ANYBODY ELSE. THE CUSTOMER TAKES HIS OWN RESPONSIBILITY IF HE DOES NOT COMPLY WITH WHAT ABOVE.

	Code	OEM new	OEM old
WIPER RELE'	63466	1902328	1335482 1523612 1741091
● Model			
★ Application			
● 4 TRUCK			
★			94 - 114 - 124 - 144 - 164
● 4 BUS			
★			



FLASHER RELAY	63467	1401789	1328548
● 4 TRUCK			
★			
● 4 BUS			
★			



SWITCH	64178	1475750	1387022
● 3 TRUCK			
★			LHD/RHD GR801 - GR/GRS/GRH900
● 4 TRUCK			
★			
● 3 BUS			
★			GR801
● 4 BUS			
★			



ALL THE COMPONENTS LISTED IN OUR CATALOGUE ARE NOT ORIGINAL, THOUGH PERFECTLY INTERCHANGEABLE. REFERENCE NUMBERS, EITHER ORIGINAL OR OF A DIFFERENT NATURE, ARE FOR INFORMATION PURPOSES ONLY. WHEN PLACING AN ORDER, PLEASE, ALWAYS USE COSIBO REFERENCE NUMBERS AND DO NOT MENTION THE ORIGINAL REFERENCE NUMBERS OF THE TRUCK MANUFACTURERS IN THE INVOICE TO VEHICLE OWNERS OR TO ANYBODY ELSE. THE CUSTOMER TAKES HIS OWN RESPONSIBILITY IF HE DOES NOT COMPLY WITH WHAT ABOVE.

		Code	OEM new	OEM old
RELAY	● Model	63446	1543731	1407909 1439172 303535
	★ Application			
	● 3 BUS			
	★			
	● 3 TRUCK			
	★			
	● 4 BUS			
	★			
	● 4 TRUCK			
	★	94 - 114 - 124.144 - 164		
	● F-K-N BUS			
	★	CK/CN CNUD P700		
● P-G-R-T TRUCK				
★				



CABLE CONNECTOR M27	63593	1378882	
● 3 BUS			
★			
● 4 BUS			
★			
● IND. MARINE ENGINE 4			
★			
● IND. MARINE ENGINE 5			
★			
● 3 TRUCK			
★			
● 4 TRUCK			
★			
● P-G-R-T TRUCK			
★	2 POLE B9		



ALL THE COMPONENTS LISTED IN OUR CATALOGUE ARE NOT ORIGINAL, THOUGH PERFECTLY INTERCHANGEABLE. REFERENCE NUMBERS, EITHER ORIGINAL OR OF A DIFFERENT NATURE, ARE FOR INFORMATION PURPOSES ONLY. WHEN PLACING AN ORDER, PLEASE, ALWAYS USE COSIBO REFERENCE NUMBERS AND DO NOT MENTION THE ORIGINAL REFERENCE NUMBERS OF THE TRUCK MANUFACTURERS IN THE INVOICE TO VEHICLE OWNERS OR TO ANYBODY ELSE. THE CUSTOMER TAKES HIS OWN RESPONSIBILITY IF HE DOES NOT COMPLY WITH WHAT ABOVE.

		Code	OEM new	OEM old
CABLE CONNECTOR M24	● Model	63594	1378883	1120398 1365170
	★ Application			
	● 3 BUS			
	★			
	● 4 BUS			
	★ ADR			
	● F-K-N BUS			
	★ 2 POLE			
	● IND. MARINE ENGINE 4			
	★			
	● IND. MARINE ENGINE 5			
	★ SG9 A280			
	● 3 TRUCK			
	★ ADR			
	● 4 TRUCK			
	★ ADR			
● P-G-R-T TRUCK				
★ 2 POLE				

		63598	355223	
CONNECTOR SET M24	● 3 BUS			
	★			
	● 4 BUS			
	★ ADR			
	● IND. MARINE ENGINE 4			
	★			
	● IND. MARINE ENGINE 5			
	★ SG9 A280			
	● 3 TRUCK			
	★ ADR			
	● 4 TRUCK			
	★ ADR			



ALL THE COMPONENTS LISTED IN OUR CATALOGUE ARE NOT ORIGINAL, THOUGH PERFECTLY INTERCHANGEABLE. REFERENCE NUMBERS, EITHER ORIGINAL OR OF A DIFFERENT NATURE, ARE FOR INFORMATION PURPOSES ONLY. WHEN PLACING AN ORDER, PLEASE, ALWAYS USE COSIBO REFERENCE NUMBERS AND DO NOT MENTION THE ORIGINAL REFERENCE NUMBERS OF THE TRUCK MANUFACTURERS IN THE INVOICE TO VEHICLE OWNERS OR TO ANYBODY ELSE. THE CUSTOMER TAKES HIS OWN RESPONSIBILITY IF HE DOES NOT COMPLY WITH WHAT ABOVE.

OIL SENSOR



	Code	OEM new	OEM old
● Model	63847	1452862	1393113 1488340
★ Application			
● 3 BUS			
★			
● IND. MARINE ENGINE 4			
★ DC9 51 A05 E			
● IND. MARINE ENGINE 5			
★ SG9 A280			
● 3 TRUCK			
★			
● 4 TRUCK			
★ DSC12 05 - EDC LHD/RHD			

PRESSURE SWITCH



	64177	1731130	
● 4 BUS			
★ K/L/N 4X2 6X2 8X2 6X2/2 6X2/4 LHD/RHD - DC19 19/20/21 PDE 4X2 6X2 6X2/4 8X2 6X2/4 LHD - L/N 6X2/2 LHD - L/N EDC 6X2/2 LHD - K/L/N EDC 4X2 6X2 6X2/4 8X2 LHD			

ALTERNATOR REGULATOR



	62249	1117253	1118188
● 3 BUS			
★ N1 28V 10/55A			
● 3 TRUCK			
★ N1 28V 10/55A			
● 4 BUS			
★ N1 28V 20/65A 1 POLE			
● 4 TRUCK			
★ N1 28V 20/65A 1 POLE			
● IND. MARINE ENGINE 4			
★ N1 28V 20/65A 1 POLE			

ALL THE COMPONENTS LISTED IN OUR CATALOGUE ARE NOT ORIGINAL, THOUGH PERFECTLY INTERCHANGEABLE. REFERENCE NUMBERS, EITHER ORIGINAL OR OF A DIFFERENT NATURE, ARE FOR INFORMATION PURPOSES ONLY. WHEN PLACING AN ORDER, PLEASE, ALWAYS USE COSIBO REFERENCE NUMBERS AND DO NOT MENTION THE ORIGINAL REFERENCE NUMBERS OF THE TRUCK MANUFACTURERS IN THE INVOICE TO VEHICLE OWNERS OR TO ANYBODY ELSE. THE CUSTOMER TAKES HIS OWN RESPONSIBILITY IF HE DOES NOT COMPLY WITH WHAT ABOVE.

	Code	OEM new	OEM old
STARTER MOTOR	64795	1796026	1447911 571467 579265
● Model			
★ Application			
● 4 BUS			
★ D12 EVB - D9 - D11 - D12			
● 4 TRUCK			
★ D9 - D11 - D12 - D9 D11 D12 EVB -			
● F-K-N BUS			
★ D9 - D11 - D12 - D13			
● IND.MARINE ENGINE 4			
★ DC12 50A/57A/60A - D12A - DC12A EMS -			
● IND.MARINE ENGINE 5			
★ DC9A EMS - SG9 A280 - DC09/13A			
● P-G-R-T TRUCK			
★ D9 - D11 - D12 - D13			



	64313	1424601	
STARTER MOTOR PINION			
● 4 BUS			
★			
● IND.MARINE ENGINE 4			
★			
● 4 TRUCK			
★			



	63051	316379	
SWITCH			
● 3 TRUCK			
★ TOPLINE			
● 4 TRUCK			
★ 94 - 114 - 124 - 144 - 164			



ALL THE COMPONENTS LISTED IN OUR CATALOGUE ARE NOT ORIGINAL, THOUGH PERFECTLY INTERCHANGEABLE. REFERENCE NUMBERS, EITHER ORIGINAL OR OF A DIFFERENT NATURE, ARE FOR INFORMATION PURPOSES ONLY. WHEN PLACING AN ORDER, PLEASE, ALWAYS USE COSIBO REFERENCE NUMBERS AND DO NOT MENTION THE ORIGINAL REFERENCE NUMBERS OF THE TRUCK MANUFACTURERS IN THE INVOICE TO VEHICLE OWNERS OR TO ANYBODY ELSE. THE CUSTOMER TAKES HIS OWN RESPONSIBILITY IF HE DOES NOT COMPLY WITH WHAT ABOVE.

	Code	OEM new	OEM old
SWITCH	65452	1541086	
<ul style="list-style-type: none"> ● Model ★ Application 			
<ul style="list-style-type: none"> ● 4 TRUCK ★ ADR GR/GRS890/900 + R - GR/GRS890/900 + R 			



CABLE HARNESS	65453	1424221	
<ul style="list-style-type: none"> ● 4 TRUCK ★ ADR GR/GRS890/900 + R - GR/GRS890/900 + R 			



CABLE HARNESS	65454	1549304	
<ul style="list-style-type: none"> ● 4 TRUCK ★ ADR GR/GRS890/900 + R - GR/GRS890/900 + R 			



ALL THE COMPONENTS LISTED IN OUR CATALOGUE ARE NOT ORIGINAL, THOUGH PERFECTLY INTERCHANGEABLE. REFERENCE NUMBERS, EITHER ORIGINAL OR OF A DIFFERENT NATURE, ARE FOR INFORMATION PURPOSES ONLY. WHEN PLACING AN ORDER, PLEASE, ALWAYS USE COSIBO REFERENCE NUMBERS AND DO NOT MENTION THE ORIGINAL REFERENCE NUMBERS OF THE TRUCK MANUFACTURERS IN THE INVOICE TO VEHICLE OWNERS OR TO ANYBODY ELSE. THE CUSTOMER TAKES HIS OWN RESPONSIBILITY IF HE DOES NOT COMPLY WITH WHAT ABOVE.

EBS SENSOR



	Code	OEM new	OEM old
● Model ★ Application	62554	1892056	1428454 1530702
● 4 TRUCK			
★			
● P-G-R-T TRUCK			
★			

EBS SENSOR



	Code	OEM new	OEM old
	62555	1892057	1530704
● 4 TRUCK			
★			
● P-G-R-T TRUCK			
★			

ABS SENSOR



	Code	OEM new	OEM old
	63878	1892047	1530690
● 4 TRUCK			
★ 94-114-124-144-164			
● P-G-R-T TRUCK			
★			

ALL THE COMPONENTS LISTED IN OUR CATALOGUE ARE NOT ORIGINAL, THOUGH PERFECTLY INTERCHANGEABLE. REFERENCE NUMBERS, EITHER ORIGINAL OR OF A DIFFERENT NATURE, ARE FOR INFORMATION PURPOSES ONLY. WHEN PLACING AN ORDER, PLEASE, ALWAYS USE COSIBO REFERENCE NUMBERS AND DO NOT MENTION THE ORIGINAL REFERENCE NUMBERS OF THE TRUCK MANUFACTURERS IN THE INVOICE TO VEHICLE OWNERS OR TO ANYBODY ELSE. THE CUSTOMER TAKES HIS OWN RESPONSIBILITY IF HE DOES NOT COMPLY WITH WHAT ABOVE.

ABS & EBS SENSOR



	Code	OEM new	OEM old
● Model	63879	1892051	1530696
★ Application			
● 3 TRUCK			
★ 93-113-143 ABS+ASR			
● 4 TRUCK			
★ ONLY ABS			
● P-G-R-T TRUCK			
★ ONLY EBS			

RETARDER SENSOR



	Code	OEM new	OEM old
	64228	1491408	1397851
● 3 BUS			
★ GR801			
● 3 TRUCK			
★ GR/GRS900R ABS - GR/GRS900R CAG - GR/GRS900R EDC - GR/GRS900R EDC+CAG			
● 4 BUS			
★ GR801R - G700 - GR801			
● 4 TRUCK			
★ ABS+EEB - ABS/EBS			

PRESSURE SENSOR



	Code	OEM new	OEM old
	64400	1862892	
● 4 BUS			
★ DC/DSC12 PDE - DC11 03/04/06 - DC9 PDE - DC9 19/20/21 PDE			
● 4 TRUCK			
★ D16 EDC - DC9 PDE - DC11 01/02/03/04/06 - DSC12 05 - DC12 01/02/03/09 - DT12 02/08			
● F-K-N BUS			
★ DT12 03/12 HPI EGR - DC12 10/13 HPI EGR - D11 D12 PDE - D9 PDE - D9 PDE EGR			
● IND MARINE ENGINE			
★ DC9A EMS - D12A/M EMS - DI12 49A 68M - DC12 57A 60A - DC16A			
● P-G-R-T TRUCK			
★ D9 D11 D12 PDE - D9 PDE EGR - D12 HPI - D12 HPI EGR - D16 PDE - DC12 15/18 HPI			

ALL THE COMPONENTS LISTED IN OUR CATALOGUE ARE NOT ORIGINAL, THOUGH PERFECTLY INTERCHANGEABLE. REFERENCE NUMBERS, EITHER ORIGINAL OR OF A DIFFERENT NATURE, ARE FOR INFORMATION PURPOSES ONLY. WHEN PLACING AN ORDER, PLEASE, ALWAYS USE COSIBO REFERENCE NUMBERS AND DO NOT MENTION THE ORIGINAL REFERENCE NUMBERS OF THE TRUCK MANUFACTURERS IN THE INVOICE TO VEHICLE OWNERS OR TO ANYBODY ELSE. THE CUSTOMER TAKES HIS OWN RESPONSIBILITY IF HE DOES NOT COMPLY WITH WHAT ABOVE.

SPEED SENSOR



	Code	OEM new	OEM old
● Model	64401	1471738	
★ Application			
● 4 TRUCK			
★	D16 EDC - DC11 01/02/03/04 EDC - DC11 01/02/03/04/06 - DSC12 05 PDE - DC12 01/02/09 PDE - DSC12 05 - DC12 01/02/09		
● IND.MARINE ENGINE			
★	D16A - D16M		
● P-G-R-T TRUCK			
★	D16 PDE		

SENSOR



	Code	OEM new	OEM old
	64414	1892068	1530703
● 4 TRUCK			
★	EBS 94-114-124-144-164		
● F-K-N BUS			
★	ABS / EBS		
● P-G-R-T TRUCK			
★	EBS		

SENSOR



	Code	OEM new	OEM old
	64418	1892054	1530700
● 4 TRUCK			
★	ABS - ADR/EDC/SLD		
● P-G-R-T TRUCK			
★	ABS/EBS		

ALL THE COMPONENTS LISTED IN OUR CATALOGUE ARE NOT ORIGINAL, THOUGH PERFECTLY INTERCHANGEABLE. REFERENCE NUMBERS, EITHER ORIGINAL OR OF A DIFFERENT NATURE, ARE FOR INFORMATION PURPOSES ONLY. WHEN PLACING AN ORDER, PLEASE, ALWAYS USE COSIBO REFERENCE NUMBERS AND DO NOT MENTION THE ORIGINAL REFERENCE NUMBERS OF THE TRUCK MANUFACTURERS IN THE INVOICE TO VEHICLE OWNERS OR TO ANYBODY ELSE. THE CUSTOMER TAKES HIS OWN RESPONSIBILITY IF HE DOES NOT COMPLY WITH WHAT ABOVE.

	Code	OEM new	OEM old
SENSOR	64419	1892049	1530693
<ul style="list-style-type: none"> ● Model ★ Application 			
<ul style="list-style-type: none"> ● 4 TRUCK ★ ABS - ADR/EDC/SLD 			
<ul style="list-style-type: none"> ● P-G-R-T TRUCK ★ ABS 			



CABLE HARNESS	64807	1420500	
<ul style="list-style-type: none"> ● 4 TRUCK ★ EBS 			



SENSOR	64808	1457303	
<ul style="list-style-type: none"> ● 4 BUS ★ DC/DSC12 PDE - DC11 03/04/06 - DC9 PDE - DC9 19/20/21 PDE 			
<ul style="list-style-type: none"> ● 4 TRUCK ★ 94-114-124-144-164 - DC9 PDE - DT12 02/08 LHD-RHD - DC12 03 LHD/RHD 			
<ul style="list-style-type: none"> ● F-K-N BUS ★ DT12 03/12 HPI EGR - DC12 10/13 HPI EGR - D11/12 PDE - D9 PDE - D9 PDE EGR - D9 EGR - D9 XPI EGR - D16 XPI EGR 			
<ul style="list-style-type: none"> ● IND MARINE ENGINE ★ DI12 68M - DC9A EMS - D12A/M EMS - DI12 49A - DC12 57A 60A - D12A EMS - DC09A XPI/PDE - DC13A XPI/PDE 			
<ul style="list-style-type: none"> ● P-G-R-T TRUCK ★ D9 D11 D12 PDE - D9 PDE EGR - D9 XPI EGR - D12 HPI - D12 HPI EGR - D13 XPI EGR - DC12 15/18 HPI 			



ALL THE COMPONENTS LISTED IN OUR CATALOGUE ARE NOT ORIGINAL, THOUGH PERFECTLY INTERCHANGEABLE. REFERENCE NUMBERS, EITHER ORIGINAL OR OF A DIFFERENT NATURE, ARE FOR INFORMATION PURPOSES ONLY. WHEN PLACING AN ORDER, PLEASE, ALWAYS USE COSIBO REFERENCE NUMBERS AND DO NOT MENTION THE ORIGINAL REFERENCE NUMBERS OF THE TRUCK MANUFACTURERS IN THE INVOICE TO VEHICLE OWNERS OR TO ANYBODY ELSE. THE CUSTOMER TAKES HIS OWN RESPONSIBILITY IF HE DOES NOT COMPLY WITH WHAT ABOVE.

	Code	OEM new	OEM old
SENSOR	64809	1457304	
<ul style="list-style-type: none"> ● Model ★ Application 			
<ul style="list-style-type: none"> ● 4 BUS ★ DC9 PDE - DC9 19/20/21 PDE 			
<ul style="list-style-type: none"> ● 4 TRUCK ★ 94-114-124-144-164 - DC9 PDE - DT12 02/08 LHD-RHD - DC12 03 LHD-RHD 			
<ul style="list-style-type: none"> ● F-K-N BUS ★ DT12 03/12 HPI EGR - DC12 10/13 HPI/EGR - D11/12 PCD - D9 PDE - D9 PDE/EGR - D9 EGR - D9 XPI EGR - D13 XPI EGR 			
<ul style="list-style-type: none"> ● IND.MARINE ENGINE ★ D12 68M - DC9 EMS - D12A EMS - DI12 49A - DC12 57A 60A - DC09A XPI/PDE - DC13A XPI/PDE 			



SENSOR	64810	1471743	
<ul style="list-style-type: none"> ● 4 TRUCK ★ D16 EDC - DC11 01/02/03/04/06 - DSC12 05 - DC12 01/02/09 			



SENSOR	64811	1471747	
<ul style="list-style-type: none"> ● 4 BUS ★ DC/DSC12 PDE - DC11 03/04/06 - DC11 03/04/06 EDC 			
<ul style="list-style-type: none"> ● 4 TRUCK ★ DC11 01/02/03/04 EDC - DSC12 05 PDE - DC12 01/02/09 PDE - DSC12 05 - DC12 01/02/09 			



ALL THE COMPONENTS LISTED IN OUR CATALOGUE ARE NOT ORIGINAL, THOUGH PERFECTLY INTERCHANGEABLE. REFERENCE NUMBERS, EITHER ORIGINAL OR OF A DIFFERENT NATURE, ARE FOR INFORMATION PURPOSES ONLY. WHEN PLACING AN ORDER, PLEASE, ALWAYS USE COSIBO REFERENCE NUMBERS AND DO NOT MENTION THE ORIGINAL REFERENCE NUMBERS OF THE TRUCK MANUFACTURERS IN THE INVOICE TO VEHICLE OWNERS OR TO ANYBODY ELSE. THE CUSTOMER TAKES HIS OWN RESPONSIBILITY IF HE DOES NOT COMPLY WITH WHAT ABOVE.

	Code	OEM new	OEM old
CABLE HARNESS	64812	1884529	1482003
<ul style="list-style-type: none"> ● Model ★ Application 			
<ul style="list-style-type: none"> ● P-G-R-T TRUCK ★ EBS 			



WHEEL SPEED SENSOR SET	64813	1892060	1530709 2765315
<ul style="list-style-type: none"> ● 3 TRUCK ★ ABS - ABS+ASR 			
<ul style="list-style-type: none"> ● 4 BUS ★ ABS 			



SENSOR	64814	1539313	
<ul style="list-style-type: none"> ● IND.MARINE ENGINE ★ D16A - D16M 			
<ul style="list-style-type: none"> ● P-G-R-T TRUCK ★ D16 PDE 			



AIR PRESSURE SENSOR	64815	1862891	1854601
<ul style="list-style-type: none"> ● F-K-N BUS ★ D9/D13 XPI EGR 			
<ul style="list-style-type: none"> ● IND.MARINE ENGINE ★ DC09A XPI - DC13A XPI 			
<ul style="list-style-type: none"> ● P-G-R-T TRUCK ★ D9 D13 XPI EGR - D16 XPI SCR 			



ALL THE COMPONENTS LISTED IN OUR CATALOGUE ARE NOT ORIGINAL, THOUGH PERFECTLY INTERCHANGEABLE. REFERENCE NUMBERS, EITHER ORIGINAL OR OF A DIFFERENT NATURE, ARE FOR INFORMATION PURPOSES ONLY. WHEN PLACING AN ORDER, PLEASE, ALWAYS USE COSIBO REFERENCE NUMBERS AND DO NOT MENTION THE ORIGINAL REFERENCE NUMBERS OF THE TRUCK MANUFACTURERS IN THE INVOICE TO VEHICLE OWNERS OR TO ANYBODY ELSE. THE CUSTOMER TAKES HIS OWN RESPONSIBILITY IF HE DOES NOT COMPLY WITH WHAT ABOVE.

FUEL COMBINED SENSOR



	Code	OEM new	OEM old
● Model	64816	1862895	1539110
★ Application			
● 4 TRUCK			
★ DT12 02/08 LHD-RHD - DC12 03 LHD-RHD			
● F-K-N BUS			
★ DT12 03/12 HPI EGR - DC12 10/13 HPI EGR			
● P-G-R-T TRUCK			
★ D12 HPI - D12 HPI EGR - DC12 15/18 HPI			

WHEEL SPEED SENSOR SET



	64817	1892048	1530792
● 4 BUS			
★ ABS			
● 4 TRUCK			
★ ABS - EDC ADR SLD			
● P-G-R-T TRUCK			
★ ABS			

WHEEL SPEED SENSOR SET



	64818	1892053	1530699
● 3 TRUCK			
★ GPRT 93-113-143 ABS+ASR			
● 4 BUS			
★ ABS			
● 4 TRUCK			
★ ABS - ADR EDC SLD			
● P-G-R-T TRUCK			
★ ABS			

ALL THE COMPONENTS LISTED IN OUR CATALOGUE ARE NOT ORIGINAL, THOUGH PERFECTLY INTERCHANGEABLE. REFERENCE NUMBERS, EITHER ORIGINAL OR OF A DIFFERENT NATURE, ARE FOR INFORMATION PURPOSES ONLY. WHEN PLACING AN ORDER, PLEASE, ALWAYS USE COSIBO REFERENCE NUMBERS AND DO NOT MENTION THE ORIGINAL REFERENCE NUMBERS OF THE TRUCK MANUFACTURERS IN THE INVOICE TO VEHICLE OWNERS OR TO ANYBODY ELSE. THE CUSTOMER TAKES HIS OWN RESPONSIBILITY IF HE DOES NOT COMPLY WITH WHAT ABOVE.

WHEEL SPEED SENSOR SET



	Code	OEM new	OEM old
● Model	64819	1892058	1530705
★ Application			
● 4 TRUCK			
★ EBS			
● F-K-N BUS			
★ EBS			
● P-G-R-T TRUCK			
★ EBS			

WHEEL SENSOR SET



	Code	OEM new	OEM old
	64820	1892062	
● P-G-R-T TRUCK			
★ EBS REAR RH			

SPEED SENSOR



	Code	OEM new	OEM old
	65504	1375689	
● IND.MARINE ENGINE			
★ D14			

ALL THE COMPONENTS LISTED IN OUR CATALOGUE ARE NOT ORIGINAL, THOUGH PERFECTLY INTERCHANGEABLE. REFERENCE NUMBERS, EITHER ORIGINAL OR OF A DIFFERENT NATURE, ARE FOR INFORMATION PURPOSES ONLY. WHEN PLACING AN ORDER, PLEASE, ALWAYS USE COSIBO REFERENCE NUMBERS AND DO NOT MENTION THE ORIGINAL REFERENCE NUMBERS OF THE TRUCK MANUFACTURERS IN THE INVOICE TO VEHICLE OWNERS OR TO ANYBODY ELSE. THE CUSTOMER TAKES HIS OWN RESPONSIBILITY IF HE DOES NOT COMPLY WITH WHAT ABOVE.

		Code	OEM new	OEM old
SENSOR	● Model	65479	1377930	
	★ Application			
	● 4 BUS			
	★ DC9 EDC			
	● 4 BUS			
	★ DC9 EDC			

EGR VALVE	64444	2021085	1744081 1856310
	● F-K-N BUS		
	★ DT12 03/12 - DC12 10/13 - HPI EGR - 150AaD9 - XPI EGR		
	● P-G-R-T TRUCK		
	★ DT12 EGR - D9 XPI EGR		

SENSOR	65519	1865315	1539106 1788498
	● 4 BUS		
	★ DC9 PDE - DC9 19/20/21 PDE		
	● 4 TRUCK		
	★ PDE		
	● F-K-N BUS		
	★ DT12 03/12 - DC12 10/13 - D9/D11/D12 PDE - D9 EGR		
	● IND.MARINE ENGINE 4		
	★ DC12 50A - D12 40A		
	● IND.MARINE ENGINE 5		
	★ DC9A EMS		
	● P-G-R-T TRUCK		
	★ D9/D11/D12 PDE - D12 HPI - D9/D12 EGR - D12 HPI - D9/D13 XPI EGR - DC12 15/18 HPI		

ALL THE COMPONENTS LISTED IN OUR CATALOGUE ARE NOT ORIGINAL, THOUGH PERFECTLY INTERCHANGEABLE. REFERENCE NUMBERS, EITHER ORIGINAL OR OF A DIFFERENT NATURE, ARE FOR INFORMATION PURPOSES ONLY. WHEN PLACING AN ORDER, PLEASE, ALWAYS USE COSIBO REFERENCE NUMBERS AND DO NOT MENTION THE ORIGINAL REFERENCE NUMBERS OF THE TRUCK MANUFACTURERS IN THE INVOICE TO VEHICLE OWNERS OR TO ANYBODY ELSE. THE CUSTOMER TAKES HIS OWN RESPONSIBILITY IF HE DOES NOT COMPLY WITH WHAT ABOVE.

		Code	OEM new	OEM old
SENSOR	● Model	64203	2149696	1787155 1862890
	★ Application			
				
● 4 BUS				
★ DC9 PDE - DC9 19/20/21 PDE - DC11 03/04/06 - DC/DSC12 PDE -				
● 4 TRUCK				
★ DC9 PDE - DC11 01/02/03/04 EDC - DC11 01/02/03/04/06 - DSC12 05 - DC12 01/02/09 PDE - DC12 01/02/03/09 - DT12 02/08 - D16 EDC				
● F-K-N BUS				
★ D9 PDE - D11/D12 PDE - DT12 03/12 - DC12 10/13				
● IND.MARINE ENGINE 4				
★ D12 A/M EMS - DC12 60A - D112 68M - D16 A/M				
● IND.MARINE ENGINE 5				
★ DC9 EMS - DC09A DC13A PDE				
● P-G-R-T TRUCK				
★ D9 - D11 - D12 - DC12 15/18 - D16				

		64240	1865317	1788333
TEMPERATURE SENSOR	● 4 BUS			
	★ DC/DSC12 PDE - DC11 03/04/06			
				
● 4 TRUCK				
★ DC9 PDE - DC11 01/02/03/04 EDC - DC11 01/02/03/04/06 - DSC12 05 - DC12 01/02/09 PDE - DT12 02/08 - DC12 03 - D16 EDC				
● IND.MARINE ENGINE 5				
★ D112 49A 68M - D12 A/M EMS - DC12 57A 60A - D16 A/M				
● P-G-R-T TRUCK				
★ D16 PDE				

ALL THE COMPONENTS LISTED IN OUR CATALOGUE ARE NOT ORIGINAL, THOUGH PERFECTLY INTERCHANGEABLE. REFERENCE NUMBERS, EITHER ORIGINAL OR OF A DIFFERENT NATURE, ARE FOR INFORMATION PURPOSES ONLY. WHEN PLACING AN ORDER, PLEASE, ALWAYS USE COSIBO REFERENCE NUMBERS AND DO NOT MENTION THE ORIGINAL REFERENCE NUMBERS OF THE TRUCK MANUFACTURERS IN THE INVOICE TO VEHICLE OWNERS OR TO ANYBODY ELSE. THE CUSTOMER TAKES HIS OWN RESPONSIBILITY IF HE DOES NOT COMPLY WITH WHAT ABOVE.

SENSOR



- Model
- ★ Application

Code	OEM new	OEM old
65458	2247379	2020691 1908536

- P-G-R-T TRUCK

- ★

ALL THE COMPONENTS LISTED IN OUR CATALOGUE ARE NOT ORIGINAL, THOUGH PERFECTLY INTERCHANGEABLE. REFERENCE NUMBERS, EITHER ORIGINAL OR OF A DIFFERENT NATURE, ARE FOR INFORMATION PURPOSES ONLY. WHEN PLACING AN ORDER, PLEASE, ALWAYS USE COSIBO REFERENCE NUMBERS AND DO NOT MENTION THE ORIGINAL REFERENCE NUMBERS OF THE TRUCK MANUFACTURERS IN THE INVOICE TO VEHICLE OWNERS OR TO ANYBODY ELSE. THE CUSTOMER TAKES HIS OWN RESPONSIBILITY IF HE DOES NOT COMPLY WITH WHAT ABOVE.

SOLENOID SWITCH



- | Code | OEM new | OEM old |
|-------------------------------------|---------|---------|
| 63440 | 1405979 | |
| ● Model | | |
| ★ Application | | |
| ● 4 BUS | | |
| ★ D11 - D12 | | |
| ● IND. MARINE ENGINE 4 | | |
| ★ D11 - D12 - DI12 49A | | |
| ● 4 TRUCK | | |
| ★ D11 - D12 - DSC11 - DS111 - OSC11 | | |

V-BELT



- | | | |
|-----------|-------|--------|
| ● 3 TRUCK | 60484 | 814210 |
| ★ DN/DS11 | | |
| ● 3 BUS | | |
| ★ | | |

V-BELT

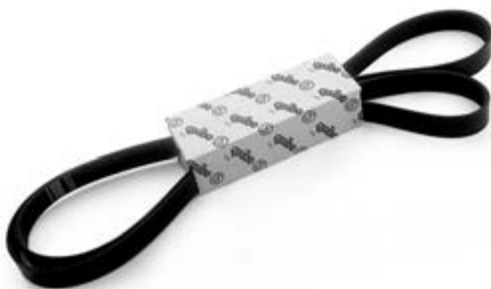

- | | | |
|-----------|-------|--------|
| ● 3 TRUCK | 61322 | 814209 |
| ★ DSC11 | | |

ALL THE COMPONENTS LISTED IN OUR CATALOGUE ARE NOT ORIGINAL, THOUGH PERFECTLY INTERCHANGEABLE. REFERENCE NUMBERS, EITHER ORIGINAL OR OF A DIFFERENT NATURE, ARE FOR INFORMATION PURPOSES ONLY. WHEN PLACING AN ORDER, PLEASE, ALWAYS USE COSIBO REFERENCE NUMBERS AND DO NOT MENTION THE ORIGINAL REFERENCE NUMBERS OF THE TRUCK MANUFACTURERS IN THE INVOICE TO VEHICLE OWNERS OR TO ANYBODY ELSE. THE CUSTOMER TAKES HIS OWN RESPONSIBILITY IF HE DOES NOT COMPLY WITH WHAT ABOVE.

BELT L=1225 mm

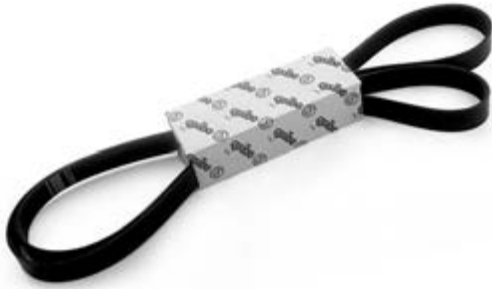

● Model
★ Application

Code

OEM new

OEM old

64187

814195



● 3 BUS

★

● IND. MARINE ENGINE 4

★ D14 A/M 65A

ALL THE COMPONENTS LISTED IN OUR CATALOGUE ARE NOT ORIGINAL, THOUGH PERFECTLY INTERCHANGEABLE. REFERENCE NUMBERS, EITHER ORIGINAL OR OF A DIFFERENT NATURE, ARE FOR INFORMATION PURPOSES ONLY. WHEN PLACING AN ORDER, PLEASE, ALWAYS USE COSIBO REFERENCE NUMBERS AND DO NOT MENTION THE ORIGINAL REFERENCE NUMBERS OF THE TRUCK MANUFACTURERS IN THE INVOICE TO VEHICLE OWNERS OR TO ANYBODY ELSE. THE CUSTOMER TAKES HIS OWN RESPONSIBILITY IF HE DOES NOT COMPLY WITH WHAT ABOVE.

		Code	OEM new	OEM old
SOLENOID VALVE	● Model	65191	2038653	1536304
	★ Application			1340231
		● 4 BUS		
		★		
		● 3 TRUCK		
		★ T113 LHD - R113 LHD - T143 LHD - R143 LHD GRH880		





SENSOR		65486	1781199	1448083 1541703
	● P-G-R-T TRUCK			
★				



VALVE BLOC		65484	2021087	1744086 1856312
	● F-K-N BUS			
★				
● P-G-R-T TRUCK				
★				



ALL THE COMPONENTS LISTED IN OUR CATALOGUE ARE NOT ORIGINAL, THOUGH PERFECTLY INTERCHANGEABLE. REFERENCE NUMBERS, EITHER ORIGINAL OR OF A DIFFERENT NATURE, ARE FOR INFORMATION PURPOSES ONLY. WHEN PLACING AN ORDER, PLEASE, ALWAYS USE COSIBO REFERENCE NUMBERS AND DO NOT MENTION THE ORIGINAL REFERENCE NUMBERS OF THE TRUCK MANUFACTURERS IN THE INVOICE TO VEHICLE OWNERS OR TO ANYBODY ELSE. THE CUSTOMER TAKES HIS OWN RESPONSIBILITY IF HE DOES NOT COMPLY WITH WHAT ABOVE.

	Code	OEM new	OEM old
<p>SWITCH</p> 	63677	1472739	1420005
<ul style="list-style-type: none"> ● Model ★ Application 			
<ul style="list-style-type: none"> ● 4 BUS ★ GR/GR801R WITH OPTICRUISE 			
<ul style="list-style-type: none"> ● 4 TRUCK ★ GRS890R - GRS/GRSH/GRS0900R - GRS920R - GT/GTD 800/900/901 - GR/GR801R 			
<p>SWITCH</p> 	63055	1303471	370710
<ul style="list-style-type: none"> ● 4 BUS ★ GRS900CAG - G700/701 			
<ul style="list-style-type: none"> ● 4 TRUCK ★ GR/GRS/GRH900 			
<p>SWITCH</p> 	64304	1472738	
<ul style="list-style-type: none"> ● 4 BUS ★ CH 3527596 DIFF. LOCK 			
<ul style="list-style-type: none"> ● 4 TRUCK ★ R780 8X8 - 4X2 4X4 6X2A/B/Z 6X2/4 6X6 6X4 8X2/6A/B 8X2A/Z 8X4A/B/Z 8X4/4A/B 			
<p>SWITCH</p> 	64421	1904343	1396644
<ul style="list-style-type: none"> ● 4 TRUCK ★ 			
<ul style="list-style-type: none"> ● P-G-R-T TRUCK ★ 			

ALL THE COMPONENTS LISTED IN OUR CATALOGUE ARE NOT ORIGINAL, THOUGH PERFECTLY INTERCHANGEABLE. REFERENCE NUMBERS, EITHER ORIGINAL OR OF A DIFFERENT NATURE, ARE FOR INFORMATION PURPOSES ONLY. WHEN PLACING AN ORDER, PLEASE, ALWAYS USE COSIBO REFERENCE NUMBERS AND DO NOT MENTION THE ORIGINAL REFERENCE NUMBERS OF THE TRUCK MANUFACTURERS IN THE INVOICE TO VEHICLE OWNERS OR TO ANYBODY ELSE. THE CUSTOMER TAKES HIS OWN RESPONSIBILITY IF HE DOES NOT COMPLY WITH WHAT ABOVE.

ACCELERATOR PEDAL COMPLETE



● Model

★ Application

Code

OEM new

OEM old

64119

64119

● 3 TRUCK

- ★ T93 LHD - R93 LHD - G93/P93 LHD/RHD - T113 LHD - P113 LHD/RHD - P113 HK6X4L EK6X4L - T143 LHD EDC - R143 LHD/RHD - P113 ML/HL 4X2 6X2 LHD GA850/GA850R - R143 LHD CR19 6X4 - P93 ML/MV/HL 4X2/6X2 LHD GA750/GA850R - R143 LHD 8X4 CR13 6X4 - R143 EK8X4L - P113 HK4X4L HK6X4L HK6X6L EK6X4L - R93 HK6X4L - R113 LHD/RHD - P113 HK4X4R HK6X6R MK8X4R - R143 LHD CR13/19 - P93 RHD EK330/340 - P93 RHD MV/ML/HL 4X2 6X2 GA776 - GA750/GA750R - R143 6X2/4 8X2 8X4 LHD - R143 4X2 6X2 6X4 LHD CR13/19 - R113 HK6X4L EK6X4L - R113 HK8X4L MK8X4L EK8X4L - P113 HK8X4L MK8X4L EK8X4L - R143 6X2/4 RHD - P113 DSC LHD - R143 LHD EDC - R113 DSC LHD - R113 EDC DTC - R113 8X2 8X4 LHD - R93 HK6X4L - P93 LHD/RHD GA776 - P93 ML/HL 4X2 6X2 LHD GA750

ACCELERATOR PEDAL



64132

390684

● 3 TRUCK

- ★ T93 LHD - R93 LHD - G93/P93 LHD/RHD - T113 LHD - P113 LHD/RHD - P113 HK6X4L EK6X4L - T143 LHD EDC - R143 LHD/RHD - P113 ML/HL 4X2 6X2 LHD GA850/GA850R - R143 LHD CR19 6X4 - P93 ML/MV/HL 4X2/6X2 LHD GA750/GA850R - R143 LHD 8X4 CR13 6X4 - R143 EK8X4L - P113 HK4X4L HK6X4L HK6X6L EK6X4L - R93 HK6X4L - R113 LHD/RHD - P113 HK4X4R HK6X6R MK8X4R - R143 LHD CR13/19 - P93 RHD EK330/340 - P93 RHD MV/ML/HL 4X2 6X2 GA776 - GA750/GA750R - R143 6X2/4 8X2 8X4 LHD - R143 4X2 6X2 6X4 LHD CR13/19 - R113 HK6X4L EK6X4L - R113 HK8X4L MK8X4L EK8X4L - P113 HK8X4L MK8X4L EK8X4L - R143 6X2/4 RHD - P113 DSC LHD - R143 LHD EDC - R113 DSC LHD - R113 EDC DTC - R113 8X2 8X4 LHD - R93 HK6X4L - P93 LHD/RHD GA776 - P93 ML/HL 4X2 6X2 LHD GA750

ACCELERATOR PEDAL BUSHING



60196

289445

● 3 TRUCK

★

● 3 BUS

★

● 4 BUS

- ★ F94H LHD/RHD - K114/124

ACCELERATOR CABLE



- Model
- ★ Application

Code	OEM new	OEM old
62386	1105970	

- **3 TRUCK**
- ★ R113

BUSHING



	64182	813245	
● 3 BUS			
★			
● 3 TRUCK			
★ G/P/T 93 - P/T 113 - R/T 143			
● 4 BUS			
★ F94 H			
● 4 TRUCK			
★ P/R DSC11 74/75/79 - T114 - P OSC11 G03 - P94 N FRONTLINE - P/R94			

ALL THE COMPONENTS LISTED IN OUR CATALOGUE ARE NOT ORIGINAL, THOUGH PERFECTLY INTERCHANGEABLE. REFERENCE NUMBERS, EITHER ORIGINAL OR OF A DIFFERENT NATURE, ARE FOR INFORMATION PURPOSES ONLY. WHEN PLACING AN ORDER, PLEASE, ALWAYS USE COSIBO REFERENCE NUMBERS AND DO NOT MENTION THE ORIGINAL REFERENCE NUMBERS OF THE TRUCK MANUFACTURERS IN THE INVOICE TO VEHICLE OWNERS OR TO ANYBODY ELSE. THE CUSTOMER TAKES HIS OWN RESPONSIBILITY IF HE DOES NOT COMPLY WITH WHAT ABOVE.

	Code	OEM new	OEM old
CLAMP D.6	64082	813933	
<ul style="list-style-type: none"> ● Model ★ Application 			
<ul style="list-style-type: none"> ● 3 TRUCK ★ 			
<ul style="list-style-type: none"> ● 4 TRUCK ★ 			
<ul style="list-style-type: none"> ● P-G-R-T TRUCK ★ 			
<ul style="list-style-type: none"> ● 3 BUS ★ 			
<ul style="list-style-type: none"> ● IND. MARINE ENGINE 4 ★ 			



CLAMP D.10	64083	813935	
<ul style="list-style-type: none"> ● 3 BUS ★ 			



CLAMP D.16	64084	813937	
<ul style="list-style-type: none"> ● 3 TRUCK ★ 			
<ul style="list-style-type: none"> ● 4 TRUCK ★ 			
<ul style="list-style-type: none"> ● P-G-R-T TRUCK ★ 			
<ul style="list-style-type: none"> ● 3 BUS ★ 			
<ul style="list-style-type: none"> ● 4 BUS ★ 			
<ul style="list-style-type: none"> ● IND. MARINE ENGINE 4 ★ 			



ALL THE COMPONENTS LISTED IN OUR CATALOGUE ARE NOT ORIGINAL, THOUGH PERFECTLY INTERCHANGEABLE. REFERENCE NUMBERS, EITHER ORIGINAL OR OF A DIFFERENT NATURE, ARE FOR INFORMATION PURPOSES ONLY. WHEN PLACING AN ORDER, PLEASE, ALWAYS USE COSIBO REFERENCE NUMBERS AND DO NOT MENTION THE ORIGINAL REFERENCE NUMBERS OF THE TRUCK MANUFACTURERS IN THE INVOICE TO VEHICLE OWNERS OR TO ANYBODY ELSE. THE CUSTOMER TAKES HIS OWN RESPONSIBILITY IF HE DOES NOT COMPLY WITH WHAT ABOVE.

	Code	OEM new	OEM old
CLAMP D.20	64085	813939	
	<ul style="list-style-type: none"> ● Model ★ Application 		
	<ul style="list-style-type: none"> ● 3 TRUCK ★ 		
	<ul style="list-style-type: none"> ● P-G-R-T TRUCK ★ 		
	<ul style="list-style-type: none"> ● 4 BUS ★ 		
	<ul style="list-style-type: none"> ● IND. MARINE ENGINE 4 ★ 		
	<ul style="list-style-type: none"> ● F-K-N BUS ★ 		

CLAMP D.25	64086	813941	
	<ul style="list-style-type: none"> ● 3 TRUCK ★ 		
	<ul style="list-style-type: none"> ● P-G-R-T TRUCK ★ 		
	<ul style="list-style-type: none"> ● 3 BUS ★ 		

CLAMP D.5	64089	813932	
	<ul style="list-style-type: none"> ● 3 TRUCK ★ 		



ALL THE COMPONENTS LISTED IN OUR CATALOGUE ARE NOT ORIGINAL, THOUGH PERFECTLY INTERCHANGEABLE. REFERENCE NUMBERS, EITHER ORIGINAL OR OF A DIFFERENT NATURE, ARE FOR INFORMATION PURPOSES ONLY. WHEN PLACING AN ORDER, PLEASE, ALWAYS USE COSIBO REFERENCE NUMBERS AND DO NOT MENTION THE ORIGINAL REFERENCE NUMBERS OF THE TRUCK MANUFACTURERS IN THE INVOICE TO VEHICLE OWNERS OR TO ANYBODY ELSE. THE CUSTOMER TAKES HIS OWN RESPONSIBILITY IF HE DOES NOT COMPLY WITH WHAT ABOVE.

	Code	OEM new	OEM old
CLAMP D.8	64090	813934	
 <ul style="list-style-type: none"> ● Model ★ Application 			
<ul style="list-style-type: none"> ● 3 TRUCK ★ 			
<ul style="list-style-type: none"> ● 4 BUS ★ 			

CLAMP D.13	64091	813936	
 <ul style="list-style-type: none"> ● Model ★ Application 			
<ul style="list-style-type: none"> ● 3 TRUCK ★ 			
<ul style="list-style-type: none"> ● 4 TRUCK ★ 			
<ul style="list-style-type: none"> ● 3 BUS ★ 			
<ul style="list-style-type: none"> ● IND. MARINE ENGINE 4 ★ 			

CLAMP D.18	64092	813938	
 <ul style="list-style-type: none"> ● Model ★ Application 			
<ul style="list-style-type: none"> ● 4 TRUCK ★ 			
<ul style="list-style-type: none"> ● 3 BUS ★ 			
<ul style="list-style-type: none"> ● IND. MARINE ENGINE 4 ★ 			

ALL THE COMPONENTS LISTED IN OUR CATALOGUE ARE NOT ORIGINAL, THOUGH PERFECTLY INTERCHANGEABLE. REFERENCE NUMBERS, EITHER ORIGINAL OR OF A DIFFERENT NATURE, ARE FOR INFORMATION PURPOSES ONLY. WHEN PLACING AN ORDER, PLEASE, ALWAYS USE COSIBO REFERENCE NUMBERS AND DO NOT MENTION THE ORIGINAL REFERENCE NUMBERS OF THE TRUCK MANUFACTURERS IN THE INVOICE TO VEHICLE OWNERS OR TO ANYBODY ELSE. THE CUSTOMER TAKES HIS OWN RESPONSIBILITY IF HE DOES NOT COMPLY WITH WHAT ABOVE.

	Code	OEM new	OEM old
<p>CLAMP D.22</p> 	64093	813940	
<ul style="list-style-type: none"> ● Model ★ Application 			
<ul style="list-style-type: none"> ● 3 TRUCK ★ 			
<ul style="list-style-type: none"> ● 4 TRUCK ★ 			
<ul style="list-style-type: none"> ● 4 BUS ★ 			
<ul style="list-style-type: none"> ● F-K-N BUS ★ 			
<p>CLAMP D.45</p> 	64094	813942	
<ul style="list-style-type: none"> ● 3 TRUCK ★ 			
<ul style="list-style-type: none"> ● 3 BUS ★ 			
<p>CLAMP D.28</p> 	64095	804578	
<ul style="list-style-type: none"> ● 3 TRUCK ★ 			
<ul style="list-style-type: none"> ● P-G-R-T TRUCK ★ 			
<ul style="list-style-type: none"> ● 4 BUS ★ 			
<ul style="list-style-type: none"> ● IND. MARINE ENGINE 4 ★ 			
<ul style="list-style-type: none"> ● F-K-N BUS ★ 			

ALL THE COMPONENTS LISTED IN OUR CATALOGUE ARE NOT ORIGINAL, THOUGH PERFECTLY INTERCHANGEABLE. REFERENCE NUMBERS, EITHER ORIGINAL OR OF A DIFFERENT NATURE, ARE FOR INFORMATION PURPOSES ONLY. WHEN PLACING AN ORDER, PLEASE, ALWAYS USE COSIBO REFERENCE NUMBERS AND DO NOT MENTION THE ORIGINAL REFERENCE NUMBERS OF THE TRUCK MANUFACTURERS IN THE INVOICE TO VEHICLE OWNERS OR TO ANYBODY ELSE. THE CUSTOMER TAKES HIS OWN RESPONSIBILITY IF HE DOES NOT COMPLY WITH WHAT ABOVE.

	Code	OEM new	OEM old
CLAMP D.32	64100	804583	
<ul style="list-style-type: none"> ● Model ★ Application 			
<ul style="list-style-type: none"> ● 3 TRUCK ★ 			
<ul style="list-style-type: none"> ● 3 BUS ★ 			
<ul style="list-style-type: none"> ● 4 BUS ★ 			
<ul style="list-style-type: none"> ● IND. MARINE ENGINE 4 ★ 			



CLAMP D.38	64101	804591	
<ul style="list-style-type: none"> ● 3 BUS ★ 			



RUBBER BUSHING	64112	1350440	
<ul style="list-style-type: none"> ● 4 TRUCK ★ 			
<ul style="list-style-type: none"> ● P-G-R-T TRUCK ★ 			



RUBBER BUSHING	64113	1350441	
<ul style="list-style-type: none"> ● 4 TRUCK ★ 			
<ul style="list-style-type: none"> ● P-G-R-T TRUCK ★ 			



ALL THE COMPONENTS LISTED IN OUR CATALOGUE ARE NOT ORIGINAL, THOUGH PERFECTLY INTERCHANGEABLE. REFERENCE NUMBERS, EITHER ORIGINAL OR OF A DIFFERENT NATURE, ARE FOR INFORMATION PURPOSES ONLY. WHEN PLACING AN ORDER, PLEASE, ALWAYS USE COSIBO REFERENCE NUMBERS AND DO NOT MENTION THE ORIGINAL REFERENCE NUMBERS OF THE TRUCK MANUFACTURERS IN THE INVOICE TO VEHICLE OWNERS OR TO ANYBODY ELSE. THE CUSTOMER TAKES HIS OWN RESPONSIBILITY IF HE DOES NOT COMPLY WITH WHAT ABOVE.

STARTER CABLE



	Code	OEM new	OEM old
● Model	60416	250318	
★ Application			
● 3 TRUCK			
★ P/R 113 LHD/RHD - P/R 113 6X2/4 RHD			

STOP CABLE



	Code	OEM new	OEM old
	60418	1343156	1343155 365161 365184
● 3 TRUCK			
★ G/P/R 93 - R143 - R143 6X2/4 RHD			

ACCELERATOR CABLE



	Code	OEM new	OEM old
	60420	1105971	1112015
● 3 TRUCK			
★ R143 LHD 8X4 CR13 6X4 - R143 4X2 6X2 6X4 LHD CR13/19 - R143 6X2/4 8X2 8X4 LHD			

ALL THE COMPONENTS LISTED IN OUR CATALOGUE ARE NOT ORIGINAL, THOUGH PERFECTLY INTERCHANGEABLE. REFERENCE NUMBERS, EITHER ORIGINAL OR OF A DIFFERENT NATURE, ARE FOR INFORMATION PURPOSES ONLY. WHEN PLACING AN ORDER, PLEASE, ALWAYS USE COSIBO REFERENCE NUMBERS AND DO NOT MENTION THE ORIGINAL REFERENCE NUMBERS OF THE TRUCK MANUFACTURERS IN THE INVOICE TO VEHICLE OWNERS OR TO ANYBODY ELSE. THE CUSTOMER TAKES HIS OWN RESPONSIBILITY IF HE DOES NOT COMPLY WITH WHAT ABOVE.

STOP CABLE



- Model
- ★ Application

Code

OEM new

OEM old

63930

365162

1331139
312354
365160

- **3 BUS**

- ★ LHD/RHD

- **3 TRUCK**

- ★ LHD - CAG G770 GR871/880 GS771/772 GRS900 - P/R113 6X2/4 RHD

Cross reference COSIBO - SCANIA

COSIBO	Replacing	Page	COSIBO	Replacing	Page	COSIBO	Replacing	Page	COSIBO	Replacing	Page
60002	373472	A.3.1	60109	393151	A.2.1	60249	338706	C.4.2	60362	551370	A.5.1
60002	257375	A.3.1	60109	306993	A.2.1	60252	362385	L.2.14	60367	1869988	A.16.5
60002	346143	A.3.1	60111	1369981	A.7.15	60255	470272	M.2.2	60367	1387549	A.16.5
60003	1403587	A.3.1	60111	1318091	A.7.15	60279	1539231	G.2.2	60367	1526087	A.16.5
60003	1313459	A.3.1	60111	301473	A.7.15	60279	1374305	G.2.2	60367	1801775	A.16.5
60003	170274	A.3.1	60112	154621	A.7.16	60279	1414072	G.2.2	60375	1413047	C.2.3
60003	367569	A.3.1	60113	225931	A.7.17	60279	273020	G.2.2	60375	303470	C.2.3
60005	159496	G.2.7	60114	225353	A.7.17	60299	193136	G.2.3	60391	263161	A.7.19
60010	352211	A.1.1	60115	225354	A.7.18	60299	193137	G.2.3	60398	40607	A.33.12
60010	294674	A.1.1	60116	238777	A.7.18	60301	264310	G.2.3	60405	332738	A.18.1
60014	1397521	A.1.2	60126	173171	A.14.1	60301	209152	G.2.3	60405	137207	A.18.1
60014	1100997	A.1.2	60127	323790	A.10.4	60302	264311	G.2.3	60405	332738	C.9.1
60014	1360834	A.1.2	60127	362128	A.10.4	60302	209153	G.2.3	60405	137207	C.9.1
60014	232018	A.1.2	60127	323790	H.5.1	60304	1488083	C.2.1	60407	242299	A.7.19
60014	352347	A.1.2	60127	362128	H.5.1	60304	1334037	C.2.1	60408	242297	A.7.19
60015	315060	C.3.3	60129	1800538	A.23.5	60304	1423566	C.2.1	60409	242298	A.7.19
60016	319110	A.7.16	60129	1389042	A.23.5	60319	258410	A.29.3	60413	1112542	H.4.1
60016	139110	A.7.16	60129	1530980	A.23.5	60320	258411	A.29.3	60413	363808	H.4.1
60017	1523410	A.1.5	60140	309885	A.18.1	60321	258412	A.29.3	60415	1116635	A.7.7
60017	269715	A.1.5	60140	138849	A.18.1	60322	168778	A.29.3	60415	1103422	A.7.7
60017	300957	A.1.5	60140	238999	A.18.1	60323	168781	A.29.4	60416	250318	O.2.6
60018	1521209	A.1.6	60141	364833	A.18.1	60324	168782	A.29.4	60418	1343156	O.2.6
60018	1398624	A.1.6	60141	364833	A.18.1	60325	258686	A.29.5	60418	1343155	O.2.6
60018	223635	A.1.6	60142	146526	C.9.1	60326	258687	A.29.6	60418	365161	O.2.6
60018	269716	A.1.6	60155	1522377	B.1.1	60327	258688	A.29.6	60418	365184	O.2.6
60018	300958	A.1.6	60155	1393332	B.1.1	60328	258689	A.29.6	60420	1105971	O.2.6
60018	393264	A.1.6	60155	1434649	B.1.1	60329	258690	A.29.6	60420	1112015	O.2.6
60023	1412265	N.1.11	60155	1455730	B.1.1	60330	258691	A.29.7	60426	550453	B.1.5
60023	1327274	N.1.11	60196	289445	O.1.1	60331	169316	A.29.4	60426	550421	B.1.5
60023	1412265	N.3.2	60206	1388678	A.8.1	60332	169317	A.29.4	60426	550422	B.1.5
60023	1327274	N.3.2	60206	371507	A.8.1	60333	169318	A.29.4	60426	550437	B.1.5
60047	284843	C.4.2	60237	1879537	D.2.1	60334	169319	A.29.5	60429	1340615	A.29.2
60058	385998	A.13.1	60237	1111745	D.2.1	60335	169320	A.29.5	60432	1428892	A.33.6
60058	235178	A.13.1	60237	1422433	D.2.1	60336	169321	A.29.5	60432	1364355	A.33.6
60058	277273	A.13.1	60237	1765828	D.2.1	60340	1357600	I.54.1	60434	2002705	C.1.1
60059	385997	A.13.1	60237	337058	D.2.1	60341	1357599	I.54.1	60434	1768402	C.1.1
60059	235177	A.13.1	60238	1797424	D.2.1	60343	1338128	A.33.1	60434	1301696	C.1.1
60059	277272	A.13.1	60238	1541070	D.2.1	60343	1338071	A.33.1	60434	2002705	F.2.1
60060	1510490	A.26.1	60238	1766466	D.2.1	60346	1361983	A.33.3	60434	1768402	F.2.1
60060	1486098	A.26.1	60238	337059	D.2.1	60347	357402	A.33.3	60434	1301696	F.2.1
60060	570957	A.26.1	60238	365901	D.2.1	60359	1894478	A.21.20	60435	1496288	A.18.2
60073	250996	A.13.22	60239	1797425	D.2.2	60359	1421090	A.21.20	60435	1423011	A.18.2
60073	279052	A.13.22	60239	1541071	D.2.2	60359	1492421	A.21.20	60435	1336885	A.18.2
60101	1471237	A.2.3	60239	1750308	D.2.2	60359	1511775	A.21.20	60435/2	1778532	A.18.2
60101	139625	A.2.3	60239	1766467	D.2.2	60359	1765735	A.21.20	60435/3	1778530	A.18.3
60102	353843	A.2.5	60239	337060	D.2.2	60359	1855164	A.21.20	60436	1438902	H.4.1
60102	131120	A.2.5	60239	366437	D.2.2	60361	1804064	J.1.9	60438	1348117	J.9.2
60102	271488	A.2.5	60239	390225	D.2.2	60361	1768694	J.1.9	60439	60439	A.33.8

ALL THE COMPONENTS LISTED IN OUR CATALOGUE ARE NOT ORIGINAL, THOUGH PERFECTLY INTERCHANGEABLE. REFERENCE NUMBERS, EITHER ORIGINAL OR OF A DIFFERENT NATURE, ARE FOR INFORMATION PURPOSES ONLY. WHEN PLACING AN ORDER, PLEASE, ALWAYS USE COSIBO REFERENCE NUMBERS AND DO NOT MENTION THE ORIGINAL REFERENCE NUMBERS OF THE TRUCK MANUFACTURERS IN THE INVOICE TO VEHICLE OWNERS OR TO ANYBODY ELSE. THE CUSTOMER TAKES HIS OWN RESPONSIBILITY IF HE DOES NOT COMPLY WITH WHAT ABOVE.

Cross reference COSIBO - SCANIA

COSIBO	Replacing	Page	COSIBO	Replacing	Page	COSIBO	Replacing	Page	COSIBO	Replacing	Page
60455	2059778	A.14.14	60522	1358793	M.2.5	60629	342988	A.25.1	60665	1105075	A.29.18
60455	1117285	A.14.14	60522	283784	M.2.5	60629	378396	A.25.1	60665	351311	A.29.18
60479	1363634	A.21.5	60522	395010	M.2.5	60630	1372444	A.30.1	60666	1105076	A.29.19
60481	1923654	J.8.14	60532	391496	M.1.1	60631	1913503	J.5.6	60666	351313	A.29.19
60481	1349805	J.8.14	60535	154261	H.40.7	60631	1420197	J.5.6	60667	1105077	A.29.19
60481/1	1349805/1	J.8.14	60536	154262	H.40.5	60631	1379952	J.5.6	60667	351314	A.29.19
60482	1394544	J.8.3	60538	182930	H.40.8	60631/1	1420197/1	J.5.7	60668	1105078	A.29.19
60482/T	1377562	J.8.7	60539	141164	H.40.8	60632	1763776	A.29.1	60668	351315	A.29.19
60484	814210	A.23.5	60540	141163	H.40.6	60632	1411894	A.29.1	60669	381918	A.29.19
60484	814210	N.31.1	60543	804782	H.40.9	60633	1508533	A.26.1	60670	381919	A.29.19
60488	1349810	J.8.14	60546	123102	H.40.9	60633	1353072	A.26.1	60671	381920	A.29.20
60490	1385170	J.8.7	60547	289336	H.12.4	60633	570955	A.26.1	60672	381921	A.29.20
60492	1380819	N.3.3	60547/1	134494	H.12.5	60634	1508534	A.26.2	60673	381922	A.29.20
60496	297568	N.3.1	60549	180064	H.40.9	60634	1365841	A.26.2	60674	381923	A.29.20
60500	1504609	N.3.3	60554	283642	L.2.15	60634	570956	A.26.2	60675	381924	A.29.20
60500	1387878	N.3.3	60556	1387983	A.33.7	60635	197800	A.5.4	60676	381925	A.29.21
60500	1436868	N.3.3	60561	258459	A.8.1	60635	392661	A.5.4	60677	365485	A.29.14
60501	1504608	N.3.3	60564	357363	A.16.1	60635	197800	C.8.4	60678	365486	A.29.15
60501	1387877	N.3.3	60565	1384552	A.16.1	60635	392661	C.8.4	60679	365487	A.29.15
60501	1436867	N.3.3	60565	393820	A.16.1	60635	197800	F.2.5	60680	365489	A.29.15
60505	550195	A.17.1	60566	139616	A.13.2	60635	392661	F.2.5	60681	365490	A.29.16
60506	1382113	A.17.1	60567	1388682	A.10.1	60636	332119	A.14.12	60682	365491	A.29.16
60506	1382110	A.17.1	60567	371487	A.10.1	60636	392663	A.14.12	60683	305286	A.29.7
60506	550196	A.17.1	60569	1459004	A.13.7	60636	332119	H.14.1	60684	305287	A.29.7
60511	1385410	N.2.1	60569	371505	A.13.7	60636	392663	H.14.1	60685	305288	A.29.7
60512	1387155	N.2.1	60570	551438	A.13.7	60636	332119	J.6.1	60686	305289	A.29.7
60517	1358175	N.30.1	60573	551456	A.4.1	60636	392663	J.6.1	60687	320813	A.29.8
60517	360248	N.30.1	60573	551513	A.4.1	60636	332119	M.5.2	60688	320814	A.29.8
60521	1738380	E.2.3	60575	551516	A.5.1	60636	392663	M.5.2	60689	348293	A.29.8
60521	1358792	E.2.3	60575	551457	A.5.1	60638	561408	A.27.15	60690	348294	A.29.8
60521	283783	E.2.3	60575	551459	A.5.1	60653	308604	A.21.7	60692	263911	A.29.8
60521	395009	E.2.3	60576	551470	A.5.1	60654	273793	A.21.8	60693	263912	A.29.9
60521	1738380	F.5.1	60580	306902	L.2.9	60657	1105079	A.29.16	60694	271147	A.29.9
60521	1358792	F.5.1	60584	1869993	A.16.5	60657	351301	A.29.16	60695	271148	A.29.9
60521	283783	F.5.1	60584	1421022	A.16.5	60658	1105080	A.29.17	60696	308385	A.29.9
60521	395009	F.5.1	60587	551469	A.4.1	60658	351302	A.29.17	60696	263915	A.29.9
60521	1738380	M.2.4	60587	550214	A.4.1	60659	1105081	A.29.17	60697	308386	A.29.9
60521	1358792	M.2.4	60589	1388681	A.11.1	60659	351303	A.29.17	60697	263916	A.29.9
60521	283783	M.2.4	60589	131180	A.11.1	60660	1105082	A.29.17	60698	263917	A.29.10
60521	395009	M.2.4	60589	287554	A.11.1	60660	351305	A.29.17	60699	263918	A.29.10
60522	1358793	E.2.3	60589	374742	A.11.1	60661	1105083	A.29.17	60700	369291	A.29.13
60522	283784	E.2.3	60589	385022	A.11.1	60661	351306	A.29.17	60701	369292	A.29.13
60522	395010	E.2.3	60591	1891445	A.2.3	60662	1105084	A.29.18	60702	369293	A.29.13
60522	1358793	F.5.1	60591	1465410	A.2.3	60662	351307	A.29.18	60703	369295	A.29.14
60522	283784	F.5.1	60591	1487567	A.2.3	60663	1105073	A.29.18	60704	369296	A.29.14
60522	395010	F.5.1	60591	1527914	A.2.3	60663	351309	A.29.18	60705	369297	A.29.14
			60591	170069	A.2.3	60664	1105074	A.29.18	60706	312217	A.29.11
			60597	306278	B.1.8	60664	351310	A.29.18	60707	312218	A.29.12

ALL THE COMPONENTS LISTED IN OUR CATALOGUE ARE NOT ORIGINAL, THOUGH PERFECTLY INTERCHANGEABLE. REFERENCE NUMBERS, EITHER ORIGINAL OR OF A DIFFERENT NATURE, ARE FOR INFORMATION PURPOSES ONLY. WHEN PLACING AN ORDER, PLEASE, ALWAYS USE COSIBO REFERENCE NUMBERS AND DO NOT MENTION THE ORIGINAL REFERENCE NUMBERS OF THE TRUCK MANUFACTURERS IN THE INVOICE TO VEHICLE OWNERS OR TO ANYBODY ELSE. THE CUSTOMER TAKES HIS OWN RESPONSIBILITY IF HE DOES NOT COMPLY WITH WHAT ABOVE.

Cross reference COSIBO - SCANIA

COSIBO	Replacing	Page	COSIBO	Replacing	Page	COSIBO	Replacing	Page	COSIBO	Replacing	Page
60708	312219	A.29.12	60836	1525988	C.4.2	60915	1388823	L.2.4	60986	1749034	G.2.16
60709	312221	A.29.12	60836	387877	C.4.2	60915	265768	L.2.4	60986	1365510	G.2.16
60710	312222	A.29.12	60836	1525988	D.1.3	60915	302768	L.2.4	60986	243956	G.2.16
60711	312223	A.29.13	60836	387877	D.1.3	60916	128680	L.2.16	60986	318690	G.2.16
60712	322693	A.29.10	60836	1525988	E.2.6	60917	135036	L.2.17	60993	1409890	G.2.10
60713	322694	A.29.10	60836	387877	E.2.6	60918	182929	L.2.18	60993	1313719	G.2.10
60714	322695	A.29.10	60836	1525988	F.2.3	60919	182931	L.2.19	60993	33352	G.2.10
60715	322697	A.29.11	60836	387877	F.2.3	60920	355148	L.2.18	60994	1765061	G.2.11
60716	322698	A.29.11	60836	1525988	H.6.10	60920	202333	L.2.18	60994	120310	G.2.11
60717	322699	A.29.11	60836	387877	H.6.10	60921	135698	L.2.18	60998	1109871	A.22.9
60718/1	371781	A.28.3	60838	550730	E.1.1	60922	303520	J.5.6	60998	170226	A.22.9
60718/1	319789	A.28.3	60838	550729	E.1.1	60955	154259	H.40.6	60998	310953	A.22.9
60720	392204	A.31.1	60845	550722	E.1.1	60957	1302857	H.13.14	60999	170761	A.22.9
60720	280862	A.31.1	60849	550731	E.1.1	60957	141168	H.13.14	61000	259065	A.26.3
60721	318523	A.31.1	60859	310979	E.2.5	60957	287620	H.13.14	61000	571055	A.26.3
60743	1414153	H.10.1	60860	310980	E.2.5	60958	120828	H.13.1	61002	1314406	A.26.3
60743	1361331	H.10.1	60861	1337366	E.2.4	60961	153287	L.2.5	61002	292761	A.26.3
60744	1543691	L.9.1	60861	352645	E.2.4	60962	241922	L.2.5	61002	571059	A.26.3
60744	1440294	L.9.1	60862	1337367	E.2.4	60969	1392931	A.16.1	61002	575100	A.26.3
60744	1510195	L.9.1	60862	352646	E.2.4	60969	139472	A.16.1	61005	1375837	A.26.1
60744	1731113	L.9.1	60866	1754546	L.7.4	60969	371515	A.16.1	61005	261575	A.26.1
60754	1384624	C.7.1	60866	204733	L.7.4	60970	1403258	A.3.2	61007	392309	G.2.11
60754	1356022	C.7.1	60866	378277	L.7.4	60970	387503	A.3.2	61007	298021	G.2.11
60758	551365	A.13.8	60867	204728	L.7.5	60971	551449	A.5.2	61007/1	392309	G.2.12
60778	1108445	B.2.1	60893	1313326	H.3.1	60972	551484	A.4.2	61007/1	298021	G.2.12
60778	304394	B.2.1	60893	301760	H.3.1	60973	1392930	A.16.2	61010	214008	F.2.5
60789	1367604	B.2.3	60893	377253	H.3.1	60973	139471	A.16.2	61017	370075	G.2.15
60789	352750	B.2.3	60894	1313325	H.3.1	60973	371514	A.16.2	61020	370074	G.2.9
60790	1797431	B.2.4	60894	377254	H.3.1	60974	304309	B.2.4	61023	1109870	A.10.2
60790	1321260	B.2.4	60895	550539	C.1.6	60975	362778	B.2.4	61023	310951	A.10.2
60790	1393163	B.2.4	60897	550520	C.1.4	60975	352722	B.2.4	61025	388528	C.3.4
60790	382413	B.2.4	60900	550527	C.1.5	60983	1368694	G.2.16	61025	314063	C.3.4
60790	388053	B.2.4	60900	550521	C.1.5	60983	272853	G.2.16	61026	338643	A.11.3
60794	342832	B.2.2	60907	1384897	C.7.2	60983/1	1368690	G.2.17	61026	275591	A.11.3
60794	294999	B.2.2	60907	305319	C.7.2	60983/1	290062	G.2.17	61026	338643	C.3.4
60795	342833	B.2.3	60907	371451	C.7.2	60983/1	397266	G.2.17	61026	275591	C.3.4
60795	304305	B.2.3	60908	1384898	C.7.3	60984	1368693	G.2.17	61033	314572	F.4.1
60798	397956	B.2.3	60908	305320	C.7.3	60984	295953	G.2.17	61077	393950	A.21.6
60798	352745	B.2.3	60908	371452	C.7.3	60985	1897335	E.2.1	61109	1122620	A.2.6
60799	550446	B.1.4	60909	275460	L.2.15	60985	1369411	E.2.1	61119	1912757	M.2.2
60807	360719	B.1.1	60912	1377728	L.2.14	60985	1379168	E.2.1	61119	1379071	M.2.2
60808	1747895	B.1.1	60912	202335	L.2.14	60985	1385251	E.2.1	61119	1384025	M.2.2
60808	1331770	B.1.1	60913	355147	L.2.17	60985	1409918	E.2.1	61119	1768898	M.2.2
60808	371612	B.1.1	60913	135035	L.2.17	60985	1501030	E.2.1	61120	211005	A.28.1
60810	1336159	B.1.5	60914	355145	L.2.16	60985	1723895	E.2.1	61121	192882	A.28.4
60810	550455	B.1.5	60914	128681	L.2.16	60985	1737683	E.2.1	61137	365015	J.3.4
60810	550465	B.1.5							61147	550044	A.26.6

ALL THE COMPONENTS LISTED IN OUR CATALOGUE ARE NOT ORIGINAL, THOUGH PERFECTLY INTERCHANGEABLE. REFERENCE NUMBERS, EITHER ORIGINAL OR OF A DIFFERENT NATURE, ARE FOR INFORMATION PURPOSES ONLY. WHEN PLACING AN ORDER, PLEASE, ALWAYS USE COSIBO REFERENCE NUMBERS AND DO NOT MENTION THE ORIGINAL REFERENCE NUMBERS OF THE TRUCK MANUFACTURERS IN THE INVOICE TO VEHICLE OWNERS OR TO ANYBODY ELSE. THE CUSTOMER TAKES HIS OWN RESPONSIBILITY IF HE DOES NOT COMPLY WITH WHAT ABOVE.

Cross reference COSIBO - SCANIA

COSIBO	Replacing	Page	COSIBO	Replacing	Page	COSIBO	Replacing	Page	COSIBO	Replacing	Page
61152	1362721	H.13.15	61205	165286	A.13.29	61313	1548054	L.2.3	61477	1360833	A.1.5
61152	1342340	H.13.15	61206	362257	A.14.9	61313	255315	L.2.3	61477	278102	A.1.5
61153	1338019	H.13.15	61207	371453	C.7.3	61314	811911	L.2.12	61477	366256	A.1.5
61153	381962	H.13.15	61208	1437727	C.7.3	61314	816089	L.2.12	61482	366547	A.16.4
61154	811768	H.40.5	61208	1384896	C.7.3	61315	272449	L.2.6	61483	1746684	A.16.2
61154	804958	H.40.5	61208	371448	C.7.3	61316	335119	I.54.7	61483	1308589	A.16.2
61162	364624	A.29.1	61209	350270	C.7.1	61317	366006	N.3.2	61483	1392459	A.16.2
61163	1448110	H.13.4	61212	346627	A.27.2	61319	237884	L.2.21	61483	277607	A.16.2
61163	218684	H.13.4	61212	346627	C.8.1	61322	814209	A.23.5	61483	353249	A.16.2
61166	1448111	H.13.4	61212	346627	J.5.1	61322	814209	N.31.1	61483	371510	A.16.2
61166	276517	H.13.4	61213	354967	A.27.7	61323	142575	H.13.14	61484	369276	A.13.3
61167	1448112	H.13.5	61214	315270	C.5.1	61324	1514505	J.8.10	61484	170363	A.13.3
61167	276518	H.13.5	61215	194414	C.5.1	61324	1105972	J.8.10	61485	387775	A.13.1
61168	1448113	H.13.8	61218	252497	L.7.1	61333	244090	C.6.1	61485	303419	A.13.1
61168	278734	H.13.8	61219	369478	A.10.2	61335	280652	H.13.2	61486	364792	A.13.2
61169	1448115	H.13.5	61219	366303	A.10.2	61341	194838	B.2.1	61487	364791	A.13.3
61169	278736	H.13.5	61220	213604	L.2.7	61341	194838	C.1.1	61490	365863	A.13.2
61174	1377571	A.26.3	61222	390358	J.8.1	61344	1120884	B.1.7	61490/1	222499	A.13.2
61174	1338490	A.26.3	61222	347241	J.8.1	61344	338692	B.1.7	61491	170948	A.13.21
61174	397957	A.26.3	61223	390359	J.8.2	61346	374338	A.12.1	61492	170955	A.13.21
61174	571067	A.26.3	61223	347245	J.8.2	61350	1120881	B.1.7	61493	1120880	B.1.7
61180	551476	A.26.6	61226	329583	J.8.6	61350	345360	B.1.7	61494	1372543	C.3.3
61180	550216	A.26.6	61226	305345	J.8.6	61352	808214	B.1.8	61494	335683	C.3.3
61183	550167	A.26.7	61227	1343178	L.7.1	61356	387300	C.1.2	61496	244780	C.2.9
61186	550206	A.26.7	61227	204724	L.7.1	61363	336979	I.48.8	61498	550534	C.1.6
61187	1522013	A.7.7	61230	1392935	A.10.1	61366	1535698	B.2.6	61499	2028998	E.2.2
61187	1361198	A.7.7	61230	371499	A.10.1	61366	224915	B.2.6	61499	1378435	E.2.2
61187	1420836	A.7.7	61232	309065	A.21.7	61366	1535698	C.8.4	61499	1397866	E.2.2
61191	1392196	A.14.11	61233	211813	A.14.5	61366	224915	C.8.4	61499	395350	E.2.2
61191	1320290	A.14.11	61237	378299	A.8.2	61368	1435859	J.9.4	61499	1734020	E.2.2
61191	371490	A.14.11	61237	344426	A.8.2	61371	235434	C.3.5	61501	204750	L.7.1
61192	1384872	A.14.11	61257	1448114	H.13.6	61371	153682	C.3.5	61502	204723	L.7.2
61192	371489	A.14.11	61257	278735	H.13.6	61371	235434	F.1.2	61503	204737	L.7.2
61193	1769799	A.14.3	61259	218832	H.13.6	61371	153682	F.1.2	61504	204735	L.7.2
61193	211818	A.14.3	61260	218831	H.13.6	61460	1370254	A.7.20	61505	204736	L.7.2
61193	372985	A.14.3	61265	309422	H.13.7	61461	2028987	A.7.20	61506	1118446	L.7.3
61194	1769798	A.14.4	61266	309421	H.13.7	61461	1888025	A.7.20	61506	204731	L.7.3
61194	290534	A.14.4	61297	1740992	G.2.8	61461	1448659	A.7.20	61507	204746	L.7.3
61194	372984	A.14.4	61297	1409889	G.2.8	61463	1381926	A.21.13	61508	368033	L.7.4
61195	159656	H.8.3	61297	1534012	G.2.8	61463	270142	A.21.13	61509	204727	L.7.4
61196	375086	G.2.9	61297	370076	G.2.8	61473	1361193	A.1.1	61510	204719	L.7.5
61197	375087	G.2.15	61303	228483	L.2.7	61473	1105218	A.1.1	61511	204722	L.7.5
61198	315022	C.5.1	61305	1477867	L.2.8	61473	215715	A.1.1	61519	1309465	H.40.8
61199	1100867	A.5.10	61305	1429110	L.2.8	61475	1361196	A.1.1	61519	1100816	H.40.8
61199	170132	A.5.10	61305	310808	L.2.8	61475	243648	A.1.1	61519	1305055	H.40.8
61204	1433641	A.13.28	61306	213606	L.2.11	61476	1801529	A.1.4	61529	1112539	H.4.3
61204	1423608	A.13.28	61307	213607	L.2.11	61476	1319081	A.1.4	61529	1112540	H.4.3
61204	165282	A.13.28				61476	391608	A.1.4			

ALL THE COMPONENTS LISTED IN OUR CATALOGUE ARE NOT ORIGINAL, THOUGH PERFECTLY INTERCHANGEABLE. REFERENCE NUMBERS, EITHER ORIGINAL OR OF A DIFFERENT NATURE, ARE FOR INFORMATION PURPOSES ONLY. WHEN PLACING AN ORDER, PLEASE, ALWAYS USE COSIBO REFERENCE NUMBERS AND DO NOT MENTION THE ORIGINAL REFERENCE NUMBERS OF THE TRUCK MANUFACTURERS IN THE INVOICE TO VEHICLE OWNERS OR TO ANYBODY ELSE. THE CUSTOMER TAKES HIS OWN RESPONSIBILITY IF HE DOES NOT COMPLY WITH WHAT ABOVE.

Cross reference COSIBO - SCANIA

COSIBO	Replacing	Page	COSIBO	Replacing	Page	COSIBO	Replacing	Page	COSIBO	Replacing	Page
61530	1342121	H.3.1	61632	1312934	A.7.2	61710	1372510	J.8.17	61833	550343	A.13.9
61530	1117705	H.3.1	61632	323641	A.7.2	61728	1306975	I.48.9	61833	551466	A.13.9
61530	385647	H.3.1	61632	1312934	B.3.2	61728	356085	I.48.9	61834	1305959	A.8.2
61531	1103635	H.3.2	61632	323641	B.3.2	61729	1306976	I.48.9	61834	170610	A.8.2
61531	1309571	H.3.2	61632	1312934	H.6.8	61729	356086	I.48.9	61834	381638	A.8.2
61536	1332503	A.12.1	61632	323641	H.6.8	61731	285248	A.5.15	61835	378264	A.13.4
61536	1348896	A.12.1	61634	315002	C.3.2	61731	285248	J.8.12	61836	1109288	A.13.4
61536	1332503	H.4.1	61640	1116847	F.2.4	61734	339188	L.2.9	61837	1302827	A.7.2
61536	1348896	H.4.1	61643	1309563	C.6.4	61743	385266	J.8.2	61837	362408	A.7.2
61537	15323	A.13.23	61644	336980	I.48.8	61745	1478450	A.32.1	61838	1801737	A.13.5
61538	276087	A.13.22	61645	367326	N.30.1	61745	1369848	A.32.1	61838	1323354	A.13.5
61548	1122696	A.32.1	61645	347893	N.30.1	61745	1432186	A.32.1	61838	1393937	A.13.5
61548	361692	A.32.1	61648	2000089	J.8.16	61746	1303951	A.29.21	61842	1392932	A.9.1
61549	278665	M.2.1	61648	1386423	J.8.16	61747	1303952	A.29.21	61842	170694	A.9.1
61549	278666	M.2.1	61649	301519	G.2.6	61748	1303953	A.29.21	61844	1384551	A.9.1
61550	1377799	L.2.2	61650	273023	G.2.6	61749	1303954	A.29.21	61844	371483	A.9.1
61550	363990	L.2.2	61651	1327413	G.2.5	61750	1303955	A.29.22	61846	351197	A.24.3
61552	1412666	A.13.8	61651	287449	G.2.5	61751	1303956	A.29.22	61846	278335	A.24.3
61552	366539	A.13.8	61652	1879541	D.2.2	61752	1303957	A.29.22	61849	156938	G.2.15
61553	1320292	A.13.3	61652	1422442	D.2.2	61753	1303958	A.29.22	61849	1112702	G.2.15
61553	371491	A.13.3	61652	1541072	D.2.2	61758	153468	A.14.1	61850	272400	L.1.1
61554	388402	A.13.7	61652	386073	D.2.2	61758	153468	M.5.3	61851	1907845	G.2.12
61560	551512	A.4.1	61654	370875	M.2.6	61759	1368736	A.7.14	61851	1363674	G.2.12
61560	551500	A.4.1	61654	370875	M.2.6	61759	1350909	A.7.14	61851	1528043	G.2.12
61585	1116698	F.2.7	61656	390784	M.2.7	61759	1362222	A.7.14	61851	1786639	G.2.12
61586	1116848	F.2.7	61657	1106953	I.7.1	61759	1368735	A.7.14	61852	1391386	H.5.3
61587	1116699	F.2.8	61657	396851	I.7.1	61759	350061	A.7.14	61856	1386452	B.2.6
61602	301843	I.56.1	61658	1106955	I.7.2	61761	273022	G.2.7	61858	1367370	L.2.13
61604	369375	I.30.8	61658	396853	I.7.2	61762	1388684	A.7.5	61859	1362710	L.2.14
61606	1406613	I.48.8	61659	296538	I.7.2	61762	371492	A.7.5	61859	255669	L.2.14
61606	376673	I.48.8	61660	296538/A	I.7.2	61764	1103619	B.2.2	61864	318350	A.27.2
61607	1366849	I.48.10	61661	1365968	N.2.2	61764	1103619	C.3.2	61865	353628	N.30.3
61608	1923594	H.14.1	61661	394766	N.2.2	61770/S	365488	A.29.27	61866	1321259	B.2.11
61608	1422701	H.14.1	61662	1365969	N.2.2	61771/S	365484	A.29.26	61869	1340201	A.27.8
61621	353592	J.4.1	61662	394767	N.2.2	61790	1542159	H.5.3	61878	1374083	H.5.2
61621	341299	J.4.1	61663	1371292	N.2.3	61790	1376281	H.5.3	61878	1108223	H.5.2
61622	1852817	H.13.2	61663	313657	N.2.3	61793	298823	A.27.7	61878	1108227	H.5.2
61622	1402272	H.13.2	61664	1371293	N.2.3	61793	298823	C.8.1	61878	1327886	H.5.2
61624	234387	C.2.5	61664	313658	N.2.3	61798	303643	A.27.1	61878	319747	H.5.2
61627	367761	A.21.4	61703	297394	A.21.18	61799	223315	A.27.7	61878	551435	H.5.2
61628	393107	C.7.11	61703	297394	C.8.4	61800	241805	A.27.2	61878	551436	H.5.2
61628	321297	C.7.11	61704	312646	A.21.14	61808	142729	A.27.1	61879	1350817	H.13.13
61629	393108	C.7.11	61706	316640	I.7.4	61808	142729	J.5.1	61879	324728	H.13.13
61629	310243	C.7.11	61707	1545478	A.13.25	61830	1376280	H.5.5	61902	1769800	A.14.5
61630	323662	A.7.1	61707	1408455	A.13.25	61831	1376279	H.5.5	61902	1475433	A.14.5
61631	1302828	A.7.1	61707	250995	A.13.25	61832	551450	A.13.9	61903	1118884	J.8.16
61631	342989	A.7.1	61707	278531	A.13.25	61832	550231	A.13.9			
			61708	288649	H.8.1						

ALL THE COMPONENTS LISTED IN OUR CATALOGUE ARE NOT ORIGINAL, THOUGH PERFECTLY INTERCHANGEABLE. REFERENCE NUMBERS, EITHER ORIGINAL OR OF A DIFFERENT NATURE, ARE FOR INFORMATION PURPOSES ONLY. WHEN PLACING AN ORDER, PLEASE, ALWAYS USE COSIBO REFERENCE NUMBERS AND DO NOT MENTION THE ORIGINAL REFERENCE NUMBERS OF THE TRUCK MANUFACTURERS IN THE INVOICE TO VEHICLE OWNERS OR TO ANYBODY ELSE. THE CUSTOMER TAKES HIS OWN RESPONSIBILITY IF HE DOES NOT COMPLY WITH WHAT ABOVE.

Cross reference COSIBO - SCANIA

COSIBO	Replacing	Page	COSIBO	Replacing	Page	COSIBO	Replacing	Page	COSIBO	Replacing	Page
61906	1856108	H.13.3	61969	1317538	I.50.3	62040	1336882	C.9.1	62226	1308969	B.2.7
61906	1390428	H.13.3	61971	1397570	I.50.1	62041	1113033	D.1.1	62227	1307793	B.2.8
61906	1527633	H.13.3	61971	1371856	I.50.1	62047	326631	A.13.17	62228	1345492	C.2.10
61906	1734529	H.13.3	61972	392099	I.54.3	62062	1867874	L.1.2	62229	395634	C.7.11
61906	1890861	H.13.3	61972	388169	I.54.3	62062	1370267	L.1.2	62230	395635	C.7.12
61907	1383858	I.54.6	61973	392100	I.54.3	62067	376243	I.7.3	62231	1102585	C.7.12
61908	1349045	A.13.17	61973	388170	I.54.3	62089	1747894	B.1.2	62232	1356372	C.7.14
61908	1349045	H.2.1	61974	1302771	I.54.4	62089	298953	B.1.2	62233	1344190	L.2.10
61909	1402400	A.7.21	61975	1325266	I.54.5	62089	338923	B.1.2	62234	1400209	N.1.3
61909	1102581	A.7.21	61976	1325265	I.54.5	62089	360717	B.1.2	62235	423736	L.2.10
61909	1318075	A.7.21	61979	288177	I.54.5	62091	62091	B.1.8	62236	1322341	L.2.10
61909	1322142	A.7.21	61980	288178	I.54.6	62100	1370329	I.55.2	62237	1324366	L.2.11
61909	1402401	A.7.21	61987	316756	I.56.1	62101	1370330	I.55.2	62238	307113	L.2.6
61910	1407430	B.2.5	61987	330749	I.56.1	62105	1521210	A.1.6	62239	1379244	J.8.10
61910	1321255	B.2.5	61988	1303318	I.51.1	62105	393263	A.1.6	62240	301845	I.56.2
61911	301844	I.56.1	61988	1110201	I.51.1	62108	1116987	A.1.2	62242	348764	J.8.1
61916	1323823	A.7.21	61989	1324597	I.51.4	62108	263427	A.1.2	62243	1372432	J.8.11
61917	180435	A.13.27	61990	1324598	I.51.5	62111	1364140	L.2.21	62245	716360	J.8.2
61921	1384554	A.16.2	61991	1400213	I.51.4	62133	316918	I.7.1	62249	1117253	N.30.8
61921	1301628	A.16.2	61991	1324596	I.51.4	62134	275698	L.2.19	62249	1118188	N.30.8
61922	1384555	A.16.3	61992	1329552	I.51.1	62135	1369917	M.2.1	62250	1515190	I.51.3
61922	1301629	A.16.3	61993	1329551	I.51.1	62135	300308	M.2.1	62250	1376832	I.51.3
61923	1304571	M.2.1	62006	327557	B.2.7	62135	306913	M.2.1	62250	1482069	I.51.3
61923	381339	M.2.1	62006	234682	B.2.7	62135	382774	M.2.1	62250	1499231	I.51.3
61924	352635	M.2.1	62010	1894408	J.8.15	62136	316920	I.7.1	62253	1114170	A.33.1
61924	278663	M.2.1	62010	1343134	J.8.15	62138	389500	M.1.2	62254	1543635	N.4.1
61924	278664	M.2.1	62010	1481245	J.8.15	62144	384848	A.13.26	62254	1324600	N.4.1
61932	352637	M.2.2	62011	393932	A.21.7	62145	1356668	J.8.5	62255	1543634	N.4.1
61933	1308643	M.2.1	62012	1513717	B.1.2	62145	320775	J.8.5	62255	1324599	N.4.1
61936	1375493	A.28.3	62012	1367453	B.1.2	62195	1406614	I.48.9	62256	2056867	I.52.3
61946	390533	F.1.1	62012	1421186	B.1.2	62195	376674	I.48.9	62256	1383520	I.52.3
61953	1303472	C.2.5	62012	1454590	B.1.2	62208	376116	I.48.4	62257	1732510	N.1.4
61953	375734	C.2.5	62012	1469161	B.1.2	62211	1382827	J.9.2	62257	1431256	N.1.4
61953	1303472	F.4.1	62013	550464	B.1.6	62213	395339	A.33.11	62257	1446588	N.1.4
61953	375734	F.4.1	62013	550458	B.1.6	62214	295297	A.5.16	62257	1467003	N.1.4
61955	1427670	A.28.5	62013	550562	B.1.6	62215	338395	A.5.16	62258	1732509	N.1.3
61955	1384501	A.28.5	62014	355708	B.3.1	62216	352543	A.5.16	62258	1431257	N.1.3
61955	393620	A.28.5	62015	311757	J.8.2	62217	1307953	A.5.16	62258	1446587	N.1.3
61959	391555	A.21.5	62027	346085	J.8.2	62218	1108488	A.5.17	62258	1467000	N.1.3
61960	132650	A.16.11	62028	283295	J.8.3	62219	120252	L.2.22	62259/1	62259/1	A.13.10
61960	132650	L.7.5	62029	348694	J.8.4	62220	303649	A.21.11	62260	1764886	A.21.1
61961	1361136	B.1.4	62030	1302008	J.8.4	62220	303649	I.105.7	62260	1327249	A.21.1
61961	1105332	B.1.4	62031	325014	J.8.4	62221	1755952	A.24.3	62260	1397435	A.21.1
61961	1114685	B.1.4	62032	311755	J.8.4	62221	1351075	A.24.3	62260	1408881	A.21.1
61964	1313592	I.54.2	62033	1121763	J.8.5	62222	300296	A.21.11	62260	1442751	A.21.1
61965	1313594	I.54.3	62033	297571	J.8.5	62223	1304725	A.12.1	62260	570491	A.21.1
61966	1395276	I.54.6	62035	1332320	I.54.2	62223	397929	A.12.1	62261	1529070	N.1.2
61966	1378194	I.54.6	62040	1336882	A.18.2	62225	1432187	A.32.2	62261	1422991	N.1.2

ALL THE COMPONENTS LISTED IN OUR CATALOGUE ARE NOT ORIGINAL, THOUGH PERFECTLY INTERCHANGEABLE. REFERENCE NUMBERS, EITHER ORIGINAL OR OF A DIFFERENT NATURE, ARE FOR INFORMATION PURPOSES ONLY. WHEN PLACING AN ORDER, PLEASE, ALWAYS USE COSIBO REFERENCE NUMBERS AND DO NOT MENTION THE ORIGINAL REFERENCE NUMBERS OF THE TRUCK MANUFACTURERS IN THE INVOICE TO VEHICLE OWNERS OR TO ANYBODY ELSE. THE CUSTOMER TAKES HIS OWN RESPONSIBILITY IF HE DOES NOT COMPLY WITH WHAT ABOVE.

Cross reference COSIBO - SCANIA

COSIBO	Replacing	Page	COSIBO	Replacing	Page	COSIBO	Replacing	Page	COSIBO	Replacing	Page
62262	1529071	N.1.3	62298	280553	N.1.8	62342	1536307	L.6.2	62374	1525892	J.2.5
62262	1422992	N.1.3	62299	367762	A.21.4	62342	1421325	L.6.2	62374	1337958	J.2.5
62264	1514093	I.51.4	62300	1471599	I.30.8	62343	1366850	I.48.10	62375	1358291	J.2.5
62264	1395871	I.51.4	62305	1397571	I.50.4	62343	1366850	I.48.10	62375	1525887	J.2.5
62264	1499230	I.51.4	62305	1371857	I.50.4	62344	1485485	I.54.7	62376	1323400	J.2.1
62266	1424227	J.9.1	62306	1357602	I.54.6	62344	1408465	I.54.7	62377	1323410	J.2.2
62266	1363120	J.9.1	62307	1368652	I.54.2	62345	1485486	I.54.7	62379	1396542	I.7.11
62267	1435856	J.9.1	62308	1362708	I.54.1	62345	1408466	I.54.7	62382	1486634	A.11.3
62268	1382829	J.9.3	62310	1401929	I.50.1	62346	1549740	J.1.1	62383	1850567	H.6.3
62268	1382826	J.9.3	62311	1371757	I.50.1	62346	1422640	J.1.1	62383	1736364	H.6.3
62269	1379384	N.3.4	62312	1371758	I.50.1	62346	1534976	J.1.1	62384	2093721	I.54.11
62270	394768	N.2.2	62313	1403954	A.21.13	62347	2005369	I.48.6	62384	1785531	I.54.11
62271	394769	N.2.2	62313	1318911	A.21.13	62347	1423017	I.48.6	62384	1409860	I.54.11
62274	1795583	A.21.10	62314	385840	J.1.5	62347	1488409	I.48.6	62384	1482405	I.54.11
62274	397308	A.21.10	62319	336590	J.10.3	62347	1544330	I.48.6	62386	1105970	O.1.2
62274	1795583	J.8.11	62321	356942	I.48.10	62348	2005370	I.48.6	62387	1385402	N.1.5
62274	397308	J.8.11	62321	356942	I.48.10	62348	1423018	I.48.6	62388	1385403	N.1.5
62275	1366384	I.50.2	62322	1476415	J.9.3	62348	1488410	I.48.6	62389	1413146	I.48.12
62275	1306198	I.50.2	62324	62324	J.1.11	62348	1544331	I.48.6	62390	1425019	M.1.1
62276	1363131	J.3.2	62324/1	IT7085	J.1.9	62353	1535045	I.30.9	62393	815462	H.5.6
62276	1328177	J.3.2	62324/1	1526569	J.1.9	62353	1351203	I.30.9	62395	1374642	J.4.1
62276	290950	J.3.2	62324/1	1371200	J.1.9	62354	581025	I.48.6	62397	308678	A.21.21
62278	1446583	N.1.4	62324/2	IT7086	J.1.9	62356	1314653	J.1.1	62397	308678	H.6.9
62279	1446584	N.1.4	62324/2	1526571	J.1.9	62357	1549738	J.1.7	62398	1353142	H.4.3
62280	1383609	I.50.1	62324/2	1371207	J.1.9	62357	1466506	J.1.7	62398	1353142	N.30.3
62281	1386957	I.55.5	62324/3	IT7088	J.1.10	62357	1517324	J.1.7	62399	1396529	I.7.5
62282	1537675	I.55.5	62324/3	1851213	J.1.10	62358	1385406	N.1.4	62400	1396530	I.7.5
62282	1386958	I.55.5	62324/3	1371208	J.1.10	62359	1385407	N.1.5	62401	1873018	A.30.1
62283	62283	I.56.3	62324/3	1526572	J.1.10	62361	1381235	A.14.15	62401	1446432	A.30.1
62285	1749953	I.56.5	62324/4	IT7087	J.1.10	62361	1329876	A.14.15	62402	2057893	A.14.15
62285	1379997	I.56.5	62324/4	1371201	J.1.10	62361	1381235	C.3.6	62402	1439036	A.14.15
62285	584085	I.56.5	62324/4	1526570	J.1.10	62361	1329876	C.3.6	62402	1873014	A.14.15
62290	1764885	A.21.2	62324/5	IT7084	J.1.10	62361	1381235	H.6.7	62403	1421021	A.16.6
62290	1384059	A.21.2	62324/5	1526573	J.1.10	62361	1329876	H.6.7	62403	1335678	A.16.6
62290	1477051	A.21.2	62324/5	1426339	J.1.10	62363	388536	I.50.3	62404	1732515	N.1.5
62290	570490	A.21.2	62327	1390075	I.30.1	62364	1381479	I.50.2	62404	1467007	N.1.5
62291	1726850	I.55.10	62328	1354593	I.30.1	62364	1306403	I.50.2	62405	1449757	J.5.2
62291	1381563	I.55.10	62329	207783	A.28.3	62365	1381480	I.50.2	62405	1354110	J.5.2
62291	1440108	I.55.10	62334	1105803	J.1.5	62365	1306404	I.50.2	62406	1375497	J.1.1
62292	1726851	I.55.11	62335	361993	I.30.4	62366	385159	I.50.3	62406	1349010	J.1.1
62292	1381564	I.55.11	62336	1497013	A.33.2	62369	375903	J.2.3	62407	1769452	I.56.2
62292	1440113	I.55.11	62336	1387823	A.33.2	62369	288207	J.2.3	62407	1430533	I.56.2
62294	1346425	J.10.3	62338	1354594	I.30.2	62370	375904	J.2.3	62411	1870689	I.50.2
62294	1306379	J.10.3	62339	1390074	I.30.1	62370	288208	J.2.3	62411	1366832	I.50.2
62295	1434135	J.3.2	62340	361994	I.30.5	62371	375905	J.2.4	62412	1383887	I.50.2
62296	1424231	J.9.3	62341	1326935	I.56.3	62371	288209	J.2.4	62413	1383888	I.50.3
62296	1349840	J.9.3	62342	1536307	J.6.1	62372	1323401	J.2.2	62414	1515195	I.30.5
62297	371910	M.1.1	62342	1421325	J.6.1	62373	1353735	J.2.2	62414	1351193	I.30.5

ALL THE COMPONENTS LISTED IN OUR CATALOGUE ARE NOT ORIGINAL, THOUGH PERFECTLY INTERCHANGEABLE. REFERENCE NUMBERS, EITHER ORIGINAL OR OF A DIFFERENT NATURE, ARE FOR INFORMATION PURPOSES ONLY. WHEN PLACING AN ORDER, PLEASE, ALWAYS USE COSIBO REFERENCE NUMBERS AND DO NOT MENTION THE ORIGINAL REFERENCE NUMBERS OF THE TRUCK MANUFACTURERS IN THE INVOICE TO VEHICLE OWNERS OR TO ANYBODY ELSE. THE CUSTOMER TAKES HIS OWN RESPONSIBILITY IF HE DOES NOT COMPLY WITH WHAT ABOVE.

Cross reference COSIBO - SCANIA

COSIBO	Replacing	Page	COSIBO	Replacing	Page	COSIBO	Replacing	Page	COSIBO	Replacing	Page
62415	1515194	I.30.6	62460	1528991	F.2.2	62512	1371839	A.21.21	62535	1401840	A.32.3
62415	1351194	I.30.6	62460	1680726	F.2.2	62512	295960	A.21.21	62535	1482500	A.32.3
62420	1304787	N.2.3	62460	388728	F.2.2	62512	1371839	H.6.8	62535	1387193	A.32.3
62421	62421	I.48.7	62461	1103934	B.2.2	62512	295960	H.6.8	62535	1401840	A.32.3
62422	1366851	J.10.4	62461	1103934	C.3.3	62512	1371839	J.2.6	62535	1482500	A.32.3
62424	1852570	N.1.1	62463	2080828	I.30.9	62512	295960	J.2.6	62536	1366781	J.10.2
62424	1446354	N.1.1	62463	1737413	I.30.9	62518	1923607	H.14.2	62537	1366735	J.10.2
62425	1852569	N.1.1	62463	2000390	I.30.9	62518	1521553	H.14.2	62538	1440367	J.7.2
62425	1446353	N.1.1	62465	550813	F.2.2	62518	1364902	H.14.2	62539	1440364	J.7.3
62426	1852572	N.1.1	62466	1386104	L.7.6	62519	1543688	A.7.15	62540	1877664	J.10.1
62426	1446355	N.1.1	62467	62467	L.7.6	62519	1333183	A.7.15	62542	1516474	A.16.3
62427	1852573	N.1.2	62468	62468	L.7.6	62520	1488067	J.3.1	62542	1374338	A.16.3
62427	1446356	N.1.2	62469	1484808	C.6.1	62520	353626	J.3.1	62542	1374340	A.16.3
62428	1382728	I.55.4	62469	1321420	C.6.1	62521	475110	L.6.1	62542	1516145	A.16.3
62429	1382727	I.55.4	62469	1484807	C.6.1	62521	468568	L.6.1	62543	1543607	I.50.4
62430	1381566	I.55.3	62470	1484809	C.6.1	62522	1441235	C.7.4	62550	1539871	I.56.2
62431	1381565	I.55.3	62470	1345151	C.6.1	62523	1304786	N.2.3	62550	1355656	I.56.2
62432	1431925	I.51.3	62471	1391426	J.7.1	62524	1770301	I.30.4	62552	1761195	G.2.4
62433	1431926	I.51.3	62472	1391425	J.7.1	62524	1722531	I.30.4	62552	1315681	G.2.4
62434	1504131	I.51.2	62473	1440371	J.7.2	62524	1770301	N.2.4	62553	1390706	A.22.3
62436	62436	I.110.1	62474	1440370	J.7.1	62524	1722531	N.2.4	62554	1892056	N.30.11
62437	1803335	A.23.8	62475	1548504	J.2.7	62525	1440365	J.7.2	62554	1428454	N.30.11
62437	1534505	A.23.8	62476	1720924	J.1.7	62526	284015	C.2.11	62554	1530702	N.30.11
62439	1921972	C.9.2	62477	1524337	J.1.6	62527	1919065	C.7.5	62555	1892057	N.30.11
62439	1469287	C.9.2	62477	1501180	J.1.6	62527	1727377	C.7.5	62555	1530704	N.30.11
62439	1782203	C.9.2	62478	1377566	C.8.5	62527	1438702	C.7.5	63005	294904	C.3.1
62440	1364666	I.52.1	62479	1377567	C.8.5	62528	1762624	A.21.9	63005	294903	C.3.1
62441	1364665	I.52.1	62480	1755594	I.50.4	62528	1492747	A.21.9	63019	1519631	L.1.2
62442	1390747	I.54.7	62480	1538383	I.50.4	62529	1762623	A.21.9	63019	1478507	L.1.2
62443	1375428	N.4.2	62481	1536807	I.50.6	62529	1492746	A.21.9	63019	1397523	L.1.2
62444	1375427	N.4.2	62482	1538385	I.55.10	62530	1852113	C.2.4	63051	316379	N.30.9
62445	1386960	I.55.6	62483	1538384	I.55.9	62530	1742947	C.2.4	63055	1303471	C.2.6
62446	1386959	I.55.6	62484	1504019	J.10.1	62530	1852113	J.3.5	63055	370710	C.2.6
62447	1370108	I.55.7	62484	1366837	J.10.1	62530	1742947	J.3.5	63055	1303471	F.4.2
62448	1370107	I.55.7	62485	1504020	J.10.1	62531	1742265	I.50.7	63055	370710	F.4.2
62449	62449	I.55.8	62485	1366838	J.10.1	62531	1543308	I.50.7	63055	1303471	N.40.2
62450	62450	I.55.8	62486	1341110	J.10.2	62532	1724264	I.50.7	63055	370710	N.40.2
62453	1854058	C.8.4	62487	1522464	J.10.3	62532	1543307	I.50.7	63057	384970	C.7.5
62453	1380106	C.8.4	62487	1385829	J.10.3	62533	1767631	I.50.12	63064	551351	A.13.9
62455	1369053	J.1.5	62488	1346601	J.10.2	62533	1431334	I.50.12	63068	815454	H.5.6
62456	1433656	J.1.6	62489	1420776	A.8.2	62534	1401839	A.32.3	63068	814346	H.5.6
62457	1541982	J.1.6	62490	1368061	A.5.5	62534	1398636	A.32.3	63071	815457	H.5.6
62457	1433655	J.1.6	62491	1516496	L.4.1	62534	1387191	A.32.3	63071	814349	H.5.6
62458	1541983	J.1.6	62496	1539870	I.56.2	62534	1398636	A.32.3	63073	815458	H.5.7
62458	1433654	J.1.6	62496	1379814	I.56.2	62534	1401839	A.32.3	63073	814350	H.5.7
62459	1324663	H.8.2	62497	62497	I.55.9				63074	815459	H.5.7
62459	1324664	H.8.2	62498	62498	I.55.8				63084	1111494	A.31.2
			62499	62499	A.33.7				63085	1367028	A.8.3

ALL THE COMPONENTS LISTED IN OUR CATALOGUE ARE NOT ORIGINAL, THOUGH PERFECTLY INTERCHANGEABLE. REFERENCE NUMBERS, EITHER ORIGINAL OR OF A DIFFERENT NATURE, ARE FOR INFORMATION PURPOSES ONLY. WHEN PLACING AN ORDER, PLEASE, ALWAYS USE COSIBO REFERENCE NUMBERS AND DO NOT MENTION THE ORIGINAL REFERENCE NUMBERS OF THE TRUCK MANUFACTURERS IN THE INVOICE TO VEHICLE OWNERS OR TO ANYBODY ELSE. THE CUSTOMER TAKES HIS OWN RESPONSIBILITY IF HE DOES NOT COMPLY WITH WHAT ABOVE.

Cross reference COSIBO - SCANIA

COSIBO	Replacing	Page	COSIBO	Replacing	Page	COSIBO	Replacing	Page	COSIBO	Replacing	Page
63093	1500455	A.33.2	63175	1375718	A.21.14	63320	750226	H.6.1	63349	1789561	H.13.9
63093	1420278	A.33.2	63175	1315195	A.21.14	63321	1445398	A.21.12	63349	1112833	H.13.9
63094	1397273	A.33.4	63175	368559	A.21.14	63322	1422564	A.29.2	63350	1789562	H.13.10
63097	1300367	A.33.9	63176	318364	A.27.8	63323	1422474	A.33.10	63350	1112834	H.13.10
63107	1315559	A.33.11	63176	318364	C.8.1	63323	1387136	A.33.10	63353	346077	M.5.1
63109	1460812	E.2.6	63178	301789	A.27.8	63324	1304781	B.2.1	63354	1541653	M.1.1
63109	1460812	F.1.1	63179	382985	A.27.8	63324	571254	B.2.1	63354	1439270	M.1.1
63110	1515117	C.7.7	63180	382983	A.27.14	63326	1485717	C.7.5	63354	1462613	M.1.1
63110	1428073	C.7.7	63187	1495692	J.5.2	63326	1369555	C.7.5	63354	1489734	M.1.1
63112	1515118	C.7.7	63187	1401436	J.5.2	63327	1482997	C.7.6	63354	1490913	M.1.1
63112	1426263	C.7.7	63192	1375602	A.24.4	63327	1362071	C.7.6	63355	1540425	M.1.2
63114	1375383	A.9.2	63192	1305644	A.24.4	63328	339130	C.7.8	63355	1462612	M.1.2
63117	1545062	B.2.5	63193	1421825	A.24.4	63329	307443	C.7.2	63355	1490912	M.1.2
63117	1393161	B.2.5	63193	1358996	A.24.4	63330	1502384	C.5.2	63355	1491834	M.1.2
63120	1865675	A.13.8	63194	318362	A.21.5	63330	1300974	C.5.2	63356	1386271	N.3.2
63120	1460362	A.13.8	63214	267460	A.27.1	63330	1380160	C.5.2	63356	1365959	N.3.2
63120	1744775	A.13.8	63214	267460	H.5.1	63330	1393331	C.5.2	63356	1365961	N.3.2
63123	1527743	C.1.3	63219	350572	A.21.15	63330	1502384	F.2.1	63357	1386272	N.3.1
63123	1329585	C.1.3	63229	412080	A.21.13	63330	1300974	F.2.1	63357	1365958	N.3.1
63124	1305139	C.1.3	63229	412080	C.8.1	63330	1380160	F.2.1	63357	1365960	N.3.1
63128	1318388	B.3.3	63241	184490	C.3.1	63330	1393331	F.2.1	63359	1350343	N.3.3
63128	1318388	C.3.4	63253	254333	C.3.2	63331	1472144	C.6.2	63361	1744210	J.8.9
63139	1475868	A.18.3	63262	1114838	C.3.1	63331	804666	C.6.2	63361	1443114	J.8.9
63139	1371729	A.18.3	63262	244536	C.3.1	63332	1474732	C.6.3	63361	1504160	J.8.9
63139	1423012	A.18.3	63275	378480	F.2.5	63332	804674	C.6.3	63362	1525890	J.2.4
63140	369477	A.11.2	63276	1319557	C.2.2	63333	1472142	C.6.3	63362	1358288	J.2.4
63140	372773	A.11.2	63279	551525	A.4.2	63333	804713	C.6.3	63363	1525888	J.2.4
63148	292811	A.8.7	63280	551350	A.4.2	63334	1515869	C.6.4	63363	1358289	J.2.4
63151	372981	A.14.10	63281	551363	A.4.3	63334	1315437	C.6.4	63364	1525889	J.2.4
63152	1316331	A.12.2	63287	295751	L.2.8	63335	1472145	C.6.5	63364	1358290	J.2.4
63152	1334704	A.12.2	63292	1514086	A.23.3	63335	1303798	C.6.5	63365	288212	J.2.2
63153	1316330	A.12.3	63292	1428940	A.23.3	63336	63336	H.40.10	63366	288213	J.2.2
63154	1433110	A.21.14	63293	550269	A.26.7	63337	804672	C.6.7	63367	288214	J.2.3
63154	1423508	A.21.14	63295	551355	A.26.8	63337	390546	C.6.7	63369	1732776	I.7.4
63154	397999	A.21.14	63296	551369	A.26.8	63338	804658	C.6.7	63369	1442705	I.7.4
63155	219722	A.21.8	63297	488368	A.21.15	63338	397920	C.6.7	63370	1732778	I.7.5
63164	1872753	H.6.2	63297	390581	A.21.15	63339	1472718	C.6.6	63370	1346579	I.7.5
63164	1379707	H.6.2	63300	373210	A.21.15	63339	804710	C.6.6	63372	1304292	A.5.7
63166	1331309	A.16.10	63301	375527	A.21.16	63344	1515870	C.6.6	63373/S	1313677	A.29.25
63166	1331309	H.6.2	63303	1108053	A.13.30	63344	1318762	C.6.6	63374/S	1382071	A.29.25
63170	375937	A.16.10	63306	1912758	M.2.2	63345	1502385	F.2.1	63374/S	1313676	A.29.25
63171	1745449	A.24.1	63306	1847312	M.2.2	63345	1383129	F.2.1	63375	1356677	A.13.22
63171	1347594	A.24.1	63306	1384027	M.2.2	63345	1386594	F.2.1	63375	355939	A.13.22
63171	1404925	A.24.1	63306	1769597	M.2.2	63346	1112829	H.13.8	63376	1374700	A.13.17
63172	1916620	A.24.2	63307	1386453	B.2.8	63347	1112830	H.13.9	63376	354334	A.13.17
63172	1358995	A.24.2	63308	1386454	B.2.8	63348	1789560	H.13.9	63377	1380451	A.13.18
63172	1404924	A.24.2	63320	750226	A.14.6	63348	1112831	H.13.9	63377	1109278	A.13.18
63174	283281	A.24.2									

ALL THE COMPONENTS LISTED IN OUR CATALOGUE ARE NOT ORIGINAL, THOUGH PERFECTLY INTERCHANGEABLE. REFERENCE NUMBERS, EITHER ORIGINAL OR OF A DIFFERENT NATURE, ARE FOR INFORMATION PURPOSES ONLY. WHEN PLACING AN ORDER, PLEASE, ALWAYS USE COSIBO REFERENCE NUMBERS AND DO NOT MENTION THE ORIGINAL REFERENCE NUMBERS OF THE TRUCK MANUFACTURERS IN THE INVOICE TO VEHICLE OWNERS OR TO ANYBODY ELSE. THE CUSTOMER TAKES HIS OWN RESPONSIBILITY IF HE DOES NOT COMPLY WITH WHAT ABOVE.

Cross reference COSIBO - SCANIA

COSIBO	Replacing	Page	COSIBO	Replacing	Page	COSIBO	Replacing	Page	COSIBO	Replacing	Page
63378	1371209	A.13.18	63447	2077837	N.30.4	63562	812418	A.7.12	63618	1869987	A.16.6
63378	1109279	A.13.18	63447	1431781	N.30.4	63562	182525	A.7.12	63618	1387548	A.16.6
63384	1514087	A.23.3	63447	1391322	N.30.4	63562	812418	C.1.9	63618	1526086	A.16.6
63384	1413609	A.23.3	63447	243460	N.30.4	63562	182525	C.1.9	63619	1395248	A.13.19
63384	1428941	A.23.3	63450	1318306	N.30.4	63562	812418	F.2.6	63620	1306492	J.4.1
63385	131115	A.5.6	63450	278263	N.30.4	63562	182525	F.2.6	63621	63621	C.5.2
63386	157274	A.5.6	63465	1902698	N.30.4	63562	812418	G.2.14	63625	63625	C.6.5
63387	131455	A.5.7	63465	1327013	N.30.4	63562	182525	G.2.14	63627	291826	A.8.3
63388	323451	A.7.3	63465	1401788	N.30.4	63562	812418	H.6.1	63639	1800521	A.23.6
63388	323451	C.1.8	63465	1504270	N.30.4	63562	182525	H.6.1	63639	1389028	A.23.6
63389	1305676	C.6.2	63466	1902328	N.30.5	63562	812418	M.5.2	63639	1454280	A.23.6
63407	550154	A.5.11	63466	1335482	N.30.5	63562	182525	M.5.2	63639	1888463	A.23.6
63408	1332967	A.13.11	63466	1523612	N.30.5	63563	1391726	A.7.13	63640	1803333	A.23.6
63409	1332968	A.13.11	63466	1741091	N.30.5	63563	366550	A.7.13	63640	1389031	A.23.6
63410	1332969	A.13.11	63467	1401789	N.30.5	63565	1444941	A.3.2	63640	1530979	A.23.6
63411	1332970	A.13.11	63467	1328548	N.30.5	63565	1377039	A.3.2	63644	1434134	J.3.4
63412	1332971	A.13.12	63468	270739	A.13.18	63565	1403260	A.3.2	63644	1423207	J.3.4
63413	1333116	A.13.24	63469	270738	A.13.19	63567	1340408	B.1.9	63646	1430545	J.8.16
63414	1545479	A.13.24	63470	293853	A.13.19	63569	1753479	B.3.2	63646	1407139	J.8.16
63414	394794	A.13.24	63540	1346905	I.48.5	63569	1335485	B.3.2	63646	1451839	J.8.16
63416	1320973	A.5.7	63541	1346906	I.48.5	63570	329638	C.2.9	63646	1399776	J.8.16
63438	1368123	N.3.1	63545	1791152	A.1.4	63571	1375369	A.29.27	63646	1934939	J.8.16
63438	371894	N.3.1	63545	1328537	A.1.4	63572	1375370	A.29.27	63649	1671745	A.13.20
63438	371896	N.3.1	63545	1445830	A.1.4	63573	1375371	A.29.28	63652	1859654	A.23.1
63440	1405979	N.31.1	63546	1785076	A.1.3	63574	1375372	A.29.28	63652	1493670	A.23.1
63446	1543731	N.30.6	63546	1333230	A.1.3	63575	1375373	A.29.28	63652	1503113	A.23.1
63446	1407909	N.30.6	63546	1477022	A.1.3	63576	1375374	A.29.29	63652	1545982	A.23.1
63446	1439172	N.30.6	63547	1309051	A.13.6	63585	1394884	M.2.3	63652	1774651	A.23.1
63446	303535	N.30.6	63548	1862376	A.7.3	63587	1759691	M.2.3	63675	1341701	A.29.23
63447	2077837	A.12.2	63548	1317682	A.7.3	63587	1343283	M.2.3	63676	1341702	A.29.23
63447	1431781	A.12.2	63548	1433063	A.7.3	63589	1759690	M.2.3	63677	1472739	C.2.5
63447	1391322	A.12.2	63549	1328995	A.7.4	63589	1343266	M.2.3	63677	1420005	C.2.5
63447	243460	A.12.2	63550	1440359	A.5.8	63591	1375228	M.2.5	63677	1472739	N.40.2
63447	2077837	C.2.8	63550	1339877	A.5.8	63593	1378882	N.30.6	63677	1420005	N.40.2
63447	1431781	C.2.8	63550	1437123	A.5.8	63594	1378883	N.30.7	63678	550537	C.1.5
63447	1391322	C.2.8	63554	1484765	A.7.4	63594	1120398	N.30.7	63680	1893533	I.56.5
63447	243460	C.2.8	63554	1352885	A.7.4	63594	1365170	N.30.7	63680	1730221	I.56.5
63447	2077837	H.8.2	63554	1484765	C.1.8	63598	355223	N.30.7	63680	1780585	I.56.5
63447	1431781	H.8.2	63554	1352885	C.1.8	63599	1308474	N.1.7	63680	1851989	I.56.5
63447	1391322	H.8.2	63555	1484766	A.7.5	63600	1308473	N.1.7	63680	588002	I.56.5
63447	243460	H.8.2	63555	1352866	A.7.5	63601	1377231	A.27.9	63683	550550	H.6.5
63447	2077837	J.3.1	63555	1484766	C.1.8	63601	1377231	C.8.3	63684	63684	H.6.6
63447	1431781	J.3.1	63555	1352866	C.1.8	63602	1341729	A.27.9	63700	1478502	L.1.4
63447	1391322	J.3.1	63556/1	1377739	L.1.5	63604	1488066	J.3.3	63700	1377056	L.1.4
63447	243460	J.3.1	63556/1	1103026	L.1.5	63604	353621	J.3.3	63708	550247	A.5.9
			63556/2	63556/2	L.1.6	63608	370640	J.6.1	63712	1442706	I.7.3
			63558	551356	A.5.2	63617	470391	M.1.2	63712	1346377	I.7.3
			63559	1349497	A.7.6				63718	1393640	A.5.11

ALL THE COMPONENTS LISTED IN OUR CATALOGUE ARE NOT ORIGINAL, THOUGH PERFECTLY INTERCHANGEABLE. REFERENCE NUMBERS, EITHER ORIGINAL OR OF A DIFFERENT NATURE, ARE FOR INFORMATION PURPOSES ONLY. WHEN PLACING AN ORDER, PLEASE, ALWAYS USE COSIBO REFERENCE NUMBERS AND DO NOT MENTION THE ORIGINAL REFERENCE NUMBERS OF THE TRUCK MANUFACTURERS IN THE INVOICE TO VEHICLE OWNERS OR TO ANYBODY ELSE. THE CUSTOMER TAKES HIS OWN RESPONSIBILITY IF HE DOES NOT COMPLY WITH WHAT ABOVE.

Cross reference COSIBO - SCANIA

COSIBO	Replacing	Page	COSIBO	Replacing	Page	COSIBO	Replacing	Page	COSIBO	Replacing	Page
63733	1355655	I.56.3	63794	63794	A.23.10	63866	1742920	J.2.1	63921	1928763	A.13.15
63739	581201	I.7.12	63795	63795	A.23.11	63866	1323416	J.2.1	63921	1381070	A.13.15
63746	346568	J.8.5	63797	1732782	I.7.10	63867	1797845	C.8.5	63921	1541368	A.13.15
63747	383523	J.8.6	63797	1346381	I.7.10	63867	1370488	C.8.5	63922	2138380	A.13.16
63749	304332	D.1.3	63800	1366141	I.7.11	63873	1780108	J.8.9	63922	1850826	A.13.16
63750	1313606	A.2.5	63801	1396541	I.7.12	63873	1343149	J.8.9	63922	1503932	A.13.16
63750	168248	A.2.5	63802	202288	F.2.5	63873	1459188	J.8.9	63923	1928760	A.13.16
63753	1411774	H.2.1	63803	395432	E.2.1	63878	1892047	N.30.11	63923	1520701	A.13.16
63754	63754	C.2.1	63804	1367027	A.8.4	63878	1530690	N.30.11	63923	1793583	A.13.16
63755	1364636	C.2.2	63808	63808	J.8.8	63879	1892051	G.3.1	63923	1863897	A.13.16
63757	280651	H.13.3	63809	1402449	N.30.2	63879	1530696	G.3.1	63924	1928761	A.13.16
63759	1377386	C.7.6	63811	63811	J.8.8	63879	1892051	N.30.12	63924	1520702	A.13.16
63759	1317885	C.7.6	63812	63812	L.2.20	63879	1530696	N.30.12	63924	1793584	A.13.16
63761	1525891	J.2.5	63813	63813	L.2.20	63882	1541106	J.2.1	63924	1863898	A.13.16
63761	1337957	J.2.5	63814	63814	L.2.21	63882	1431178	J.2.1	63925	63925	A.13.14
63764	1923585	H.14.2	63844	1379621	C.7.15	63885	1754943	B.1.4	63926	1431979	A.24.2
63764	1372154	H.14.2	63845	1472771	C.7.16	63885	1545626	B.1.4	63927	1744211	J.8.9
63764	1333735	H.14.2	63845	1472879	C.7.16	63886	1873016	A.30.2	63929	1388070	A.21.10
63765	1923586	H.14.2	63846	1341683	B.2.13	63886	1459762	A.30.2	63929	1388070	B.8.1
63765	1372155	H.14.2	63847	1452862	A.12.2	63893	1789568	H.13.11	63929	1388070	H.6.9
63765	1341069	H.14.2	63847	1393113	A.12.2	63893	1358635	H.13.11	63930	365162	O.2.7
63767	1433183	A.10.3	63847	1488340	A.12.2	63894	1789567	H.13.10	63930	1331139	O.2.7
63767	1375002	A.10.3	63847	1452862	N.30.8	63894	1358634	H.13.10	63930	312354	O.2.7
63769	1861118	L.1.2	63847	1393113	N.30.8	63896	1403823	A.1.7	63930	365160	O.2.7
63769	1388417	L.1.2	63847	1488340	N.30.8	63898	552004	F.5.2	63931	550469	A.4.4
63769	1420474	L.1.2	63852	1399180	L.5.1	63898	552004	L.2.1	63933	1468555	A.3.3
63769	1421062	L.1.2	63852	1338769	L.5.1	63913	1442292	I.48.11	63934	1800527	A.23.9
63769	1861117	L.1.2	63853	1411851	A.8.4	63914	1442293	I.48.12	63934	1490821	A.23.9
63777	63777	A.13.12	63854	1401984	A.8.4	63915	1732507	N.1.6	63934	1800527	J.5.1
63778	1364290	A.33.8	63855	1414422	A.8.5	63915	1348539	N.1.6	63934	1490821	J.5.1
63779	1374413	H.2.1	63856	1375839	A.26.4	63915	1431255	N.1.6	63938	1427794	J.1.3
63779	1360069	H.2.1	63856	571154	A.26.4	63915	1446585	N.1.6	63942	1541984	J.1.4
63780	1354420	A.13.12	63858	2197003	A.23.1	63915	1467001	N.1.6	63942	1427793	J.1.4
63781	1340899	A.13.13	63858	1859655	A.23.1	63916	1732508	N.1.6	63952	1439171	A.7.14
63782	1354428	A.13.13	63858	1476395	A.23.1	63916	1348540	N.1.6	63953	1448933	A.7.15
63783	1355353	A.13.13	63858	1503114	A.23.1	63916	1431254	N.1.6	63954	1382072	A.29.23
63784	1422198	A.13.13	63858	1545983	A.23.1	63916	1446586	N.1.6	63954	1313678	A.29.23
63784	1354423	A.13.13	63858	1774652	A.23.1	63916	1467002	N.1.6	63955	1382073	A.29.24
63785	1422200	A.13.13	63860	1732783	I.7.10	63917	1401931	I.50.4	63955	1313679	A.29.24
63785	1354424	A.13.13	63860	1346382	I.7.10	63918	1371754	I.50.4	63956	1382074	A.29.24
63786	1412398	A.22.2	63862	1746684	A.13.5	63919	1928759	A.13.15	63956	1313680	A.29.24
63786	1402869	A.22.2	63862	1392459	A.13.5	63919	1520700	A.13.15	63957	1313681	A.29.24
63791	1865749	H.13.7	63863	390918	A.13.6	63919	1793582	A.13.15	63958	1313682	A.29.24
63791	1448116	H.13.7	63864	2123147	A.32.2	63919	1863896	A.13.15	63959	1313683	A.29.25
63791	362044	H.13.7	63864	1481301	A.32.2	63920	1928762	A.13.15	63960	1517650	I.55.14
63792	1448117	H.13.8	63864	2061500	A.32.2	63920	1381069	A.13.15	63960	1429394	I.55.14
63792	362045	H.13.8	63865	550553	H.6.5	63920	1541367	A.13.15	63961	1517649	I.55.14
63793	1881850	C.2.8							63961	1429393	I.55.14

ALL THE COMPONENTS LISTED IN OUR CATALOGUE ARE NOT ORIGINAL, THOUGH PERFECTLY INTERCHANGEABLE. REFERENCE NUMBERS, EITHER ORIGINAL OR OF A DIFFERENT NATURE, ARE FOR INFORMATION PURPOSES ONLY. WHEN PLACING AN ORDER, PLEASE, ALWAYS USE COSIBO REFERENCE NUMBERS AND DO NOT MENTION THE ORIGINAL REFERENCE NUMBERS OF THE TRUCK MANUFACTURERS IN THE INVOICE TO VEHICLE OWNERS OR TO ANYBODY ELSE. THE CUSTOMER TAKES HIS OWN RESPONSIBILITY IF HE DOES NOT COMPLY WITH WHAT ABOVE.

Cross reference COSIBO - SCANIA

COSIBO	Replacing	Page	COSIBO	Replacing	Page	COSIBO	Replacing	Page	COSIBO	Replacing	Page
63962	1496659	I.35.1	64026	1366764	I.48.12	64082	813933	H.60.1	64091	813936	H.50.3
63962	1387870	I.35.1	64027	1738098	J.5.4	64082	813933	I.105.1	64091	813936	I.105.4
63963	1411129	H.6.9	64027	1425070	J.5.4	64082	813933	L.60.1	64091	813936	L.60.2
63963	1384116	H.6.9	64028	1424074	A.32.4	64082	813933	O.2.1	64091	813936	M.30.3
63964	1725664	I.54.11	64028	1373479	A.32.4	64083	813935	A.105.1	64091	813936	O.2.3
63965	1725663	I.54.11	64031	1358497	G.2.1	64083	813935	C.50.1	64092	813938	A.105.5
63966	1888464	A.23.6	64032	1365594	G.2.2	64083	813935	H.50.1	64092	813938	B.50.2
63966	1389029	A.23.6	64033	1873183	G.2.1	64083	813935	I.105.1	64092	813938	C.50.3
63966	1454281	A.23.6	64033	1403618	G.2.1	64083	813935	L.60.1	64092	813938	H.50.3
63966	1800522	A.23.6	64034	1374500	A.22.8	64083	813935	O.2.1	64092	813938	I.105.4
63967	1800539	A.23.7	64036	550282	L.3.1	64084	813937	A.105.2	64092	813938	L.60.2
63967	1530981	A.23.7	64049	1331164	J.4.1	64084	813937	B.50.1	64092	813938	M.30.3
63968	1420911	A.23.8	64050	376283	I.48.1	64084	813937	C.50.1	64092	813938	O.2.3
63969	1888465	A.23.7	64051	376284	I.48.1	64084	813937	H.50.1	64093	813940	A.105.5
63969	1514865	A.23.7	64052	1318506	J.2.7	64084	813937	I.105.1	64093	813940	B.50.2
63969	1800533	A.23.7	64053	1858661	J.2.7	64084	813937	L.60.1	64093	813940	C.50.3
63987	1523607	I.54.10	64053	1392755	J.2.7	64084	813937	M.30.1	64093	813940	H.50.3
63988	1523608	I.54.10	64054	1849428	A.21.20	64084	813937	O.2.1	64093	813940	I.105.5
63991	1382075	A.29.26	64054	1757490	A.21.20	64085	813939	A.105.2	64093	813940	L.60.2
63991	1302530	A.29.26	64054	1874363	A.21.20	64085	813939	C.50.2	64093	813940	O.2.4
63992	1302531	A.29.26	64058	1870001	A.16.8	64085	813939	H.50.1	64094	813942	A.105.5
63994	561991	A.5.12	64058	1387542	A.16.8	64085	813939	I.105.2	64094	813942	C.50.3
63997	1386227	L.7.7	64058	1801772	A.16.8	64085	813939	M.30.2	64094	813942	I.105.5
63998	1474065	L.7.3	64060	1481371	J.4.1	64085	813939	O.2.2	64094	813942	O.2.4
63999	804690	L.7.3	64061	1444016	J.9.4	64086	813941	A.105.3	64095	804578	A.105.6
64000	1357628	A.29.29	64061	312465	J.9.4	64086	813941	C.50.2	64095	804578	B.50.2
64000	1357633	A.29.29	64062	1369553	J.4.2	64086	813941	H.50.2	64095	804578	C.50.3
64001	1789305	I.48.1	64064	1340860	H.12.1	64086	813941	I.105.2	64095	804578	I.105.5
64001	1406223	I.48.1	64065	1340859	H.12.1	64086	813941	M.30.2	64095	804578	L.60.2
64002	1789306	I.48.1	64066	1858884	A.23.4	64086	813941	O.2.2	64095	804578	M.30.3
64002	1406224	I.48.1	64066	1510698	A.23.4	64087	1355703	A.8.7	64095	804578	O.2.4
64003	1343262	M.2.6	64066	1795774	A.23.4	64088	1321727	H.13.1	64096	804589	A.105.6
64006	1545149	A.33.12	64067	1383496	J.8.8	64089	813932	A.105.3	64096	804589	H.50.4
64006	1421621	A.33.12	64068	1726130	L.2.1	64089	813932	H.50.2	64096	804589	I.105.6
64007	1722828	A.33.13	64068	1384353	L.2.1	64089	813932	I.105.3	64097	1379922	B.3.3
64008	1549482	A.26.4	64069	199846	I.56.2	64089	813932	O.2.2	64098	1302914	B.3.4
64008	1433792	A.26.4	64070	1361131	H.8.3	64090	813934	A.105.4	64099	1370141	L.4.1
64008	1510404	A.26.4	64070	1361131	L.6.1	64090	813934	B.50.1	64100	804583	A.105.6
64008	1549481	A.26.4	64071	1461414	C.4.1	64090	813934	C.50.2	64100	804583	C.50.4
64008	570958	A.26.4	64071	1114622	C.4.1	64090	813934	F.50.1	64100	804583	H.50.4
64009	1335674	A.16.8	64072	1781929	J.8.15	64090	813934	H.50.2	64100	804583	I.105.6
64016	1431701	A.16.9	64072	1343131	J.8.15	64090	813934	I.105.3	64100	804583	M.30.4
64016	1431701	H.4.4	64074	358404	C.3.5	64090	813934	L.60.1	64100	804583	O.2.5
64017	1439822	A.21.12	64080	378613	C.3.5	64090	813934	O.2.3	64101	804591	A.105.7
64022	1374326	A.9.2	64081	1350394	A.27.16	64091	813936	A.105.4	64101	804591	H.50.4
64023	1346177	I.48.4	64082	813933	A.105.1	64091	813936	B.50.1	64101	804591	I.105.6
64024	1346178	I.48.5	64082	813933	C.50.1	64091	813936	C.50.2	64101	804591	O.2.5
64025	1346119	I.48.12	64082	813933	F.50.1	64091	813936	F.50.1			

ALL THE COMPONENTS LISTED IN OUR CATALOGUE ARE NOT ORIGINAL, THOUGH PERFECTLY INTERCHANGEABLE. REFERENCE NUMBERS, EITHER ORIGINAL OR OF A DIFFERENT NATURE, ARE FOR INFORMATION PURPOSES ONLY. WHEN PLACING AN ORDER, PLEASE, ALWAYS USE COSIBO REFERENCE NUMBERS AND DO NOT MENTION THE ORIGINAL REFERENCE NUMBERS OF THE TRUCK MANUFACTURERS IN THE INVOICE TO VEHICLE OWNERS OR TO ANYBODY ELSE. THE CUSTOMER TAKES HIS OWN RESPONSIBILITY IF HE DOES NOT COMPLY WITH WHAT ABOVE.

Cross reference COSIBO - SCANIA

COSIBO	Replacing	Page	COSIBO	Replacing	Page	COSIBO	Replacing	Page	COSIBO	Replacing	Page
64102	1520867	J.10.1	64141	2010938	A.7.13	64184	1424970	N.30.2	64246	1737306	B.3.1
64102	1366836	J.10.1	64141	1795526	A.7.13	64184	1402450	N.30.2	64246	1545625	B.3.1
64102	1441240	J.10.1	64141	1774202	A.7.13	64185	1859657	A.23.2	64247	1104545	H.40.1
64103	1871043	A.5.10	64142	1746135	A.7.8	64185	1774654	A.23.2	64247	1104549	H.40.1
64103	1376911	A.5.10	64143	381235	A.7.22	64186	1765382	M.2.6	64248	1104544	H.40.1
64103	1871043	H.7.1	64144	1351692	A.7.22	64187	814195	A.23.10	64248	1104548	H.40.1
64103	1376911	H.7.1	64145	1539675	A.5.15	64187	814195	N.31.2	64249	1115287	H.5.4
64104	1535052	I.30.9	64152	1755638	J.8.12	64188	551477	A.26.8	64251	1858885	A.23.4
64105	1805447	I.30.10	64156	1392261	A.22.3	64189	1380814	L.5.2	64251	1510697	A.23.4
64105	1535048	I.30.10	64156	1393424	A.22.3	64189	322368	L.5.2	64251	1512749	A.23.4
64106	64106	I.54.10	64161	1405402	C.7.9	64190	64190	A.7.23	64251	1795775	A.23.4
64107	64107	I.54.10	64162	1405406	C.7.9	64197	1466382	A.5.14	64252	1792374	N.3.6
64110	1549741	J.1.2	64163	233275	G.2.13	64197	1456041	A.5.14	64253	1792375	N.3.6
64110	1477877	J.1.2	64164	1120873	G.2.13	64201	1755901	H.9.1	64254	1342748	H.12.3
64111	1368039	J.8.10	64165	1336380	G.2.14	64202	1774872	H.9.1	64255	1342747	H.12.3
64112	1350440	O.2.5	64166	1736562	G.2.14	64202	1763421	H.9.1	64255	330655	H.12.3
64113	1350441	O.2.5	64166	1363673	G.2.14	64203	2149696	N.30.20	64258	1449771	J.5.5
64114	1355667	I.56.1	64167	1354103	A.26.5	64203	1787155	N.30.20	64260	1342745	H.12.2
64117	1431199	L.7.7	64167	571150	A.26.5	64203	1862890	N.30.20	64261	1342746	H.12.2
64117	1357942	L.7.7	64168	1348121	J.9.1	64204	1795464	J.5.3	64262	1862798	A.16.4
64117	1380324	L.7.7	64169	1723519	I.7.6	64204	1450166	J.5.3	64262	1784636	A.16.4
64117	1390097	L.7.7	64170	1723518	I.7.7	64204	1789068	J.5.3	64263	1757903	A.10.3
64118	2081360	A.14.2	64171	1916864	I.7.14	64206	2000090	J.8.17	64270	2171712	J.8.6
64118	1384549	A.14.2	64171	1484078	I.7.14	64206	1386424	J.8.17	64271	2171712	J.8.7
64118	1774598	A.14.2	64171	1484076+	I.7.14	64207	1543608	I.55.11	64273	551560	A.5.2
64118	2081360	H.6.8		1484078		64208	1543609	I.55.12	64273	551526	A.5.2
64118	1774598	H.6.8	64172	1916864	I.7.15	64209	1913500	J.5.7	64274	551573	A.4.4
64119	64119	O.1.1	64172	1484079	I.7.15	64209	1770813	J.5.7	64275	551570	A.4.5
64121	1800535	A.23.7	64172	1484076+	I.7.15	64210	345083	H.5.2	64275	550270	A.4.5
64121	1354390	A.23.7		1484079		64213	1364102	I.35.1	64276	1425921	A.8.3
64121	1519788	A.23.7	64173	1916864	I.7.13	64214	1364103	I.35.1	64277	1437296	A.16.4
64121	1530973	A.23.7	64173	1484076	I.7.13	64226	1466383	A.7.8	64277	1349714	A.16.4
64121	1803332	A.23.7	64174	1484081	I.7.14	64226	1423202	A.7.8	64277	366557	A.16.4
64122	1756460	B.1.5	64175	550578	C.1.7	64228	1491408	C.2.7	64278	1336138	A.13.6
64122	1355979	B.1.5	64175	550540	C.1.7	64228	1397851	C.2.7	64278	1485685	A.13.6
64122	1532517	B.1.5	64177	1731130	N.30.8	64228	1491408	N.30.12	64285	1422499	A.27.4
64123	1789522	A.26.4	64178	1475750	N.30.5	64228	1397851	N.30.12	64286	1493708	C.8.2
64123	1546188	A.26.4	64178	1387022	N.30.5	64232	1509813	A.7.9	64286	1450536	C.8.2
64123	570964	A.26.4	64180	1741027	J.3.3	64232	1467166	A.7.9	64288	1375601	A.27.2
64129	64129	A.14.6	64180	1503790	J.3.3	64240	1865317	A.14.15	64288	1358384	A.27.2
64130	64130	A.14.7	64181	1895479	A.2.1	64240	1788333	A.14.15	64291	1377993	C.8.3
64131	64131	A.14.8	64181	1849151	A.2.1	64240	1865317	N.30.20	64292	1387044	C.8.2
64132	390684	O.1.1	64182	813245	O.1.2	64240	1788333	N.30.20	64293	1367972	C.8.2
64134	1327015	J.3.3	64183	1888468	A.23.10	64243	1879484	A.26.5	64294	1511620	A.27.4
64137	1502798	A.7.6	64183	1389024	A.23.10	64243	1549027	A.26.5	64294	1494718	A.27.4
64137	1433886	A.7.6	64183	1389048	A.23.10	64244	1369975	C.7.6	64295	1385836	J.1.12
64138	64138	A.7.9	64183	1490819	A.23.10	64245	1723518	I.7.6	64295	1380264	J.1.12
64140	64140	A.7.10	64183	1800531	A.23.10	64245	1732782	I.7.6			

ALL THE COMPONENTS LISTED IN OUR CATALOGUE ARE NOT ORIGINAL, THOUGH PERFECTLY INTERCHANGEABLE. REFERENCE NUMBERS, EITHER ORIGINAL OR OF A DIFFERENT NATURE, ARE FOR INFORMATION PURPOSES ONLY. WHEN PLACING AN ORDER, PLEASE, ALWAYS USE COSIBO REFERENCE NUMBERS AND DO NOT MENTION THE ORIGINAL REFERENCE NUMBERS OF THE TRUCK MANUFACTURERS IN THE INVOICE TO VEHICLE OWNERS OR TO ANYBODY ELSE. THE CUSTOMER TAKES HIS OWN RESPONSIBILITY IF HE DOES NOT COMPLY WITH WHAT ABOVE.

Cross reference COSIBO - SCANIA

COSIBO	Replacing	Page	COSIBO	Replacing	Page	COSIBO	Replacing	Page	COSIBO	Replacing	Page
64296	1532223	J.1.12	64343	1738379	F.5.1	64378	1527913	A.2.4	64409	1328242	A.5.13
64296	1425599	J.1.12	64343	1357674	F.5.1	64378	1487566	A.2.4	64409	1328242	C.3.6
64297	288893	J.1.12	64343	1738379	M.2.5	64379	64379	A.13.26	64409	1328242	H.5.9
64298	2035104	I.56.4	64343	1357674	M.2.5	64380	1870000	A.16.9	64410	1304914	A.5.11
64298	1910437	I.56.4	64344	1732322	I.30.7	64382	1372174	I.56.4	64410	1304914	C.3.7
64298	1798980	I.56.4	64344	1529885	I.30.7	64385	64385	A.7.10	64410	1304914	H.5.8
64299	2035105	I.56.4	64345	1529886	I.30.7	64386	64386	A.7.10	64411	1349018	A.5.12
64299	1910438	I.56.4	64346	1420908	A.23.8	64389	1362693	I.54.12	64411	1349018	C.3.7
64299	1798981	I.56.4	64346	1372545	A.23.8	64390	1869992	A.16.6	64411	1349018	H.5.9
64301	1342708	G.2.12	64347	1549330	A.31.1	64391	1476532	I.45.1	64412	1471133	C.7.16
64304	1472738	C.2.5	64347	1376871	A.31.1	64391	1452667	I.45.1	64413	1749126	B.2.13
64304	1472738	E.3.1	64348	64348	I.56.4	64392	1476533	I.45.1	64414	1892068	N.30.13
64304	1472738	F.4.1	64349	1732856	I.54.9	64392	1452668	I.45.1	64414	1530703	N.30.13
64304	1472738	N.40.2	64350	1732855	I.54.9	64393	1476534	I.45.2	64415	1804210	H.11.1
64306	1725112	A.4.5	64351	1392708	A.11.3	64394	1476535	I.45.2	64415	1761517	H.11.1
64307	1403883	A.26.2	64353	1927829	B.1.3	64395	64395	A.7.11	64417	1821737	H.4.2
64307	1353010	A.26.2	64353	1523400	B.1.3	64396	2003505	A.29.2	64417	1507790	H.4.2
64309	550283	L.3.1	64353	1800442	B.1.3	64396	1794863	A.29.2	64418	1892054	N.30.13
64310	2146105	E.2.1	64354	1923599	H.14.3	64397	1757877	A.21.10	64418	1530700	N.30.13
64310	2040254	E.2.1	64354	1452542	H.14.3	64397	1344182	A.21.10	64419	1892049	N.30.14
64310	1361413	E.2.1	64355	1733735	A.27.14	64397	1117597	A.21.10	64419	1530693	N.30.14
64310	1395614	E.2.1	64356	1790071	A.27.14	64397	1328597	A.21.10	64420	2131819	A.16.5
64310	1734019	E.2.1	64356	1790071	J.1.11	64397	313228	A.21.10	64420	1784637	A.16.5
64310	1897333	E.2.1	64357	1325383	C.7.8	64397	1757877	D.2.3	64420	1862799	A.16.5
64311	550577	C.1.7	64358	1433190	A.16.11	64397	1344182	D.2.3	64421	1904343	N.40.2
64312	1549495	C.1.4	64358	1433190	H.4.4	64397	1117597	D.2.3	64421	1396644	N.40.2
64312	1329586	C.1.4	64362	1459146	I.50.11	64397	1328597	D.2.3	64422	1790840	J.5.5
64313	1424601	N.30.9	64363	1903797	C.6.5	64397	313228	D.2.3	64422	1446258	J.5.5
64314	550533	C.1.4	64364	1804628	I.50.11	64397	1757877	F.2.6	64422	1782207	J.5.5
64318	1800470	I.50.9	64364	1746585	I.50.11	64397	1344182	F.2.6	64423	1898019	B.2.9
64318	1720616	I.50.9	64368	1346181	I.48.4	64397	1117597	F.2.6	64423	574908	B.2.9
64319	1800469	I.50.8	64369	1425659	I.48.4	64397	1328597	F.2.6	64425	64425	B.2.12
64319	1720615	I.50.8	64370	1541083	A.32.4	64397	313228	F.2.6	64426	1439462	I.7.13
64320	1815227	I.50.12	64370	1423990	A.32.4	64398	64398	A.7.11	64427	1439463	I.7.12
64320	1722438	I.50.12	64371	375350	J.1.7	64400	1862892	A.14.14	64428	1769912	I.45.3
64328	1733181	N.1.9	64371	575171	J.1.7	64400	1862892	N.30.12	64428	1406466	I.45.3
64329	1856473	I.55.13	64373	1864620	J.2.1	64401	1471738	N.30.13	64429	1769911	I.45.3
64329	1496293	I.55.13	64373	1380034	J.2.1	64402	1424853	A.16.9	64429	1406465	I.45.3
64330	1856472	I.55.14	64373	1431177	J.2.1	64403	1424854	A.16.10	64433	1865517	I.48.9
64330	1496294	I.55.14	64373	1543076	J.2.1	64404	1446910	A.16.10	64433	1865519	I.48.9
64331	64331	B.2.6	64373	1751403	J.2.1	64405	1928587	H.8.3	64437	1541984	J.1.4
64332	64332	C.7.11	64374	1530783	A.22.7	64405	1763423	H.8.3	64437	1427794	J.1.4
64335	1765829	D.2.3	64375	1387547	A.16.8	64406	2051700	A.5.12	64438	1923617	H.14.3
64335	1879538	D.2.3	64376	1804034	A.26.9	64406	1921327	A.5.12	64438	1371717	H.14.3
64340	64340	B.3.1	64376	1522518	A.26.9	64407/1	1903798	C.6.7	64439	1782290	J.8.7
64343	1738379	E.2.4	64377	1810345	J.8.15	64408	804664	A.5.13	64444	2021085	N.30.19
64343	1357674	E.2.4	64377	1519436	J.8.15	64408	804664	C.3.6	64444	1744081	N.30.19
						64408	804664	M.5.2	64444	1856310	N.30.19

ALL THE COMPONENTS LISTED IN OUR CATALOGUE ARE NOT ORIGINAL, THOUGH PERFECTLY INTERCHANGEABLE. REFERENCE NUMBERS, EITHER ORIGINAL OR OF A DIFFERENT NATURE, ARE FOR INFORMATION PURPOSES ONLY. WHEN PLACING AN ORDER, PLEASE, ALWAYS USE COSIBO REFERENCE NUMBERS AND DO NOT MENTION THE ORIGINAL REFERENCE NUMBERS OF THE TRUCK MANUFACTURERS IN THE INVOICE TO VEHICLE OWNERS OR TO ANYBODY ELSE. THE CUSTOMER TAKES HIS OWN RESPONSIBILITY IF HE DOES NOT COMPLY WITH WHAT ABOVE.

Cross reference COSIBO - SCANIA

COSIBO	Replacing	Page	COSIBO	Replacing	Page	COSIBO	Replacing	Page	COSIBO	Replacing	Page
64446	1787032	C.7.9	64658	1438564	N.4.5	64699	1431934	I.52.2	64771	1782741	A.33.11
64448	1793197	J.3.3	64659	1438563	N.4.4	64700	1512423	I.30.2	64771	1420480	A.33.11
64493	353623	J.3.4	64660	1936675	N.4.3	64701	1512424	I.30.2	64775	1439825	A.21.1
64497	1868087	G.2.4	64660	1431921	N.4.3	64702	1442653	I.30.2	64777	1373126	A.21.19
64497	1439070	G.2.4	64660	1790007	N.4.3	64703	1442654	I.30.3	64778	1331820	A.21.19
64497	1476945	G.2.4	64661	1936674	N.4.3	64704	1431931	I.52.2	64778	1331820	C.1.9
64497	1724482	G.2.4	64661	1431920	N.4.3	64706	1748086	I.50.6	64778	1331820	F.2.6
64498	339129	C.7.4	64661	1790006	N.4.3	64707	1431932	I.52.2	64790	804670	A.28.5
64498/2	64498/2	C.7.4	64662	1439789	I.51.2	64708	1779120	I.30.3	64790	804670	C.7.17
64509	1395994	J.2.6	64663	1439788	I.51.1	64708	1486647	I.30.3	64790	804670	E.1.3
64509	353546	J.2.6	64664	1731206	I.51.1	64709	1779121	I.30.3	64790	804670	L.8.1
64522	294271	D.1.1	64664	1422843	I.51.1	64709	1486648	I.30.3	64791	1373793	L.2.9
64522/1	294270	D.1.1	64665	1483281	A.33.4	64711	1549737	J.1.8	64795	1796026	N.30.9
64524	1113031	D.1.2	64665	1445925	A.33.4	64711	1477876	J.1.8	64795	1447911	N.30.9
64631	64631	A.21.6	64669	1746246	N.1.8	64720	1762224	G.2.3	64795	571467	N.30.9
64632	64632	A.21.6	64672	1786692	N.1.2	64721	1375390	M.5.1	64795	579265	N.30.9
64633	1387764	D.1.2	64672	1523881	N.1.2	64722	1722694	J.2.6	64797	1515119	C.7.7
64634	1387794	D.1.2	64673	1786693	N.1.2	64722	1506330	J.2.6	64797	1427669	C.7.7
64639	1498102	N.3.6	64673	1523882	N.1.2	64723	1375382	G.2.18	64800	1349089	H.12.4
64640	1498103	N.3.6	64674	1523508	I.51.2	64723	1339680	G.2.18	64801	1794440	H.13.4
64641	1504602	N.3.4	64675	1523509	I.51.2	64725	1387609	I.32.1	64801	1731309	H.13.4
64642	1504603	N.3.4	64676	1466031	I.50.5	64726	1548055	L.2.5	64802	1540426	M.1.2
64643	1725675	I.54.8	64677	1466032	I.50.5	64726	1338491	L.2.5	64803	1854876	J.5.2
64644	1725676	I.54.9	64678	1727263	I.50.7	64727	1345206	M.2.7	64804	1779202	J.5.3
64645	1375838	A.26.6	64679	1727264	I.50.7	64730	64730	G.2.9	64804	1323821	J.5.3
64645	571153	A.26.6	64680	1856475	I.55.12	64738	64738	L.2.13	64805	1846702	J.5.4
64646	1110588	L.1.1	64680	1495956	I.55.12	64739	64739	L.2.12	64805	1437263	J.5.4
64646	1111056	L.1.1	64680	1749716	I.55.12	64740	1800871	A.33.2	64806	1378541	A.12.4
64646	395063	L.1.1	64680	1798863	I.55.12	64740	1484094	A.33.2	64807	1420500	N.30.14
64647	1486148	A.22.6	64681	1856474	I.55.13	64741	1502468	J.9.4	64808	1457303	N.30.14
64647	1434106	A.22.6	64681	1495957	I.55.13	64742	1505748	A.33.4	64809	1457304	N.30.15
64648	1332193	A.22.4	64681	1749717	I.55.13	64742	1497653	A.33.4	64810	1471743	N.30.15
64649	1440406	A.22.8	64681	1798864	I.55.13	64743	1505563	J.9.2	64811	1471747	N.30.15
64650	1725671	I.54.8	64682	1805399	I.50.6	64745	1482079	I.51.5	64812	1884529	N.30.16
64650	1400899	I.54.8	64682	1541484	I.50.6	64746	1482080	I.51.6	64812	1482003	N.30.16
64650	1457895	I.54.8	64683	1300831	N.1.10	64747	1482078	I.51.5	64813	1892060	G.3.1
64651	1725672	I.54.8	64683	370990	N.1.10	64748	64748	A.5.13	64813	1530709	G.3.1
64651	1400900	I.54.8	64684	64684	I.56.3	64749	551520	A.5.1	64813	2765315	G.3.1
64651	1457896	I.54.8	64686	1548318	C.7.10	64749	551505	A.5.1	64813	1892060	N.30.16
64653	1747981	N.2.1	64686	1412052	C.7.10	64750	1849922	A.5.2	64813	1530709	N.30.16
64653	1521683	N.2.1	64691	1459133	I.50.5	64751	1488658	A.5.3	64813	2765315	N.30.16
64654	1727992	N.4.3	64692	1459134	I.50.5	64757	1801736	A.13.14	64814	1539313	N.30.16
64654	1438558	N.4.3	64693	1459135	I.50.5	64757	1424924	A.13.14	64815	1862891	N.30.16
64655	1727991	N.4.2	64694	1459141	I.50.10	64763	1488557	A.33.5	64815	1854601	N.30.16
64655	1438557	N.4.2	64695	1459142	I.50.10	64764	1483278	A.33.5	64816	1862895	N.30.17
64656	1431923	N.4.4	64696	1459145	I.50.6	64764	1397052	A.33.5	64816	1539110	N.30.17
64657	2124015	N.4.4	64697	1748085	I.50.6	64770	1431579	A.33.10	64817	1892048	N.30.17
64657	1431922	N.4.4	64698	1431933	I.52.1				64817	1530792	N.30.17

ALL THE COMPONENTS LISTED IN OUR CATALOGUE ARE NOT ORIGINAL, THOUGH PERFECTLY INTERCHANGEABLE. REFERENCE NUMBERS, EITHER ORIGINAL OR OF A DIFFERENT NATURE, ARE FOR INFORMATION PURPOSES ONLY. WHEN PLACING AN ORDER, PLEASE, ALWAYS USE COSIBO REFERENCE NUMBERS AND DO NOT MENTION THE ORIGINAL REFERENCE NUMBERS OF THE TRUCK MANUFACTURERS IN THE INVOICE TO VEHICLE OWNERS OR TO ANYBODY ELSE. THE CUSTOMER TAKES HIS OWN RESPONSIBILITY IF HE DOES NOT COMPLY WITH WHAT ABOVE.

Cross reference COSIBO - SCANIA

COSIBO	Replacing	Page	COSIBO	Replacing	Page	COSIBO	Replacing	Page	COSIBO	Replacing	Page
64818	1892053	E.2.5	64854	1450153	A.26.2	65075	184808	F.2.4	65140	1391796	A.27.5
64818	1530699	E.2.5	64854	1376495	A.26.2	65088	1335618	A.33.1	65141	1391795	A.27.6
64818	1892053	G.3.1	64855	1905884	B.1.3	65089	550567	H.6.6	65142	1385086	A.27.12
64818	1530699	G.3.1	64855	1755194	B.1.3	65089/2	65089/2	H.6.7	65143	1529007	A.27.13
64818	1892053	N.30.17	64856	1860195	B.1.3	65091	315085	C.4.1	65143	1377332	A.27.13
64818	1530699	N.30.17	64857	2057206	A.13.29	65091	315085	D.1.3	65143	1447198	A.27.13
64819	1892058	N.30.18	64857	1770297	A.13.29	65092	1525145	A.21.17	65144	1377331	A.27.13
64819	1530705	N.30.18	64858	1872122	H.5.4	65094	1888471	A.23.9	65145	1376949	A.27.13
64820	1892062	N.30.18	64858	1530826	H.5.4	65094	1530984	A.23.9	65145	1358296	A.27.13
64822	1795730	A.21.3	64858	1724430	H.5.4	65094	1800541	A.23.9	65146	1376294	A.27.6
64822	1531761	A.21.3	64858	1804829	H.5.4	65095	1800523	A.23.9	65146	1363545	A.27.6
64822	1766614	A.21.3	64859	353625	J.3.4	65095	1454282	A.23.9	65147	1376291	A.27.6
64822	1766617	A.21.3	64860	64860	G.2.13	65097	1502472	J.9.5	65149	1375604	A.27.7
64822	1769483	A.21.3	64861	1809771	A.21.18	65098	1510575	A.33.4	65149	1357342	A.27.7
64822	1790041	A.21.3	64862	1479758	I.50.9	65099	1794725	A.21.17	65150	1375603	A.27.13
64823	807351	C.7.10	64863	1479759	I.50.9	65102	2085863	B.2.10	65150	1357341	A.27.13
64823	1433099	C.7.10	64864	1787672	I.50.8	65102	1479575	B.2.10	65151/1	371780/1	A.28.2
64824	64824	C.7.10	64865	1801618	I.50.9	65102	571316	B.2.10	65151/2	371780	A.28.1
64825	1537771	J.5.6	64866	572950	B.2.12	65102	574911	B.2.10	65152	319792	A.28.2
64826	1346907	I.48.5	64867	2021084	H.6.4	65119	1392929	A.14.2	65153	367624	A.28.2
64827	1433667	A.33.6	64867	1756046	H.6.4	65119	371502	A.14.2	65154	269342	A.28.1
64828	1461416	H.6.10	64867	1856309	H.6.4	65122	1541549	C.8.3	65155/1	1307770	A.28.4
64828	1114314	H.6.10	64868	1356880	A.7.14	65122	1377997	C.8.3	65157	65157	A.32.2
64829	1461417	H.6.11	64998	2197007	A.23.2	65122	1512422	C.8.3	65163	361481	A.32.4
64829	1302791	H.6.11	64998	1859656	A.23.2	65124	1516491	A.21.2	65174	1360842	B.1.3
64832	1766909	A.22.1	64998	1545984	A.23.2	65124	1365371	A.21.2	65176	1350317	J.3.1
64832	1422502	A.22.1	64998	1774653	A.23.2	65124	1439504	A.21.2	65177	389035	B.1.6
64833	2132266	A.22.1	65001	1388680	A.11.1	65124	570482	A.21.2	65177	293152	B.1.6
64833	1453967	A.22.1	65001	1305341	A.11.1	65125	1373919	A.27.9	65177	389035	H.4.5
64833	1856995	A.22.1	65002	1522011	A.21.16	65127	1375859	A.27.5	65177	293152	H.4.5
64833	2052003	A.22.1	65002	1442579	A.21.16	65128	1376226	A.27.9	65178	1409551	B.1.6
64833/K	64833/K	A.22.1	65002	1522010	A.21.16	65129	1374040	A.27.10	65178	1391676	B.1.6
64834	2132264	A.22.3	65003	65003	C.6.6	65129	1374040	C.8.3	65178	1409551	H.4.5
64834	1763618	A.22.3	65008	164433	F.2.3	65130	1449431	A.27.10	65178	1391676	H.4.5
64839	64839	A.22.2	65016	1483280	A.33.5	65130	1376293	A.27.10	65179	283650	B.1.8
64842	1444948	A.27.3	65016	1405350	A.33.5	65131	1376895	A.27.10	65179	283650	C.2.10
64843	1525983	A.27.3	65021	1320602	A.21.4	65132	1545116	A.27.10	65179	283650	H.8.2
64844	1755951	A.27.3	65026	1923589	H.14.3	65132	1380621	A.27.10	65180	287379	C.7.12
64844	1446229	A.27.3	65026	1380880	H.14.3	65132	1448384	A.27.10	65181	287380	C.7.13
64845	1755953	A.27.3	65027	1805380	L.2.4	65132	1531776	A.27.10	65182	339141	C.7.13
64845	1446228	A.27.3	65027	1369806	L.2.4	65133	1376896	A.27.11	65182	248326	C.7.13
64846	1512485	H.6.2	65028	1377692	L.2.22	65134	1383873	A.27.11	65182	302948	C.7.13
64847	1506273	H.6.3	65028	1370142	L.2.22	65135	1383990	A.27.11	65183	1300097	C.7.13
64848	1729116	H.6.3	65036	372983	A.14.13	65136	1426194	A.27.12	65183	248325	C.7.13
64848	1516514	H.6.3	65073	1378527	J.1.2	65136	1375874	A.27.12	65183	339140	C.7.13
64850	1377996	C.8.2	65073	368926	J.1.2	65137	1395066	A.27.12	65184	349034	C.7.14
64853	1479872	A.5.14	65074	1378531	J.1.3	65137	1384464	A.27.12	65186	1853436	C.2.4
64853	1367849	A.5.14	65074	383524	J.1.3	65139	1392276	A.27.5	65186	1111459	C.2.4

ALL THE COMPONENTS LISTED IN OUR CATALOGUE ARE NOT ORIGINAL, THOUGH PERFECTLY INTERCHANGEABLE. REFERENCE NUMBERS, EITHER ORIGINAL OR OF A DIFFERENT NATURE, ARE FOR INFORMATION PURPOSES ONLY. WHEN PLACING AN ORDER, PLEASE, ALWAYS USE COSIBO REFERENCE NUMBERS AND DO NOT MENTION THE ORIGINAL REFERENCE NUMBERS OF THE TRUCK MANUFACTURERS IN THE INVOICE TO VEHICLE OWNERS OR TO ANYBODY ELSE. THE CUSTOMER TAKES HIS OWN RESPONSIBILITY IF HE DOES NOT COMPLY WITH WHAT ABOVE.

Cross reference COSIBO - SCANIA

COSIBO	Replacing	Page	COSIBO	Replacing	Page	COSIBO	Replacing	Page	COSIBO	Replacing	Page
65186	1853436	J.3.2	65227	1945331	A.13.20	65283	1805603	H.2.2	65331	2164195	B.2.5
65186	1111459	J.3.2	65227	2000364	A.13.20	65283	1383863	H.2.2	65331	1851631	B.2.5
65187	1300043	C.8.5	65227	1866391	A.13.20	65283	1412695	H.2.2	65331	1479576	B.2.5
65191	2038653	A.12.3	65227	1374099	A.13.20	65283	1427514	H.2.2	65331	1499770	B.2.5
65191	1536304	A.12.3	65227	1792307	A.13.20	65283	1374889	H.2.2	65331	1728165	B.2.5
65191	1340231	A.12.3	65227	1792308	A.13.20	65288	1343373	E.1.3	65331	1749125	B.2.5
65191	1421322	A.12.3	65227	1945014	A.13.20	65296	1421599	H.6.4	65332	1929397	B.2.9
65191	2038653	C.2.3	65231	222095	L.7.8	65296	1364851	H.6.4	65332	1444110	B.2.9
65191	1536304	C.2.3	65233	1400769	H.4.2	65296	1382490	H.6.4	65332	1749123	B.2.9
65191	1340231	C.2.3	65233	1376474	H.4.2	65298	276228	L.2.1	65334	1386647	A.1.3
65191	1421322	C.2.3	65237	397946	H.8.2	65300	1372786	L.7.8	65335	1386648	A.1.3
65191	2038653	E.3.1	65237	368851	H.8.2	65300	248953	L.7.8	65335	1414395	A.1.3
65191	1536304	E.3.1	65239	550806	L.5.1	65302	1368682	L.7.7	65336	1360836	A.1.2
65191	1340231	E.3.1	65240	550807	L.5.1	65302	349254	L.7.7	65337	551387	A.5.3
65191	1421322	E.3.1	65241	550808	L.5.2	65305	280378	I.55.1	65338	551528	A.5.3
65191	2038653	F.10.1	65242	423730	L.2.6	65306	280377	I.55.1	65339	551386	A.5.3
65191	1536304	F.10.1	65243	639320	L.6.1	65307	388306	I.55.1	65340	1765974	A.4.6
65191	1340231	F.10.1	65244	285493	L.2.22	65308	388305	I.55.1	65342	1505366	A.8.5
65191	1421322	F.10.1	65246	1529552	I.54.12	65309	1414200	C.2.4	65343	1449542	A.8.6
65191	2038653	H.8.1	65246	366595	I.54.12	65309	1414200	H.11.1	65344	1542104	A.8.6
65191	1536304	H.8.1	65248	360247	N.30.1	65310	1368681	L.7.7	65344	1476506	A.8.6
65191	1340231	H.8.1	65249	1402448	N.30.2	65310	204749	L.7.7	65344	1401982	A.8.6
65191	1421322	H.8.1	65250	363712	N.30.3	65311	1775964	A.13.24	65345	1392933	A.9.2
65191	2038653	J.6.2	65250	331881	N.30.3	65312	1775965	A.13.25	65345	170696	A.9.2
65191	1536304	J.6.2	65254	302200	J.6.1	65313	1439814	A.13.23	65352	1896605	A.11.2
65191	1340231	J.6.2	65255	1343100	J.8.15	65313	1423610	A.13.23	65352	1403129	A.11.2
65191	1421322	J.6.2	65261	1324713	J.8.13	65315	550268	C.7.1	65359	1375391	M.5.1
65191	2038653	L.6.2	65262	1768269	J.8.13	65316	1549739	J.1.4	65360	1769522	A.22.5
65191	1536304	L.6.2	65262	1375299	J.8.13	65316	1517325	J.1.4	65360	1444954	A.22.5
65191	1340231	L.6.2	65263	1324712	J.8.14	65317	1386571	J.1.8	65361	1505749	A.33.6
65191	1421322	L.6.2	65265	283296	J.8.3	65318	1325626	J.1.8	65363	1545122	C.2.7
65191	2038653	N.40.1	65266	1116362	J.8.3	65319	1440407	A.22.8	65363	1498607	C.2.7
65191	1536304	N.40.1	65269	1353965	J.8.10	65319	1371782	A.22.8	65364	1545124	C.2.7
65191	1340231	N.40.1	65272	384595	J.8.1	65319	1397796	A.22.8	65365	1442294	I.48.11
65191	1421322	N.40.1	65273	1358828	J.8.1	65320	1511832	A.22.6	65366	1442295	I.48.11
65192	1426449	C.1.2	65273	1332090	J.8.1	65320	1440404	A.22.6	65367	1475436	A.14.8
65192	1120646	C.1.2	65275	371211	A.13.10	65321	65321	I.7.8	65368	1513719	B.2.10
65193	550284	E.1.2	65278	1334196	N.30.3	65322	65322	I.7.9	65368	1513720	B.2.10
65194	550257	E.1.2	65278	289929	N.30.3	65323	65323	I.7.9	65370	1865674	A.13.10
65206	1386753	L.7.8	65278	334470	N.30.3	65324	65324	I.7.8	65370	1744774	A.13.10
65207	1519488	L.10.1	65278	365559	N.30.3	65325	1390705	A.22.4	65371	1379888	A.21.18
65207	1372850	L.10.1	65279	1853773	A.13.21	65325	1349968	A.22.4	65371	1379888	H.5.4
65207	1407661	L.10.1	65279	1384089	A.13.21	65326	1742449	J.8.13	65372	1376295	A.27.4
65213	273024	G.2.5	65279	1413894	A.13.21	65328	1923608	H.14.3	65373	1446581	N.1.6
65214	1104500	G.2.5	65279	1470305	A.13.21	65328	1521554	H.14.3	65373	1349781	N.1.6
65215	297999	G.2.8	65282	1353959	J.8.11	65328	1360368	H.14.3	65374	1446582	N.1.7
65226	1338018	H.40.7							65374	1349782	N.1.7
65226	1307340	H.40.7									

ALL THE COMPONENTS LISTED IN OUR CATALOGUE ARE NOT ORIGINAL, THOUGH PERFECTLY INTERCHANGEABLE. REFERENCE NUMBERS, EITHER ORIGINAL OR OF A DIFFERENT NATURE, ARE FOR INFORMATION PURPOSES ONLY. WHEN PLACING AN ORDER, PLEASE, ALWAYS USE COSIBO REFERENCE NUMBERS AND DO NOT MENTION THE ORIGINAL REFERENCE NUMBERS OF THE TRUCK MANUFACTURERS IN THE INVOICE TO VEHICLE OWNERS OR TO ANYBODY ELSE. THE CUSTOMER TAKES HIS OWN RESPONSIBILITY IF HE DOES NOT COMPLY WITH WHAT ABOVE.

Cross reference COSIBO - SCANIA

COSIBO	Replacing	Page	COSIBO	Replacing	Page	COSIBO	Replacing	Page	COSIBO	Replacing	Page
65375	1385413	N.1.10	65419	1549814	N.1.8	65452	1541086	C.2.6	65486	1781199	H.8.3
65376	138414	N.1.10	65419	1521565	N.1.8	65452	1541086	E.3.2	65486	1448083	H.8.3
65377	1385409	N.1.10	65420	1549815	N.1.9	65452	1541086	N.30.10	65486	1541703	H.8.3
65378	65378	I.7.14	65420	1521566	N.1.9	65453	1424221	C.2.6	65486	1781199	L.10.1
65379	1929397	B.2.11	65421	1930649	I.50.10	65453	1424221	E.3.2	65486	1448083	L.10.1
65379	1382331	B.2.11	65421	1857591	I.50.10	65453	1424221	N.30.10	65486	1541703	L.10.1
65380	65380	L.2.2	65425	1362168	H.8.4	65454	1549304	C.2.7	65486	1781199	N.40.1
65381	65381	I.110.1	65426	1525357	M.10.1	65454	1549304	E.3.2	65486	1448083	N.40.1
65384	394195	H.13.11	65427	1524331	M.10.1	65454	1549304	N.30.10	65486	1541703	N.40.1
65385	394196	H.13.11	65428	1870767	N.3.7	65456	1723663	J.5.3	65487	1872151	A.16.7
65387	1324358	H.13.12	65428	1546618	N.3.7	65456	1437264	J.5.3	65487	1730757	A.16.7
65388	1789565	H.13.12	65430	1469566	C.7.16	65458	2247379	A.2.2	65489	1867658	I.48.2
65388	1356695	H.13.12	65431	1762415	C.7.8	65458	2020691	A.2.2	65489	1789317	I.48.2
65389	1789566	H.13.13	65431	1450132	C.7.8	65458	1908536	A.2.2	65490	1867659	I.48.2
65389	1356696	H.13.13	65431	1543603	C.7.8	65458	2247379	N.30.21	65490	1789318	I.48.2
65390	1302772	I.54.4	65431	1548849	C.7.8	65458	2020691	N.30.21	65498	1917858	A.40.1
65392	1502474	A.9.3	65432	1902973	I.48.2	65458	1908536	N.30.21	65499	1907422	A.40.2
65394	1849060	A.24.1	65432	1406227	I.48.2	65459	2191989	A.23.3	65499	1795459	A.40.2
65394	1423451	A.24.1	65432	1789309	I.48.2	65459	1870551	A.23.3	65499	1852188	A.40.2
65394	1799757	A.24.1	65433	1902974	I.48.2	65460	2030276	E.1.3	65499	1488093	A.40.2
65394	1800909	A.24.1	65433	1406228	I.48.2	65460	1908858	E.1.3	65501	1444822	F.2.2
65398	1769997	A.21.3	65433	1789310	I.48.2	65460	2030276	F.2.4	65501	1325066	F.2.2
65398	1784616	A.21.3	65434	375351	J.1.7	65460	1908858	F.2.4	65501	264906	F.2.2
65398	1527653	A.21.3	65436	1383956	L.6.2	65468	1541978	J.1.3	65502	1535248	H.40.2
65398	1741588	A.21.3	65437	1752264	J.5.5	65469	1473979	A.30.2	65502	551161	H.40.2
65398	570485	A.21.3	65438	1854227	I.30.6	65470	2038655	C.2.3	65503	1375688	A.2.1
65399	1433203	B.1.2	65438	1498179	I.30.6	65470	1376794	C.2.3	65504	1375689	A.2.2
65400	2022275	A.14.2	65439	1854228	I.30.7	65470	1376794	E.3.1	65504	1375689	N.30.18
65400	1742032	A.14.2	65439	1498180	I.30.7	65470	1376794	F.10.1	65505	1535249	H.40.2
65401	1926077	I.50.8	65440	1502515	H.11.1	65470	1376794	H.8.1	65505	551162	H.40.2
65402	1466075	A.27.16	65440	1393478	H.11.1	65471	1422615	J.5.5	65506	1535250	H.40.3
65402	1466075	C.50.1	65441	2001791	A.40.1	65472	1493381	N.1.8	65506	551163	H.40.3
65402	1466075	H.4.4	65441	1753208	A.40.1	65474	1887055	H.5.7	65507	1910461	H.6.4
65402	1466075	M.30.1	65442	1779130	A.5.8	65474	468005	H.5.7	65507	1773867	H.6.4
65405	65405	I.48.7	65443	1785693	A.5.9	65477	1530503	M.2.4	65514	1861121	L.1.3
65406	65406	I.48.7	65444	1918538	A.40.1	65477	486317	M.2.4	65514	1478511	L.1.3
65409	1725593	N.1.9	65444	1749823	A.40.1	65478	1796883	M.2.4	65515	1519633	L.1.3
65410	1733180	N.1.9	65444	1884205	A.40.1	65478	1432591	M.2.4	65515	1478509	L.1.3
65411	1520919	N.1.3	65445	1720925	J.1.8	65479	1377930	A.14.14	65516	1865759	L.9.2
65411	1358833	N.1.3	65446	1725376	J.1.2	65479	1377930	N.30.19	65516	1402423	L.9.2
65412	1451527	I.50.10	65447	1851248	J.1.11	65481	1936370	A.13.14	65517	1863244	L.9.2
65413	1451528	I.50.10	65447	1767479	J.1.11	65483	1347572	L.6.3	65517	1387283	L.9.2
65414	1451270	I.50.11	65449	2099046	L.10.1	65484	2021087	N.40.1	65519	1865315	N.30.19
65415	1451271	I.50.11	65449	1495828	L.10.1	65484	1744086	N.40.1	65519	1539106	N.30.19
65416	1897336	E.2.2	65450	2077976	H.9.1	65484	1856312	N.40.1	65519	1788498	N.30.19
65418	1346380	I.7.13	65450	1763422	H.9.1	65485	1748892	A.12.4	65524	1485592	A.16.7
			65450	1774873	H.9.1	65485	1513440	A.12.4	65525	1446239	A.22.5
			65450	1928588	H.9.1						

ALL THE COMPONENTS LISTED IN OUR CATALOGUE ARE NOT ORIGINAL, THOUGH PERFECTLY INTERCHANGEABLE. REFERENCE NUMBERS, EITHER ORIGINAL OR OF A DIFFERENT NATURE, ARE FOR INFORMATION PURPOSES ONLY. WHEN PLACING AN ORDER, PLEASE, ALWAYS USE COSIBO REFERENCE NUMBERS AND DO NOT MENTION THE ORIGINAL REFERENCE NUMBERS OF THE TRUCK MANUFACTURERS IN THE INVOICE TO VEHICLE OWNERS OR TO ANYBODY ELSE. THE CUSTOMER TAKES HIS OWN RESPONSIBILITY IF HE DOES NOT COMPLY WITH WHAT ABOVE.

Cross reference COSIBO - SCANIA

COSIBO	Replacing	Page	COSIBO	Replacing	Page	COSIBO	Replacing	Page	COSIBO	Replacing	Page
65526	1440780	I.48.3									
65526	1393103	I.48.3									
65527	1440781	I.48.3									
65527	1404099	I.48.3									
65528	1768957	C.700.1									
65529	1442300	A.2.4									
65530	1792387	N.3.5									
65531	1792388	N.3.5									
65532	65532	N.3.5									
65534	1523635	C.2.8									
65535	1888034	J.5.4									
65535	1412263	J.5.4									
65539	1486287	M.10.1									
65540	1779118	I.30.4									
65540	1501342	I.30.4									
65541	1779119	I.30.4									
65541	1501343	I.30.4									
65542	1362707	I.30.9									
65542	1362707	N.2.4									
65543	1414341	A.5.6									
65544	1479574	B.2.10									
65547	2197390	A.23.2									
65547	2191990	A.23.2									
65547	1870552	A.23.2									
65548	1386199	L.9.2									
65549	1386200	L.9.1									
66520	120824	H.40.8									
66573/1	242857	A.32.3									
66578/1	1346612	C.7.15									
66579/1	1373520	A.22.7									
66580/1	1514089	C.7.15									
66580/1	1427926	C.7.15									
66581/1	488372	A.5.15									
66582	1357381	J.8.12									
66583	1346606	C.7.14									
66584	1357380	J.1.9									
66585	1346608	C.7.14									
66600	242573	H.3.2									
66606	1403609	H.3.3									
66606	1337777	H.3.3									
66606	1340548	H.3.3									
66606	1345729	H.3.3									
66606	207517	H.3.3									
66606	231936	H.3.3									
66623	258420	L.1.1									
66625	308710	A.32.1									
68888	1535049	I.30.8									
68888	1390076	I.30.8									

ALL THE COMPONENTS LISTED IN OUR CATALOGUE ARE NOT ORIGINAL, THOUGH PERFECTLY INTERCHANGEABLE. REFERENCE NUMBERS, EITHER ORIGINAL OR OF A DIFFERENT NATURE, ARE FOR INFORMATION PURPOSES ONLY. WHEN PLACING AN ORDER, PLEASE, ALWAYS USE COSIBO REFERENCE NUMBERS AND DO NOT MENTION THE ORIGINAL REFERENCE NUMBERS OF THE TRUCK MANUFACTURERS IN THE INVOICE TO VEHICLE OWNERS OR TO ANYBODY ELSE. THE CUSTOMER TAKES HIS OWN RESPONSIBILITY IF HE DOES NOT COMPLY WITH WHAT ABOVE.

Cross reference SCANIA - COSIBO

Replacing	COSIBO	Page	Replacing	COSIBO	Page	Replacing	COSIBO	Page	Replacing	COSIBO	Page
	63201	A.27.1	64331	64331	B.2.6	135036	60917	L.2.17	170363	61484	A.13.3
	65341	A.33.7	64332	64332	C.7.11	135698	60921	L.2.18	170610	61834	A.8.2
	65386	H.13.12	64340	64340	B.3.1	137207	60405	A.18.1	170694	61842	A.9.1
	65417	I.7.13	64348	64348	I.56.4	137207	60405	C.9.1	170696	65345	A.9.2
7084	623245	J.1.10	64379	64379	A.13.26	138414	65376	N.1.10	170761	60999	A.22.9
7085	623241	J.1.9	64385	64385	A.7.10	138849	60140	A.18.1	170948	61491	A.13.21
7086	623242	J.1.9	64386	64386	A.7.10	139110	60016	A.7.16	170955	61492	A.13.21
7087	623244	J.1.10	64395	64395	A.7.11	139471	60973	A.16.2	173171	60126	A.14.1
7088	623243	J.1.10	64398	64398	A.7.11	139472	60969	A.16.1	180064	60549	H.40.9
15323	61537	A.13.23	64425	64425	B.2.12	139616	60566	A.13.2	180435	61917	A.13.27
33352	60993	G.2.10	64631	64631	A.21.6	139625	60101	A.2.3	182525	63562	A.7.12
40607	60398	A.33.12	64632	64632	A.21.6	141163	60540	H.40.6	182525	63562	C.1.9
60439	60439	A.33.8	64684	64684	I.56.3	141164	60539	H.40.8	182525	63562	F.2.6
62091	62091	B.1.8	64730	64730	G.2.9	141168	60957	H.13.14	182525	63562	G.2.14
62283	62283	I.56.3	64738	64738	L.2.13	142575	61323	H.13.14	182525	63562	H.6.1
62324	62324	J.1.11	64739	64739	L.2.12	142729	61808	A.27.1	182525	63562	M.5.2
62421	62421	I.48.7	64748	64748	A.5.13	142729	61808	J.5.1	182929	60918	L.2.18
62436	62436	I.110.1	64824	64824	C.7.10	146526	60142	C.9.1	182930	60538	H.40.8
62449	62449	I.55.8	64833	64833	A.22.1	153287	60961	L.2.5	182931	60919	L.2.19
62450	62450	I.55.8	64839	64839	A.22.2	153468	61758	A.14.1	184490	63241	C.3.1
62467	62467	L.7.6	64860	64860	G.2.13	153468	61758	M.5.3	184808	65075	F.2.4
62468	62468	L.7.6	65003	65003	C.6.6	153682	61371	C.3.5	192882	61121	A.28.4
62497	62497	I.55.9	65157	65157	A.32.2	153682	61371	F.1.2	193136	60299	G.2.3
62498	62498	I.55.8	65321	65321	I.7.8	154259	60955	H.40.6	193137	60299	G.2.3
62499	62499	A.33.7	65322	65322	I.7.9	154261	60535	H.40.7	194414	61215	C.5.1
63336	63336	H.40.10	65323	65323	I.7.9	154262	60536	H.40.5	194838	61341	B.2.1
63621	63621	C.5.2	65324	65324	I.7.8	154621	60112	A.7.16	194838	61341	C.1.1
63625	63625	C.6.5	65378	65378	I.7.14	156938	61849	G.2.15	197800	60635	A.5.4
63684	63684	H.6.6	65380	65380	L.2.2	157274	63386	A.5.6	197800	60635	C.8.4
63754	63754	C.2.1	65381	65381	I.110.1	159496	60005	G.2.7	197800	60635	F.2.5
63777	63777	A.13.12	65405	65405	I.48.7	159656	61195	H.8.3	199846	64069	I.56.2
63794	63794	A.23.10	65406	65406	I.48.7	164433	65008	F.2.3	202288	63802	F.2.5
63795	63795	A.23.11	65532	65532	N.3.5	165282	61204	A.13.28	202333	60920	L.2.18
63808	63808	J.8.8	120252	62219	L.2.22	165286	61205	A.13.29	202335	60912	L.2.14
63811	63811	J.8.8	120310	60994	G.2.11	168248	63750	A.2.5	204719	61510	L.7.5
63812	63812	L.2.20	120824	66520	H.40.8	168778	60322	A.29.3	204722	61511	L.7.5
63813	63813	L.2.20	120828	60958	H.13.1	168781	60323	A.29.4	204723	61502	L.7.2
63814	63814	L.2.21	123102	60546	H.40.9	168782	60324	A.29.4	204724	61227	L.7.1
63925	63925	A.13.14	128680	60916	L.2.16	169316	60331	A.29.4	204727	61509	L.7.4
64106	64106	I.54.10	128681	60914	L.2.16	169317	60332	A.29.4	204728	60867	L.7.5
64107	64107	I.54.10	131115	63385	A.5.6	169318	60333	A.29.4	204731	61506	L.7.3
64119	64119	O.1.1	131120	60102	A.2.5	169319	60334	A.29.5	204733	60866	L.7.4
64129	64129	A.14.6	131180	60589	A.11.1	169320	60335	A.29.5	204735	61504	L.7.2
64130	64130	A.14.7	131455	63387	A.5.7	169321	60336	A.29.5	204736	61505	L.7.2
64131	64131	A.14.8	132650	61960	A.16.11	170069	60591	A.2.3	204737	61503	L.7.2
64138	64138	A.7.9	132650	61960	L.7.5	170132	61199	A.5.10	204746	61507	L.7.3
64140	64140	A.7.10	134494	605471	H.12.5	170226	60998	A.22.9	204749	65310	L.7.7
64190	64190	A.7.23	135035	60913	L.2.17	170274	60003	A.3.1	204750	61501	L.7.1

ALL THE COMPONENTS LISTED IN OUR CATALOGUE ARE NOT ORIGINAL, THOUGH PERFECTLY INTERCHANGEABLE. REFERENCE NUMBERS, EITHER ORIGINAL OR OF A DIFFERENT NATURE, ARE FOR INFORMATION PURPOSES ONLY. WHEN PLACING AN ORDER, PLEASE, ALWAYS USE COSIBO REFERENCE NUMBERS AND DO NOT MENTION THE ORIGINAL REFERENCE NUMBERS OF THE TRUCK MANUFACTURERS IN THE INVOICE TO VEHICLE OWNERS OR TO ANYBODY ELSE. THE CUSTOMER TAKES HIS OWN RESPONSIBILITY IF HE DOES NOT COMPLY WITH WHAT ABOVE.

Cross reference SCANIA - COSIBO

Replacing	COSIBO	Page	Replacing	COSIBO	Page	Replacing	COSIBO	Page	Replacing	COSIBO	Page
207517	66606	H.3.3	243460	63447	J.3.1	270142	61463	A.21.13	283650	65179	C.2.10
207783	62329	A.28.3	243460	63447	N.30.4	270738	63469	A.13.19	283650	65179	H.8.2
209152	60301	G.2.3	243648	61475	A.1.1	270739	63468	A.13.18	283783	60521	E.2.3
209153	60302	G.2.3	243956	60986	G.2.16	271147	60694	A.29.9	283783	60521	F.5.1
211005	61120	A.28.1	244090	61333	C.6.1	271148	60695	A.29.9	283783	60521	M.2.4
211813	61233	A.14.5	244536	63262	C.3.1	271488	60102	A.2.5	283784	60522	E.2.3
211818	61193	A.14.3	244780	61496	C.2.9	272400	61850	L.1.1	283784	60522	F.5.1
213604	61220	L.2.7	248325	65183	C.7.13	272449	61315	L.2.6	283784	60522	M.2.5
213606	61306	L.2.11	248326	65182	C.7.13	272853	60983	G.2.16	284015	62526	C.2.11
213607	61307	L.2.11	248953	65300	L.7.8	273020	60279	G.2.2	284843	60047	C.4.2
214008	61010	F.2.5	250318	60416	O.2.6	273022	61761	G.2.7	285248	61731	A.5.15
215715	61473	A.1.1	250995	61707	A.13.25	273023	61650	G.2.6	285248	61731	J.8.12
218684	61163	H.13.4	250996	60073	A.13.22	273024	65213	G.2.5	285493	65244	L.2.22
218831	61260	H.13.6	252497	61218	L.7.1	273793	60654	A.21.8	287379	65180	C.7.12
218832	61259	H.13.6	254333	63253	C.3.2	275460	60909	L.2.15	287380	65181	C.7.13
219722	63155	A.21.8	255315	61313	L.2.3	275591	61026	A.11.3	287449	61651	G.2.5
222095	65231	L.7.8	255669	61859	L.2.14	275591	61026	C.3.4	287554	60589	A.11.1
222499	614901	A.13.2	257375	60002	A.3.1	275698	62134	L.2.19	287620	60957	H.13.14
223315	61799	A.27.7	258410	60319	A.29.3	276087	61538	A.13.22	288177	61979	I.54.5
223635	60018	A.1.6	258411	60320	A.29.3	276228	65298	L.2.1	288178	61980	I.54.6
224915	61366	B.2.6	258412	60321	A.29.3	276517	61166	H.13.4	288207	62369	J.2.3
224915	61366	C.8.4	258420	66623	L.1.1	276518	61167	H.13.5	288208	62370	J.2.3
225353	60114	A.7.17	258459	60561	A.8.1	277272	60059	A.13.1	288209	62371	J.2.4
225354	60115	A.7.18	258686	60325	A.29.5	277273	60058	A.13.1	288212	63365	J.2.2
225931	60113	A.7.17	258687	60326	A.29.6	277607	61483	A.16.2	288213	63366	J.2.2
228483	61303	L.2.7	258688	60327	A.29.6	278102	61477	A.1.5	288214	63367	J.2.3
231936	66606	H.3.3	258689	60328	A.29.6	278263	63450	N.30.4	288649	61708	H.8.1
232018	60014	A.1.2	258690	60329	A.29.6	278335	61846	A.24.3	288893	64297	J.1.12
233275	64163	G.2.13	258691	60330	A.29.7	278531	61707	A.13.25	289336	60547	H.12.4
234387	61624	C.2.5	259065	61000	A.26.3	278663	61924	M.2.1	289445	60196	O.1.1
234682	62006	B.2.7	261575	61005	A.26.1	278664	61924	M.2.1	289929	65278	N.30.3
235177	60059	A.13.1	263161	60391	A.7.19	278665	61549	M.2.1	290062	609831	G.2.17
235178	60058	A.13.1	263427	62108	A.1.2	278666	61549	M.2.1	290534	61194	A.14.4
235434	61371	C.3.5	263911	60692	A.29.8	278734	61168	H.13.8	290950	62276	J.3.2
235434	61371	F.1.2	263912	60693	A.29.9	278735	61257	H.13.6	291826	63627	A.8.3
237884	61319	L.2.21	263915	60696	A.29.9	278736	61169	H.13.5	292761	61002	A.26.3
238777	60116	A.7.18	263916	60697	A.29.9	279052	60073	A.13.22	292811	63148	A.8.7
238999	60140	A.18.1	263917	60698	A.29.10	280377	65306	I.55.1	293152	65177	B.1.6
241805	61800	A.27.2	263918	60699	A.29.10	280378	65305	I.55.1	293152	65177	H.4.5
241922	60962	L.2.5	264310	60301	G.2.3	280553	62298	N.1.8	293853	63470	A.13.19
242297	60408	A.7.19	264311	60302	G.2.3	280651	63757	H.13.3	294270	645221	D.1.1
242298	60409	A.7.19	264906	65501	F.2.2	280652	61335	H.13.2	294271	64522	D.1.1
242299	60407	A.7.19	265768	60915	L.2.4	280862	60720	A.31.1	294674	60010	A.1.1
242573	66600	H.3.2	267460	63214	A.27.1	283281	63174	A.24.2	294903	63005	C.3.1
242857	665731	A.32.3	267460	63214	H.5.1	283295	62028	J.8.3	294904	63005	C.3.1
243460	63447	A.12.2	269342	65154	A.28.1	283296	65265	J.8.3	294999	60794	B.2.2
243460	63447	C.2.8	269715	60017	A.1.5	283642	60554	L.2.15	295297	62214	A.5.16
243460	63447	H.8.2	269716	60018	A.1.6	283650	65179	B.1.8	295751	63287	L.2.8

ALL THE COMPONENTS LISTED IN OUR CATALOGUE ARE NOT ORIGINAL, THOUGH PERFECTLY INTERCHANGEABLE. REFERENCE NUMBERS, EITHER ORIGINAL OR OF A DIFFERENT NATURE, ARE FOR INFORMATION PURPOSES ONLY. WHEN PLACING AN ORDER, PLEASE, ALWAYS USE COSIBO REFERENCE NUMBERS AND DO NOT MENTION THE ORIGINAL REFERENCE NUMBERS OF THE TRUCK MANUFACTURERS IN THE INVOICE TO VEHICLE OWNERS OR TO ANYBODY ELSE. THE CUSTOMER TAKES HIS OWN RESPONSIBILITY IF HE DOES NOT COMPLY WITH WHAT ABOVE.

Cross reference SCANIA - COSIBO

Replacing	COSIBO	Page	Replacing	COSIBO	Page	Replacing	COSIBO	Page	Replacing	COSIBO	Page
295953	60984	G.2.17	306278	60597	B.1.8	316756	61987	I.56.1	335119	61316	I.54.7
295960	62512	A.21.21	306902	60580	L.2.9	316918	62133	I.7.1	335683	61494	C.3.3
295960	62512	H.6.8	306913	62135	M.2.1	316920	62136	I.7.1	336590	62319	J.10.3
295960	62512	J.2.6	306993	60109	A.2.1	318350	61864	A.27.2	336979	61363	I.48.8
296538	61659	I.7.2	307113	62238	L.2.6	318362	63194	A.21.5	336980	61644	I.48.8
296538	61660	I.7.2	307443	63329	C.7.2	318364	63176	A.27.8	337058	60237	D.2.1
297394	61703	A.21.18	308385	60696	A.29.9	318364	63176	C.8.1	337059	60238	D.2.1
297394	61703	C.8.4	308386	60697	A.29.9	318523	60721	A.31.1	337060	60239	D.2.2
297568	60496	N.3.1	308604	60653	A.21.7	318690	60986	G.2.16	338395	62215	A.5.16
297571	62033	J.8.5	308678	62397	A.21.21	319110	60016	A.7.16	338643	61026	A.11.3
297999	65215	G.2.8	308678	62397	H.6.9	319747	61878	H.5.2	338643	61026	C.3.4
298021	61007	G.2.11	308710	66625	A.32.1	319789	607181	A.28.3	338692	61344	B.1.7
298021	610071	G.2.12	309065	61232	A.21.7	319792	65152	A.28.2	338706	60249	C.4.2
298823	61793	A.27.7	309421	61266	H.13.7	320775	62145	J.8.5	338923	62089	B.1.2
298823	61793	C.8.1	309422	61265	H.13.7	320813	60687	A.29.8	339129	64498	C.7.4
298953	62089	B.1.2	309885	60140	A.18.1	320814	60688	A.29.8	339130	63328	C.7.8
300296	62222	A.21.11	310243	61629	C.7.11	321297	61628	C.7.11	339140	65183	C.7.13
300308	62135	M.2.1	310808	61305	L.2.8	322368	64189	L.5.2	339141	65182	C.7.13
300957	60017	A.1.5	310951	61023	A.10.2	322693	60712	A.29.10	339188	61734	L.2.9
300958	60018	A.1.6	310953	60998	A.22.9	322694	60713	A.29.10	341299	61621	J.4.1
301473	60111	A.7.15	310979	60859	E.2.5	322695	60714	A.29.10	342832	60794	B.2.2
301519	61649	G.2.6	310980	60860	E.2.5	322697	60715	A.29.11	342833	60795	B.2.3
301760	60893	H.3.1	311755	62032	J.8.4	322698	60716	A.29.11	342988	60629	A.25.1
301789	63178	A.27.8	311757	62015	J.8.2	322699	60717	A.29.11	342989	61631	A.7.1
301843	61602	I.56.1	312217	60706	A.29.11	323451	63388	A.7.3	344426	61237	A.8.2
301844	61911	I.56.1	312218	60707	A.29.12	323451	63388	C.1.8	345083	64210	H.5.2
301845	62240	I.56.2	312219	60708	A.29.12	323641	61632	A.7.2	345360	61350	B.1.7
302200	65254	J.6.1	312221	60709	A.29.12	323641	61632	B.3.2	346077	63353	M.5.1
302768	60915	L.2.4	312222	60710	A.29.12	323641	61632	H.6.8	346085	62027	J.8.2
302948	65182	C.7.13	312223	60711	A.29.13	323662	61630	A.7.1	346143	60002	A.3.1
303419	61485	A.13.1	312354	63930	O.2.7	323790	60127	A.10.4	346568	63746	J.8.5
303470	60375	C.2.3	312465	64061	J.9.4	323790	60127	H.5.1	346627	61212	A.27.2
303520	60922	J.5.6	312646	61704	A.21.14	324728	61879	H.13.13	346627	61212	C.8.1
303535	63446	N.30.6	313228	64397	A.21.10	325014	62031	J.8.4	346627	61212	J.5.1
303643	61798	A.27.1	313228	64397	D.2.3	326631	62047	A.13.17	347241	61222	J.8.1
303649	62220	A.21.11	313228	64397	F.2.6	327557	62006	B.2.7	347245	61223	J.8.2
303649	62220	I.105.7	313657	61663	N.2.3	329583	61226	J.8.6	347893	61645	N.30.1
304305	60795	B.2.3	313658	61664	N.2.3	329638	63570	C.2.9	348293	60689	A.29.8
304309	60974	B.2.4	314063	61025	C.3.4	330655	64255	H.12.3	348294	60690	A.29.8
304332	63749	D.1.3	314572	61033	F.4.1	330749	61987	I.56.1	348694	62029	J.8.4
304394	60778	B.2.1	315002	61634	C.3.2	331881	65250	N.30.3	348764	62242	J.8.1
305286	60683	A.29.7	315022	61198	C.5.1	332119	60636	A.14.12	349034	65184	C.7.14
305287	60684	A.29.7	315060	60015	C.3.3	332119	60636	H.14.1	349254	65302	L.7.7
305288	60685	A.29.7	315085	65091	C.4.1	332119	60636	J.6.1	350061	61759	A.7.14
305289	60686	A.29.7	315085	65091	D.1.3	332119	60636	M.5.2	350270	61209	C.7.1
305319	60907	C.7.2	315270	61214	C.5.1	332738	60405	A.18.1	350572	63219	A.21.15
305320	60908	C.7.3	316379	63051	N.30.9	332738	60405	C.9.1	351197	61846	A.24.3
305345	61226	J.8.6	316640	61706	I.7.4	334470	65278	N.30.3	351301	60657	A.29.16

ALL THE COMPONENTS LISTED IN OUR CATALOGUE ARE NOT ORIGINAL, THOUGH PERFECTLY INTERCHANGEABLE. REFERENCE NUMBERS, EITHER ORIGINAL OR OF A DIFFERENT NATURE, ARE FOR INFORMATION PURPOSES ONLY. WHEN PLACING AN ORDER, PLEASE, ALWAYS USE COSIBO REFERENCE NUMBERS AND DO NOT MENTION THE ORIGINAL REFERENCE NUMBERS OF THE TRUCK MANUFACTURERS IN THE INVOICE TO VEHICLE OWNERS OR TO ANYBODY ELSE. THE CUSTOMER TAKES HIS OWN RESPONSIBILITY IF HE DOES NOT COMPLY WITH WHAT ABOVE.

Cross reference SCANIA - COSIBO

Replacing	COSIBO	Page	Replacing	COSIBO	Page	Replacing	COSIBO	Page	Replacing	COSIBO	Page
351302	60658	A.29.17	360719	60807	B.1.1	367624	65153	A.28.2	371894	63438	N.3.1
351303	60659	A.29.17	361481	65163	A.32.4	367761	61627	A.21.4	371896	63438	N.3.1
351305	60660	A.29.17	361692	61548	A.32.1	367762	62299	A.21.4	371910	62297	M.1.1
351306	60661	A.29.17	361993	62335	I.30.4	368033	61508	L.7.4	372773	63140	A.11.2
351307	60662	A.29.18	361994	62340	I.30.5	368559	63175	A.21.14	372981	63151	A.14.10
351309	60663	A.29.18	362044	63791	H.13.7	368851	65237	H.8.2	372983	65036	A.14.13
351310	60664	A.29.18	362045	63792	H.13.8	368926	65073	J.1.2	372984	61194	A.14.4
351311	60665	A.29.18	362128	60127	A.10.4	369276	61484	A.13.3	372985	61193	A.14.3
351313	60666	A.29.19	362128	60127	H.5.1	369291	60700	A.29.13	373210	63300	A.21.15
351314	60667	A.29.19	362257	61206	A.14.9	369292	60701	A.29.13	373472	60002	A.3.1
351315	60668	A.29.19	362385	60252	L.2.14	369293	60702	A.29.13	374338	61346	A.12.1
352211	60010	A.1.1	362408	61837	A.7.2	369295	60703	A.29.14	374742	60589	A.11.1
352347	60014	A.1.2	362778	60975	B.2.4	369296	60704	A.29.14	375086	61196	G.2.9
352543	62216	A.5.16	363712	65250	N.30.3	369297	60705	A.29.14	375087	61197	G.2.15
352635	61924	M.2.1	363808	60413	H.4.1	369375	61604	I.30.8	375350	64371	J.1.7
352637	61932	M.2.2	363990	61550	L.2.2	369477	63140	A.11.2	375351	65434	J.1.7
352645	60861	E.2.4	364624	61162	A.29.1	369478	61219	A.10.2	375527	63301	A.21.16
352646	60862	E.2.4	364791	61487	A.13.3	370074	61020	G.2.9	375734	61953	C.2.5
352722	60975	B.2.4	364792	61486	A.13.2	370075	61017	G.2.15	375734	61953	F.4.1
352745	60798	B.2.3	364833	60141	A.18.1	370076	61297	G.2.8	375903	62369	J.2.3
352750	60789	B.2.3	364833	60141	A.18.1	370640	63608	J.6.1	375904	62370	J.2.3
353249	61483	A.16.2	365015	61137	J.3.4	370710	63055	C.2.6	375905	62371	J.2.4
353546	64509	J.2.6	365160	63930	O.2.7	370710	63055	F.4.2	375937	63170	A.16.10
353592	61621	J.4.1	365161	60418	O.2.6	370710	63055	N.40.2	376116	62208	I.48.4
353621	63604	J.3.3	365162	63930	O.2.7	370875	61654	M.2.6	376243	62067	I.7.3
353623	64493	J.3.4	365184	60418	O.2.6	370875	61654	M.2.6	376283	64050	I.48.1
353625	64859	J.3.4	365484	61771	A.29.26	370990	64683	N.1.10	376284	64051	I.48.1
353626	62520	J.3.1	365485	60677	A.29.14	371211	65275	A.13.10	376673	61606	I.48.8
353628	61865	N.30.3	365486	60678	A.29.15	371448	61208	C.7.3	376674	62195	I.48.9
353843	60102	A.2.5	365487	60679	A.29.15	371451	60907	C.7.2	377253	60893	H.3.1
354334	63376	A.13.17	365488	61770	A.29.27	371452	60908	C.7.3	377254	60894	H.3.1
354967	61213	A.27.7	365489	60680	A.29.15	371453	61207	C.7.3	378264	61835	A.13.4
355145	60914	L.2.16	365490	60681	A.29.16	371483	61844	A.9.1	378277	60866	L.7.4
355147	60913	L.2.17	365491	60682	A.29.16	371487	60567	A.10.1	378299	61237	A.8.2
355148	60920	L.2.18	365559	65278	N.30.3	371489	61192	A.14.11	378396	60629	A.25.1
355223	63598	N.30.7	365863	61490	A.13.2	371490	61191	A.14.11	378480	63275	F.2.5
355708	62014	B.3.1	365901	60238	D.2.1	371491	61553	A.13.3	378613	64080	C.3.5
355939	63375	A.13.22	366006	61317	N.3.2	371492	61762	A.7.5	381235	64143	A.7.22
356085	61728	I.48.9	366256	61477	A.1.5	371499	61230	A.10.1	381339	61923	M.2.1
356086	61729	I.48.9	366303	61219	A.10.2	371502	65119	A.14.2	381638	61834	A.8.2
356942	62321	I.48.10	366437	60239	D.2.2	371505	60569	A.13.7	381918	60669	A.29.19
356942	62321	I.48.10	366539	61552	A.13.8	371507	60206	A.8.1	381919	60670	A.29.19
357363	60564	A.16.1	366547	61482	A.16.4	371510	61483	A.16.2	381920	60671	A.29.20
357402	60347	A.33.3	366550	63563	A.7.13	371514	60973	A.16.2	381921	60672	A.29.20
358404	64074	C.3.5	366557	64277	A.16.4	371515	60969	A.16.1	381922	60673	A.29.20
360247	65248	N.30.1	366595	65246	I.54.12	371612	60808	B.1.1	381923	60674	A.29.20
360248	60517	N.30.1	367326	61645	N.30.1	371780	651512	A.28.1	381924	60675	A.29.20
360717	62089	B.1.2	367569	60003	A.3.1	371781	607181	A.28.3	381925	60676	A.29.21

ALL THE COMPONENTS LISTED IN OUR CATALOGUE ARE NOT ORIGINAL, THOUGH PERFECTLY INTERCHANGEABLE. REFERENCE NUMBERS, EITHER ORIGINAL OR OF A DIFFERENT NATURE, ARE FOR INFORMATION PURPOSES ONLY. WHEN PLACING AN ORDER, PLEASE, ALWAYS USE COSIBO REFERENCE NUMBERS AND DO NOT MENTION THE ORIGINAL REFERENCE NUMBERS OF THE TRUCK MANUFACTURERS IN THE INVOICE TO VEHICLE OWNERS OR TO ANYBODY ELSE. THE CUSTOMER TAKES HIS OWN RESPONSIBILITY IF HE DOES NOT COMPLY WITH WHAT ABOVE.

Cross reference SCANIA - COSIBO

Replacing	COSIBO	Page	Replacing	COSIBO	Page	Replacing	COSIBO	Page	Replacing	COSIBO	Page
381962	61153	H.13.15	391555	61959	A.21.5	397920	63338	C.6.7	550527	60900	C.1.5
382413	60790	B.2.4	391608	61476	A.1.4	397929	62223	A.12.1	550533	64314	C.1.4
382774	62135	M.2.1	392099	61972	I.54.3	397946	65237	H.8.2	550533	64314	C.1.5
382983	63180	A.27.14	392100	61973	I.54.3	397956	60798	B.2.3	550534	61498	C.1.6
382985	63179	A.27.8	392204	60720	A.31.1	397957	61174	A.26.3	550537	63678	C.1.5
383523	63747	J.8.6	392309	61007	G.2.11	397999	63154	A.21.14	550539	60895	C.1.6
383524	65074	J.1.3	392309	610071	G.2.12	412080	63229	A.21.13	550540	64175	C.1.7
384595	65272	J.8.1	392661	60635	A.5.4	412080	63229	C.8.1	550550	63683	H.6.5
384848	62144	A.13.26	392661	60635	C.8.4	423730	65242	L.2.6	550553	63865	H.6.5
384970	63057	C.7.5	392661	60635	F.2.5	423736	62235	L.2.10	550562	62013	B.1.6
385022	60589	A.11.1	392663	60636	A.14.12	468005	65474	H.5.7	550567	65089	H.6.6
385159	62366	I.50.3	392663	60636	H.14.1	468568	62521	L.6.1	550577	64311	C.1.7
385266	61743	J.8.2	392663	60636	J.6.1	470272	60255	M.2.2	550578	64175	C.1.7
385647	61530	H.3.1	392663	60636	M.5.2	470391	63617	M.1.2	550722	60845	E.1.1
385840	62314	J.1.5	393107	61628	C.7.11	475110	62521	L.6.1	550729	60838	E.1.1
385997	60059	A.13.1	393108	61629	C.7.11	486317	65477	M.2.4	550730	60838	E.1.1
385998	60058	A.13.1	393151	60109	A.2.1	488368	63297	A.21.15	550731	60849	E.1.1
386073	61652	D.2.2	393263	62105	A.1.6	488372	665811	A.5.15	550806	65239	L.5.1
387300	61356	C.1.2	393264	60018	A.1.6	550044	61147	A.26.6	550807	65240	L.5.1
387503	60970	A.3.2	393620	61955	A.28.5	550154	63407	A.5.11	550808	65241	L.5.2
387775	61485	A.13.1	393820	60565	A.16.1	550167	61183	A.26.7	550813	62465	F.2.2
387877	60836	C.4.2	393932	62011	A.21.7	550195	60505	A.17.1	551161	65502	H.40.2
387877	60836	D.1.3	393950	61077	A.21.6	550196	60506	A.17.1	551161	65502	H.40.3
387877	60836	E.2.6	394195	65384	H.13.11	550206	61186	A.26.7	551162	65505	H.40.2
387877	60836	F.2.3	394196	65385	H.13.11	550214	60587	A.4.1	551162	65505	H.40.4
387877	60836	H.6.10	394766	61661	N.2.2	550216	61180	A.26.6	551163	65506	H.40.3
388053	60790	B.2.4	394767	61662	N.2.2	550231	61832	A.13.9	551163	65506	H.40.4
388169	61972	I.54.3	394768	62270	N.2.2	550247	63708	A.5.9	551350	63280	A.4.2
388170	61973	I.54.3	394769	62271	N.2.2	550257	65194	E.1.2	551351	63064	A.13.9
388305	65308	I.55.1	394794	63414	A.13.24	550268	65315	C.7.1	551355	63295	A.26.8
388306	65307	I.55.1	395009	60521	E.2.3	550269	63293	A.26.7	551356	63558	A.5.2
388402	61554	A.13.7	395009	60521	F.5.1	550270	64275	A.4.5	551363	63281	A.4.3
388528	61025	C.3.4	395009	60521	M.2.4	550282	64036	L.3.1	551365	60758	A.13.8
388536	62363	I.50.3	395010	60522	E.2.3	550283	64309	L.3.1	551369	63296	A.26.8
388728	62460	F.2.2	395010	60522	F.5.1	550284	65193	E.1.2	551370	60362	A.5.1
389035	65177	B.1.6	395010	60522	M.2.5	550343	61833	A.13.9	551386	65339	A.5.3
389035	65177	H.4.5	395063	64646	L.1.1	550421	60426	B.1.5	551387	65337	A.5.3
389500	62138	M.1.2	395063	64646	L.1.4	550422	60426	B.1.5	551435	61878	H.5.2
390225	60239	D.2.2	395339	62213	A.33.11	550437	60426	B.1.5	551436	61878	H.5.2
390358	61222	J.8.1	395350	61499	E.2.2	550446	60799	B.1.4	551438	60570	A.13.7
390359	61223	J.8.2	395432	63803	E.2.1	550453	60426	B.1.5	551449	60971	A.5.2
390533	61946	F.1.1	395634	62229	C.7.11	550455	60810	B.1.5	551450	61832	A.13.9
390546	63337	C.6.7	395635	62230	C.7.12	550458	62013	B.1.6	551456	60573	A.4.1
390581	63297	A.21.15	396851	61657	I.7.1	550464	62013	B.1.6	551457	60575	A.5.1
390684	64132	O.1.1	396853	61658	I.7.2	550465	60810	B.1.5	551459	60575	A.5.1
390784	61656	M.2.7	397266	609831	G.2.17	550469	63931	A.4.4	551466	61833	A.13.9
390918	63863	A.13.6	397308	62274	A.21.10	550520	60897	C.1.4	551469	60587	A.4.1
391496	60532	M.1.1	397308	62274	J.8.11	550521	60900	C.1.5	551470	60576	A.5.1

ALL THE COMPONENTS LISTED IN OUR CATALOGUE ARE NOT ORIGINAL, THOUGH PERFECTLY INTERCHANGEABLE. REFERENCE NUMBERS, EITHER ORIGINAL OR OF A DIFFERENT NATURE, ARE FOR INFORMATION PURPOSES ONLY. WHEN PLACING AN ORDER, PLEASE, ALWAYS USE COSIBO REFERENCE NUMBERS AND DO NOT MENTION THE ORIGINAL REFERENCE NUMBERS OF THE TRUCK MANUFACTURERS IN THE INVOICE TO VEHICLE OWNERS OR TO ANYBODY ELSE. THE CUSTOMER TAKES HIS OWN RESPONSIBILITY IF HE DOES NOT COMPLY WITH WHAT ABOVE.

Cross reference SCANIA - COSIBO

Replacing	COSIBO	Page	Replacing	COSIBO	Page	Replacing	COSIBO	Page	Replacing	COSIBO	Page
551476	61180	A.26.6	635562	635562	L.1.6	812418	63562	C.1.9	813938	64092	A.105.5
551477	64188	A.26.8	639320	65243	L.6.1	812418	63562	F.2.6	813938	64092	B.50.2
551484	60972	A.4.2	644982	644982	C.7.4	812418	63562	G.2.14	813938	64092	C.50.3
551500	61560	A.4.1	650892	650892	H.6.7	812418	63562	H.6.1	813938	64092	H.50.3
551505	64749	A.5.1	716360	62245	J.8.2	812418	63562	M.5.2	813938	64092	I.105.4
551512	61560	A.4.1	750226	63320	A.14.6	813245	64182	O.1.2	813938	64092	L.60.2
551513	60573	A.4.1	750226	63320	H.6.1	813932	64089	A.105.3	813938	64092	M.30.3
551516	60575	A.5.1	804578	64095	A.105.6	813932	64089	H.50.2	813938	64092	O.2.3
551520	64749	A.5.1	804578	64095	B.50.2	813932	64089	I.105.3	813939	64085	A.105.2
551525	63279	A.4.2	804578	64095	C.50.3	813932	64089	O.2.2	813939	64085	C.50.2
551526	64273	A.5.2	804578	64095	I.105.5	813933	64082	A.105.1	813939	64085	H.50.1
551528	65338	A.5.3	804578	64095	L.60.2	813933	64082	C.50.1	813939	64085	I.105.2
551560	64273	A.5.2	804578	64095	M.30.3	813933	64082	F.50.1	813939	64085	M.30.2
551570	64275	A.4.5	804578	64095	O.2.4	813933	64082	H.60.1	813939	64085	O.2.2
551573	64274	A.4.4	804583	64100	A.105.6	813933	64082	I.105.1	813940	64093	A.105.5
552004	63898	F.5.2	804583	64100	C.50.4	813933	64082	L.60.1	813940	64093	B.50.2
552004	63898	L.2.1	804583	64100	H.50.4	813933	64082	O.2.1	813940	64093	C.50.3
561408	60638	A.27.15	804583	64100	I.105.6	813934	64090	A.105.4	813940	64093	H.50.3
561991	63994	A.5.12	804583	64100	M.30.4	813934	64090	B.50.1	813940	64093	I.105.5
570482	65124	A.21.2	804583	64100	O.2.5	813934	64090	C.50.2	813940	64093	L.60.2
570485	65398	A.21.3	804589	64096	A.105.6	813934	64090	F.50.1	813940	64093	O.2.4
570490	62290	A.21.2	804589	64096	H.50.4	813934	64090	H.50.2	813941	64086	A.105.3
570491	62260	A.21.1	804589	64096	I.105.6	813934	64090	I.105.3	813941	64086	C.50.2
570955	60633	A.26.1	804591	64101	A.105.7	813934	64090	L.60.1	813941	64086	H.50.2
570956	60634	A.26.2	804591	64101	H.50.4	813934	64090	O.2.3	813941	64086	I.105.2
570957	60060	A.26.1	804591	64101	I.105.6	813935	64083	A.105.1	813941	64086	M.30.2
570958	64008	A.26.4	804591	64101	O.2.5	813935	64083	C.50.1	813941	64086	O.2.2
570964	64123	A.26.4	804658	63338	C.6.7	813935	64083	H.50.1	813942	64094	A.105.5
571055	61000	A.26.3	804664	64408	A.5.13	813935	64083	I.105.1	813942	64094	C.50.3
571059	61002	A.26.3	804664	64408	C.3.6	813935	64083	L.60.1	813942	64094	I.105.5
571067	61174	A.26.3	804664	64408	M.5.2	813935	64083	O.2.1	813942	64094	O.2.4
571150	64167	A.26.5	804666	63331	C.6.2	813936	64091	A.105.4	814195	64187	A.23.10
571153	64645	A.26.6	804670	64790	A.28.5	813936	64091	B.50.1	814195	64187	N.31.2
571154	63856	A.26.4	804670	64790	C.7.17	813936	64091	C.50.2	814209	61322	A.23.5
571254	63324	B.2.1	804670	64790	E.1.3	813936	64091	F.50.1	814209	61322	N.31.1
571316	65102	B.2.10	804670	64790	L.8.1	813936	64091	H.50.3	814210	60484	A.23.5
571467	64795	N.30.9	804672	63337	C.6.7	813936	64091	I.105.4	814210	60484	N.31.1
572950	64866	B.2.12	804674	63332	C.6.3	813936	64091	L.60.2	814346	63068	H.5.6
574908	64423	B.2.9	804690	63999	L.7.3	813936	64091	M.30.3	814349	63071	H.5.6
574911	65102	B.2.10	804710	63339	C.6.6	813936	64091	O.2.3	814350	63073	H.5.7
575100	61002	A.26.3	804713	63333	C.6.3	813937	64084	A.105.2	815454	63068	H.5.6
575171	64371	J.1.7	804782	60543	H.40.9	813937	64084	B.50.1	815457	63071	H.5.6
579265	64795	N.30.9	804958	61154	H.40.5	813937	64084	C.50.1	815458	63073	H.5.7
581025	62354	I.48.6	807351	64823	C.7.10	813937	64084	H.50.1	815459	63074	H.5.7
581201	63739	I.7.12	808214	61352	B.1.8	813937	64084	I.105.1	815462	62393	H.5.6
584085	62285	I.56.5	811768	61154	H.40.5	813937	64084	L.60.1	816089	61314	L.2.12
588002	63680	I.56.5	811911	61314	L.2.12	813937	64084	M.30.1	1100816	61519	H.40.8
622591	622591	A.13.10	812418	63562	A.7.12	813937	64084	O.2.1	1100867	61199	A.5.10

ALL THE COMPONENTS LISTED IN OUR CATALOGUE ARE NOT ORIGINAL, THOUGH PERFECTLY INTERCHANGEABLE. REFERENCE NUMBERS, EITHER ORIGINAL OR OF A DIFFERENT NATURE, ARE FOR INFORMATION PURPOSES ONLY. WHEN PLACING AN ORDER, PLEASE, ALWAYS USE COSIBO REFERENCE NUMBERS AND DO NOT MENTION THE ORIGINAL REFERENCE NUMBERS OF THE TRUCK MANUFACTURERS IN THE INVOICE TO VEHICLE OWNERS OR TO ANYBODY ELSE. THE CUSTOMER TAKES HIS OWN RESPONSIBILITY IF HE DOES NOT COMPLY WITH WHAT ABOVE.

Cross reference SCANIA - COSIBO

Replacing	COSIBO	Page	Replacing	COSIBO	Page	Replacing	COSIBO	Page	Replacing	COSIBO	Page
1100997	60014	A.1.2	1111056	64646	L.1.1	1122696	61548	A.32.1	1305644	63192	A.24.4
1102581	61909	A.7.21	1111056	64646	L.1.4	1300043	65187	C.8.5	1305676	63389	C.6.2
1102585	62231	C.7.12	1111459	65186	C.2.4	1300097	65183	C.7.13	1305959	61834	A.8.2
1103026	635561	L.1.5	1111459	65186	J.3.2	1300367	63097	A.33.9	1306198	62275	I.50.2
1103422	60415	A.7.7	1111494	63084	A.31.2	1300831	64683	N.1.10	1306379	62294	J.10.3
1103619	61764	B.2.2	1111745	60237	D.2.1	1300974	63330	C.5.2	1306403	62364	I.50.2
1103619	61764	C.3.2	1112015	60420	O.2.6	1300974	63330	F.2.1	1306404	62365	I.50.2
1103635	61531	H.3.2	1112539	61529	H.4.3	1301628	61921	A.16.2	1306492	63620	J.4.1
1103934	62461	B.2.2	1112540	61529	H.4.3	1301629	61922	A.16.3	1306975	61728	I.48.9
1103934	62461	C.3.3	1112542	60413	H.4.1	1301696	60434	C.1.1	1306976	61729	I.48.9
1104500	65214	G.2.5	1112702	61849	G.2.15	1301696	60434	F.2.1	1307340	65226	H.40.7
1104544	64248	H.40.1	1112829	63346	H.13.8	1302008	62030	J.8.4	1307770	651551	A.28.4
1104545	64247	H.40.1	1112830	63347	H.13.9	1302530	63991	A.29.26	1307793	62227	B.2.8
1104548	64248	H.40.1	1112831	63348	H.13.9	1302531	63992	A.29.26	1307953	62217	A.5.16
1104549	64247	H.40.1	1112833	63349	H.13.9	1302771	61974	I.54.4	1308473	63600	N.1.7
1105073	60663	A.29.18	1112834	63350	H.13.10	1302772	65390	I.54.4	1308474	63599	N.1.7
1105074	60664	A.29.18	1113031	64524	D.1.2	1302791	64829	H.6.11	1308589	61483	A.16.2
1105075	60665	A.29.18	1113033	62041	D.1.1	1302827	61837	A.7.2	1308643	61933	M.2.1
1105076	60666	A.29.19	1114170	62253	A.33.1	1302828	61631	A.7.1	1308969	62226	B.2.7
1105077	60667	A.29.19	1114314	64828	H.6.10	1302857	60957	H.13.14	1309051	63547	A.13.6
1105078	60668	A.29.19	1114622	64071	C.4.1	1302914	64098	B.3.4	1309465	61519	H.40.8
1105079	60657	A.29.16	1114685	61961	B.1.4	1303318	61988	I.51.1	1309563	61643	C.6.4
1105080	60658	A.29.17	1114838	63262	C.3.1	1303471	63055	C.2.6	1309571	61531	H.3.2
1105081	60659	A.29.17	1115287	64249	H.5.4	1303471	63055	F.4.2	1312934	61632	A.7.2
1105082	60660	A.29.17	1116362	65266	J.8.3	1303471	63055	N.40.2	1312934	61632	B.3.2
1105083	60661	A.29.17	1116635	60415	A.7.7	1303472	61953	C.2.5	1312934	61632	H.6.8
1105084	60662	A.29.18	1116698	61585	F.2.7	1303472	61953	F.4.1	1313325	60894	H.3.1
1105218	61473	A.1.1	1116699	61587	F.2.8	1303798	63335	C.6.5	1313326	60893	H.3.1
1105332	61961	B.1.4	1116847	61640	F.2.4	1303951	61746	A.29.21	1313459	60003	A.3.1
1105803	62334	J.1.5	1116848	61586	F.2.7	1303952	61747	A.29.21	1313592	61964	I.54.2
1105970	62386	O.1.2	1116987	62108	A.1.2	1303953	61748	A.29.21	1313594	61965	I.54.3
1105971	60420	O.2.6	1117253	62249	N.30.8	1303954	61749	A.29.21	1313606	63750	A.2.5
1105972	61324	J.8.10	1117285	60455	A.14.14	1303955	61750	A.29.22	1313676	63374	A.29.25
1106953	61657	I.7.1	1117597	64397	A.21.10	1303956	61751	A.29.22	1313677	63373	A.29.25
1106955	61658	I.7.2	1117597	64397	D.2.3	1303957	61752	A.29.22	1313678	63954	A.29.23
1108053	63303	A.13.30	1117597	64397	F.2.6	1303958	61753	A.29.22	1313679	63955	A.29.24
1108223	61878	H.5.2	1117705	61530	H.3.1	1304292	63372	A.5.7	1313680	63956	A.29.24
1108227	61878	H.5.2	1118188	62249	N.30.8	1304571	61923	M.2.1	1313681	63957	A.29.24
1108445	60778	B.2.1	1118446	61506	L.7.3	1304725	62223	A.12.1	1313682	63958	A.29.24
1108488	62218	A.5.17	1118884	61903	J.8.16	1304781	63324	B.2.1	1313683	63959	A.29.25
1109278	63377	A.13.18	1120398	63594	N.30.7	1304786	62523	N.2.3	1313719	60993	G.2.10
1109279	63378	A.13.18	1120646	65192	C.1.2	1304787	62420	N.2.3	1314406	61002	A.26.3
1109288	61836	A.13.4	1120873	64164	G.2.13	1304914	64410	A.5.11	1314653	62356	J.1.1
1109870	61023	A.10.2	1120880	61493	B.1.7	1304914	64410	C.3.7	1315195	63175	A.21.14
1109871	60998	A.22.9	1120881	61350	B.1.7	1304914	64410	H.5.8	1315437	63334	C.6.4
1110201	61988	I.51.1	1120884	61344	B.1.7	1305055	61519	H.40.8	1315559	63107	A.33.11
1110588	64646	L.1.1	1121763	62033	J.8.5	1305139	63124	C.1.3	1315681	62552	G.2.4
1110588	64646	L.1.4	1122620	61109	A.2.6	1305341	65001	A.11.1	1316330	63153	A.12.3

ALL THE COMPONENTS LISTED IN OUR CATALOGUE ARE NOT ORIGINAL, THOUGH PERFECTLY INTERCHANGEABLE. REFERENCE NUMBERS, EITHER ORIGINAL OR OF A DIFFERENT NATURE, ARE FOR INFORMATION PURPOSES ONLY. WHEN PLACING AN ORDER, PLEASE, ALWAYS USE COSIBO REFERENCE NUMBERS AND DO NOT MENTION THE ORIGINAL REFERENCE NUMBERS OF THE TRUCK MANUFACTURERS IN THE INVOICE TO VEHICLE OWNERS OR TO ANYBODY ELSE. THE CUSTOMER TAKES HIS OWN RESPONSIBILITY IF HE DOES NOT COMPLY WITH WHAT ABOVE.

Cross reference SCANIA - COSIBO

Replacing	COSIBO	Page	Replacing	COSIBO	Page	Replacing	COSIBO	Page	Replacing	COSIBO	Page
1316331	63152	A.12.2	1326935	62341	I.56.3	1334196	65278	N.30.3	1342121	61530	H.3.1
1317538	61969	I.50.3	1327013	63465	N.30.4	1334704	63152	A.12.2	1342340	61152	H.13.15
1317682	63548	A.7.3	1327015	64134	J.3.3	1335482	63466	N.30.5	1342708	64301	G.2.12
1317885	63759	C.7.6	1327249	62260	A.21.1	1335485	63569	B.3.2	1342745	64260	H.12.2
1318075	61909	A.7.21	1327274	60023	N.1.11	1335618	65088	A.33.1	1342746	64261	H.12.2
1318091	60111	A.7.15	1327274	60023	N.3.2	1335674	64009	A.16.8	1342747	64255	H.12.3
1318306	63450	N.30.4	1327413	61651	G.2.5	1335678	62403	A.16.6	1342748	64254	H.12.3
1318388	63128	B.3.3	1327886	61878	H.5.2	1336138	64278	A.13.6	1343100	65255	J.8.15
1318388	63128	C.3.4	1328177	62276	J.3.2	1336159	60810	B.1.5	1343131	64072	J.8.15
1318506	64052	J.2.7	1328242	64409	A.5.13	1336380	64165	G.2.14	1343134	62010	J.8.15
1318762	63344	C.6.6	1328242	64409	C.3.6	1336882	62040	A.18.2	1343149	63873	J.8.9
1318911	62313	A.21.13	1328242	64409	H.5.9	1336882	62040	C.9.1	1343155	60418	O.2.6
1319081	61476	A.1.4	1328537	63545	A.1.4	1336885	60435	A.18.2	1343156	60418	O.2.6
1319557	63276	C.2.2	1328548	63467	N.30.5	1337366	60861	E.2.4	1343178	61227	L.7.1
1320290	61191	A.14.11	1328597	64397	A.21.10	1337367	60862	E.2.4	1343262	64003	M.2.6
1320292	61553	A.13.3	1328597	64397	D.2.3	1337777	66606	H.3.3	1343266	63589	M.2.3
1320602	65021	A.21.4	1328597	64397	F.2.6	1337957	63761	J.2.5	1343283	63587	M.2.3
1320973	63416	A.5.7	1328995	63549	A.7.4	1337958	62374	J.2.5	1343373	65288	E.1.3
1321255	61910	B.2.5	1329551	61993	I.51.1	1338018	65226	H.40.7	1344182	64397	A.21.10
1321259	61866	B.2.11	1329552	61992	I.51.1	1338019	61153	H.13.15	1344182	64397	D.2.3
1321260	60790	B.2.4	1329585	63123	C.1.3	1338071	60343	A.33.1	1344182	64397	F.2.6
1321420	62469	C.6.1	1329586	64312	C.1.4	1338128	60343	A.33.1	1344190	62233	L.2.10
1321727	64088	H.13.1	1329876	62361	A.14.15	1338490	61174	A.26.3	1345151	62470	C.6.1
1322142	61909	A.7.21	1329876	62361	C.3.6	1338491	64726	L.2.5	1345206	64727	M.2.7
1322341	62236	L.2.10	1329876	62361	H.6.7	1338769	63852	L.5.1	1345492	62228	C.2.10
1323354	61838	A.13.5	1331139	63930	O.2.7	1339680	64723	G.2.18	1345729	66606	H.3.3
1323400	62376	J.2.1	1331164	64049	J.4.1	1339877	63550	A.5.8	1346119	64025	I.48.12
1323401	62372	J.2.2	1331309	63166	A.16.10	1340201	61869	A.27.8	1346177	64023	I.48.4
1323410	62377	J.2.2	1331309	63166	H.6.2	1340231	65191	A.12.3	1346178	64024	I.48.5
1323416	63866	J.2.1	1331770	60808	B.1.1	1340231	65191	C.2.3	1346181	64368	I.48.4
1323821	64804	J.5.3	1331820	64778	A.21.19	1340231	65191	E.3.1	1346377	63712	I.7.3
1323823	61916	A.7.21	1331820	64778	C.1.9	1340231	65191	F.10.1	1346380	65418	I.7.13
1324358	65387	H.13.12	1331820	64778	F.2.6	1340231	65191	H.8.1	1346381	63797	I.7.10
1324366	62237	L.2.11	1332090	65273	J.8.1	1340231	65191	J.6.2	1346382	63860	I.7.10
1324596	61991	I.51.4	1332193	64648	A.22.4	1340231	65191	L.6.2	1346425	62294	J.10.3
1324597	61989	I.51.4	1332320	62035	I.54.2	1340231	65191	N.40.1	1346579	63370	I.7.5
1324598	61990	I.51.5	1332503	61536	A.12.1	1340408	63567	B.1.9	1346601	62488	J.10.2
1324599	62255	N.4.1	1332503	61536	H.4.1	1340548	66606	H.3.3	1346606	66583	C.7.14
1324600	62254	N.4.1	1332967	63408	A.13.11	1340615	60429	A.29.2	1346608	66585	C.7.14
1324663	62459	H.8.2	1332968	63409	A.13.11	1340859	64065	H.12.1	1346612	665781	C.7.15
1324664	62459	H.8.2	1332969	63410	A.13.11	1340860	64064	H.12.1	1346905	63540	I.48.5
1324712	65263	J.8.14	1332970	63411	A.13.11	1340899	63781	A.13.13	1346906	63541	I.48.5
1324713	65261	J.8.13	1332971	63412	A.13.12	1341069	63765	H.14.2	1346907	64826	I.48.5
1325066	65501	F.2.2	1333116	63413	A.13.24	1341110	62486	J.10.2	1347572	65483	L.6.3
1325265	61976	I.54.5	1333183	62519	A.7.15	1341683	63846	B.2.13	1347594	63171	A.24.1
1325266	61975	I.54.5	1333230	63546	A.1.3	1341701	63675	A.29.23	1348117	60438	J.9.2
1325383	64357	C.7.8	1333735	63764	H.14.2	1341702	63676	A.29.23	1348121	64168	J.9.1
1325626	65318	J.1.8	1334037	60304	C.2.1	1341729	63602	A.27.9	1348539	63915	N.1.6

ALL THE COMPONENTS LISTED IN OUR CATALOGUE ARE NOT ORIGINAL, THOUGH PERFECTLY INTERCHANGEABLE. REFERENCE NUMBERS, EITHER ORIGINAL OR OF A DIFFERENT NATURE, ARE FOR INFORMATION PURPOSES ONLY. WHEN PLACING AN ORDER, PLEASE, ALWAYS USE COSIBO REFERENCE NUMBERS AND DO NOT MENTION THE ORIGINAL REFERENCE NUMBERS OF THE TRUCK MANUFACTURERS IN THE INVOICE TO VEHICLE OWNERS OR TO ANYBODY ELSE. THE CUSTOMER TAKES HIS OWN RESPONSIBILITY IF HE DOES NOT COMPLY WITH WHAT ABOVE.

Cross reference SCANIA - COSIBO

Replacing	COSIBO	Page	Replacing	COSIBO	Page	Replacing	COSIBO	Page	Replacing	COSIBO	Page
1348540	63916	N.1.6	1354428	63782	A.13.13	1358996	63193	A.24.4	1365960	63357	N.3.1
1348896	61536	A.12.1	1354593	62328	I.30.1	1360069	63779	H.2.1	1365961	63356	N.3.2
1348896	61536	H.4.1	1354594	62338	I.30.2	1360368	65328	H.14.3	1365968	61661	N.2.2
1349010	62406	J.1.1	1355353	63783	A.13.13	1360833	61477	A.1.5	1365969	61662	N.2.2
1349018	64411	A.5.12	1355655	63733	I.56.3	1360834	60014	A.1.2	1366141	63800	I.7.11
1349018	64411	C.3.7	1355656	62550	I.56.2	1360836	65336	A.1.2	1366384	62275	I.50.2
1349018	64411	H.5.9	1355667	64114	I.56.1	1360842	65174	B.1.3	1366735	62537	J.10.2
1349045	61908	A.13.17	1355703	64087	A.8.7	1361131	64070	H.8.3	1366764	64026	I.48.12
1349045	61908	H.2.1	1355979	64122	B.1.5	1361131	64070	L.6.1	1366781	62536	J.10.2
1349089	64800	H.12.4	1356022	60754	C.7.1	1361136	61961	B.1.4	1366832	62411	I.50.2
1349497	63559	A.7.6	1356372	62232	C.7.14	1361193	61473	A.1.1	1366836	64102	J.10.1
1349714	64277	A.16.4	1356668	62145	J.8.5	1361196	61475	A.1.1	1366837	62484	J.10.1
1349781	65373	N.1.6	1356677	63375	A.13.22	1361198	61187	A.7.7	1366838	62485	J.10.1
1349782	65374	N.1.7	1356695	65388	H.13.12	1361331	60743	H.10.1	1366849	61607	I.48.10
1349805	60481	J.8.14	1356696	65389	H.13.13	1361413	64310	E.2.1	1366850	62343	I.48.10
1349810	60488	J.8.14	1356880	64868	A.7.14	1361983	60346	A.33.3	1366850	62343	I.48.10
1349840	62296	J.9.3	1357341	65150	A.27.13	1362071	63327	C.7.6	1366851	62422	J.10.4
1349968	65325	A.22.4	1357342	65149	A.27.7	1362168	65425	H.8.4	1367027	63804	A.8.4
1350317	65176	J.3.1	1357380	66584	J.1.9	1362222	61759	A.7.14	1367028	63085	A.8.3
1350343	63359	N.3.3	1357381	66582	J.8.12	1362693	64389	I.54.12	1367370	61858	L.2.13
1350394	64081	A.27.16	1357599	60341	I.54.1	1362707	65542	I.30.9	1367453	62012	B.1.2
1350440	64112	O.2.5	1357600	60340	I.54.1	1362707	65542	N.2.4	1367604	60789	B.2.3
1350441	64113	O.2.5	1357602	62306	I.54.6	1362708	62308	I.54.1	1367849	64853	A.5.14
1350817	61879	H.13.13	1357628	64000	A.29.29	1362710	61859	L.2.14	1367972	64293	C.8.2
1350909	61759	A.7.14	1357633	64000	A.29.29	1362721	61152	H.13.15	1368039	64111	J.8.10
1351075	62221	A.24.3	1357674	64343	E.2.4	1363120	62266	J.9.1	1368061	62490	A.5.5
1351193	62414	I.30.5	1357674	64343	F.5.1	1363131	62276	J.3.2	1368123	63438	N.3.1
1351194	62415	I.30.6	1357674	64343	M.2.5	1363545	65146	A.27.6	1368652	62307	I.54.2
1351203	62353	I.30.9	1357942	64117	L.7.7	1363634	60479	A.21.5	1368681	65310	L.7.7
1351692	64144	A.7.22	1358175	60517	N.30.1	1363673	64166	G.2.14	1368682	65302	L.7.7
1352866	63555	A.7.5	1358288	63362	J.2.4	1363674	61851	G.2.12	1368690	609831	G.2.17
1352866	63555	C.1.8	1358289	63363	J.2.4	1364102	64213	I.35.1	1368693	60984	G.2.17
1352885	63554	A.7.4	1358290	63364	J.2.4	1364103	64214	I.35.1	1368694	60983	G.2.16
1352885	63554	C.1.8	1358291	62375	J.2.5	1364140	62111	L.2.21	1368735	61759	A.7.14
1353010	64307	A.26.2	1358296	65145	A.27.13	1364290	63778	A.33.8	1368736	61759	A.7.14
1353072	60633	A.26.1	1358384	64288	A.27.2	1364355	60432	A.33.6	1369053	62455	J.1.5
1353142	62398	H.4.3	1358497	64031	G.2.1	1364636	63755	C.2.2	1369411	60985	E.2.1
1353142	62398	N.30.3	1358634	63894	H.13.10	1364665	62441	I.52.1	1369553	64062	J.4.2
1353735	62373	J.2.2	1358635	63893	H.13.11	1364666	62440	I.52.1	1369555	63326	C.7.5
1353959	65282	J.8.11	1358792	60521	E.2.3	1364851	65296	H.6.4	1369806	65027	L.2.4
1353959	65282	J.8.12	1358792	60521	F.5.1	1364902	62518	H.14.2	1369848	61745	A.32.1
1353965	65269	J.8.10	1358792	60521	M.2.4	1365170	63594	N.30.7	1369917	62135	M.2.1
1354103	64167	A.26.5	1358793	60522	E.2.3	1365371	65124	A.21.2	1369975	64244	C.7.6
1354110	62405	J.5.2	1358793	60522	F.5.1	1365510	60986	G.2.16	1369981	60111	A.7.15
1354390	64121	A.23.7	1358793	60522	M.2.5	1365594	64032	G.2.2	1370107	62448	I.55.7
1354420	63780	A.13.12	1358828	65273	J.8.1	1365841	60634	A.26.2	1370108	62447	I.55.7
1354423	63784	A.13.13	1358833	65411	N.1.3	1365958	63357	N.3.1	1370141	64099	L.4.1
1354424	63785	A.13.13	1358995	63172	A.24.2	1365959	63356	N.3.2	1370142	65028	L.2.22

ALL THE COMPONENTS LISTED IN OUR CATALOGUE ARE NOT ORIGINAL, THOUGH PERFECTLY INTERCHANGEABLE. REFERENCE NUMBERS, EITHER ORIGINAL OR OF A DIFFERENT NATURE, ARE FOR INFORMATION PURPOSES ONLY. WHEN PLACING AN ORDER, PLEASE, ALWAYS USE COSIBO REFERENCE NUMBERS AND DO NOT MENTION THE ORIGINAL REFERENCE NUMBERS OF THE TRUCK MANUFACTURERS IN THE INVOICE TO VEHICLE OWNERS OR TO ANYBODY ELSE. THE CUSTOMER TAKES HIS OWN RESPONSIBILITY IF HE DOES NOT COMPLY WITH WHAT ABOVE.

Cross reference SCANIA - COSIBO

Replacing	COSIBO	Page	Replacing	COSIBO	Page	Replacing	COSIBO	Page	Replacing	COSIBO	Page
1370254	61460	A.7.20	1374500	64034	A.22.8	1376832	62250	I.51.3	1380160	63330	C.5.2
1370267	62062	L.1.2	1374642	62395	J.4.1	1376871	64347	A.31.1	1380160	63330	F.2.1
1370267	62062	L.1.3	1374700	63376	A.13.17	1376895	65131	A.27.10	1380264	64295	J.1.12
1370329	62100	I.55.2	1374889	65283	H.2.2	1376896	65133	A.27.11	1380324	64117	L.7.7
1370330	62101	I.55.2	1375002	63767	A.10.3	1376911	64103	A.5.10	1380451	63377	A.13.18
1370488	63867	C.8.5	1375228	63591	M.2.5	1376911	64103	H.7.1	1380621	65132	A.27.10
1371200	623241	J.1.9	1375299	65262	J.8.13	1376949	65145	A.27.13	1380814	64189	L.5.2
1371201	623244	J.1.10	1375369	63571	A.29.27	1377039	63565	A.3.2	1380819	60492	N.3.3
1371207	623242	J.1.9	1375370	63572	A.29.27	1377056	63700	L.1.4	1380880	65026	H.14.3
1371208	623243	J.1.10	1375371	63573	A.29.28	1377231	63601	A.27.9	1381069	63920	A.13.15
1371209	63378	A.13.18	1375372	63574	A.29.28	1377231	63601	C.8.3	1381070	63921	A.13.15
1371292	61663	N.2.3	1375373	63575	A.29.28	1377331	65144	A.27.13	1381235	62361	A.14.15
1371293	61664	N.2.3	1375374	63576	A.29.29	1377332	65143	A.27.13	1381235	62361	C.3.6
1371717	64438	H.14.3	1375382	64723	G.2.18	1377386	63759	C.7.6	1381235	62361	H.6.7
1371729	63139	A.18.3	1375383	63114	A.9.2	1377562	60482	J.8.7	1381479	62364	I.50.2
1371754	63918	I.50.4	1375390	64721	M.5.1	1377566	62478	C.8.5	1381480	62365	I.50.2
1371757	62311	I.50.1	1375391	65359	M.5.1	1377567	62479	C.8.5	1381563	62291	I.55.10
1371758	62312	I.50.1	1375427	62444	N.4.2	1377571	61174	A.26.3	1381564	62292	I.55.11
1371782	65319	A.22.8	1375428	62443	N.4.2	1377692	65028	L.2.22	1381565	62431	I.55.3
1371839	62512	A.21.21	1375493	61936	A.28.3	1377728	60912	L.2.14	1381566	62430	I.55.3
1371839	62512	H.6.8	1375497	62406	J.1.1	1377739	635561	L.1.5	1381926	61463	A.21.13
1371839	62512	J.2.6	1375601	64288	A.27.2	1377799	61550	L.2.2	1382071	63374	A.29.25
1371856	61971	I.50.1	1375602	63192	A.24.4	1377930	65479	A.14.14	1382072	63954	A.29.23
1371857	62305	I.50.4	1375603	65150	A.27.13	1377930	65479	N.30.19	1382073	63955	A.29.24
1372154	63764	H.14.2	1375604	65149	A.27.7	1377993	64291	C.8.3	1382074	63956	A.29.24
1372155	63765	H.14.2	1375688	65503	A.2.1	1377996	64850	C.8.2	1382075	63991	A.29.26
1372174	64382	I.56.4	1375689	65504	A.2.2	1377997	65122	C.8.3	1382110	60506	A.17.1
1372432	62243	J.8.11	1375689	65504	N.30.18	1378194	61966	I.54.6	1382113	60506	A.17.1
1372444	60630	A.30.1	1375718	63175	A.21.14	1378435	61499	E.2.2	1382331	65379	B.2.11
1372510	61710	J.8.17	1375837	61005	A.26.1	1378527	65073	J.1.2	1382490	65296	H.6.4
1372543	61494	C.3.3	1375838	64645	A.26.6	1378531	65074	J.1.3	1382727	62429	I.55.4
1372545	64346	A.23.8	1375839	63856	A.26.4	1378541	64806	A.12.4	1382728	62428	I.55.4
1372786	65300	L.7.8	1375859	65127	A.27.5	1378882	63593	N.30.6	1382826	62268	J.9.3
1372850	65207	L.10.1	1375874	65136	A.27.12	1378883	63594	N.30.7	1382827	62211	J.9.2
1373126	64777	A.21.19	1376226	65128	A.27.9	1379071	61119	M.2.2	1382829	62268	J.9.3
1373479	64028	A.32.4	1376279	61831	H.5.5	1379168	60985	E.2.1	1383129	63345	F.2.1
1373520	665791	A.22.7	1376280	61830	H.5.5	1379244	62239	J.8.10	1383496	64067	J.8.8
1373793	64791	L.2.9	1376281	61790	H.5.3	1379384	62269	N.3.4	1383520	62256	I.52.3
1373919	65125	A.27.9	1376291	65147	A.27.6	1379621	63844	C.7.15	1383609	62280	I.50.1
1374040	65129	A.27.10	1376293	65130	A.27.10	1379707	63164	H.6.2	1383858	61907	I.54.6
1374040	65129	C.8.3	1376294	65146	A.27.6	1379814	62496	I.56.2	1383863	65283	H.2.2
1374083	61878	H.5.2	1376295	65372	A.27.4	1379888	65371	A.21.18	1383873	65134	A.27.11
1374099	65227	A.13.20	1376474	65233	H.4.2	1379888	65371	H.5.4	1383887	62412	I.50.2
1374305	60279	G.2.2	1376495	64854	A.26.2	1379922	64097	B.3.3	1383888	62413	I.50.3
1374326	64022	A.9.2	1376794	65470	C.2.3	1379952	60631	J.5.6	1383956	65436	L.6.2
1374338	62542	A.16.3	1376794	65470	E.3.1	1379997	62285	I.56.5	1383990	65135	A.27.11
1374340	62542	A.16.3	1376794	65470	F.10.1	1380034	64373	J.2.1	1384025	61119	M.2.2
1374413	63779	H.2.1	1376794	65470	H.8.1	1380106	62453	C.8.4	1384027	63306	M.2.2

ALL THE COMPONENTS LISTED IN OUR CATALOGUE ARE NOT ORIGINAL, THOUGH PERFECTLY INTERCHANGEABLE. REFERENCE NUMBERS, EITHER ORIGINAL OR OF A DIFFERENT NATURE, ARE FOR INFORMATION PURPOSES ONLY. WHEN PLACING AN ORDER, PLEASE, ALWAYS USE COSIBO REFERENCE NUMBERS AND DO NOT MENTION THE ORIGINAL REFERENCE NUMBERS OF THE TRUCK MANUFACTURERS IN THE INVOICE TO VEHICLE OWNERS OR TO ANYBODY ELSE. THE CUSTOMER TAKES HIS OWN RESPONSIBILITY IF HE DOES NOT COMPLY WITH WHAT ABOVE.

Cross reference SCANIA - COSIBO

Replacing	COSIBO	Page	Replacing	COSIBO	Page	Replacing	COSIBO	Page	Replacing	COSIBO	Page
1384059	62290	A.21.2	1387022	64178	N.30.5	1391322	63447	N.30.4	1397052	64764	A.33.5
1384089	65279	A.13.21	1387044	64292	C.8.2	1391386	61852	H.5.3	1397273	63094	A.33.4
1384116	63963	H.6.9	1387136	63323	A.33.10	1391386	61852	H.5.8	1397435	62260	A.21.1
1384353	64068	L.2.1	1387155	60512	N.2.1	1391425	62472	J.7.1	1397521	60014	A.1.2
1384464	65137	A.27.12	1387191	62534	A.32.3	1391426	62471	J.7.1	1397523	63019	L.1.2
1384501	61955	A.28.5	1387193	62535	A.32.3	1391676	65178	B.1.6	1397570	61971	I.50.1
1384549	64118	A.14.2	1387283	65517	L.9.2	1391676	65178	H.4.5	1397571	62305	I.50.4
1384551	61844	A.9.1	1387283	65517	L.9.3	1391726	63563	A.7.13	1397796	65319	A.22.8
1384552	60565	A.16.1	1387542	64058	A.16.8	1391795	65141	A.27.6	1397851	64228	C.2.7
1384554	61921	A.16.2	1387547	64375	A.16.8	1391796	65140	A.27.5	1397851	64228	N.30.12
1384555	61922	A.16.3	1387548	63618	A.16.6	1392196	61191	A.14.11	1397866	61499	E.2.2
1384624	60754	C.7.1	1387549	60367	A.16.5	1392261	64156	A.22.3	1398624	60018	A.1.6
1384872	61192	A.14.11	1387609	64725	I.32.1	1392276	65139	A.27.5	1398636	62534	A.32.3
1384896	61208	C.7.3	1387764	64633	D.1.2	1392459	63862	A.13.5	1398636	62534	A.32.3
1384897	60907	C.7.2	1387794	64634	D.1.2	1392459	61483	A.16.2	1399180	63852	L.5.1
1384898	60908	C.7.3	1387823	62336	A.33.2	1392708	64351	A.11.3	1399776	63646	J.8.16
1385086	65142	A.27.12	1387870	63962	I.35.1	1392755	64053	J.2.7	1400209	62234	N.1.3
1385170	60490	J.8.7	1387877	60501	N.3.3	1392929	65119	A.14.2	1400213	61991	I.51.4
1385251	60985	E.2.1	1387878	60500	N.3.3	1392930	60973	A.16.2	1400769	65233	H.4.2
1385402	62387	N.1.5	1387983	60556	A.33.7	1392931	60969	A.16.1	1400899	64650	I.54.8
1385403	62388	N.1.5	1388070	63929	A.21.10	1392932	61842	A.9.1	1400900	64651	I.54.8
1385406	62358	N.1.4	1388070	63929	B.8.1	1392933	65345	A.9.2	1401436	63187	J.5.2
1385407	62359	N.1.5	1388070	63929	H.6.9	1392935	61230	A.10.1	1401788	63465	N.30.4
1385409	65377	N.1.10	1388417	63769	L.1.2	1393103	65526	I.48.3	1401789	63467	N.30.5
1385410	60511	N.2.1	1388678	60206	A.8.1	1393113	63847	A.12.2	1401839	62534	A.32.3
1385413	65375	N.1.10	1388680	65001	A.11.1	1393113	63847	N.30.8	1401839	62534	A.32.3
1385829	62487	J.10.3	1388681	60589	A.11.1	1393161	63117	B.2.5	1401840	62535	A.32.3
1385836	64295	J.1.12	1388682	60567	A.10.1	1393163	60790	B.2.4	1401840	62535	A.32.3
1386104	62466	L.7.6	1388684	61762	A.7.5	1393331	63330	C.5.2	1401929	62310	I.50.1
1386199	65548	L.9.2	1388823	60915	L.2.4	1393331	63330	F.2.1	1401931	63917	I.50.4
1386200	65549	L.9.1	1389024	64183	A.23.10	1393332	60155	B.1.1	1401982	65344	A.8.6
1386227	63997	L.7.7	1389028	63639	A.23.6	1393424	64156	A.22.3	1401984	63854	A.8.4
1386271	63356	N.3.2	1389029	63966	A.23.6	1393478	65440	H.11.1	1402272	61622	H.13.2
1386272	63357	N.3.1	1389031	63640	A.23.6	1393640	63718	A.5.11	1402400	61909	A.7.21
1386423	61648	J.8.16	1389042	60129	A.23.5	1393937	61838	A.13.5	1402401	61909	A.7.21
1386424	64206	J.8.17	1389048	64183	A.23.10	1394544	60482	J.8.3	1402423	65516	L.9.2
1386452	61856	B.2.6	1390074	62339	I.30.1	1394884	63585	M.2.3	1402423	65516	L.9.3
1386453	63307	B.2.8	1390075	62327	I.30.1	1395066	65137	A.27.12	1402448	65249	N.30.2
1386454	63308	B.2.8	1390076	68888	I.30.8	1395248	63619	A.13.19	1402449	63809	N.30.2
1386571	65317	J.1.8	1390097	64117	L.7.7	1395276	61966	I.54.6	1402450	64184	N.30.2
1386594	63345	F.2.1	1390428	61906	H.13.3	1395614	64310	E.2.1	1402869	63786	A.22.2
1386647	65334	A.1.3	1390705	65325	A.22.4	1395871	62264	I.51.4	1403129	65352	A.11.2
1386648	65335	A.1.3	1390706	62553	A.22.3	1395994	64509	J.2.6	1403258	60970	A.3.2
1386753	65206	L.7.8	1390747	62442	I.54.7	1396529	62399	I.7.5	1403260	63565	A.3.2
1386957	62281	I.55.5	1391322	63447	A.12.2	1396530	62400	I.7.5	1403587	60003	A.3.1
1386958	62282	I.55.5	1391322	63447	C.2.8	1396541	63801	I.7.12	1403609	66606	H.3.3
1386959	62446	I.55.6	1391322	63447	H.8.2	1396542	62379	I.7.11	1403618	64033	G.2.1
1386960	62445	I.55.6	1391322	63447	J.3.1	1396644	64421	N.40.2	1403823	63896	A.1.7

ALL THE COMPONENTS LISTED IN OUR CATALOGUE ARE NOT ORIGINAL, THOUGH PERFECTLY INTERCHANGEABLE. REFERENCE NUMBERS, EITHER ORIGINAL OR OF A DIFFERENT NATURE, ARE FOR INFORMATION PURPOSES ONLY. WHEN PLACING AN ORDER, PLEASE, ALWAYS USE COSIBO REFERENCE NUMBERS AND DO NOT MENTION THE ORIGINAL REFERENCE NUMBERS OF THE TRUCK MANUFACTURERS IN THE INVOICE TO VEHICLE OWNERS OR TO ANYBODY ELSE. THE CUSTOMER TAKES HIS OWN RESPONSIBILITY IF HE DOES NOT COMPLY WITH WHAT ABOVE.

Cross reference SCANIA - COSIBO

Replacing	COSIBO	Page	Replacing	COSIBO	Page	Replacing	COSIBO	Page	Replacing	COSIBO	Page
1403883	64307	A.26.2	1414200	65309	C.2.4	1423011	60435	A.18.2	1430545	63646	J.8.16
1403954	62313	A.21.13	1414200	65309	H.11.1	1423012	63139	A.18.3	1431177	64373	J.2.1
1404099	65527	I.48.3	1414341	65543	A.5.6	1423017	62347	I.48.6	1431178	63882	J.2.1
1404924	63172	A.24.2	1414395	65335	A.1.3	1423018	62348	I.48.6	1431199	64117	L.7.7
1404925	63171	A.24.1	1414422	63855	A.8.5	1423202	64226	A.7.8	1431254	63916	N.1.6
1405350	65016	A.33.5	1420005	63677	C.2.5	1423207	63644	J.3.4	1431255	63915	N.1.6
1405402	64161	C.7.9	1420005	63677	N.40.2	1423451	65394	A.24.1	1431256	62257	N.1.4
1405406	64162	C.7.9	1420197	60631	J.5.6	1423508	63154	A.21.14	1431257	62258	N.1.3
1405979	63440	N.31.1	1420278	63093	A.33.2	1423566	60304	C.2.1	1431334	62533	I.50.12
1406223	64001	I.48.1	1420474	63769	L.1.2	1423608	61204	A.13.28	1431579	64770	A.33.10
1406224	64002	I.48.1	1420480	64771	A.33.11	1423610	65313	A.13.23	1431701	64016	A.16.9
1406227	65432	I.48.2	1420500	64807	N.30.14	1423990	64370	A.32.4	1431701	64016	H.4.4
1406228	65433	I.48.2	1420776	62489	A.8.2	1424074	64028	A.32.4	1431781	63447	A.12.2
1406465	64429	I.45.3	1420836	61187	A.7.7	1424221	65453	C.2.6	1431781	63447	C.2.8
1406466	64428	I.45.3	1420908	64346	A.23.8	1424221	65453	E.3.2	1431781	63447	H.8.2
1406613	61606	I.48.8	1420911	63968	A.23.8	1424221	65453	N.30.10	1431781	63447	J.3.1
1406614	62195	I.48.9	1421021	62403	A.16.6	1424227	62266	J.9.1	1431781	63447	N.30.4
1407139	63646	J.8.16	1421022	60584	A.16.5	1424231	62296	J.9.3	1431920	64661	N.4.3
1407430	61910	B.2.5	1421062	63769	L.1.2	1424601	64313	N.30.9	1431921	64660	N.4.3
1407661	65207	L.10.1	1421090	60359	A.21.20	1424853	64402	A.16.9	1431922	64657	N.4.4
1407909	63446	N.30.6	1421186	62012	B.1.2	1424854	64403	A.16.10	1431923	64656	N.4.4
1408455	61707	A.13.25	1421322	65191	A.12.3	1424924	64757	A.13.14	1431925	62432	I.51.3
1408465	62344	I.54.7	1421322	65191	C.2.3	1424970	64184	N.30.2	1431926	62433	I.51.3
1408466	62345	I.54.7	1421322	65191	E.3.1	1425019	62390	M.1.1	1431931	64704	I.52.2
1408881	62260	A.21.1	1421322	65191	F.10.1	1425070	64027	J.5.4	1431932	64707	I.52.2
1409551	65178	B.1.6	1421322	65191	H.8.1	1425599	64296	J.1.12	1431933	64698	I.52.1
1409551	65178	H.4.5	1421322	65191	J.6.2	1425659	64369	I.48.4	1431934	64699	I.52.2
1409860	62384	I.54.11	1421322	65191	L.6.2	1425921	64276	A.8.3	1431979	63926	A.24.2
1409889	61297	G.2.8	1421322	65191	N.40.1	1426194	65136	A.27.12	1432186	61745	A.32.1
1409890	60993	G.2.10	1421325	62342	J.6.1	1426263	63112	C.7.7	1432187	62225	A.32.2
1409918	60985	E.2.1	1421325	62342	L.6.2	1426339	623245	J.1.10	1432591	65478	M.2.4
1411129	63963	H.6.9	1421599	65296	H.6.4	1426449	65192	C.1.2	1433063	63548	A.7.3
1411774	63753	H.2.1	1421621	64006	A.33.12	1427514	65283	H.2.2	1433099	64823	C.7.10
1411851	63853	A.8.4	1421825	63193	A.24.4	1427669	64797	C.7.7	1433110	63154	A.21.14
1411894	60632	A.29.1	1422198	63784	A.13.13	1427670	61955	A.28.5	1433183	63767	A.10.3
1412052	64686	C.7.10	1422200	63785	A.13.13	1427793	63942	J.1.4	1433190	64358	A.16.11
1412263	65535	J.5.4	1422433	60237	D.2.1	1427794	63938	J.1.3	1433190	64358	H.4.4
1412265	60023	N.1.11	1422442	61652	D.2.2	1427794	64437	J.1.4	1433203	65399	B.1.2
1412265	60023	N.3.2	1422474	63323	A.33.10	1427926	665801	C.7.15	1433641	61204	A.13.28
1412398	63786	A.22.2	1422499	64285	A.27.4	1428073	63110	C.7.7	1433654	62458	J.1.6
1412666	61552	A.13.8	1422502	64832	A.22.1	1428454	62554	N.30.11	1433655	62457	J.1.6
1412695	65283	H.2.2	1422564	63322	A.29.2	1428892	60432	A.33.6	1433656	62456	J.1.6
1413047	60375	C.2.3	1422615	65471	J.5.5	1428940	63292	A.23.3	1433667	64827	A.33.6
1413146	62389	I.48.12	1422640	62346	J.1.1	1428941	63384	A.23.3	1433792	64008	A.26.4
1413609	63384	A.23.3	1422701	61608	H.14.1	1429110	61305	L.2.8	1433886	64137	A.7.6
1413894	65279	A.13.21	1422843	64664	I.51.1	1429393	63961	I.55.14	1434106	64647	A.22.6
1414072	60279	G.2.2	1422991	62261	N.1.2	1429394	63960	I.55.14	1434134	63644	J.3.4
1414153	60743	H.10.1	1422992	62262	N.1.3	1430533	62407	I.56.2	1434135	62295	J.3.2

ALL THE COMPONENTS LISTED IN OUR CATALOGUE ARE NOT ORIGINAL, THOUGH PERFECTLY INTERCHANGEABLE. REFERENCE NUMBERS, EITHER ORIGINAL OR OF A DIFFERENT NATURE, ARE FOR INFORMATION PURPOSES ONLY. WHEN PLACING AN ORDER, PLEASE, ALWAYS USE COSIBO REFERENCE NUMBERS AND DO NOT MENTION THE ORIGINAL REFERENCE NUMBERS OF THE TRUCK MANUFACTURERS IN THE INVOICE TO VEHICLE OWNERS OR TO ANYBODY ELSE. THE CUSTOMER TAKES HIS OWN RESPONSIBILITY IF HE DOES NOT COMPLY WITH WHAT ABOVE.

Cross reference SCANIA - COSIBO

Replacing	COSIBO	Page	Replacing	COSIBO	Page	Replacing	COSIBO	Page	Replacing	COSIBO	Page
1434649	60155	B.1.1	1442295	65366	I.48.11	1448117	63792	H.13.8	1461416	64828	H.6.10
1435856	62267	J.9.1	1442300	65529	A.2.4	1448384	65132	A.27.10	1461417	64829	H.6.11
1435859	61368	J.9.4	1442579	65002	A.21.16	1448659	61461	A.7.20	1462612	63355	M.1.2
1436867	60501	N.3.3	1442653	64702	I.30.2	1448933	63953	A.7.15	1462613	63354	M.1.1
1436868	60500	N.3.3	1442654	64703	I.30.3	1449431	65130	A.27.10	1465410	60591	A.2.3
1437123	63550	A.5.8	1442705	63369	I.7.4	1449542	65343	A.8.6	1466031	64676	I.50.5
1437263	64805	J.5.4	1442706	63712	I.7.3	1449757	62405	J.5.2	1466032	64677	I.50.5
1437264	65456	J.5.3	1442751	62260	A.21.1	1449771	64258	J.5.5	1466075	65402	A.27.16
1437296	64277	A.16.4	1443114	63361	J.8.9	1450132	65431	C.7.8	1466075	65402	C.50.1
1437727	61208	C.7.3	1444016	64061	J.9.4	1450153	64854	A.26.2	1466075	65402	H.4.4
1438557	64655	N.4.2	1444110	65332	B.2.9	1450166	64204	J.5.3	1466075	65402	M.30.1
1438558	64654	N.4.3	1444822	65501	F.2.2	1450536	64286	C.8.2	1466382	64197	A.5.14
1438563	64659	N.4.4	1444941	63565	A.3.2	1451270	65414	I.50.11	1466383	64226	A.7.8
1438564	64658	N.4.5	1444948	64842	A.27.3	1451271	65415	I.50.11	1466506	62357	J.1.7
1438702	62527	C.7.5	1444954	65360	A.22.5	1451527	65412	I.50.10	1467000	62258	N.1.3
1438902	60436	H.4.1	1445398	63321	A.21.12	1451528	65413	I.50.10	1467001	63915	N.1.6
1439036	62402	A.14.15	1445830	63545	A.1.4	1451839	63646	J.8.16	1467002	63916	N.1.6
1439070	64497	G.2.4	1445925	64665	A.33.4	1452542	64354	H.14.3	1467003	62257	N.1.4
1439171	63952	A.7.14	1446228	64845	A.27.3	1452667	64391	I.45.1	1467007	62404	N.1.5
1439172	63446	N.30.6	1446229	64844	A.27.3	1452668	64392	I.45.1	1467166	64232	A.7.9
1439270	63354	M.1.1	1446239	65525	A.22.5	1452862	63847	A.12.2	1468555	63933	A.3.3
1439462	64426	I.7.13	1446258	64422	J.5.5	1452862	63847	N.30.8	1469161	62012	B.1.2
1439463	64427	I.7.12	1446353	62425	N.1.1	1453967	64833	A.22.1	1469287	62439	C.9.2
1439504	65124	A.21.2	1446354	62424	N.1.1	1453967	64833	A.22.2	1469566	65430	C.7.16
1439788	64663	I.51.1	1446355	62426	N.1.1	1454280	63639	A.23.6	1470305	65279	A.13.21
1439789	64662	I.51.2	1446356	62427	N.1.2	1454281	63966	A.23.6	1471133	64412	C.7.16
1439814	65313	A.13.23	1446432	62401	A.30.1	1454282	65095	A.23.9	1471237	60101	A.2.3
1439822	64017	A.21.12	1446581	65373	N.1.6	1454590	62012	B.1.2	1471599	62300	I.30.8
1439825	64775	A.21.1	1446582	65374	N.1.7	1455730	60155	B.1.1	1471738	64401	N.30.13
1440108	62291	I.55.10	1446583	62278	N.1.4	1456041	64197	A.5.14	1471743	64810	N.30.15
1440113	62292	I.55.11	1446584	62279	N.1.4	1457303	64808	N.30.14	1471747	64811	N.30.15
1440294	60744	L.9.1	1446585	63915	N.1.6	1457304	64809	N.30.15	1472142	63333	C.6.3
1440359	63550	A.5.8	1446586	63916	N.1.6	1457895	64650	I.54.8	1472144	63331	C.6.2
1440364	62539	J.7.3	1446587	62258	N.1.3	1457896	64651	I.54.8	1472145	63335	C.6.5
1440365	62525	J.7.2	1446588	62257	N.1.4	1459004	60569	A.13.7	1472718	63339	C.6.6
1440367	62538	J.7.2	1446910	64404	A.16.10	1459133	64691	I.50.5	1472738	64304	C.2.5
1440370	62474	J.7.1	1447198	65143	A.27.13	1459134	64692	I.50.5	1472738	64304	E.3.1
1440371	62473	J.7.2	1447911	64795	N.30.9	1459135	64693	I.50.5	1472738	64304	F.4.1
1440404	65320	A.22.6	1448083	65486	H.8.3	1459141	64694	I.50.10	1472738	64304	N.40.2
1440406	64649	A.22.8	1448083	65486	L.10.1	1459142	64695	I.50.10	1472739	63677	C.2.5
1440407	65319	A.22.8	1448083	65486	N.40.1	1459145	64696	I.50.6	1472739	63677	N.40.2
1440780	65526	I.48.3	1448110	61163	H.13.4	1459146	64362	I.50.11	1472771	63845	C.7.16
1440781	65527	I.48.3	1448111	61166	H.13.4	1459188	63873	J.8.9	1472879	63845	C.7.16
1441235	62522	C.7.4	1448112	61167	H.13.5	1459762	63886	A.30.2	1473979	65469	A.30.2
1441240	64102	J.10.1	1448113	61168	H.13.8	1460362	63120	A.13.8	1474065	63998	L.7.3
1442292	63913	I.48.11	1448114	61257	H.13.6	1460812	63109	E.2.6	1474732	63332	C.6.3
1442293	63914	I.48.12	1448115	61169	H.13.5	1460812	63109	F.1.1	1475433	61902	A.14.5
1442294	65365	I.48.11	1448116	63791	H.13.7	1461414	64071	C.4.1	1475436	65367	A.14.8

ALL THE COMPONENTS LISTED IN OUR CATALOGUE ARE NOT ORIGINAL, THOUGH PERFECTLY INTERCHANGEABLE. REFERENCE NUMBERS, EITHER ORIGINAL OR OF A DIFFERENT NATURE, ARE FOR INFORMATION PURPOSES ONLY. WHEN PLACING AN ORDER, PLEASE, ALWAYS USE COSIBO REFERENCE NUMBERS AND DO NOT MENTION THE ORIGINAL REFERENCE NUMBERS OF THE TRUCK MANUFACTURERS IN THE INVOICE TO VEHICLE OWNERS OR TO ANYBODY ELSE. THE CUSTOMER TAKES HIS OWN RESPONSIBILITY IF HE DOES NOT COMPLY WITH WHAT ABOVE.

Cross reference SCANIA - COSIBO

Replacing	COSIBO	Page	Replacing	COSIBO	Page	Replacing	COSIBO	Page	Replacing	COSIBO	Page
1475750	64178	N.30.5	1484765	63554	A.7.4	1495956	64680	I.55.12	1507790	64417	H.4.2
1475868	63139	A.18.3	1484765	63554	C.1.8	1495957	64681	I.55.13	1508533	60633	A.26.1
1476395	63858	A.23.1	1484766	63555	A.7.5	1496288	60435	A.18.2	1508534	60634	A.26.2
1476415	62322	J.9.3	1484766	63555	C.1.8	1496293	64329	I.55.13	1509813	64232	A.7.9
1476506	65344	A.8.6	1484807	62469	C.6.1	1496294	64330	I.55.14	1510195	60744	L.9.1
1476532	64391	I.45.1	1484808	62469	C.6.1	1496659	63962	I.35.1	1510404	64008	A.26.4
1476533	64392	I.45.1	1484809	62470	C.6.1	1497013	62336	A.33.2	1510490	60060	A.26.1
1476534	64393	I.45.2	1485485	62344	I.54.7	1497653	64742	A.33.4	1510575	65098	A.33.4
1476535	64394	I.45.2	1485486	62345	I.54.7	1498102	64639	N.3.6	1510697	64251	A.23.4
1476945	64497	G.2.4	1485592	65524	A.16.7	1498103	64640	N.3.6	1510698	64066	A.23.4
1477022	63546	A.1.3	1485685	64278	A.13.6	1498179	65438	I.30.6	1511620	64294	A.27.4
1477051	62290	A.21.2	1485717	63326	C.7.5	1498180	65439	I.30.7	1511775	60359	A.21.20
1477867	61305	L.2.8	1486098	60060	A.26.1	1498607	65363	C.2.7	1511832	65320	A.22.6
1477876	64711	J.1.8	1486148	64647	A.22.6	1499230	62264	I.51.4	1512422	65122	C.8.3
1477877	64110	J.1.2	1486287	65539	M.10.1	1499231	62250	I.51.3	1512423	64700	I.30.2
1478450	61745	A.32.1	1486634	62382	A.11.3	1499770	65331	B.2.5	1512424	64701	I.30.2
1478502	63700	L.1.4	1486647	64708	I.30.3	1500455	63093	A.33.2	1512485	64846	H.6.2
1478507	63019	L.1.2	1486648	64709	I.30.3	1501030	60985	E.2.1	1512749	64251	A.23.4
1478509	65515	L.1.3	1487566	64378	A.2.4	1501180	62477	J.1.6	1513440	65485	A.12.4
1478509	65515	L.1.4	1487567	60591	A.2.3	1501342	65540	I.30.4	1513717	62012	B.1.2
1478511	65514	L.1.3	1488066	63604	J.3.3	1501343	65541	I.30.4	1513719	65368	B.2.10
1478511	65514	L.1.3	1488067	62520	J.3.1	1502384	63330	C.5.2	1513720	65368	B.2.10
1479574	65544	B.2.10	1488083	60304	C.2.1	1502384	63330	F.2.1	1514086	63292	A.23.3
1479575	65102	B.2.10	1488093	65499	A.40.2	1502385	63345	F.2.1	1514087	63384	A.23.3
1479576	65331	B.2.5	1488340	63847	A.12.2	1502468	64741	J.9.4	1514089	665801	C.7.15
1479758	64862	I.50.9	1488340	63847	N.30.8	1502472	65097	J.9.5	1514093	62264	I.51.4
1479759	64863	I.50.9	1488409	62347	I.48.6	1502474	65392	A.9.3	1514505	61324	J.8.10
1479872	64853	A.5.14	1488410	62348	I.48.6	1502515	65440	H.11.1	1514865	63969	A.23.7
1481245	62010	J.8.15	1488557	64763	A.33.5	1502798	64137	A.7.6	1515117	63110	C.7.7
1481301	63864	A.32.2	1488658	64751	A.5.3	1503113	63652	A.23.1	1515118	63112	C.7.7
1481371	64060	J.4.1	1489734	63354	M.1.1	1503114	63858	A.23.1	1515119	64797	C.7.7
1482003	64812	N.30.16	1490819	64183	A.23.10	1503790	64180	J.3.3	1515190	62250	I.51.3
1482069	62250	I.51.3	1490821	63934	A.23.9	1503932	63922	A.13.16	1515194	62415	I.30.6
1482078	64747	I.51.5	1490821	63934	J.5.1	1504019	62484	J.10.1	1515195	62414	I.30.5
1482079	64745	I.51.5	1490912	63355	M.1.2	1504020	62485	J.10.1	1515869	63334	C.6.4
1482080	64746	I.51.6	1490913	63354	M.1.1	1504131	62434	I.51.2	1515870	63344	C.6.6
1482405	62384	I.54.11	1491408	64228	C.2.7	1504160	63361	J.8.9	1516145	62542	A.16.3
1482500	62535	A.32.3	1491408	64228	N.30.12	1504270	63465	N.30.4	1516474	62542	A.16.3
1482500	62535	A.32.3	1491834	63355	M.1.2	1504602	64641	N.3.4	1516491	65124	A.21.2
1482997	63327	C.7.6	1492421	60359	A.21.20	1504603	64642	N.3.4	1516496	62491	L.4.1
1483278	64764	A.33.5	1492746	62529	A.21.9	1504608	60501	N.3.3	1516514	64848	H.6.3
1483280	65016	A.33.5	1492747	62528	A.21.9	1504609	60500	N.3.3	1517324	62357	J.1.7
1483281	64665	A.33.4	1493381	65472	N.1.8	1505366	65342	A.8.5	1517325	65316	J.1.4
1484076	64173	I.7.13	1493670	63652	A.23.1	1505563	64743	J.9.2	1517649	63961	I.55.14
1484078	64171	I.7.14	1493708	64286	C.8.2	1505748	64742	A.33.4	1517650	63960	I.55.14
1484079	64172	I.7.15	1494718	64294	A.27.4	1505749	65361	A.33.6	1519436	64377	J.8.15
1484081	64174	I.7.14	1495692	63187	J.5.2	1506273	64847	H.6.3	1519488	65207	L.10.1
1484094	64740	A.33.2	1495828	65449	L.10.1	1506330	64722	J.2.6	1519631	63019	L.1.2

ALL THE COMPONENTS LISTED IN OUR CATALOGUE ARE NOT ORIGINAL, THOUGH PERFECTLY INTERCHANGEABLE. REFERENCE NUMBERS, EITHER ORIGINAL OR OF A DIFFERENT NATURE, ARE FOR INFORMATION PURPOSES ONLY. WHEN PLACING AN ORDER, PLEASE, ALWAYS USE COSIBO REFERENCE NUMBERS AND DO NOT MENTION THE ORIGINAL REFERENCE NUMBERS OF THE TRUCK MANUFACTURERS IN THE INVOICE TO VEHICLE OWNERS OR TO ANYBODY ELSE. THE CUSTOMER TAKES HIS OWN RESPONSIBILITY IF HE DOES NOT COMPLY WITH WHAT ABOVE.

Cross reference SCANIA - COSIBO

Replacing	COSIBO	Page	Replacing	COSIBO	Page	Replacing	COSIBO	Page	Replacing	COSIBO	Page
1519633	65515	L.1.3	1526087	60367	A.16.5	1534976	62346	J.1.1	1541484	64682	I.50.6
1519633	65515	L.1.4	1526569	623241	J.1.9	1535045	62353	I.30.9	1541549	65122	C.8.3
1519788	64121	A.23.7	1526570	623244	J.1.10	1535048	64105	I.30.10	1541653	63354	M.1.1
1520700	63919	A.13.15	1526571	623242	J.1.9	1535049	68888	I.30.8	1541703	65486	H.8.3
1520701	63923	A.13.16	1526572	623243	J.1.10	1535052	64104	I.30.9	1541703	65486	L.10.1
1520702	63924	A.13.16	1526573	623245	J.1.10	1535248	65502	H.40.2	1541703	65486	N.40.1
1520867	64102	J.10.1	1527633	61906	H.13.3	1535248	65502	H.40.3	1541978	65468	J.1.3
1520919	65411	N.1.3	1527653	65398	A.21.3	1535249	65505	H.40.2	1541982	62457	J.1.6
1521209	60018	A.1.6	1527743	63123	C.1.3	1535249	65505	H.40.4	1541983	62458	J.1.6
1521210	62105	A.1.6	1527913	64378	A.2.4	1535250	65506	H.40.3	1541984	63942	J.1.4
1521553	62518	H.14.2	1527914	60591	A.2.3	1535250	65506	H.40.4	1541984	64437	J.1.4
1521554	65328	H.14.3	1528043	61851	G.2.12	1535698	61366	B.2.6	1542104	65344	A.8.6
1521565	65419	N.1.8	1528991	62460	F.2.2	1535698	61366	C.8.4	1542159	61790	H.5.3
1521566	65420	N.1.9	1529007	65143	A.27.13	1536304	65191	A.12.3	1543076	64373	J.2.1
1521683	64653	N.2.1	1529070	62261	N.1.2	1536304	65191	C.2.3	1543307	62532	I.50.7
1522010	65002	A.21.16	1529071	62262	N.1.3	1536304	65191	E.3.1	1543308	62531	I.50.7
1522011	65002	A.21.16	1529552	65246	I.54.12	1536304	65191	F.10.1	1543603	65431	C.7.8
1522013	61187	A.7.7	1529885	64344	I.30.7	1536304	65191	H.8.1	1543607	62543	I.50.4
1522377	60155	B.1.1	1529886	64345	I.30.7	1536304	65191	J.6.2	1543608	64207	I.55.11
1522464	62487	J.10.3	1530503	65477	M.2.4	1536304	65191	L.6.2	1543609	64208	I.55.12
1522518	64376	A.26.9	1530690	63878	N.30.11	1536304	65191	N.40.1	1543634	62255	N.4.1
1523400	64353	B.1.3	1530693	64419	N.30.14	1536307	62342	J.6.1	1543635	62254	N.4.1
1523410	60017	A.1.5	1530696	63879	G.3.1	1536307	62342	L.6.2	1543688	62519	A.7.15
1523508	64674	I.51.2	1530696	63879	N.30.12	1536807	62481	I.50.6	1543691	60744	L.9.1
1523509	64675	I.51.2	1530699	64818	E.2.5	1537675	62282	I.55.5	1543731	63446	N.30.6
1523607	63987	I.54.10	1530699	64818	G.3.1	1537771	64825	J.5.6	1544330	62347	I.48.6
1523608	63988	I.54.10	1530699	64818	N.30.17	1538383	62480	I.50.4	1544331	62348	I.48.6
1523612	63466	N.30.5	1530700	64418	N.30.13	1538384	62483	I.55.9	1545062	63117	B.2.5
1523635	65534	C.2.8	1530702	62554	N.30.11	1538385	62482	I.55.10	1545116	65132	A.27.10
1523881	64672	N.1.2	1530703	64414	N.30.13	1539106	65519	N.30.19	1545122	65363	C.2.7
1523882	64673	N.1.2	1530704	62555	N.30.11	1539110	64816	N.30.17	1545124	65364	C.2.7
1524331	65427	M.10.1	1530705	64819	N.30.18	1539231	60279	G.2.2	1545149	64006	A.33.12
1524337	62477	J.1.6	1530709	64813	G.3.1	1539313	64814	N.30.16	1545478	61707	A.13.25
1525145	65092	A.21.17	1530709	64813	N.30.16	1539675	64145	A.5.15	1545479	63414	A.13.24
1525357	65426	M.10.1	1530783	64374	A.22.7	1539870	62496	I.56.2	1545625	64246	B.3.1
1525887	62375	J.2.5	1530792	64817	N.30.17	1539871	62550	I.56.2	1545626	63885	B.1.4
1525888	63363	J.2.4	1530826	64858	H.5.4	1540425	63355	M.1.2	1545982	63652	A.23.1
1525889	63364	J.2.4	1530973	64121	A.23.7	1540426	64802	M.1.2	1545983	63858	A.23.1
1525890	63362	J.2.4	1530979	63640	A.23.6	1541070	60238	D.2.1	1545984	64998	A.23.2
1525891	63761	J.2.5	1530980	60129	A.23.5	1541071	60239	D.2.2	1546188	64123	A.26.4
1525892	62374	J.2.5	1530981	63967	A.23.7	1541072	61652	D.2.2	1546618	65428	N.3.7
1525983	64843	A.27.3	1530984	65094	A.23.9	1541083	64370	A.32.4	1548054	61313	L.2.3
1525988	60836	C.4.2	1531761	64822	A.21.3	1541086	65452	C.2.6	1548055	64726	L.2.5
1525988	60836	D.1.3	1531776	65132	A.27.10	1541086	65452	E.3.2	1548318	64686	C.7.10
1525988	60836	E.2.6	1532223	64296	J.1.12	1541086	65452	N.30.10	1548504	62475	J.2.7
1525988	60836	F.2.3	1532517	64122	B.1.5	1541106	63882	J.2.1	1548849	65431	C.7.8
1525988	60836	H.6.10	1534012	61297	G.2.8	1541367	63920	A.13.15	1549027	64243	A.26.5
1526086	63618	A.16.6	1534505	62437	A.23.8	1541368	63921	A.13.15	1549304	65454	C.2.7

ALL THE COMPONENTS LISTED IN OUR CATALOGUE ARE NOT ORIGINAL, THOUGH PERFECTLY INTERCHANGEABLE. REFERENCE NUMBERS, EITHER ORIGINAL OR OF A DIFFERENT NATURE, ARE FOR INFORMATION PURPOSES ONLY. WHEN PLACING AN ORDER, PLEASE, ALWAYS USE COSIBO REFERENCE NUMBERS AND DO NOT MENTION THE ORIGINAL REFERENCE NUMBERS OF THE TRUCK MANUFACTURERS IN THE INVOICE TO VEHICLE OWNERS OR TO ANYBODY ELSE. THE CUSTOMER TAKES HIS OWN RESPONSIBILITY IF HE DOES NOT COMPLY WITH WHAT ABOVE.

Cross reference SCANIA - COSIBO

Replacing	COSIBO	Page	Replacing	COSIBO	Page	Replacing	COSIBO	Page	Replacing	COSIBO	Page
1549304	65454	E.3.2	1727991	64655	N.4.2	1742449	65326	J.8.13	1757877	64397	D.2.3
1549304	65454	N.30.10	1727992	64654	N.4.3	1742920	63866	J.2.1	1757877	64397	F.2.6
1549330	64347	A.31.1	1728165	65331	B.2.5	1742947	62530	C.2.4	1757903	64263	A.10.3
1549481	64008	A.26.4	1729116	64848	H.6.3	1742947	62530	J.3.5	1759690	63589	M.2.3
1549482	64008	A.26.4	1730221	63680	I.56.5	1744081	64444	N.30.19	1759691	63587	M.2.3
1549495	64312	C.1.4	1730757	65487	A.16.7	1744086	65484	N.40.1	1761195	62552	G.2.4
1549737	64711	J.1.8	1731113	60744	L.9.1	1744210	63361	J.8.9	1761517	64415	H.11.1
1549738	62357	J.1.7	1731130	64177	N.30.8	1744211	63927	J.8.9	1762224	64720	G.2.3
1549739	65316	J.1.4	1731206	64664	I.51.1	1744774	65370	A.13.10	1762415	65431	C.7.8
1549740	62346	J.1.1	1731309	64801	H.13.4	1744775	63120	A.13.8	1762623	62529	A.21.9
1549741	64110	J.1.2	1732322	64344	I.30.7	1745449	63171	A.24.1	1762624	62528	A.21.9
1549814	65419	N.1.8	1732507	63915	N.1.6	1746135	64142	A.7.8	1763421	64202	H.9.1
1549815	65420	N.1.9	1732508	63916	N.1.6	1746246	64669	N.1.8	1763422	65450	H.9.1
1671745	63649	A.13.20	1732509	62258	N.1.3	1746585	64364	I.50.11	1763423	64405	H.8.3
1680726	62460	F.2.2	1732510	62257	N.1.4	1746684	63862	A.13.5	1763618	64834	A.22.3
1720615	64319	I.50.8	1732515	62404	N.1.5	1746684	61483	A.16.2	1763776	60632	A.29.1
1720616	64318	I.50.9	1732776	63369	I.7.4	1747894	62089	B.1.2	1764885	62290	A.21.2
1720924	62476	J.1.7	1732778	63370	I.7.5	1747895	60808	B.1.1	1764886	62260	A.21.1
1720925	65445	J.1.8	1732782	64245	I.7.6	1747981	64653	N.2.1	1765061	60994	G.2.11
1722438	64320	I.50.12	1732782	64245	I.7.7	1748085	64697	I.50.6	1765382	64186	M.2.6
1722531	62524	I.30.4	1732782	63797	I.7.10	1748086	64706	I.50.6	1765735	60359	A.21.20
1722531	62524	N.2.4	1732783	63860	I.7.10	1748892	65485	A.12.4	1765828	60237	D.2.1
1722694	64722	J.2.6	1732855	64350	I.54.9	1749034	60986	G.2.16	1765829	64335	D.2.3
1722828	64007	A.33.13	1732856	64349	I.54.9	1749123	65332	B.2.9	1765974	65340	A.4.6
1723518	64245	I.7.6	1733180	65410	N.1.9	1749125	65331	B.2.5	1766466	60238	D.2.1
1723518	64245	I.7.7	1733181	64328	N.1.9	1749126	64413	B.2.13	1766467	60239	D.2.2
1723518	64170	I.7.7	1733735	64355	A.27.14	1749716	64680	I.55.12	1766614	64822	A.21.3
1723519	64169	I.7.6	1734019	64310	E.2.1	1749717	64681	I.55.13	1766617	64822	A.21.3
1723663	65456	J.5.3	1734020	61499	E.2.2	1749823	65444	A.40.1	1766909	64832	A.22.1
1723895	60985	E.2.1	1734529	61906	H.13.3	1749953	62285	I.56.5	1767479	65447	J.1.11
1724264	62532	I.50.7	1736364	62383	H.6.3	1750308	60239	D.2.2	1767631	62533	I.50.12
1724430	64858	H.5.4	1736562	64166	G.2.14	1751403	64373	J.2.1	1768269	65262	J.8.13
1724482	64497	G.2.4	1737306	64246	B.3.1	1752264	65437	J.5.5	1768402	60434	C.1.1
1725112	64306	A.4.5	1737413	62463	I.30.9	1753208	65441	A.40.1	1768402	60434	F.2.1
1725376	65446	J.1.2	1737683	60985	E.2.1	1753479	63569	B.3.2	1768694	60361	J.1.9
1725593	65409	N.1.9	1738098	64027	J.5.4	1754546	60866	L.7.4	1768898	61119	M.2.2
1725663	63965	I.54.11	1738379	64343	E.2.4	1754943	63885	B.1.4	1768957	65528	C.700.1
1725664	63964	I.54.11	1738379	64343	F.5.1	1755194	64855	B.1.3	1769452	62407	I.56.2
1725671	64650	I.54.8	1738379	64343	M.2.5	1755594	62480	I.50.4	1769483	64822	A.21.3
1725672	64651	I.54.8	1738380	60521	E.2.3	1755638	64152	J.8.12	1769522	65360	A.22.5
1725675	64643	I.54.8	1738380	60521	F.5.1	1755901	64201	H.9.1	1769597	63306	M.2.2
1725676	64644	I.54.9	1738380	60521	M.2.4	1755951	64844	A.27.3	1769798	61194	A.14.4
1726130	64068	L.2.1	1740992	61297	G.2.8	1755952	62221	A.24.3	1769799	61193	A.14.3
1726850	62291	I.55.10	1741027	64180	J.3.3	1755953	64845	A.27.3	1769800	61902	A.14.5
1726851	62292	I.55.11	1741091	63466	N.30.5	1756046	64867	H.6.4	1769911	64429	I.45.3
1727263	64678	I.50.7	1741588	65398	A.21.3	1756460	64122	B.1.5	1769912	64428	I.45.3
1727264	64679	I.50.7	1742032	65400	A.14.2	1757490	64054	A.21.20	1769997	65398	A.21.3
1727377	62527	C.7.5	1742265	62531	I.50.7	1757877	64397	A.21.10	1770297	64857	A.13.29

ALL THE COMPONENTS LISTED IN OUR CATALOGUE ARE NOT ORIGINAL, THOUGH PERFECTLY INTERCHANGEABLE. REFERENCE NUMBERS, EITHER ORIGINAL OR OF A DIFFERENT NATURE, ARE FOR INFORMATION PURPOSES ONLY. WHEN PLACING AN ORDER, PLEASE, ALWAYS USE COSIBO REFERENCE NUMBERS AND DO NOT MENTION THE ORIGINAL REFERENCE NUMBERS OF THE TRUCK MANUFACTURERS IN THE INVOICE TO VEHICLE OWNERS OR TO ANYBODY ELSE. THE CUSTOMER TAKES HIS OWN RESPONSIBILITY IF HE DOES NOT COMPLY WITH WHAT ABOVE.

Cross reference SCANIA - COSIBO

Replacing	COSIBO	Page	Replacing	COSIBO	Page	Replacing	COSIBO	Page	Replacing	COSIBO	Page
1770301	62524	I.30.4	1789068	64204	J.5.3	1797425	60239	D.2.2	1849060	65394	A.24.1
1770301	62524	N.2.4	1789305	64001	I.48.1	1797431	60790	B.2.4	1849151	64181	A.2.1
1770813	64209	J.5.7	1789306	64002	I.48.1	1797845	63867	C.8.5	1849428	64054	A.21.20
1773867	65507	H.6.4	1789309	65432	I.48.2	1798863	64680	I.55.12	1849922	64750	A.5.2
1774202	64141	A.7.13	1789310	65433	I.48.2	1798864	64681	I.55.13	1850567	62383	H.6.3
1774598	64118	A.14.2	1789317	65489	I.48.2	1798980	64298	I.56.4	1850826	63922	A.13.16
1774598	64118	H.6.8	1789317	65489	I.48.3	1798981	64299	I.56.4	1851213	623243	J.1.10
1774651	63652	A.23.1	1789318	65490	I.48.2	1799757	65394	A.24.1	1851248	65447	J.1.11
1774652	63858	A.23.1	1789318	65490	I.48.3	1800442	64353	B.1.3	1851631	65331	B.2.5
1774653	64998	A.23.2	1789522	64123	A.26.4	1800469	64319	I.50.8	1851989	63680	I.56.5
1774654	64185	A.23.2	1789560	63348	H.13.9	1800470	64318	I.50.9	1852113	62530	C.2.4
1774872	64202	H.9.1	1789561	63349	H.13.9	1800521	63639	A.23.6	1852113	62530	J.3.5
1774873	65450	H.9.1	1789562	63350	H.13.10	1800522	63966	A.23.6	1852188	65499	A.40.2
1775964	65311	A.13.24	1789565	65388	H.13.12	1800523	65095	A.23.9	1852569	62425	N.1.1
1775965	65312	A.13.25	1789566	65389	H.13.13	1800527	63934	A.23.9	1852570	62424	N.1.1
1778530	604353	A.18.3	1789567	63894	H.13.10	1800527	63934	J.5.1	1852572	62426	N.1.1
1778532	604352	A.18.2	1789568	63893	H.13.11	1800531	64183	A.23.10	1852573	62427	N.1.2
1779118	65540	I.30.4	1790006	64661	N.4.3	1800533	63969	A.23.7	1852817	61622	H.13.2
1779119	65541	I.30.4	1790007	64660	N.4.3	1800535	64121	A.23.7	1853436	65186	C.2.4
1779120	64708	I.30.3	1790041	64822	A.21.3	1800538	60129	A.23.5	1853436	65186	J.3.2
1779121	64709	I.30.3	1790071	64356	A.27.14	1800539	63967	A.23.7	1853773	65279	A.13.21
1779130	65442	A.5.8	1790071	64356	J.1.11	1800541	65094	A.23.9	1854058	62453	C.8.4
1779202	64804	J.5.3	1790840	64422	J.5.5	1800871	64740	A.33.2	1854227	65438	I.30.6
1780108	63873	J.8.9	1791152	63545	A.1.4	1800909	65394	A.24.1	1854228	65439	I.30.7
1780585	63680	I.56.5	1792307	65227	A.13.20	1801529	61476	A.1.4	1854601	64815	N.30.16
1781199	65486	H.8.3	1792308	65227	A.13.20	1801618	64865	I.50.9	1854876	64803	J.5.2
1781199	65486	L.10.1	1792374	64252	N.3.6	1801736	64757	A.13.14	1855164	60359	A.21.20
1781199	65486	N.40.1	1792375	64253	N.3.6	1801737	61838	A.13.5	1856108	61906	H.13.3
1781929	64072	J.8.15	1792387	65530	N.3.5	1801772	64058	A.16.8	1856309	64867	H.6.4
1782203	62439	C.9.2	1792388	65531	N.3.5	1801775	60367	A.16.5	1856310	64444	N.30.19
1782207	64422	J.5.5	1793197	64448	J.3.3	1803332	64121	A.23.7	1856312	65484	N.40.1
1782290	64439	J.8.7	1793582	63919	A.13.15	1803333	63640	A.23.6	1856472	64330	I.55.14
1782741	64771	A.33.11	1793583	63923	A.13.16	1803335	62437	A.23.8	1856473	64329	I.55.13
1784616	65398	A.21.3	1793584	63924	A.13.16	1804034	64376	A.26.9	1856474	64681	I.55.13
1784636	64262	A.16.4	1794440	64801	H.13.4	1804064	60361	J.1.9	1856475	64680	I.55.12
1784637	64420	A.16.5	1794725	65099	A.21.17	1804210	64415	H.11.1	1856995	64833	A.22.1
1785076	63546	A.1.3	1794863	64396	A.29.2	1804628	64364	I.50.11	1856995	64833	A.22.2
1785531	62384	I.54.11	1795459	65499	A.40.2	1804829	64858	H.5.4	1857591	65421	I.50.10
1785693	65443	A.5.9	1795464	64204	J.5.3	1805380	65027	L.2.4	1858661	64053	J.2.7
1786639	61851	G.2.12	1795526	64141	A.7.13	1805399	64682	I.50.6	1858884	64066	A.23.4
1786692	64672	N.1.2	1795583	62274	A.21.10	1805447	64105	I.30.10	1858885	64251	A.23.4
1786693	64673	N.1.2	1795583	62274	J.8.11	1805603	65283	H.2.2	1859654	63652	A.23.1
1787032	64446	C.7.9	1795730	64822	A.21.3	1809771	64861	A.21.18	1859655	63858	A.23.1
1787155	64203	N.30.20	1795774	64066	A.23.4	1810345	64377	J.8.15	1859656	64998	A.23.2
1787672	64864	I.50.8	1795775	64251	A.23.4	1815227	64320	I.50.12	1859657	64185	A.23.2
1788333	64240	A.14.15	1796026	64795	N.30.9	1821737	64417	H.4.2	1860195	64856	B.1.3
1788333	64240	N.30.20	1796883	65478	M.2.4	1846702	64805	J.5.4	1861117	63769	L.1.2
1788498	65519	N.30.19	1797424	60238	D.2.1	1847312	63306	M.2.2	1861118	63769	L.1.2

ALL THE COMPONENTS LISTED IN OUR CATALOGUE ARE NOT ORIGINAL, THOUGH PERFECTLY INTERCHANGEABLE. REFERENCE NUMBERS, EITHER ORIGINAL OR OF A DIFFERENT NATURE, ARE FOR INFORMATION PURPOSES ONLY. WHEN PLACING AN ORDER, PLEASE, ALWAYS USE COSIBO REFERENCE NUMBERS AND DO NOT MENTION THE ORIGINAL REFERENCE NUMBERS OF THE TRUCK MANUFACTURERS IN THE INVOICE TO VEHICLE OWNERS OR TO ANYBODY ELSE. THE CUSTOMER TAKES HIS OWN RESPONSIBILITY IF HE DOES NOT COMPLY WITH WHAT ABOVE.

Cross reference SCANIA - COSIBO

Replacing	COSIBO	Page	Replacing	COSIBO	Page	Replacing	COSIBO	Page	Replacing	COSIBO	Page
1861121	65514	L.1.3	1872753	63164	H.6.2	1898019	64423	B.2.9	1928763	63921	A.13.15
1861121	65514	L.1.3	1873014	62402	A.14.15	1902328	63466	N.30.5	1929397	65332	B.2.9
1862376	63548	A.7.3	1873016	63886	A.30.2	1902698	63465	N.30.4	1929397	65379	B.2.11
1862798	64262	A.16.4	1873018	62401	A.30.1	1902973	65432	I.48.2	1930649	65421	I.50.10
1862799	64420	A.16.5	1873183	64033	G.2.1	1902974	65433	I.48.2	1934939	63646	J.8.16
1862890	64203	N.30.20	1874363	64054	A.21.20	1903797	64363	C.6.5	1936370	65481	A.13.14
1862891	64815	N.30.16	1877664	62540	J.10.1	1903798	644071	C.6.7	1936674	64661	N.4.3
1862892	64400	A.14.14	1879484	64243	A.26.5	1904343	64421	N.40.2	1936675	64660	N.4.3
1862892	64400	N.30.12	1879537	60237	D.2.1	1905884	64855	B.1.3	1945014	65227	A.13.20
1862895	64816	N.30.17	1879538	64335	D.2.3	1907422	65499	A.40.2	1945331	65227	A.13.20
1863244	65517	L.9.2	1879541	61652	D.2.2	1907845	61851	G.2.12	2000089	61648	J.8.16
1863244	65517	L.9.3	1881850	63793	C.2.8	1908536	65458	A.2.2	2000090	64206	J.8.17
1863896	63919	A.13.15	1884205	65444	A.40.1	1908536	65458	N.30.21	2000364	65227	A.13.20
1863897	63923	A.13.16	1884529	64812	N.30.16	1908858	65460	E.1.3	2000390	62463	I.30.9
1863898	63924	A.13.16	1887055	65474	H.5.7	1908858	65460	F.2.4	2001791	65441	A.40.1
1864620	64373	J.2.1	1888025	61461	A.7.20	1910437	64298	I.56.4	2002705	60434	C.1.1
1865315	65519	N.30.19	1888034	65535	J.5.4	1910438	64299	I.56.4	2002705	60434	F.2.1
1865317	64240	A.14.15	1888463	63639	A.23.6	1910461	65507	H.6.4	2003505	64396	A.29.2
1865317	64240	N.30.20	1888464	63966	A.23.6	1912757	61119	M.2.2	2005369	62347	I.48.6
1865517	64433	I.48.9	1888465	63969	A.23.7	1912758	63306	M.2.2	2005370	62348	I.48.6
1865519	64433	I.48.9	1888468	64183	A.23.10	1913500	64209	J.5.7	2010938	64141	A.7.13
1865674	65370	A.13.10	1888471	65094	A.23.9	1913503	60631	J.5.6	2020691	65458	A.2.2
1865675	63120	A.13.8	1890861	61906	H.13.3	1916620	63172	A.24.2	2020691	65458	N.30.21
1865749	63791	H.13.7	1891445	60591	A.2.3	1916864	64173	I.7.13	2021084	64867	H.6.4
1865759	65516	L.9.2	1892047	63878	N.30.11	1916864	64171	I.7.14	2021085	64444	N.30.19
1865759	65516	L.9.3	1892048	64817	N.30.17	1916864	64172	I.7.15	2021087	65484	N.40.1
1866391	65227	A.13.20	1892049	64419	N.30.14	1917858	65498	A.40.1	2022275	65400	A.14.2
1867658	65489	I.48.2	1892051	63879	G.3.1	1918538	65444	A.40.1	2028987	61461	A.7.20
1867658	65489	I.48.3	1892051	63879	N.30.12	1919065	62527	C.7.5	2028998	61499	E.2.2
1867659	65490	I.48.2	1892053	64818	E.2.5	1921327	64406	A.5.12	2030276	65460	E.1.3
1867659	65490	I.48.3	1892053	64818	G.3.1	1921972	62439	C.9.2	2030276	65460	F.2.4
1867874	62062	L.1.2	1892053	64818	N.30.17	1923585	63764	H.14.2	2035104	64298	I.56.4
1867874	62062	L.1.3	1892054	64418	N.30.13	1923586	63765	H.14.2	2035105	64299	I.56.4
1868087	64497	G.2.4	1892056	62554	N.30.11	1923589	65026	H.14.3	2038653	65191	A.12.3
1869987	63618	A.16.6	1892057	62555	N.30.11	1923594	61608	H.14.1	2038653	65191	C.2.3
1869988	60367	A.16.5	1892058	64819	N.30.18	1923599	64354	H.14.3	2038653	65191	E.3.1
1869992	64390	A.16.6	1892060	64813	G.3.1	1923607	62518	H.14.2	2038653	65191	F.10.1
1869993	60584	A.16.5	1892060	64813	N.30.16	1923608	65328	H.14.3	2038653	65191	H.8.1
1870000	64380	A.16.9	1892062	64820	N.30.18	1923617	64438	H.14.3	2038653	65191	J.6.2
1870001	64058	A.16.8	1892068	64414	N.30.13	1923654	60481	J.8.14	2038653	65191	L.6.2
1870551	65459	A.23.3	1893533	63680	I.56.5	1926077	65401	I.50.8	2038653	65191	N.40.1
1870552	65547	A.23.2	1894408	62010	J.8.15	1927829	64353	B.1.3	2038655	65470	C.2.3
1870689	62411	I.50.2	1894478	60359	A.21.20	1928587	64405	H.8.3	2040254	64310	E.2.1
1870767	65428	N.3.7	1895479	64181	A.2.1	1928588	65450	H.9.1	2051700	64406	A.5.12
1871043	64103	A.5.10	1896605	65352	A.11.2	1928759	63919	A.13.15	2052003	64833	A.22.1
1871043	64103	H.7.1	1897333	64310	E.2.1	1928760	63923	A.13.16	2052003	64833	A.22.2
1872122	64858	H.5.4	1897335	60985	E.2.1	1928761	63924	A.13.16	2056867	62256	I.52.3
1872151	65487	A.16.7	1897336	65416	E.2.2	1928762	63920	A.13.15	2057206	64857	A.13.29

ALL THE COMPONENTS LISTED IN OUR CATALOGUE ARE NOT ORIGINAL, THOUGH PERFECTLY INTERCHANGEABLE. REFERENCE NUMBERS, EITHER ORIGINAL OR OF A DIFFERENT NATURE, ARE FOR INFORMATION PURPOSES ONLY. WHEN PLACING AN ORDER, PLEASE, ALWAYS USE COSIBO REFERENCE NUMBERS AND DO NOT MENTION THE ORIGINAL REFERENCE NUMBERS OF THE TRUCK MANUFACTURERS IN THE INVOICE TO VEHICLE OWNERS OR TO ANYBODY ELSE. THE CUSTOMER TAKES HIS OWN RESPONSIBILITY IF HE DOES NOT COMPLY WITH WHAT ABOVE.

Cross reference SCANIA - COSIBO

Replacing	COSIBO	Page	Replacing	COSIBO	Page	Replacing	COSIBO	Page	Replacing	COSIBO	Page
2057893	62402	A.14.15									
2059778	60455	A.14.14									
2061500	63864	A.32.2									
2077837	63447	A.12.2									
2077837	63447	C.2.8									
2077837	63447	H.8.2									
2077837	63447	J.3.1									
2077837	63447	N.30.4									
2077976	65450	H.9.1									
2080828	62463	I.30.9									
2081360	64118	A.14.2									
2081360	64118	H.6.8									
2085863	65102	B.2.10									
2093721	62384	I.54.11									
2099046	65449	L.10.1									
2123147	63864	A.32.2									
2124015	64657	N.4.4									
2131819	64420	A.16.5									
2132264	64834	A.22.3									
2132266	64833	A.22.1									
2132266	64833	A.22.2									
2138380	63922	A.13.16									
2146105	64310	E.2.1									
2149696	64203	N.30.20									
2164195	65331	B.2.5									
2171712	64270	J.8.6									
2171712	64271	J.8.7									
2191989	65459	A.23.3									
2191990	65547	A.23.2									
2197003	63858	A.23.1									
2197007	64998	A.23.2									
2197390	65547	A.23.2									
2247379	65458	A.2.2									
2247379	65458	N.30.21									
2765315	64813	G.3.1									
2765315	64813	N.30.16									
3717801	651511	A.28.2									
13498051	604811	J.8.14									
14201971	606311	J.5.7									
1484076+	64171	I.7.14									
1484078											
1484076+	64172	I.7.15									
1484079											

ALL THE COMPONENTS LISTED IN OUR CATALOGUE ARE NOT ORIGINAL, THOUGH PERFECTLY INTERCHANGEABLE. REFERENCE NUMBERS, EITHER ORIGINAL OR OF A DIFFERENT NATURE, ARE FOR INFORMATION PURPOSES ONLY. WHEN PLACING AN ORDER, PLEASE, ALWAYS USE COSIBO REFERENCE NUMBERS AND DO NOT MENTION THE ORIGINAL REFERENCE NUMBERS OF THE TRUCK MANUFACTURERS IN THE INVOICE TO VEHICLE OWNERS OR TO ANYBODY ELSE. THE CUSTOMER TAKES HIS OWN RESPONSIBILITY IF HE DOES NOT COMPLY WITH WHAT ABOVE.

Since 1988, strength, agility and accuracy



Cosibo is specialised in the production and marketing of spare parts for heavy vehicles which are alternative and interchangeable with the original ones. In over twenty years of activity the Company has developed a business strength and a productive experience which today make it one of the most qualified reference points for the whole sector. A perfect knowledge of products, the total mastery of the technological processes, the great ability and agility in the management of commercial processes, make **Cosibo** one of the most reliable and competitive companies in its sector both in terms of products quality and promptness of action. In an industry, such as the one of heavy vehicles, where the evolution of the models, the technological innovation and the reliability of the products are the key for the success of the great manufacturers, the ability to innovate and update the range of available spare parts is an absolute and unavoidable value which has always been at the core of **Cosibo's** activity. Another competitive advantage has always been the managerial accuracy, the transparency of relationships and the understanding of the dynamics which rule the sector in the different markets. This advantage, over the years, has generated and consolidated the appreciation and diffusion of the **Cosibo** brand in each Country where the Company has decided to launch its activity. Supported by the verified effectiveness of its business strategy and of the choices made until today, **Cosibo** is currently offering a range of over 3,000 items for the vehicles of the main brands present on the market. **Cosibo** guarantees the absolute quality of the spare parts for vehicles of the following brands:

SCANIA • VOLVO • DAF • MERCEDES • IVECO • MAN • RENAULT

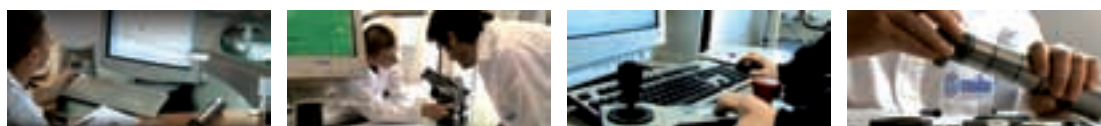

Cosibo certified quality for alternative spare parts



Cosibo S.p.A. 40050 Castello d'Argile · Bologna · Italy · Via L. Einaudi, 11/C
Tel. +39.051.977831 · Fax Sales Dept. +39.051.977590 · Fax Purchasing Dept/Production Dept. + 39.051.976515 · info@cosibo.it
www.cosibo.it · www.cosibo.com