

# Ersatzteile und Zubehör

für LKW- und Anhängerbeleuchtung

# Spare Parts and Accessories

for Trucks and Trailers Lighting





## ERSATZTEILE UND ZUBEHÖR

Dieser Katalog enthält die Ersatzteilproduktpalette für Truck & Trailer von Aspöck, welche sich durch hochwertige Qualität und Funktionsicherheit auszeichnet.

Diese Merkmale haben Aspöck zu einem führenden Erstausrüster im Bereich Fahrzeugbeleuchtung gemacht.

## SPARE PARTS AND ACCESSORIES

This catalogue contains the spare parts product range for Truck & Trailer by Aspöck, which is characterized through high quality and functional safety.

These features have made Aspöck a leading original equipment manufacturer in the field of vehicle lighting.





**Heckleuchte**  
Rear Lamp



**Umrissleuchte**  
End Outline Marker



**Positionsleuchte**  
Position Lamp

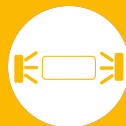

**Kennzeichenleuchte**  
Number Plate Lamp



**Bremsleuchte**  
Stop Lamp



**Rückfahrleuchte**  
Arbeitsscheinwerfer  
Reverse Lamp  
Working Lamp



**Innenleuchte**  
Interior Lamp



**Elektronisches Zubehör**  
Verbindungselemente  
Electronic Accesories  
Connection Elements



**Information**

# INHALT / CONTENT

## HECKLEUCHTE





### REAR LAMP

10	ECOLED II	
14	ECOLED	
16	EUROPOINT III	
24	EUROPOINT II	
30	EUROPOINT I	
32	ECOPOINT II	
38	ECOPOINT I	
44	ECOFLEX	
46	EUROFAB	
48	EARPOINT LED	
50	EARPOINT I	
52	MULTILED III	
56	MULTILED II	
60	MULTILED	
62	MULTIPOINT V	
64	MULTIPOINT LED	
66	MULTIPOINT I	
68	MINILED II	
70	LINEPOINT II	

72	LINEPOINT I	
74	BRASPOINT 98	
77	BRASPOINT 140	
80	ROUNDPOINT II	
81	ROUNDPOINT II LED	
82	3 CHAMBER LAMP II LED	
85	3 CHAMBER LAMP I LED	
86	3 CHAMBER LAMP	





## UMRISSLEUCHTE

### END OUTLINE MARKER

92	FLEXIPOINT I LED	
94	FLEXIPOINT I	
96	SUPERPOINT IV LED	
102	SUPERPOINT III LED	
106	SUPERPOINT II	

## POSITIONSLEUCHTE

### POSITION LAMP

112	FLATPOINT II LED	
116	FLATPOINT I LED	
120	UNIPOINT II LED	
122	UNIPOINT I LED	

TECHNISCHE ÄNDERUNGEN UND URHEBERRECHTE VORBEHALTEN.

IN DIESEM KATALOG ANGEFÜHRTE TECHNISCHE DATEN UND LEISTUNGSBESCHREIBUNGEN SIND UNVERBINDLICH. SIE BERUHEN AUF DURCHFÜHRTE TESTS UND ERFAHRUNGSWERTE.

128 UNIPOINT DI



130 UNIPOINT DI + SML



132 UNIPOINT MAXX LED



134 SIDEPOINT



138 POSIPOINT II LED



140 POSIPOINT I LED



142 MONOPOINT II LED



146 MONOPOINT I LED



## KENNZEICHENLEUCHTE

## NUMBER PLATE LAMP

150 REGPOINT II LED



152 REGPOINT LED



154 REGPOINT



## BREMSLEUCHTE

## STOP LAMP

162 3. BREMSLEUCHTE /  
3<sup>rd</sup> STOP LIGHT



## RÜCKFAHRLEUCHTE ARBEITSSCHEINWERFER REVERSE LAMP WORKING LAMP

166 RÜCKFAHRSCHEIN-  
WERFER /  
REVERSE LAMP



168 RÜCKFAHRSCHEIN-  
WERFER LED /  
REVERSE LAMP LED



170 WORKPOINT LED 3000



172 WORKPOINT LED 1500



174 WORKPOINT LED 800



176 WORKPOINT LED 650



## INNENLEUCHTE

## INTERIOR LAMP

180 INPOINT III LED



182 INTERIOR LAMP  
LED ROUND



183 INTERIOR LAMP LED



184 TUBEPOINT LED



## ELEKTRONISCHES ZUBEHÖR VERBINDUNGSELEMENTE ELECTRONIC ACCESORIES CONNECTION ELEMENTS

188 LCG



192 VERBINDER /  
CONNECTORS



## ZUSÄTZLICHE INFORMATION

## ADDITIONAL INFORMATION

196 E - NUMMERN  
ÜBERSICHT



197 APPROVAL NUMBER  
OVERVIEW



198 ARTIKELNUMMERN /  
PART NUMBERS

XX-XXXX-XXX

202 PIKTOGRAMM  
ÜBERSICHT /  
PICTOGRAM  
OVERVIEW



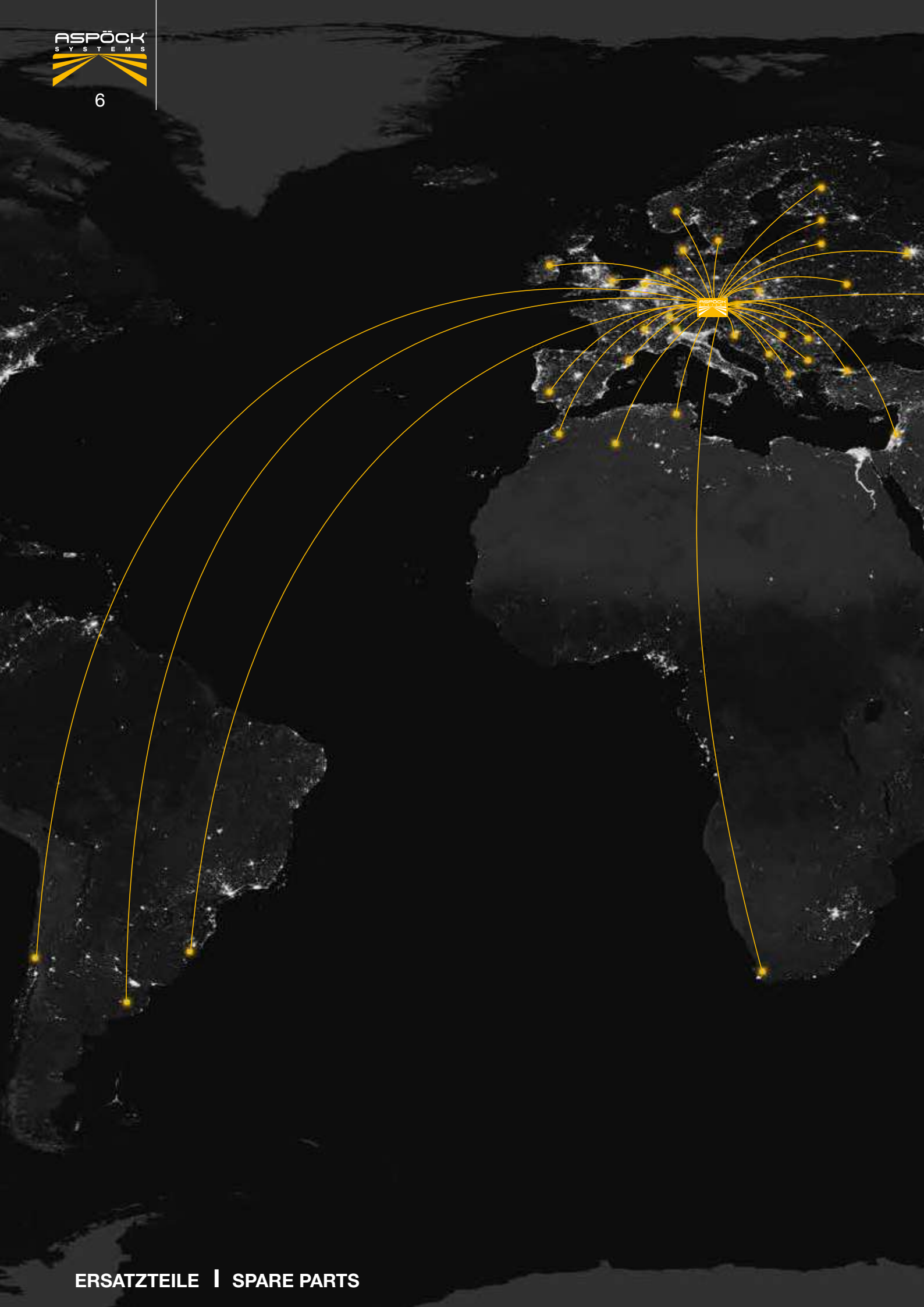

## UNTERNEHMEN

Das österreichische Familienunternehmen Aspöck Systems bringt seit über 40 Jahren mit der Herstellung von Beleuchtungssystemen das Licht auf die Straße. Dabei stehen seit jeher Qualität und Präzision an vorderster Stelle. Diese Philosophie hat das Unternehmen zum führenden Hersteller vorgefertigter Lichtanlagen für gezogene Fahrzeuge aller Art gemacht.

Der Hauptsitz von Aspöck Systems befindet sich in Peuerbach / Oberösterreich, von wo aus das Unternehmen um weitere Produktionsstätten in Portugal, Polen und Brasilien gewachsen ist. Dazu verteilen sich Vertriebsniederlassungen und Vertriebspartner rund um den Globus und sichern ein weltweites Vertriebs- & Servicenetz.

## COMPANY

The Austrian family-run company Aspöck Systems has brought light onto the streets for over 40 years now through the manufacture of lighting systems. Here quality and precision have always been of primary importance. This philosophy has made the company the leading manufacturer of preassembled lighting systems for towed vehicles of all kinds.

The headquarter of Aspöck Systems is located in Peuerbach / Upper Austria, from where the company has expanded by further production facilities in Portugal, Poland and Brazil. In addition, sales subsidiaries and sales partners are distributed around the globe to secure a worldwide Sales and Service network.

FÖÖKX<sup>®</sup>

S T E M S





## HECKLEUCHE

Das Aspöck Sortiment weist eine große Auswahl an unterschiedlichsten Heckleuchten auf. Je nach Bedarf sind verschiedene Funktionen integriert, welche von Ein-, Zwei- bis Mehrfunktionsleuchten reichen.

## REAR LAMP

The Aspöck range features a large selection of very different rear lamps. Dependent on requirements, various functions are integrated which extend from single and dual-function to multifunction lamps.

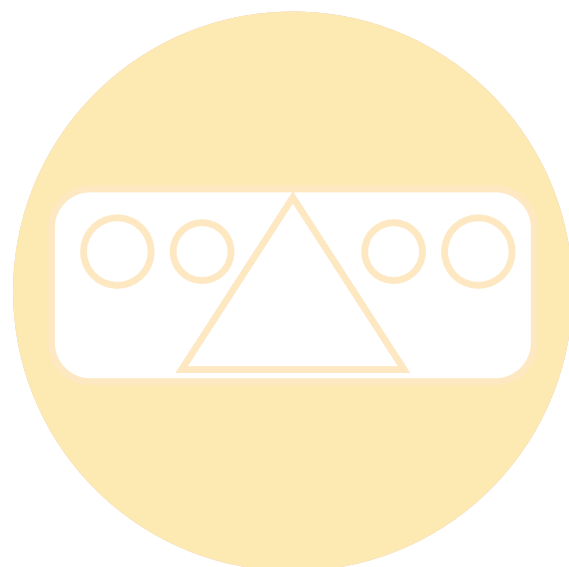



# ECOLED II

ISO 13207-1 ADR Zone 2 IP 54

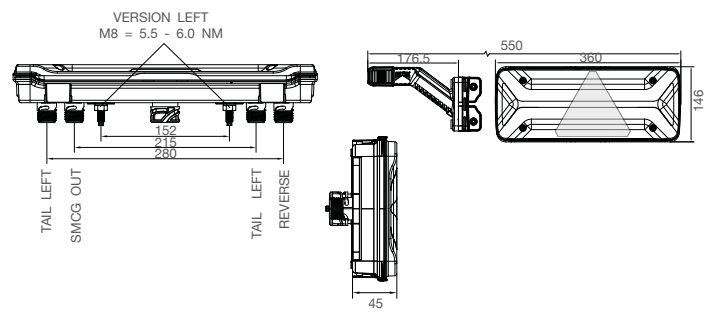

Blinklicht Direction indicator	Rücklicht Tail light	Bremslicht Stop light	Nebelschlusslicht Fog light
Rückfahrlicht Reverse light	Dreieckrückstrahler Triangle reflector		

BEST. NR PART NO	Box	←	→	LED	12V 24V	LED	ZUSATZ	ANSCHLUSS
							ADD ON	CONNECTOR
25-4121-001	1/8	●		LED	12V 24V			7 pol. ASS2.1 7 pin ASS2.1 ♂
25-4121-011	1/8	●		LED	12V 24V			7 pol. ASS2.1 7 pin ASS2.1 ♂ 4 x 2 pol. ASS2 4 x 2 pin ASS2
25-4121-021	1/8	●		LED	12V 24V	LED		7 pol. ASS2.1 7 pin ASS2.1 ♂ 4 x 2 pol. ASS2 4 x 2 pin ASS2
25-4121-031	1/8	●		LED	12V 24V			7 pol. AMP 7 pin AMP ♂
25-4121-041	1/8	●		LED	12V 24V			7 pol. AMP 7 pin AMP ♂ 4 x 2 pol. Superseal 4 x 2 pin Superseal
25-4121-051	1/8	●		LED	12V 24V	LED		7 pol. AMP 7 pin AMP ♂ 4 x 2 pol. Superseal 4 x 2 pin Superseal
25-4120-001	1/8		●	LED	12V 24V			7 pol. ASS2.1 7 pin ASS2.1 ♂
25-4120-011	1/8		●	LED	12V 24V			7 pol. ASS2.1 7 pin ASS2.1 ♂ 4 x 2 pol. ASS2 4 x 2 pin ASS2
25-4120-021	1/8		●	LED	12V 24V	LED		7 pol. ASS2.1 7 pin ASS2.1 ♂ 4 x 2 pol. ASS2 4 x 2 pin ASS2
25-4120-031	1/8		●	LED	12V 24V			7 pol. AMP 7 pin AMP ♂
25-4120-041	1/8		●	LED	12V 24V			7 pol. AMP 7 pin AMP ♂ 4 x 2 pol. Superseal 4 x 2 pin Superseal
25-4120-051	1/8		●	LED	12V 24V	LED		7 pol. AMP 7 pin AMP ♂ 4 x 2 pol. Superseal 4 x 2 pin Superseal



# ECOLED II SMARTBOX

ISO 13207-1 ADR Zone 2 IP 54

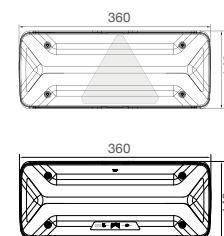
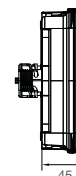
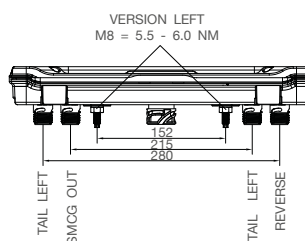

Blinklicht Direction indicator	Rücklicht Tail light	Bremslicht Stop light	Nebelschlusslicht Fog light
Rückfahrlicht Reverse light			

BEST. NR							ZUSATZ	ANSCHLUSS
PART NO							ADD ON	CONNECTOR
25-4126-001	1/-	●	●	LED	12V 24V			7 pol. ASS2.1 7 pin ASS2.1
25-4126-011	1/-	●	●	LED	12V 24V			7 pol. ASS2.1 7 pin ASS2.1   4 x 2 pol. ASS2 4 x 2 pin ASS2
25-4126-031	1/-	●	●	LED	12V 24V			7 pol. AMP 7 pin AMP
25-4126-041	1/-	●	●	LED	12V 24V			7 pol. AMP 7 pin AMP   4 x 2 pol. Superseal 4 x 2 pin Superseal
25-4126-061	1/-	●	●	LED	12V 24V			7 pol. AMP 7 pin AMP



# ECOLED II Truck Version

ISO 13207-1

ADR Zone 2

IP 54

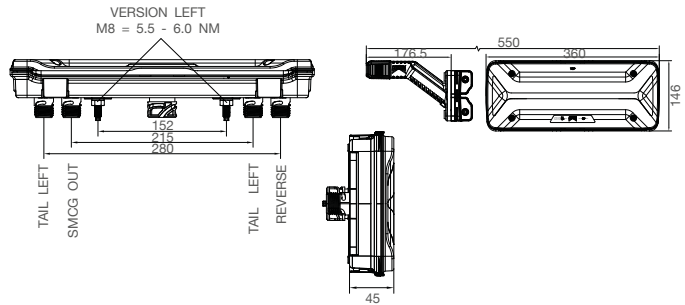

Blinklicht Direction indicator	Rücklicht Tail light	Bremslicht Stop light	Nebelschlusslicht Fog light
Rückfahrlicht Reverse light			

BEST. NR							ZUSATZ	ANSCHLUSS
PART NO							ADD ON	CONNECTOR
25-4121-061	1/8	●		LED	12V 24V			7 pol. AMP 7 pin AMP ♂
25-4120-061	1/8		●	LED	12V 24V			7 pol. AMP 7 pin AMP ♂



ECOLED II

ZUBEHÖR / ACCESSORIES





- 1** **Lichtscheibe | lens**  
mit Dreieck ..... 18-8536-001   
ohne Dreieck ..... 18-8536-011 

- 2** **Umrißarm LED inkl. Haltewinkel und Schrauben  
end outline marker LED incl. bracket and screws**
- (a) ASS2 links 12V / 24V  
ASS2 left 12V / 24V ..... 31-3103-204   
ASS2 rechts 12V / 24V ..... 31-3102-204 
- (b) Superseal links 12V / 24V  
Superseal left 12V / 24V .. 31-3103-214   
Superseal rechts 12V / 24V ..... 31-3102-214 

- 3** **Haltewinkel + Schrauben | bracket + screws**  
..... 15-5300-294 

- 4** **ASS1 & ASS2 Verbinder |  
ASS1 & ASS2 connector**
- (a) 2 pol. weiblich  
2 pin female ..... 13-5626-401 
- (b) 7 pol. weiblich  
7 pin female ..... 13-5626-631 
- (c) Verschlusskappe  
closed connection ..... 15-5623-304 

- 5** **Superseal Verbinder |  
Superseal connector**  
2 pol. weiblich  
2 pin female ..... 15-7002-044 

- 6** **AMP Verbinder |  
AMP connector**  
7 pol. weiblich  
7 pin female ..... 15-7002-024 

- 7** **Schutzhaube | protection cap**  
..... 25-7537-154 



ECOLED

ADR Zone 2 IP69K

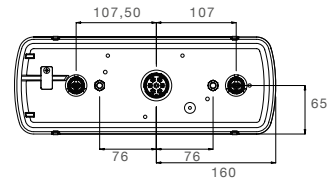
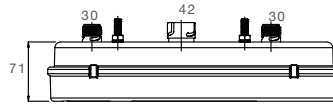
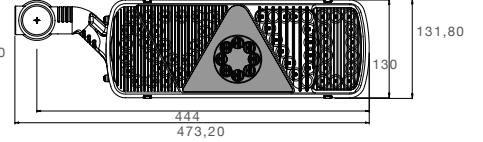
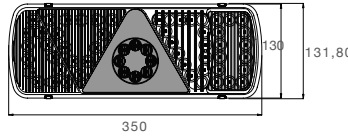

Blinklicht Direction indicator	Rücklicht Tail light	Bremslicht Stop light	Nebelschlusslicht Fog light
Rückfahrlicht Reverse light	Dreieckrückstrahler Triangle reflector	Seitenmarkierungslicht + Reflektor Sidemarker light + reflector	

BEST. NR	PART NO							ZUSATZ ADD ON	ANSCHLUSS CONNECTOR
25-3800-501	1/10	●			LED	24V		7 pol. ASS2 7 pin ASS2	
25-3800-511	1/10	●			LED	24V		7 pol. ASS2.1 7 pin ASS2.1	2 x 2 pol. ASS2 2 x 2 pin ASS2
25-3820-511	1/-	●			LED	24V	LED	7 pol. ASS2.1 7 pin ASS2.1	2 x 2 pol. ASS2 2 x 2 pin ASS2
25-3900-501	1/10		●		LED	24V		7 pol. ASS2 7 pin ASS2	
25-3900-511	1/10		●		LED	24V		7 pol. ASS2.1 7 pin ASS2.1	2 x 2 pol. ASS2 2 x 2 pin ASS2
25-3920-511	1/-		●		LED	24V	LED	7 pol. ASS2.1 7 pin ASS2.1	2 x 2 pol. ASS2 2 x 2 pin ASS2



ECOLED

ZUBEHÖR / ACCESSORIES



**1 Umrissarm LED | outline marker LED**

- rot / weiß / orange links  
red / white / orange left  
..... 31-3305-234
- rot / weiß / orange rechts  
red / white / orange right  
..... 31-3306-234

**2 Schutzhaube | protection cap**

- ..... 15-5277-004

**3 ASS1 & ASS2 Verbinder |  
ASS1 & ASS2 connector**

- (a) 2 pol. weiblich  
2 pin female ..... 13-5626-401
- (b) 7 pol. weiblich  
7 pin female ..... 13-5626-631
- (c) Verschlusskappe  
closed connection ..... 15-5623-304

**4 LED Vorschaltgerät | LED control gear**

- ..... 75-0309-001
- siehe Seite 166  
see at page 166



**EUROPOINT III** links  
left

ADR Zone 2 IP 56K

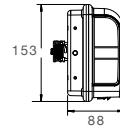
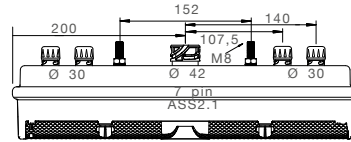
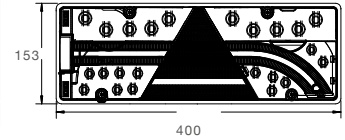
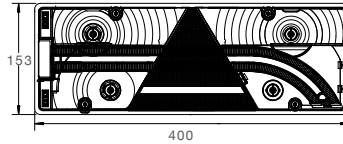

Blinklicht Direction indicator	Rücklicht Tail light	Bremslicht Stop light	Nebelschlusslicht Fog light
Rückfahrlicht Reverse light	Dreieckrückstrahler Triangle reflector	Seitenmarkierungslicht + Reflektor Sidemarker light + reflector	

BEST. NR	PART NO	Box	←	→	LED	24V	Light Type	ZUSATZ ADD ON	ANSCHLUSS CONNECTOR
25-7000-501	1/10	●			LED	24V			7 pol. ASS2.1 7 pin ASS2.1
25-7000-511	1/10	●			LED	24V			7 pol. ASS2.1 7 pin ASS2.1
25-7000-701	1/10	●			LED	24V			7 pol. ASS2.1 7 pin ASS2.1
25-7000-711	1/10	●			LED	24V			7 pol. ASS2.1 7 pin ASS2.1
25-7000-721	1/10	●			LED	24V			7 pol. ASS2.1 7 pin ASS2.1
25-7000-741	1/10	●			LED	24V			7 pol. ASS2.1 7 pin ASS2.1
25-7030-721	1/10	●			LED	24V			7 pol. AMP 7 pin AMP
25-7001-501	1/10	●			LED	24V			7 pol. ASS2.1 7 pin ASS2.1
25-7001-601	1/10	●			LED	24V			7 pol. ASS2.1 7 pin ASS2.1
25-7030-711	1/10	●			LED	24V			7 pol. AMP 7 pin AMP
25-7001-611	1/10	●			LED	24V			7 pol. ASS2.1 7 pin ASS2.1
25-7002-001	1/10	●			LED	24V			7 pol. ASS2.1 7 pin ASS2.1
25-7000-761	1/10	●			LED	24V			7 pol. ASS2.1 7 pin ASS2.1





EUROPOINT III rechts  
right

ADR Zone 2 IP 56K

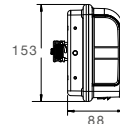
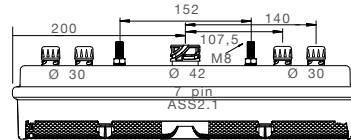
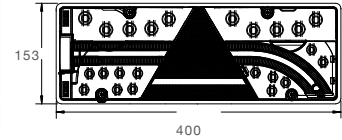
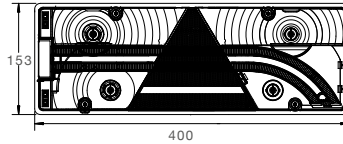

Blinklicht Direction indicator	Rücklicht Tail light	Bremslicht Stop light	Nebelschlusslicht Fog light
Rückfahrlicht Reverse light	Dreieckrückstrahler Triangle reflector	Seitenmarkierungslicht + Reflektor Sidemarker light + reflector	

BEST. NR	PART NO	←	→	LED	24V	ZUSATZ	ANSCHLUSS	
						ADD ON	CONNECTOR	
25-7430-721	1/10	●		LED	24V		7 pol. AMP 7 pin AMP ♂	4 x 2 pol. Superseal 4 x 2 pin Superseal
25-7400-501	1/10	●		LED	24V		7 pol. ASS2.1 7 pin ASS2.1 ♂	
25-7400-511	1/10	●		LED	24V		7 pol. ASS2.1 7 pin ASS2.1 ♂	4 x 2 pol. ASS2 4 x 2 pin ASS2
25-7400-701	1/10	●		LED	24V		7 pol. ASS2.1 7 pin ASS2.1 ♂	
25-7400-711	1/10	●		LED	24V		7 pol. ASS2.1 7 pin ASS2.1 ♂	4 x 2 pol. ASS2 4 x 2 pin ASS2
25-7400-721	1/10	●		LED	24V		7 pol. ASS2.1 7 pin ASS2.1 ♂	
25-7400-741	1/10	●		LED	24V		7 pol. ASS2.1 7 pin ASS2.1 ♂	
25-7401-531	1/10	●		LED	24V		7 pol. ASS2.1 7 pin ASS2.1 ♂	
25-7401-601	1/10	●		LED	24V		7 pol. ASS2.1 7 pin ASS2.1 ♂	4 x 2 pol. ASS2 4 x 2 pin ASS2
25-7430-711	1/10	●		LED	24V		7 pol. AMP 7 pin AMP ♂	4 x 2 pol. Superseal 4 x 2 pin Superseal
25-7401-611	1/10	●		LED	24V		7 pol. ASS2.1 7 pin ASS2.1 ♂	4 x 2 pol. ASS2 4 x 2 pin ASS2
25-7402-001	1/10	●		LED	24V		7 pol. ASS2.1 7 pin ASS2.1 ♂	4 x 2 pol. ASS2 4 x 2 pin ASS2
25-7400-761	1/10	●		LED	24V		7 pol. ASS2.1 7 pin ASS2.1 ♂	4 x 2 pol. ASS2 4 x 2 pin ASS2



**EUROPOINT III** links mit Umrissarm  
left with end outline marker

ADR Zone 2 IP56K

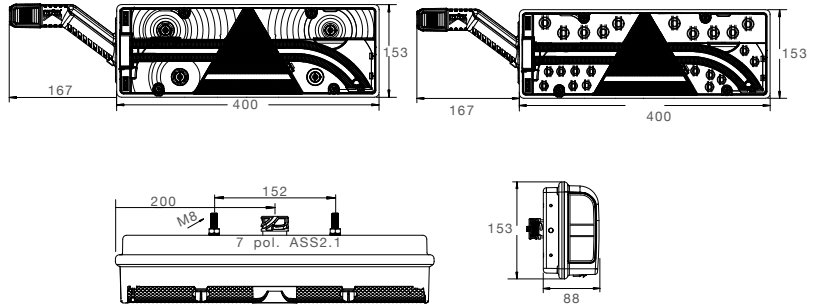

Blinklicht Direction indicator	Rücklicht Tail light	Bremslicht Stop light	Nebelschlusslicht Fog light
Rückfahrt Reverse light	Dreieckrückstrahler Triangle reflector	Seitenmarkierungslicht + Reflektor Sidemarker light + reflector	

BEST. NR	PART NO	Box	←	→	LED	24V	LED	ZUSATZ	ANSCHLUSS
								ADD ON	CONNECTOR
25-7020-501	1/6	●			LED	24V	LED		7 pol. ASS2.1 7 pin ASS2.1 ♂
25-7020-511	1/6	●			LED	24V	LED		7 pol. ASS2.1 7 pin ASS2.1 ♂ 4 x 2 pol. ASS2 4 x 2 pin ASS2
25-7020-541	1/6	●			LED	24V	LED		7 pol. ASS2.1 7 pin ASS2.1 ♂
25-7020-701	1/6	●			LED	24V	LED		7 pol. ASS2.1 7 pin ASS2.1 ♂
25-7020-711	1/6	●			LED	24V	LED		7 pol. ASS2.1 7 pin ASS2.1 ♂ 4 x 2 pol. ASS2 4 x 2 pin ASS2
25-7020-721	1/6	●			LED	24V	LED		7 pol. ASS2.1 7 pin ASS2.1 ♂
25-7020-731	1/6	●			LED	24V	LED		7 pol. ASS2.1 7 pin ASS2.1 ♂
25-7021-511	1/6	●			LED	24V	LED		7 pol. ASS2.1 7 pin ASS2.1 ♂ 4 x 2 pol. ASS2 4 x 2 pin ASS2
25-7002-101	1/6	●			LED	24V	LED		7 pol. ASS2.1 7 pin ASS2.1 ♂ 4 x 2 pol. ASS2 4 x 2 pin ASS2
25-7020-741	1/6	●			LED	24V	LED		7 pol. ASS2.1 7 pin ASS2.1 ♂ 4 x 2 pol. ASS2 4 x 2 pin ASS2
25-7020-751	1/6	●			LED	24V	LED		7 pol. ASS2.1 7 pin ASS2.1 ♂ 4 x 2 pol. ASS2 4 x 2 pin ASS2
25-7021-521	1/6	●			LED	24V	LED		7 pol. ASS2.1 7 pin ASS2.1 ♂ 4 x 2 pol. ASS2 4 x 2 pin ASS2



**EUROPOINT III** rechts mit Umrissarm  
right with end outline marker

ADR Zone 2 IP 56K

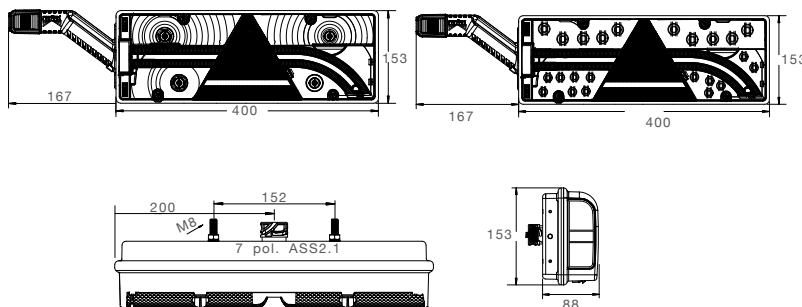

Blinklicht Direction indicator	Rücklicht Tail light	Bremslicht Stop light	Nebelschlusslicht Fog light
Rückfahrlicht Reverse light	Dreieckrückstrahler Triangle reflector	Seitenmarkierungslicht + Reflektor Sidemarker light + reflector	

BEST. NR	PART NO	←	→	LED	24V	LED	ZUSATZ	ANSCHLUSS
							ADD ON	CONNECTOR
25-7420-501	1/6	●		LED	24V	LED		7 pol. ASS2.1 7 pin ASS2.1 ♂
25-7420-511	1/6	●		LED	24V	LED		7 pol. ASS2.1 7 pin ASS2.1 ♂ 4 x 2 pol. ASS2 4 x 2 pin ASS2
25-7420-541	1/6	●		LED	24V	LED		7 pol. ASS2.1 7 pin ASS2.1 ♂
25-7420-551	1/6	●		LED	24V	LED		7 pol. ASS2.1 7 pin ASS2.1 ♂ 4 x 2 pol. ASS2 4 x 2 pin ASS2
25-7420-701	1/6	●		LED	24V	LED		7 pol. ASS2.1 7 pin ASS2.1 ♂
25-7420-711	1/6	●		LED	24V	LED		7 pol. ASS2.1 7 pin ASS2.1 ♂ 4 x 2 pol. ASS2 4 x 2 pin ASS2
25-7420-721	1/6	●		LED	24V	LED		7 pol. ASS2.1 7 pin ASS2.1 ♂
25-7420-751	1/6	●		LED	24V	LED		7 pol. ASS2.1 7 pin ASS2.1 ♂ 4 x 2 pol. ASS2 4 x 2 pin ASS2
25-7420-761	1/6	●		LED	24V	LED		7 pol. ASS2.1 7 pin ASS2.1 ♂
25-7421-521	1/6	●		LED	24V	LED		7 pol. ASS2.1 7 pin ASS2.1 ♂ 4 x 2 pol. ASS2 4 x 2 pin ASS2
25-7402-101	1/6	●		LED	24V	LED		7 pol. ASS2.1 7 pin ASS2.1 ♂ 4 x 2 pol. ASS2 4 x 2 pin ASS2
25-7420-741	1/6	●		LED	24V	LED		7 pol. ASS2.1 7 pin ASS2.1 ♂ 4 x 2 pol. ASS2 4 x 2 pin ASS2
25-7420-771	1/6	●		LED	24V	LED		7 pol. ASS2.1 7 pin ASS2.1 ♂ 4 x 2 pol. ASS2 4 x 2 pin ASS2
25-7421-531	1/6	●		LED	24V	LED		7 pol. ASS2.1 7 pin ASS2.1 ♂ 4 x 2 pol. ASS2 4 x 2 pin ASS2



# EUROPOINT III Truck Version

ADR Zone 2 IP 56K

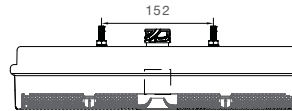
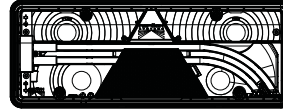

Blinklicht Direction indicator	Rücklicht Tail light	Bremslicht Stop light	Nebelschlusslicht Fog light
Rückfahrlicht Reverse light	Seitenmarkierungslicht + Reflektor Sidemarker light + reflector		

BEST. NR		←	→				ZUSATZ	ANSCHLUSS
PART NO							ADD ON	CONNECTOR
25-7000-541	1/10	●			24V			7 pol AMP 7 pin AMP
25-7000-751	1/10	●			24V			7 pol AMP 7 pin AMP
25-7400-541	1/10		●		24V			7 pol AMP 7 pin AMP
25-7400-751	1/10		●		24V			7 pol AMP 7 pin AMP

# THE ART OF LIGHTS



## ECOLED II

WECHSELBARE LICHTSCHEIBE | GLOWING BODY TECHNOLOGIE | BEIDSEITIG VERWENDBAR  
REPLACEABLE LENS | GLOWING BODY TECHNOLOGY | CAN BE USED ON BOTH SIDES

In einem „Glowing Body“ gebündelt Licht, präsentiert ASPÖCK mit der Heckleuchte **ECOLED II** für Trailer + Truck. Klares Design in seinen Beleuchtungslösungen und neue technische Visionen bringen seit über 40 Jahren das Licht auf die Straße.

The **ASPÖCK ECOLED II rear lamp** for trailers and trucks is light housed in a glowing body. A clear design in its lighting solutions and new technological visions have brought light to the road for over 40 years.



EUROPOINT III

ZUBEHÖR / ACCESSORIES

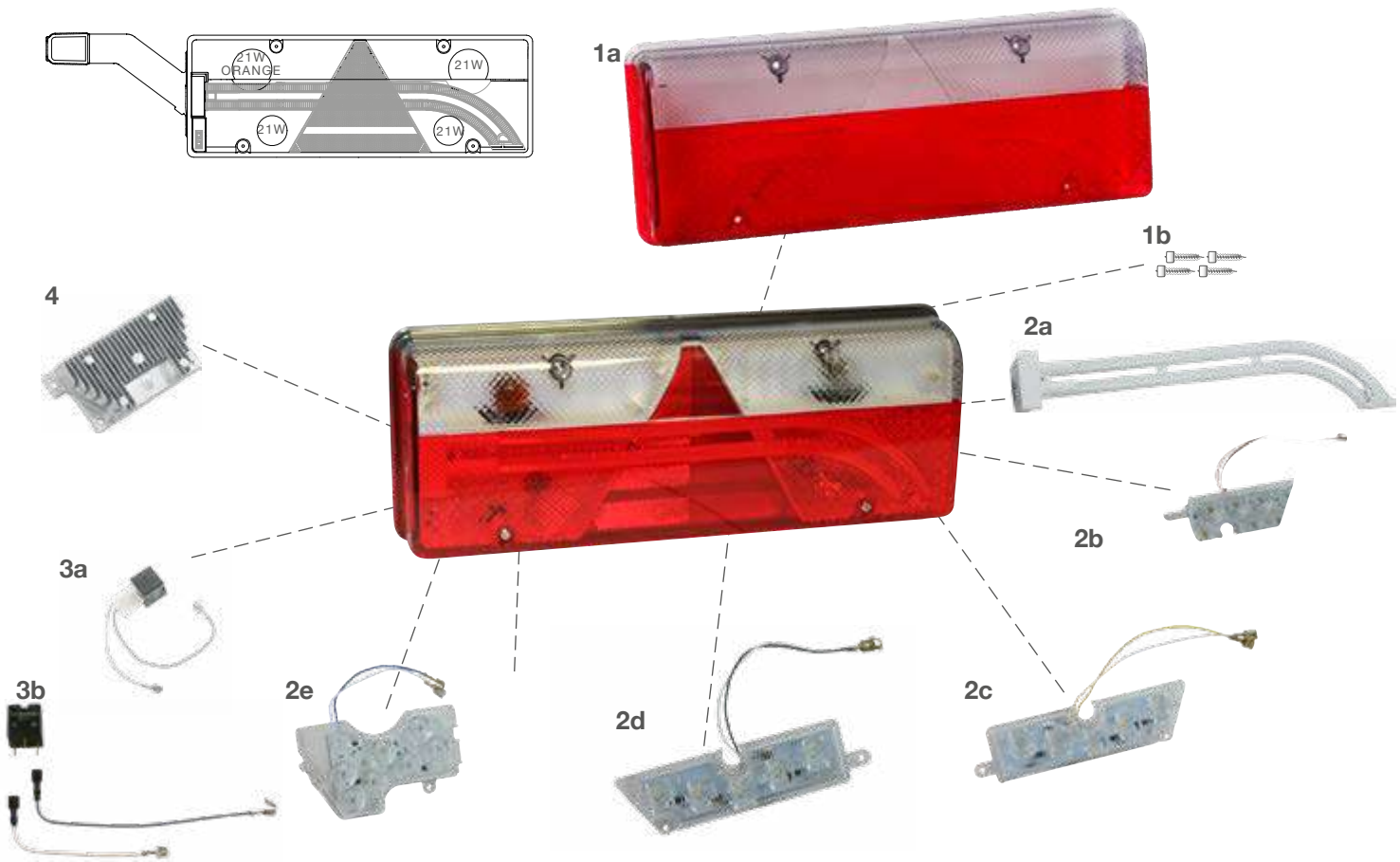

**1** (a) Lichtscheibe | lens

- links  
left..... 18-8570-001
- rechts  
right ..... 18-8570-101
- links mit KZL  
left with no. plate lamp 18-8570-011
- rechts mit KZL  
right with no. plate lamp 18-8570-111

(b) Schrauben für Lichtscheibe |  
Screws for lens

- ..... 14-1430-554

**2** LED Einsätze | LED inserts

- (a) Rücklicht links („Light Guide“) 12V / 24V  
tail left („Light Guide“) 12V / 24V  
..... 12-1570-001
- Rücklicht rechts („Light Guide“) 12V / 24V  
tail right („Light Guide“) 12V / 24V  
..... 12-1570-101
- (b) Bremslicht links 12V / 24V  
stop left 12V / 24V  
..... 12-1570-204

- Bremslicht rechts 12V / 24V  
stop light right 12V / 24V  
..... 12-1574-204

- (c) Blinklicht links 24V  
direction indicator left 24V  
..... 12-1570-224

- Blinklicht rechts 24V  
direction indicator right 24V  
..... 12-1574-224

- (d) Rückfahrlicht links 24V  
reverse left 24V ..... 12-1570-234
- Rückfahrlicht rechts 24V  
reverse right 24V ..... 12-1574-234

- (e) Nebelschlusslicht links 24V  
fog left 24V ..... 12-1570-214
- Nebelschlusslicht rechts 24V  
fog right 24V ..... 12-1574-214

**3** Relais

- (a) Rückfahrwarner 24V  
reverse alarm 24V  
..... 12-3922-004
- (b) SMCG Steuerung für Seitenmarkierungsleuchten  
SMCG side marker control gear  
..... 12-3970-584



# EUROPOINT III

## ZUBEHÖR / ACCESSORIES

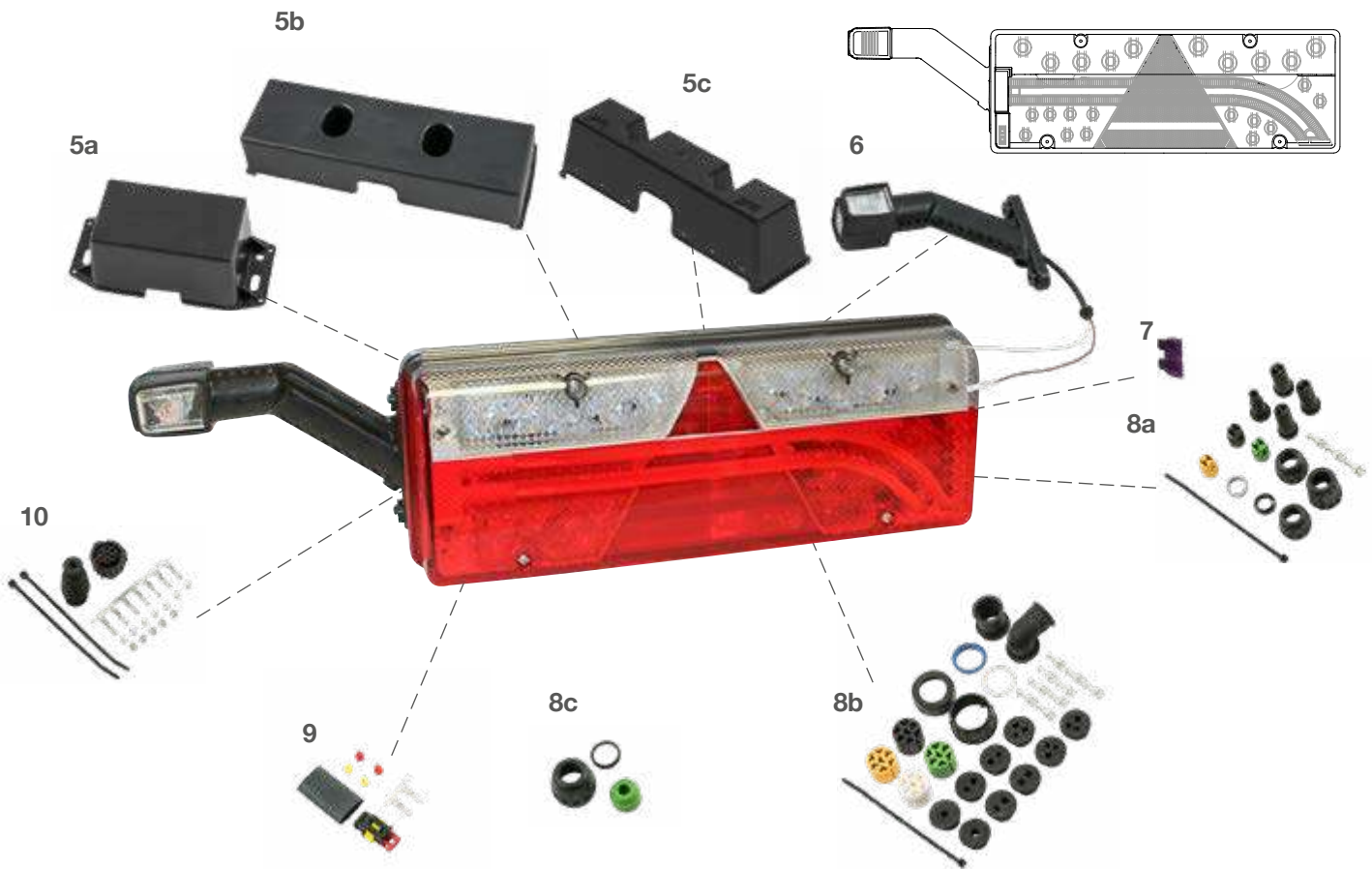

**4 LED Vorschaltgerät | LED control gear**  
 LCG ..... 25-7008-024   
 siehe Seite 188  
 see at page 188

**5 Schutzhaube | protection cap**  
 (a) klein  
 small ..... 15-5270-004   
 (b) groß  
 big ..... 15-5276-004   
 (c) groß  
 big ..... 25-7537-154

**6 Umrissarm LED | outline marker LED**  
 links 12V / 24V  
 left 12V / 24V ..... 31-3103-024   
 rechts 12V / 24V  
 right 12V / 24V ..... 31-3102-024

**7 Sicherung | fuse**  
 3 A ..... 12-6830-094

**8 ASS1 & ASS2 Verbinder | ASS1 & ASS2 connector**  
 (a) 2 pol. weiblich  
 2 pin female ..... 13-5626-401   
 (b) 7 pol. weiblich  
 7 pin female ..... 13-5626-631   
 (c) Verschlusskappe  
 closed connection ..... 15-5623-304

**9 Superseal Verbinder | Superseal connector**  
 2 pol. weiblich  
 2 pin female ..... 15-7002-044

**10 AMP Verbinder | AMP connector**  
 7 pol. weiblich  
 7 pin female ..... 15-7002-024

**Glühlampe | bulb**  
 24V 21W orange ..... 16-6321-617   
 24V 21W ..... 16-6321-037



**EUROPOINT II** links  
left

ADR Zone 2

IP 54

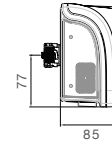
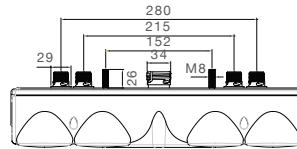
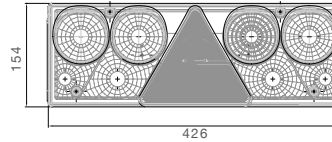

Blinklicht Direction indicator	Rücklicht Tail light	Bremslicht Stop light	Nebelschlusslicht Fog light
Rückfahrlicht Reverse light	Dreieckrückstrahler Triangle reflector	Seitenmarkierungslicht + Reflektor Sidemarker light + reflector	

BEST. NR PART NO							ZUSATZ ADD ON	ANSCHLUSS CONNECTOR				
25-6000-501	1/10	●			24V			7 pol. ASS2 7 pin ASS2				
25-6000-701	1/10	●			24V			7 pol. ASS2 7 pin ASS2				
25-6000-711	1/10	●			24V			7 pol. ASS2.1 7 pin ASS 2.1				
25-6000-721	1/10	●			24V			7 pol. ASS2 7 pin ASS2				
25-6000-741	1/10	●			24V			7 pol. ASS2 7 pin ASS2				
25-6000-751	1/10	●			24V			7 pol. ASS2 7 pin ASS2				
25-6001-501	1/10	●			24V			7 pol. ASS2 7 pin ASS2				
25-6010-501	1/10	●			24V			7 pol. ASS2.1 7 pin ASS2.1			4 x 2 pol. ASS2 4 x 2 pin ASS2	
25-6010-541	1/10	●			24V			7 pol. ASS2 7 pin ASS2				
25-6011-501	1/10	●			24V			7 pol. ASS2.1 7 pin ASS 2.1			4 x 2 pol. ASS2 4 x 2 pin ASS2	
25-6030-501	1/10	●			24V			7 pol. AMP 7 pin AMP			4 x 2 pol. Superseal 4 x 2 pin Superseal	
25-6030-701	1/10	●			24V			7 pol. AMP 7 pin AMP			4 x 2 pol. Superseal 4 x 2 pin Superseal	
25-6030-711	1/10	●			24V			7 pol. AMP 7 pin AMP			4 x 2 pol. Superseal 4 x 2 pin Superseal	
25-6101-501	1/10	●			24V			7 pol. ASS2 7 pin ASS2			2 x 2 pol. ASS2 2 x 2 pin ASS2	
25-6200-501	1/10	●			24V			7 pol. ASS2 7 pin ASS2			4 x 2 pol. ASS2 4 x 2 pin ASS2	
25-6201-511	1/10	●			24V			7 pol. ASS2.1 7 pin ASS 2.1			4 x 2 pol. ASS2 4 x 2 pin ASS2	
25-6030-511	1/10	●			24V			7 pol. AMP 7 pin AMP			4 x 2 pol. Superseal 4 x 2 pin Superseal	
25-6030-721	1/10	●			24V			7 pol. AMP 7 pin AMP			4 x 2 pol. Superseal 4 x 2 pin Superseal	





EUROPOINT II rechts  
right

ADR Zone 2

IP 54

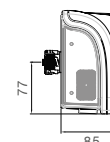
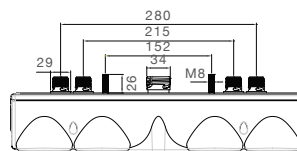
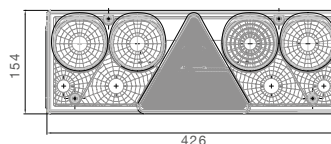

Blinklicht Direction indicator	Rücklicht Tail light	Bremslicht Stop light	Nebelschlusslicht Fog light
Rückfahrlicht Reverse light	Dreieckrückstrahler Triangle reflector	Seitenmarkierungslicht + Reflektor Sidemarker light + reflector	

BEST. NR	PART NO							ZUSATZ	ANSCHLUSS
								ADD ON	CONNECTOR
25-6400-501	1/10		●		24V				7 pol. ASS2 7 pin ASS2
25-6400-701	1/10		●		24V				7 pol. ASS2 7 pin ASS2
25-6400-711	1/10		●		24V				7 pol. ASS2.1 7 pin ASS 2.1
25-6400-721	1/10		●		24V				7 pol. ASS2 7 pin ASS2
25-6400-741	1/10		●		24V				7 pol. ASS2 7 pin ASS2
25-6400-751	1/10		●		24V				7 pol. ASS2 7 pin ASS2
25-6401-501	1/10		●		24V				7 pol. ASS2 7 pin ASS2
25-6410-501	1/10		●		24V				7 pol. ASS2.1 7 pin ASS2.1
25-6410-541	1/10		●		24V				7 pol. ASS2 7 pin ASS2
25-6411-501	1/10		●		24V				7 pol. ASS2.1 7 pin ASS 2.1
25-6430-501	1/10		●		24V				7 pol. AMP 7 pin AMP
25-6430-701	1/10		●		24V				7 pol. AMP 7 pin AMP
25-6430-711	1/10		●		24V				7 pol. AMP 7 pin AMP
25-6501-501	1/10		●		24V				7 pol. ASS2 7 pin ASS2
25-6501-511	1/10		●		24V				7 pol. ASS2 7 pin ASS2
25-6600-501	1/10		●		24V				7 pol. ASS2 7 pin ASS2
25-6601-511	1/10		●		24V				7 pol. ASS2 7 pin ASS2
25-6430-511	1/10		●		24V				7 pol. AMP 7 pin AMP
25-6430-721	1/10		●		24V				7 pol. AMP 7 pin AMP



**EUROPOINT II** links mit Umrissarm  
left with end outline marker

ADR Zone 2 IP 54

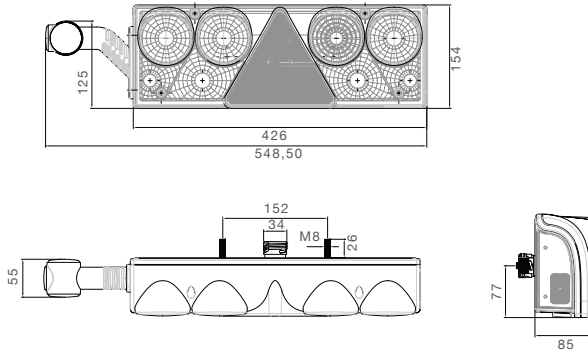

Blinklicht Direction indicator	Rücklicht Tail light	Bremslicht Stop light	Nebelschlusslicht Fog light
Rückfahrlicht Reverse light	Dreieckrückstrahler Triangle reflector	Seitenmarkierungslicht + Reflektor Sidemarker light + reflector	

BEST. NR	PART NO							ZUSATZ ADD ON	ANSCHLUSS CONNECTOR
25-6011-511	1/6	●			24V			7 pol. ASS2 7 pin ASS2	♂
25-6011-701	1/6	●			24V			7 pol. ASS2 7 pin ASS2	♂
25-6015-501	1/6	●			24V			7 pol. ASS2 7 pin ASS2	♂
25-6020-751	1/6	●			24V			7 pol. ASS2 7 pin ASS2	♂
25-6021-701	1/6	●			24V			7 pol. ASS2 7 pin ASS2	♂
25-6021-731	1/6	●			24V			7 pol. ASS2 7 pin ASS2	♂
25-6021-741	1/6	●			24V			7 pol. ASS2 7 pin ASS2	♂
25-6110-501	1/6	●			24V			7 pol. ASS2 7 pin ASS2	♂  2 x 2 pol. ASS2 2 x 2 pin ASS2
25-6110-711	1/6	●			24V			7 pol. ASS2 7 pin ASS2	♂  2 x 2 pol. ASS2 2 x 2 pin ASS2
25-6210-501	1/6	●			24V			7 pol. ASS2 7 pin ASS2	♂  4 x 2 pol. ASS2 4 x 2 pin ASS2
25-6211-501	1/6	●			24V			7 pol. ASS2 7 pin ASS2	♂  4 x 2 pol. ASS2 4 x 2 pin ASS2

EUROPOINT II rechts mit Umrissarm  
right with end outline marker

ADR Zone 2

IP 54

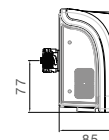
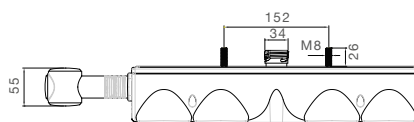
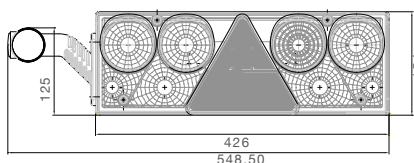

Blinklicht Direction indicator	Rücklicht Tail light	Bremslicht Stop light	Nebelschlusslicht Fog light
Rückfahrlicht Reverse light	Dreieckrückstrahler Triangle reflector	Seitenmarkierungslicht + Reflektor Sidemarker light + reflector	

BEST. NR		←	→	💡	⚡	🔦	ZUSATZ	ANSCHLUSS
PART NO							ADD ON	CONNECTOR
25-6411-511	1/6		●	💡	24V	💡		7 pol. ASS2 7 pin ASS2 ♂
25-6411-701	1/6		●		24V	💡		7 pol. ASS2 7 pin ASS2 ♂
25-6415-501	1/6		●	💡	24V	💡		7 pol. ASS2 7 pin ASS2 ♂
25-6420-751	1/6		●		24V			7 pol. ASS2 7 pin ASS2 ♂
25-6421-701	1/6		●	💡	24V			7 pol. ASS2 7 pin ASS2 ♂
25-6421-731	1/6		●		24V			7 pol. ASS2 7 pin ASS2 ♂
25-6421-741	1/6		●		24V			7 pol. ASS2 7 pin ASS2 ♂
25-6510-501	1/6		●	💡	24V	💡		7 pol. ASS2 7 pin ASS2 ♂  2 x 2 pol. ASS2 2 x 2 pin ASS2
25-6510-711	1/6		●	💡	24V			7 pol. ASS2 7 pin ASS2 ♂  2 x 2 pol. ASS2 2 x 2 pin ASS2
25-6610-501	1/6		●	💡	24V	💡		7 pol. ASS2 7 pin ASS2 ♂  4 x 2 pol. ASS2 4 x 2 pin ASS2
25-6611-501	1/6		●	💡	24V	💡		7 pol. ASS2 7 pin ASS2 ♂  4 x 2 pol. ASS2 4 x 2 pin ASS2



## EUROPOINT II

ZUBEHÖR / ACCESSORIES

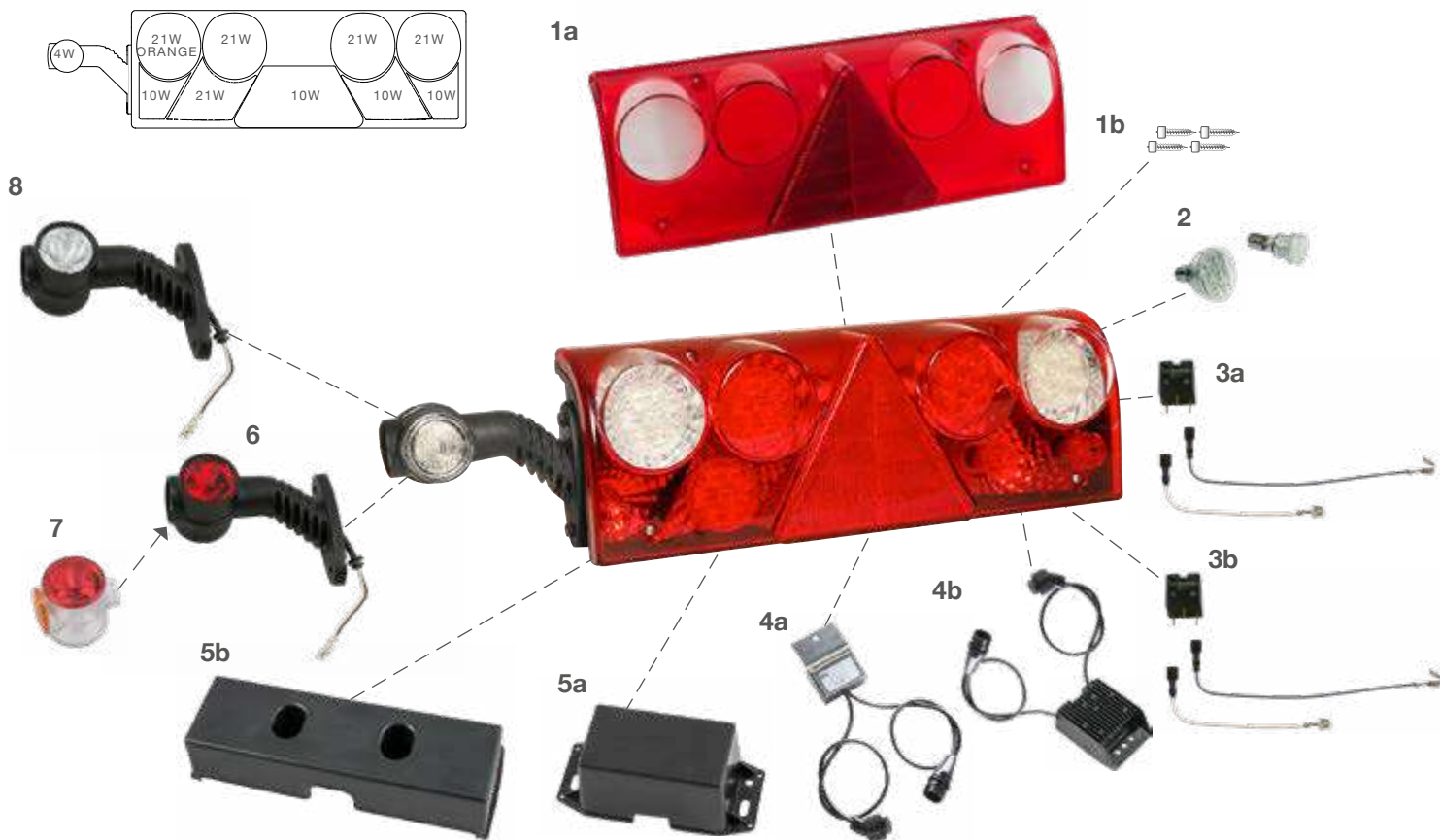

**1 (a) Lichtscheibe | lens**  
..... 18-8560-002

**(b) Schrauben für Lichtscheibe |  
Screws for lens**  
..... 14-1430-454

**2 LED Einsätze | LED inserts**  
Rücklicht 12V / 24V  
tail 12V / 24V..... 12-1560-001   
Bremslicht 12V / 24V  
stop light 12V / 24V ..... 12-1560-141   
Blinklicht 24V  
direction indicator 24V... 12-1560-011   
Rückfahrlicht 24V  
reverse 24V..... 12-1560-021   
Nebelschlusslicht 24V  
fog 24V ..... 12-1560-031

**3 Relais**  
**(a) Rückfahrwarner 24V**  
reverse alarm 24V  
..... 12-3922-004   
**(b) SMCG Steuerung für Seitenmarkierungsleuchten**  
SMCG side marker control gear  
..... 12-3970-584

**4 LED Vorschaltgerät | LED control gear**  
**(a) LCG 1** ..... 75-0300-001  
siehe Seite 188  
see at page 188

**(b) LCG 1 - V2**..... 75-0300-101  
siehe Seite 188  
see at page 188

**5 Schutzhaube | protection cap**  
**(a) klein**  
small ..... 15-5270-004   
**(b) groß**  
big ..... 15-5276-004

**6 Umrissarm Glühlampe | outline marker bulb**  
rot / weiß / orange links  
red / white / orange left  
..... 31-3305-064   
rot / weiß / orange rechts  
red / white / orange right  
..... 31-3306-064



**7 Lichtscheibe Umrissarm | lens outline marker**  
..... 18-8141-004



## EUROPOINT II

ZUBEHÖR / ACCESSORIES



- 8 Umrissarm LED | outline marker LED**  
 rot / weiß links  
 red / white left ..... 31-3305-084   
 rot / weiß rechts  
 red / white right ..... 31-3306-084 

- 9 Sicherung | fuse**  
 3 A ..... 12-6830-094 

- 10 ASS1 & ASS2 Verbinder | ASS1 & ASS2 connector**  
 (a) 2 pol. weiblich  
 2 pin female ..... 13-5626-401   
 (b) 7 pol. weiblich  
 7 pin female ..... 13-5626-631   
 (c) Verschlusskappe  
 closed connection ..... 15-5623-304 

- 11 Superseal Verbinder | Superseal connector**  
 2 pol. weiblich  
 2 pin female ..... 15-7002-044 

- 12 AMP Verbinder | AMP connector**  
 7 pol. weiblich  
 7 pin female ..... 15-7002-024 

- Glühlampe | bulb**  
 24V 21W orange ..... 16-6321-617   
 24V 21W ..... 16-6321-037   
 24V 10W ..... 16-6310-027   
 24V 4W ..... 16-6304-027 



# EUROPOINT I

ADR Zone 2

IP 54

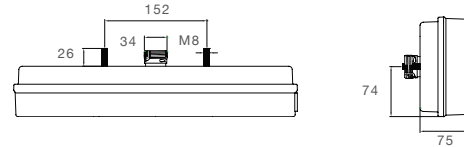
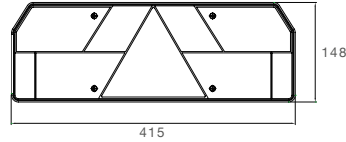

Blinklicht Direction indicator	Rücklicht Tail light	Bremslicht Stop light	Nebelschlusslicht Fog light
Rückfahrlicht Reverse light	Dreieckrückstrahler Triangle reflector	Seitenmarkierungslicht + Reflektor Sidemarker light + reflector	Begrenzungslicht hinten Rear position light

BEST. NR							ZUSATZ	ANSCHLUSS
PART NO							ADD ON	CONNECTOR
25-5000-501	1/10	●			24V			7 pol. ASS2 7 pin ASS2 
25-5001-501	1/10	●			24V			7 pol. ASS2 7 pin ASS2 
25-5100-501	1/10	●			24V			PG Verschraubung cable glands 
35-5103-011	1/ -	●			24V			offenes Ende open end 2,70 m
25-5400-501	1/10		●		24V			7 pol. ASS2 7 pin ASS2 
25-5401-501	1/10		●		24V			7 pol. ASS2 7 pin ASS2 
25-5500-501	1/10		●		24V			PG Verschraubung cable glands 
35-5502-011	1/ -		●		24V			offenes Ende open end 3,70 m



EUROPOINT I

ZUBEHÖR / ACCESSORIES

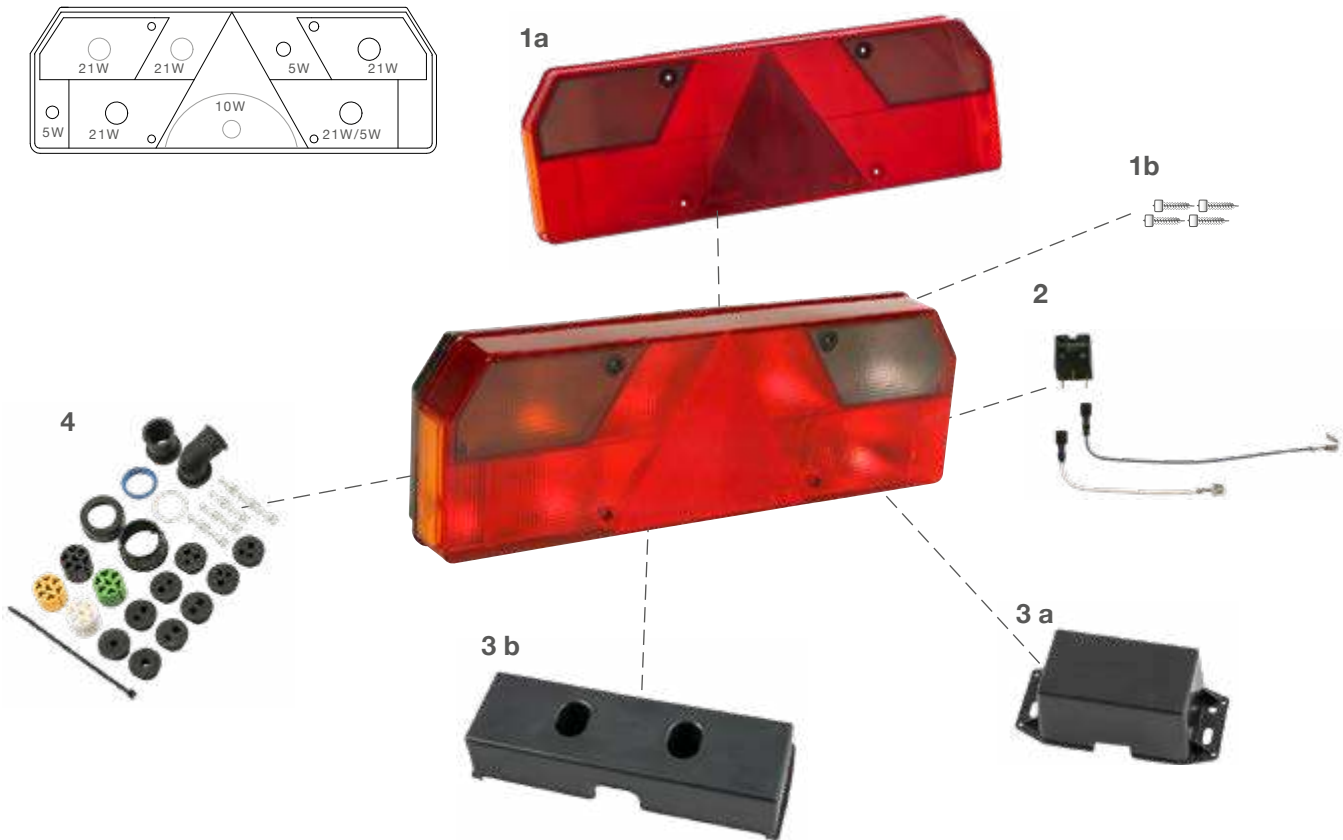

- 1 Lichtscheibe | lens**
- (a) Ohne Kennzeichenleuchte  
without number plate lamp  
..... 18-8550-002
  - (b) Mit Kennzeichenleuchte  
with number plate lamp  
..... 18-8554-042
  - (c) Schrauben für Lichtscheibe |  
Screws for lens  
..... 14-1430-354

**Glühlampe | bulb**

24V 21W/5W.....	16-6322-027	
24V 21W .....	16-6321-037	
24V 10W .....	16-6310-027	
24V 5W .....	16-6305-027	

- 2 Rückfahrwarner 24V | reverse alarm 24V**  
..... 12-3922-004

- 3 Schutzhaube | protection cap**
- (a) klein  
small .....
  - (b) groß  
big .....

- 4 ASS1 & ASS2 Verbinder |  
ASS1 & ASS2 connector**
- 7 pol. weiblich  
7 pin female .....



# ECOPOINT II

links  
left

ADR Zone 2 IP 56K

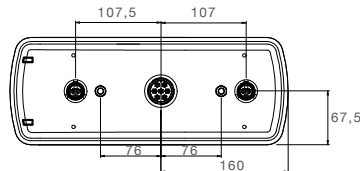
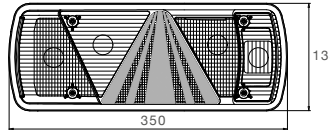

Blinklicht Direction indicator	Rücklicht Tail light	Bremslicht Stop light	Nebelschlusslicht Fog light
Rückfahrlicht Reverse light	Dreieckrückstrahler Triangle reflector	Seitenmarkierungslicht + Reflektor Sidemarker light + reflector	

BEST. NR PART NO						ZUSATZ ADD ON	ANSCHLUSS CONNECTOR
25-2800-001	1/6	●			24V		7 pol. ASS2.1 7 pin ASS2.1 ♂
25-2800-451	1/6	●			24V		7 pol. ASS2 7 pin ASS2 ♂
25-2800-501	1/6	●			24V		7 pol. ASS2 7 pin ASS2 ♂
25-2800-511	1/6	●			24V		7 pol. ASS2 7 pin ASS2 ♂  2 x 2 pol. ASS2 2 x 2 pin ASS2
25-2800-521	1/6	●			24V		7 pol. ASS2 7 pin ASS2 ♂  2 x 2 pol. ASS2 2 x 2 pin ASS2
25-2801-501	1/6	●			24V		7 pol. ASS2 7 pin ASS2 ♂
25-2860-001	1/6	●			24V		7 pol. ASS2.1 7 pin ASS2.1 ♂
25-2801-701	1/6	●			24V		7 pol. ASS2.1 7 pin ASS2.1 ♂
25-2860-701	1/8	●			24V		7 pol. ASS2.1 7 pin ASS2.1 ♂
25-2880-521	1/6	●			24V		7 pol. AMP 7 pin AMP ♂  2 x 2 pol. Superseal 2 x 2 pin Superseal
25-2860-041	1/8	●			24V		7 pol. ASS2.1 7 pin ASS2.1 ♂
25-2860-701	1/8	●			24V		7 pol. ASS2.1 7 pin ASS2.1 ♂





ECOPOINT II rechts  
right

ADR Zone 2 IP 56K

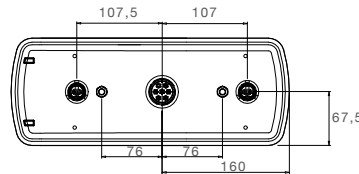
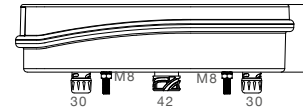
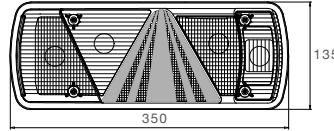

Blinklicht Direction indicator	Rücklicht Tail light	Bremslicht Stop light	Nebelschlusslicht Fog light
Rückfahrlicht Reverse light	Dreieckrückstrahler Triangle reflector	Seitenmarkierungslicht + Reflektor Sidemarker light + reflector	

BEST. NR PART NO						ZUSATZ ADD ON	ANSCHLUSS CONNECTOR
25-2900-001	1/6		●		24V		7 pol. ASS2.1 7 pin ASS2.1 ♂
25-2900-451	1/6		●		24V		7 pol. ASS2 7 pin ASS2 ♂
25-2900-501	1/6		●		24V		7 pol. ASS2 7 pin ASS2 ♂
25-2900-511	1/6		●		24V		7 pol. ASS2 7 pin ASS2 ♂  2 x 2 pol. ASS2 2 x 2 pin ASS2
25-2900-521	1/6		●		24V		7 pol. ASS2 7 pin ASS2 ♂  2 x 2 pol. ASS2 2 x 2 pin ASS2
25-2901-501	1/6		●		24V		7 pol. ASS2 7 pin ASS2 ♂
25-2901-551	1/-		●		24V		7 pol. ASS2.1 7 pin ASS2.1 ♂
25-2960-001	1/6		●		24V		7 pol. ASS2.1 7 pin ASS2.1 ♂
25-2901-701	1/6		●		24V		7 pol. ASS2.1 7 pin ASS2.1 ♂
25-2960-701	1/8		●		24V		7 pol. ASS2.1 7 pin ASS2.1 ♂
25-2980-521	1/6		●		24V		7 pol. AMP 7 pin AMP ♂  2 x 2 pol. Superseal 2 x 2 pin Superseal
25-2960-041	1/8		●		24V		7 pol. ASS2.1 7 pin ASS2.1 ♂
25-2960-701	1/8		●		24V		7 pol. ASS2.1 7 pin ASS2.1 ♂



# ECOPOINT II

links mit Umrissarm  
left with end outline marker

ADR Zone 2 IP 56K

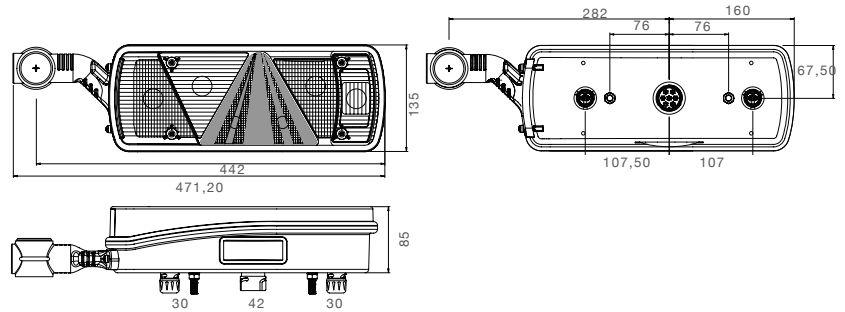

Blinklicht Direction indicator	Rücklicht Tail light	Bremslicht Stop light	Nebelschlusslicht Fog light
Rückfahrlicht Reverse light	Dreieckrückstrahler Triangle reflector	Seitenmarkierungslicht + Reflektor Sidemarker light + reflector	

BEST. NR	PART NO							ZUSATZ ADD ON	ANSCHLUSS CONNECTOR
25-2810-511	1/-	●			24V			7 pol. ASS2 7 pin ASS2	2 x 2 pol. ASS2 2 x 2 pin ASS2
25-2811-501	1/8	●			24V			7 pol. ASS2 7 pin ASS2	
25-2870-401	1/-	●			24V			7 pol. ASS2.1 7 pin ASS2.1	
25-2810-501	1/8	●			24V			7 pol. ASS2 7 pin ASS2	
25-2831-501	1/6	●			24V	lang long		7 pol. ASS2.1 7 pin ASS2.1	2 x 2 pol. ASS2 2 x 2 pin ASS2
25-2832-501	1/6	●			24V	lang long		7 pol. ASS2.1 7 pin ASS2.1	
25-2810-451	1/-	●			24V	lang long		7 pol. ASS2.1 7 pin ASS2.1	
25-2820-741	1/-	●			24V	lang long		7 pol. ASS2.1 7 pin ASS2.1	2 x 2 pol. ASS2 2 x 2 pin ASS2
25-2820-501	1/8	●			24V	LED		7 pol. ASS2 7 pin ASS2	
25-2820-541	1/8	●			24V	LED		7 pol. ASS2.1 7 pin ASS2.1	2 x 2 pol. ASS2 2 x 2 pin ASS2
25-2880-531	1/8	●			24V	LED		7 pol. AMP 7 pin AMP	2 x 2 pol. Superseal 2 x 2 pin Superseal



ECOPOINT II

rechts mit Umrissarm  
right with end outline marker

ADR Zone 2 IP 56K

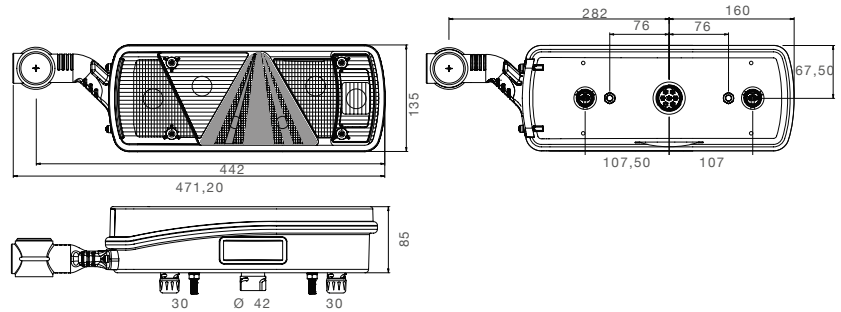

Blinklicht Direction indicator	Rücklicht Tail light	Bremslicht Stop light	Nebelschlusslicht Fog light
Rückfahrlicht Reverse light	Dreieckrückstrahler Triangle reflector	Seitenmarkierungslicht + Reflektor Sidemarker light + reflector	

BEST. NR	PART NO							ZUSATZ ADD ON	ANSCHLUSS CONNECTOR
25-2910-511	1/-		●		24V			7 pol. ASS2 7 pin ASS2	2 x 2 pol. ASS2 2 x 2 pin ASS2
25-2910-551	1/-		●		24V			7 pol. ASS2.1 7 pin ASS2.1	2 x 2 pol. ASS2 2 x 2 pin ASS2
25-2911-501	1/8		●		24V			7 pol. ASS2 7 pin ASS2	
25-2911-551	1/-		●		24V			7 pol. ASS2.1 7 pin ASS2.1	
25-2970-401	1/-		●		24V			7 pol. ASS2.1 7 pin ASS2.1	
25-2910-451	1/-		●		24V	lang long		7 pol. ASS2.1 7 pin ASS2.1	
25-2931-501	1/6		●		24V	lang long		7 pol. ASS2.1 7 pin ASS2.1	2 x 2 pol. ASS2 2 x 2 pin ASS2
25-2920-741	1/-		●		24V	lang long		7 pol. ASS2.1 7 pin ASS2.1	2 x 2 pol. ASS2 2 x 2 pin ASS2
25-2932-501	1/6		●		24V	lang long		7 pol. ASS2 7 pin ASS2	
25-2920-501	1/8		●		24V	LED		7 pol. ASS2 7 pin ASS2	
25-2920-541	1/8		●		24V	LED		7 pol. ASS2.1 7 pin ASS2.1	2 x 2 pol. ASS2 2 x 2 pin ASS2
25-2980-531	1/8		●		24V	LED		7 pol. AMP 7 pin AMP	2 x 2 pol. Superseal 2 x 2 pin Superseal
25-2910-501	1/8		●		24V			7 pol. ASS2 7 pin ASS2	



## ECOPOINT II

ZUBEHÖR / ACCESSORIES

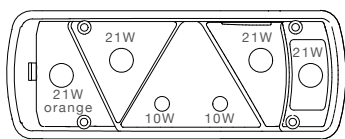

### 1 Lichtscheibe | lens

- (a) links
- left..... 18-8528-002
- rechts
- right ..... 18-8529-002
- (b) links ohne Dreieck
- left without triangle ..... 18-8526-002
- rechts ohne Dreieck
- right without triangle.... 18-8527-002

### 2 LED Einsätze | LED inserts

- (a) Blinklicht links <sup>24V</sup>
- direction indicator left <sup>24V</sup>
- ..... 12-1522-154
- Blinklicht rechts <sup>24V</sup>
- direction indicator right <sup>24V</sup>
- ..... 12-1526-154
- (b) Rückfahrlicht links <sup>24V</sup>
- reverse left <sup>24V</sup>
- ..... 12-1522-144
- Rückfahrlicht rechts <sup>24V</sup>
- reverse right <sup>24V</sup>
- ..... 12-1526-144

- (c) Nebelschlusslicht links / rechts <sup>24V</sup>
- fog left / right <sup>24V</sup>
- ..... 12-1526-164
- (d) Rücklicht und Bremslicht links <sup>24V</sup>
- tail light and stop light left <sup>24V</sup>
- ..... 12-1528-001
- Rücklicht und Bremslicht rechts <sup>24V</sup>
- tail light and stop light right <sup>24V</sup>
- ..... 12-1529-001

### 3 Relais

- (a) Rückfahrwarner <sup>24V</sup>
- reverse alarm <sup>24V</sup>
- ..... 12-3922-004
- (b) SMCG Steuerung für Seitenmarkierungsleuchten
- SMCG side marker control gear
- ..... 12-3970-584

### 4 Schutzhaube | protection cap

- ..... 15-5277-004



## ECOPOINT II

ZUBEHÖR / ACCESSORIES



### 5 Umrissarm Glühlampe | outline marker bulb

- (a) links kurz  
left short..... 31-3303-024
- rechts kurz  
right short ..... 31-3302-024
- (b) links lang  
links long ..... 31-3303-034
- rechts lang  
rechts long..... 31-3302-034

### 6 Lichtscheibe Umrissarm | lens outline marker ..... 18-8141-004

### 7 Umrissarm LED | outline marker LED

- a) links kurz  
left short..... 31-3303-044
- rechts kurz  
right short ..... 31-3302-044
- b) links lang  
links long ..... 31-3303-104
- rechts lang  
rechts long..... 31-3302-104

### 8 ASS1 & ASS2 Verbinder | ASS1 & ASS2 connector

- (a) 2 pol. weiblich  
2 pin female ..... 13-5626-401
- (b) 7 pol. weiblich  
7 pin female ..... 13-5626-631
- (c) Verschlusskappe  
closed connection ..... 15-5623-304

### 9 Superseal Verbinder | Superseal connector

- 2 pol. weiblich  
2 pin female ..... 15-7002-044

### 10 AMP Verbinder | AMP connector

- 7 pol. weiblich  
7 pin female ..... 15-7002-024

### Glühlampe | bulb

- 24V 21W orange ..... 16-6321-617
- 24V 21W ..... 16-6321-037
- 24V 10W ..... 16-6310-027
- 24V 4W ..... 16-6304-027



**ECOPOINT I** mit Dreieck  
with triangle

ADR  
Zone 2

IP 54

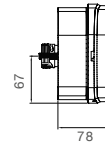
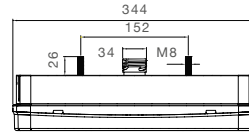
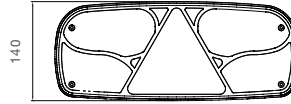

Blinklicht Direction indicator	Rücklicht Tail light	Bremslicht Stop light	Nebelschlusslicht Fog light
Rückfahrlicht Reverse light	Dreieckrückstrahler Triangle reflector		

BEST. NR	PART NO							ZUSATZ ADD ON	ANSCHLUSS CONNECTOR
25-2200-001	1/15	●			24V			7 pol. ASS2 7 pin ASS2	
25-2200-701	1/15	●			24V			7 pol. ASS2 7 pin ASS2	
25-2201-001	1/15	●			24V			7 pol. ASS2 7 pin ASS2	
25-2600-001	1/15		●		24V			7 pol. ASS2 7 pin ASS2	
25-2600-701	1/15		●		24V			7 pol. ASS2 7 pin ASS2	
25-2601-001	1/15		●		24V			7 pol. ASS2 7 pin ASS2	

ECOPOINT I mit Dreieck  
with triangle

ADR Zone 2

IP 54

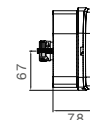
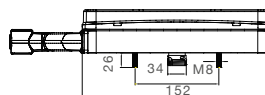
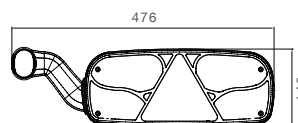

Blinklicht Direction indicator	Rücklicht Tail light	Bremslicht Stop light	Nebelschlusslicht Fog light
Rückfahrlicht Reverse light	Dreieckrückstrahler Triangle reflector		

BEST. NR							ZUSATZ	ANSCHLUSS
PART NO							ADD ON	CONNECTOR
25-2210-001	1/8	●			24V			7 pol. ASS2 7 pin ASS2 ♂
25-2210-701	1/8	●			24V			7 pol. ASS2 7 pin ASS2 ♂
25-2211-001	1/8	●			24V			7 pol. ASS2 7 pin ASS2 ♂
25-2610-001	1/8		●		24V			7 pol. ASS2 7 pin ASS2 ♂
25-2610-701	1/8		●		24V			7 pol. ASS2 7 pin ASS2 ♂
25-2611-001	1/8		●		24V			7 pol. ASS2 7 pin ASS2 ♂



ECOPOINT I mit Dreieck  
with triangle

ZUBEHÖR / ACCESSORIES

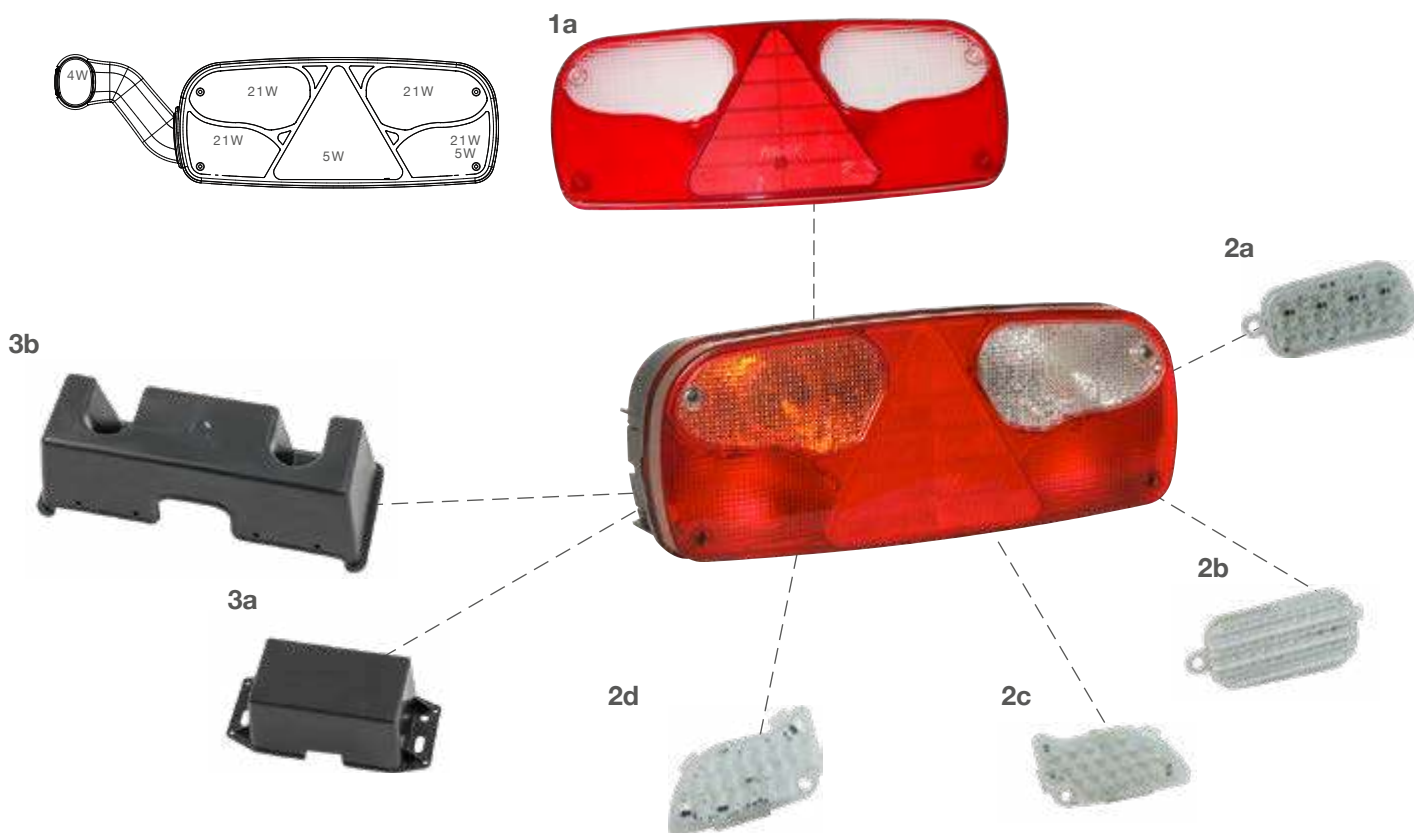

**1** **Lichtscheibe | lens**  
links / rechts  
left / right..... 18-8522-002

**2** **LED Einsätze | LED inserts**  
(a) Blinklicht links 24V  
direction indicator left 24V  
..... 12-1522-014   
Blinklicht rechts 24V  
direction indicator right 24V  
..... 12-1526-014   
(b) Rückfahrlicht links 24V  
reverse left 24V..... 12-1522-034   
Rückfahrlicht rechts 24V  
reverse right 24V..... 12-1526-034   
(c) Nebelschlusslicht links 24V  
fog left 24V..... 12-1522-024   
Nebelschlusslicht rechts 24V  
fog right 24V ..... 12-1526-024

(d) Rücklicht und Bremslicht links 24V  
tail light and stop light left 24V  
..... 12-1522-004   
Rücklicht und Bremslicht rechts 24V  
tail light and stop light right 24V  
..... 12-1526-004

**3** **Schutzhaube | protection cap**  
(a) klein  
small ..... 15-5270-004   
(b) groß  
big ..... 15-5276-004





ECOPOINT I mit Dreieck  
with triangle

ZUBEHÖR / ACCESSORIES



**4** Umrissarm Glühlampe | outline marker bulb

- links  
left..... 31-3608-014
- rechts  
right ..... 31-3608-004

**5** Lichtscheibe Umrissarm | lens outline marker

- ..... 18-8136-004

**6** Umrissarm LED | outline marker LED

- links  
left..... 31-3305-174
- rechts  
right ..... 31-3306-174

**7** ASS1 & ASS2 Verbinder |  
ASS1 & ASS2 connector

- 7 pol. weiblich  
7 pin female ..... 13-5626-631

**8** ASS3 Verbinder | ASS3 connector

- (a) 17 pol. weiblich  
17 pin female ..... 13-1722-001
- (b) 17 pol. männlich  
17 pin male ..... 13-1732-001

**Glühlampe | bulb**

- 24V 21W / 5W ..... 16-6322-037
- 24V 21W ..... 16-6321-037
- 24V 5W ..... 16-6305-027
- 24V 4W ..... 16-6304-027



**ECOPOINT** | ohne Dreieck  
without triangle

ADR  
Zone 2

IP 54

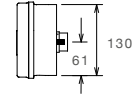
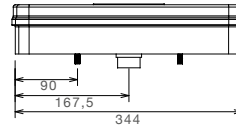
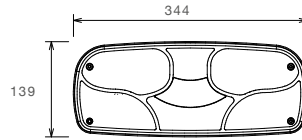

Blinklicht Direction indicator	Rücklicht Tail light	Bremslicht Stop light	Nebelschlusslicht Fog light
Rückfahrlicht Reverse light			

BEST. NR							ZUSATZ	ANSCHLUSS
PART NO							ADD ON	CONNECTOR
25-2000-501	1/15	●			24V			7 pol. ASS2 7 pin ASS2 
25-2400-501	1/15		●		24V			7 pol. ASS2 7 pin ASS2 



ECOPOINT | ohne Dreieck  
without triangle

ZUBEHÖR / ACCESSORIES



**1** Lichtscheibe | lens  
links / rechts  
left / right..... 18-8520-002

**2** Schutzhaube | protection cap  
(a) klein  
small ..... 15-5270-004   
(b) groß  
big ..... 15-5276-004

**3** ASS1 & ASS2 Verbinder |  
ASS1 & ASS2 connector  
7 pol. weiblich  
7 pin female ..... 13-5626-631

Glühlampe | bulb  
24V 21W / 5W ..... 16-6322-037   
24V 21W ..... 16-6321-037   
24V 5W ..... 16-6305-027   
24V 4W ..... 16-6304-027



# ECOFLEX

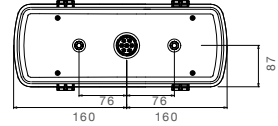
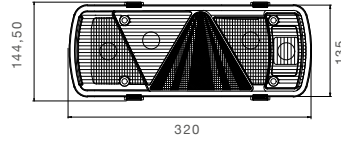

Blinklicht Direction indicator	Rücklicht Tail light	Bremslicht Stop light	Nebelschlusslicht Fog light
Rückfahrlicht Reverse light	Dreieckrückstrahler Triangle reflector		

BEST. NR	PART NO							ZUSATZ ADD ON	ANSCHLUSS CONNECTOR
25-2800-401	1/6	●			24V			7 pol. ASS2.1 7 pin ASS2.1	
25-2810-401	1/8	●			24V			7 pol. ASS2.1 7 pin ASS2.1	
25-2820-401	1/8	●			24V			7 pol. ASS2.1 7 pin ASS2.1	
25-2900-401	1/6		●		24V			7 pol. ASS2.1 7 pin ASS2.1	
25-2910-401	1/8		●		24V			7 pol. ASS2.1 7 pin ASS2.1	
25-2920-401	1/8		●		24V			7 pol. ASS2.1 7 pin ASS2.1	



# ECOFLEX

ZUBEHÖR / ACCESSORIES



- 1 Lichtscheibe | lens**  
links  
left..... 18-8528-402
- rechts  
right ..... 18-8529-402

- 2 Clip für Lichtscheibe | clip for lens**  
..... 15-5323-004

- 3 LED Einsätze | LED insert**  
Rücklicht / Bremslicht links  
tail light / stop light left  
..... 12-1528-001
- Rücklicht / Bremslicht rechts  
tail light / stop light right  
..... 12-1529-001

- 4 ASS1 & ASS2 Verbinder | ASS1 & ASS2 connector**  
7 pol. weiblich  
7 pin female ..... 13-5626-631

- 5 Umrissarm Glühlampe | outline marker bulb**  
(a) links lang  
left long..... 31-3303-034

- rechts lang  
right long..... 31-3302-034
- (b) links kurz  
left short..... 31-3303-024
- rechts kurz  
right short ..... 31-3302-024

- 6 Lichtscheibe Umrissarm | lens outline marker**  
..... 18-8141-004

- 7 Umrissarm LED | outline marker LED**  
(a) links lang  
left long..... 31-3303-104
- rechts lang  
right long..... 31-3302-104
- (b) links kurz  
left short..... 31-3303-044
- rechts kurz  
right short ..... 31-3302-044

- Glühlampe | bulb**  
24V 21W orange ..... 16-6321-617
- 24V 21W ..... 16-6321-037
- 24V 10W ..... 16-6310-027
- 24V 4W ..... 16-6304-027



EUROFAB

ADR Zone 2 IP 56K

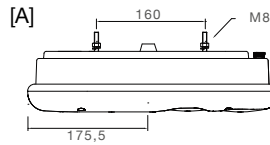
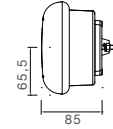
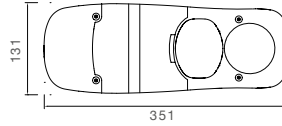

Blinklicht Direction indicator	Rücklicht Tail light	Bremslicht Stop light	Nebelschlusslicht Fog light
Rückfahrlicht Reverse light			

BEST. NR							ZUSATZ	ANSCHLUSS
PART NO							ADD ON	CONNECTOR
25-8100-001	1/-	●			12V 24V		[A]	Tülleneingang grommet
25-8100-161	1/-	●			12V		[A]	Tülleneingang grommet
25-8100-201	1/-	●			12V		[A]	7 pol. AMP 7 pin AMP
25-8100-501	1/-	●			24V		[A]	7 pol. AMP 7 pin AMP
25-8300-001	1/-		●		12V 24V		[A]	Tülleneingang grommet
25-8300-161	1/-		●		12V		[A]	Tülleneingang grommet
25-8300-201	1/-		●		12V		[A]	7 pol. AMP 7 pin AMP
25-8300-501	1/-		●		24V		[A]	7 pol. AMP 7 pin AMP

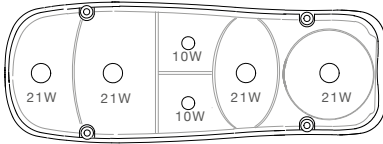

1a



1b



2



- 1** (a) **Lichtscheibe | lens**  
links / rechts  
left / right..... 18-8580-001
- (b) **Schrauben für Lichtscheibe |**  
**Screws for lens**  
..... 14-1430-454
- 2** **AMP Verbinder | AMP connector**  
7 pol. weiblich  
7 pin female ..... 15-7002-024
- Glühlampe | bulb**  
24V 21W ..... 16-6321-037   
24V 10W ..... 16-6310-027   
12V 21W ..... 16-6121-017   
12V 10W ..... 16-6110-017



# EARPOINT LED

ADR Zone 2 IP 6K9K

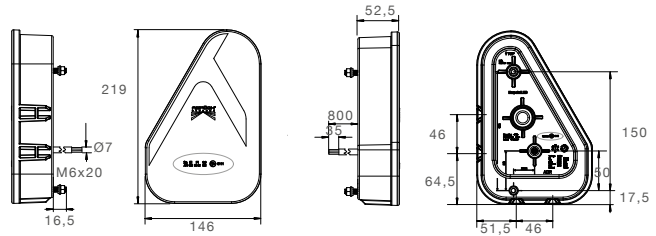

Blinklicht Direction indicator	Rücklicht Tail light	Bremslicht Stop light	Nebelschlusslicht Fog light
Rückfahrlicht Reverse light	Dreieckrückstrahler Triangle reflector		

BEST. NR		←	→	💡	⚡	🔦	ZUSATZ	ANSCHLUSS
PART NO				LED	V		ADD ON	CONNECTOR
35-0301-001	1/-	●		LED	12V 24V			offenes Ende open end 0,80 m
35-0301-011	1/-	●		LED	12V 24V			5 pol. Bajonett 5 pin Bayonet  0,80 m
35-0301-021	1/-	●		LED	12V 24V			8 pol. Bajonett 8 pin Bayonet  0,80 m
35-0301-041	1/-	●		LED	12V 24V			7 pol. ASS2 7 pin ASS2  0,80 m
35-0302-001	1/-		●	LED	12V 24V			offenes Ende open end 0,80 m
35-0302-011	1/-		●	LED	12V 24V			5 pol. Bajonett 5 pin Bayonet  0,80 m
35-0302-021	1/-		●	LED	12V 24V			8 pol. Bajonett 8 pin Bayonet  0,80 m
35-0302-041	1/-		●	LED	12V 24V			7 pol. ASS2 7 pin ASS2  0,80 m





# EARPOINT LED

ZUBEHÖR / ACCESSORIES

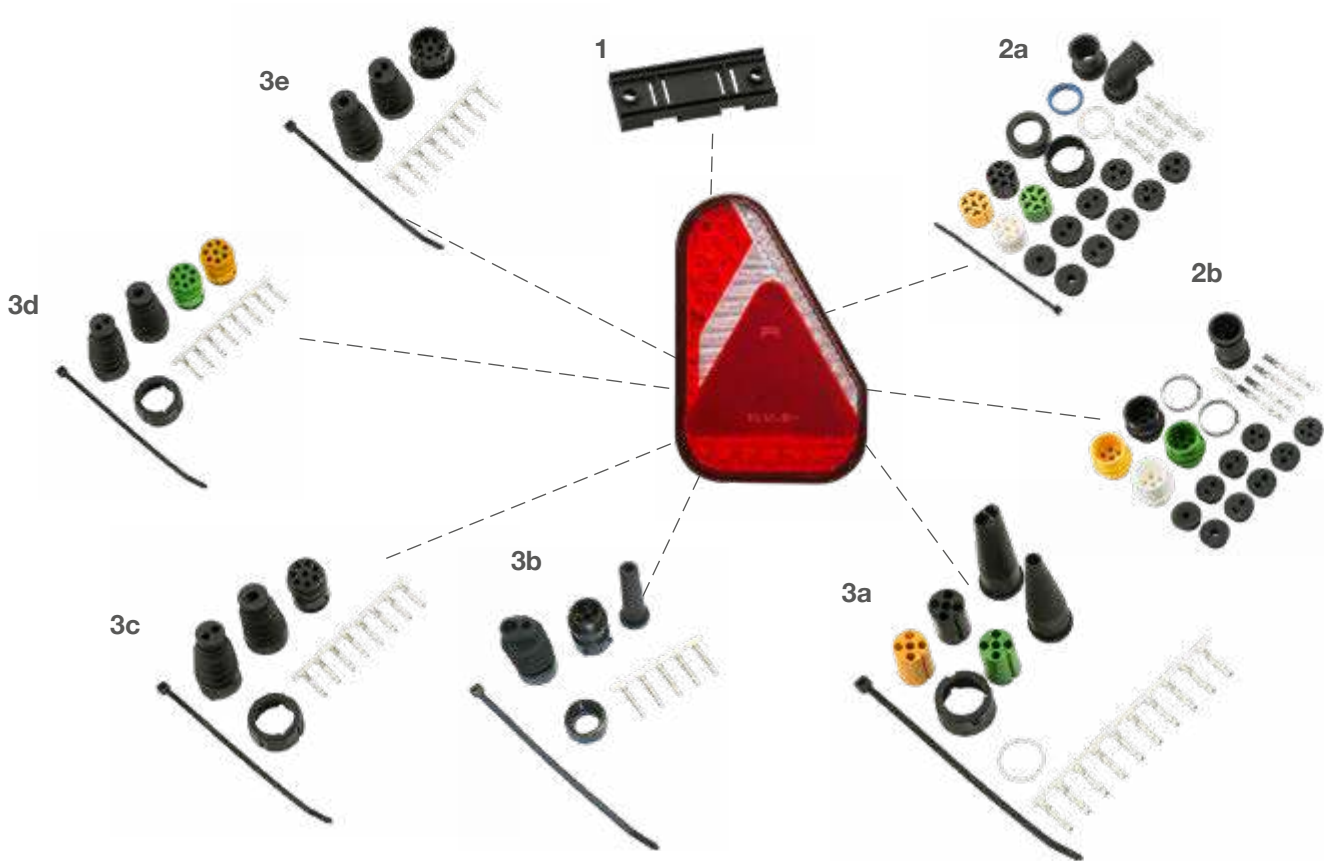

**1 Halter | bracket**  
..... 15-5303-004

**2 ASS1 & ASS2 Verbinder | ASS1 & ASS2 connector**  
(a) 7 pol. weiblich  
7 pin female ..... 13-5626-631   
(b) 7 pol. männlich  
7 pin male ..... 13-5625-981

**3 Bajonett Verbinder | bayonet connector**  
(a) 5 pol. weiblich  
5 pin female ..... 13-0521-104   
(b) 5 pol. männlich  
5 pin male ..... 13-0536-044   
(c) 8 pol. weiblich  
8 pin female ..... 13-0828-034   
(d) 8 pol. weiblich  
8 pin female ..... 15-0821-524   
(d) 8 pol. männlich  
8 pin male ..... 13-0838-054



# EARPOINT I

ADR Zone 2

IP 54

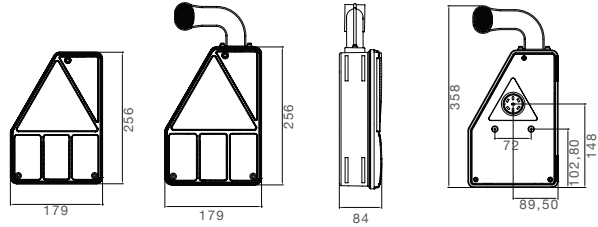

Blinklicht Direction indicator	Rücklicht Tail light	Bremslicht Stop light	
	Dreieckrückstrahler Triangle reflector		

BEST. NR	PART NO							ZUSATZ ADD ON	ANSCHLUSS CONNECTOR
24-4101-001	1/-	●			24V			7 pol. ASS2 7 pin ASS2	
24-4105-001	1/-	●			24V			7 pol. ASS2 7 pin ASS2	
24-4111-001	1/-	●			24V			PG Verschraubung cable glands	
24-4151-001	-/-	●			24V			7 pol. ASS2 7 pin ASS2	
24-4301-001	1/-		●		24V			7 pol. ASS2 7 pin ASS2	
24-4305-001	-/-		●		24V			7 pol. ASS2 7 pin ASS2	
24-4311-001	-/-		●		24V			PG Verschraubung cable glands	
24-4351-001	1/-		●		24V			7 pol. ASS2 7 pin ASS2	



# EARPOINT I

ZUBEHÖR / ACCESSORIES

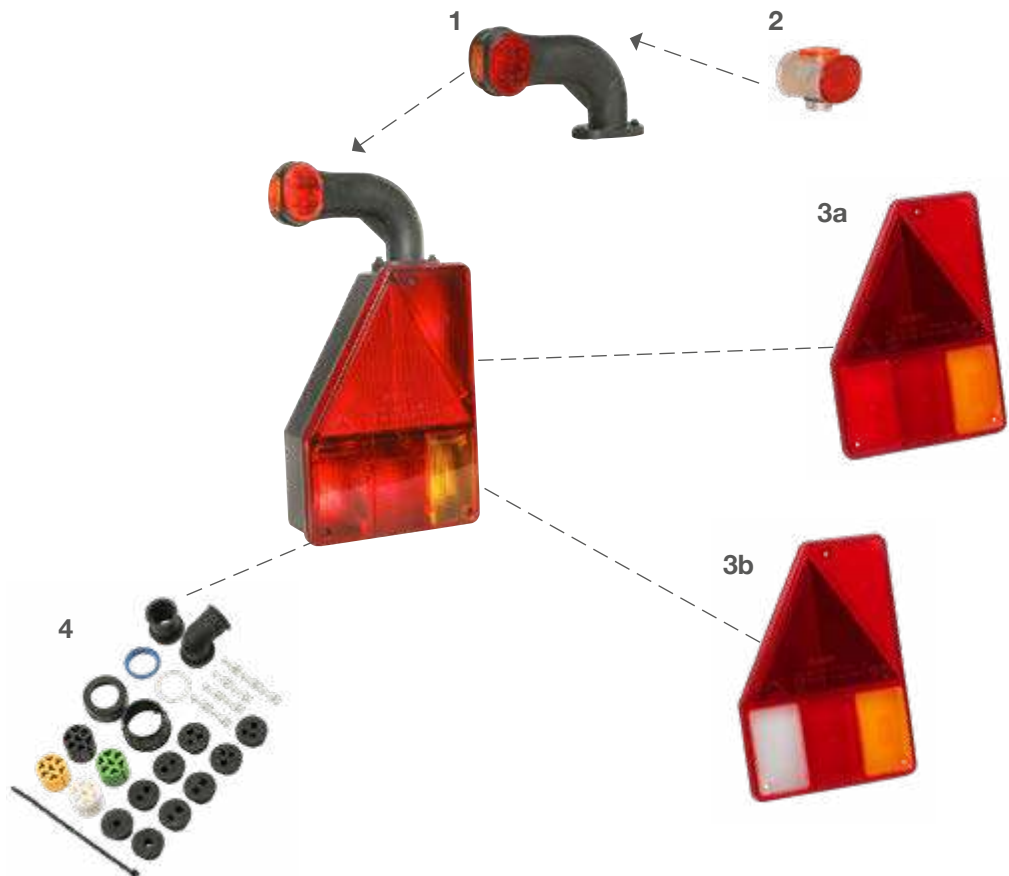
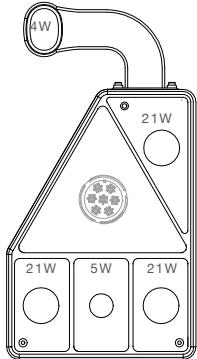

**1** Umrissarm Glühlampe | outline marker bulb  
..... 21-3800-004

**2** Lichtscheibe Umrissarm | lens outline marker  
..... 18-8136-004

**3** Lichtscheibe | lens  
(a) links mit left with ..... 18-8440-001   
rechts mit right with ..... 18-8442-001   
(b) links mit für left with for ..... 18-8440-051   
rechts mit right with ..... 18-8442-101

**4** ASS1 & ASS2 Verbinder |  
ASS1 & ASS2 connector  
7 pol. weiblich  
7 pin female ..... 13-5626-631

**Glühlampe | bulb**  
24V 21W ..... 16-6321-037   
24V 21/5W ..... 16-6322-027   
24V 10W ..... 16-6310-027   
24V 5W Soffitte ..... 16-6705-017   
24V 4W ..... 16-6304-027



# MULTILED III TRAILER

ISO  
13207-1

ADR  
Zone 2

IP 56

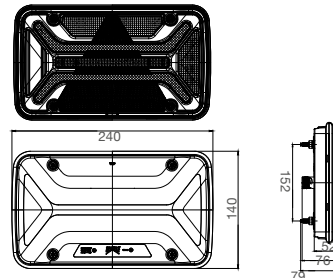

Blinklicht Direction indicator	Rücklicht Tail light	Bremslicht Stop light	Nebelschlusslicht Fog light
Rückfahrlicht Reverse light	Dreieckrückstrahler Triangle reflector		

BEST. NR	PART NO							ZUSATZ ADD ON	ANSCHLUSS CONNECTOR	
24-8931-001	1/-	●		LED	12V 24V			7 pol. ASS2 7 pin ASS2	  	
24-8930-001	1/-		●	LED	12V 24V			7 pol. ASS2 7 pin ASS2	  	
24-8931-011	1/-	●		LED	12V 24V			7 pol. ASS2 7 pin ASS2	   2 pol. ASS2 2 pin ASS2	
24-8930-011	1/-		●	LED	12V 24V			7 pol. ASS2 7 pin ASS2	   2 pol. ASS2 2 pin ASS2	
24-8931-021	1/-	●		LED	12V 24V			7 pol. AMP 7 pin AMP	   2 pol. ASS2 2 pin ASS2	
24-8930-021	1/-		●	LED	12V 24V			7 pol. AMP 7 pin AMP	   2 pol. ASS2 2 pin ASS2	
24-8931-041	1/-	●		LED	12V 24V			7 pol. AMP 7 pin AMP	  	
24-8930-041	1/-		●	LED	12V 24V			7 pol. AMP 7 pin AMP	  	
24-8931-031	1/-	●		LED	12V 24V			7 pol. AMP 7 pin AMP	   2 pol. ASS2 2 pin ASS2	
24-8930-031	1/-		●	LED	12V 24V			7 pol. AMP 7 pin AMP	   2 pol. ASS2 2 pin ASS2	
24-8931-051	1/-	●		LED	12V 24V			7 pol. AMP 7 pin AMP	   2 pol. Superseal 2 pin Superseal	
24-8930-051	1/-		●	LED	12V 24V			7 pol. AMP 7 pin AMP	   2 pol. Superseal 2 pin Superseal	
24-8931-061	1/-	●		LED	12V 24V			7 pol. AMP 7 pin AMP	   2 pol. Superseal 2 pin Superseal	
24-8930-061	1/-		●	LED	12V 24V			7 pol. AMP 7 pin AMP	   2 pol. Superseal 2 pin Superseal	
24-8931-071	1/-	●		LED	12V 24V			7 pol. AMP 7 pin AMP	  	
24-8930-071	1/-		●	LED	12V 24V			7 pol. AMP 7 pin AMP	  	
24-8931-081	1/-	●		LED	12V 24V			7 pol. AMP 7 pin AMP	   2 pol. ASS2 2 pin ASS2	
24-8930-081	1/-		●	LED	12V 24V			7 pol. AMP 7 pin AMP	   2 pol. ASS2 2 pin ASS2	



MULTILED III TRUCK

ISO  
13207-1

ADR  
Zone 2

IP 56

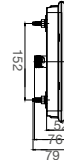
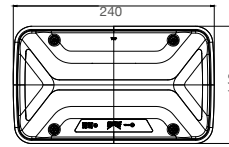
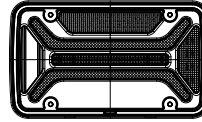

Blinklicht Direction indicator	Rücklicht Tail light	Bremslicht Stop light	Nebelschlusslicht Fog light
Rückfahrlicht Reverse light			

BEST. NR		←	→	💡	⚡	🔌	ZUSATZ	ANSCHLUSS
PART NO				LED	12V 24V		ADD ON	CONNECTOR
24-8931-071	1/-	●		LED	12V 24V			7 pol. AMP 7 pin AMP ♂ 
24-8930-071	1/-		●	LED	12V 24V			7 pol. AMP 7 pin AMP ♂ 
24-8931-081	1/-	●		LED	12V 24V			7 pol. AMP 7 pin AMP ♂ 2 pol. ASS2 2 pin ASS2
24-8930-081	1/-		●	LED	12V 24V			7 pol. AMP 7 pin AMP ♂ 2 pol. ASS2 2 pin ASS2



MULTILED III TRAILER

ZUBEHÖR / ACCESSORIES



- 1** Lichtscheibe | lens  
mit Dreieck  
with triangle ..... 24-8937-001   
ohne Dreieck  
without triangle ..... 24-8937-011 

- 2** ASS1 & ASS2 Verbinder |  
ASS1 & ASS2 connector  
(a) 2 pol. weiblich  
2 pin female ..... 13-5626-401   
(b) 7 pol. weiblich  
7 pin female ..... 13-5626-631   
(c) Verschlusskappe  
closed connection ..... 15-5623-304 

- 3** AMP Verbinder |  
AMP connector  
7 pol. weiblich  
7 pin female ..... 15-7002-024 

- 4** Superseal Verbinder |  
Superseal connector  
2 pol. weiblich  
2 pin female ..... 15-7002-044 

# THE ART OF LIGHTS



IT GLOWS TEST IT ITS SAFE TURN IT ITS SAFE ECOLED II SWITCH IT TEST IT ITS SAFE MULTILED III

## ECOLED II

Glowing Body Technologie | *Glowing body technology*  
Beidseitig verwendbar | *Can be used on both sides*



## MULTILED III

Platzsparend | *Space saving version*  
Wechselbare Lichtscheibe | *Reversible Lens*



THE ART OF  
OF LIGHTS  
LIGHTS  
THE ART OF



**MULTILED II** hoch / high

ADR Zone 2 IP 6K9K

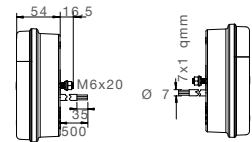
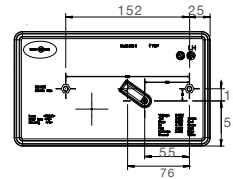
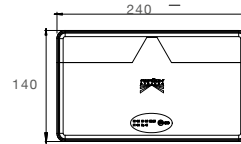

Blinklicht Direction indicator	Rücklicht Tail light	Bremslicht Stop light	Nebelschlusslicht Fog light
Rückfahrlicht Reverse light	Dreieckrückstrahler Triangle reflector		

BEST. NR		←	→	💡	⚡	🔦	ZUSATZ	ANSCHLUSS
PART NO				LED	12V 24V		ADD ON	CONNECTOR
35-0203-001	1/-	●		LED	12V 24V			offenes Ende open end 0,50 m
35-0203-011	1/-	●		LED	12V 24V			5 pol. Bajonett 5 pin Bayonet  0,50 m
35-0203-021	1/-	●		LED	12V 24V			8 pol. Bajonett 8 pin Bayonet  0,50 m
35-0203-031	1/-	●		LED	12V 24V			7 pol. ASS2 7 pin ASS2  0,50 m
35-0203-041	1/-	●		LED	12V 24V			7 pol. AMP 7 pin AMP  0,50 m
35-0203-051	1/-	●		LED	12V 24V			offenes Ende open end 0,50 m
35-0203-061	1/-	●		LED	12V 24V			5 pol. Bajonett 5 pin Bayonet  0,50 m
35-0203-071	1/-	●		LED	12V 24V			8 pol. Bajonett 8 pin Bayonet  0,50 m
35-0203-081	1/-	●		LED	12V 24V			7 pol. ASS2 7 pin ASS2  0,50 m
35-0203-091	1/-	●		LED	12V 24V			7 pol. AMP 7 pin AMP  0,50 m
35-0203-101	1/-	●		LED	12V 24V			offenes Ende open end 0,50 m
35-0203-111	1/-	●		LED	12V 24V			5 pol. Bajonett 5 pin Bayonet  0,50 m
35-0203-121	1/-	●		LED	12V 24V			8 pol. Bajonett 8 pin Bayonet  0,50 m
35-0203-131	1/-	●		LED	12V 24V			7 pol. ASS2 7 pin ASS2  0,50 m
35-0203-141	1/-	●		LED	12V 24V			7 pol. AMP 7 pin AMP  0,50 m





# MULTILED II hoch / high

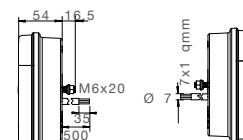
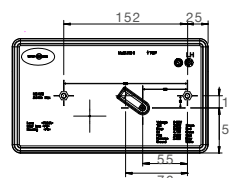
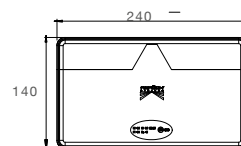

Blinklicht Direction indicator	Rücklicht Tail light	Bremslicht Stop light	Nebelschlusslicht Fog light
Rückfahrlicht Reverse light	Dreieckrückstrahler Triangle reflector		

BEST. NR							ZUSATZ	ANSCHLUSS	
PART NO							ADD ON	CONNECTOR	
35-0204-001	1/-		●	LED	12V 24V			offenes Ende open end	0,50 m
35-0204-011	1/-		●	LED	12V 24V			5 pol. Bajonett 5 pin Bayonet	0,50 m
35-0204-021	1/-		●	LED	12V 24V			8 pol. Bajonett 8 pin Bayonet	0,50 m
35-0204-051	1/-		●	LED	12V 24V			offenes Ende open end	0,50 m
35-0204-031	1/-		●	LED	12V 24V			7 pol. ASS2 7 pin ASS2	0,50 m
35-0204-041	1/-		●	LED	12V 24V			7 pol. AMP 7 pin AMP	0,50 m
35-0204-061	1/-		●	LED	12V 24V			5 pol. Bajonett 5 pin Bayonet	0,50 m
35-0204-071	1/-		●	LED	12V 24V			8 pol. Bajonett 8 pin Bayonet	0,50 m
35-0204-081	1/-		●	LED	12V 24V			7 pol. ASS2 7 pin ASS2	0,50 m
35-0204-091	1/-		●	LED	12V 24V			7 pol. AMP 7 pin AMP	0,50 m
35-0204-101	1/-		●	LED	12V 24V			offenes Ende open end	0,50 m
35-0204-111	1/-		●	LED	12V 24V			5 pol. Bajonett 5 pin Bayonet	0,50 m
35-0204-121	1/-		●	LED	12V 24V			8 pol. Bajonett 8 pin Bayonet	0,50 m
35-0204-131	1/-		●	LED	12V 24V			7 pol. ASS2 7 pin ASS2	0,50 m
35-0204-141	1/-		●	LED	12V 24V			7 pol. AMP 7 pin AMP	0,50 m



**MULTILED II** flach / flat

ADR Zone 2 IP 6K9K

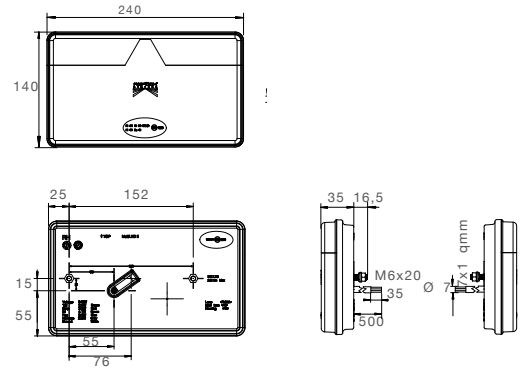

Blinklicht Direction indicator	Rücklicht Tail light	Bremslicht Stop light	Nebelschlusslicht Fog light
Rückfahrlicht Reverse light	Dreieckrückstrahler Triangle reflector		

BEST. NR	PART NO	Box	←	→	LED	12V 24V	Light	ZUSATZ ADD ON	ANSCHLUSS CONNECTOR	Length	Terminal
35-0201-001	1/-	●			LED	12V 24V			offenes Ende open end	0,50 m	↔
35-0201-011	1/-	●			LED	12V 24V			5 pol. Bajonett 5 pin Bayonet	0,50 m	♂
35-0201-021	1/-	●			LED	12V 24V			8 pol. Bajonett 8 pin Bayonet	0,50 m	♂
35-0201-031	1/-	●			LED	12V 24V			7 pol. ASS2 7 pin ASS2	0,50 m	♂
35-0201-041	1/-	●			LED	12V 24V			7 pol. AMP 7 pin AMP	0,50 m	♂
35-0202-001	1/-		●		LED	12V 24V			offenes Ende open end	0,50 m	↔
35-0202-011	1/-		●		LED	12V 24V			5 pol. Bajonett 5 pin Bayonet	0,50 m	♂
35-0202-021	1/-		●		LED	12V 24V			8 pol. Bajonett 8 pin Bayonet	0,50 m	♂
35-0202-031	1/-		●		LED	12V 24V			7 pol. ASS2 7 pin ASS2	0,50 m	♂
35-0202-041	1/-		●		LED	12V 24V			7 pol. AMP 7 pin AMP	0,50 m	♂



# MULTILED II

ZUBEHÖR / ACCESSORIES

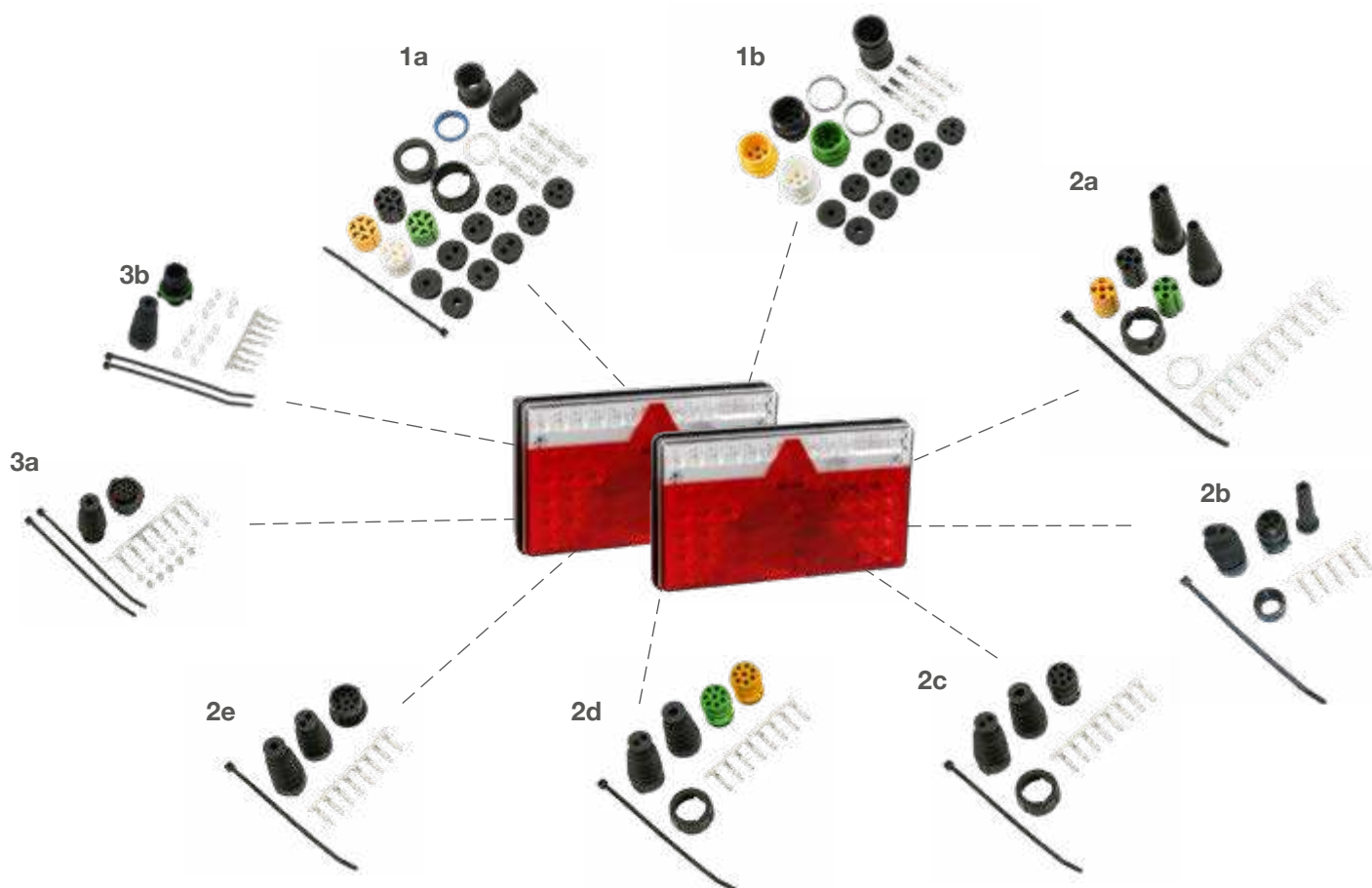

## 1 ASS1 & ASS2 Verbinder | ASS1 & ASS2 connector

- (a) 7 pol. weiblich  
7 pin female ..... 13-5626-631
- (b) 7 pol. männlich  
7 pin male ..... 13-5625-981

## 2 Bajonett Verbinder | bayonet connector

- (a) 5 pol. weiblich  
5 pin female ..... 13-0521-104
- (b) 5 pol. männlich  
5 pol. male ..... 13-0536-044
- (c) 8 pol. weiblich  
8 pin female ..... 13-0828-034
- (d) 8 pol. weiblich  
8 pin female ..... 15-0821-524
- (e) 8 pol. männlich  
8 pol. male ..... 13-0838-054

## 3 AMP Verbinder | AMP connector

- (a) 7 pol. weiblich  
7 pin female ..... 15-7002-024
- (b) 7 pol. männlich  
7 pin male ..... 15-7002-034



MULTILED

ADR Zone 2 IP69K

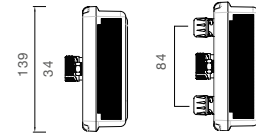
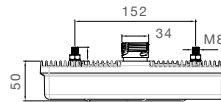
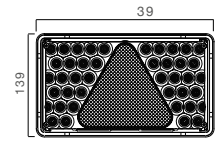

Blinklicht Direction indicator	Rücklicht Tail light	Bremslicht Stop light	Nebelschlusslicht Fog light
Rückfahrlicht Reverse light	Dreieckrückstrahler Triangle reflector	Seitenmarkierungslicht + Reflektor Sidemarker light + reflector	

BEST. NR	PART NO						ZUSATZ ADD ON	ANSCHLUSS CONNECTOR
24-7400-701	1/-	●			24V		7 pol. ASS2.1 7 pin ASS2.1	♂ 
24-7430-701	1/-	●			24V		7 pol. AMP 7 pin AMP	♂ 1 x 2 pol. ASS2 1 x 2 pin ASS2
24-7470-701	1/-	●			24V		7 pol. AMP 7 pin AMP	♂ 1 x 2 pol. ASS2 1 x 2 pin ASS2
24-7630-701	1/-	●			24V	Plastikgehäuse plastic housing	7 pol. AMP 7 pin AMP	♂ 1 x 2 pol. ASS2 1 x 2 pin ASS2
24-7500-701	1/-		●		24V		7 pol. ASS2.1 7 pin ASS2.1	♂ 
24-7530-701	1/-		●		24V		7 pol. AMP 7 pin AMP	♂ 1 x 2 pol. ASS2 1 x 2 pin ASS2
24-7570-701	1/-		●		24V		7 pol. AMP 7 pin AMP	♂ 1 x 2 pol. ASS2 1 x 2 pin ASS2
24-7730-701	1/-		●		24V	Plastikgehäuse plastic housing	7 pol. AMP 7 pin AMP	♂ 1 x 2 pol. ASS2 1 x 2 pin ASS2



# MULTILED

ZUBEHÖR / ACCESSORIES

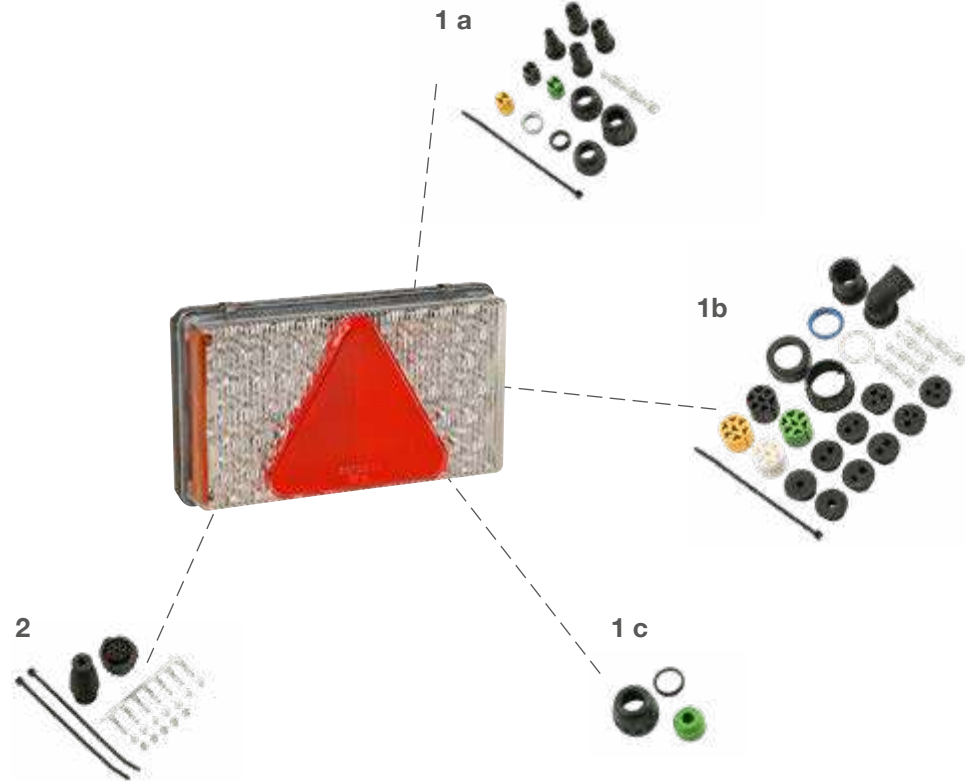

## 1 ASS1 & ASS2 Verbinder | ASS1 & ASS2 connector

- (a) 2 pol. weiblich  
2 pin female ..... 13-5626-401
- (b) 7 pol. weiblich  
7 pin female ..... 13-5626-631
- (c) Verschlusskappe  
closed connection ..... 15-5623-304

## 2 AMP Verbinder | AMP connector

- 7 pol. weiblich
- 7 pin female ..... 15-7002-024

## LED Vorschaltgerät | LED control gear

- LCG ..... siehe Seite 188
- ..... see at page 188



# MULTIPOINT V

ADR  
Zone 2

IP 54

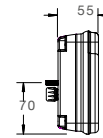
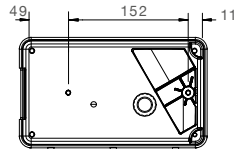
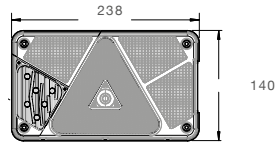

Blinklicht Direction indicator	Rücklicht Tail light	Bremslicht Stop light	Nebelschlusslicht Fog light
Rückfahrlicht Reverse light			

BEST. NR	PART NO							ZUSATZ ADD ON	ANSCHLUSS CONNECTOR
24-8502-001	1/-	●			24V			PG Verschraubung cable glands	
24-8504-701	1/-	●			24V			PG Verschraubung cable glands	
34-8503-001	1/-	●			24V			7 pol. AMP 7 pin AMP	0,15 m
34-8505-001	1/-	●			24V			7 pol. ASS2 7 pin ASS2	2,50 m
34-8605-001	1/-	●			24V			7 pol. ASS2 7 pin ASS2	0,90 m
24-8702-001	1/-		●		24V			PG Verschraubung cable glands	
24-8714-701	1/-		●		24V			PG Verschraubung cable glands	
34-8702-001	1/-		●		24V			7 pol. AMP 7 pin AMP	0,15 m
34-8706-001	1/-		●		24V			7 pol. ASS2 7 pin ASS2	2,50 m
34-8806-001	1/-		●		24V			7 pol. ASS2 7 pin ASS2	0,90 m



# MULTIPOINT V

ZUBEHÖR / ACCESSORIES

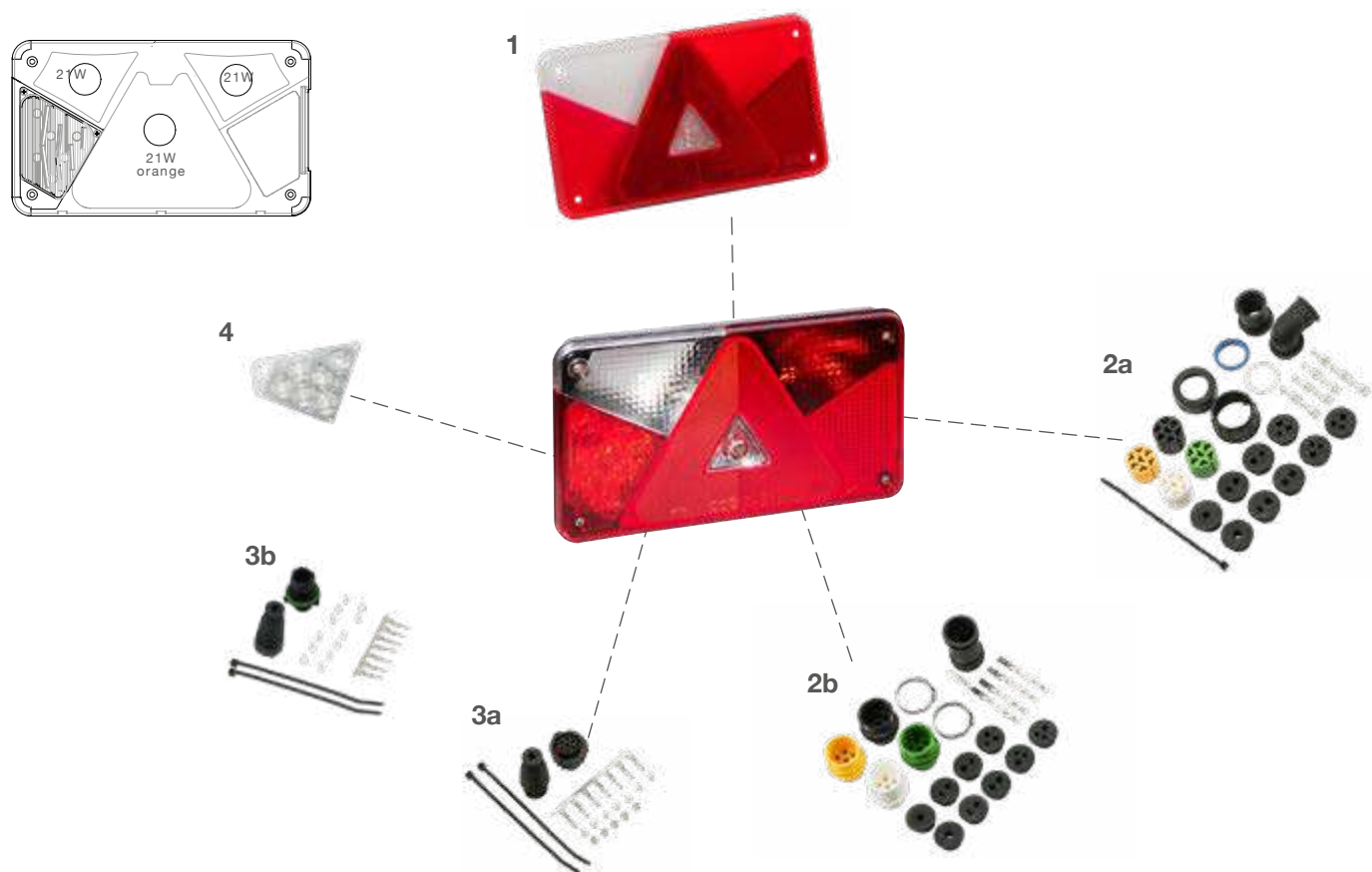

## 1 Lichtscheibe | lens

- links  
left..... 18-8485-004
- rechts  
right ..... 18-8487-004

## 2 ASS1 & ASS2 Verbinder | ASS1 & ASS2 connector

- (a) 7 pol. weiblich  
7 pin female ..... 13-5626-631
- (b) 7 pol. männlich  
7 pin male ..... 13-5625-981

## 3 AMP Verbinder | AMP connector

- (a) 7 pol. weiblich  
7 pin female ..... 15-7002-024
- (b) 7 pol. männlich  
7 pin male ..... 15-7002-034

## 4 LED Einsätze | LED insert

- Rücklicht / Bremslicht links  
tail light / stop light left  
..... 12-1530-004
- Rücklicht / Bremslicht rechts  
tail light / stop light right  
..... 12-1531-004

## Glühlampe | bulb

- 24V 21W orange ..... 16-6321-617
- 24V 21W ..... 16-6321-037
- 24V 10W ..... 16-6310-027



# MULTIPOINT LED

ADR  
Zone 2

IP 54

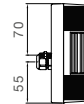
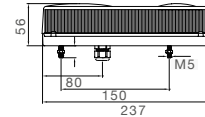
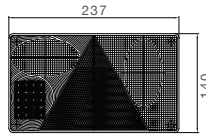

Blinklicht Direction indicator	Rücklicht Tail light	Bremslicht Stop light	
		Seitenmarkierungslicht + Reflektor Sidemarker light + reflector	

BEST. NR		←	→	LED	24V	⚡	ZUSATZ	ANSCHLUSS
PART NO							ADD ON	CONNECTOR
24-5700-721	1/-	●			24V			PG 11 Verschraubung cable glands 11
24-5705-701	1/-	●			24V			PG 11 Verschraubung cable glands 11
34-5703-001	1/-	●			24V			8 pol. Bajonett 8 pin Bayonet   1,80 m
34-5703-011	1/-	●			24V			8 pol. Bajonett 8 pin Bayonet   1,80 m
34-5705-001	1/-	●			24V			7 pol. ASS2 7 pin ASS2   2,50 m
24-5800-731	1/-		●		24V			PG 11 Verschraubung cable glands 11
24-5805-701	1/-		●		24V			PG 11 Verschraubung cable glands 11
24-5805-711	1/-		●		24V			Tülleneingang grommet
24-5813-701	1/-		●		24V			Tülleneingang grommet
34-5802-001	1/-		●		24V			8 pol. Bajonett 8 pin Bayonet   1,80 m
34-5802-011	1/-		●		24V			8 pol. Bajonett 8 pin Bayonet   2,50 m
34-5806-001	1/-		●		24V			7 pol. ASS2 7 pin ASS2   2,50 m





# MULTIPOINT LED

ZUBEHÖR / ACCESSORIES

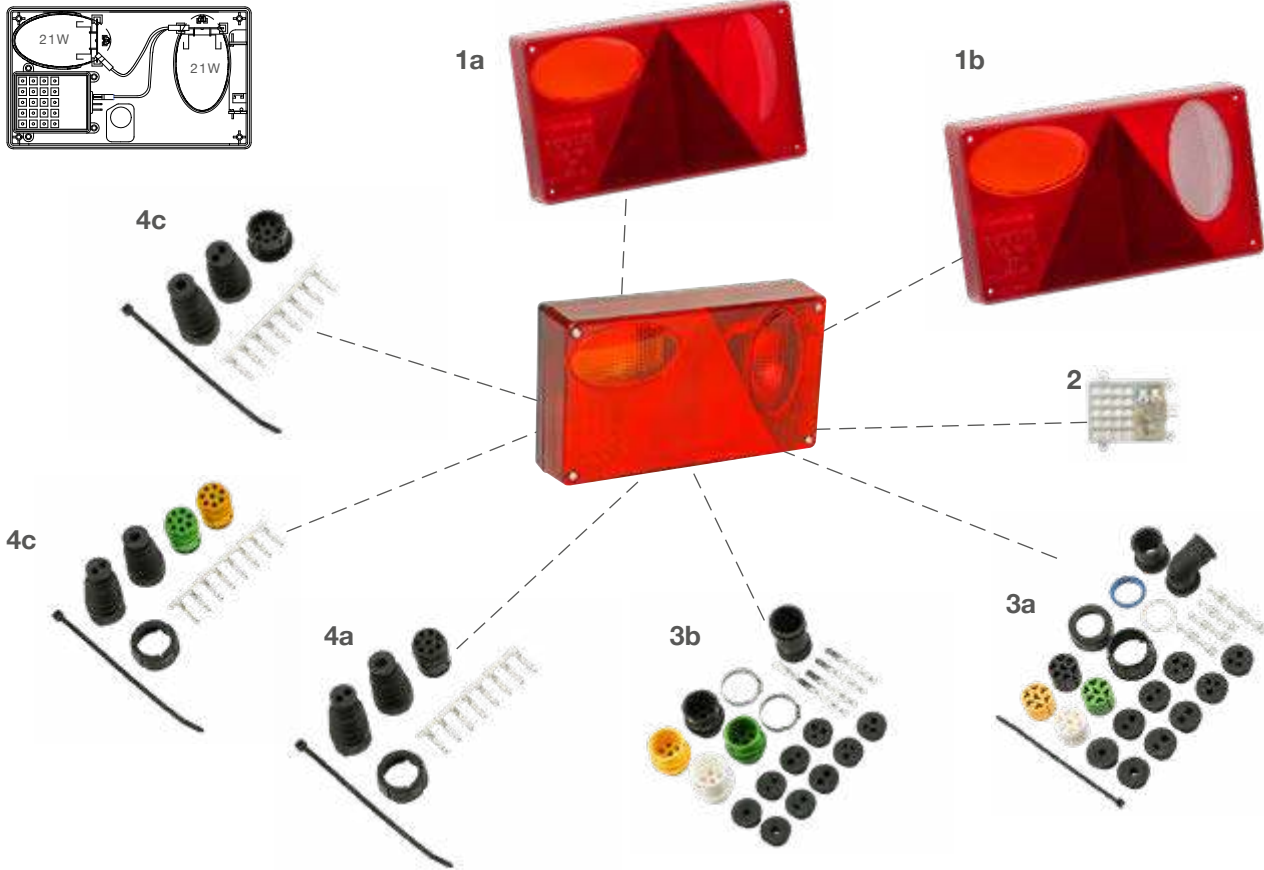

## 1 Lichtscheibe | lens

- (a) links mit left with ..... 18-8457-131
- rechts mit right with ..... 18-8458-051
- (b) links mit für left with for ..... 18-8457-051
- rechts mit right with ..... 18-8458-131

## 2 LED Einsätze | LED inserts

- ..... 12-1527-004

## 3 ASS1 & ASS2 Verbinder | ASS1 & ASS2 connector

- (a) 7 pol. weiblich  
7 pin female ..... 13-5626-631
- (b) 7 pol. männlich  
7 pin male ..... 13-5625-981

## 4 Bajonett Verbinder | bayonet connector

- (a) 8 pol. weiblich  
8 pin female ..... 13-0828-034
- (b) 8 pol. weiblich  
8 pin female ..... 15-0821-524
- (c) 8 pol. männlich  
8 pin male ..... 13-0838-054

## Glühlampe | bulb

- 24V 21W ..... 16-6321-037



# MULTIPOINT I

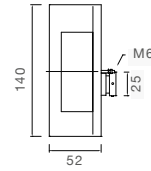
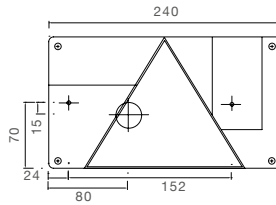

Blinklicht Direction indicator	Rücklicht Tail light	Bremslicht Stop light	

BEST. NR							ZUSATZ	ANSCHLUSS
PART NO							ADD ON	CONNECTOR
24-5013-001	1/-	●			24V			PG 11 Verschraubung cable glands 11
24-5213-001	1/-		●		24V			PG 11 Verschraubung cable glands 11







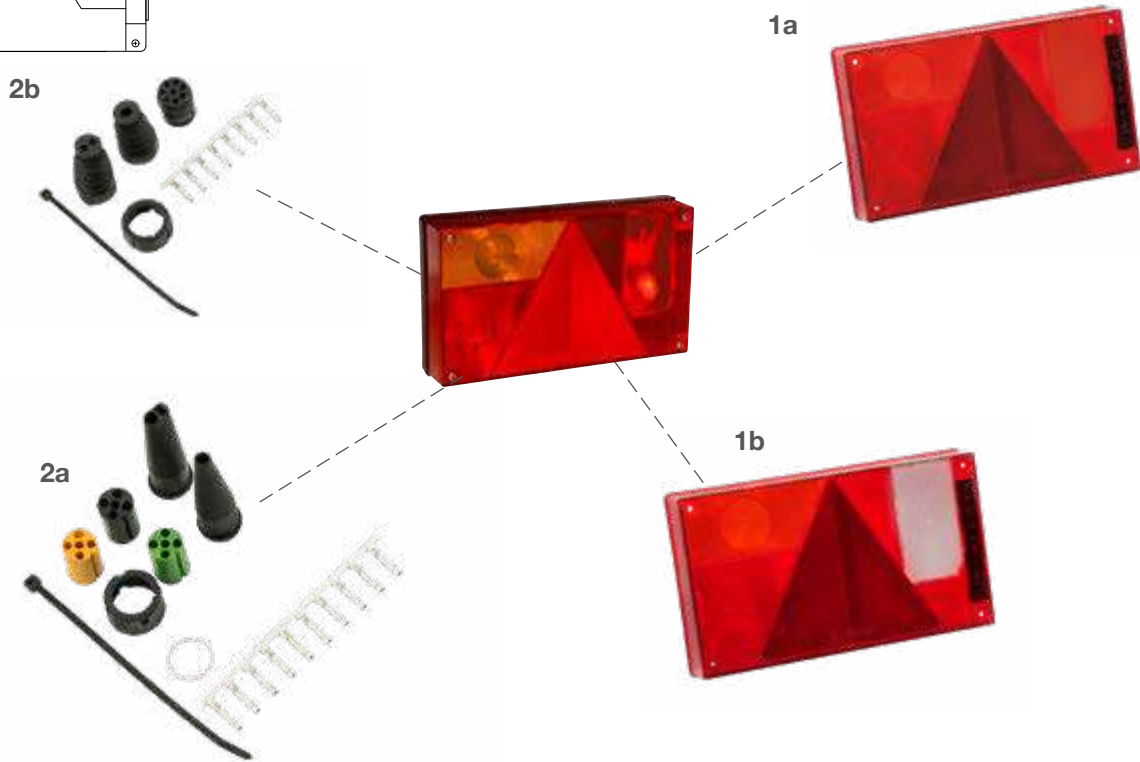
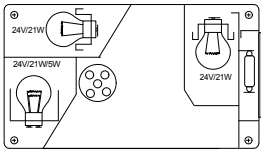







# MULTIPOINT I



ZUBEHÖR / ACCESSORIES



## 1 Lichtscheibe | lens

- (a) links mit 
  - left with  ..... 18-8450-021 
  - rechts mit 
    - right with  ..... 18-8452-021 
- (b) links mit 
  - left with  ..... 18-8451-021 
  - rechts mit 
    - right with  ..... 18-8452-121 

## 2 Bajonett Verbinder | bayonet connector

- (a) 5 pol. weiblich
  - 5 pin female ..... 13-0521-104 
- (b) 8 pol. weiblich
  - 8 pin female ..... 13-0828-034 

## Glühlampe | bulb

- 24V 21W ..... 16-6321-037 
- 24V 21/5W ..... 16-6310-027 
- 24V 5W Soffitte ..... 16-6705-017 



# MINILED II

ADR Zone 2 IP 6K9K

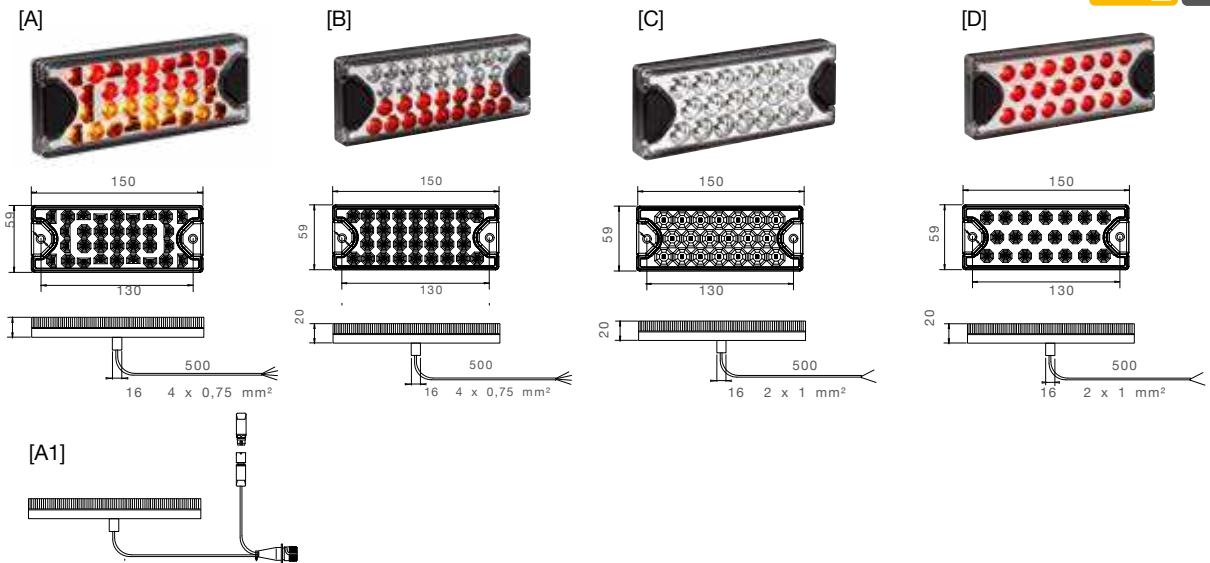

BEST. NR	PART NO							ZUSATZ ADD ON	ANSCHLUSS CONNECTOR	0,50 m	
32-7200-001	1/-	●	●	LED	12V 24V	[B]		offenes Ende open end	0,50 m		
32-7207-001	1/-	●	●	LED	12V 24V	[B]		3 pol. ASS3 3 pin ASS3	0,50 m		
33-7200-001	1/-	●	●	LED	12V 24V	[A]		offenes Ende open end	0,50 m		
33-7200-011	1/-	●	●	LED	12V 24V	[A]		offenes Ende open end	5,00 m		
33-7207-041	1/-	●		LED	12V 24V	[A1]		7 pol. ASS2 7 pin ASS2	0,50 m		
								3 pol. ASS3 3 pin ASS3	0,25 m		
33-7207-051	1/-		●	LED	12V 24V	[A1]		7 pol. ASS2 7 pin ASS2	0,50 m		
								3 pol. ASS3 3 pin ASS3	0,25 m		
37-7200-001	1/-	●	●	LED	12V 24V	[D]		offenes Ende open end	0,50 m		
37-7207-001	1/-	●	●	LED	12V 24V	[D]		2 pol. ASS3 2 pin ASS3	0,50 m		
38-7200-001	1/-	●	●	LED	12V 24V	[C]		offenes Ende open end	0,50 m		
38-7207-001	1/-	●	●	LED	12V 24V	[C]		2 pol. ASS3 2 pin ASS3	0,50 m		



# MINILED II

## ZUBEHÖR / ACCESSORIES

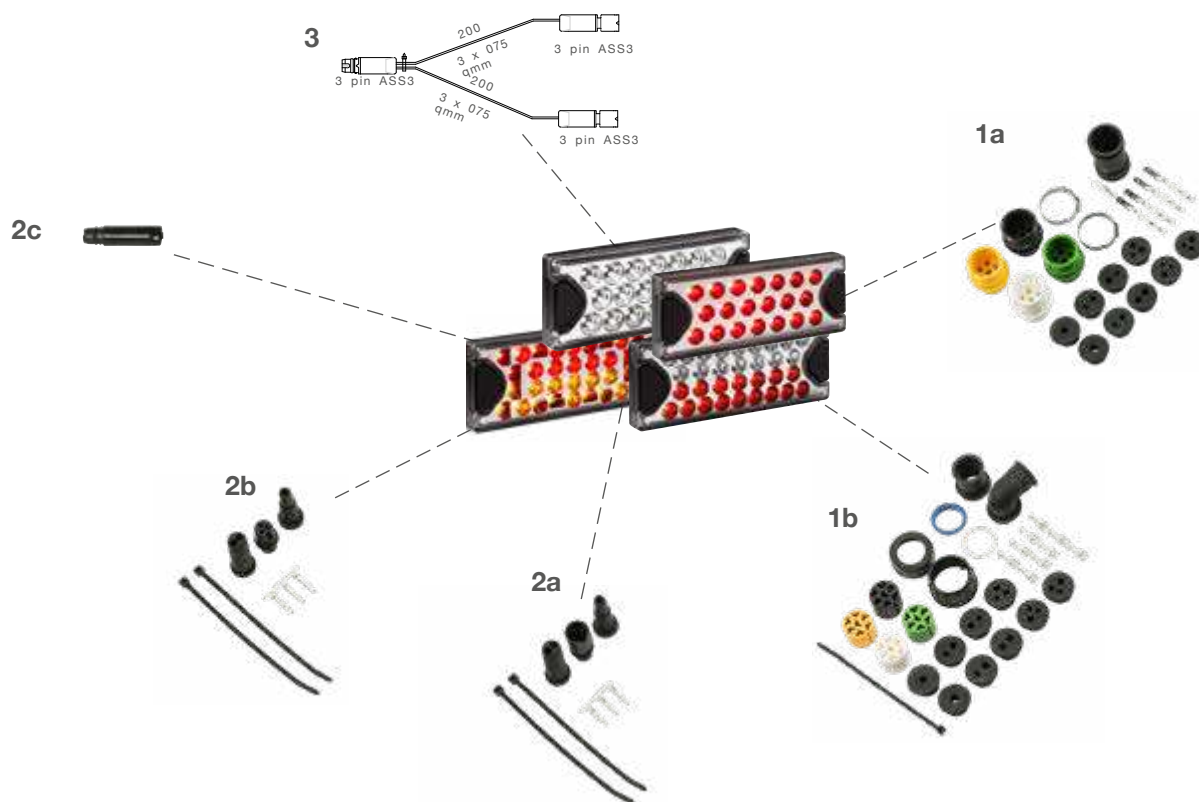

- 1 ASS1 & ASS2 Verbinder | ASS1 & ASS2 connector**
- (a) 7 pol. männlich  
7 pin male ..... 13-5625-981
  - (b) 7 pol. weiblich  
7 pin female ..... 13-5626-631
- 2 ASS3 Verbinder | ASS3 connector**
- (a) 3 pol. männlich  
3 pin male ..... 13-0332-281
  - (b) 3 pol. weiblich  
3 pin female ..... 13-0322-281
  - (c) 3 pol. Verschlusskappe  
3 pin connection ..... 13-0320-004
- 3 Y-Kabel 3 pol. ASS3 | Y-cable 3 pin ASS3**  
..... 65-6502-014



# LINEPOINT II

ADR Zone 2 IP 6K9K

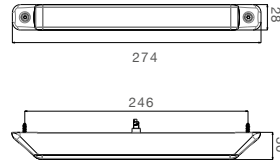

BEST. NR							ZUSATZ	ANSCHLUSS
PART NO							ADD ON	CONNECTOR
31-9207-031	-/-	●		LED	12V 24V			2 pol. ASS3 2 pin ASS3 ♀   0,50 m
31-9207-071	-/-	●		LED	12V 24V			2 pol. ASS3 2 pin ASS3 ♀   0,25 m
31-9231-201	1/-	●		LED	12V 24V			offenes Ende open end 0,50 m
31-9207-021	-/-		●	LED	12V 24V			2 pol. ASS3 2 pin ASS3 ♀   0,50 m
31-9207-061	-/-		●	LED	12V 24V			2 pol. ASS3 2 pin ASS3 ♀   0,25 m
31-9231-211	1/-		●	LED	12V 24V			offenes Ende open end 0,50 m
31-9207-011	1/-	●	●	LED	12V 24V			3 pol. ASS3 3 pin ASS3 ♀   0,50 m
31-9231-001	1/-	●	●	LED	12V 24V			offenes Ende open end 0,50 m
31-9207-001	1/-	●	●	LED	12V 24V			3 pol. ASS3 3 pin ASS3 ♀   0,50 m
31-9230-001	1/-	●	●	LED	12V 24V			offenes Ende open end 0,50 m
31-9207-081	-/-	●	●	LED	12V 24V			3 pol. ASS3 3 pin ASS3 ♀   0,25 m
37-9207-001	1/-	●	●	LED	12V 24V			3 pol. ASS3 3 pin ASS3 ♀   0,50 m
37-9230-001	1/-	●	●	LED	12V 24V			offenes Ende open end 0,50 m
38-9207-001	1/-	●	●	LED	12V 24V			3 pol. ASS3 3 pin ASS3 ♀   0,50 m
38-9230-001	1/-	●	●	LED	12V 24V			offenes Ende open end 0,50 m
38-9231-001	1/-	●	●	LED	12V 24V			offenes Ende open end 0,50 m
38-9237-001	1/-	●	●	LED	12V 24V			3 pol. ASS3 3 pin ASS3 ♀   0,50 m
38-9207-021	-/-	●	●	LED	12V 24V			3 pol. ASS3 3 pin ASS3 ♀   0,25 m



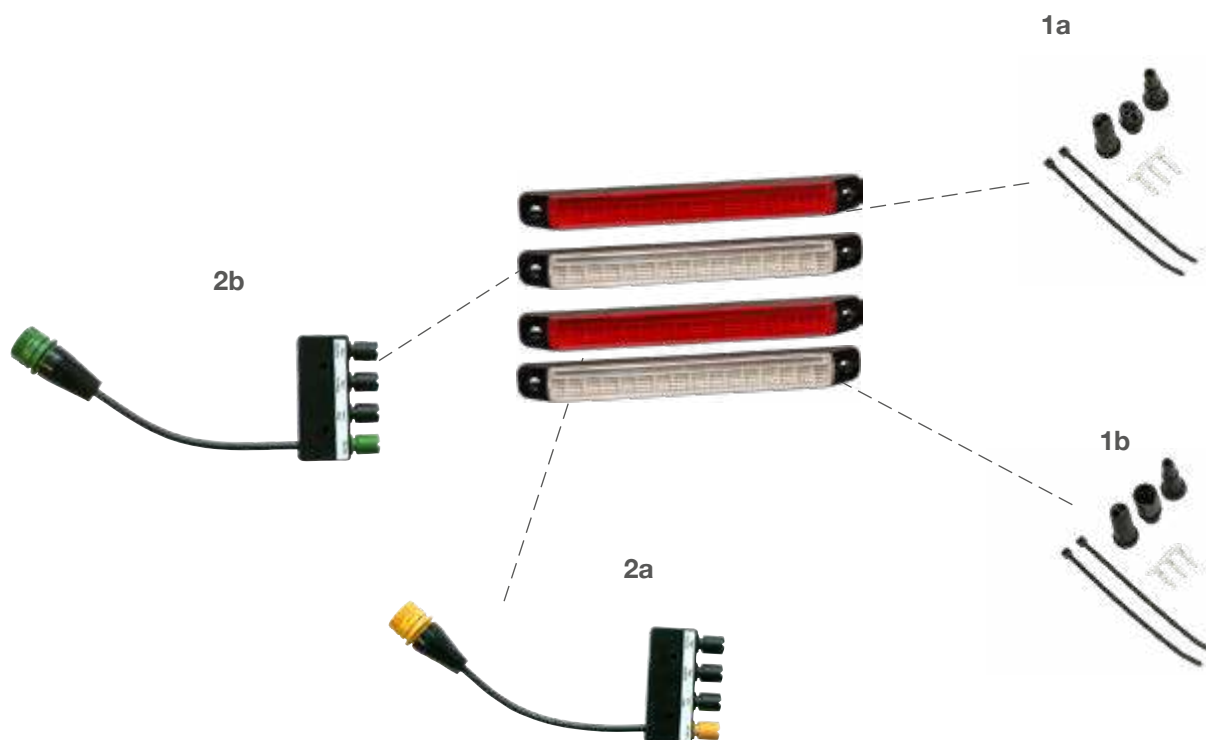

## LINEPOINT II

ZUBEHÖR / ACCESSORIES



### 1 ASS3 Verbinder | ASS3 connector

- (a) 3 pol. weiblich  
3 pin female ..... 13-0322-281 
- (b) 3 pol. männlich  
3 pin male ..... 13-0332-281 

### 2 ASS3 Verteiler | ASS3 junction box

- (a) links  
left ..... 76-9027-001 
- (b) rechts  
right ..... 76-9028-001 



# LINEPOINT I

ADR Zone 2 IP 6K9K

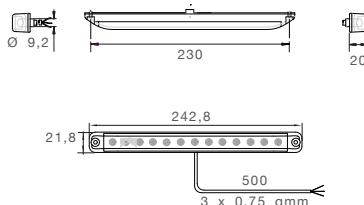

BEST. NR PART NO							ZUSATZ ADD ON	ANSCHLUSS CONNECTOR
31-8920-001	1/-	●	●	LED	12V 24V			offenes Ende 2 pol. open end 2 pin 0,50 m
31-8927-001	-/-	●	●	LED	12V 24V			2 pol. ASS3 2 pin ASS3    0,50 m
31-9207-041	1/-	●	●	LED	12V 24V			3 pol. ASS3 3 pin ASS3    0,50 m
31-9207-051	1/-	●	●	LED	12V 24V			2 pol. ASS3 2 pin ASS3    0,50 m
31-9220-001	1/-	●	●	LED	12V 24V			offenes Ende 3 pol. open end 3 pin 0,50 m
31-9220-011	-/-	●	●	LED	12V 24V			3 pol. AMP 3 pin AMP    0,15 m
31-9221-001	1/-	●	●	LED	12V 24V			offenes Ende 2 pol. open end 2 pin 0,50 m
31-9221-011	-/-	●	●	LED	12V 24V			2 pol. Superseal 2 pin Superseal    0,15 m
37-9207-011	-/-	●	●	LED	12V 24V			3 pol. ASS3 3 pin ASS3    0,50 m
37-9220-001	1/-	●	●	LED	12V 24V			offenes Ende 2 pol. open end 2 pin 0,50 m
37-9220-011	-/-	●	●	LED	12V 24V			2 pol. Superseal 2 pin Superseal    0,15 m
38-9207-011	1/-	●	●	LED	12V 24V			2 pol. ASS3 2 pin ASS3    0,50 m
38-9220-001	1/-	●	●	LED	12V 24V			offenes Ende 2 pol. open end 2 pin 0,50 m
38-9220-011	-/-	●	●	LED	12V 24V			2 pol. Superseal 2 pin Superseal    0,15 m
33-8914-001	1/-	●	●	LED	12V 24V			offenes Ende open end 0,50 m
33-8914-011	1/-	●	●	LED	12V 24V			offenes Ende open end 5,00 m





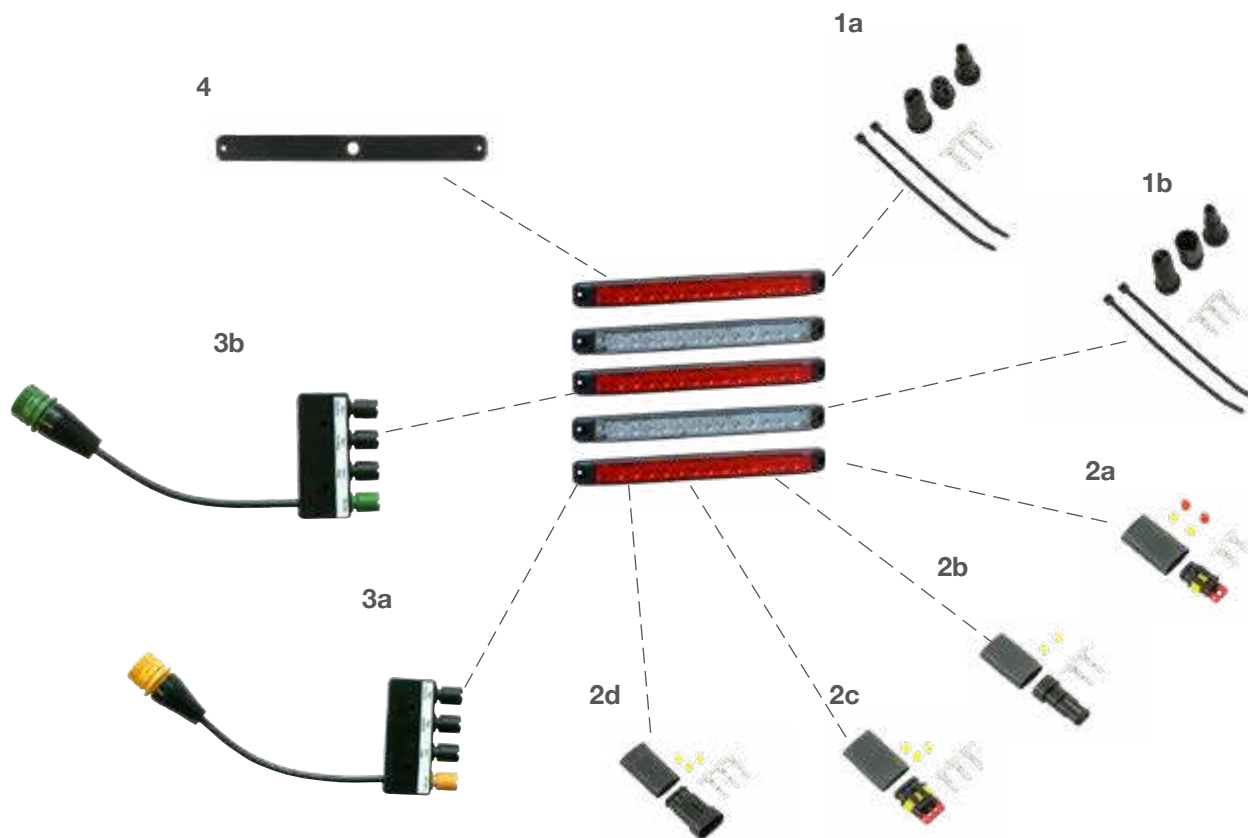

# LINEPOINT I

ZUBEHÖR / ACCESSORIES



## 1 ASS3 Verbinder | ASS3 connector

- (a) 3 pol. weiblich  
3 pin female ..... 13-0322-281 
- (b) 3 pol. männlich  
3 pin male ..... 13-0332-281 

## 2 Superseal Verbinder | Superseal connector

- (a) 2 pol. weiblich  
2 pin female ..... 15-7002-044
- (b) 2 pol. männlich  
2 pin male ..... 15-7002-054
- (c) 3 pol. weiblich  
3 pin female ..... 15-7002-064
- (d) 3 pol. männlich  
3 pin male ..... 15-7002-074

## 3 ASS3 Verteiler | ASS3 junction box

- (a) links  
left ..... 76-9027-001 
- (b) rechts  
right ..... 76-9028-001 

## 4 Gummiunterlage | rubber pad

- ..... 15-5111-404 



# BRASPOINT 98

ADR Zone 2 IP 6K9K

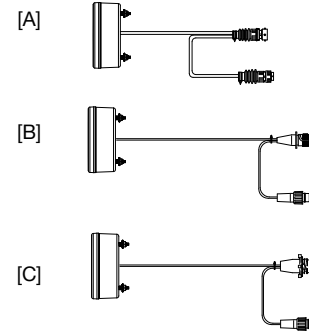
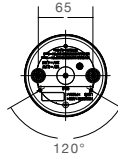
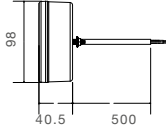

Blinklicht Direction indicator	Rücklicht Tail light	Bremslicht Stop light	

BEST. NR		←	→				ZUSATZ	ANSCHLUSS
PART NO							ADD ON	CONNECTOR
33-9200-001	1/-	●	●	LED	12V 24V			offenes Ende open end 0,50 m
33-9200-011	1/-	●	●	LED	12V 24V			offenes Ende open end 7,00 m
33-9200-021	1/-	●	●	LED	12V 24V			offenes Ende open end 2,00 m
33-9200-501	1/-	●	●	LED	12V 24V			5 pol. Bajonett 5 pin Bayonet 0,50 m
33-9200-511	1/-	●	●	LED	12V 24V		[A]	8 pol. Bajonett 8 pin Bayonet 0,50 m
								8 pol. Bajonett 8 pin Bayonet 0,25 m
33-9207-051	1/-	●	●	LED	12V 24V		[B]	7 pol. ASS2 7 pin ASS2 0,50 m
								7 pol. ASS2 7 pin ASS2 0,20 m
33-9207-081	1/-	●	●	LED	12V 24V		[C]	7 pol. AMP 7 pin AMP 0,50 m
								7 pol. ASS2 7 pin ASS2 0,20 m
33-9280-001	1/-	●	●	LED	12V 24V			4 pol. AMP 4 pin AMP 0,50 m







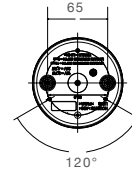
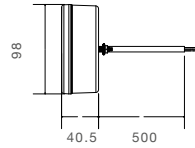































# BRASPOINT 98

ADR Zone 2 IP 6K9K



 Rückfahrlicht Reverse light	 Rücklicht Tail light	 Nebelschlusslicht Fog light
	 Rückstrahler rot Reflector red	

BEST. NR		←	→				ZUSATZ	ANSCHLUSS
PART NO							ADD ON	CONNECTOR
33-8100-001	1/-	●	●	LED	12V 24V			offenes Ende open end 0,50 m 
33-8100-101	1/-	●	●	LED	12V 24V			offenes Ende open end 0,50 m 
33-8100-501	1/-	●	●	LED	12V 24V			8 pol. Bajonett 8 pin Bayonet    0,50 m 
33-8100-601	1/-	●	●	LED	12V 24V			8 pol. Bajonett 8 pin Bayonet    0,50 m 
33-8107-041	1/-	●	●	LED	12V 24V			7 pol. ASS2 7 pin ASS2    0,50 m 
33-8107-051	1/-	●	●	LED	12V 24V			7 pol. ASS2 7 pin ASS2    0,50 m 
33-8180-001	1/-	●	●	LED	12V 24V			4 pol. AMP 4 pin AMP    0,50 m 



# BRASPOINT 98

ZUBEHÖR / ACCESSORIES

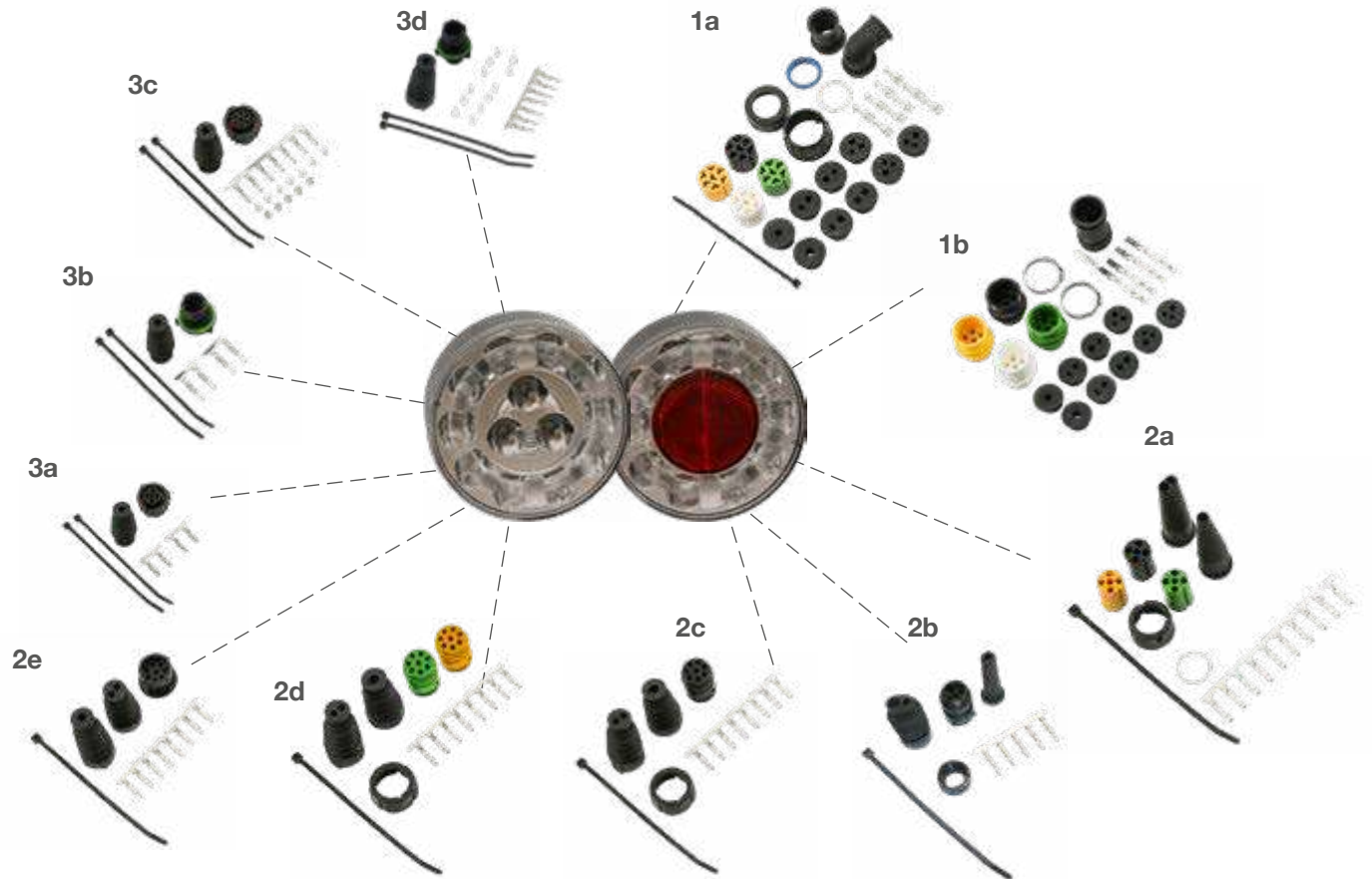

## 1 ASS1 & ASS2 Verbinder | ASS1 & ASS2 connector

- (a) 7 pol. weiblich  
7 pin female ..... 13-5626-631
- (b) 7 pol. männlich  
7 pin male ..... 13-5625-981

## 2 Bajonett Verbinder | bayonet connector

- (a) 5 pol. weiblich  
5 pin female ..... 13-0521-104
- (b) 5 pol. männlich  
5 pin male ..... 13-0536-044
- (c) 8 pol. weiblich  
8 pin female ..... 13-0828-034
- (d) 8 pol. weiblich  
8 pin female ..... 15-0821-524
- (e) 8 pol. männlich  
8 pin male ..... 13-0838-054

## 3 AMP Verbinder | AMP connector

- (a) 4 pol. weiblich  
4 pin female ..... 15-7002-004
- (b) 4 pol. männlich  
4 pin male ..... 15-7002-014
- (c) 7 pol. weiblich  
7 pin female ..... 15-7002-024
- (d) 7 pol. männlich  
7 pin male ..... 15-7002-034



# BRASPOINT 140

ADR Zone 2 IP 6K9K

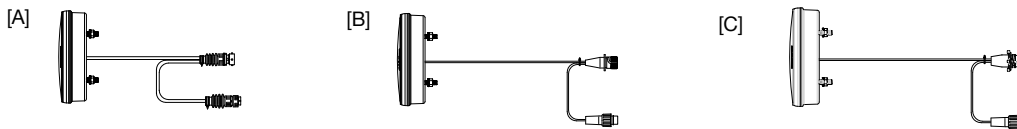
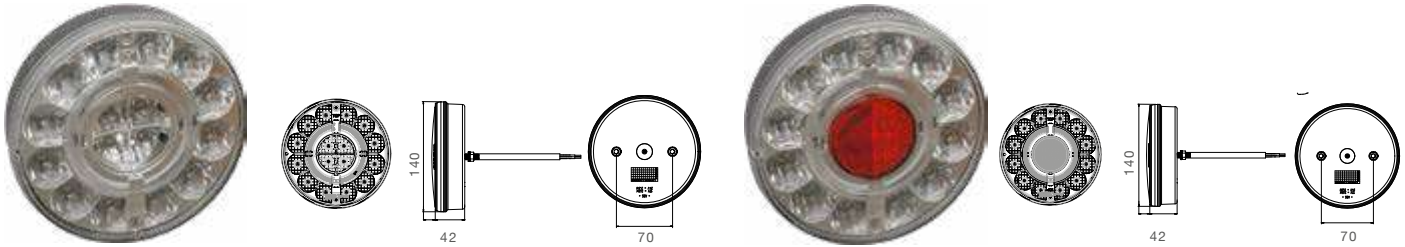

Nebelschlusslicht Fog light	Rücklicht Tail light	Rückfahrlicht Reverse light	Rückstrahler rot Reflector red
--------------------------------	-------------------------	--------------------------------	-----------------------------------

BEST. NR PART NO		←	→				ZUSATZ ADD ON	ANSCHLUSS CONNECTOR	0,50 m	
33-9200-201	1/-	●	●	LED	12V 24V			offenes Ende open end	0,50 m	
33-9200-701	1/-	●	●	LED	12V 24V			5 pol. Bajonett 5 pin Bayonet	0,50 m	
33-9200-711	1/-	●	●	LED	12V 24V		[A]	8 pol. Bajonett 8 pin Bayonet	0,50 m	
								8 pol. Bajonett 8 pin Bayonet	0,25 m	
33-9207-061	1/-	●	●	LED	12V 24V		[B]	7 pol. ASS2 7 pin ASS2	0,50 m	
								7 pol. ASS2 7 pin ASS2	0,20 m	
33-9207-091	-/-	●	●	LED	12V 24V		[C]	7 pol. AMP 7 pin AMP	0,50 m	
								7 pol. ASS2 7 pin ASS2	0,20 m	
33-9200-221	1/-	●	●	LED	12V 24V			offenes Ende open end	1,50 m	
33-9200-531	1/-	●	●	LED	12V 24V		[B]	7 pol. ASS2 7 pin ASS2	1,50 m	
								7 pol. ASS2 7 pin ASS2	0,30 m	
33-8100-201	1/-	●	●	LED	12V 24V			offenes Ende open end	0,50 m	
33-8100-701	1/-	●	●	LED	12V 24V			8 pol. Bajonett 8 pin Bayonet	0,50 m	
33-8107-031	1/-	●	●	LED	12V 24V			7 pol. ASS2 7 pin ASS2	0,50 m	
33-9200-211	1/-	●	●	LED	12V 24V			offenes Ende open end	1,50 m	
33-9200-521	1/-	●	●	LED	12V 24V			7 pol. ASS2 7 pin ASS2	1,50 m	



# BRASPOINT 140

ADR Zone 2 IP 6K9K

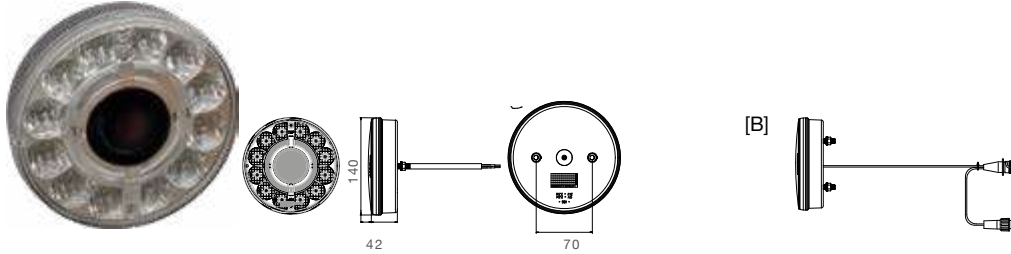

Blinklicht Direction indicator	Rücklicht Tail light	Bremslicht Stop light	
-----------------------------------	-------------------------	--------------------------	--

BEST. NR		←	→	LED	12V 24V		ZUSATZ ADD ON	ANSCHLUSS CONNECTOR
33-9200-301	-/-	●	●	LED	12V 24V			offenes Ende open end 0,50 m
33-9207-071	-/-	●	●	LED	12V 24V		[B]	7 pol. ASS2 7 pin ASS2 ♂   0,50 m
								7 pol. ASS2 7 pin ASS2 ♀   0,20 m



# BRASPOINT 140

## ZUBEHÖR / ACCESSORIES

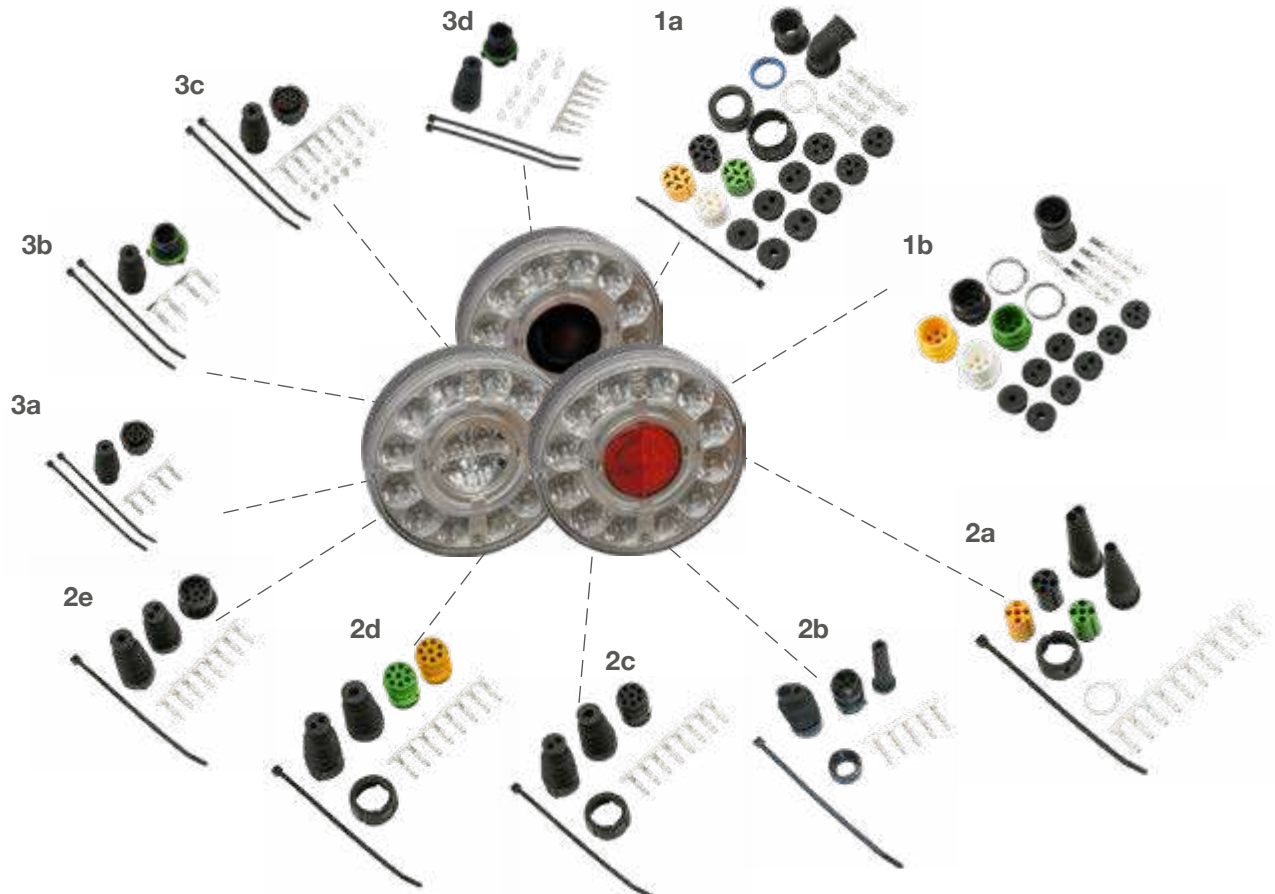

### 1 ASS1 & ASS2 Verbinder | ASS1 & ASS2 connector

- (a) 7 pol. weiblich  
7 pin female ..... 13-5626-631
- (b) 7 pol. männlich  
7 pin male ..... 13-5625-981

### 2 Bajonett Verbinder | bayonet connector

- (a) 5 pol. weiblich  
5 pin female ..... 13-0521-104
- (b) 5 pol. männlich  
5 pin male ..... 13-0536-044
- (c) 8 pol. weiblich  
8 pin female ..... 13-0828-034
- (d) 8 pol. weiblich  
8 pin female ..... 15-0821-524
- (e) 8 pol. männlich  
8 pin male ..... 13-0838-054

### 3 AMP Verbinder | AMP connector

- (a) 4 pol. weiblich  
4 pin female ..... 15-7002-004
- (b) 4 pol. männlich  
4 pin male ..... 15-7002-014
- (c) 7 pol. weiblich  
7 pin female ..... 15-7002-024
- (d) 7 pol. männlich  
7 pin male ..... 15-7002-034



# ROUNDPOINT II

ADR Zone 2 IP 6K9K

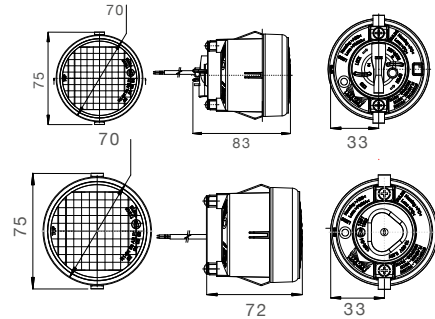

BEST. NR PART NO	☐	←	→	💡	⚡ V	🔵	ZUSATZ	ANSCHLUSS
							ADD ON	CONNECTOR
31-7600-001	1/-	●	●	💡	12V	🟡	↔	offenes Ende open end 1,80 m ⤴
32-7600-001	1/-	●	●	💡	12V	🔴	↔ (S)	offenes Ende open end 1,80 m ⤴
37-7600-001	1/-	●	●	💡	12V	🔴	⊕	offenes Ende open end 1,80 m ⤴
38-7600-001	1/-	●	●	💡	12V	⚪	⊖	offenes Ende open end 1,80 m ⤴



# ROUNDPOINT II LED

ZUBEHÖR / ACCESSORIES

ADR Zone 2 IP 6K9K

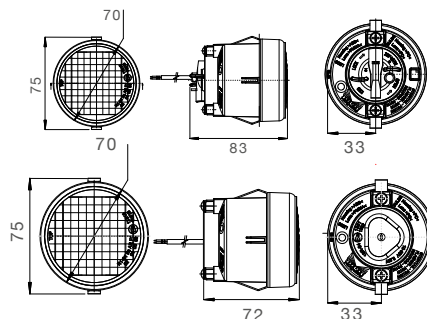

BEST. NR		←	→	💡	⚡	🔦	ZUSATZ	ANSCHLUSS
PART NO	📦						ADD ON	CONNECTOR
31-7600-701	1/-	●	●	LED	12V 24V			offenes Ende open end 1,80 m
32-7600-701	1/-	●	●	LED	12V 24V			offenes Ende open end 1,80 m
37-7600-701	1/-	●	●	LED	12V 24V			offenes Ende open end 1,80 m
38-7600-701	1/-	●	●	LED	12V 24V			offenes Ende open end 1,80 m

ZUBEHÖR / ACCESSORIES

## 1 Lichtscheibe inklusive Gehäuse | lens including housing

- (a) ..... 21-7600-001
- (b) ..... 22-7600-001
- (c) ..... 27-7600-001
- (d) ..... 28-7600-001

## Glühlampe | bulb

- 12V 21W, BA15s ..... 16-6121-017
- 12V 21W / 5W ..... 16-6122-017





## 3 CHAMBER LAMP II LED

ADR  
Zone 2

IP 54

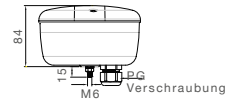
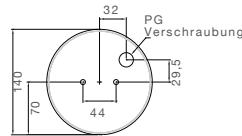
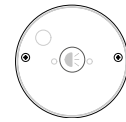
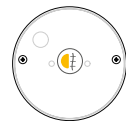
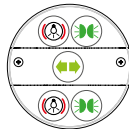

BEST. NR	PART NO	←	→	LED	V	ZUSATZ	ANSCHLUSS	
ADD ON							CONNECTOR	
22-7000-701	1/-	●	●	LED	12V 24V	☉ ☉	PG 11 Verschraubung cable glands 11	☉ ☉
23-8400-751	1/-	●	●	LED	12V 24V	☉ 2x ☉ 2x ☉	PG 11 Verschraubung cable glands 11	☉ ☉
23-8400-761	1/-	●	●	LED	12V 24V	☉ 2x ☉ 2x ☉	PG 16 Verschraubung cable glands 16	☉ ☉
23-8400-771	1/-	●	●	LED	12V 24V	☉ 2x ☉ 2x ☉	8 pol. Bajonett 8 pin Bayonet	♂ ☉ ☉
23-8400-781	1/-	●	●	LED	12V 24V	☉ 2x ☉ 2x ☉	5 pol. Bajonett 5 pin Bayonet	♂ ☉ ☉
23-8400-801	1/-	●	●	LED	12V 24V	☉ ☉ ☉	PG 11 Verschraubung cable glands 11	☉ ☉
23-8400-811	1/-	●	●	LED	12V 24V	☉ ☉ ☉	PG16 Verschraubung cable glands 16	☉ ☉
23-8400-821	1/-	●	●	LED	12V 24V	☉ ☉ ☉	8 pol. Bajonett 8 pin Bayonet	♂ ☉ ☉
27-8100-721	1/-	●	●	LED	12V 24V	☉	8 pol. Bajonett 8 pin Bayonet	♂ ☉ ☉
27-8400-701	1/-	●	●	LED	12V 24V	☉	PG 11 Verschraubung cable glands 11	☉ ☉
28-8100-731	1/-	●	●	LED	12V 24V	☉	8 pol. Bajonett 8 pin Bayonet	♂ ☉ ☉
28-8400-701	1/-	●	●	LED	12V 24V	☉	PG 11 Verschraubung cable glands 11	☉ ☉
32-7000-701	1/-	●	●	LED	12V 24V	☉ ☉	7 pol. ASS2 7 pin ASS2	♂ ☉ ☉ 1,50 m ☐
33-8400-011	1/-		●	LED	12V 24V	☉ ☉ ☉	offnes Ende open end	2,50 m ☐
33-8402-031	1/-		●	LED	12V 24V	☉ 2x ☉ 2x ☉	offnes Ende open end	0,50 m ☐
33-8403-031	1/-	●		LED	12V 24V	☉ 2x ☉ 2x ☉	offnes Ende open end	0,50 m ☐



# 3 CHAMBER LAMP II LED

ADR Zone 2

IP 54

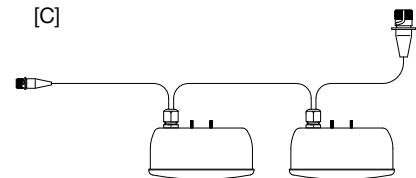
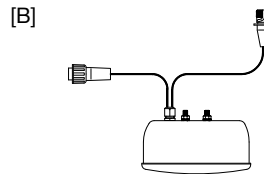
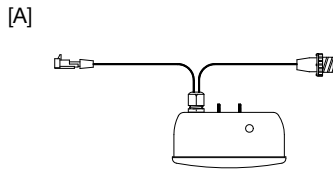

BEST. NR		←	→	💡	⚡		ZUSATZ	ANSCHLUSS
PART NO	📦						ADD ON	CONNECTOR
33-8403-041	1/-	●		LED	12V 24V			offnes Ende open end 0,50 m
33-8405-081	1/-	●		LED	12V 24V		2x  2x	7 pol. ASS2 7 pin ASS2 ♂  0,50 m
33-8405-091	1/-	●		LED	12V 24V			7 pol. ASS2 7 pin ASS2 ♂  0,50 m
33-8405-101	1/-	●		LED	12V 24V			7 pol. AMP 7 pin AMP ♂  0,90 m 2 pol. Superseal 2 pin Superseal ♂  1,00 m
33-8406-081	1/-		●	LED	12V 24V		2x  2x	7 pol. ASS2 7 pin ASS2 ♂  0,50 m
33-8406-091	1/-		●	LED	12V 24V			7 pol. ASS2 7 pin ASS2 ♂  0,50 m
33-8406-101	1/-		●	LED	12V 24V		[A]	7 pol. AMP 7 pin AMP ♂  0,90 m 2 pol. Superseal 2 pin Superseal ♂  1,00 m
33-8407-014	1/-	●	●	LED	12V 24V		[B]	7 pol. ASS2 7 pin ASS2 ♂  0,15 m 7 pol. ASS2 7 pin ASS2 ♀  0,15 m
37-8400-001	1/-	●	●	LED	12V 24V			2 pol. Superseal 2 pin Superseal ♀  0,55 m
37-8407-001	1/-	●	●	LED	12V 24V			2 pol. ASS2 2 pin ASS2 ♀  1,50 m
38-8107-061	1/-	●	●	LED	12V 24V			7 pol. ASS2 7 pin ASS2 ♀  0,15 m
38-8407-001	1/-	●	●	LED	12V 24V			2 pol. ASS2 2 pin ASS2 ♀  1,50 m
39-7000-001	1/-	●	●	LED	12V 24V			3 pol. AMP 3 pin AMP ♀  0,58 m
39-7007-001	1/-	●	●	LED	12V 24V			7 pol. ASS2 7 pin ASS2 ♂  0,15 m
87-3079-001	1/-	●		LED	12V 24V		[C]	7 pol. AMP 7 pin AMP ♂  0,90 m 2 pol. Superseal 2 pin Superseal ♂  1,00 m
87-3080-001	1/-		●	LED	12V 24V		[C]	7 pol. AMP 7 pin AMP ♂  0,90 m 2 pol. Superseal 2 pin Superseal ♂  1,00 m



# 3 CHAMBER LAMP II LED

ZUBEHÖR / ACCESSORIES

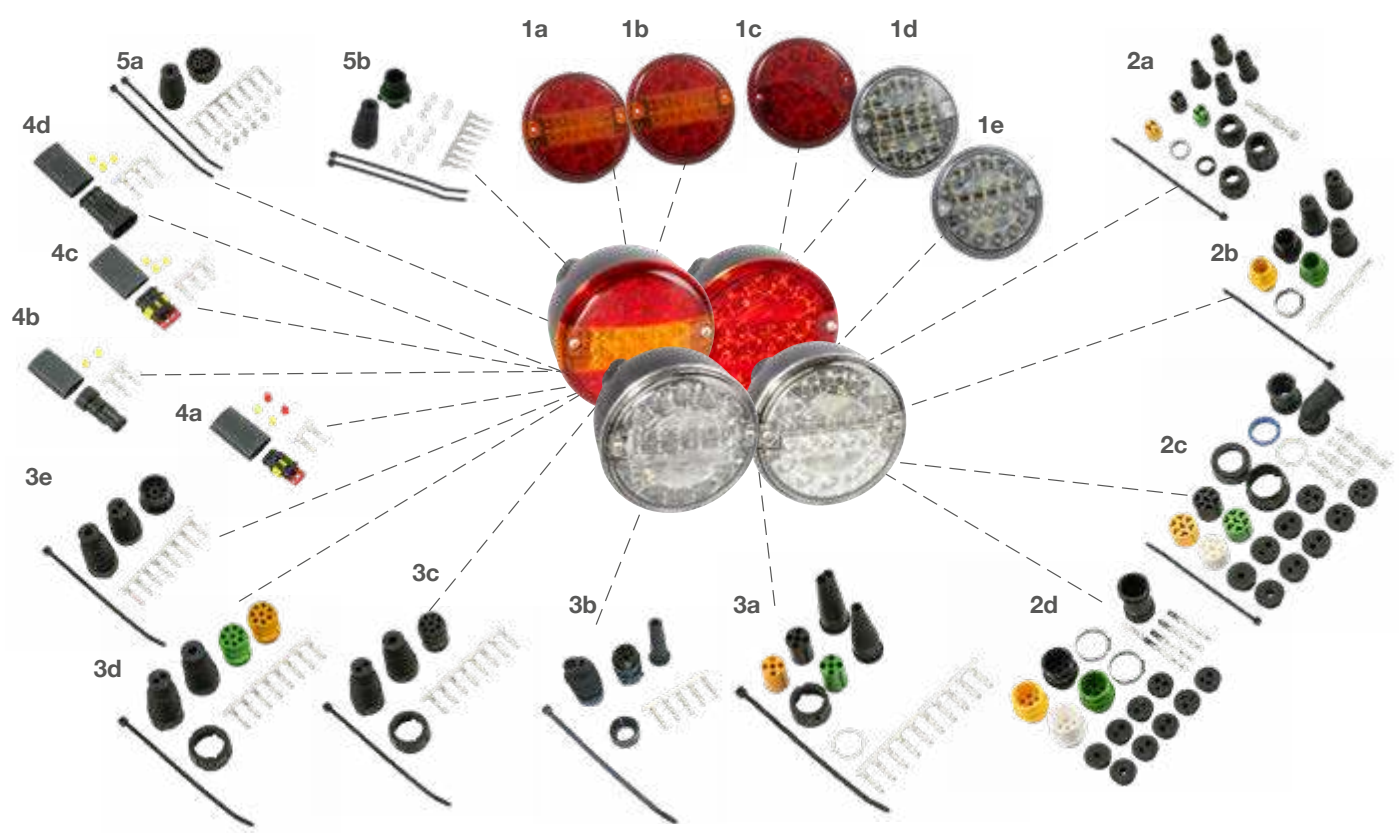

- 1 Lichtscheibe | lens**
- (a) 3 Kammerleuchte Doppelfunktion  
3 Chamber double function  
..... 18-8384-501
  - (b) 3 Kammerleuchte Einfunktion  
3 chamber single function  
..... 18-8384-551
  - (c) mit   
with ..... 18-8784-501
  - (d) mit   
with ..... 18-8884-501
  - (e) mit   
with ..... 22-7000-001

- 2 ASS1 & ASS2 Verbinder | ASS1 & ASS2 connector**
- (a) 2 pol. weiblich  
2 pin female ..... 13-5626-401
  - (b) 2 pol. männlich  
2 pin male ..... 13-5625-991
  - (c) 7 pol. weiblich  
7 pin female ..... 13-5626-631
  - (d) 7 pol. männlich  
7 pin male ..... 13-5625-981

- 3 Bajonett Verbinder | bayonet connector**
- (a) 5 pol. weiblich  
5 pin female ..... 13-0521-104

- (b) 5 pol. männlich  
5 pin male ..... 13-0536-044
- (c) 8 pol. weiblich  
8 pin female ..... 13-0828-034
- (d) 8 pol. weiblich  
8 pin female ..... 15-0821-524
- (e) 8 pol. männlich  
8 pin male ..... 13-0838-054

- 4 Superseal Verbinder | Superseal connector**
- (a) 2 pol. weiblich  
2 pin female ..... 15-7002-044
  - (b) 2 pol. männlich  
2 pin male ..... 15-7002-054
  - (c) 3 pol. weiblich  
3 pin female ..... 15-7002-064
  - (d) 3 pol. männlich  
3 pin male ..... 15-7002-074

- 5 AMP Verbinder | AMP connector**
- (a) 7 pol. weiblich  
7 pin female ..... 15-7002-024
  - (b) 7 pol. männlich  
7 pin male ..... 15-7002-034



# 3 CHAMBER LAMP | LED

ADR Zone 2

IP 54

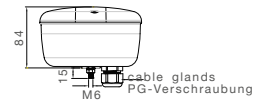
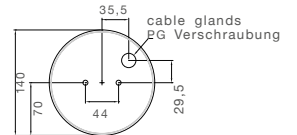
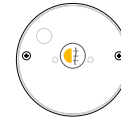
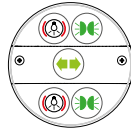

BEST. NR		←	→	💡	⚡		ZUSATZ	ANSCHLUSS
PART NO							ADD ON	CONNECTOR
23-8400-701	1/-	●	●	LED	24V			8 pol. Bajonett 8 pin Bayonet
23-8400-711	1/-	●	●	LED	24V			PG 16 Verschraubung cable glands 16
23-8400-721	1/-	●	●	LED	24V			PG 11 Verschraubung cable glands 11
23-8500-701	1/-	●	●	LED	24V		2x  2x	8 pol. Bajonett 8 pin Bayonet
23-8500-721	1/-	●	●	LED	24V		2x  2x	PG 11 Verschraubung cable glands 11
27-8100-701	1/-	●	●	LED	24V			PG 9 Verschraubung cable glands 9
28-8100-711	1/-	●	●	LED	24V			PG 9 Verschraubung cable glands 9

## ZUBEHÖR / ACCESSORIES

- 1** Bajonett Verbinder | bayonet connector  
 8 pol. weiblich  
 8 pin female ..... 13-0828-034





# 3 CHAMBER LAMP

ADR  
Zone 2

IP 54

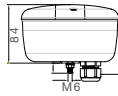

cable glands  
PG Verschraubung

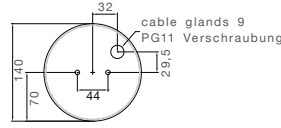

cable glands 9  
PG11 Verschraubung

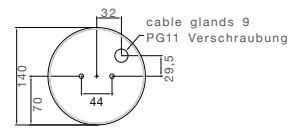
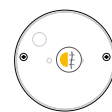

cable glands 9  
PG11 Verschraubung

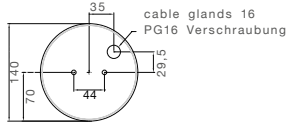

cable glands 16  
PG16 Verschraubung

BEST. NR	PART NO	←	→	💡	⚡	ZUSATZ	ANSCHLUSS
						ADD ON	CONNECTOR
23-8200-011	1/-	●	●	💡	24V		PG 11 Verschraubung cable glands 11
23-8200-511	1/-	●	●	💡	24V		8 pol. Bajonett 8 pin Bayonet
23-8220-001	1/-	●	●	💡	24V		18,5 mm Loch 18,5 mm hole
23-8230-001	1/-	●	●	💡	24V		PG 16 Verschraubung cable glands 16
27-8000-021	1/-	●	●	💡	24V		PG 9 Verschraubung cable glands 9
27-8001-511	1/-	●	●	💡	24V		8 pol. Bajonett 8 pin Bayonet
28-8000-021	1/-	●	●	💡	24V		PG 9 Verschraubung cable glands 9
28-8001-521	1/-	●	●	💡	24V		8 pol. Bajonett 8 pin Bayonet
33-8205-031	-/-	●		💡	24V	[A]	7 pol. ASS2 7 pin ASS2 0,50 m
33-8205-081	1/-	●		💡	24V		7 pol. ASS2 7 pin ASS2 1,50 m
33-8205-101	1/-	●		💡	24V	[B]	7 pol. AMP 7 pin AMP 0,90 m
							2 pol. Superseal 2 pin Superseal 1,00 m
33-8206-031	-/-		●	💡	24V	[A]	7 pol. ASS2 7 pin ASS2 0,50 m
33-8206-091	1/-		●	💡	24V		7 pol. ASS2 7 pin ASS2 1,50 m
33-8206-101	1/-		●	💡	24V	[B]	7 pol. AMP 7 pin AMP 0,90 m
							2 pol. Superseal 2 pin Superseal 1,00 m



# 3 CHAMBER LAMP

ADR Zone 2

IP 54

[A]

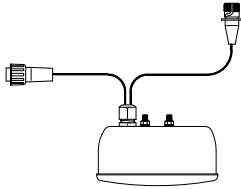

[B]

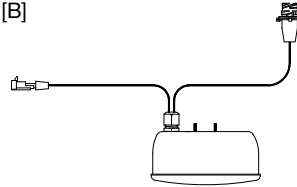

BEST. NR PART NO		←	→				ZUSATZ	ANSCHLUSS		
							ADD ON	CONNECTOR		
37-8000-041	-/-	●	●		24V			2 pol. Superseal 2 pin Superseal	♀	0,25 m
37-8000-061	-/-	●	●		24V			2 pol. Superseal 2 pin Superseal	♀	1,60 m
37-8007-131	1/-	●	●		24V			2 pol. ASS2 2 pin ASS2	♀	0,25 m
37-8007-161	-/-	●	●		24V			2 pol. ASS2 2 pin ASS2	♀	1,20 m
37-8007-191	1/-	●	●		24V			2 pol. ASS2 2 pin ASS2	♀	3,00 m
38-8000-031	-/-	●	●		24V			2 pol. Superseal 2 pin Superseal	♂	0,25 m
38-8000-051	-/-	●	●		24V			2 pol. Superseal 2 pin Superseal	♀	0,25 m
38-8000-061	-/-	●	●		24V			2 pol. Superseal 2 pin Superseal	♀	1,60 m
38-8007-131	1/-	●	●		24V			2 pol. ASS2 2 pin ASS2	♀	0,25 m
38-8007-141	-/-	●	●		24V			2 pol. ASS2 2 pin ASS2	♀	3,00 m
38-8007-151	-/-	●	●		24V			2 pol. ASS2 2 pin ASS2	♀	1,20 m



# 3 CHAMBER LAMP

ADR  
Zone 2

IP 54

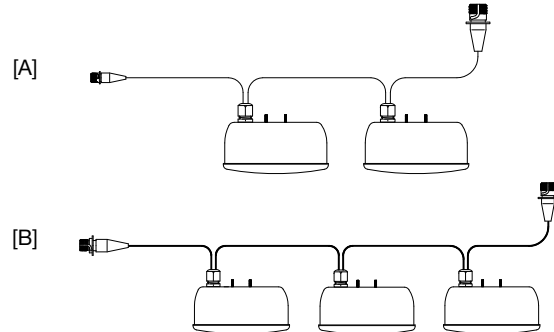
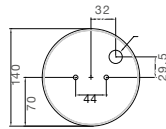
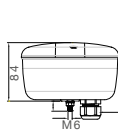

Blinklicht Direction indicator	Rücklicht Tail light	Bremslicht Stop light	

BEST. NR PART NO		←	→				ZUSATZ	ANSCHLUSS
							ADD ON	CONNECTOR
87-3047-021	1/-		●		24V		[A] 7 pol. ASS2 7 pin ASS2 2 pol. ASS2 2 pin ASS2	  0,90 m   1,00 m
87-3048-021	1/-	●			24V		[A] 7 pol. ASS2 7 pin ASS2 2 pol. ASS2 2 pin ASS2	  0,90 m   1,00 m
87-3067-001	-/-		●		24V		[B] 7 pol. ASS2 7 pin ASS2 2 pol. ASS2 2 pin ASS2	  0,90 m   1,00 m
87-3068-001	-/-	●			24V		[B] 7 pol. ASS2 7 pin ASS2 2 pol. ASS2 2 pin ASS2	  0,90 m   1,00 m
87-3081-001	1/-	●			24V		[B] 7 pol. AMP 7 pin AMP 2 pol. Superseal 2 pin Superseal	  0,90 m   1,00 m
87-3082-001	1/-		●		24V		[B] 7 pol. AMP 7 pin AMP 2 pol. Superseal 2 pin Superseal	  0,90 m   1,00 m





# 3 CHAMBER LAMP

ZUBEHÖR / ACCESSORIES

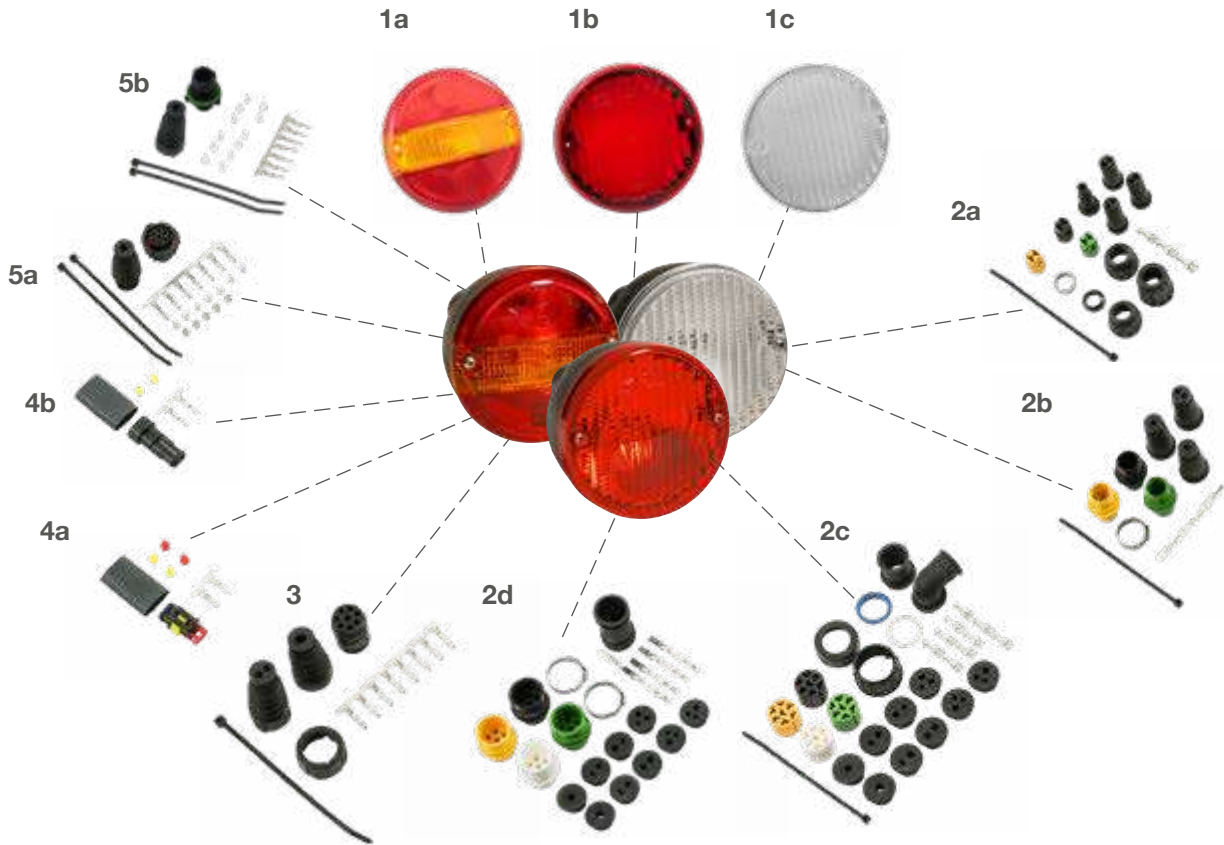

## 1 Lichtscheibe | lens

- (a) 3 Kammerleuchte  
3 chamber lamp..... 18-8382-104
- (b) mit   
with ..... 18-8780-104
- (c) mit   
with ..... 18-8880-104

## 2 ASS1 & ASS2 Verbinder | ASS1 & ASS2 connector

- (a) 2 pol. weiblich  
2 pin female ..... 13-5626-401
- (b) 2 pol. männlich  
2 pin male ..... 13-5625-991
- (c) 7 pol. weiblich  
7 pin female ..... 13-5626-631
- (d) 7 pol. männlich  
7 pin male ..... 13-5625-981

## 3 Bajonett Verbinder | bayonet connector

- 8 pol. weiblich  
8 pin female ..... 13-0828-034

## 4 Superseal Verbinder | Superseal connector

- (a) 2 pol. weiblich  
2 pin female ..... 15-7002-044
- (b) 2 pol. männlich  
2 pin male ..... 15-7002-054

## 5 AMP Verbinder | AMP connector

- (a) 7 pol. weiblich  
7 pin female ..... 15-7002-024
- (b) 7 pol. männlich  
7 pin male ..... 15-7002-034

## Glühlampe | bulb

- 24V 21W ..... 16-6321-037
- 24V 10W ..... 16-6310-027

# FASTBOOK<sup>®</sup>

## SYSTEMS



## UMRISSLEUCHE

Um eine flexible und optimale Anbringung zu ermöglichen, werden Aspöck Umrissleuchten mit verschiedenen Befestigungswinkeln angeboten. Somit kann die Begrenzung des Fahrzeuges sichtbar gemacht und mehr Sicherheit garantiert werden.

## END OUTLINE MARKER

In order to permit flexible and optimum attachment, Aspöck end-outline marker lamps are offered with various mounting brackets. In this way, accurate delimitation of the vehicle can be achieved and therefore a higher level of safety guaranteed.

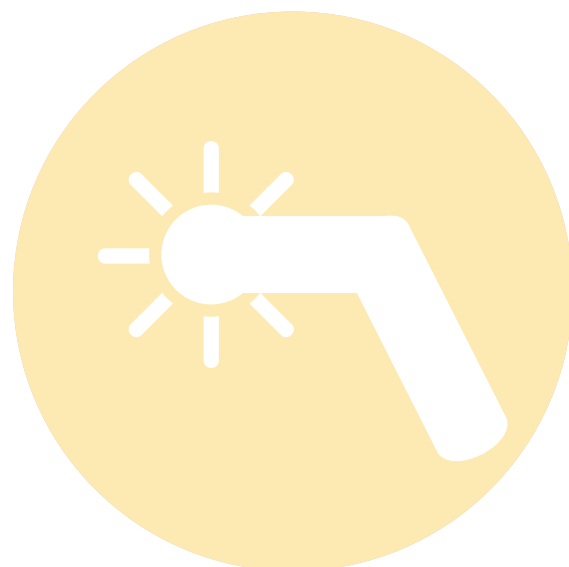



# FLEXIPOINT I LED

ADR  
Zone 2

IP 54



[A]

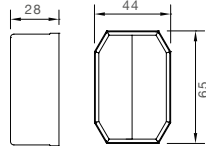

[B]

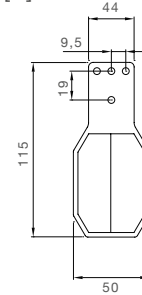

Umrissleuchte  
End outline marker

BEST. NR PART NO		←	→			ZUSATZ ADD ON		ANSCHLUSS CONNECTOR				
						[A]	[B]					
31-6300-004	1/-	●	●	LED	12V 24V	[A]			Offenes Ende open end	1,00 m		
31-6304-014	1/-	●	●	LED	12V 24V	[A]			P&R		1,00 m	
31-6364-004	1/-	●		LED	12V 24V	[B]			P&R		1,00 m	
31-6364-014	1/-		●	LED	12V 24V	[B]			P&R		1,00 m	



# FLEXIPOINT I LED

ZUBEHÖR / ACCESSORIES

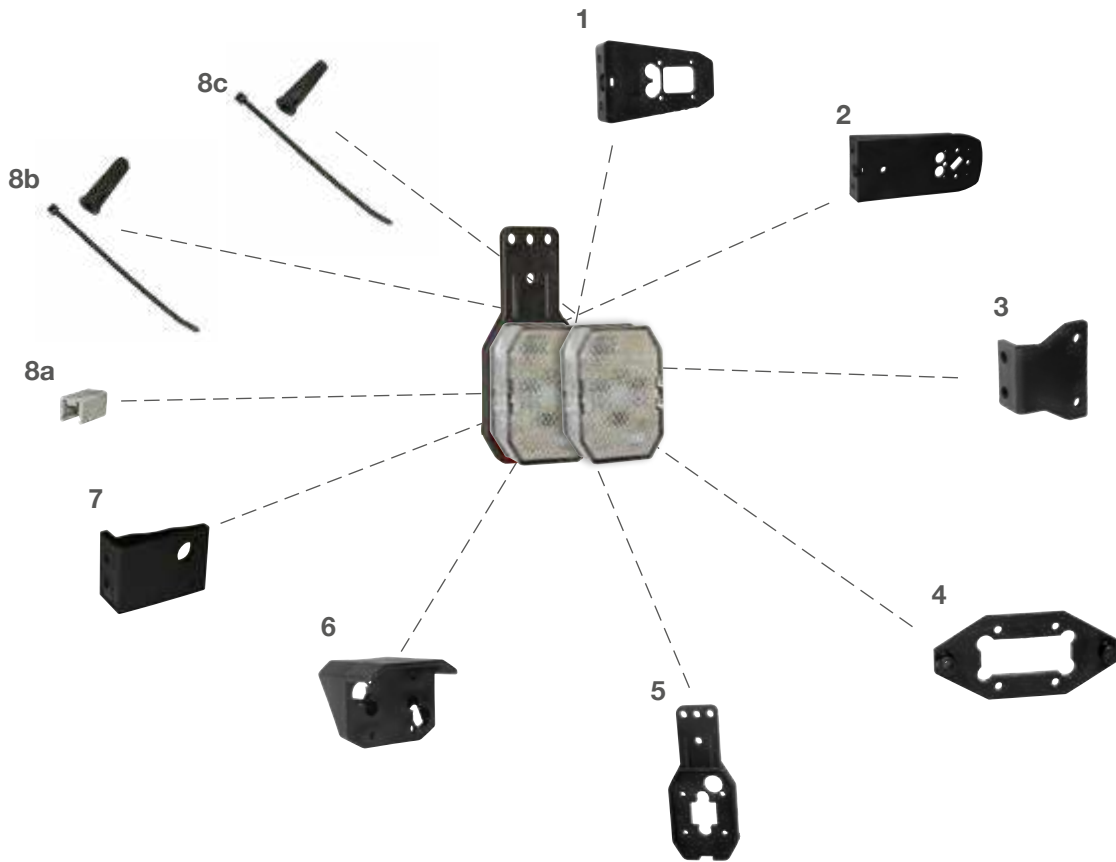

**1** Aufhängelasche 100 mm |  
bracket 100 mm  
..... 15-5310-104

**2** Aufhängelasche 150 mm |  
bracket 150 mm  
..... 15-5311-004

**3** 90° Winkelhalter | 90° bracket  
..... 15-5318-004

**4** wendbare Halteplatte | turnable flat bracket  
..... 15-5316-004

**5** flexibler gerader Gummihalter |  
flexible straight rubber bracket  
..... 15-5312-104

**6** Kotflügelhalter | mud guard bracket  
..... 15-5314-104

**7** Winkelhalter soft | soft bracket  
..... 15-5316-704

**8** für P&R Verbinder | for P&R connector  
(a) Verschlusskappen  
caps..... 15-5971-014   
(b) Endkappen rund  
end caps round..... 15-5983-024   
(c) Endkappen eckig  
end caps square..... 15-5729-014





# FLEXIPOINT I



[A]

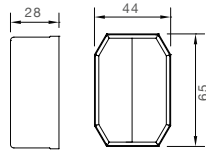

[B]

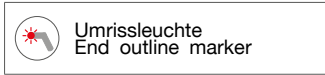
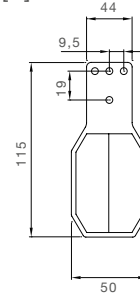

BEST. NR PART NO		←	→			ZUSATZ ADD ON			ANSCHLUSS CONNECTOR			
						[A]	[B]					
31-6504-084	1/-	●	●		24V	[A]			P&R			0,50 m
31-6504-134	-/-	●	●		24V	[A]			P&R			2,00 m
31-6504-104	-/-	●	●		24V	[A]			P&R			0,25 m
31-6504-174	1/-	●	●		24V	[A]			P&R			0,50 m
31-6564-064	1/-		●		24V	[B]			P&R			0,50 m
31-6564-074	-/-	●			24V	[B]			P&R			0,50 m
31-6564-144	1/-		●		24V	[B]			P&R			1,50 m
31-6564-154	1/-	●			24V	[B]			P&R			1,50 m



# FLEXIPOINT I

ZUBEHÖR / ACCESSORIES

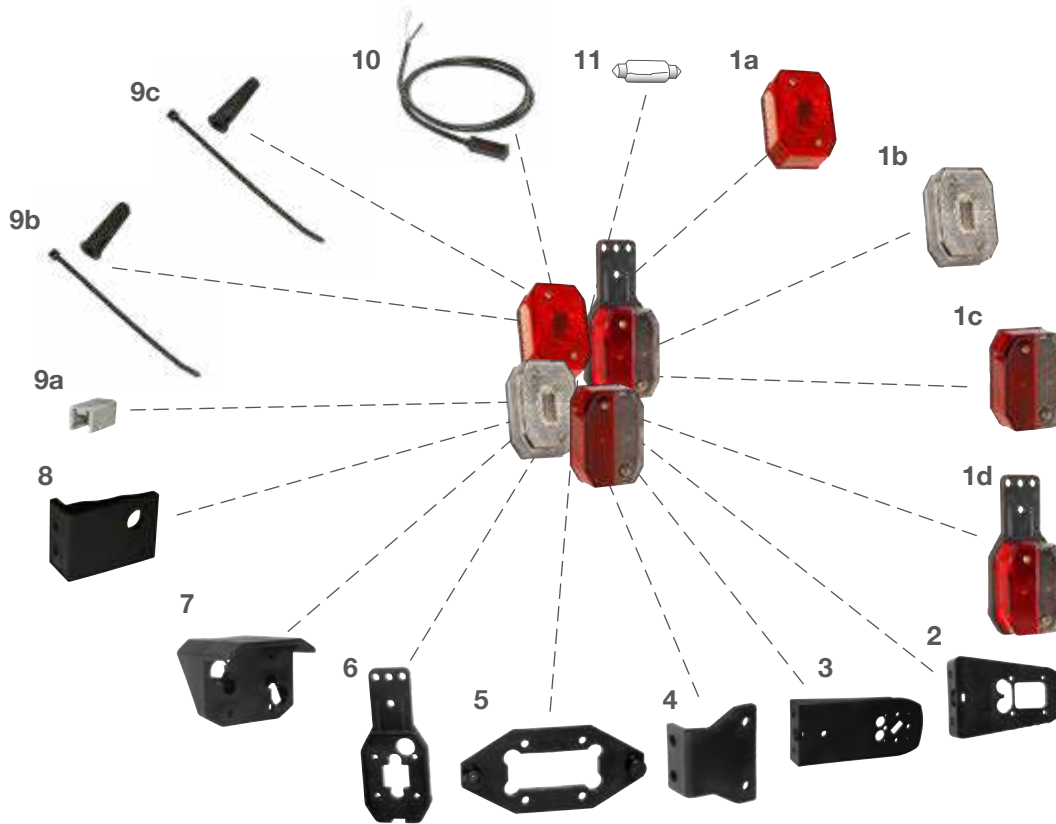

- 1 Ersatzteileuchte | spare part lamp**
- (a) rot ..... 21-6510-004
  - (b) weiß ..... 21-6512-004
  - (c) rot/weiß ..... 21-6513-004
  - (d) rot/weiß mit Aufhängelasche  
red/white with bracket. 21-6513-214

- 2 Aufhängelasche 100 mm |  
bracket 100 mm**  
..... 15-5310-104

- 3 Aufhängelasche 150 mm |  
bracket 150 mm**  
..... 15-5311-004

- 4 90° Winkelhalter | 90° bracket**  
..... 15-5318-004

- 5 wendbare Halteplatte | turnable flat bracket**  
..... 15-5316-004

- 6 flexibler gerader Gummihalter |  
flexible straight rubber bracket**  
..... 15-5312-104

- 7 Kotflügelhalter | mud guard bracket**  
..... 15-5314-104

- 8 Winkelhalter soft | soft bracket**  
..... 15-5316-704

- 9 für P&R Verbinder | for P&R connector**
- (a) Verschlusskappen  
caps..... 15-5971-014
  - (b) Endkappen rund  
end caps round..... 15-5983-024
  - (c) Endkappen eckig  
end caps square..... 15-5729-014

- 10 Zuleitung P&R | front connection P&R**
- 0,5 m..... 68-5000-574
  - 1,5 m..... 68-5000-604
  - 5,0 m..... 68-5000-634

- 11 Soffitte**  
24V 5W ..... 16-6705-017





# SUPERPOINT IV LED

ADR Zone 2 IP 69K

[A1]

[A2]

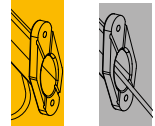
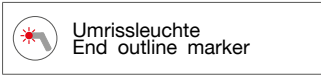
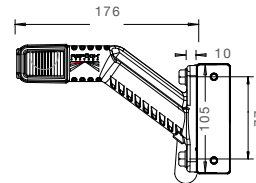
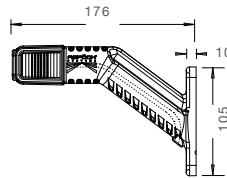

BEST. NR PART NO		←	→			ZUSATZ ADD ON			ANSCHLUSS CONNECTOR				
31-3104-004	1/-	●		LED	12V 24V	[A1]				P&R		2,00 m	
31-3105-004	1/-	●		LED	12V 24V	[A1]				2 pol. ASS2 2 pin ASS2	♀	2,00 m	
31-3103-034	1/-	●		LED	12V 24V	[A1]				2 pol. Superseal 2 pin Superseal	♀	1,00 m	
31-3104-014	1/-		●	LED	12V 24V	[A1]				P&R		2,00 m	
31-3106-004	1/-		●	LED	12V 24V	[A1]				2 pol. ASS2 2 pin ASS2	♀	2,00 m	
31-3102-034	1/-		●	LED	12V 24V	[A1]				2 pol. Superseal 2 pin Superseal	♀	1,00 m	
31-3103-024	1/-	●		LED	12V 24V	[A1]				offenes Ende mit Flachsteckern open end with contact pin		0,25 m	
31-3102-024	1/-		●	LED	12V 24V	[A1]				offenes Ende mit Flachsteckern open end with contact pin		0,25 m	
31-3100-004	2/-	●		LED	12V 24V	[A1]				P&R		2,00 m	
			●			[A1]				P&R		2,00 m	
31-3103-104	1/-	●		LED	12V 24V	[A1]				Offenes Ende open end		0,25 m	
31-3103-114	1/-	●		LED	12V 24V	[A1]				Offenes Ende open end		2,00 m	
31-3103-124	1/-	●		LED	12V 24V	[A1]				2 pol. Superseal 2 pin Superseal	♂	2,00 m	
31-3103-184	1/-	●		LED	12V 24V	[A1]				P&R		2,00 m	
31-3103-204	1/-	●		LED	12V 24V	[A1]				2 pol. ASS2 2 pin ASS2	♀	0,25 m	
31-3103-214	1/-	●		LED	12V 24V	[A1]				2 pol. Superseal 2 pin Superseal	♀	0,25 m	
31-3104-034	1/-	●		LED	12V 24V	[A1]				P&R		0,50 m	
31-3105-014	1/-	●		LED	12V 24V	[A1]				2 pol. ASS2 2 pin ASS2	♀	0,50 m	





# SUPERPOINT IV LED

ADR Zone 2 IP69K



[A1]

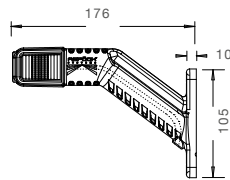

[A2]

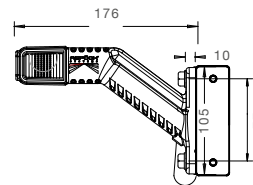

Umrissleuchte  
End outline marker

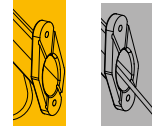

BEST. NR PART NO		←	→			ZUSATZ ADD ON			ANSCHLUSS CONNECTOR					
									2 pol. ASS3 2 pin ASS3	2 pol. ASS2 2 pin ASS2	Offenes Ende open end	2 pol. Superseal 2 pin Superseal	P&R	2 pol. ASS2 2 pin ASS2
31-3105-024	1/-	●			12V 24V	[A1]				2 pol. ASS3 2 pin ASS3	♀		1,50 m	
31-3105-034	1/-	●			12V 24V	[A1]				2 pol. ASS2 2 pin ASS2	♀		2,00 m	
31-3105-044	1/-	●			12V 24V	[A1]				2 pol. ASS2 2 pin ASS2	♀		0,75 m	
31-3164-004	1/-	●			12V 24V	[A2]				P&R			0,75 m	
31-3165-004	1/-	●			12V 24V	[A2]				2 pol. ASS2 2 pin ASS2	♀		1,50 m	
31-3102-104	1/-		●		12V 24V	[A1]				Offenes Ende open end			0,25 m	
31-3102-114	1/-		●		12V 24V	[A1]				Offenes Ende open end			2,00 m	
31-3102-124	1/-		●		12V 24V	[A1]				2 pol. Superseal 2 pin Superseal	♂		2,00 m	
31-3102-184	1/-		●		12V 24V	[A1]				P&R			2,00 m	
31-3102-204	1/-		●		12V 24V	[A1]				2 pol. ASS2 2 pin ASS2 Ecoled II	♀		0,25 m	
31-3102-214	1/-		●		12V 24V	[A1]				2 pol. Superseal 2 pin Superseal Ecoled II	♀		0,25 m	
31-3104-024	1/-		●		12V 24V	[A1]				P&R			0,50 m	
31-3106-014	1/-		●		12V 24V	[A1]				2 pol. ASS2 2 pin ASS2	♀		0,50 m	
31-3106-024	1/-		●		12V 24V	[A1]				2 pol. ASS3 2 pin ASS3	♀		1,50 m	
31-3106-034	1/-		●		12V 24V	[A1]				2 pol. ASS2 2 pin ASS2	♀		2,00 m	
31-3106-044	1/-		●		12V 24V	[A1]				2 pol. ASS2 2 pin ASS2	♀		0,75 m	
31-3164-014	1/-		●		12V 24V	[A2]				P&R			0,75 m	
31-3166-004	1/-		●		12V 24V	[A2]				2 pol. ASS2 2 pin ASS2	♀		1,50 m	



# SUPERPOINT IV LED

ADR Zone 2 IP 69K

[B]

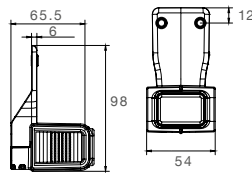

[C]

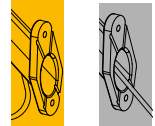
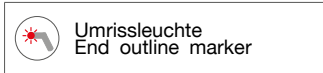
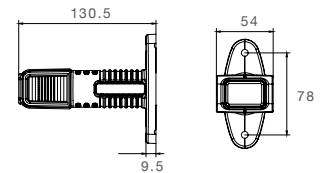

BEST. NR						ZUSATZ				ANSCHLUSS		
PART NO				LED	12V 24V	ADD ON				CONNECTOR		
31-3103-064	1/-	●		LED	12V 24V	[B]				Offenes Ende open end	2,00 m	
31-3103-144	1/-	●		LED	12V 24V	[B]				Offenes Ende open end	2,00 m	
31-3103-194	1/-	●		LED	12V 24V	[B]				2 pol. ASS3 2 pin ASS3	  	2,00 m
31-3104-084	1/-	●		LED	12V 24V	[B]				P&R	 	2,00 m
31-3102-064	1/-		●	LED	12V 24V	[B]				Offenes Ende open end	2,00 m	
31-3102-144	1/-		●	LED	12V 24V	[B]				Offenes Ende open end	2,00 m	
31-3102-194	1/-		●	LED	12V 24V	[B]				2 pol. ASS3 2 pin ASS3	  	2,00 m
31-3104-094	1/-		●	LED	12V 24V	[B]				P&R	 	2,00 m
31-3103-074	1/-	●		LED	12V 24V	[C]				Offenes Ende open end	2,00 m	
31-3103-134	1/-	●		LED	12V 24V	[C]				P&R	 	2,00 m
31-3103-154	1/-	●		LED	12V 24V	[C]				Offenes Ende open end	2,00 m	
31-3104-044	1/-	●		LED	12V 24V	[C]				P&R	 	2,00 m
31-3102-074	1/-		●	LED	12V 24V	[C]				Offenes Ende open end	2,00 m	
31-3102-134	1/-		●	LED	12V 24V	[C]				P&R	 	2,00 m
31-3102-154	1/-		●	LED	12V 24V	[C]				Offenes Ende open end	2,00 m	
31-3104-054	1/-		●	LED	12V 24V	[C]				P&R	 	2,00 m



# SUPERPOINT IV LED

ADR Zone 2

IP 69K

[D]

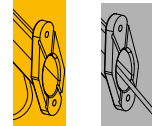
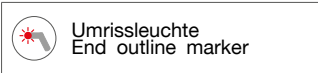
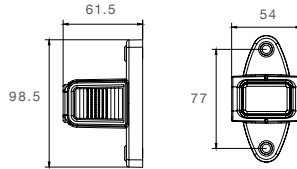

BEST. NR PART NO	Box	←	→	LED	12V 24V	ZUSATZ ADD ON			ANSCHLUSS CONNECTOR		
						[D]	Color	Mounting	Connector	Length	End
31-3103-044	1/-	●		LED	12V 24V	[D]	Red/White	Bracket	Offenes Ende open end	2,00 m	↔
31-3103-054	1/-	●		LED	12V 24V	[D]	Red/White	Bracket	Offenes Ende open end	2,00 m	↔
31-3103-164	1/-	●		LED	12V 24V	[D]	Red/White	Bracket	Offenes Ende open end	2,00 m	↔
31-3104-104	1/-	●		LED	12V 24V	[D]	Red/White	Bracket	Offenes Ende open end	4,50 m	↔
31-3104-114	1/-	●		LED	12V 24V	[D]	Red/White	Bracket	P&R	4,50 m	↔
31-3104-064	1/-	●		LED	12V 24V	[D]	Red/White	Bracket	P&R	2,00 m	↔
31-3102-044	1/-		●	LED	12V 24V	[D]	Red/White	Bracket	Offenes Ende open end	2,00 m	↔
31-3102-054	1/-		●	LED	12V 24V	[D]	Red/White	Bracket	Offenes Ende open end	2,00 m	↔
31-3102-164	1/-		●	LED	12V 24V	[D]	Red/White	Bracket	Offenes Ende open end	2,00 m	↔
31-3104-124	1/-		●	LED	12V 24V	[D]	Red/White	Bracket	P&R	4,50 m	↔
31-3104-134	1/-		●	LED	12V 24V	[D]	Red/White	Bracket	Offenes Ende open end	4,50 m	↔
31-3104-074	1/-		●	LED	12V 24V	[D]	Red/White	Bracket	P&R	2,00 m	↔



# SUPERPOINT IV LED

ZUBEHÖR / ACCESSORIES

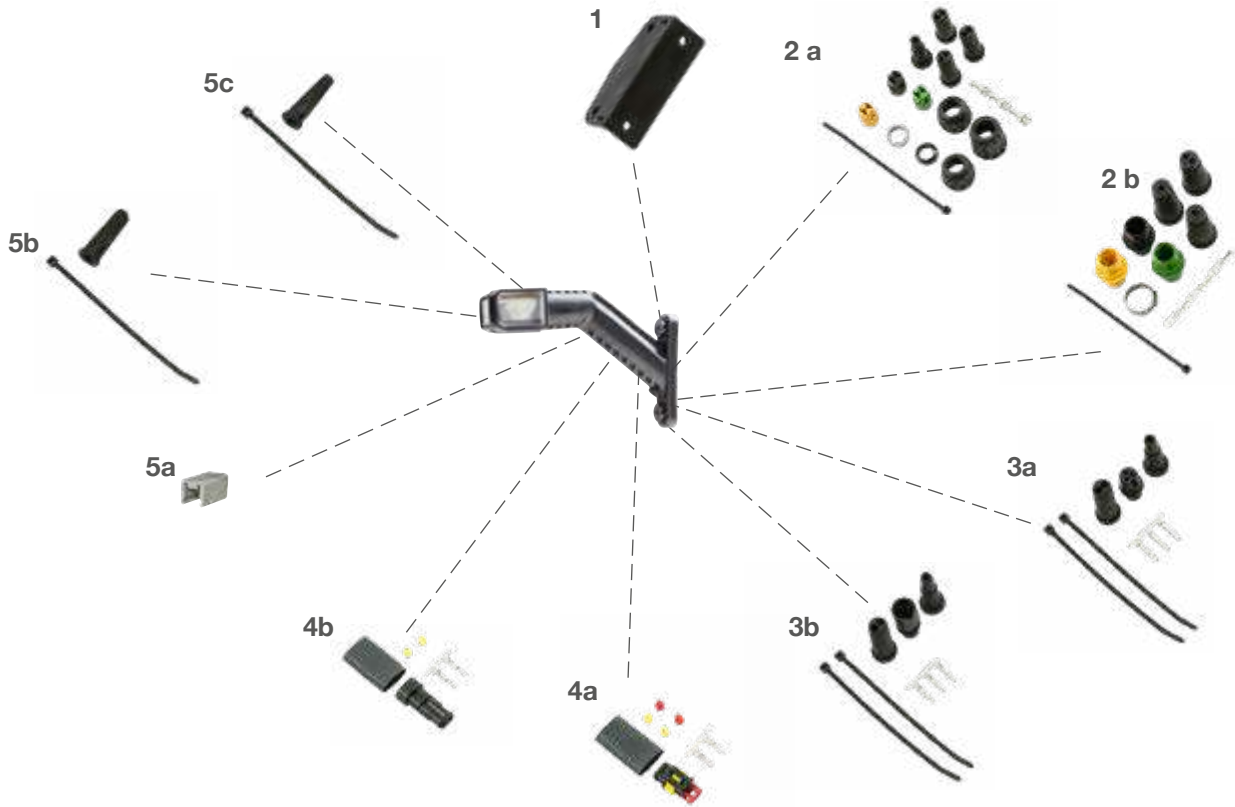

**1** Befestigungswinkel für Leuchtarm |  
angle bracket for end outline marker  
..... 15-5313-004

**2** ASS1 & ASS2 Verbinder |  
ASS1 & ASS2 connector  
(a) 2 pol. weiblich  
2 pin female ..... 13-5626-401   
(b) 2 pol. männlich  
2 pin male ..... 13-5625-991

**3** ASS3 Verbinder |  
ASS3 connector  
(a) 3 pol. weiblich  
3 pin female ..... 13-0322-281   
(b) 3 pol. männlich  
3 pin male ..... 13-0332-281

**4** Superseal Verbinder | Superseal connector  
(a) 2 pol. weiblich  
2 pin female ..... 15-7002-044   
(b) 2 pol. männlich  
2 pin male ..... 15-7002-054

**5** für P&R Verbinder |  
for P&R connector  
(a) Verschlusskappen  
caps ..... 15-5971-014   
(b) Endkappen rund  
end caps round ..... 15-5983-024   
(c) Endkappen eckig  
end caps square ..... 15-5729-014

THE ART OF LIGHTS

# ECOLED II

VARIANTE  
VERSION

# TRAILER

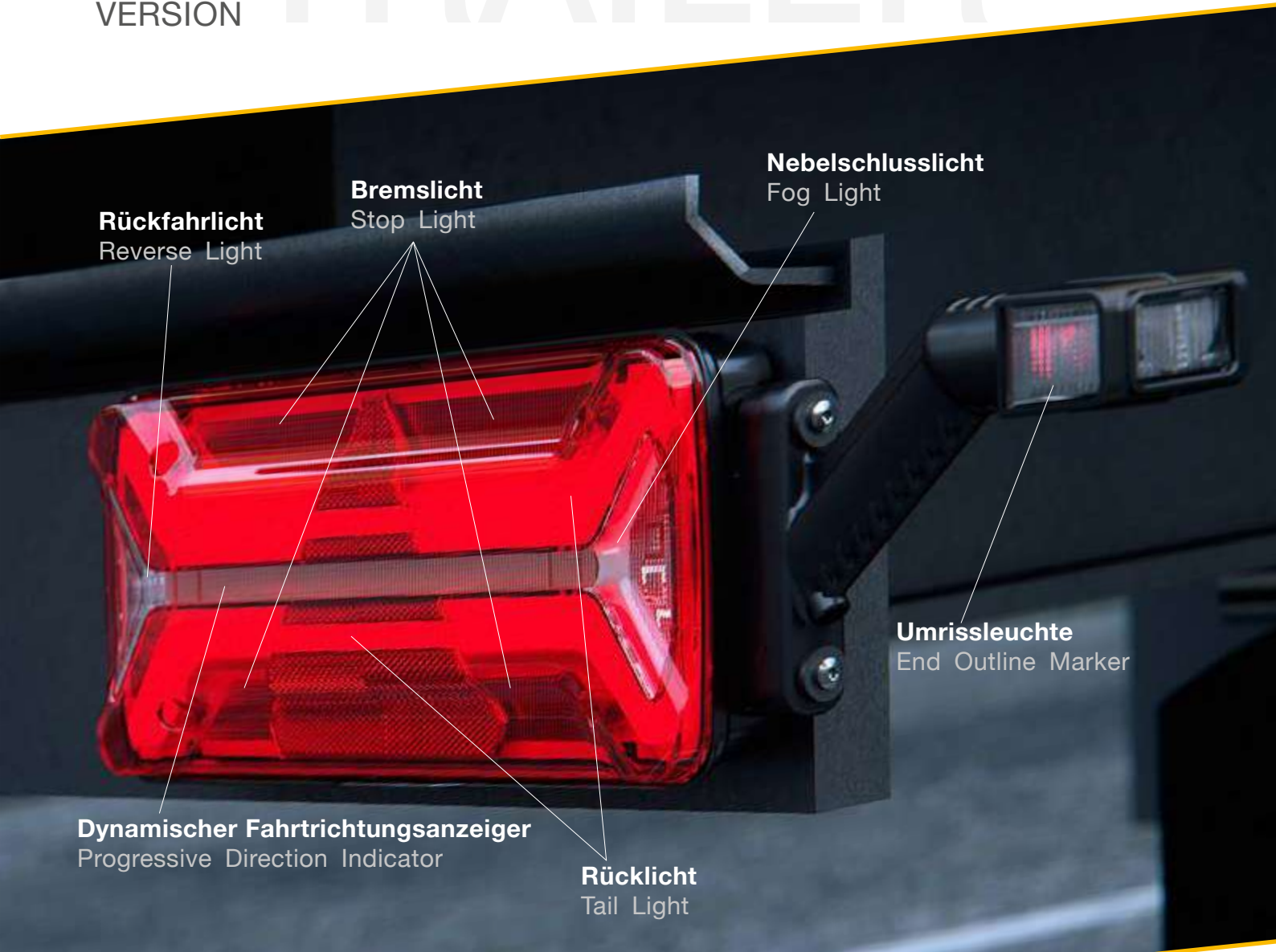

**Rückfahrlicht**  
Reverse Light

**Bremslicht**  
Stop Light

**Nebelschlusslicht**  
Fog Light

**Dynamischer Fahrtrichtungsanzeiger**  
Progressive Direction Indicator

**Rücklicht**  
Tail Light

**Umrissleuchte**  
End Outline Marker

ECOLEDII ECOLEDII ITGLOWs ITGLOWs TURNIT TURNIT ITS SAFE ITS SAFE SWITCHIT SWITCHIT SWITC ITGLOWs TURNIT ITS SAFE ECOLED



# SUPERPOINT III LED





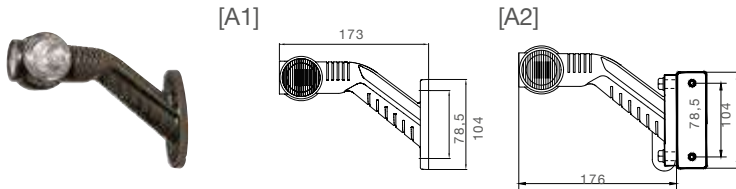



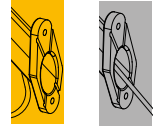









































































































ADR  
Zone 2

IP 69K



 Umrissleuchte  
End outline marker



BEST. NR						ZUSATZ	ANSCHLUSS		
PART NO						ADD ON	CONNECTOR		
31-3365-094	1/-	●		LED	24V	[A2]   	2 pol. ASS2 2 pin ASS2	♀   	1,50 m 
31-3366-094	1/-		●	LED	24V	[A2]   	2 pol. ASS2 2 pin ASS2	♀   	1,50 m 
31-3300-074	1/-	●	●	LED	24V	[A1]   	offenes Ende open end		4,00 m 
31-3302-054	1/-	●		LED	24V	[A1]   	2 pol. Superseal 2 pin Superseal	♀   	0,50 m 
31-3303-054	1/-		●	LED	24V	[A1]   	2 pol. Superseal 2 pin Superseal	♀   	0,50 m 
31-3304-044	1/-	●		LED	24V	[A1]   	P&R	 	1,25 m 
31-3304-054	1/-		●	LED	24V	[A1]   	P&R	 	1,25 m 
31-3304-114	1/-		●	LED	24V	[A1]   	P&R	 	1,25 m 
31-3304-124	1/-	●		LED	24V	[A1]   	P&R	 	1,25 m 
31-3304-134	1/-		●	LED	24V	[A1]   	P&R	 	1,75 m 
31-3304-144	1/-	●		LED	24V	[A1]   	P&R	 	1,75 m 
31-3305-014	1/-	●		LED	24V	[A1]   	2 pol. ASS2 2 pin ASS2	♀   	1,75 m 
31-3305-044	1/-	●		LED	24V	[A1]   	2 pol. ASS2 2 pin ASS2	♀   	2,00 m 
31-3305-124	1/-	●		LED	24V	[A1]   	3 pol. ASS3 3 pin ASS3	♀   	1,25 m 
31-3305-214	1/-	●		LED	24V	[A1]   	2 pol. ASS2 2 pin ASS2	♀   	0,50 m 
31-3305-294	1/-	●		LED	24V	[A1]   	2 pol. Superseal 2 pin Superseal	♂   	0,50 m 
31-3306-014	1/-		●	LED	24V	[A1]   	2 pol. ASS2 2 pin ASS2	♀   	1,50 m 



# SUPERPOINT III LED

ADR Zone 2 IP 69K



Umrissleuchte  
End outline marker

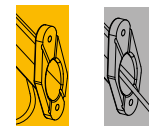

BEST. NR						ZUSATZ				ANSCHLUSS					
PART NO						ADD ON				CONNECTOR					
31-3306-044	1/-		●	LED	24V	[A1]				2 pol. ASS2 2 pin ASS2	♀			2,00 m	
31-3306-124	1/-		●	LED	24V	[A1]				3 pol. ASS3 3 pin ASS3	♀			1,25 m	
31-3306-214	1/-		●	LED	24V	[A1]				2 pol. ASS2 2 pin ASS2	♀			0,50 m	
31-3306-294	1/-		●	LED	24V	[A1]				2 pol. Superseal 2 pin Superseal	♂			0,50 m	
31-3362-004	1/-		●	LED	24V	[B]				2 pol. Superseal 2 pin Superseal	♀			0,25 m	
31-3362-104	1/-		●	LED	24V	[B]				2 pol. Superseal 2 pin Superseal	♂			1,50 m	
31-3363-004	1/-	●		LED	24V	[B]				2 pol. Superseal 2 pin Superseal	♀			0,25 m	
31-3363-104	1/-	●		LED	24V	[B]				2 pol. Superseal 2 pin Superseal	♂			1,50 m	
31-3364-024	1/-		●	LED	24V	[B]				P&R				1,50 m	
31-3364-054	1/-	●		LED	24V	[B]				P&R				1,50 m	
31-3365-014	1/-	●		LED	24V	[B]				offenes Ende open end				4,00 m	
31-3365-054	1/-	●		LED	24V	[B]				2 pol. ASS2 2 pin ASS2	♀			0,25 m	
31-3365-064	1/-	●		LED	24V	[B]				3 pol. ASS3 3 pin ASS3	♀			1,50 m	
31-3366-024	1/-		●	LED	24V	[B]				offenes Ende open end				4,00 m	
31-3366-054	1/-		●	LED	24V	[B]				2 pol. ASS2 2 pin ASS2	♀			0,25 m	
31-3366-064	1/-		●	LED	24V	[B]				3 pol. ASS3 3 pin ASS3	♀			1,50 m	
31-3305-084	1/-	●		LED	24V	[C]				Europoint II				0,04 m	
31-3306-084	1/-		●	LED	24V	[C]				offenes Ende open end				0,04 m	



# SUPERPOINT III LED

ADR Zone 2 IP 69K

[D]

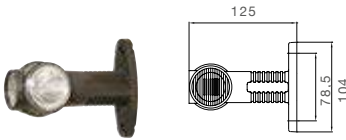

[E]

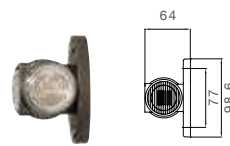

Umrissleuchte  
End outline marker

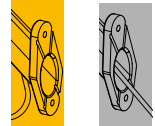

BEST. NR						ZUSATZ				ANSCHLUSS		
PART NO				LED	24V	ADD ON				CONNECTOR		
31-3300-244	1/-	●	●	LED	24V	[D]				offenes Ende open end	4,00 m	
31-3302-064	1/-		●	LED	24V	[D]				2 pol. Superseal 2 pin Superseal	♀	0,50 m
31-3303-064	1/-	●		LED	24V	[D]				2 pol. Superseal 2 pin Superseal	♀	0,50 m
31-3304-094	1/-	●	●	LED	24V	[D]				P&R		1,25 m
31-3305-194	1/-	●		LED	24V	[D]				2 pol. ASS2 2 pin ASS2	♀	2,00 m
31-3306-194	1/-		●	LED	24V	[D]				2 pol. ASS2 2 pin ASS2	♀	2,00 m
31-3307-014	1/-	●	●	LED	24V	[D]				2 pol. ASS2 2 pin ASS2	♀	1,75 m
31-3307-024	1/-	●	●	LED	24V	[D]				3 pol. ASS3 3 pin ASS3	♀	1,75 m
31-3307-104	1/-	●	●	LED	24V	[D]				2 pol. ASS2 2 pin ASS2	♀	2,50 m
31-3307-194	1/-	●	●	LED	24V	[D]				2 pol. Superseal 2 pin Superseal	♂	2,00 m
31-3300-374	1/-	●	●	LED	24V	[E]				2 pol. Superseal 2 pin Superseal	♀	3,00 m
31-3307-044	1/-	●	●	LED	24V	[E]				2 pol. ASS2 2 pin ASS2	♀	1,50 m
31-3307-134	1/-	●	●	LED	24V	[E]				2 pol. ASS2 2 pin ASS2	♀	3,00 m
31-3307-224	1/-	●	●	LED	24V	[E]				3 pol. ASS3 3 pin ASS3	♀	0,50 m
31-3360-004	1/-	●	●	LED	24V	[E]				offenes Ende open end	4,00 m	
31-3364-004	1/-	●	●	LED	24V	[E]				P&R		1,50 m
31-3367-004	1/-	●	●	LED	24V	[E]				2 pol. ASS2 2 pin ASS2	♀	0,50 m





# SUPERPOINT III LED

ZUBEHÖR / ACCESSORIES

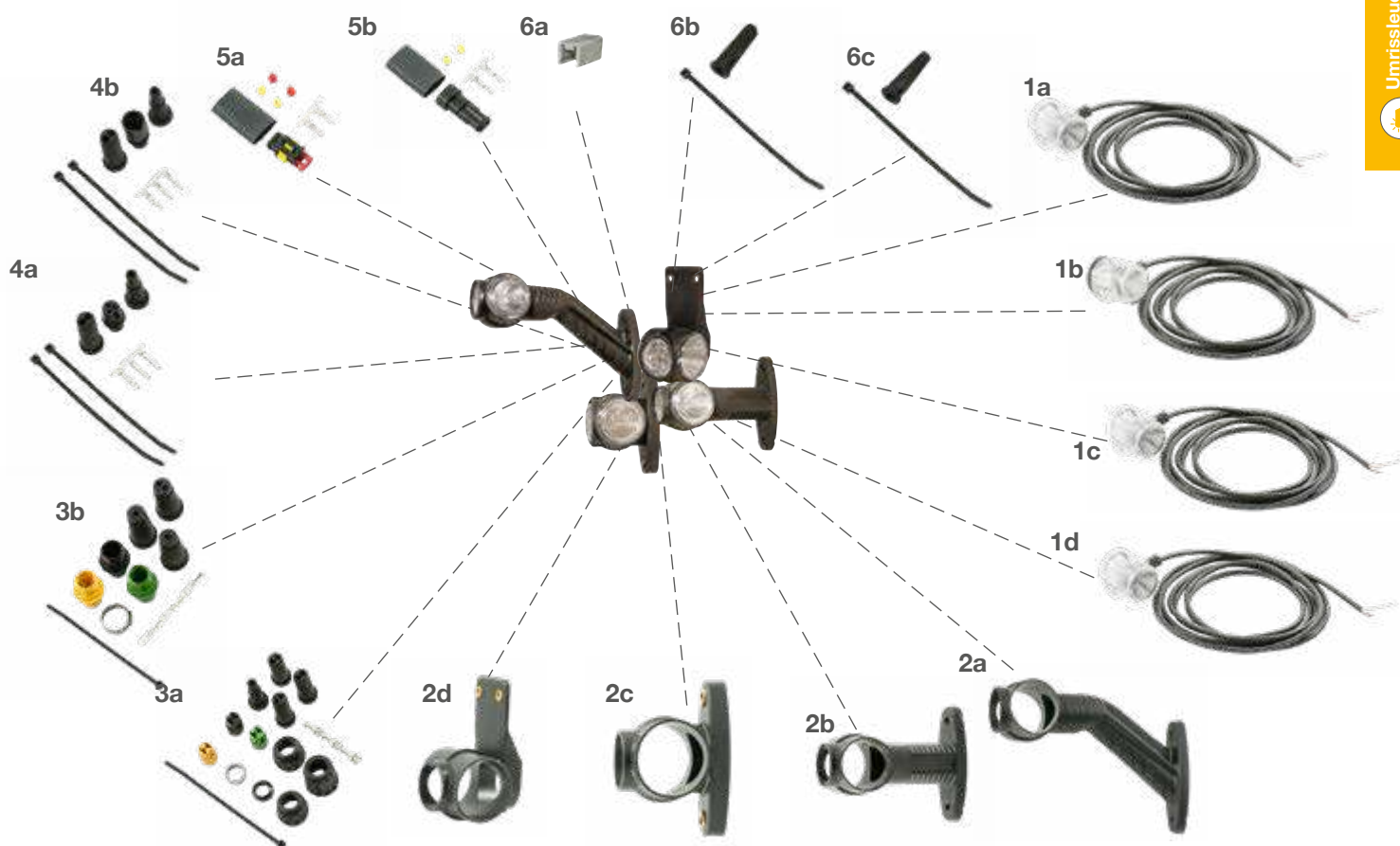

## 1 Lichtscheibe | lens

- (a) rot/weiß/orange mit 4,00 m Kabel  
red/white/orange with 4,00 m cable ..... 21-3351-704
- (b) schwarz/weiß/orange mit 4,00 m Kabel  
black/white/orange with 4,00 m cable ..... 21-3350-704
- (c) rot/weiß/orange mit 1,50 m Kabel  
red/white/orange with 1,50 m cable ..... 21-3353-704
- (d) rot/weiß/orange mit 3,00 m Kabel  
red/white/orange with 3,00 m cable ..... 21-3354-704

## 2 Umrißarm | end outline marker

- (a) Standard  
Standard..... 21-3300-007
- (b) gerade  
straight ..... 21-3302-007
- (c) Direktanbau  
direct mounting ..... 15-5325-004
- (d) mit Pendelhalter  
with pendular bracket.. 15-5325-101

## 3 ASS1 & ASS2 Verbinder | ASS1 & ASS2 connector

- (a) 2 pol. weiblich  
2 pin female ..... 13-5626-401
- (b) 2 pol. männlich  
2 pin male ..... 13-5625-991

## 4 ASS3 Verbinder | ASS3 connector

- (a) 3 pol. weiblich  
3 pin female ..... 13-0322-281
- (b) 3 pol. männlich  
3 pin male ..... 13-0332-281

## 5 Superseal Verbinder | Superseal connector

- (a) 2 pol. weiblich  
2 pin female ..... 15-7002-044
- (b) 2 pol. männlich  
2 pin male ..... 15-7002-054

## 6 für P&R Verbinder | for P&R connector

- (a) Verschlusskappen  
caps..... 15-5971-014
- (b) Endkappen rund  
end caps round..... 15-5983-024
- (c) Endkappen eckig  
end caps square..... 15-5729-014



# SUPERPOINT II

ADR  
Zone 2

IP 68

[A1]



[A2]

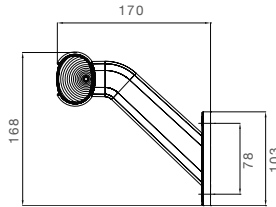

[B]

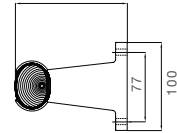

Umrissleuchte  
End outline marker



BEST. NR	PART NO		←	→			ZUSATZ	ANSCHLUSS
							ADD ON	CONNECTOR
31-3404-014	1/-	●			24V	[A1]		P&R  1,25 m
31-3404-104	-/-	●			24V	[A1]		P&R  1,80 m
31-3404-124	1/-	●			24V	[A1]		P&R  1,25 m
31-3404-364	-/-	●			24V	[A2]		P&R  1,80 m
31-3405-004	1/-	●			24V	[A1]		2 pol. ASS2 2 pin ASS2 ♀  1,75 m
31-3405-074	-/-	●			24V	[A1]		3 pol. ASS3 3 pin ASS3 ♀  1,25 m
31-3407-114	1/-	●			24V	[A1]		2 pol. ASS2 2 pin ASS2 ♀  0,50 m
31-3404-004	1/-		●		24V	[A1]		P&R  1,25 m
31-3404-064	1/-		●		24V	[A1]		P&R  1,80 m
31-3404-114	-/-		●		24V	[A1]		P&R  1,80 m
31-3404-134	1/-		●		24V	[A1]		P&R  1,30 m
31-3406-004	1/-		●		24V	[A1]		2 pol. ASS2 2 pin ASS2 ♀  1,75 m
31-3406-064	-/-		●		24V	[A1]		3 pol. ASS3 3 pin ASS3 ♀  1,25 m
31-3407-104	1/-		●		24V	[A1]		2 pol. ASS2 2 pin ASS2 ♀  0,50 m
31-3704-004	1/-	●	●		24V	[B]		P&R  0,50 m
31-3704-014	1/-	●	●		24V	[B]		P&R  1,50 m
31-3707-024	1/-	●	●		24V	[B]		2 pol. ASS2 2 pin ASS2 ♀  1,75 m
31-3707-105	1/-	●			24V	[B]		2 pol. ASS2 2 pin ASS2 ♀  2,00 m



# SUPERPOINT II

ADR Zone 2

IP 68

Umrissleuchte  
End Outline Marker

[C]

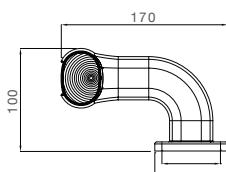

[D]

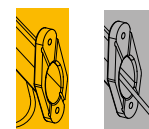
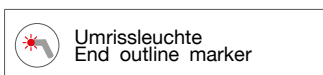
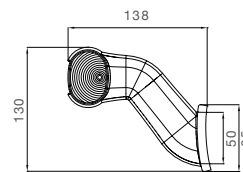

BEST. NR						ZUSATZ			ANSCHLUSS						
PART NO		←	→		V	ADD ON			CONNECTOR						
31-3707-144	1/-	●		💡	24V	[B]				2 pol. ASS2	♀			0,50 m	
31-3793-004	-/-	●		💡	24V	[B]				2 pol. Superseal	♀			0,50 m	
31-3707-095	-/-		●	💡	24V	[B]				2 pol. ASS2	♀			2,00 m	
31-3707-134	1/-		●	💡	24V	[B]				2 pol. ASS2	♀			0,50 m	
31-3792-004	-/-		●	💡	24V	[B]				2 pol. Superseal	♀			0,50 m	
31-3804-014	1/-	●		💡	24V	[C]				P&R				1,40 m	
31-3805-004	1/-	●		💡	24V	[C]				2 pol. ASS2	♀			1,75 m	
31-3805-024	-/-	●		💡	24V	[C]				2 pol. ASS3	♀			1,75 m	
31-3804-004	1/-		●	💡	24V	[C]				P&R				1,40 m	
31-3806-004	1/-		●	💡	24V	[C]				2 pol. ASS2	♀			1,75 m	
31-3806-024	-/-		●	💡	24V	[C]				2 pol. ASS3	♀			1,75 m	
31-3604-044	1/-		●	💡	24V	[D]				P&R				1,40 m	
31-3606-004	1/-		●	💡	24V	[D]				2 pol. ASS2	♀			1,75 m	
31-3608-004	1/-		●	💡	24V	[D]				offenes Ende				0,45 m	
31-3604-054	1/-	●		💡	24V	[D]				P&R				1,40 m	
31-3605-004	1/-	●		💡	24V	[D]				2 pol. ASS2	♀			1,70 m	
31-3608-014	1/-	●		💡	24V	[D]				offenes Ende				0,45 m	



# SUPERPOINT II

ZUBEHÖR / ACCESSORIES

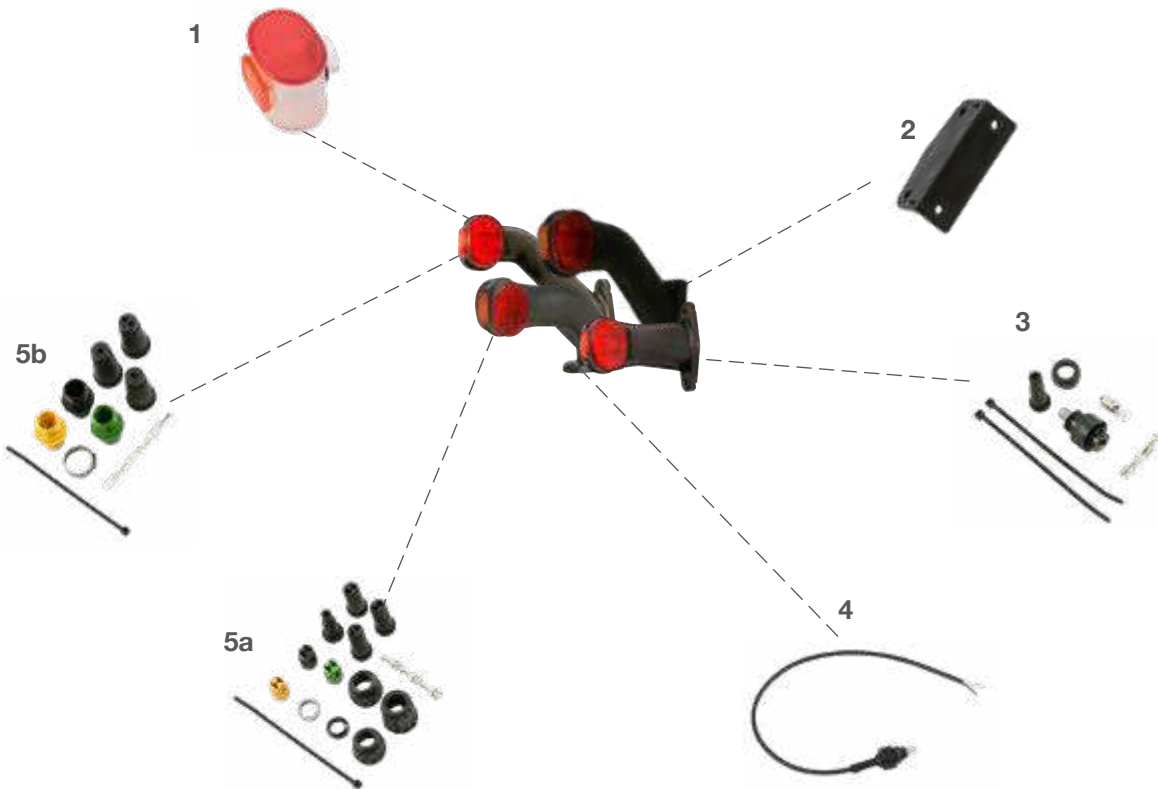

**1** Lichtscheibe | lens  
rot/weiß/orange  
red/white/orange  
..... 18-8136-004

**2** Befestigungswinkel für Leuchtarm |  
angle bracket for end outline marker  
..... 15-5313-004

**3** gerade Anschluss | straight connector  
..... 15-2128-544

**4** Glühlampenanschluss | bulb connection  
inkl. Glühlampe und 0,5 m Kabel  
including bulb and 0,5 m cable  
..... 31-2800-004

**5** ASS1 & ASS2 Verbinder |  
ASS1 & ASS2 connector  
(a) 2 pol. weiblich  
2 pin female ..... 13-5626-401   
(b) 2 pol. männlich  
2 pin male ..... 13-5625-991



## SUPERPOINT II

ZUBEHÖR / ACCESSORIES

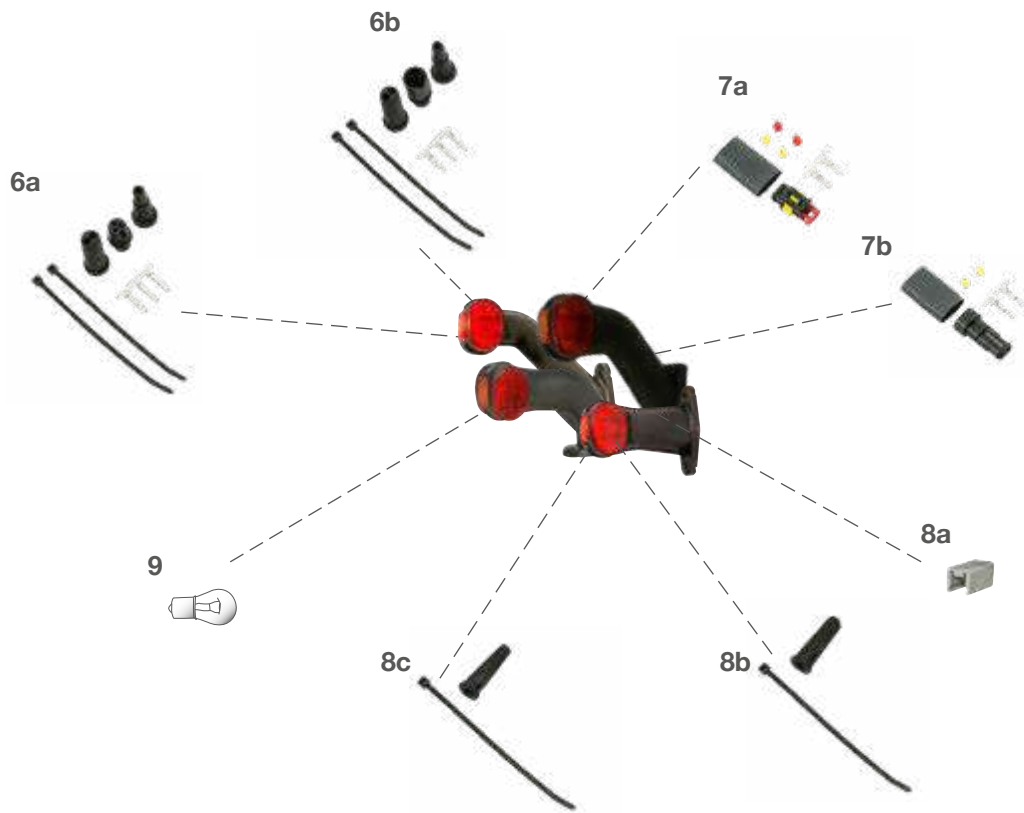

### 6 ASS3 Verbinder | ASS3 connector

- (a) 3 pol. weiblich  
3 pin female ..... 13-0322-281 
- (b) 3 pol. männlich  
3 pin male ..... 13-0332-281 

### 7 Superseal Verbinder | Superseal connector

- (a) 2 pol. weiblich  
2 pin female ..... 15-7002-044 
- (b) 2 pol. männlich  
2 pin male ..... 15-7002-054 

### 8 für P&R Verbinder | for P&R connector

- (a) Verschlusskappen  
caps ..... 15-5971-014 
- (b) Endkappen rund  
end caps round ..... 15-5983-024 
- (c) Endkappen eckig  
end caps square ..... 15-5729-014 

### 9 Glühlampe | bulb

- 24V 4W ..... 16-6304-027 

SPÖCK®

S T E M S



ERSATZTEILE | SPARE PARTS

## POSITIONSLEUCHE

Die Positionsleuchten von Aspöck erfüllen, je nach Farbwahl der Lichtscheibe unterschiedliche Funktionen. Diese Leuchten im einheitlichen Design können entweder direkt oder mit Halter montiert werden und zeichnen sich durch universelle Anschlüsse aus.

## POSITION LAMP

Depending on the selected colour of lens, the position lights by Aspöck have different functions. These lamps in uniform design can either be directly attached or attached with a bracket, and are characterised by their universal connections.

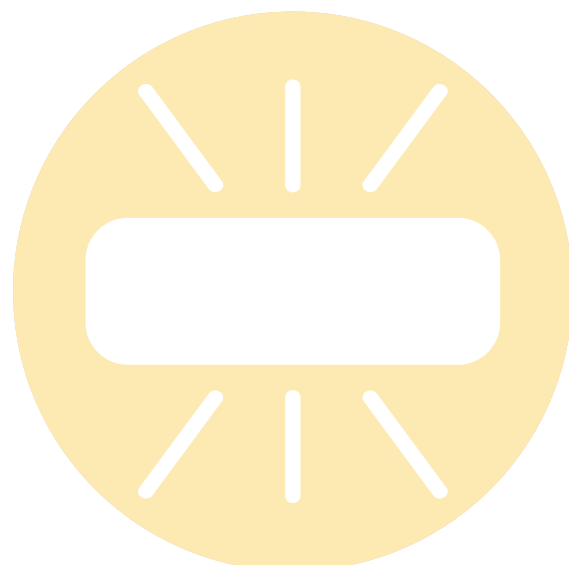



# FLATPOINT II LED

ADR Zone 2 IP 69K

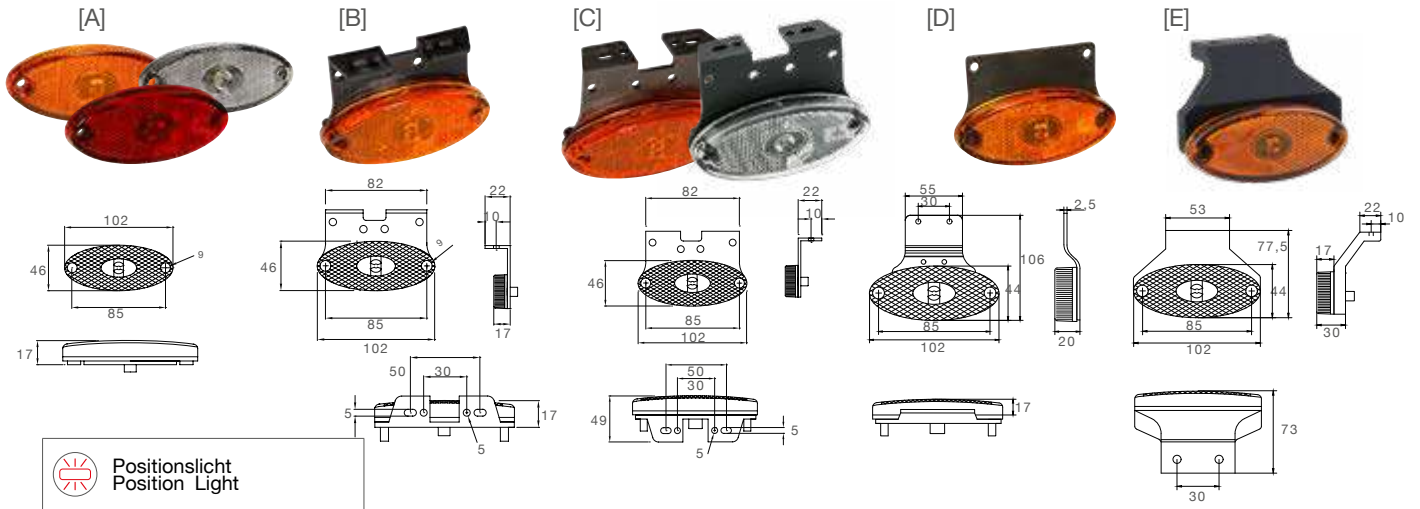

BEST. NR				ZUSATZ	ANSCHLUSS		
PART NO				ADD ON	CONNECTOR		
31-2304-014	1/-	LED	24V	[A] Bild	P&R		0,50 m
31-2304-034	1/-	LED	24V	[A] Bild	P&R		1,50 m
31-2304-044	1/-	LED	24V	[A] Bild	P&R		2,00 m
31-2304-094	1/-	LED	12V 24V	[A] Bild	P&R		1,50 m
31-2304-104	-/-	LED	12V 24V	[A] Bild	P&R		0,50 m
31-2307-004	-/-	LED	24V	[A] Bild	2 pol. ASS3 2 pin ASS3		0,50 m
31-2307-014	-/-	LED	24V	[A] Bild	2 pol. ASS3 2 pin ASS3		1,50 m
31-2307-034	-/-	LED	24V	[A] Bild	2 pol. ASS3 2 pin ASS3		1,00 m
31-2364-014	1/-	LED	24V	[B] Bild	P&R		0,50 m
31-2364-034	1/-	LED	24V	[B] Bild	P&R		1,50 m
31-2364-084	1/-	LED	24V	[C] Bild	P&R		0,50 m
31-2364-104	1/-	LED	24V	[C] Bild	P&R		1,50 m
31-2364-114	1/-	LED	24V	[C] Bild	P&R		2,00 m
31-2364-134	-/-	LED	24V	[D] Bild	P&R		0,25 m
31-2364-284	-/-	LED	24V	[D] Bild	P&R		1,50 m
31-2364-184	1/-	LED	24V	[E] Bild	P&R		1,50 m
31-2364-304	1/-	LED	24V	[F] Bild	P&R		0,25 m





# FLATPOINT II LED

ADR Zone 2 IP 69K

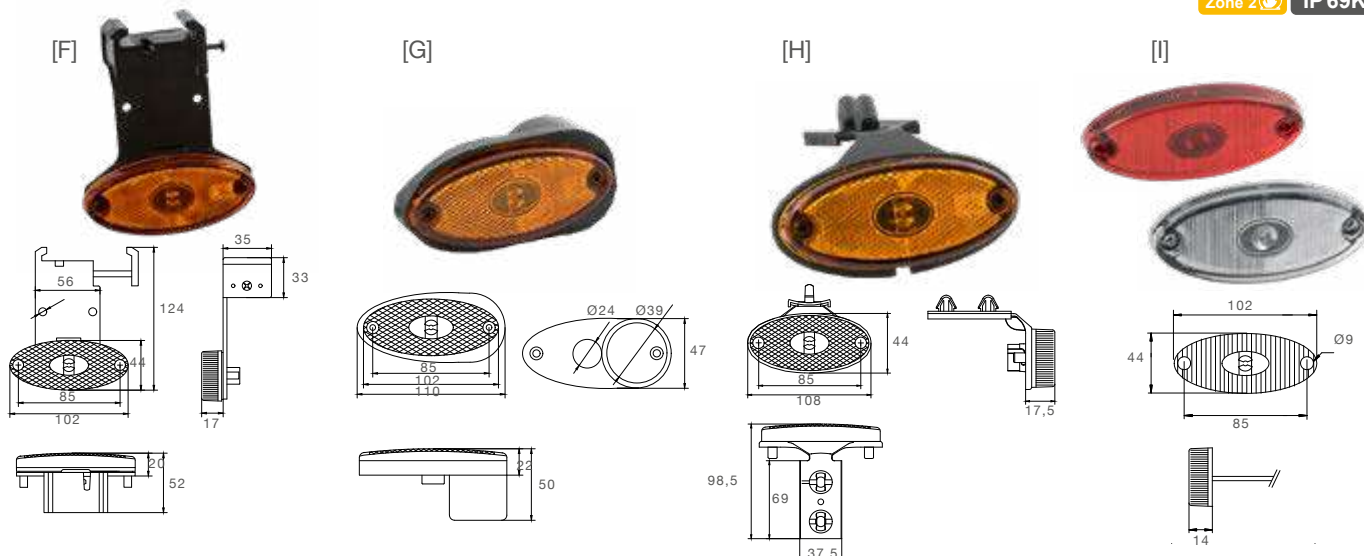

Positionslampe  
Position Lamp

BEST. NR				ZUSATZ	ANSCHLUSS
PART NO				ADD ON	CONNECTOR
31-2364-324	1/-	LED	24V	[G] Bild	P&R  2,00 m
31-2364-334	1/-	LED	24V	[H] Bild	P&R  1,50 m
31-2364-344	1/-	LED	24V	[H] Bild	P&R  1,00 m
31-2364-354	-/-	LED	24V	[H] Bild	P&R  2,00 m
31-2367-034	1/-	LED	24V	[C] Bild	2 pol. ASS3  1,50 m 2 pin ASS3
31-2367-054	-/-	LED	24V	[B] Bild	2 pol. ASS3  1,50 m 2 pin ASS3
31-2367-064	-/-	LED	24V	[H] Bild	2 pol. ASS3  1,50 m 2 pin ASS3
31-6900-014	1/-	LED	24V	[A] Bild	offenes Ende open end 0,50 m
31-6904-014	1/-	LED	24V	[A] Bild	P&R  0,50 m
31-6904-034	1/-	LED	24V	[A] Bild	P&R  1,50 m
31-6904-054	1/-	LED	24V	[A] Bild	P&R  3,50 m
31-6904-124	1/-	LED	24V	[I] Bild	P&R  3,50 m
31-6904-164	-/-	LED	12V 24V	[A] Bild	P&R  1,50 m
31-6907-034	-/-	LED	24V	[A] Bild	2 pol. ASS3  1,50 m 2 pin ASS3
31-6964-004	-/-	LED	24V	[C] Bild	P&R  1,50 m
31-6404-014	1/-	LED	24V	[A] Bild	P&R  0,50 m
31-6404-094	1/-	LED	24V	[I] Bild	P&R  0,50 m
31-6404-124	1/-	LED	24V	[I] Bild	P&R  3,50 m



# FLATPOINT II LED

ZUBEHÖR / ACCESSORIES

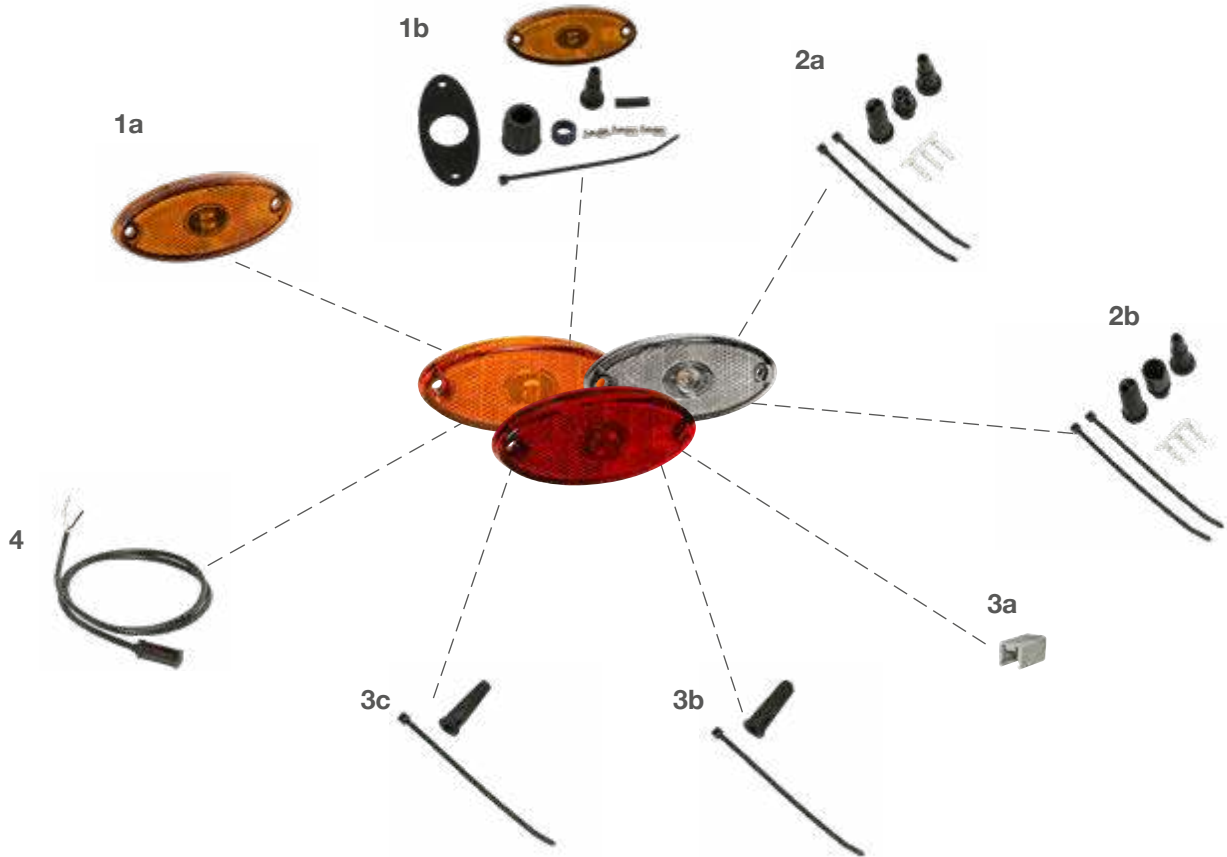

## 1 Ersatzleuchte orange | spare part lamp orange

- (a) lose  
loose..... 21-2303-004
- (b) mit Bajonett- Mutter  
with bayonet-nut ..... 21-2302-004 

## 2 ASS3 Verbinder | ASS3 connector

- (a) 3 pol. weiblich  
3 pin female ..... 13-0322-281 
- (b) 3 pol. männlich  
3 pin male ..... 13-0332-281 

## 3 für P&R Verbinder | for P&R connector

- (a) Verschlusskappen  
caps..... 15-5971-014 
- (b) Endkappen rund  
end caps round..... 15-5983-024 
- (c) Endkappen eckig  
end caps square..... 15-5729-014 

## 4 Anschlusskabel P&R | connection cable P&R

- 0,5 m..... 68-5000-014 
- 1,5 m..... 68-5000-034 





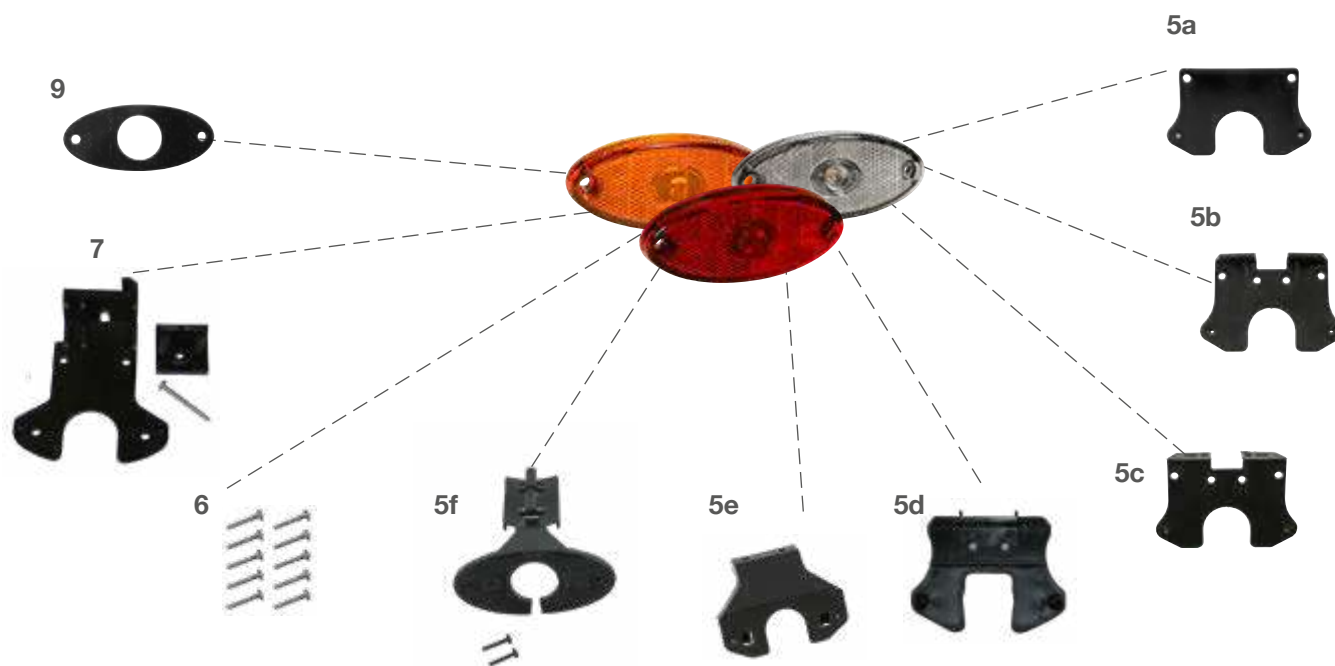

# FLATPOINT II LED

ZUBEHÖR / ACCESSORIES



## 5 Haltewinkel | bracket

- (a) gerade  
straight ..... 15-5321-004
- (b) 90° nach vorne  
90° to the front ..... 15-5321-104 
- (c) 90° nach hinten  
90° to the back ..... 15-5321-204 
- (d) 90° durchgehend nach hinten  
90° continuous to the back  
..... 15-5321-404
- (e) schräg 90° nach hinten  
sloping 90° to the back  
..... 15-2128-214 
- (f) Schnellhalter + Schrauben  
quick-fixation bracket + screws  
..... 15-5321-234 

## 6 Schrauben für Haltewinkel 10 screws for bracket

..... 14-0418-304

## 7 Verriegelungswinkel | locking bracket

Verriegelungswinkel  
locking angle  
..... 15-5322-004 

## 9 Gummiunterlage | rubber base

..... 15-5111-004





# FLATPOINT I LED

ADR Zone 2

IP 68

[A]

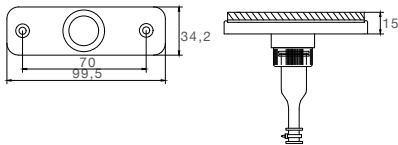

[B]

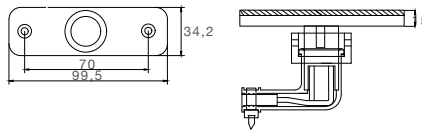

[C]

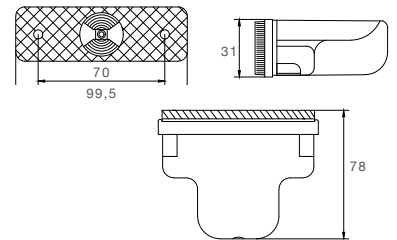

BEST. NR PART NO				ZUSATZ ADD ON	ANSCHLUSS CONNECTOR
31-6604-014	1/-	LED	24V	[A] Bild	P&R  0,50 m
31-6604-034	1/-	LED	24V	[A]	P&R  1,50 m
31-6604-074	1/-	LED	24V	[B] Bild	P&R  0,50 m
31-6604-094	1/-	LED	24V	[B]	P&R  1,50 m
31-6604-114	-/-	LED	24V	[B]	P&R  3,50 m
31-6607-004	-/-	LED	24V	[B] Bild	2 pol. ASS2 2 pin ASS2    1,50 m
31-6607-054	-/-	LED	24V	[A] Bild	2 pol. ASS3 2 pin ASS3    1,50 m
31-6614-014	1/-	LED	24V	[C] Bild    Schutzhaube protection cap	P&R  0,50 m
31-6614-034	1/-	LED	24V	[C]    Schutzhaube protection cap	P&R  1,50 m
31-6614-074	1/-	LED	24V	[D] Bild    Schutzhaube protection cap	P&R  0,50 m
31-6614-094	1/-	LED	24V	[D]    Schutzhaube protection cap	P&R  1,50 m
31-6664-014	1/-	LED	24V	[E] Bild    Schutzhaube protection cap	P&R  0,50 m
31-6664-031	1/-	LED	24V	[E]    Schutzhaube protection cap	P&R  1,50 m
31-6667-014	-/-	LED	24V	[D] Bild    Schutzhaube protection cap	2 pol. ASS3 2 pin ASS3    0,50 m



# FLATPOINT I LED

ADR Zone 2

IP 68

[D]

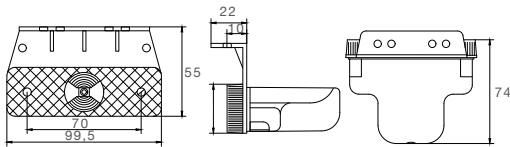

[E]

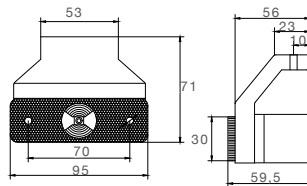

[F]

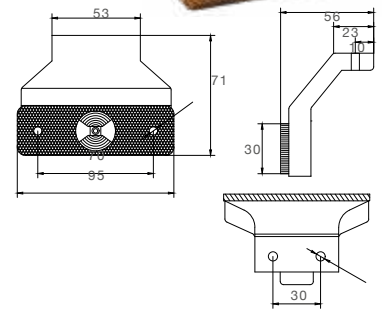

Seitenmarkierungslicht  
Sidemarker light

BEST. NR PART NO				ZUSATZ ADD ON	ANSCHLUSS CONNECTOR
31-2204-014	1/-	LED	24V	[A] Bild	P&R  0,50 m
31-2214-004	1/-	LED	24V	[D] Bild    Schutzhaube protection cap	P&R  0,25 m
31-2214-014	1/-	LED	24V	[D]    Schutzhaube protection cap	P&R  0,50 m
31-2214-024	1/-	LED	24V	[D]    Schutzhaube protection cap	P&R  1,00 m
31-2214-034	1/-	LED	24V	[D]    Schutzhaube protection cap	P&R  1,50 m
31-2214-114	1/-	LED	24V	[C]    Schutzhaube protection cap	P&R  0,50 m
31-2214-134	1/-	LED	24V	[C]    Schutzhaube protection cap	P&R  1,50 m
31-2264-014	1/-	LED	24V	[F] Bild	P&R  0,50 m
31-2264-024	1/-	LED	24V	[F]	P&R  1,00 m
31-2264-034	1/-	LED	24V	[F]	P&R  1,50 m
31-2267-014	1/-	LED	24V	[E] Bild    Schutzhaube protection cap	2 pol. ASS2 ♀  1,00 m
31-2267-064	-/-	LED	24V	[C] Bild    Schutzhaube protection cap	3 pol. ASS3 ♀  1,50 m
31-2267-074	-/-	LED	24V	[D] Bild    Schutzhaube protection cap	3 pol. ASS3 ♀  1,50 m
31-2267-084	-/-	LED	24V	[E] Bild    Schutzhaube protection cap	3 pol. ASS3 ♀  1,50 m





## FLATPOINT I LED

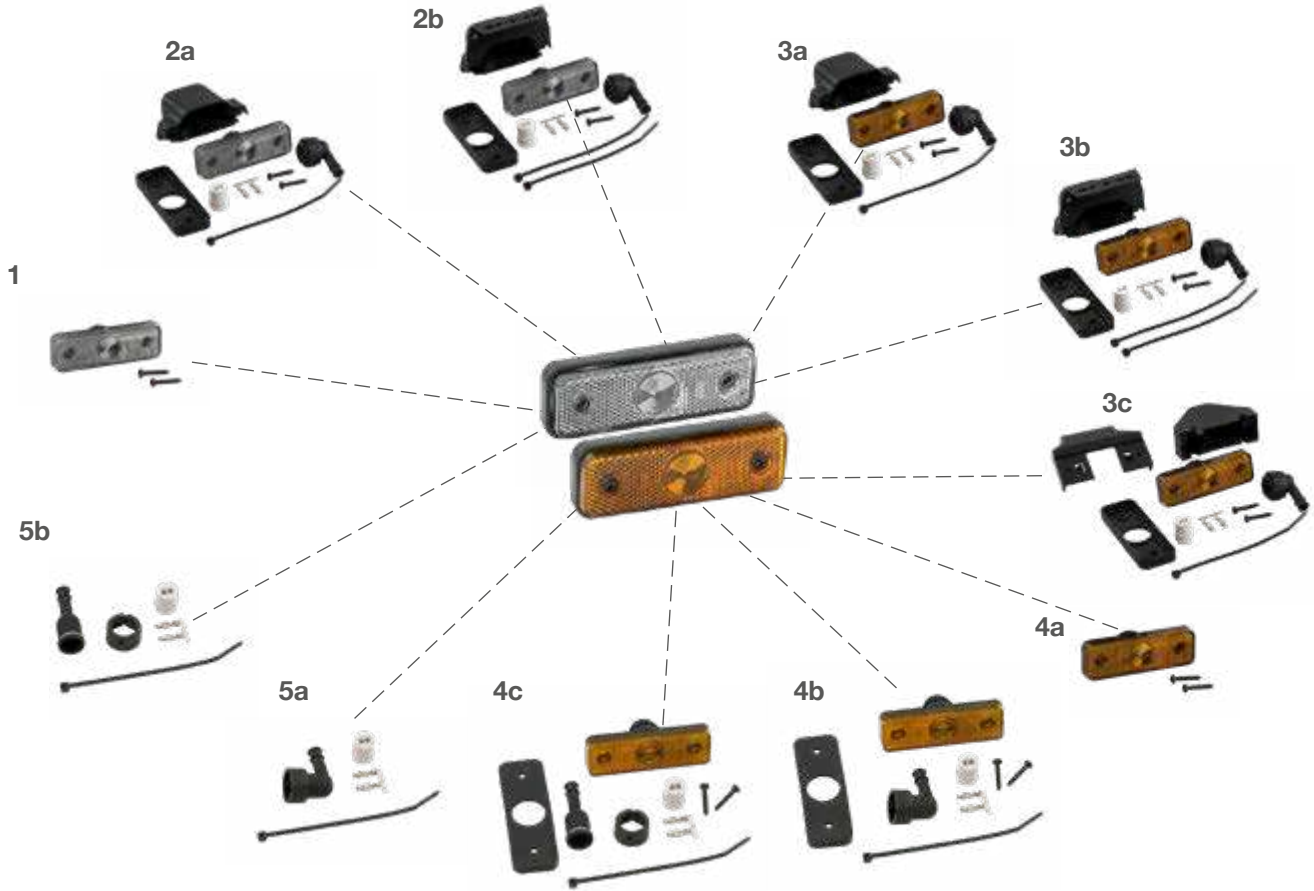

**1** Ersatzleuchte weiß ohne Schutzhaube |  
spare part lamp white without protection cap  
mit Schrauben  
with screws..... 21-6600-014

**2** Ersatzleuchte weiß mit Schutzhaube |  
spare part lamp white with protection cap  
(a) mit 90° Anschluss ohne Haltewinkel  
with 90° connector without bracket  
..... 21-6601-004   
(b) mit 90° Anschluss und 90° Haltewinkel  
with 90° connector and 90° bracket  
..... 21-6600-004

**3** Ersatzleuchte orange mit Schutzhaube |  
spare part lamp orange with protection cap  
(a) mit 90° Anschluss ohne Haltewinkel  
with 90° connector without bracket  
..... 21-2201-004   
(b) mit 90° Anschluss und 90° Haltewinkel  
with 90° connector and 90° bracket  
..... 21-2200-014   
(c) mit 90° Anschluss und 90° Haltewinkel schräg  
with 90° connector and sloping 90° bracket  
..... 21-2202-004

**4** Ersatzleuchte orange ohne Schutzhaube |  
spare part lamp orange without protection cap  
(a) mit Schrauben  
with screws..... 21-2200-004   
(b) mit 90° Anschluss  
with 90° connector  
..... 21-2201-014   
(c) mit geradem Anschluss  
with straight connector  
..... 21-2201-044

**5** Anschluss | connector  
(a) 90° gewinkelt  
angled connection 90°  
..... 15-2122-104   
(b) gerade komplett  
straight bracket complete  
..... 15-2122-124

**6** ASS1 & ASS2 Verbinder |  
ASS1 & ASS2 connector  
(a) 2 pol. männlich  
2 pin male ..... 13-5625-991   
(b) 2 pol. weiblich  
2 pin female ..... 13-5626-401





# FLATPOINT | LED

ZUBEHÖR / ACCESSORIES

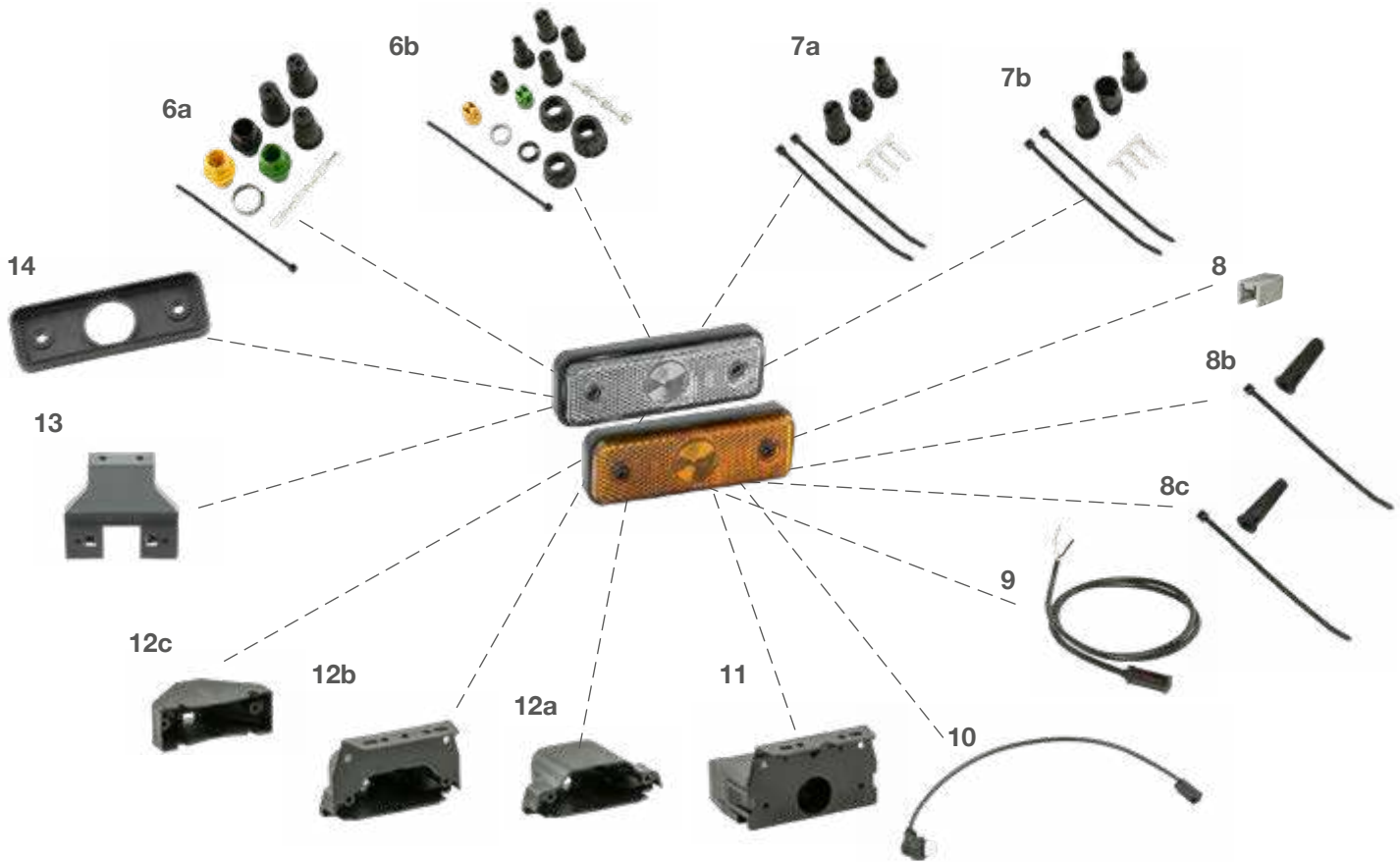

## 7 ASS3 Verbinder | ASS3 connector

- (a) 3 pol. weiblich  
3 pin female ..... 13-0322-281
- (b) 3 pol. männlich  
3 pin male ..... 13-0332-281

## 8 für P&R Verbinder | for P&R connector

- (a) Verschlusskappen  
caps ..... 15-5971-014
- (b) Endkappen rund  
end caps round ..... 15-5983-024
- (c) Endkappen eckig  
end caps square ..... 15-5729-014

## 9 Anschlusskabel P&R | connection cable P&R

- 0,50 m ..... 68-5000-014
- 1,50 m ..... 68-5000-034

## 10 Zuleitung P&R | front connection P&R

- 0,50 m ..... 31-2204-154

## 11 Sockel mit Haltewinkel und Schutzhaube | socket with bracket and protection cap

- ..... 15-2128-274

## 12 Schutzhaube | protection cap

- (a) ohne Haltewinkel  
without bracket ..... 15-2122-164
- (b) mit 90° Haltewinkel  
with 90° bracket ..... 15-2122-174
- (c) für schrägen Haltewinkel  
for sloping bracket ..... 15-2128-094

## 13 Haltewinkel | bracket

- schräg  
sloping ..... 15-2128-144

## 14 Gummiauflage | rubber base

- ..... 11-2128-194





# UNIPOINT II LED

ADR Zone 2 IP 6K9K

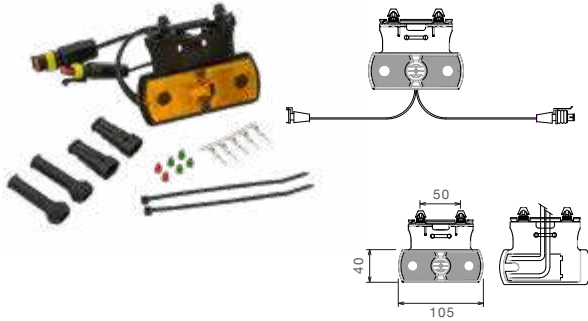

[A]

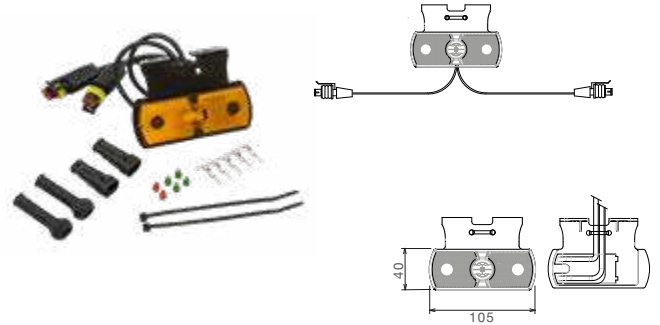

[B]

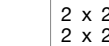
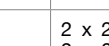

Seitenmarkierungslicht  
Sidemarker light

BEST. NR				ZUSATZ	ANSCHLUSS
PART NO				ADD ON	CONNECTOR
31-2464-024	1/-	LED	24V	[A]  	2 x 2 pol. Superseal 2 x 2 pin Superseal
31-2464-034	1/-	LED	24V	[B]  	2 x 2 pol. Superseal 2 x 2 pin Superseal











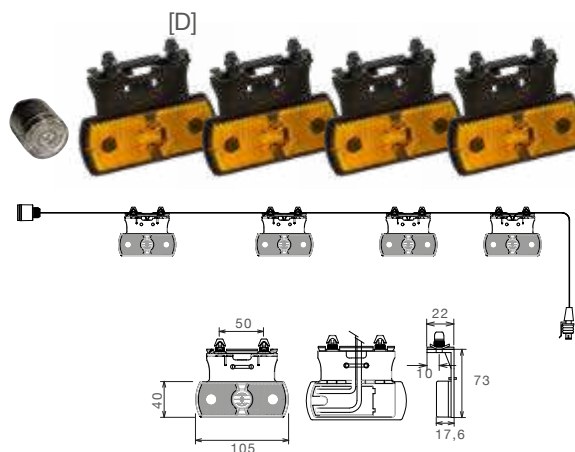
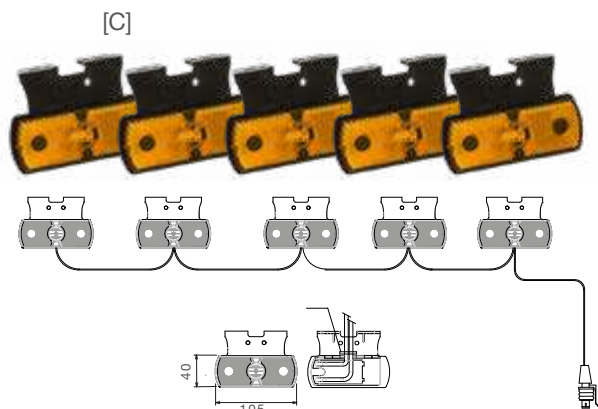









# UNIPOINT II LED

ZUBEHÖR / ACCESSORIES

ADR Zone 2 IP 6K9K



 Seitenmarkierungslicht  
Sidemarker light



BEST. NR PART NO				ZUSATZ ADD ON	ANSCHLUSS CONNECTOR
87-1368-011	1/-	LED	24V	[C]   	2 pol. Superseal 2 pin Superseal   2,20 m 
87-1366-011	-/-	LED	24V	[D]   	2 pol. Superseal 2 pin Superseal   6,04 m 

Positionslampe  
Position Lamp



ZUBEHÖR / ACCESSORIES

## 1 Superseal Verbinder | Superseal connector

- (a) 2 pol. weiblich  
2 pin female ..... 15-7002-044 
- (b) 2 pol. männlich  
2 pin male ..... 15-7002-054 

1a



1b





# UNIPOINT I LED

ADR Zone 2 IP 6K9K

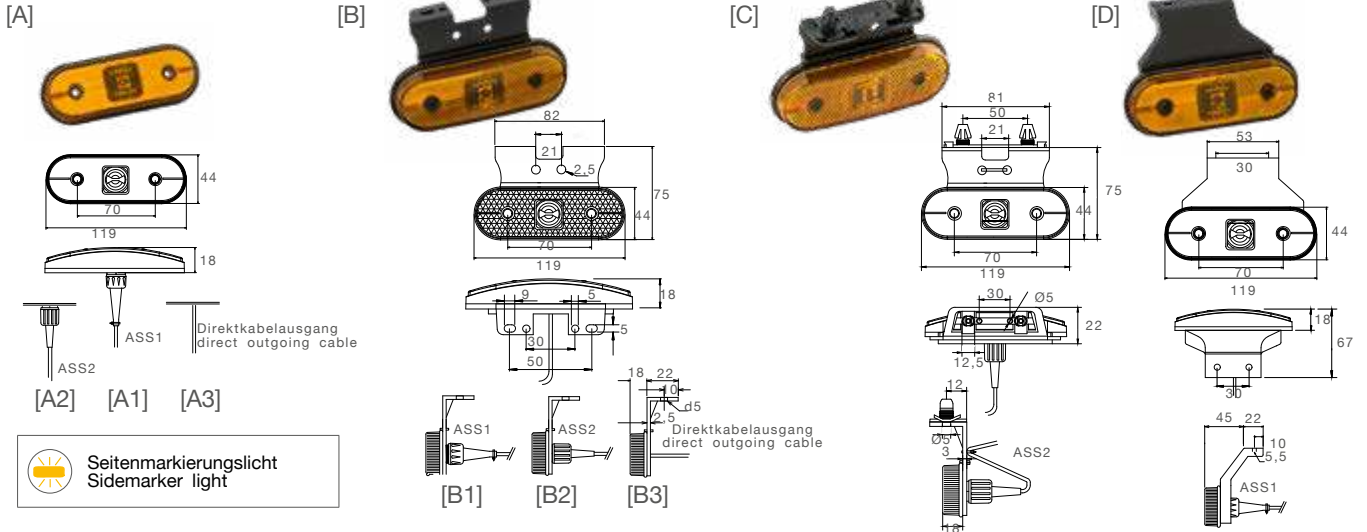

BEST. NR PART NO				ZUSATZ ADD ON	ANSCHLUSS CONNECTOR
31-2000-014	-/-	LED	24V	[A3]	offenes Ende open end 0,50 m
31-2000-034	-/-	LED	24V	[A3]	offenes Ende open end 1,50 m
31-2004-014	1/-	LED	24V	[A1]	P&R   0,50 m
31-2004-034	1/-	LED	24V	[A1]	P&R   1,50 m
31-2004-044	1/-	LED	24V	[A1]	P&R   2,00 m
31-2004-074	-/-	LED	24V	[A1]	P&R   2,50 m
31-2007-024	-/-	LED	24V	[A2]	2 pol. ASS2 2 pin ASS2   1,00 m
31-2007-234	1/-	LED	24V	[A2]	3 pol. ASS3 3 pin ASS3   0,50 m
31-2007-244	1/-	LED	24V	[A2]	3 pol. ASS3 3 pin ASS3   1,50 m
31-2007-294	1/-	LED	24V	[A2]	2 pol. ASS2 2 pin ASS2   2,00 m
31-2007-304	1/-	LED	24V	[A3]	3 pol. ASS3 3 pin ASS3   0,50 m
31-2007-334	1/-	LED	24V	[A3]	3 pol. ASS3 3 pin ASS3   1,50 m
31-2007-344	-/-	LED	24V	[A3]	2 pol. ASS2 2 pin ASS2   0,50 m
31-2064-014	1/-	LED	24V	[B1]	P&R   0,50 m
31-2064-034	1/-	LED	24V	[B1]	P&R   1,50 m
31-2064-124	1/-	LED	24V	[C]	P&R   2,00 m
31-2064-214	1/-	LED	24V	[D]	P&R   0,50 m





# UNIPOINT I LED

ADR Zone 2 IP 6K9K

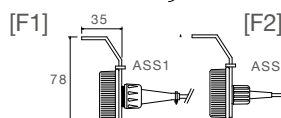
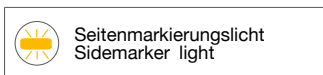
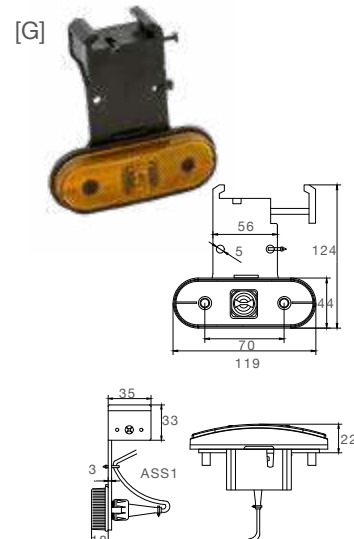
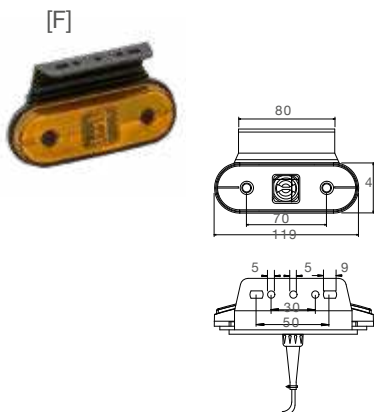
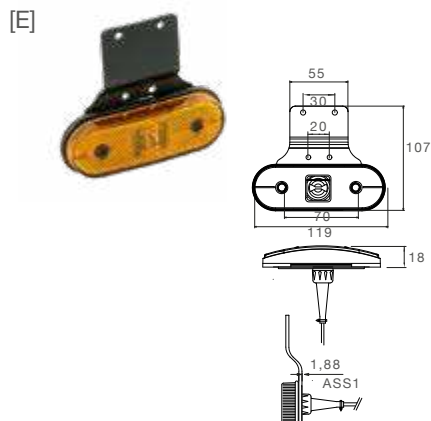

BEST. NR				ZUSATZ	ANSCHLUSS	
PART NO				ADD ON	CONNECTOR	
31-2064-234	1/-	LED	24V	[D]	P&R	1,50 m
31-2064-414	1/-	LED	24V	[E]	P&R	0,50 m
31-2064-434	1/-	LED	24V	[E]	P&R	1,50 m
31-2064-714	1/-	LED	24V	[F1]	P&R	0,50 m
31-2064-734	1/-	LED	24V	[F1]	P&R	1,50 m
31-2064-774	1/-	LED	24V	[G]	P&R	1,00 m
31-2067-084	-/-	LED	24V	[B2]	2 pol. ASS2 2 pin ASS2	1,50 m
31-2067-094	1/-	LED	24V	[B2]	3 pol. ASS3 3 pin ASS3	0,50 m
31-2067-104	1/-	LED	24V	[B2]	3 pol. ASS3 3 pin ASS3	1,50 m
31-2067-694	-/-	LED	24V	[F2]	3 pol. ASS3 3 pin ASS3	1,50 m
31-2104-014	1/-	LED	24V	[A3]	P&R	0,50 m
31-2104-034	1/-	LED	24V	[A3]	P&R	1,50 m
31-2164-014	1/-	LED	24V	[B3]	P&R	0,50 m
31-2164-034	-/-	LED	24V	[B3]	P&R	1,50 m





# UNIPOINT I LED

ADR Zone 2 IP 6K9K

[H]

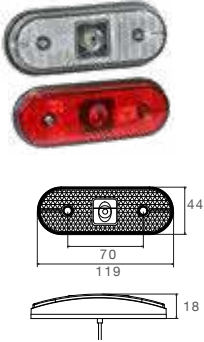

[I]

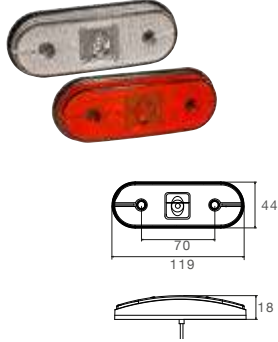

[J]

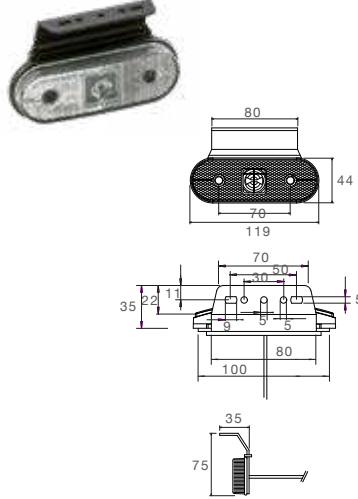

[K]

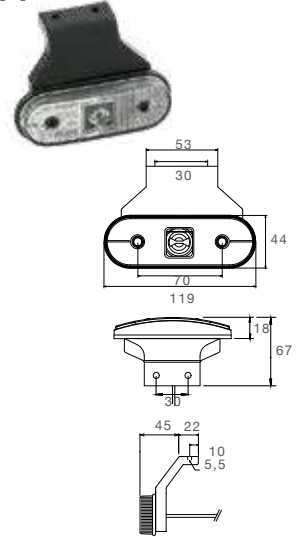

BEST. NR				ZUSATZ				ANSCHLUSS				
PART NO				ADD ON				CONNECTOR				
31-7704-014	1/-	LED	24V	[H]				P&R			0,50 m	
31-7704-034	1/-	LED	24V	[H]				P&R			1,50 m	
31-7704-054	1/-	LED	24V	[H]				P&R			3,50 m	
31-7704-094	1/-	LED	24V	[I]				P&R			0,50 m	
31-7704-124	1/-	LED	24V	[I]				P&R			3,50 m	
31-7707-034	1/-	LED	24V	[H]				2 pol. ASS2 2 pin ASS2				1,50 m
31-7707-104	1/-	LED	24V	[H]				2 pol. ASS3 2 pin ASS3				0,50 m
31-7707-114	1/-	LED	24V	[H]				2 pol. ASS3 2 pin ASS3				1,50 m
31-7707-214	-/-	LED	24V	[H]				2 pol. ASS2 2 pin ASS2				0,50 m
31-7764-014	1/-	LED	24V	[J]				P&R			0,50 m	
31-7764-214	-/-	LED	24V	[K]				P&R			0,50 m	
31-7764-234	-/-	LED	24V	[K]				P&R			1,50 m	
31-7804-014	1/-	LED	24V	[H]				P&R			0,50 m	
31-7804-054	1/-	LED	24V	[H]				P&R			3,50 m	
31-7804-094	1/-	LED	24V	[I]				P&R			0,50 m	
31-7804-124	1/-	LED	24V	[I]				P&R			3,50 m	
31-7804-144	1/-	LED	24V	[H]				P&R			5,00 m	



# UNIPOINT I LED

ZUBEHÖR / ACCESSORIES

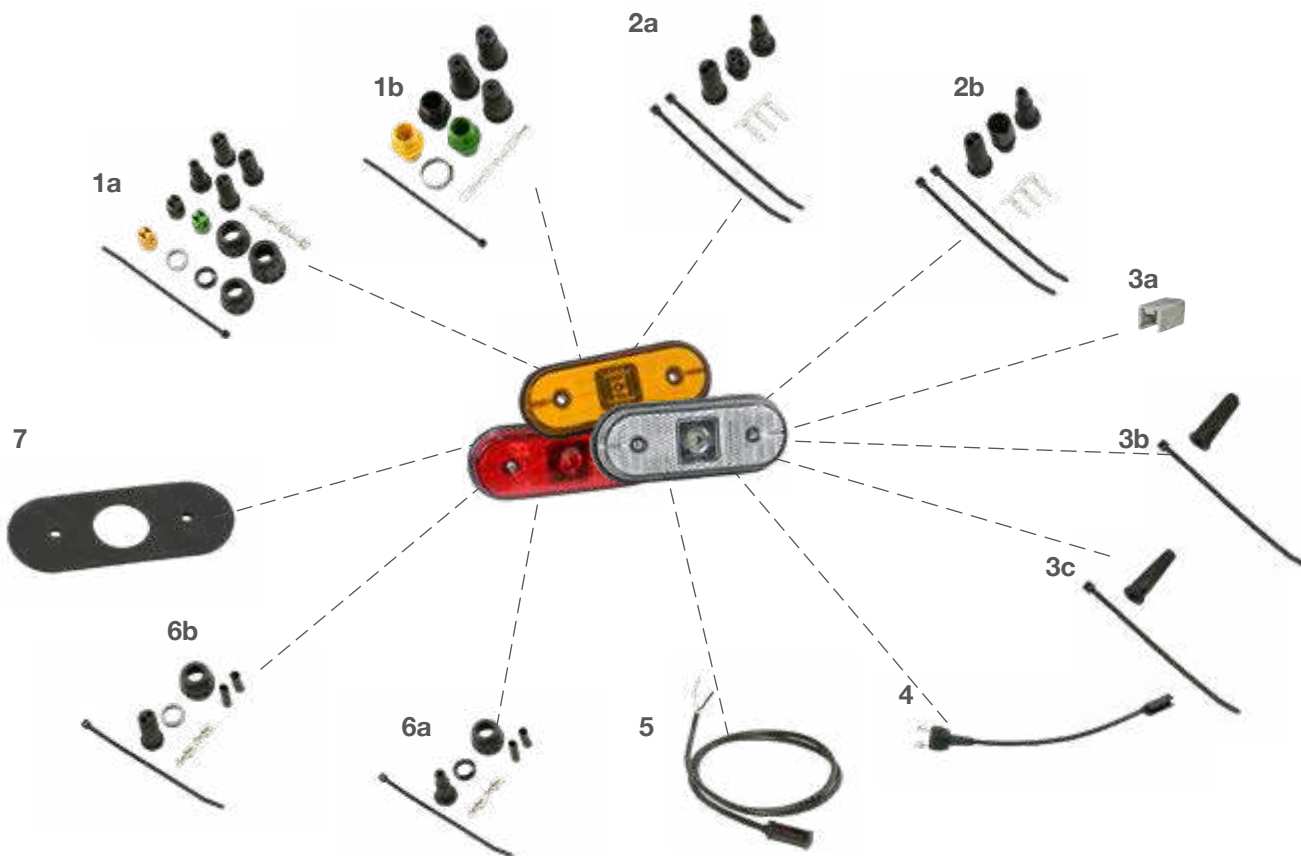

## 1 ASS1 & ASS2 Verbinder | ASS1 & ASS2 connector

- (a) 2 pol. weiblich  
2 pin female ..... 13-5626-401
- (b) 2 pol. männlich  
2 pin male ..... 13-5625-991

## 2 ASS3 Verbinder | ASS3 connector

- (a) 3 pol. weiblich  
3 pin female ..... 13-0322-281
- (b) 3 pol. männlich  
3 pin male ..... 13-0332-281

## 3 für P&R Verbinder | for P&R connector

- (a) Verschlusskappen  
caps ..... 15-5971-014
- (b) Endkappen rund  
end caps round ..... 15-5983-024
- (c) Endkappen eckig  
end caps square ..... 15-5729-014

## 4 Zuleitung mit P&R Verbinder | front connection with P&R connector

- 0,25 m ..... 68-5018-004
- 1,5 m ..... 68-5018-024

## 5 Anschlusskabel P&R | connection cable P&R

- 0,5 m ..... 68-5000-014
- 1,5 m ..... 68-5000-034

## 6 Anschluss | connector

- (a) Einfachtülle (lose)  
single grommet (loose) 15-5624-014
- (b) Doppeltülle (lose)  
double grommet (loose) 15-5624-024

## 7 Gummiunterlage | rubber base

- ..... 15-5319-904



## UNIPOINT I LED

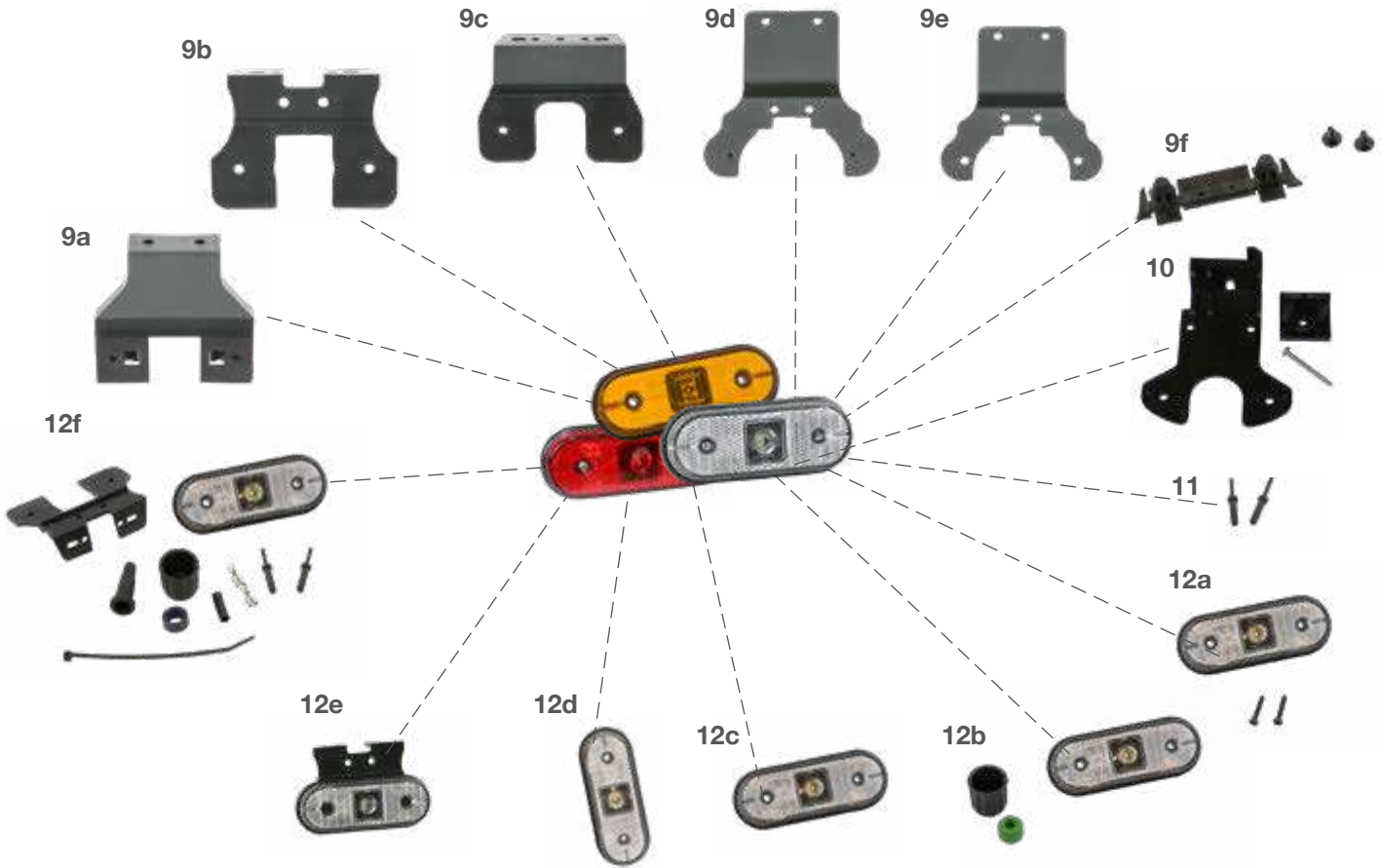

### 9 Haltewinkel | bracket

- (a) schräg nach hinten  
sloping angle to the back  
..... 15-5317-014
- (b) 90° nach hinten  
90° to the back  
..... 15-5319-004
- (c) schräg nach vorne  
sloping to the front  
..... 15-5319-304
- (d) Aufhängeteil gekröpft (Anbau mit Schrauben)  
crumped bracket (screw mounting)  
..... 15-5317-004
- (e) Aufhängeteil gekröpft (Anbau mit Nieten)  
crumped bracket (expanding rivet-mounting)  
..... 15-5317-024
- (f) Schnellhalter for SML  
quick fixation bracket for SML  
..... 15-2128-285

### 10 Verriegelungswinkel | locking bracket

- Verriegelungswinkel  
locking angle  
..... 15-5322-004

### 11 Spreizniete | expanding rivet

- 14-15 mm ..... 14-4596-004

### 12 Ersatzleuchte weiß ohne Schutzhaube | spare part lamp white without protection cap

- (a) mit Schrauben  
with screws ..... 21-7700-004
- (b) geschlossen mit Bajonett-Mutter  
closed by bayonet-nut  
..... 21-7700-014
- (c) Standard Version  
standard version ..... 21-7700-054
- (d) vertikal  
vertical ..... 21-7702-014
- (e) mit 90° Haltewinkel nach hinten  
with 90° bracket to the back  
..... 21-7700-024
- (f) mit 90° Haltewinkel nach hinten  
(komplett)  
with 90° bracket to the back  
(complete)  
..... 21-7700-035



## UNIPOINT | LED

ZUBEHÖR / ACCESSORIES

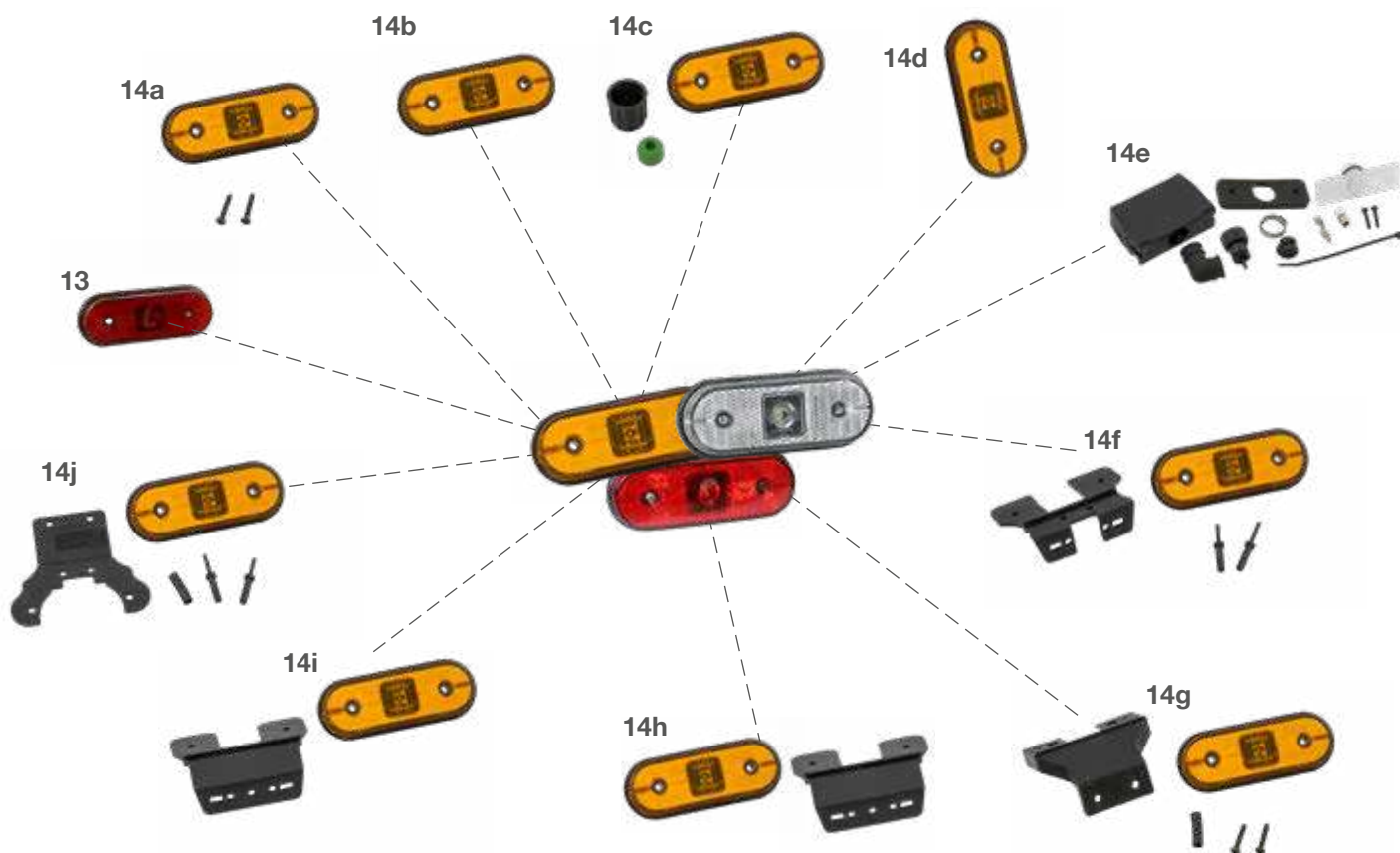

**13** Ersatzleuchte rot ohne Schutzhaube |  
**spare part lamp red without protection cap**  
 mit Schrauben  
 with screws ..... 21-7800-004

**14** Ersatzleuchte orange ohne Schutzhaube |  
**spare part lamp orange without protection cap**

(a) mit Schrauben  
 with screws..... 21-2000-004

(b) ohne Schrauben  
 without screws..... 21-2000-154

(c) geschlossen mit Bajonett-Mutter  
 closed by bayonet-nut  
 ..... 21-2000-144

(d) vertikal  
 vertical..... 21-2002-004

(e) mit geradem Anschluss für SML mit  
 90° Haltewinkel  
 with straight connector for SML with  
 90° bracket  
 ..... 21-2000-035

(f) lose mit 90° Haltewinkel  
 loose with 90° bracket  
 ..... 21-2000-014

(g) lose mit schrägem Haltewinkel  
 loose with sloping bracket  
 ..... 21-2000-024

(h) mit flexiblen Haltewinkel  
 with flexible bracket  
 ..... 21-2000-054

(i) mit flexiblen Haltewinkel und  
 Schnellhalter  
 with flexible bracket and quick-fixation bracket  
 ..... 21-2000-104

(j) mit Aufhängeteil  
 with bracket..... 21-2000-064





# UNIPOINT DI

ADR Zone 2 IP 6K9K

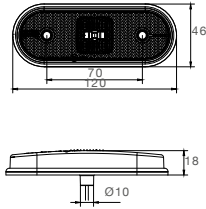

Seitenmarkierungslicht  
Sidemarker light

BEST. NR				ZUSATZ	ANSCHLUSS
PART NO				ADD ON	CONNECTOR
31-2100-134	1/-	LED	24V		offenes Ende open end 1,50 m
31-2104-074	1/-	LED	24V		P&R  1,50 m
31-2107-004	1/-	LED	24V		2 pol. ASS3 2 pin ASS3  1,50 m





# UNIPPOINT DI

ZUBEHÖR / ACCESSORIES

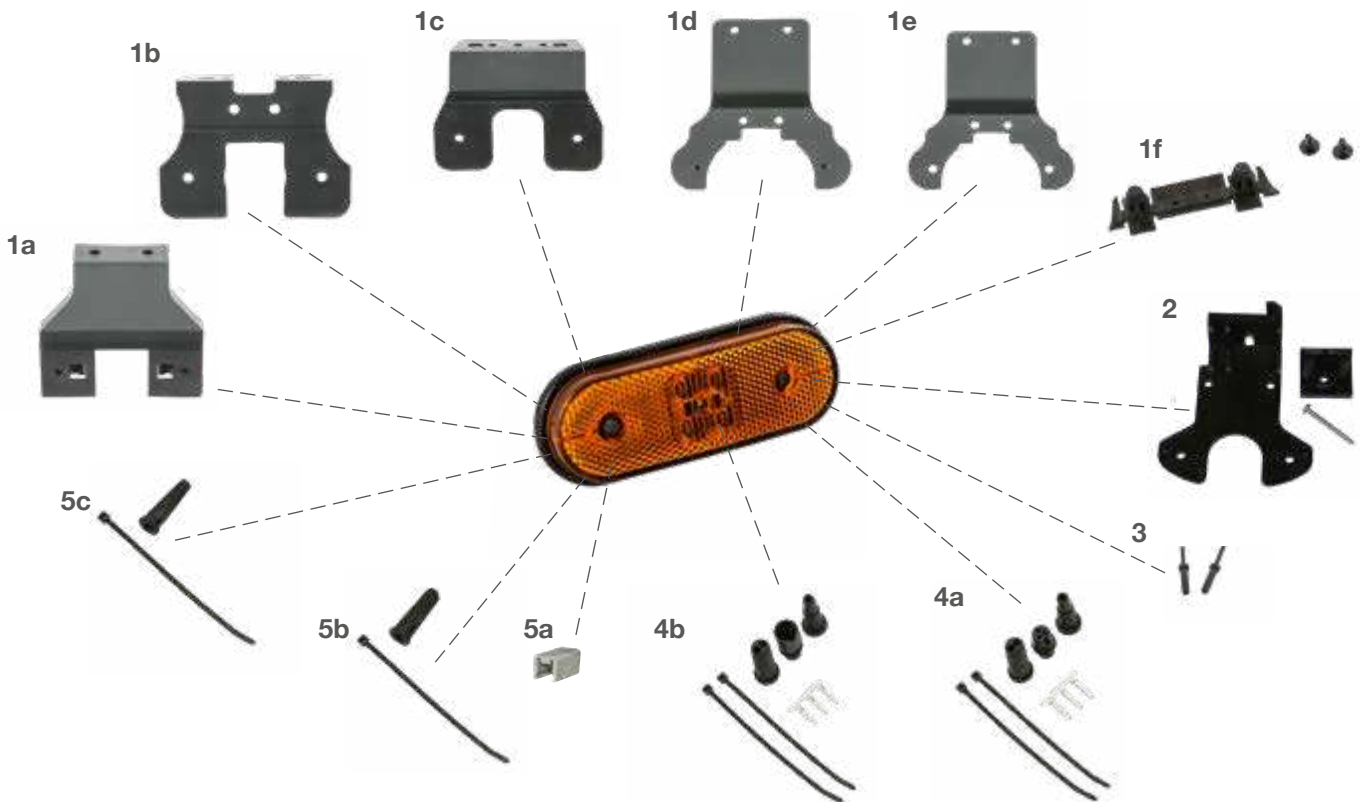

## 1 Haltewinkel | bracket

- (a) schräg nach hinten  
sloping angle to the back  
..... 15-5317-014
- (b) 90° nach hinten  
90° to the back  
..... 15-5319-004
- (c) schräg nach vorne  
sloping to the front  
..... 15-5319-304
- (d) Aufhängeteil gekröpft (Anbau mit Schrauben)  
crumped bracket (screw mounting)  
..... 15-5317-004
- (e) Aufhängeteil gekröpft (Anbau mit Nieten)  
crumped bracket (expanding rivet-mounting)  
..... 15-5317-024
- (f) Schnellhalter for SML  
quick fixation bracket for SML  
..... 15-2128-285

## 2 Verriegelungswinkel | locking bracket

- Verriegelungswinkel  
locking angle  
..... 15-5322-004

## 3 Spreizniete | expanding rivet

- 14-15 mm ..... 14-4596-004

## 4 ASS3 Verbinder | ASS3 connector

- (a) 3 pol. weiblich  
3 pin female ..... 13-0322-281
- (b) 3 pol. männlich  
3 pin male ..... 13-0332-281

## 5 für P&R Verbinder | for P&R connector

- (a) Verschlusskappen  
caps ..... 15-5971-014
- (b) Endkappen rund  
end caps round ..... 15-5983-024
- (c) Endkappen eckig  
end caps square ..... 15-5729-014





# UNIPOINT DI + SML

ADR Zone 2 IP 6K9K



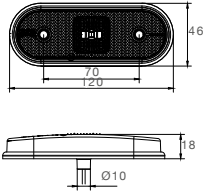



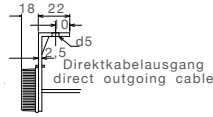
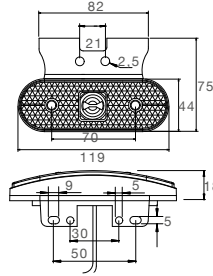













[A]



[B]



 Seitenmarkierungslicht  
Sidemarker light

BEST. NR				ZUSATZ	ANSCHLUSS	
PART NO				ADD ON	CONNECTOR	
31-2100-034	-/-	LED	24V	[A]   	offenes Ende open end	1,50 m 
31-2107-014	-/-	LED	24V	[A]   	3 pol. ASS3   	1,50 m 
31-2107-024	1/-	LED	24V	[B]   	3 pol. ASS3   	1,50 m 



# UNIPOINT DI + SML

ZUBEHÖR / ACCESSORIES

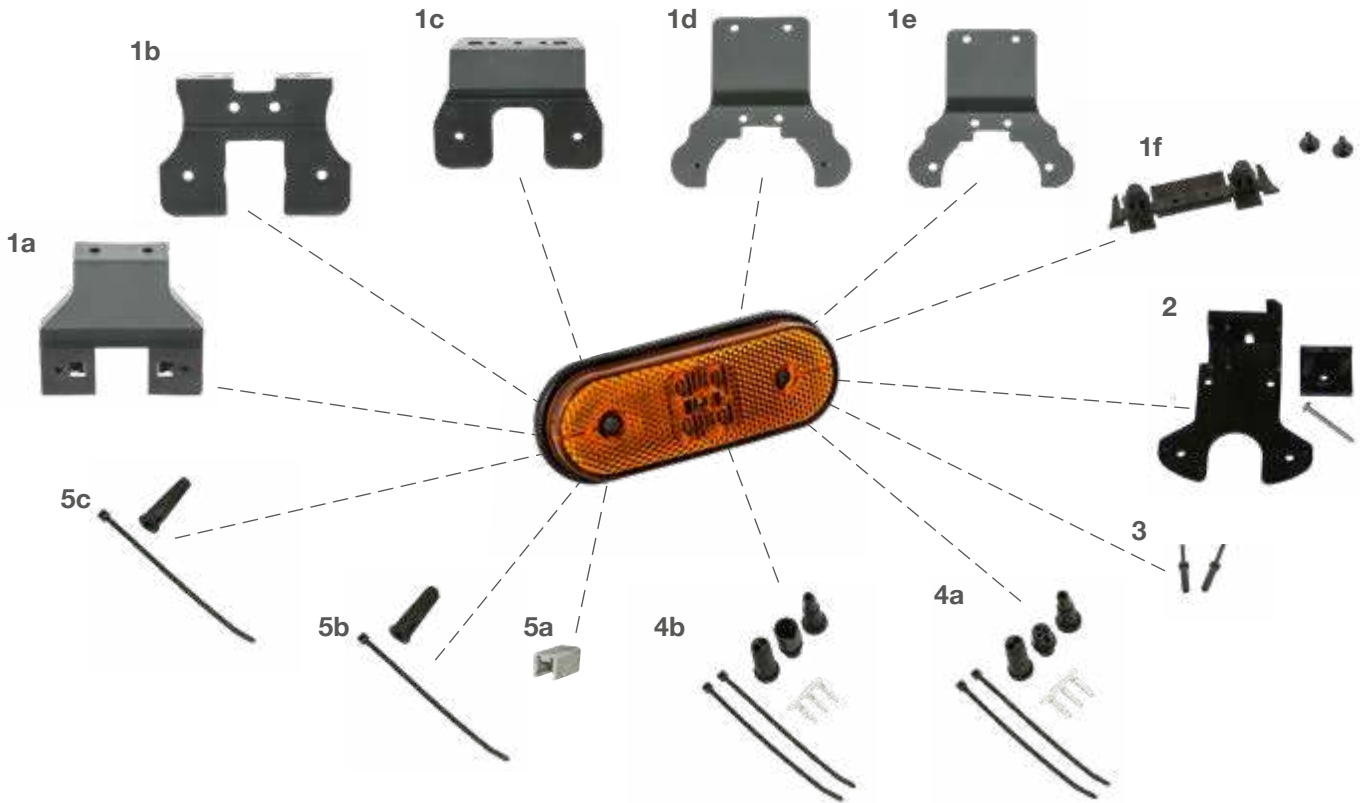

- 1 Haltewinkel | bracket**
- (a) schräg nach hinten  
sloping angle to the back  
..... 15-5317-014
  - (b) 90° nach hinten  
90° to the back  
..... 15-5319-004
  - (c) schräg nach vorne  
sloping to the front  
..... 15-5319-304
  - (d) Aufhängeteil gekröpft (Anbau mit Schrauben)  
crumped bracket (screw mounting)  
..... 15-5317-004
  - (e) Aufhängeteil gekröpft (Anbau mit Nieten)  
crumped bracket (expanding rivet-mounting)  
..... 15-5317-024
  - (f) Schnellhalter for SML  
quick fixation bracket for SML  
..... 15-2128-285

- 2 Verriegelungswinkel | locking bracket**
- Verriegelungswinkel  
locking angle  
..... 15-5322-004

- 3 Spreizniete | expanding rivet**  
14-15 mm ..... 14-4596-004
- 4 ASS3 Verbinder | ASS3 connector**
- (a) 3 pol. weiblich  
3 pin female ..... 13-0322-281
  - (b) 3 pol. männlich  
3 pin male ..... 13-0332-281
- 5 für P&R Verbinder | for P&R connector**
- (a) Verschlusskappen  
caps ..... 15-5971-014
  - (b) Endkappen rund  
end caps round ..... 15-5983-024
  - (c) Endkappen eckig  
end caps square ..... 15-5729-014





# UNIPOINT MAXX LED

ADR Zone 2 IP 6K9K

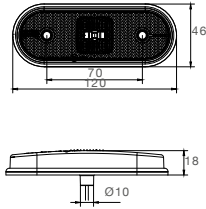

Seitenmarkierungslicht  
Sidemarker light

BEST. NR				ZUSATZ	ANSCHLUSS
PART NO				ADD ON	CONNECTOR
31-2104-064	1/-	LED	24V		P&R  2,00 m



# UNIPOINT MAXX LED

ZUBEHÖR / ACCESSORIES

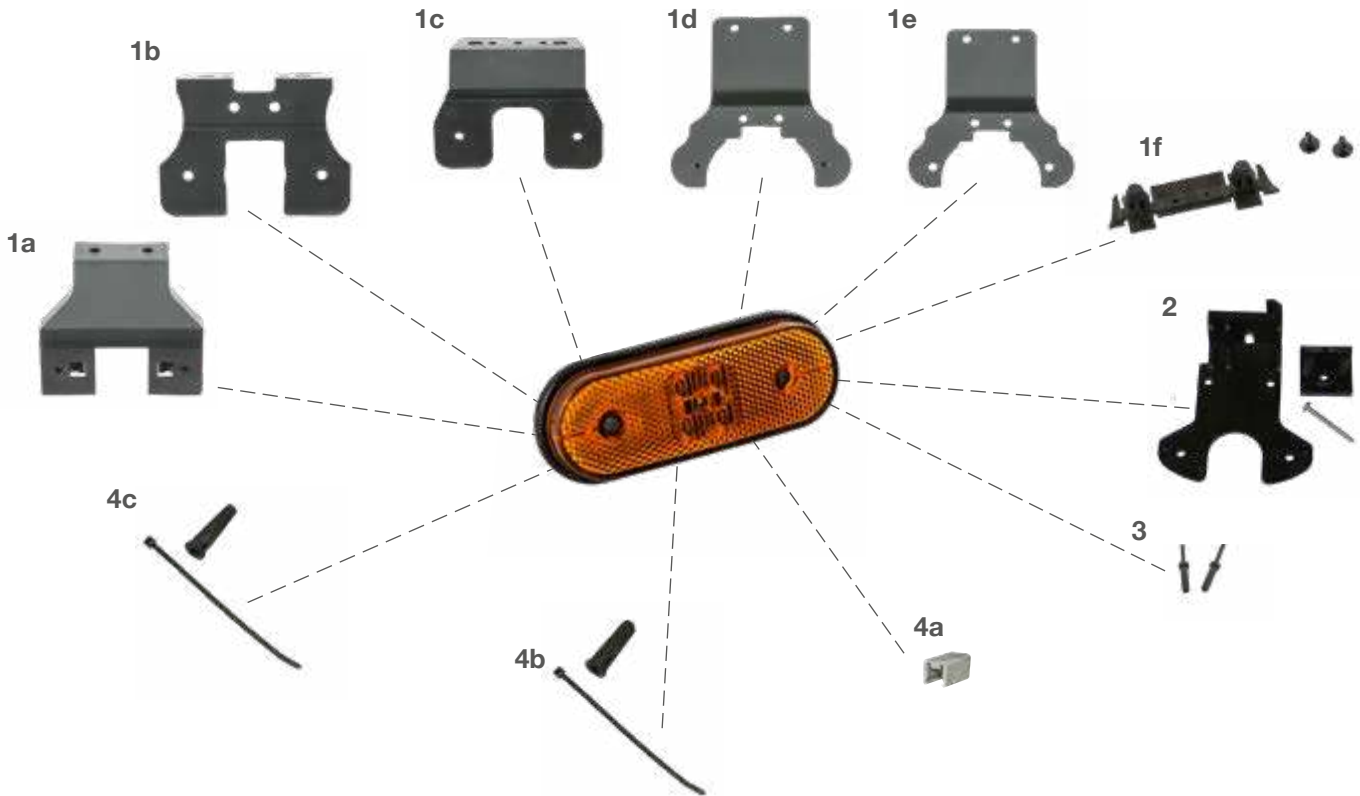

## 1 Haltewinkel | bracket

- (a) schräg nach hinten  
sloping angle to the back  
..... 15-5317-014
- (b) 90° nach hinten  
90° to the back  
..... 15-5319-004
- (c) schräg nach vorne  
sloping to the front  
..... 15-5319-304
- (d) Aufhängeteil gekröpft (Anbau mit Schrauben)  
crumped bracket (screw mounting)  
..... 15-5317-004
- (e) Aufhängeteil gekröpft (Anbau mit Nieten)  
crumped bracket (expanding rivet-mounting)  
..... 15-5317-024
- (f) Schnellhalter for SML  
quick fixation bracket for SML  
..... 15-2128-285

## 2 Verriegelungswinkel | locking bracket

- Verriegelungswinkel  
locking angle  
..... 15-5322-004

## 3 Spreizniete | expanding rivet

- 14-15 mm ..... 14-4596-004

## 4 für P&R Verbinder | for P&R connector

- (a) Verschlusskappen  
caps ..... 15-5971-014
- (b) Endkappen rund  
end caps round ..... 15-5983-024
- (c) Endkappen eckig  
end caps square ..... 15-5729-014



# SIDEPOINT

ADR  
Zone 2

IP 68

[A]

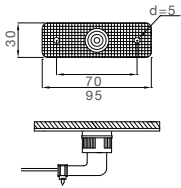

[B]

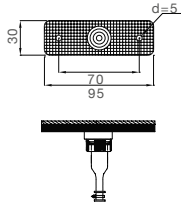

[C]

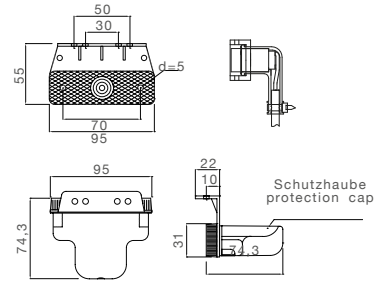

[D]

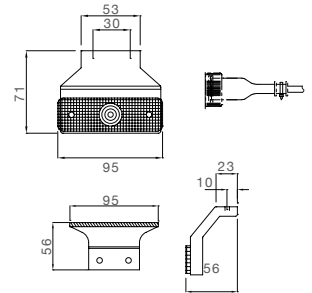

Positionslampe  
Position Lamp





BEST. NR				ZUSATZ	ANSCHLUSS	
PART NO				ADD ON	CONNECTOR	
31-5004-014	-/-		24V	[A]		0,50 m
31-5004-094	1/-		24V	[B]		0,50 m
31-5004-104	1/-		24V	[B]		1,50 m
31-5004-154	1/-		24V	[A]		0,25 m
31-2804-094	1/-		24V	[A]		0,50 m
31-2804-174	1/-		24V	[B]		1,50 m
31-2814-004	1/-		24V	[C]	Schutzhaube protection cap	0,50 m
31-2814-024	1/-		24V	[C]	Schutzhaube protection cap	1,50 m
31-2864-004	1/-		24V	[D]		0,50 m
31-2864-034	1/-		24V	[D]		1,50 m

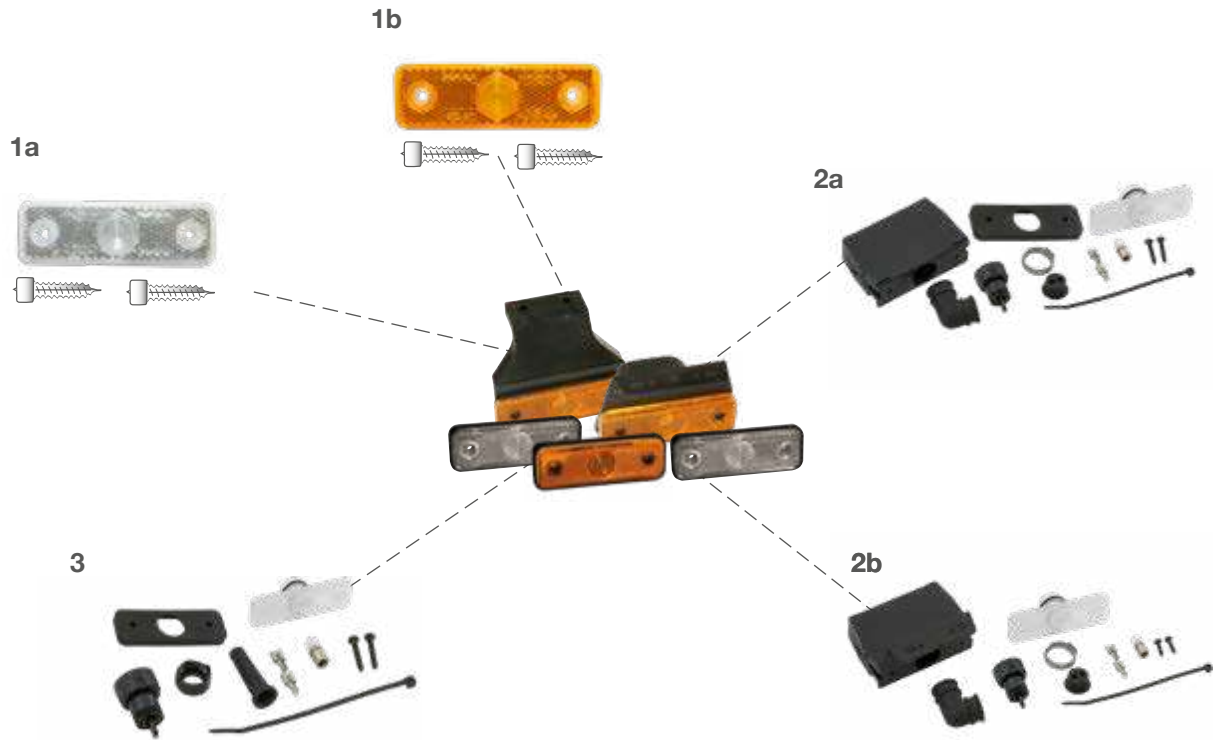

# SIDEPOINT

ZUBEHÖR / ACCESSORIES



- 1** **Lichtscheibe | lens**
- (a) weiß mit Schrauben  
white with screws ..... 21-5000-024 
  - (b) orange mit Schrauben  
orange with screws ..... 21-2800-004 
- 2** **Ersatzleuchte weiß mit Schutzhaube |  
spare part lamp white with protection cap**
- (a) mit 90° Anschluss ohne Haltewinkel  
with 90° connector without bracket  
..... 21-5000-004 
  - (b) mit 90° Anschluss und 90° Haltewinkel  
with 90° connector and 90° bracket  
..... 21-5000-034 

- 3** **Ersatzleuchte weiß ohne Schutzhaube |  
spare part lamp white without protection cap**  
mit geradem Anschluss ohne Haltewinkel  
with straight connector without bracket  
..... 21-5000-054 





## SIDEPOINT

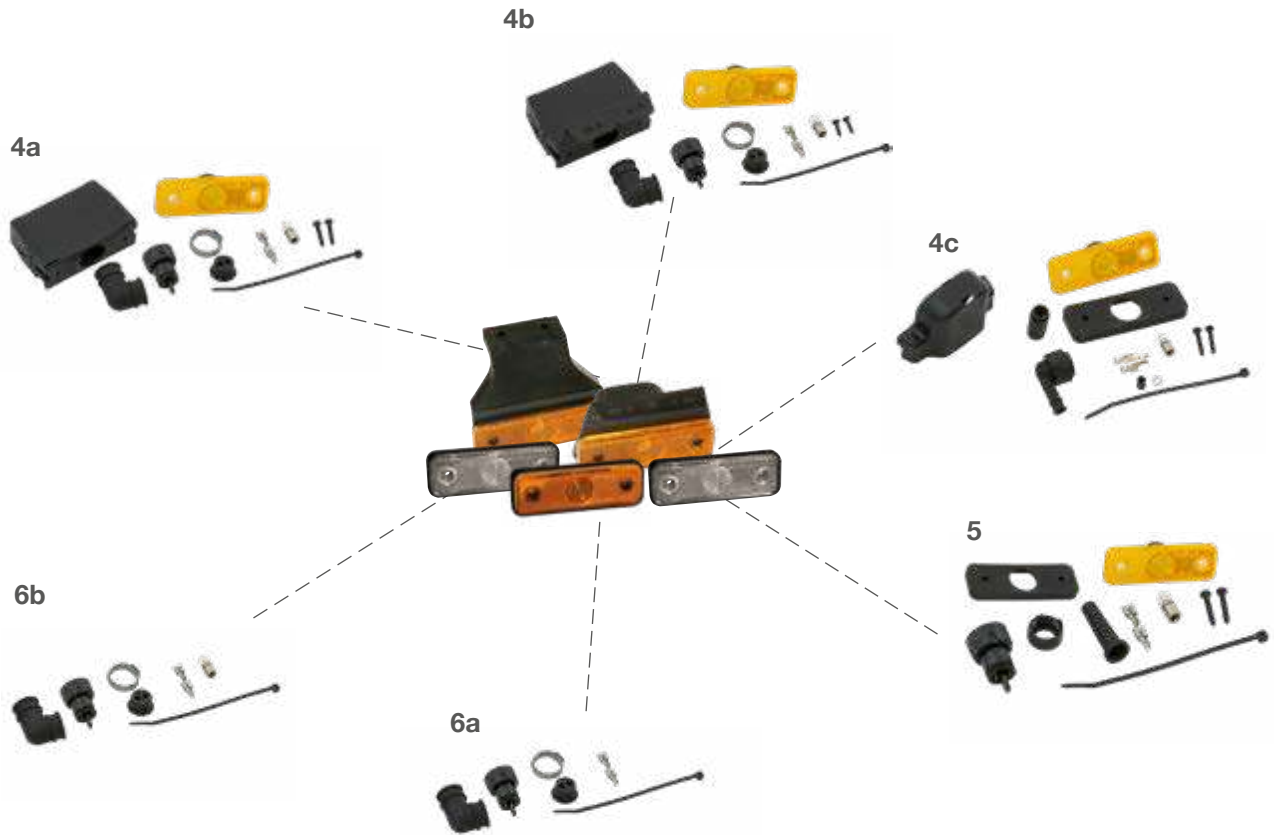

### 4 Ersatzleuchte orange mit Schutzhaube | spare part lamp orange with protection cap

- (a) mit 90° Anschluss ohne Haltewinkel  
with 90° connector without bracket  
..... 21-2801-004
- (b) mit 90° Anschluss und 90° Haltewinkel  
with 90° connector and 90° bracket  
..... 21-2800-014
- (c) mit 90° Anschluss und Schutzhaube  
with 90° connector and with protection cap  
..... 21-2801-064

### 5 Ersatzleuchte orange ohne Schutzhaube | spare part lamp orange without protection cap

- mit geradem Anschluss ohne Haltewinkel  
with straight connector without bracket  
..... 21-2801-054

### 6 Anschluss | connector

- (a) ohne Glühlampe  
without bulb..... 15-2128-524
- (b) mit Glühlampe  
with bulb..... 15-2128-514







# SIDEPOINT

ZUBEHÖR / ACCESSORIES

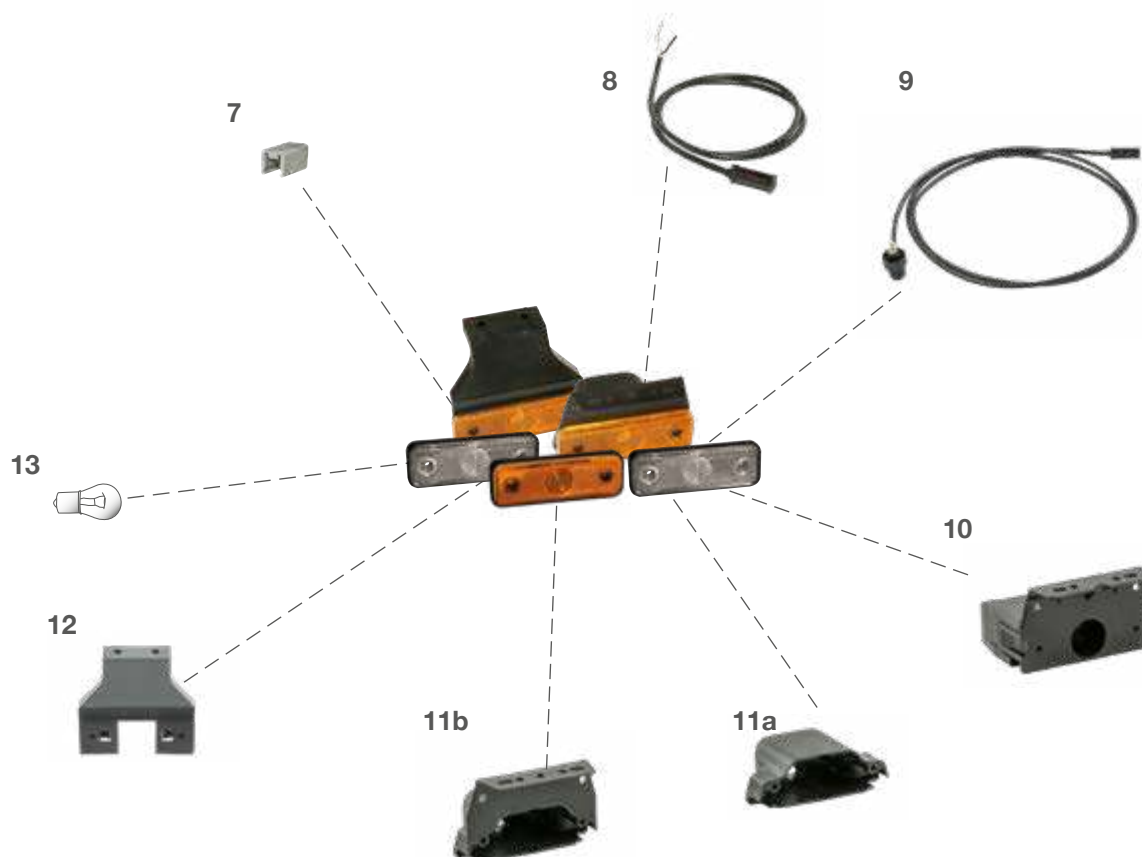

**7** Verschlusskappen für P&R Verbinder | caps for P&R connector  
..... 15-5971-014

**8** Anschlusskabel P&R | connection cable P&R  
0,50 m..... 68-5000-014   
1,50 m..... 68-5000-034

**9** Zuleitung P&R mit Anschluss und Gehäuse für Fassung | front connection P&R with connector and housing for lamp socket  
2,00 m ..... 31-2804-204

**10** Sockel mit Winkel und Schutzhaube | socket with bracket and protection cap  
..... 15-2128-274

**11** Schutzhaube | protection cap  
(a) ohne Haltewinkel  
without bracket..... 15-2122-164   
(b) mit 90° Haltewinkel  
with 90° bracket..... 15-2122-174

**12** Haltewinkel | bracket  
schräg  
sloping..... 15-2128-144

**13** Glühlampe | bulb  
24V 4W ..... 16-6304-027







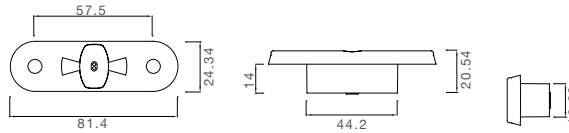































































# POSIPOINT II LED

ADR Zone 2 IP 6K9K



Positionslight  
Position Light

BEST. NR				ZUSATZ	ANSCHLUSS
PART NO				ADD ON	CONNECTOR
31-7100-004	1/-	LED	12V 24V	 	offenes Ende open end 5,00 m 
31-7100-014	1/-	LED	12V 24V	 	offenes Ende open end 3,50 m 
31-7100-034	1/-	LED	12V 24V	 	offenes Ende open end 1,50 m 
31-7100-054	1/-	LED	12V 24V	  MAN Version	2 pol. AFS lear  2 pin AFS lear  0,30 m 
31-7100-064	1/-	LED	12V 24V	 	offenes Ende open end 0,50 m 
31-7100-114	1/-	LED	12V 24V	  mit 7,50 m Wellrohr with 7,50 m corrugated pipe	offenes Ende open end 8,00 m 
31-7104-004	1/-	LED	12V 24V	 	P&R  0,50 m 
31-7104-014	1/-	LED	12V 24V	 	P&R  1,50 m 
31-7104-024	1/-	LED	12V 24V	 	P&R  3,50 m 
31-7104-034	1/-	LED	12V 24V	  mit Verschlusskappe with cap	P&R  5,00 m 
31-7104-054	-/-	LED	12V 24V	 	P&R  0,15 m 
31-7107-014	-/-	LED	12V 24V	 	2 pol. ASS2  2 pin ASS2  1,30 m 
31-7110-004	-/-	LED	12V 24V	  mit 7,50 m Wellrohr with 7,50 m corrugated pipe	offenes Ende open end 8,00 m 
31-7204-014	1/-	LED	12V 24V	 	P&R  1,50 m 
31-7204-024	1/-	LED	12V 24V	 	P&R  3,50 m 
31-7204-044	1/-	LED	12V 24V	 	P&R  5,00 m 
31-7207-014	-/-	LED	12V 24V	 	2 pol. ASS3  2 pin ASS3  0,50 m 
31-7210-004	1/-	LED	12V 24V	  mit 0,30 m Wellrohr with 0,30 m corrugated pipe	offenes Ende open end 0,80 m 



# POSIPOINT II LED

ZUBEHÖR / ACCESSORIES

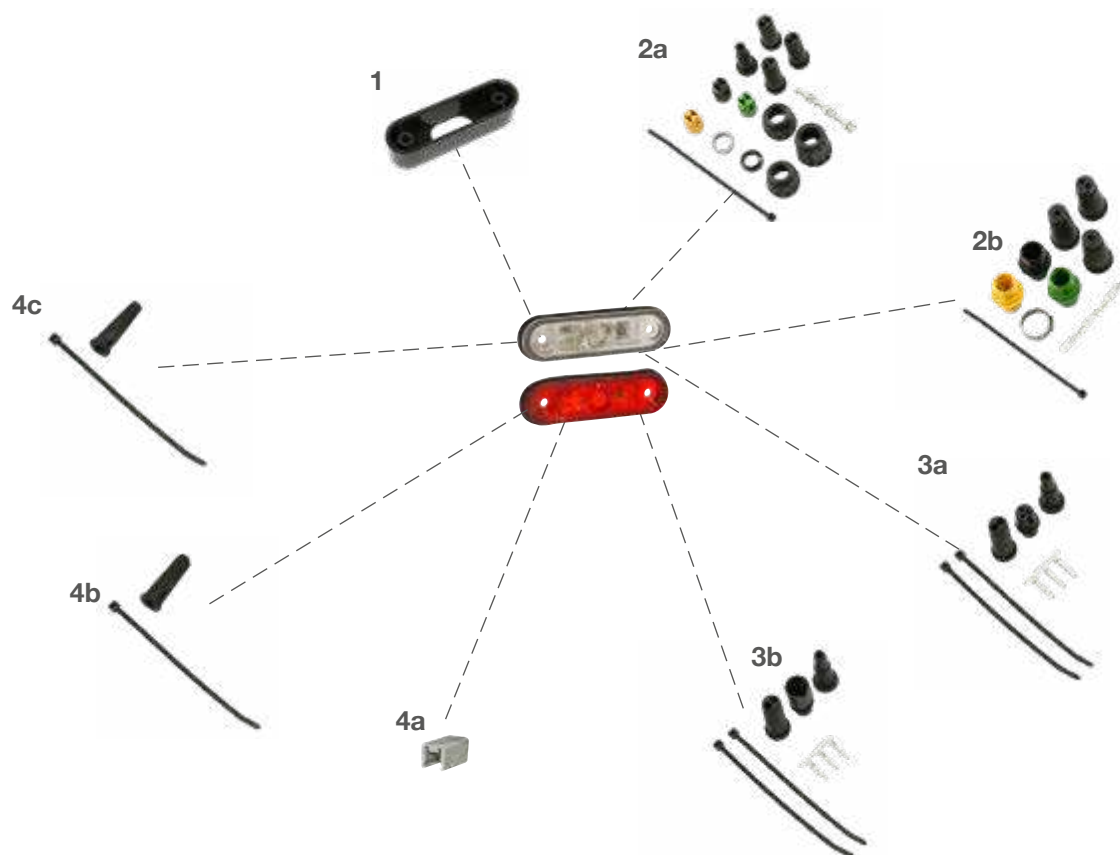

**1** Gehäuse | housing  
..... 15-5609-104

**2** ASS1 & ASS2 Verbinder |  
ASS1 & ASS2 connector  
(a) 2 pol. weiblich  
2 pin female ..... 13-5626-401   
(b) 2 pol. männlich  
2 pin male ..... 13-5625-991

**3** ASS3 Verbinder | ASS3 connector  
(a) 3 pol. weiblich  
3 pin female ..... 13-0322-281   
(b) 3 pol. männlich  
3 pin male ..... 13-0332-281

**4** für P&R Verbinder |  
for P&R connector  
(a) Verschlusskappen  
caps ..... 15-5971-014   
(b) Endkappen rund  
end caps round ..... 15-5983-024   
(c) Endkappen eckig  
end caps square ..... 15-5729-014

**4** Dichtungsring |  
sealing ring  
..... 15-5113-004



# POSIPOINT I LED

ADR Zone 2 IP 6K9K

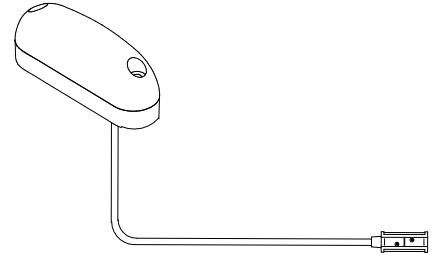
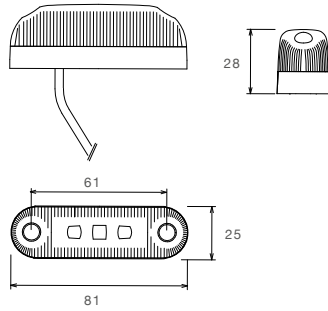

BEST. NR				ZUSATZ	ANSCHLUSS
PART NO				ADD ON	CONNECTOR
31-6004-074	1/-	LED	24V		P&R  0,50 m
31-6004-094	1/-	LED	24V		P&R  5,00 m
31-6204-084	1/-	LED	24V		P&R  0,50 m
31-6204-104	1/-	LED	24V		P&R  5,00 m



# POSIPOINT I LED

ZUBEHÖR / ACCESSORIES

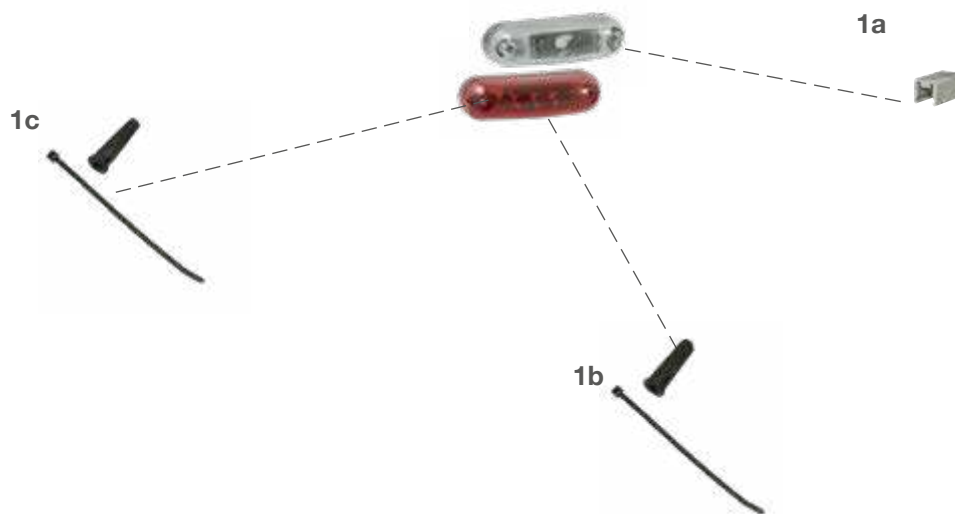

## 1 für P&R Verbinder I for P&R connector

- (a) Verschlusskappen  
caps..... 15-5971-014
- (b) Endkappen rund  
end caps round..... 15-5983-024
- (c) Endkappen eckig  
end caps square..... 15-5729-014



# MONOPOINT II LED

ADR Zone 2 IP 6K9K

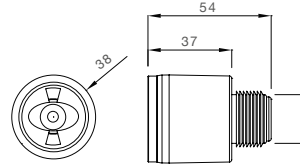
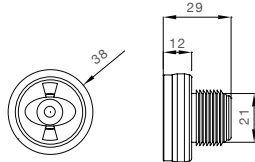

Positionslight  
Position Light

BEST. NR				ZUSATZ	ANSCHLUSS	
PART NO				ADD ON	CONNECTOR	
31-6700-024	1/-	LED	12V 24V		offenes Ende open end	3,50 m
31-6704-064	1/-	LED	12V 24V		P&R	0,50 m
31-6704-074	1/-	LED	12V 24V		P&R	1,50 m
31-6704-084	1/-	LED	12V 24V		P&R	3,50 m
31-6704-124	1/-	LED	12V 24V		P&R	5,00 m
31-6704-204	1/-	LED	12V 24V		P&R	1,70 m
31-6707-054	-/-	LED	12V 24V		3 pol. ASS3 3 pin ASS3	1,50 m
31-6700-044	1/-	LED	12V 24V		2 pol. MKR plus Lear 2 pin MKR plus Lear	0,50 m
31-6700-064	-/-	LED	12V 24V		2 pol. Superseal 2 pin Superseal	0,25 m
31-6700-014	1/-	LED	12V 24V	+ [A]	offenes Ende open end	3,70 m
31-6700-034	1/-	LED	12V 24V		offenes Ende open end	3,50 m
31-6704-094	1/-	LED	12V 24V		P&R	0,50 m
31-6704-104	1/-	LED	12V 24V		P&R	1,50 m
31-6704-114	1/-	LED	12V 24V		P&R	3,50 m



# MONOPOINT II LED

ADR Zone 2 IP 6K9K

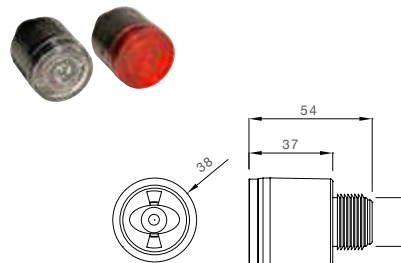
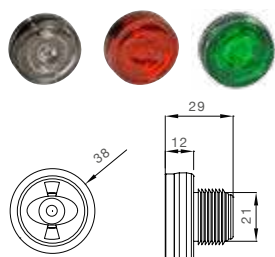

BEST. NR				ZUSATZ	ANSCHLUSS	
PART NO				ADD ON	CONNECTOR	
31-6800-014	1/-	LED	12V 24V		offenes Ende open end	3,50 m
31-6804-064	1/-	LED	12V 24V		P&R	3,50 m
31-6804-084	1/-	LED	12V 24V		P&R	0,50 m
31-6804-094	-/-	LED	12V 24V		P&R	5,00 m
31-6807-014	-/-	LED	12V 24V		3 pol. ASS3 3 pin ASS3	0,50 m
31-6804-074	1/-	LED	12V 24V		P&R	3,50 m
31-7400-004	-/-	LED	12V 24V		offenes Ende open end	3,50 m
31-7400-014	-/-	LED	12V 24V		offenes Ende open end	1,00 m





# MONOPOINT II LED

ZUBEHÖR / ACCESSORIES

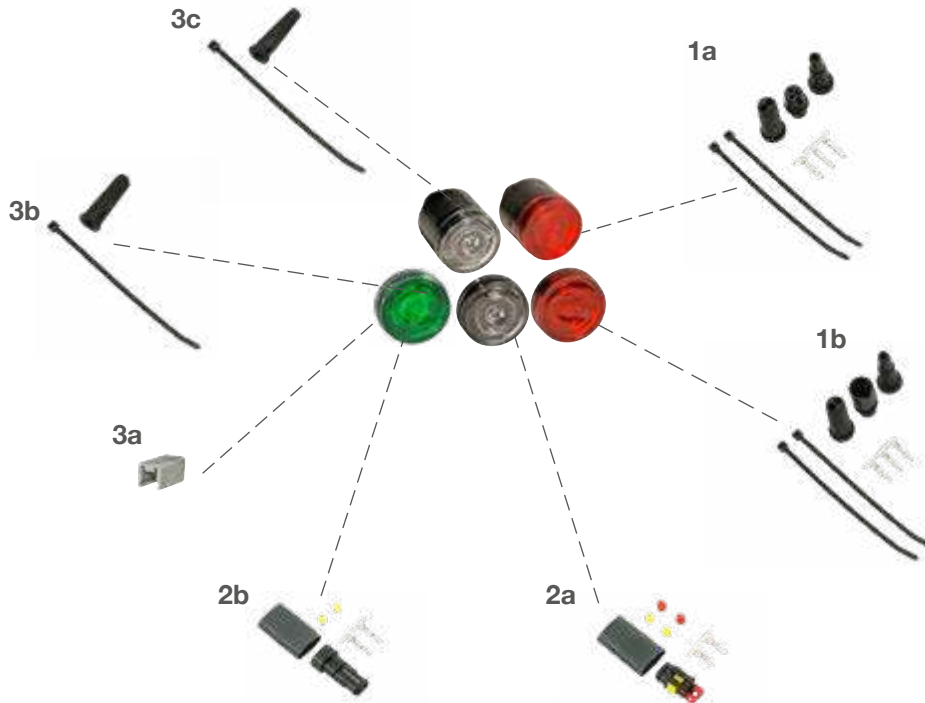

- 1 ASS3 Verbinder | ASS3 connector**
- (a) 3 pol. weiblich  
3 pin female ..... 13-0322-281
  - (b) 3 pol. männlich  
3 pin male ..... 13-0332-281
- 2 Superseal Verbinder | Superseal connector**
- (a) 2 pol. weiblich  
2 pin female ..... 15-7002-044
  - (b) 2 pol. männlich  
2 pin male ..... 15-7002-054

- 3 für P&R Verbinder | for P&R connector**
- (a) Verschlusskappen  
caps ..... 15-5971-014
  - (b) Endkappen rund  
end caps round ..... 15-5983-024
  - (c) Endkappen eckig  
end caps square ..... 15-5729-014



THE ART OF LIGHTS



# UNIPOINT MAXX

LED SEITENMARKIERUNGSLEUCHE  
MIT MAXIMALER LICHTSTÄRKE



[www.aspoeck.com](http://www.aspoeck.com)



# MONOPOINT I LED

ADR Zone 2 IP 6K9K

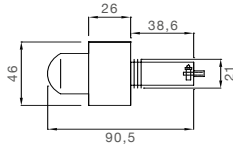

Positionslicht  
Position Light

BEST. NR				ZUSATZ	ANSCHLUSS
PART NO				ADD ON	CONNECTOR
31-6704-014	1/-	LED	12V 24V		P&R  0,50 m
31-6704-054	1/-	LED	12V 24V		P&R  3,50 m
31-6707-044	-/-	LED	12V 24V		3 pol. ASS3   3 pin ASS3 3,50 m
31-6707-004	-/-	LED	12V 24V		2 pol. ASS2   2 pin ASS2 1,50 m
31-6804-014	1/-	LED	12V 24V		P&R  0,50 m
31-6807-024	-/-	LED	12V 24V		3 pol. ASS3   3 pin ASS3 0,50 m



# MONOPOINT | LED

ZUBEHÖR / ACCESSORIES

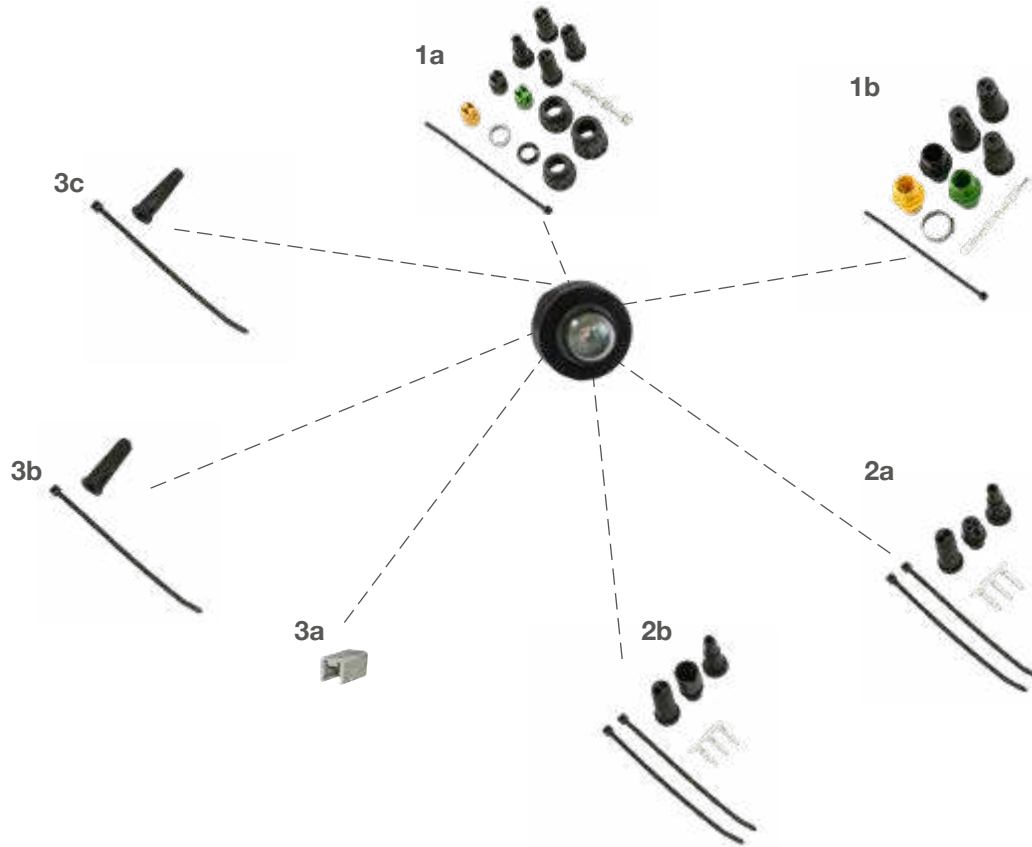

## 1 ASS1 & ASS2 Verbinder | ASS1 & ASS2 connector

- (a) 2 pol. weiblich  
2 pin female ..... 13-5626-401
- (b) 2 pol. männlich  
2 pin male ..... 13-5625-991

## 2 ASS3 Verbinder | ASS3 connector

- (a) 3 pol. weiblich  
3 pin female ..... 13-0322-281
- (b) 3 pol. männlich  
3 pin male ..... 13-0332-281

## 3 für P&R Verbinder | for P&R connector

- (a) Verschlusskappen  
caps ..... 15-5971-014
- (b) Endkappen rund  
end caps round ..... 15-5983-024
- (c) Endkappen eckig  
end caps square ..... 15-5729-014



# FASSPÖCK<sup>®</sup>

## S T E M S



## KENNZEICHENLEUCHE

Um das Nummernschild bestmöglich ersichtlich zu machen, bietet das Sortiment von Aspöck Kennzeichenleuchten mit unterschiedlichen Designs an.

Durch die verschiedenen Anschlüsse kann die Leuchte einfach und schnell mit dem vorhandenen Kabelsystem verbunden werden.

## NUMBER PLATE LAMP

In order to make the number plate as visible as possible, the Aspöck range offers registration plates in different designs.

Due to the different connections, the lamp can be easily and quickly connected with the existing cable system.

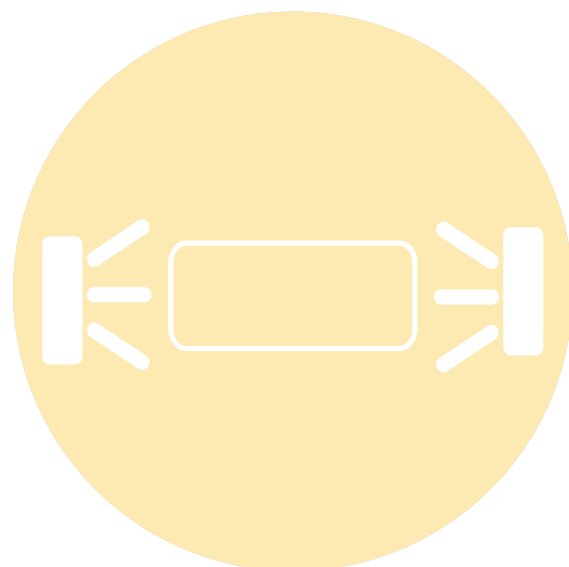









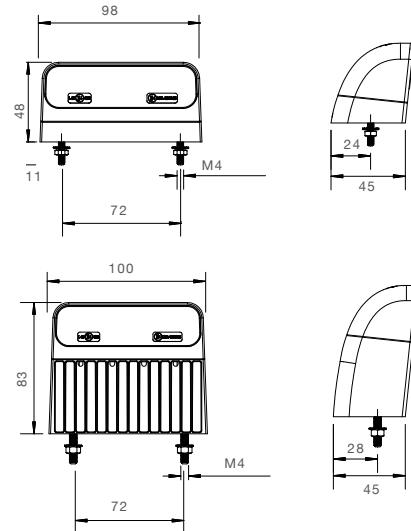

















































# REGPOINT II LED

ADR  
Zone 2

IP 54



 Kennzeichenlicht  
Number plate light

BEST. NR					ZUSATZ	ANSCHLUSS
PART NO					ADD ON	CONNECTOR
36-3804-004	1/-	LED	12V 24V			P&R  0,50 m 
36-3804-014	1/-	LED	12V 24V			P&R  2,00 m 
36-3806-004	1/-	LED	12V 24V			2 pol. ASS2  2 pin ASS2   0,50 m 
36-3805-004	1/-	LED	12V 24V			2 pol. ASS2  2 pin ASS2   2,00 m 
36-3807-004	1/-	LED	12V 24V			2 pol. Superseal  2 pin Superseal   0,50 m 
36-3810-004	1/-	LED	12V 24V			3 pol. ASS3  3 pin ASS3   0,50 m 
36-3864-004	1/-	LED	12V 24V		für Einzelbau for single mounting	P&R  0,50 m 
36-3864-014	1/-	LED	12V 24V		für Einzelbau for single mounting	P&R  2,00 m 
36-3867-014	1/-	LED	12V 24V		für Einzelbau for single mounting	2 pol. ASS2  2 pin ASS2   0,50 m 
36-3867-024	1/-	LED	12V 24V		für Einzelbau for single mounting	2 pol. ASS2  2 pin ASS2   2,00 m 
36-3865-004	1/-	LED	12V 24V		für Einzelbau for single mounting	3 pol. ASS3  3 pin ASS3   0,50 m 
36-3867-004	1/-	LED	12V 24V		für Einzelbau for single mounting	2 pol. Superseal  2 pin Superseal   0,50 m 



# REGPOINT II LED

ZUBEHÖR / ACCESSORIES

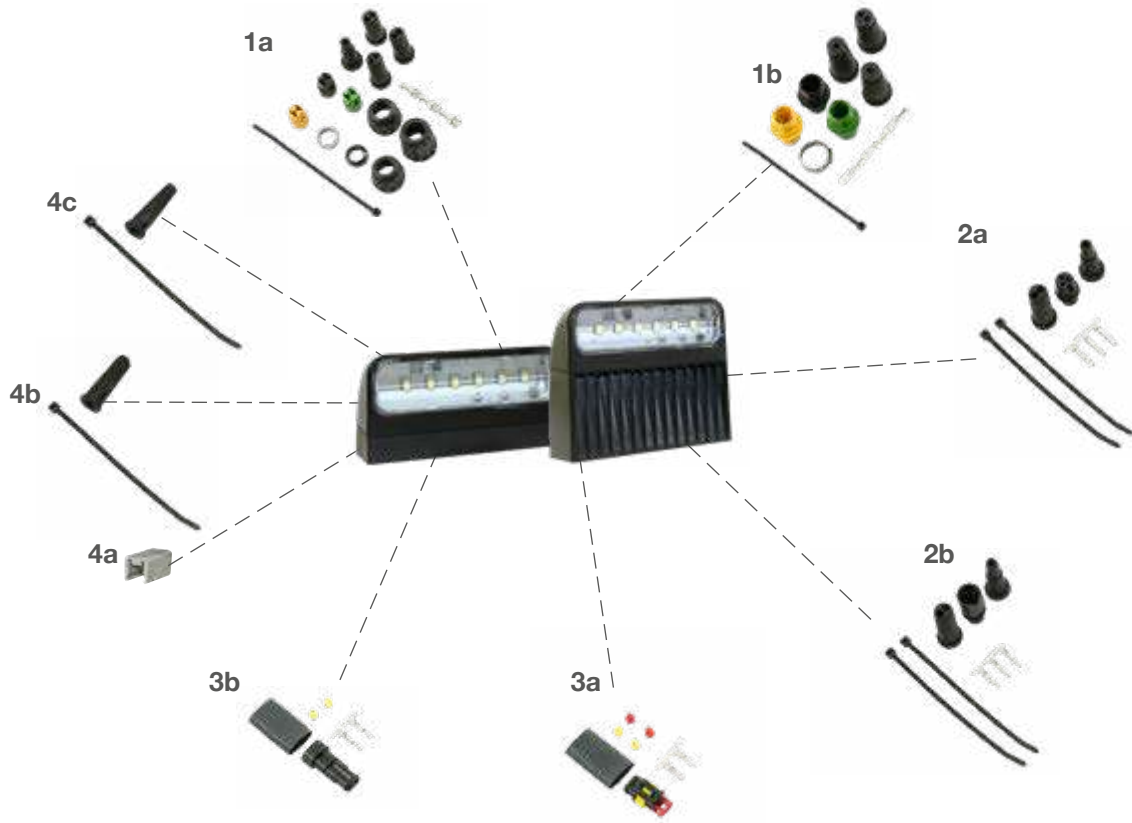

- 1 ASS1 & ASS2 Verbinder | ASS1 & ASS2 connector**
- (a) 2 pol. weiblich  
2 pin female ..... 13-5626-401
  - (b) 2 pol. männlich  
2 pin male ..... 13-5625-991
- 2 ASS3 Verbinder | ASS3 connector**
- (a) 3 pol. weiblich  
3 pin female ..... 13-0322-281
  - (b) 3 pol. männlich  
3 pin male ..... 13-0332-281
- 3 Superseal Verbinder | Superseal connector**
- (a) 2 pol. weiblich  
2 pin female ..... 15-7002-044
  - (b) 2 pol. männlich  
2 pin male ..... 15-7002-054

- 4 für P&R Verbinder | for P&R connector**
- (a) Verschlusskappen  
caps ..... 15-5971-014
  - (b) Endkappen rund  
end caps round ..... 15-5983-024
  - (c) Endkappen eckig  
end caps square ..... 15-5729-014











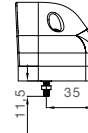
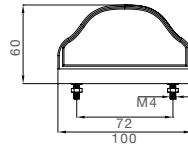
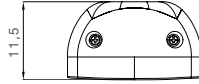





















































# REGPOINT LED

ADR  
Zone 2

IP 54



Kennzeichenlicht  
Number plate light

BEST. NR				ZUSATZ	ANSCHLUSS
PART NO				ADD ON	CONNECTOR
36-3607-004	1/-	LED	24V		2 pol. ASS2 2 pin ASS2 ♀    0,50 m 
36-3607-034	1/-	LED	24V		2 pol. ASS2 2 pin ASS2 ♀    0,80 m 
36-3607-014	1/-	LED	24V		2 pol. ASS2 2 pin ASS2 ♀    1,00 m 
36-3607-024	1/-	LED	24V		2 pol. ASS2 2 pin ASS2 ♀    3,50 m 
36-3607-074	1/-	LED	24V		3 pol. ASS3 3 pin ASS3 ♀    0,50 m 
36-3607-094	1/-	LED	24V		3 pol. ASS3 3 pin ASS3 ♀    1,00 m 
36-3690-004	1/-	LED	24V		2 pol. AFK plus lear 2 pin AFK plus lear   0,50 m 
36-3690-034	1/-	LED	24V		2 pol. Deutsch 2 pin Deutsch ♂    0,17 m 
36-3600-044	1/-	LED	24V		2 pol. Superseal 2 pin Superseal ♀    0,25 m 
36-3690-014	1/-	LED	24V		2 pol. Superseal 2 pin Superseal ♂    3,50 m 
36-3690-024	1/-	LED	24V		2 pol. Superseal 2 pin Superseal ♀    1,20 m 
36-3690-044	1/-	LED	24V		2 pol. Superseal 2 pin Superseal ♂    0,15 m 
36-3600-004	1/-	LED	24V		offenes Ende open end 0,50 m 
36-3600-014	1/-	LED	24V		offenes Ende open end 1,00 m 
36-3600-024	1/-	LED	24V		offenes Ende open end 3,50 m 
36-3604-004	1/-	LED	24V		P&R   0,50 m 
36-3604-014	1/-	LED	24V		P&R   1,00 m 
36-3604-024	1/-	LED	24V		P&R   3,50 m 





# REGPOINT LED

ZUBEHÖR / ACCESSORIES

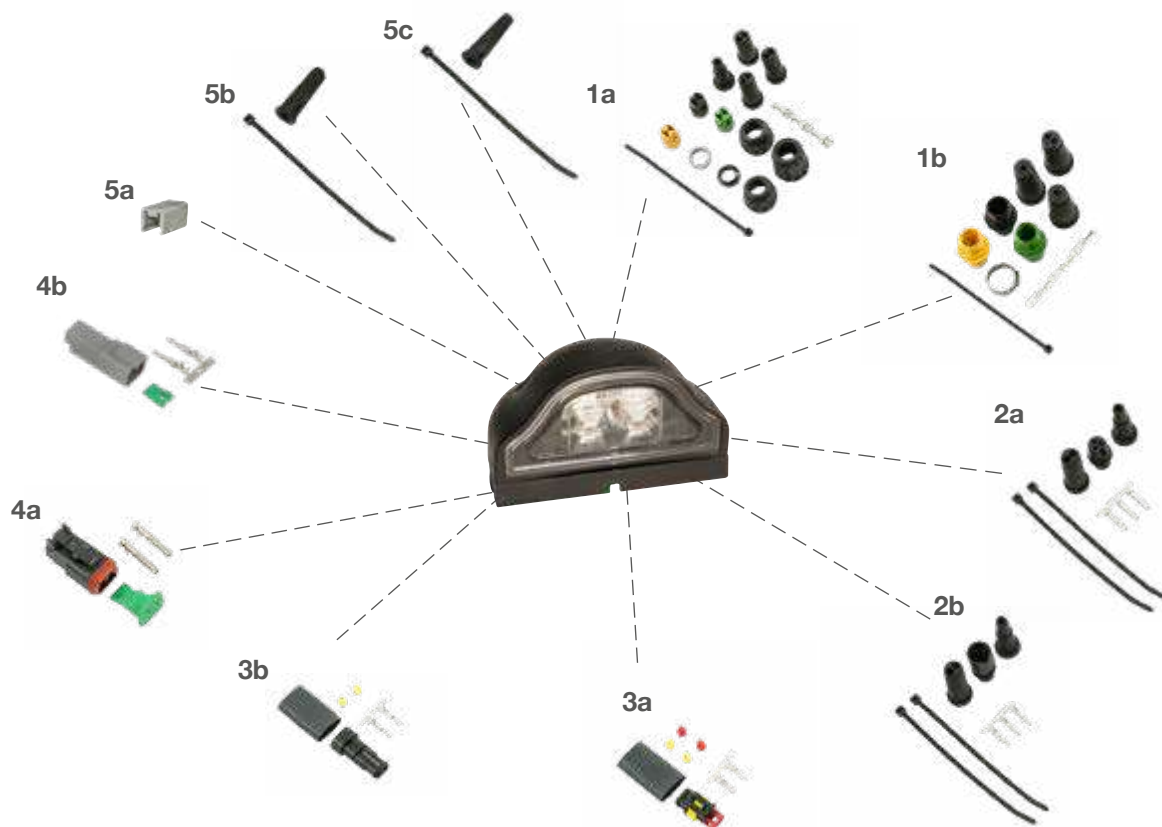

## 1 ASS1 & ASS2 Verbinder ASS1 & ASS2 connector

- (a) 2 pol. weiblich  
2 pin female ..... 13-5626-401
- (b) 2 pol. männlich  
2 pin male ..... 13-5625-991

## 2 ASS3 Verbinder | ASS3 connector

- (a) 3 pol. weiblich  
3 pin female ..... 13-0322-281
- (b) 3 pol. männlich  
3 pin male ..... 13-0332-281

## 3 Superseal Verbinder | Superseal connector

- (a) 2 pol. weiblich  
2 pin female ..... 15-7002-044
- (b) 2 pol. männlich  
2 pin male ..... 15-7002-054

## 4 Deutsch Verbinder | Deutsch connector

- (a) 2 pol. weiblich  
2 pin female ..... 15-7002-135
- (b) 2 pol. männlich  
2 pin male ..... 15-7002-125

## 5 für P&R Verbinder | for P&R connector

- (a) Verschlusskappen  
caps ..... 15-5971-014
- (b) Endkappen rund  
end caps round ..... 15-5983-024
- (c) Endkappen eckig  
end caps square ..... 15-5729-014









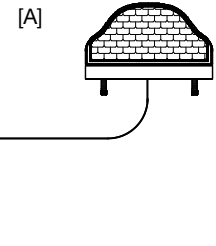
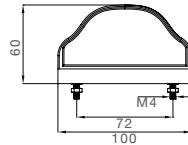
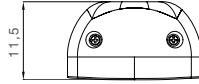









































# REGPOINT

ADR  
Zone 2

IP 54



 Kennzeichenlicht  
Number plate light

BEST. NR				ZUSATZ	ANSCHLUSS	
PART NO				ADD ON	CONNECTOR	
36-3002-014	1/-		24V		offenes Ende open end	1,00 m 
36-3003-014	1/-		24V		offenes Ende open end	0,30 m 
36-3004-014	1/-		24V	M4x16	P&R 	0,50 m 
36-3004-024	1/-		24V		P&R 	1,00 m 
36-3004-034	1/-		24V		P&R 	1,50 m 
36-3004-044	1/-		24V		P&R 	2,00 m 
36-3004-054	1/-		24V		P&R 	3,50 m 
36-3007-284	1/-		24V		2 pol. ASS2 2 pin ASS2 	0,55 m 
36-3007-254	1/-		24V		2 pol. ASS2 2 pin ASS2 	1,20 m 
36-3007-084	1/-		24V		2 pol. ASS2 2 pin ASS2 	3,50 m 
36-3007-394	1/-		24V	M4x16	3 pol. ASS3 3 pin ASS3 	0,50 m 
36-3007-464	1/-		24V	M4x35	3 pol. ASS3 3 pin ASS3 	0,50 m 
36-3007-264	1/-		24V	[A]	2 pol. ASS2 2 pin ASS2  2 pol. ASS2 2 pin ASS2 	1,02 m  0,2 m 
36-3000-134	1/-		24V		2 pol. Superseal 2 pin Superseal 	1,20 m 
36-3007-574	1/-		24V		2 pol. ASS2 2 pin ASS2 	0,70 m 



# REGPOINT

ZUBEHÖR / ACCESSORIES

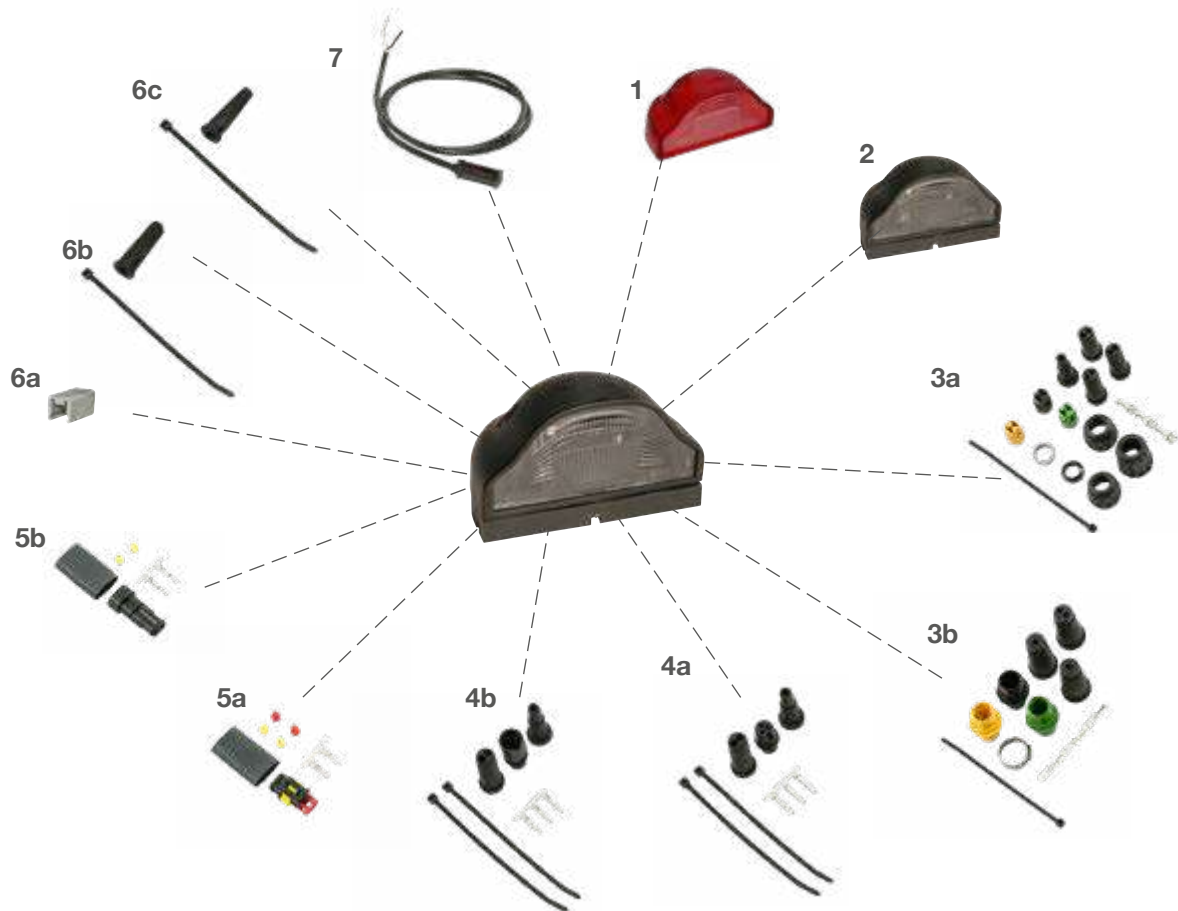

**1** Lichtscheibe | lens  
transparent rot  
transparent red ..... 18-8630-104

**2** Ersatzteilleuchte |  
spare part lamp  
weiß mit Schrauben  
white with screws ..... 26-3000-004

**3** ASS1 & ASS2 Verbinder |  
ASS1 & ASS2 connector  
(a) 2 pol. weiblich  
2 pin female ..... 13-5626-401   
(b) 2 pol. männlich  
2 pin male ..... 13-5625-991

**4** ASS3 Verbinder | ASS3 connector  
(a) 3 pol. weiblich  
3 pin female ..... 13-0322-281   
(b) 3 pol. männlich  
3 pin male ..... 13-0332-281

**5** Superseal Verbinder | Superseal connector  
(a) 2 pol. weiblich  
2 pin female ..... 15-7002-044   
(b) 2 pol. männlich  
2 pin male ..... 15-7002-054

**6** für P&R Verbinder |  
for P&R connector  
(a) Verschlusskappen  
caps ..... 15-5971-014   
(b) Endkappen rund  
end caps round ..... 15-5983-024   
(c) Endkappen eckig  
end caps square ..... 15-5729-014

**7** Zuleitung P&R | front connection P&R  
0,5 m ..... 68-5000-574   
1,5 m ..... 68-5000-604   
2,0 m ..... 68-5000-624   
5,0 m ..... 68-5000-634



REGPOINT rot  
red

ADR  
Zone 2

IP 54

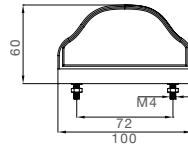
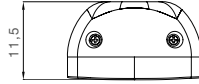

Kennzeichenlicht  
Number plate light

BEST. NR				ZUSATZ	ANSCHLUSS		
PART NO				ADD ON	CONNECTOR		
36-3004-184	1/-		24V		P&R		0,50 m
36-3004-084	1/-		24V		P&R		1,50 m

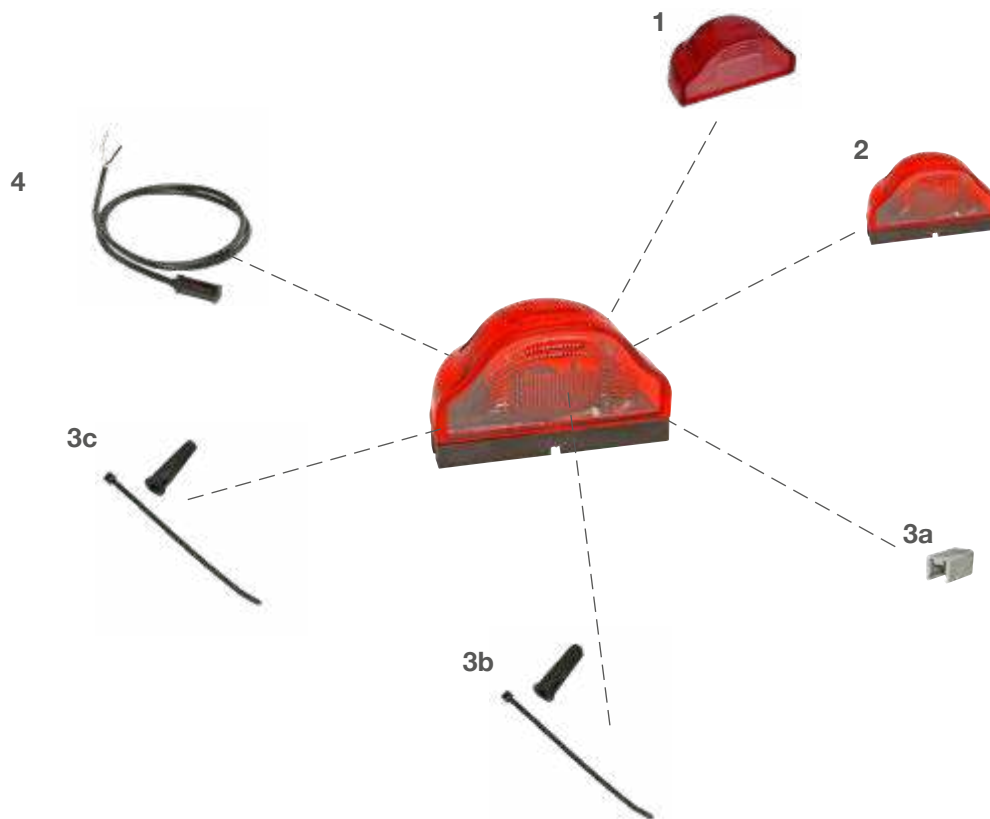

**1** **Lichtscheibe | lens**  
transparent rot  
transparent red ..... 18-8630-104

**2** **Ersatzteileuchte | spare part lamp**  
rot mit Schrauben  
red with screws ..... 26-3010-004

**3** **für P&R Verbinder | for P&R connector**  
(a) Verschlusskappen  
caps ..... 15-5971-014   
(b) Endkappen rund  
end caps round ..... 15-5983-024   
(c) Endkappen eckig  
end caps square ..... 15-5729-014

**4** **Zuleitung P&R | front connection P&R**  
0,5 m ..... 68-5000-574   
1,5 m ..... 68-5000-604   
2,0 m ..... 68-5000-624   
5,0 m ..... 68-5000-634







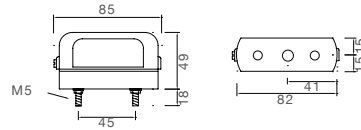











REGPOINT klein  
small



 Kennzeichenlicht  
Number plate light

BEST. NR				ZUSATZ ADD ON	ANSCHLUSS CONNECTOR
26-1200-004	1/-	-			Tülleneingang grommet  
36-1204-034	1/-		24V		P&R   0,50 m 
36-1207-004	1/-		24V		2 pol. ASS2  2 pin ASS2   1,50 m 



REGPOINT klein  
small

ZUBEHÖR / ACCESSORIES

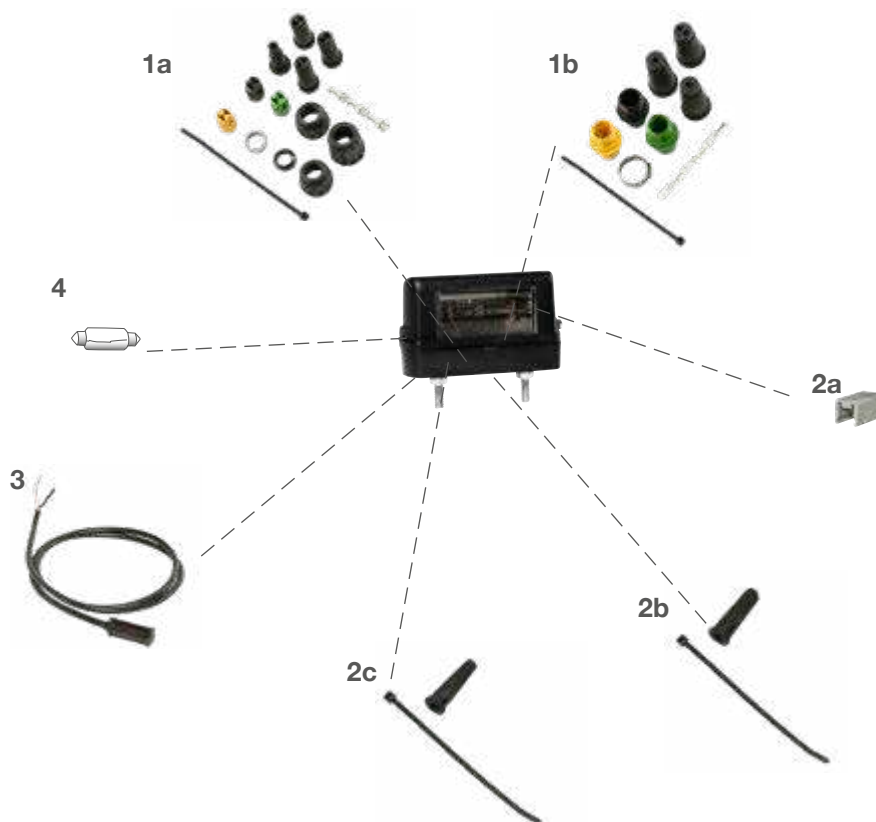

**1** ASS1 & ASS2 Verbinder |  
ASS1 & ASS2 connector

- (a) 2 pol. weiblich  
2 pin female ..... 13-5626-401
- (b) 2 pol. männlich  
2 pin male ..... 13-5625-991

**2** für P&R Verbinder |  
for P&R connector

- (a) Verschlusskappen  
caps ..... 15-5971-014
- (b) Endkappen rund  
end caps round ..... 15-5983-024
- (c) Endkappen eckig  
end caps square ..... 15-5729-014

**3** Zuleitung P&R | front connection P&R  
0,5 m ..... 68-5000-574

**4** Soffitte  
24V 5W ..... 16-6705-017

# FRYSPÖCK<sup>®</sup>

## SYSTEMS





## BREMSLEUCHE

Aspöck Bremsleuchten sind wahlweise als Einbau- oder Aufbauversionen erhältlich. Sie eignen sich ideal zum Austausch von bestehenden Bremsleuchten, zur Aufrüstung als LED oder auch zum ergänzenden Anbau.

## STOP LAMP

Aspöck brake lights are available either as integrated or as mounted versions. They are ideal for the replacement of existing brake lights, as LED retrofits or also for supplementary attachment.





### 3. BREMSLEUCHE / 3<sup>rd</sup> STOP LIGHT

ADR Zone 2 IP 6K9K

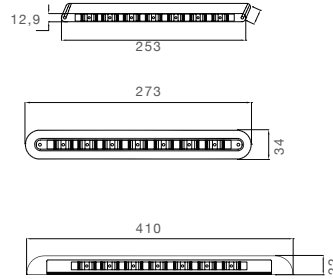

BEST. NR					ZUSATZ	ANSCHLUSS	
PART NO		LED	24V		ADD ON	CONNECTOR	
31-8900-024	1/-	LED	24V		Einbauversion lamp built in	offenes Ende open end	2,00 m
31-8900-044	1/-	LED	24V		Einbauversion lamp built-in	offenes Ende open end	6,00 m
31-8907-004	1/-	LED	24V		Einbauversion lamp built-in	2 pol. ASS2 2 pin ASS2	2,00 m
31-8907-014	1/-	LED	24V		inkl. Rahmen incl. housing	2 pol. ASS2 2 pin ASS2	2,00 m
31-8910-014	1/-	LED	24V		inkl. Rahmen incl. housing	offenes Ende open end	0,50 m
31-8910-024	1/-	LED	24V		inkl. Rahmen incl. housing	offenes Ende open end	2,00 m
31-9000-054	1/-	LED	24V		Aufbauversion lamp surface mount	offenes Ende open end	2,00 m
31-9007-014	1/-	LED	24V		Aufbauversion lamp surface mount	2 pol. ASS2 2 pin ASS2	2,00 m



### 3. BREMSLEUCHE / 3<sup>rd</sup> STOP LIGHT

ZUBEHÖR / ACCESSORIES

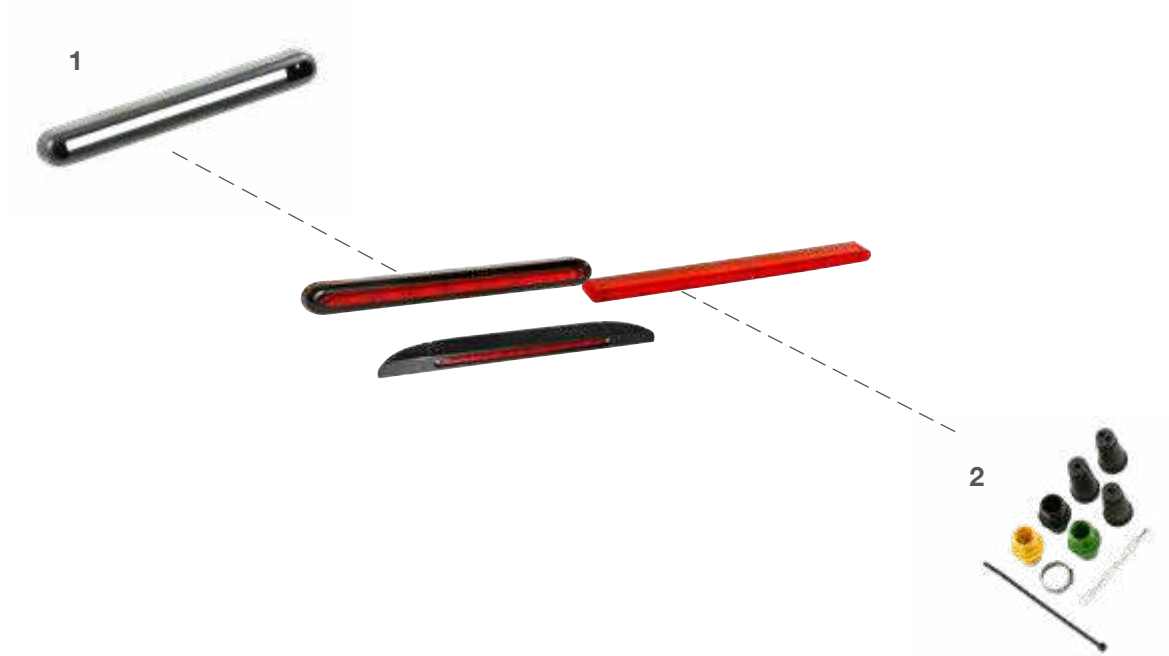

**1** Rahmen | housing  
..... 15-5203-004

**2** ASS1 & ASS2 Verbinder |  
ASS1 & ASS2 connector  
(a) 2 pol. weiblich  
2 pin female ..... 13-5626-401   
(b) 2 pol. männlich  
2 pin male ..... 13-5625-991

FRANK®

E M S



ERSATZTEILE | SPARE PARTS

## **RÜCKFAHRLEUCHE ARBEITSSCHEINWERFER**

Die Rückfahr- und Arbeitsscheinwerfer von Aspöck werden für maximale Beständigkeit unter extremen Bedingungen entwickelt. Langlebigkeit, hohe Lichtleistung und geringe Stromaufnahme sorgen dafür, dass der Arbeitsplatz auch bei schlechten Lichtverhältnissen und jedem Wetter optimal ausgeleuchtet ist.

## **REVERSE LAMP WORKING LAMP**

The reverse lights and working lights by Aspöck have been developed for maximum resistance under extreme conditions. Longevity, high light output and low power consumption ensure that the workplace can be optimally illuminated even in poor light conditions and in any weather.





# RÜCKFAHRSCHEINWERFER / REVERSE LAMP ARBEITSSCHEINWERFER / WORKING LAMP

ADR Zone 2 IP 5K4K

21W

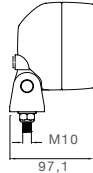
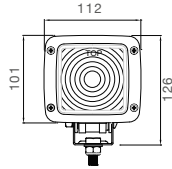

70W

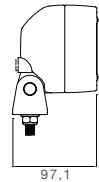
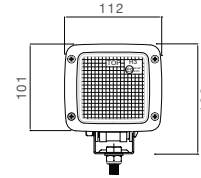

BEST. NR					ZUSATZ	ANSCHLUSS	
PART NO					ADD ON	CONNECTOR	
28-9100-001	1/-		24V		<b>70W</b>	Tülleneingang grommet	
38-9000-001	1/-		24V		<b>21W</b>	offenes Ende open end	2,50 m
38-9100-001	1/-		24V		<b>70W</b>	offenes Ende open end	2,50 m
38-9007-011	1/-		24V		<b>21W</b>	2 pol. ASS2 2 pin ASS2	2,50 m
38-9107-011	1/-		24V		<b>70W</b>	2 pol. ASS2 2 pin ASS2	2,50 m
38-9010-001	-/-		24V		<b>21W</b>	2 pol. Superseal 2 pin AMP	0,25 m
38-9100-081	-/-		24V		<b>70W</b>	2 pol. Deutsch 2 pin Deutsch	2,25 m



# RÜCKFAHRSCHEINWERFER / REVERSE LAMP ARBEITSSCHEINWERFER / WORKING LAMP

ZUBEHÖR /  
ACCESSORIES



- 1 ASS1 & ASS2 Verbinder | ASS1 & ASS2 connector**
- (a) 2 pol. weiblich  
2 pin female ..... 13-5626-401
  - (b) 2 pol. männlich  
2 pin male ..... 13-5625-991
- 2 Superseal Verbinder | Superseal connector**
- (a) 2 pol. weiblich  
2 pin female ..... 15-7002-044
  - (b) 2 pol. männlich  
2 pin male ..... 15-7002-054

- 3 Deutsch Verbinder | Deutsch connector**
- (a) 2 pol. weiblich  
2 pin female ..... 15-7002-135
  - (b) 2 pol. männlich  
2 pin male ..... 15-7002-125
- 4 Glühlampe | bulb**
- 24V 70W H3 ..... 16-6456-001
  - 24V 21W ..... 16-6321-037



# RÜCKFAHRSCHEINWERFER LED / REVERSE LAMP LED

ADR Zone 2 IP 56K

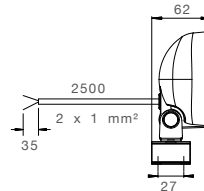
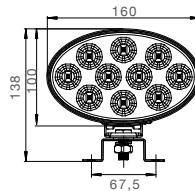

BEST. NR				ZUSATZ	ANSCHLUSS
PART NO				ADD ON	CONNECTOR
38-8200-001	1/-		12V 24V	-40°C bis +80°C	offenes Ende open end 2,50 m
38-8207-001	1/-		12V 24V	-40°C bis +80°C	2 pol. ASS2    2 pin ASS2 2,50 m
38-8207-011	1/-		12V 24V	-40°C bis +80°C	2 pol. Superseal    2 pin Superseal 2,50 m

Rückfahrlicht  
 Arbeitsscheinwerfer  
 Reverse Lamp  
 Working Lamp





# RÜCKFAHRSCHEINWERFER LED / REVERSE LAMP LED

ZUBEHÖR /  
ACCESSORIES



## 1 ASS1 & ASS2 Verbinder | ASS1 & ASS2 connector

- (a) 2 pol. weiblich  
2 pin female ..... 13-5626-401
- (b) 2 pol. männlich  
2 pin male ..... 13-5625-991

## 2 Superseal Verbinder | Superseal connector

- (a) 2 pol. weiblich  
2 pin female ..... 15-7002-044
- (b) 2 pol. männlich  
2 pin male ..... 15-7002-054



# WORKPOINT LED 3000

ADR Zone 2 IP 6K9K

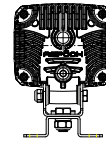
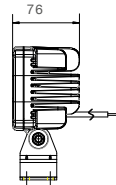
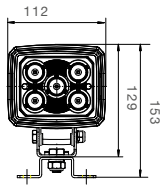

Arbeitsscheinwerfer  
Working light

BEST. NR				ZUSATZ	ANSCHLUSS
PART NO				ADD ON	CONNECTOR
38-8221-001	1/-		12V 24V	-40°C bis +80°C	offenes Ende open end 1,50 m
38-8221-101	1/-		12V 24V	-40°C bis +80°C	offenes Ende open end 1,50 m
38-8227-001	1/-		12V 24V	-40°C bis +80°C	2 pol. ASS2    1,50 m
38-8227-101	1/-		12V 24V	-40°C bis +80°C	2 pol. ASS2    1,50 m

Rückleuchte  
Arbeitsscheinwerfer  
Reverse Lamp  
Working Lamp



# WORKPOINT LED 3000

ZUBEHÖR / ACCESSORIES

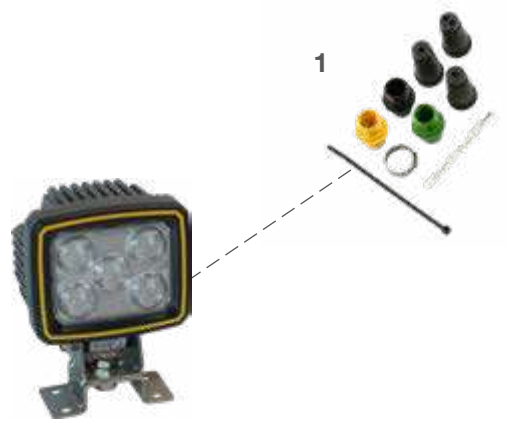

## 1 ASS1 & ASS2 Verbinder | ASS1 & ASS2 connector

- (a) 2 pol. weiblich  
2 pin female ..... 13-5626-401 
- (b) 2 pol. männlich  
2 pin male ..... 13-5625-991 



# WORKPOINT LED 1500

ADR Zone 2 IP 6K9K

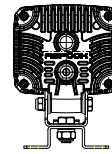
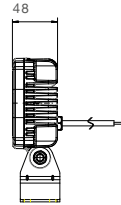
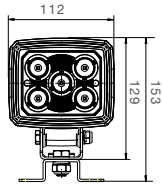

Rückfahrlicht Reverse light	Arbeitsscheinwerfer Working light
--------------------------------	--------------------------------------

BEST. NR				ZUSATZ	ANSCHLUSS
PART NO				ADD ON	CONNECTOR
38-8220-001	1/-	LED	12V 24V	1500 LUMEN 25W  -40°C bis +80°C	offenes Ende open end 1,50 m
38-8220-011	1/-	LED	12V 24V	1500 LUMEN 25W  -40°C bis +80°C	offenes Ende open end 7,50 m
38-8226-101	1/-	LED	12V 24V	1500 LUMEN 25W  -40°C bis +80°C	2 pol. Superseal 2 pin Superseal   0,40 m
38-8226-111	1/-	LED	12V 24V	1500 LUMEN 25W  -40°C bis +80°C	2 pol. Superseal 2 pin Superseal   1,50 m
38-8226-001	1/-	LED	12V 24V	1500 LUMEN 25W  -40°C bis +80°C	2 pol. ASS2 2 pin ASS2   1,50 m
38-8227-021	1/-	LED	12V 24V	1500 LUMEN 25W  -40°C bis +80°C	2 pol. ASS3 2 pin ASS3   0,50 m
38-8204-011	1/-	LED	12V 24V	1500 LUMEN 25W  -40°C bis +80°C	P&R  0,50 m
38-8220-021	1/-	LED	12V 24V	1500 LUMEN 25W  -40°C bis +80°C	2 pol. Deutsch 2 pin Deutsch   0,25 m

Rückfahrleuchte  
Arbeitsscheinwerfer  
Reverse Lamp  
Working Lamp



# WORKPOINT LED 1500

Zubehör / accessories

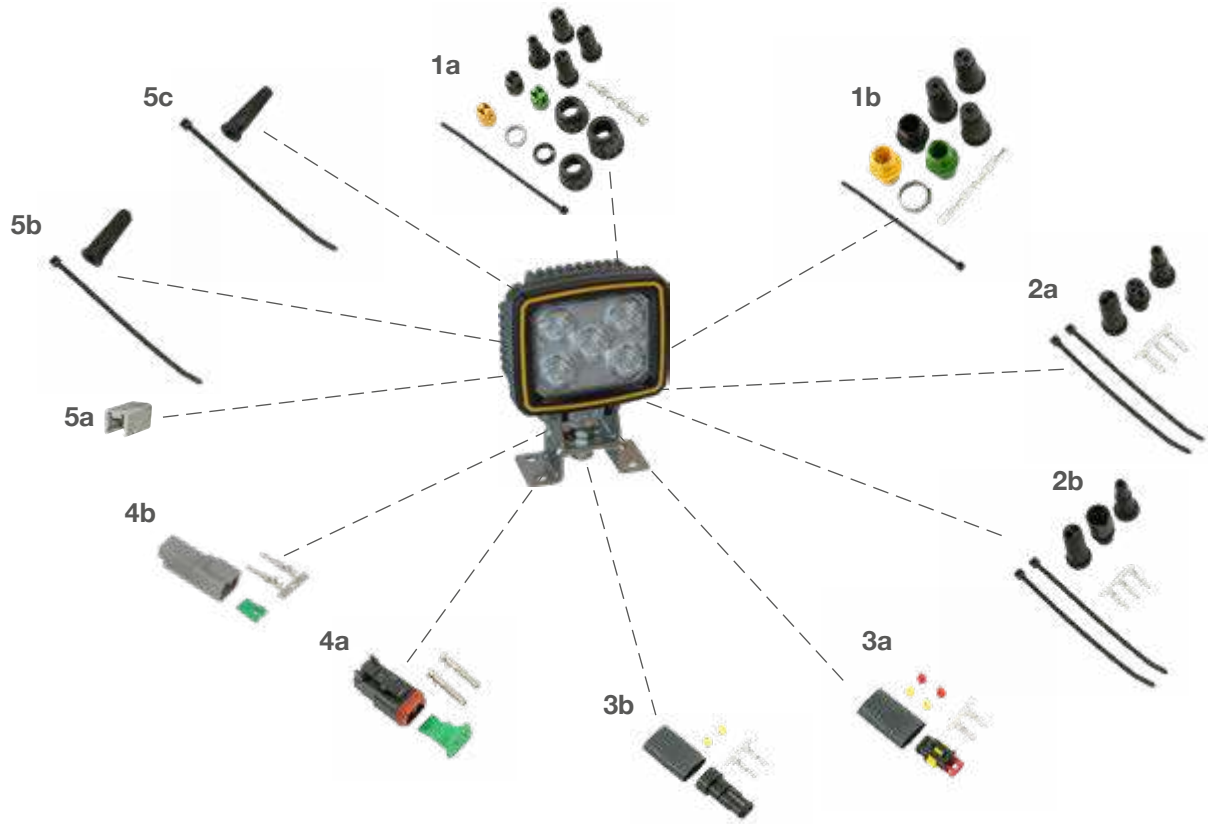

- 1 ASS1 & ASS2 Verbinder | ASS1 & ASS2 connector**
- (a) 2 pol. weiblich  
2 pin female ..... 13-5626-401
  - (b) 2 pol. männlich  
2 pin male ..... 13-5625-991
- 2 ASS3 Verbinder | ASS3 connector**
- (a) 3 pol. weiblich  
3 pin female ..... 13-0322-281
  - (b) 3 pol. männlich  
3 pin male ..... 13-0332-281
- 3 Superseal Verbinder | Superseal connector**
- (a) 2 pol. weiblich  
2 pin female ..... 15-7002-044
  - (b) 2 pol. männlich  
2 pin male ..... 15-7002-054

- 4 Deutsch Verbinder | Deutsch connector**
- (a) 2 pol. weiblich  
2 pin female ..... 15-7002-135
  - (b) 2 pol. männlich  
2 pin male ..... 15-7002-125
- 5 für P&R Verbinder | for P&R connector**
- (a) Verschlusskappen  
caps ..... 15-5971-014
  - (b) Endkappen rund  
end caps round ..... 15-5983-024
  - (c) Endkappen eckig  
end caps square ..... 15-5729-014



# WORKPOINT LED 800

ADR Zone 2 IP 56K

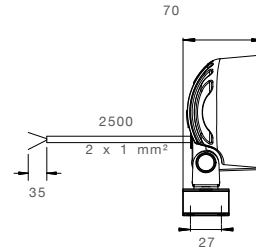
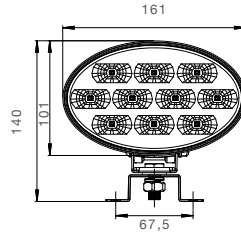

Arbeitsscheinwerfer  
Working light

BEST. NR				ZUSATZ	ANSCHLUSS
PART NO				ADD ON	CONNECTOR
39-6800-011	1/-		12V 24V		offenes Ende open end 2,50 m
39-6801-001	1/-		12V 24V		2 pol. Superseal
39-6807-001	1/-		12V 24V		2 pol. ASS2    2,50 m

Rückleuchte  
Arbeitsscheinwerfer  
Reverse Lamp  
Working Lamp



# WORKPOINT LED 800

Zubehör / accessories

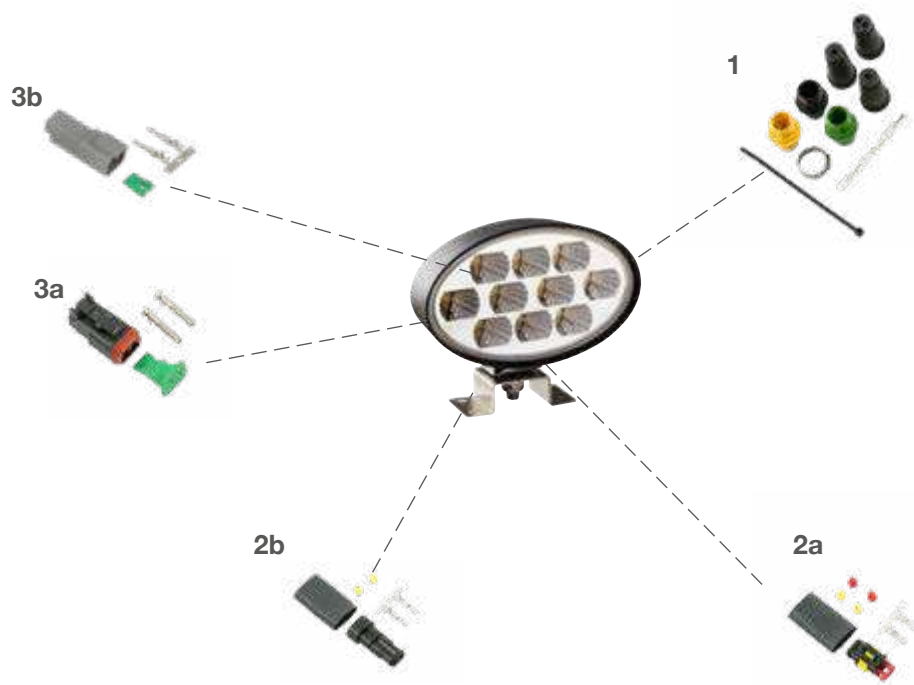

## 1 ASS1 & ASS2 Verbinder | ASS1 & ASS2 connector

- (a) 2 pol. weiblich  
2 pin female ..... 13-5626-401
- (b) 2 pol. männlich  
2 pin male ..... 13-5625-991

## 2 Superseal Verbinder | Superseal connector

- (a) 2 pol. weiblich  
2 pin female ..... 15-7002-044
- (b) 2 pol. männlich  
2 pin male ..... 15-7002-054

## 3 Deutsch Verbinder | Deutsch connector

- (a) 2 pol. weiblich  
2 pin female ..... 15-7002-135
- (b) 2 pol. männlich  
2 pin male ..... 15-7002-125











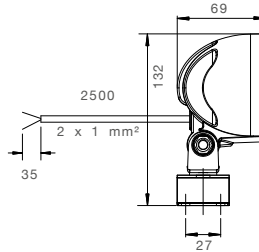
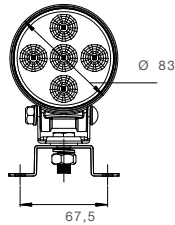

























# WORKPOINT LED 650

ADR  
Zone 2

IP 56K



 Arbeitsscheinwerfer  
Working light

BEST. NR				ZUSATZ	ANSCHLUSS
PART NO				ADD ON	CONNECTOR
39-6400-011	1/-		12V 24V	 	offenes Ende open end 2,50 m 
39-6400-031	1/-		12V 24V	 	2 pol. Superseal   2 pin Superseal 2,50 m 
39-6407-001	1/-		12V 24V	 	2 pol. ASS2   2 pin ASS2 2,50 m 
39-6407-011	1/-		12V 24V	 	2 pol. ASS2   2 pin ASS2 1,50 m 
39-6400-041	1/-		12V 24V	 	2 pol. Deutsch   2 pin Deutsch 0,30 m 

Rückleuchte  
Arbeitsscheinwerfer  
Reverse Lamp  
Working Lamp





# WORKPOINT LED 650

Zubehör / accessories

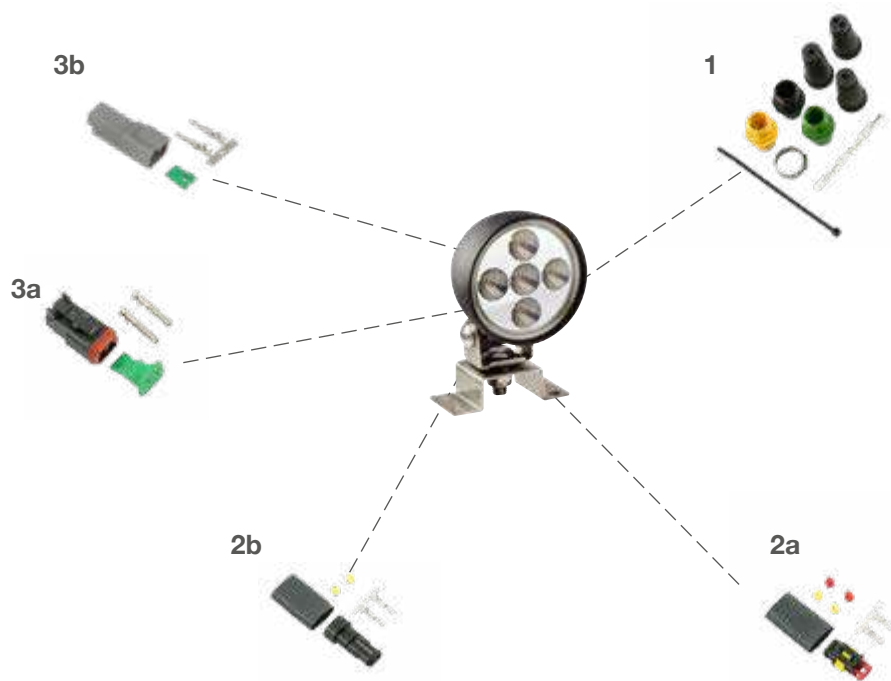

## 1 ASS1 & ASS2 Verbinder | ASS1 & ASS2 connector

- (a) 2 pol. weiblich  
2 pin female ..... 13-5626-401
- (b) 2 pol. männlich  
2 pin male ..... 13-5625-991

## 2 Superseal Verbinder | Superseal connector

- (a) 2 pol. weiblich  
2 pin female ..... 15-7002-044
- (b) 2 pol. männlich  
2 pin male ..... 15-7002-054

## 3 Deutsch Verbinder | Deutsch connector

- (a) 2 pol. weiblich  
2 pin female ..... 15-7002-135
- (b) 2 pol. männlich  
2 pin male ..... 15-7002-125

# FAPÖÖKX<sup>®</sup>

## S T E M S



## INNENLEUCHE

Um den Innenraum eines Fahrzeuges oder Anhängers auszuleuchten, befindet sich in der Produktpalette von Aspöck ein Sortiment an Leuchten, welche ideal für diesen Bereich geeignet sind. Verschiedene Formen und unterschiedliche Leuchtkraft runden das Angebot ab.

## INTERIOR LAMP

In order to illuminate the interior of a vehicle or a trailer, Aspöck features an assortment of lamps in its product spectrum which are ideally suitable for this area. Different shapes and luminosities round off the range of offers.





INPOINT III LED lang, kurz,  
long, short

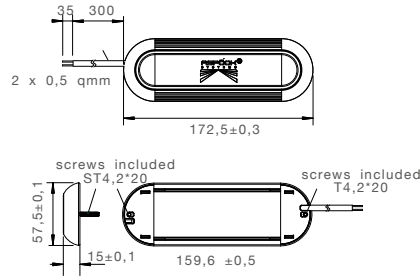
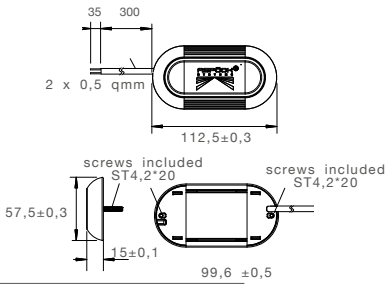

BEST. NR					ZUSATZ			ANSCHLUSS
PART NO					ADD ON			CONNECTOR
39-8900-001	1/-	LED	12V 24V		lang long	-40°C bis +80°C 6000 +/- 500k	IP 6K9K 1400 LUMEN	offenes Ende open end 0,30 m
39-8900-051	1/-	LED	12V 24V		lang, mit Bewegungssensor long, with motion sensor	-40°C bis +80°C 6000 +/- 500k	IP 67 1400 LUMEN	offenes Ende open end 0,30 m
39-8900-101	1/-	LED	12V 24V		lang, mit Schalter long, with switch	-40°C bis +80°C 6000 +/- 500k	IP 6K9K 1400 LUMEN	offenes Ende open end 0,30 m
39-8900-151	1/-	LED	12V 24V		kurz short	-40°C bis +80°C 6000 +/- 500k	IP 6K9K 700 LUMEN	offenes Ende open end 0,30 m
39-8900-201	1/-	LED	12V 24V		kurz, mit Bewegungssensor short, with motion sensor	-40°C bis +80°C 6000 +/- 500k	IP 67 700 LUMEN	offenes Ende open end 0,30 m
39-8900-251	1/-	LED	12V 24V		kurz, mit Schalter short, with switch	-40°C bis +80°C 6000 +/- 500k	IP 6K9K 700 LUMEN	offenes Ende open end 0,30 m

ZUBEHÖR / ACCESSORIES

- 1 selbstklebende Gummiunterlage |  
selfadhesive rubber  
..... 15-5020-824









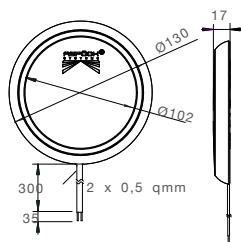













# INPOINT III LED rund round

ADR  
Zone 2



 **Innenlicht**  
Interior Light

BEST. NR					ZUSATZ	ANSCHLUSS
PART NO					ADD ON	CONNECTOR
39-8900-301	1/-		12V 24V		rund round -40°C bis +80°C 6000 +/- 500k  	offenes Ende open end 0,30 m 
39-8900-351	1/-		12V 24V		rund, mit Bewegungssensor round, with motion sensor -40°C bis +80°C 6000 +/- 500k  	offenes Ende open end 0,30 m 
39-8900-401	1/-		12V 24V		rund, mit Schalter round, with switch -40°C bis +80°C 6000 +/- 500k  	offenes Ende open end 0,30 m 



# INNENLEUCHE LED RUND INTERIOR LAMP LED ROUND

IP 69

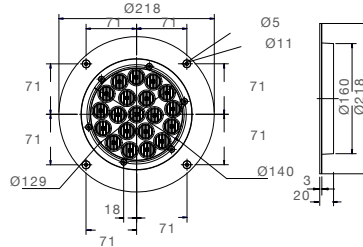

BEST. NR PART NO				ZUSATZ ADD ON	ANSCHLUSS CONNECTOR
29-8410-001	1/-	LED	12V 24V	140 LUMEN	offenes Ende open end 2 x 0,20 m
29-8410-101	1/-	LED	12V 24V	480 LUMEN	offenes Ende open end 2 x 0,20 m
39-8404-001	1/-	LED	12V 24V	140 LUMEN	P&R  0,25 m
39-8409-001	1/-	LED	12V 24V	140 LUMEN	offenes Ende open end 2 x 0,20 m

## ZUBEHÖR / ACCESSORIES

### 1 für P&R Verbinder | for P&R connector

- (a) Verschlusskappen  
caps..... 15-5971-014
- (b) Endkappen rund  
end caps round..... 15-5983-024
- (c) Endkappen eckig  
end caps square..... 15-5729-014

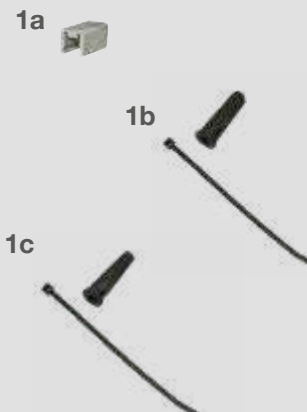



# INNENLEUCHE LED INTERIOR LAMP LED

ZUBEHÖR / ACCESSORIES

ADR Zone 2 IP 6K9K

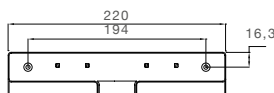

BEST. NR PART NO				ZUSATZ ADD ON	ANSCHLUSS CONNECTOR	
39-8700-011	-/-	LED	24V		offenes Ende open end	1,50 m
39-8704-001	-/-	LED	24V		P&R	0,25 m
39-8704-011	-/-	LED	24V		P&R	1,50 m
39-8707-001	-/-	LED	24V		3 pol. ASS3 3 pin ASS3	1,50 m

ZUBEHÖR / ACCESSORIES

- 1 ASS3 Verbinder | ASS3 connector**
  - (a) 3 pol. weiblich  
3 pin female ..... 13-0322-281
  - (b) 3 pol. männlich  
3 pin male ..... 13-0332-281
- 2 für P&R Verbinder | for P&R connector**
  - (a) Verschlusskappen  
caps ..... 15-5971-014
  - (b) Endkappen rund  
end caps round ..... 15-5983-024
  - (c) Endkappen eckig  
end caps square ..... 15-5729-014

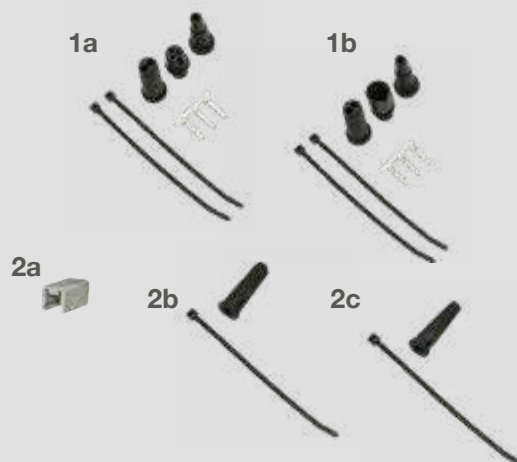



# TUBEPOINT LED

ADR Zone 2 IP 6K9K





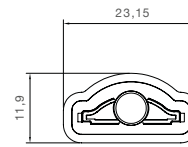



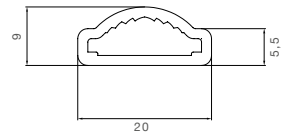

Abmessung Endkappe  
Dimension endcap



Abmessung Lichtscheibe  
Dimension Lens



 Innenlicht  
Interior Light

BEST. NR				ZUSATZ				ANSCHLUSS		
PART NO				ADD ON			CONNECTOR			
21-8004-011	1/-	LED	24V	450mm	-20°C bis +50°C 5700k	375 LUMEN	P&R		0,25 m	
21-8004-041	1/-	LED	24V	900mm	-20°C bis +50°C 5700k	750 LUMEN	P&R		0,25 m	
21-8004-071	1/-	LED	24V	1350mm	-20°C bis +50°C 5700k	1125 LUMEN	P&R		0,25 m	





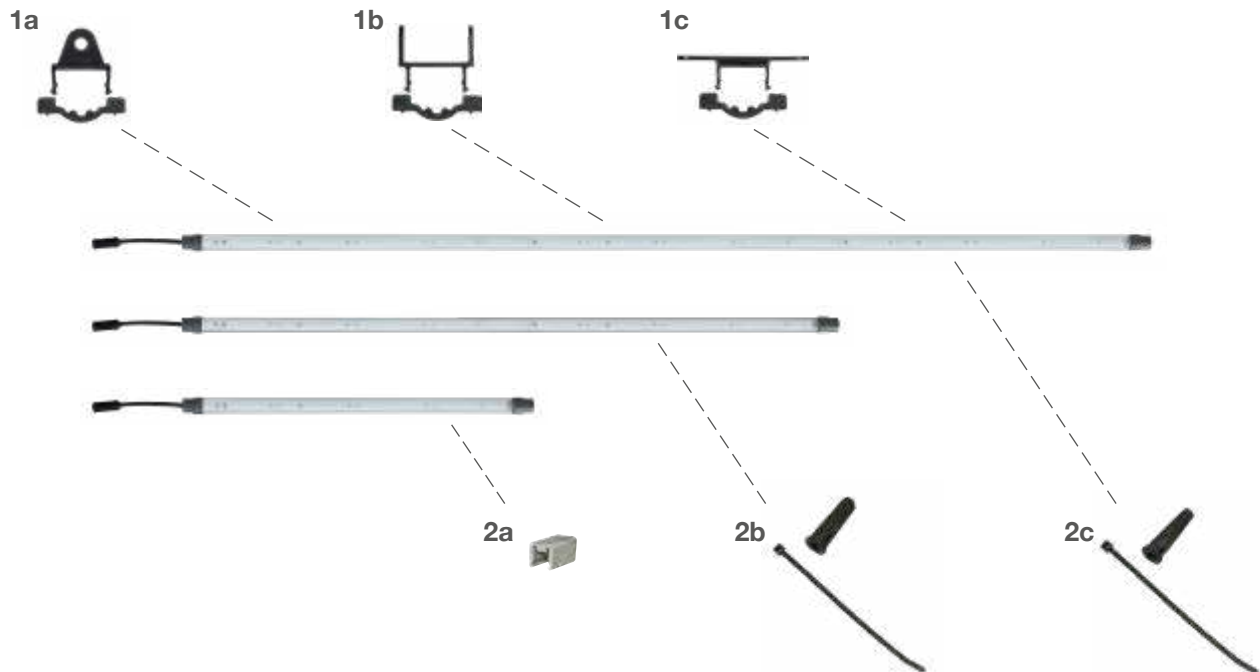

## TUBEPOINT LED

ZUBEHÖR / ACCESSORIES



### 1 Halterungen | brackets

- (a) Pendelhalter mit Verschlusskappe  
pendular bracket with fixation clip  
21-8007-144 ..... 
- (b) Halter für Profil mit Verschlusskappe  
profile bracket with fixation clip  
21-8007-154 ..... 
- (c) Halter für Direktanbau mit Verschlusskappe  
direct mounting bracket with fixation clip  
21-8007-164 ..... 

### 2 für P&R Verbinder | for P&R connector

- (a) Verschlusskappen  
caps ..... 15-5971-014 
- (b) Endkappen rund  
end caps round ..... 15-5983-024 
- (c) Endkappen eckig  
end caps square ..... 15-5729-014 

**FASFPÖÖKX<sup>®</sup>**

**S Y S T E M S**

## **ELEKTRONISCHES ZUBEHÖR VERBINDUNGSELEMENTE**

Zum einfachen Vergleich sind auf den nächsten Seiten sämtliche Aspöck LED Kontrollgeräte aufgelistet, welche die Produktbezeichnung „LCG“ tragen. Auch eine Übersicht aller erhältlichen Aspöck Verbindungselemente ist hier zu finden.

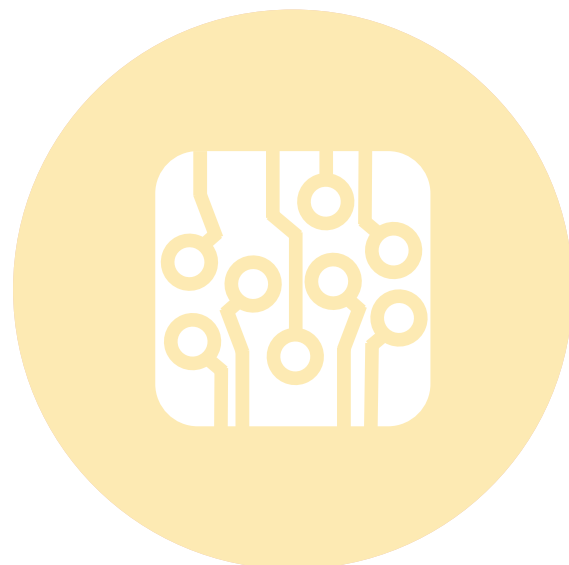

## **ELECTRONIC ACCESORIES CONNECTION ELEMENTS**

For simple comparison, all the Aspöck LED control devices bearing the product designation „LCG“ are listed on the following pages. You can also find an overview of all available Aspöck connection elements.



LCG

ÜBERSICHT / OVERVIEW

	LCG 1	LCG 1 - V2	LCG 2	
				
BEST. NR	75-0300-001	75-0300-107	75-0310-001	75-0309-001
PART NO				
$V$	24V	24V	24V	24V
ANHÄNGERERKENNUNG TRAILER DETECTION				
LED AUSFALLÜBERWACHUNG LED FAILURE DETECTION				
SIMULATION GLÜHBRINNE	  	  	  	 
POWER SIMULATION OF A BULB			  	  
BENÖTIGTE MENGE PRO FAHRZEUG	2	2	1	1
QUANTITY REQUIRED PER VEHICLE				
DAUERPLUS BENÖTIGT PERMANENT POWER REQUIRED				
KANN BEI FOLGENDEN LEUCHTEN VERWENDET WERDEN	bei allen Aspöck Heckleuchten ohne integriertem LCG	bei allen Aspöck Heckleuchten ohne integriertem LCG	bei allen Aspöck Heckleuchten ohne integriertem LCG	bei allen Aspöck Heckleuchten mit integriertem LCG für Blinker
USABLE FOR THE FOLLOWING LAMPS	All Aspöck rearlamps without integrated LCG	All Aspöck rearlamps without integrated LCG	All Aspöck rearlamps without integrated LCG	All Aspöck rearlamps with integrated LCG for direction indicator

LCG

ÜBERSICHT / OVERVIEW

	LCG 3 UNIVERSAL	LCG UNIVERSAL	LCG UNIVERSAL	LCG EUROPOINT III
				
BEST. NR	76-5132-011	75-0324-001	75-0314-001	25-7008-024
PART NO				
$V$	24V	24V	12-30V	12-30V
ANHÄNGERERKENNUNG TRAILER DETECTION				
LED AUSFALLÜBERWACHUNG LED FAILURE DETECTION				
SIMULATION GLÜHBIRNE				
POWER SIMULATION OF A BULB				
BENÖTIGTE MENGE PRO FAHRZEUG	1	1	2	2
QUANTITY REQUIRED PER VEHICLE				
DAUERPLUS BENÖTIGT	●			
PERMANENT POWER REQUIRED				
KANN BEI FOLGENDEN LEUCHTEN VERWENDET WERDEN	bei allen Aspöck Heckleuchten ohne integriertem LCG	bei allen Aspöck Heckleuchten ohne integriertem LCG für Bremslicht	bei allen Aspöck Heckleuchten ohne integriertem LCG für Blinker	Europoint III
USABLE FOR THE FOLLOWING LAMPS	All Aspöck rearlamps without integrated LCG	All Aspöck rearlamps with integrated LCG for stop light	All Aspöck rearlamps with integrated LCG for direction indicator	

### Allgemeiner Hinweis zum LCG!

In Hinsicht auf den geringen Leistungsverbrauch von LED Leuchten gegenüber Glühlampenleuchten kann es im Betrieb bei verschiedenen Zugfahrzeugen zu Problemen mit der Glühlampenausfallkontrolle kommen. Der geringe Leistungsverbrauch von LED Leuchten wird von vielen Zugfahrzeugen als ein Ausfall der Lichtfunktion gesehen und kann im Fahrzeuginneren zu einer visuellen Fehlermeldung führen.

Da die Kontrolle der Blinkerfunktion gesetzlich vorgeschrieben ist empfehlen wir die Aspöck LED Leuchten in Verbindung mit einem LED Control- Gerät „LCG“ zu betreiben.

Aspöck übernimmt keine Haftung für Funktionalität an allen Zugfahrzeugen und befreit dem Fahrer nicht von der Kontrolle der Funktionsfähigkeit der Beleuchtung.

Bei verschiedenen Zugfahrzeugen können zusätzliche nicht gesetzlich vorgeschriebene Lichtfunktionen kontrolliert werden die zu Fehlerdiagnosen im Fahrzeuginneren führen können. Diese zusätzliche Kontrolle ist eine Komfortfunktion des Fahrzeugs und befreit den Fahrer nicht von der visuellen Kontrolle der Lichtfunktion. (z.B.: Instrumententafel im Fahrerhaus zeigt einen Lampenausfall an, obwohl die Funktion gegeben ist)

Der Betrieb der Leuchte mit Wechselspannung oder getakteter Gleichspannung ist nicht zulässig. Die einzelnen Funktionen der Leuchte dürfen nur mit einer fahrzeugseitigen Sicherung von max. 3A betrieben werden.

### General advice to the LCG!

Led lighting draws less current than Incandescent lamps. This is known to cause problems with certain Vehicle Bulb failure Monitoring systems, across all manufacturers.

The low power consumption of led lamps can lead to a visual error message to the driver. As monitoring of the direction indicator is a mandatory requirement, we recommend Aspöck Led lamps are always used in conjunction with our Led Control Gear „LCG“ Aspöck cannot accept any liability for incompatibility of the „LCG“ with the non-mandatory functions, these are provided for driver convenience. With the variation of vehicle types available it is impossible for Aspöck to verify every combination.

It is the Driver of the vehicles Legal responsibility to check all lighting is operating correctly. It must also be noted that the maximum current for each function is 3A. Please take care if connecting a Vehicle to an „AC source or pulsed DC“ as this will lead to component Failure.

No liability will be accepted for the use of „LCG“ with non-approved Vehicles or lamps. Aspöck Accepts no other terms and installation of our products will be deemed as full acceptance of our Terms and conditions.



**VERBINDER / CONNECTORS**

ÜBERSICHT / OVERVIEW

<b>ASS1 &amp; ASS2</b>			
13-5626-401		 30	2 pol. weiblich 2 pin female
13-5625-991		 29	2 pol. männlich 2 pin male
13-5626-631		 41	7 pol. weiblich 7 pin female
13-5625-981		 38	7 pol. männlich 7 pin male

<b>ASS3</b>			
13-0322-281		 18	3 pol. weiblich 3 pin female
13-0332-281		 18	3 pol. männlich 3 pin male
13-1722-001		 34	17 pol. weiblich 17 pin female
13-1732-001		 38	17 pol. männlich 17 pin male

<b>Bajonett   bayonet</b>			
13-0246-004		 20	2 pol. weiblich 2 pin female
13-0236-004		 17	2 pol. männlich 2 pin male
13-0521-104		 27	5 pol. weiblich 5 pin female
13-0536-044		 24	5 pol. männlich 5 pin male
13-0828-034		 27	8 pol. weiblich 8 pin female
15-0821-524		 27	8 pol. weiblich 8 pin female
13-0838-054		 29	8 pol. männlich 8 pin male
13-1540-004		 38	15 pol. weiblich 15 pin female
13-1530-004		 34	15 pol. männlich 15 pin male



VERBINDER / CONNECTORS

ÜBERSICHT / OVERVIEW

AMP			
15-7002-004			4 pol. weiblich 4 pin female
15-7002-014			4 pol. männlich 4 pin male
15-7002-024			7 pol. weiblich 7 pin female
15-7002-034			7 pol. männlich 7 pin male

Superseal			
15-7002-044			2 pol. weiblich 2 pin female
15-7002-054			2 pol. männlich 2 pin male
15-7002-064			3 pol. weiblich 3 pin female
15-7002-074			3 pol. männlich 3 pin male
15-7002-084			4 pol. weiblich 4 pin female
15-7002-094			4 pol. männlich 4 pin male
15-7002-104			6 pol. weiblich 6 pin female
15-7002-114			6 pol. männlich 6 pin male

Deutsch			
15-7002-135			2 pol. weiblich 2 pin female
15-7002-125			2 pol. männlich 2 pin male
15-7002-155			4 pol. weiblich 4 pin female
15-7002-145			4 pol. männlich 4 pin male



**FASFPÖÖKX<sup>®</sup>**

**S Y S T E M S**

## ZUSÄTZLICHE INFORMATION

Eine Übersicht und Auflistung produktbezogener Informationen sowie die Legende der verwendeten Piktogramme sind auf den nächsten Seiten ersichtlich.

## ADDITIONAL INFORMATION

An overview and list of product-related information and the key to the pictograms used can be found on the following pages.



# E - NUMMERN ÜBERSICHT

## Heckleuchten / Glühbirne

3 Kammernleuchte	E9_5520
Earpoint I	E9_1057
Ecoflex	E9_1853
Ecopoint I	E9_5266
Ecopoint I mit Dreieck	E9_5266
Ecopoint II	E9_1853
Ecopoint II ohne Dreieck	E9_6246
Eurofab	E9_1211
Europoint III	E9_6984 E9_6985
Europoint II	E9_5497 E13_1787
Europoint I	E9_5167 E2_7078

## Heckleuchten / LED

3 Kammernleuchte LED	E9_6556 E9_1139 E4_23271 E9_5595 E9_1490 E4_13992 E4_4052
Braspoint 98	E9_11417 E9_11875 E9_11874 E9_11873 E9_11418 E9_11419 horizontal vertikal
Braspoint 140	E9_11412 E9_11416 E9_11876 E9_11887
EcoLED	E9_1854
EcoLED II	E9_16286 E9_22480
Ecopoint I LED	E9_5266
Ecopoint II LED	E9_11865 E24_1804
Ecopoint II LED ohne Dreieck	E9_11866
Europoint III LED	E9_11093 E9_11094
Europoint II LED	E9_5497
MiniLED II	E9_6535 E9_6532 E9_6530 E9_6531
MultiLED	E9_1599 E9_1600
MultiLED II	E24_6110
MultiLED III mit Dreieck	E9_22128 E9_23441
MultiLED III ohne Dreieck	E9_22128 E9_23442
Multipoint LED	E9_5186
Multipoint V LED	E9_5946
Linepoint I	E24_0145 E24_6109
Linepoint II	E9_11442 E9_11443

## Positionsluchte / Glühbirne

Flexipoint I rot	E9_5332
Flexipoint I weiß	E9_5332
Monopoint	E4_7740
Sidepoint weiß	E13_0484 E13_9592

## Positionsluchte / LED

Flatpoint I weiß LED	E24_6094
Flatpoint II rot LED	E9_5499
Flatpoint II weiß LED	E9_5499
Monopoint II rot LED	E9_5594
Monopoint II weiß LED	E9_5594
Posipoint II weiß LED	E9_5593
Posipoint II rot LED	E9_5593
Unipoint I rot LED	E9_5409
Unipoint I weiß LED	E9_5409

## Seitenmarkierungsleuchte / Glühbirne

Sidepoint	E13_9592
-----------	----------

## Seitenmarkierungsleuchte / LED

Flatpoint I LED	E24_6094
Flatpoint II LED	E9_5499
Unipoint I LED	E9_5409

## Umrissleuchte / Glühbirne

Flexipoint I rot / weiß	E9_5532
Superpoint I	E13_0339 E13_2317
Superpoint II	E9_5315

## Umrissleuchte / LED

Superpoint III LED	E9_1469
Superpoint IV LED	E9_6878

## Kennzeichenleuchte / Glühbirne

Regpoint	E9_4127 E9_4135
Regpoint rot	E9_4059 E9_4127
Regpoint small	E20_9944

## Kennzeichenleuchte / LED

Kennzeichenhalter inkl. 2 x KZL LED	E9_1558
Regpoint LED	E9_4133
Regpoint II LED	E4_4352

## 3. Bremsleuchte

3. Bremsleuchte	E9_4075
3. Bremsleuchten LED mit KZ-Halter	E9_4075

## Arbeits- Rückfahrcheinwerfer

Arbeitsscheinwerfer / Rückfahrcheinwerfer	E9_4013 E9_1014
Rückfahrcheinwerfer LED oval	E9_6989
Workpoint LED 650	E13_12435
Workpoint LED 800	E13_12438
Workpoint LED 1500	E9_1228
Workpoint LED 3000	E9_1393

## Innenleuchte

Innenleuchte LED rund	E24_0976
Inpoint III LED ohne Schalter	E9_1439 E9_1440
Inpoint III LED mit Schalter	E9_1439 E9_1440
Inpoint III LED mit Bewegungssensor	E9_1439 E9_1440
LED-Innenleuchte	E24_0976

# APPROVAL NUMBER OVERVIEW

ZUBEHÖR / ACCESSORIES

## Rear lamps / bulb

3 chamber lamp	E9_5520
Earpoint I	E9_1057
Ecoflex	E9_1853
Ecopoint I	E9_5266
Ecopoint I without triangle	E9_5266
Ecopoint II	E9_1853
Ecopoint II without triangle	E9_6246
Eurofab	E9_1211
Europoint III	E9_6984 E9_6985
Europoint II	E9_5497 E13_1787
Europoint I	E9_5167 E2_7078

## Rear lamps / LED

3 chamber lamp LED	E9_6556 E9_1139 E4_23271 E9_5595 E9_1490 E4_13992 E4_4052
Braspoint 98 horizontal vertical	E9_11417 E9_11875 E9_11874 E9_11873 E9_11418 E9_11419
Braspoint 140	E9_11412 E9_11416 E9_11876 E9_11887
EcoLED	E9_1854
EcoLED II	E9_16286 E9_22480
Ecopoint I LED	E9_5266
Ecopoint II LED	E9_11865 E24_1804
Ecopoint II LED without triangle	E9_11866
Europoint III LED	E9_11093 E9_11094
Europoint II LED	E9_5497
MiniLED II	E9_6535 E9_6532 E9_6530 E9_6531
MultiLED	E9_1599 E9_1600
MultiLED II	E24_6110
MultiLED III with triangle	E9_22128 E9_23441
MultiLED III without triangle	E9_22128 E9_23442
Multipoint LED	E9_5186
Multipoint V LED	E9_5946
Linepoint I	E24_0145 E24_6109
Linepoint II	E9_11442 E9_11443

## Position lamps / bulb

Flexipoint I red	E9_5332
Flexipoint I white	E9_5332
Monopoint	E4_7740
Sidepoint white	E13_0484 E13_9592

## Position lamps / LED

Flatpoint I white LED	E24_6094
Flatpoint II red LED	E9_5499
Flatpoint II white LED	E9_5499
Monopoint II red LED	E9_5594
Monopoint II white LED	E9_5594
Posipoint II white LED	E9_5593
Posipoint II red LED	E9_5593
Unipoint I red LED	E9_5409
Unipoint I white LED	E9_5409

## Side marker lamps / bulb

Sidepoint	E13_9592
-----------	----------

## Side marker lamps / LED

Flatpoint I LED	E24_6094
Flatpoint II LED	E9_5499
Unipoint I LED	E9_5409

## End outline marker lamps / bulb

Flexipoint I red / white	E9_5532
Superpoint I	E13_0339 E13_2317
Superpoint II	E9_5315

## End outline marker lamps / LED

Superpoint III LED	E9_1469
Superpoint IV LED	E9_6878

## Number plate lamps / LED

Regpoint	E9_4127 E9_4135
Regpoint red	E9_4059 E9_4127
Regpoint small	E20_9944

## Number plate lamps / LED

Number plate pad include 2 x NPL LED	E9_1558
Regpoint LED	E9_4133
Regpoint II LED	E4_4352

## Additional lamps

3rd stop lamp	E9_4075
3rd stop lamp „LED“ with Registration Plate	E9_4075

## Working-revers lamp

Reverse-working lamp	E9_4013 E9_1014
Reversing lamp LED oval	E9_6989
Workpoint LED 650	E13_12435
Workpoint LED 800	E13_12438
Workpoint LED 1500	E9_1228
Workpoint LED 3000	E9_1393

## Interior lamps

Interior Lamp LED round	E24_0976
Inpoint III LED without switch	E9_1439 E9_1440
Inpoint III LED with switch	E9_1439 E9_1440
Inpoint III LED with motion sensor	E9_1439 E9_1440
LED-Interior Lamp	E24_0976

## ARTIKELNUMMERN / PART NUMBERS

ARTIKEL NR PART NO	SEITE PAGE	ARTIKEL NR PART NO	SEITE PAGE	ARTIKEL NR PART NO	SEITE PAGE	ARTIKEL NR PART NO	SEITE PAGE	ARTIKEL NR PART NO	SEITE PAGE	ARTIKEL NR PART NO	SEITE PAGE
18-8570-111	22	13-0332-281	69	13-5625-991	108	14-1430-454	28	15-5317-004	129	15-5971-014	100
11-2128-194	119	13-0332-281	71	13-5625-991	118	14-1430-454	47	15-5317-014	126	15-5971-014	105
12-1522-004	40	13-0332-281	73	13-5625-991	125	14-1430-554	22	15-5317-014	129	15-5971-014	109
12-1522-014	40	13-0332-281	100	13-5625-991	139	14-4596-004	126	15-5317-014	131	15-5971-014	114
12-1522-024	40	13-0332-281	105	13-5625-991	147	14-4596-004	129	15-5317-014	133	15-5971-014	119
12-1522-034	40	13-0332-281	109	13-5625-991	151	14-4596-004	131	15-5317-024	126	15-5971-014	125
12-1522-144	36	13-0332-281	114	13-5625-991	153	14-4596-004	133	15-5317-024	129	15-5971-014	129
12-1522-154	36	13-0332-281	119	13-5625-991	155	15-0821-524	49	15-5317-024	131	15-5971-014	131
12-1526-004	40	13-0332-281	125	13-5625-991	159	15-0821-524	59	15-5317-024	133	15-5971-014	133
12-1526-014	40	13-0332-281	129	13-5625-991	163	15-0821-524	65	15-5318-004	93	15-5971-014	137
12-1526-024	40	13-0332-281	131	13-5625-991	167	15-0821-524	76	15-5318-004	95	15-5971-014	139
12-1526-034	40	13-0332-281	139	13-5625-991	169	15-0821-524	79	15-5319-004	126	15-5971-014	144
12-1526-144	36	13-0332-281	144	13-5625-991	171	15-0821-524	84	15-5319-004	129	15-5971-014	147
12-1526-154	36	13-0332-281	147	13-5625-991	173	15-0821-524	192	15-5319-004	131	15-5971-014	151
12-1526-164	36	13-0332-281	151	13-5625-991	175	15-2122-104	118	15-5319-004	133	15-5971-014	153
12-1527-004	65	13-0332-281	153	13-5625-991	177	15-2122-124	118	15-5319-304	126	15-5971-014	155
12-1528-001	36	13-0332-281	155	13-5625-991	192	15-2122-164	119	15-5319-304	129	15-5971-014	157
12-1528-001	45	13-0332-281	173	13-5626-401	13	15-2122-164	137	15-5319-304	131	15-5971-014	159
12-1529-001	36	13-0332-281	183	13-5626-401	15	15-2122-174	119	15-5319-304	133	15-5971-014	173
12-1529-001	45	13-0332-281	192	13-5626-401	23	15-2122-174	137	15-5319-904	125	15-5971-014	182
12-1530-004	63	13-0521-104	49	13-5626-401	29	15-2128-094	119	15-5321-004	115	15-5971-014	183
12-1531-004	63	13-0521-104	59	13-5626-401	37	15-2128-144	119	15-5321-104	115	15-5971-014	185
12-1560-001	28	13-0521-104	67	13-5626-401	54	15-2128-144	137	15-5321-204	115	15-5971-014	141
12-1560-011	28	13-0521-104	76	13-5626-401	61	15-2128-214	115	15-5321-234	115	15-5983-024	93
12-1560-021	28	13-0521-104	79	13-5626-401	84	15-2128-274	119	15-5321-404	115	15-5983-024	95
12-1560-031	28	13-0521-104	84	13-5626-401	89	15-2128-274	137	15-5322-004	115	15-5983-024	100
12-1560-141	28	13-0521-104	192	13-5626-401	100	15-2128-285	126	15-5322-004	126	15-5983-024	109
12-1570-001	22	13-0536-044	49	13-5626-401	105	15-2128-285	129	15-5322-004	129	15-5983-024	114
12-1570-101	22	13-0536-044	59	13-5626-401	108	15-2128-285	131	15-5322-004	131	15-5983-024	119
12-1570-204	22	13-0536-044	76	13-5626-401	118	15-2128-285	133	15-5322-004	133	15-5983-024	125
12-1570-214	22	13-0536-044	79	13-5626-401	125	15-2128-514	136	15-5323-004	45	15-5983-024	129
12-1570-224	22	13-0536-044	84	13-5626-401	139	15-2128-524	136	15-5325-004	105	15-5983-024	131
12-1570-234	22	13-0536-044	192	13-5626-401	147	15-2128-544	108	15-5325-101	105	15-5983-024	133
12-1574-204	22	13-0828-034	49	13-5626-401	151	15-5020-824	180	15-5609-104	139	15-5983-024	139
12-1574-214	22	13-0828-034	59	13-5626-401	153	15-5111-004	115	15-5623-304	13	15-5983-024	144
12-1574-224	22	13-0828-034	65	13-5626-401	155	15-5111-404	73	15-5623-304	15	15-5983-024	147
12-1574-234	22	13-0828-034	67	13-5626-401	159	15-5113-004	139	15-5623-304	23	15-5983-024	153
12-3922-004	22	13-0828-034	76	13-5626-401	163	15-5203-004	163	15-5623-304	29	15-5983-024	155
12-3922-004	28	13-0828-034	79	13-5626-401	167	15-5270-004	23	15-5623-304	37	15-5983-024	157
12-3922-004	31	13-0828-034	84	13-5626-401	169	15-5270-004	28	15-5623-304	54	15-5983-024	159
12-3922-004	36	13-0828-034	89	13-5626-401	171	15-5270-004	31	15-5623-304	61	15-5983-024	182
12-3970-584	22	13-0828-034	192	13-5626-401	173	15-5270-004	40	15-5624-014	125	15-5983-024	183
12-3970-584	28	13-0838-054	49	13-5626-401	175	15-5270-004	43	15-5624-024	125	15-5983-024	185
12-3970-584	36	13-0838-054	59	13-5626-401	177	15-5276-004	23	15-5729-014	93	15-5983-024	105
12-6830-094	23	13-0838-054	65	13-5626-401	192	15-5276-004	28	15-5729-014	95	15-5983-024	141
12-6830-094	29	13-0838-054	76	13-5626-631	51	15-5276-004	31	15-5729-014	100	15-5983-024	151
13-0236-004	192	13-0838-054	79	13-5626-631	13	15-5276-004	40	15-5729-014	105	15-5983-024	173
13-0246-004	192	13-0838-054	84	13-5626-631	15	15-5276-004	43	15-5729-014	109	15-7002-004	76
13-0320-004	69	13-0838-054	192	13-5626-631	23	15-5277-004	15	15-5729-014	114	15-7002-004	79
13-0322-281	69	13-1530-004	192	13-5626-631	29	15-5277-004	36	15-5729-014	119	15-7002-004	193
13-0322-281	71	13-1540-004	192	13-5626-631	31	15-5300-294	13	15-5729-014	125	15-7002-014	76
13-0322-281	73	13-1722-001	41	13-5626-631	37	15-5303-004	49	15-5729-014	129	15-7002-014	79
13-0322-281	100	13-1722-001	192	13-5626-631	41	15-5310-104	93	15-5729-014	131	15-7002-014	193
13-0322-281	105	13-1732-001	41	13-5626-631	43	15-5310-104	95	15-5729-014	133	15-7002-024	13
13-0322-281	109	13-1732-001	192	13-5626-631	45	15-5311-004	93	15-5729-014	139	15-7002-024	23
13-0322-281	114	13-5625-981	49	13-5626-631	49	15-5311-004	95	15-5729-014	144	15-7002-024	29
13-0322-281	119	13-5625-981	59	13-5626-631	54	15-5312-104	93	15-5729-014	147	15-7002-024	37
13-0322-281	125	13-5625-981	63	13-5626-631	59	15-5314-104	95	15-5729-014	151	15-7002-024	47
13-0322-281	129	13-5625-981	65	13-5626-631	61	15-5313-004	100	15-5729-014	153	15-7002-024	54
13-0322-281	131	13-5625-981	69	13-5626-631	63	15-5313-004	108	15-5729-014	155	15-7002-024	59
13-0322-281	139	13-5625-981	76	13-5626-631	65	15-5314-104	93	15-5729-014	157	15-7002-024	61
13-0322-281	144	13-5625-981	79	13-5626-631	69	15-5314-104	95	15-5729-014	159	15-7002-024	63
13-0322-281	147	13-5625-981	84	13-5626-631	76	15-5316-004	93	15-5729-014	173	15-7002-024	76
13-0322-281	151	13-5625-981	89	13-5626-631	79	15-5316-004	95	15-5729-014	182	15-7002-024	79
13-0322-281	153	13-5625-981	192	13-5626-631	84	15-5316-704	93	15-5729-014	183	15-7002-024	84
13-0322-281	155	13-5625-991	84	13-5626-631	89	15-5316-704	95	15-5729-014	185	15-7002-024	89
13-0322-281	173	13-5625-991	89	13-5626-631	192	15-5317-004	126	15-5729-014	141	15-7002-024	193
13-0322-281	183	13-5625-991	100	14-0418-304	115	15-5317-004	131	15-5971-014	93	15-7002-034	59
13-0322-281	192	13-5625-991	105	14-1430-354	31	15-5317-004	133	15-5971-014	95	15-7002-034	63

## ARTIKELNUMMERN / PART NUMBERS

ARTIKEL NR PART NO	SEITE PAGE	ARTIKEL NR PART NO	SEITE PAGE	ARTIKEL NR PART NO	SEITE PAGE	ARTIKEL NR PART NO	SEITE PAGE	ARTIKEL NR PART NO	SEITE PAGE	ARTIKEL NR PART NO	SEITE PAGE
15-7002-034	76	16-6121-017	47	18-8457-131	65	21-7600-001	81	24-8930-071	53	25-2910-551	35
15-7002-034	79	16-6121-017	81	18-8458-051	65	21-7700-004	126	24-8930-081	52	25-2911-501	35
15-7002-034	84	16-6122-017	81	18-8458-131	65	21-7700-014	126	24-8930-081	53	25-2911-551	35
15-7002-034	89	16-6304-027	29	18-8485-004	63	21-7700-024	126	24-8931-001	52	25-2920-401	44
15-7002-034	193	16-6304-027	37	18-8487-004	63	21-7700-035	126	24-8931-011	52	25-2920-501	35
15-7002-044	13	16-6304-027	41	18-8520-002	43	21-7700-054	126	24-8931-021	52	25-2920-541	35
15-7002-044	23	16-6304-027	43	18-8522-002	40	21-7702-014	126	24-8931-031	52	25-2920-741	35
15-7002-044	29	16-6304-027	45	18-8526-002	36	21-7800-004	127	24-8931-041	52	25-2931-501	35
15-7002-044	37	16-6304-027	51	18-8527-002	36	21-8004-011	184	24-8931-051	52	25-2932-501	35
15-7002-044	54	16-6304-027	109	18-8528-002	36	21-8004-041	184	24-8931-061	52	25-2960-001	33
15-7002-044	73	16-6304-027	137	18-8528-402	45	21-8004-071	184	24-8931-071	52	25-2960-041	33
15-7002-044	84	16-6305-027	31	18-8529-002	36	21-8007-144	185	24-8931-071	53	25-2960-701	33
15-7002-044	89	16-6305-027	41	18-8529-402	45	21-8007-154	185	24-8931-081	52	25-2960-701	33
15-7002-044	100	16-6305-027	43	18-8536-001	13	21-8007-164	185	24-8931-081	53	25-2970-401	35
15-7002-044	105	16-6310-027	29	18-8536-011	13	22-7000-001	84	24-8937-001	54	25-2980-521	33
15-7002-044	109	16-6310-027	31	18-8550-002	31	22-7000-701	82	24-8937-011	54	25-2980-531	35
15-7002-044	121	16-6310-027	37	18-8554-042	31	22-7600-001	81	25-2000-501	42	25-3800-501	14
15-7002-044	144	16-6310-027	45	18-8560-002	28	23-8200-011	86	25-2200-001	38	25-3800-511	14
15-7002-044	151	16-6310-027	47	18-8570-001	22	23-8200-511	86	25-2200-701	38	25-3820-511	14
15-7002-044	153	16-6310-027	51	18-8570-011	22	23-8220-001	86	25-2201-001	38	25-3900-501	14
15-7002-044	155	16-6310-027	63	18-8570-101	22	23-8230-001	86	25-2210-001	39	25-3900-511	14
15-7002-044	167	16-6310-027	67	18-8580-001	47	23-8400-701	85	25-2210-701	39	25-3920-511	14
15-7002-044	169	16-6310-027	89	18-8630-104	155	23-8400-711	85	25-2211-001	39	25-4120-001	10
15-7002-044	173	16-6321-037	23	18-8630-104	157	23-8400-721	85	25-2400-501	42	25-4120-011	10
15-7002-044	175	16-6321-037	29	18-8780-104	89	23-8400-751	82	25-2600-001	38	25-4120-021	10
15-7002-044	177	16-6321-037	31	18-8784-501	84	23-8400-761	82	25-2600-701	38	25-4120-031	10
15-7002-044	193	16-6321-037	37	18-8880-104	89	23-8400-771	82	25-2601-001	38	25-4120-041	10
15-7002-054	73	16-6321-037	41	18-8884-501	84	23-8400-781	82	25-2610-001	39	25-4120-051	10
15-7002-054	84	16-6321-037	43	21-2000-004	127	23-8400-801	82	25-2610-701	39	25-4120-061	12
15-7002-054	89	16-6321-037	45	21-2000-014	127	23-8400-811	82	25-2611-001	39	25-4121-001	10
15-7002-054	100	16-6321-037	47	21-2000-024	127	23-8400-821	82	25-2800-001	32	25-4121-011	10
15-7002-054	105	16-6321-037	51	21-2000-035	127	23-8500-701	85	25-2800-401	44	25-4121-021	10
15-7002-054	109	16-6321-037	63	21-2000-054	127	23-8500-721	85	25-2800-451	32	25-4121-031	10
15-7002-054	121	16-6321-037	65	21-2000-064	127	24-4101-001	50	25-2800-501	32	25-4121-041	10
15-7002-054	144	16-6321-037	67	21-2000-104	127	24-4105-001	50	25-2800-511	32	25-4121-051	10
15-7002-054	151	16-6321-037	89	21-2000-144	127	24-4111-001	50	25-2800-521	32	25-4121-061	12
15-7002-054	153	16-6321-037	167	21-2000-154	127	24-4151-001	50	25-2801-501	32	25-4126-001	11
15-7002-054	155	16-6321-617	23	21-2002-004	127	24-4301-001	50	25-2801-701	32	25-4126-011	11
15-7002-054	167	16-6321-617	29	21-2200-004	118	24-4305-001	50	25-2810-401	44	25-4126-031	11
15-7002-054	169	16-6321-617	37	21-2200-014	118	24-4311-001	50	25-2810-451	34	25-4126-041	11
15-7002-054	173	16-6321-617	45	21-2201-004	118	24-4351-001	50	25-2810-501	34	25-5000-501	30
15-7002-054	175	16-6321-617	63	21-2201-014	118	24-5013-001	66	25-2810-511	34	25-5001-501	30
15-7002-054	177	16-6322-027	31	21-2201-044	118	24-5213-001	66	25-2811-501	34	25-5100-501	30
15-7002-054	193	16-6322-027	51	21-2202-004	118	24-5700-721	64	25-2820-401	44	25-5400-501	30
15-7002-064	73	16-6322-037	41	21-2302-004	114	24-5705-701	64	25-2820-501	34	25-5401-501	30
15-7002-064	84	16-6322-037	43	21-2303-004	114	24-5800-731	64	25-2820-541	34	25-5500-501	30
15-7002-064	193	16-6456-001	167	21-2800-004	135	24-5805-701	64	25-2820-741	34	25-6000-501	24
15-7002-074	73	16-6705-017	51	21-2800-014	136	24-5805-711	64	25-2831-501	34	25-6000-701	24
15-7002-074	84	16-6705-017	67	21-2801-004	136	24-5813-701	64	25-2832-501	34	25-6000-711	24
15-7002-074	193	16-6705-017	95	21-2801-054	136	24-7400-701	60	25-2860-001	32	25-6000-721	24
15-7002-084	193	16-6705-017	159	21-2801-064	136	24-7430-701	60	25-2860-041	32	25-6000-741	24
15-7002-094	193	18-8136-004	41	21-3300-007	105	24-7470-701	60	25-2860-701	32	25-6000-751	24
15-7002-104	193	18-8136-004	51	21-3302-007	105	24-7500-701	60	25-2860-701	32	25-6001-501	24
15-7002-114	193	18-8136-004	108	21-3350-704	105	24-7530-701	60	25-2870-401	34	25-6010-501	24
15-7002-125	153	18-8141-004	28	21-3351-704	105	24-7570-701	60	25-2880-521	32	25-6010-541	24
15-7002-125	167	18-8141-004	37	21-3353-704	105	24-7630-701	60	25-2880-531	34	25-6011-501	24
15-7002-125	173	18-8141-004	45	21-3354-704	105	24-7730-701	60	25-2900-001	33	25-6011-511	26
15-7002-125	175	18-8382-104	89	21-3800-004	51	24-8502-001	62	25-2900-401	44	25-6011-701	26
15-7002-125	177	18-8384-501	84	21-5000-004	135	24-8504-701	62	25-2900-451	33	25-6015-501	26
15-7002-125	193	18-8384-551	84	21-5000-024	135	24-8702-001	62	25-2900-501	33	25-6020-751	26
15-7002-135	153	18-8440-001	51	21-5000-034	135	24-8714-701	62	25-2900-511	33	25-6021-701	26
15-7002-135	167	18-8440-051	51	21-5000-054	135	24-8930-001	52	25-2900-521	33	25-6021-731	26
15-7002-135	173	18-8442-001	51	21-6510-004	95	24-8930-011	52	25-2901-501	33	25-6021-741	26
15-7002-135	175	18-8442-101	51	21-6512-004	95	24-8930-021	52	25-2901-551	33	25-6030-501	24
15-7002-135	177	18-8450-021	67	21-6513-004	95	24-8930-031	52	25-2901-701	33	25-6030-511	24
15-7002-135	193	18-8451-021	67	21-6513-214	95	24-8930-041	52	25-2910-401	44	25-6030-701	24
15-7002-145	193	18-8452-021	67	21-6600-004	118	24-8930-051	52	25-2910-451	35	25-6030-711	24
15-7002-155	193	18-8452-121	67	21-6600-014	118	24-8930-061	52	25-2910-501	35	25-6030-721	24
16-6110-017	47	18-8457-051	65	21-6601-004	118	24-8930-071	52	25-2910-511	35	25-6101-501	24

ARTIKELNUMMERN / PART NUMBERS

ARTIKEL NR PART NO	SEITE PAGE	ARTIKEL NR PART NO	SEITE PAGE	ARTIKEL NR PART NO	SEITE PAGE	ARTIKEL NR PART NO	SEITE PAGE	ARTIKEL NR PART NO	SEITE PAGE	ARTIKEL NR PART NO	SEITE PAGE
25-6110-501	26	25-7400-711	17	31-2064-214	122	31-2864-004	134	31-3165-004	97	31-3365-014	103
25-6110-711	26	25-7400-721	17	31-2064-234	123	31-2864-034	134	31-3166-004	97	31-3365-054	103
25-6200-501	24	25-7400-741	17	31-2064-414	123	31-3100-004	96	31-3300-074	102	31-3365-064	103
25-6201-511	24	25-7400-751	20	31-2064-434	123	31-3102-024	23	31-3300-244	104	31-3365-094	102
25-6210-501	26	25-7400-761	17	31-2064-714	123	31-3102-024	96	31-3300-374	104	31-3366-024	103
25-6211-501	26	25-7401-531	17	31-2064-734	123	31-3102-034	96	31-3302-024	37	31-3366-054	103
25-6400-501	25	25-7401-601	17	31-2064-774	123	31-3102-044	99	31-3302-024	45	31-3366-064	103
25-6400-701	25	25-7401-611	17	31-2067-084	123	31-3102-054	99	31-3302-034	37	31-3366-094	102
25-6400-711	25	25-7402-001	17	31-2067-094	123	31-3102-064	98	31-3302-034	45	31-3367-004	104
25-6400-721	25	25-7402-101	19	31-2067-104	123	31-3102-074	98	31-3302-044	37	31-3404-004	106
25-6400-741	25	25-7420-501	19	31-2067-694	123	31-3102-104	97	31-3302-044	45	31-3404-014	106
25-6400-751	25	25-7420-511	19	31-2100-034	130	31-3102-114	97	31-3302-054	102	31-3404-064	106
25-6401-501	25	25-7420-541	19	31-2100-134	128	31-3102-124	97	31-3302-064	104	31-3404-104	106
25-6410-501	25	25-7420-551	19	31-2104-014	123	31-3102-134	98	31-3302-104	37	31-3404-114	106
25-6410-541	25	25-7420-701	19	31-2104-034	123	31-3102-144	98	31-3302-104	45	31-3404-124	106
25-6411-501	25	25-7420-711	19	31-2104-064	132	31-3102-154	98	31-3303-024	37	31-3404-134	106
25-6411-511	27	25-7420-721	19	31-2104-074	128	31-3102-164	99	31-3303-024	45	31-3404-364	106
25-6411-701	27	25-7420-741	19	31-2107-004	128	31-3102-184	97	31-3303-034	37	31-3405-004	106
25-6415-501	27	25-7420-751	19	31-2107-014	130	31-3102-194	98	31-3303-034	45	31-3405-074	106
25-6420-751	27	25-7420-761	19	31-2107-024	130	31-3102-204	13	31-3303-044	37	31-3406-004	106
25-6421-701	27	25-7420-771	19	31-2164-014	123	31-3102-204	97	31-3303-044	45	31-3406-064	106
25-6421-731	27	25-7421-521	19	31-2164-034	123	31-3102-214	13	31-3303-054	102	31-3407-104	106
25-6421-741	27	25-7421-531	19	31-2204-014	117	31-3102-214	97	31-3303-064	104	31-3407-114	106
25-6430-501	25	25-7430-711	17	31-2204-154	119	31-3103-024	23	31-3303-104	37	31-3604-044	107
25-6430-511	25	25-7430-721	17	31-2214-004	117	31-3103-024	96	31-3303-104	45	31-3604-054	107
25-6430-701	25	25-7537-154	13	31-2214-014	117	31-3103-034	96	31-3304-044	102	31-3605-004	107
25-6430-711	25	25-7537-154	23	31-2214-024	117	31-3103-044	99	31-3304-054	102	31-3606-004	107
25-6430-721	25	25-8100-001	46	31-2214-034	117	31-3103-054	99	31-3304-094	104	31-3608-004	41
25-6501-501	25	25-8100-161	46	31-2214-114	117	31-3103-064	98	31-3304-114	102	31-3608-004	107
25-6501-511	25	25-8100-201	46	31-2214-134	117	31-3103-074	98	31-3304-124	102	31-3608-014	41
25-6510-501	27	25-8100-501	46	31-2264-014	117	31-3103-104	96	31-3304-134	102	31-3608-014	107
25-6510-711	27	25-8300-001	46	31-2264-024	117	31-3103-114	96	31-3304-144	102	31-3704-004	106
25-6600-501	25	25-8300-161	46	31-2264-034	117	31-3103-124	96	31-3305-014	102	31-3704-014	106
25-6601-511	25	25-8300-201	46	31-2267-014	117	31-3103-134	98	31-3305-044	102	31-3707-024	106
25-6610-501	27	25-8300-501	46	31-2267-064	117	31-3103-144	98	31-3305-064	28	31-3707-095	107
25-6611-501	27	26-1200-004	158	31-2267-074	117	31-3103-154	98	31-3305-084	29	31-3707-105	106
25-7000-501	16	26-3000-004	155	31-2267-084	117	31-3103-164	99	31-3305-084	103	31-3707-134	107
25-7000-511	16	26-3010-004	157	31-2304-014	112	31-3103-184	96	31-3305-124	102	31-3707-144	107
25-7000-541	20	27-7600-001	81	31-2304-034	112	31-3103-194	98	31-3305-174	41	31-3792-004	107
25-7000-701	16	27-8000-021	86	31-2304-044	112	31-3103-204	13	31-3305-194	104	31-3793-004	107
25-7000-711	16	27-8001-511	86	31-2304-094	112	31-3103-204	96	31-3305-214	102	31-3804-004	107
25-7000-721	16	27-8100-701	85	31-2304-104	112	31-3103-214	13	31-3305-234	15	31-3804-014	107
25-7000-741	16	27-8100-721	82	31-2307-004	112	31-3103-214	96	31-3305-294	102	31-3805-004	107
25-7000-751	20	27-8400-701	82	31-2307-014	112	31-3104-004	96	31-3306-014	102	31-3805-024	107
25-7000-761	16	28-7600-001	81	31-2307-034	112	31-3104-014	96	31-3306-044	103	31-3806-004	107
25-7001-501	16	28-8000-021	86	31-2364-014	112	31-3104-024	97	31-3306-064	28	31-3806-024	107
25-7001-601	16	28-8001-521	86	31-2364-034	112	31-3104-034	96	31-3306-084	29	31-5004-014	134
25-7001-611	16	28-8100-711	85	31-2364-084	112	31-3104-044	98	31-3306-084	103	31-5004-094	134
25-7002-001	16	28-8100-731	82	31-2364-104	112	31-3104-054	98	31-3306-124	103	31-5004-104	134
25-7002-101	18	28-8400-701	82	31-2364-114	112	31-3104-064	99	31-3306-174	41	31-5004-154	134
25-7008-024	23	28-9100-001	166	31-2364-134	112	31-3104-074	99	31-3306-194	104	31-6004-074	140
25-7008-024	189	29-8410-001	182	31-2364-184	112	31-3104-084	98	31-3306-214	103	31-6004-094	140
25-7020-501	18	29-8410-101	182	31-2364-284	112	31-3104-094	98	31-3306-234	15	31-6204-084	140
25-7020-511	18	31-2000-014	122	31-2364-304	112	31-3104-104	99	31-3306-294	103	31-6204-104	140
25-7020-541	18	31-2000-034	122	31-2364-324	113	31-3104-114	99	31-3307-014	104	31-6300-004	92
25-7020-701	18	31-2004-014	122	31-2364-334	113	31-3104-124	99	31-3307-024	104	31-6304-014	92
25-7020-711	18	31-2004-034	122	31-2364-344	113	31-3104-134	99	31-3307-044	104	31-6364-004	92
25-7020-721	18	31-2004-044	122	31-2364-354	113	31-3105-004	96	31-3307-104	104	31-6364-014	92
25-7020-731	18	31-2004-074	122	31-2367-034	113	31-3105-014	96	31-3307-134	104	31-6404-014	113
25-7020-741	18	31-2007-024	122	31-2367-054	113	31-3105-024	97	31-3307-194	104	31-6404-094	113
25-7020-751	18	31-2007-234	122	31-2367-064	113	31-3105-034	97	31-3307-224	104	31-6504-084	94
25-7021-511	18	31-2007-244	122	31-2464-024	120	31-3105-044	97	31-3360-004	104	31-6504-104	94
25-7021-521	18	31-2007-294	122	31-2464-034	120	31-3106-004	96	31-3362-004	103	31-6504-134	94
25-7030-711	16	31-2007-304	122	31-2800-004	108	31-3106-014	97	31-3362-104	103	31-6504-174	94
25-7030-721	16	31-2007-334	122	31-2804-094	134	31-3106-024	97	31-3363-004	103	31-6564-064	94
25-7400-501	17	31-2007-344	122	31-2804-174	134	31-3106-034	97	31-3363-104	103	31-6564-074	94
25-7400-511	17	31-2064-014	122	31-2804-204	137	31-3106-044	97	31-3364-004	104	31-6564-144	94
25-7400-541	20	31-2064-034	122	31-2814-004	134	31-3164-004	97	31-3364-024	103	31-6564-154	94
25-7400-701	17	31-2064-124	122	31-2814-024	134	31-3164-014	97	31-3364-054	103	31-6604-014	116



# ARTIKELNUMMERN / PART NUMBERS

ARTIKEL NR PART NO	SEITE PAGE	ARTIKEL NR PART NO	SEITE PAGE	ARTIKEL NR PART NO	SEITE PAGE	ARTIKEL NR PART NO	SEITE PAGE	ARTIKEL NR PART NO	SEITE PAGE	ARTIKEL NR PART NO	SEITE PAGE
31-6604-034	116	31-7704-014	124	33-8400-011	82	35-0204-001	57	36-3864-014	150	39-6807-001	174
31-6604-074	116	31-7704-034	124	33-8402-031	82	35-0204-011	57	36-3865-004	150	39-7000-001	83
31-6604-094	116	31-7704-054	124	33-8403-031	82	35-0204-021	57	36-3867-004	150	39-7007-001	83
31-6614-114	116	31-7704-094	124	33-8403-041	83	35-0204-031	57	36-3867-014	150	39-8404-001	182
31-6607-004	116	31-7704-124	124	33-8405-081	83	35-0204-041	57	36-3867-024	150	39-8409-001	182
31-6607-054	116	31-7707-034	124	33-8405-091	83	35-0204-051	57	37-7200-001	68	39-8700-011	183
31-6614-014	116	31-7707-104	124	33-8405-101	83	35-0204-061	57	37-7207-001	68	39-8704-001	183
31-6614-034	116	31-7707-114	124	33-8406-081	83	35-0204-071	57	37-7600-001	80	39-8704-011	183
31-6614-074	116	31-7707-214	124	33-8406-091	83	35-0204-081	57	37-7600-701	81	39-8707-001	183
31-6614-094	116	31-7764-014	124	33-8406-101	83	35-0204-091	57	37-8000-041	87	39-8900-001	180
31-6664-014	116	31-7764-214	124	33-8407-014	83	35-0204-101	57	37-8000-061	87	39-8900-051	180
31-6664-031	116	31-7764-234	124	33-8914-001	72	35-0204-111	57	37-8007-131	87	39-8900-101	180
31-6667-014	116	31-7804-014	124	33-8914-011	72	35-0204-121	57	37-8007-161	87	39-8900-151	180
31-6700-014	142	31-7804-054	124	33-9200-001	74	35-0204-131	57	37-8007-191	87	39-8900-201	180
31-6700-024	142	31-7804-094	124	33-9200-011	74	35-0204-141	57	37-8400-001	83	39-8900-251	180
31-6700-034	142	31-7804-124	124	33-9200-021	74	35-0301-001	48	37-8407-001	83	39-8900-301	181
31-6700-044	142	31-7804-144	124	33-9200-201	77	35-0301-011	48	37-9207-001	70	39-8900-351	181
31-6700-064	142	31-8900-024	162	33-9200-211	77	35-0301-021	48	37-9207-011	72	39-8900-401	181
31-6704-014	146	31-8900-044	162	33-9200-221	77	35-0301-041	48	37-9220-001	72	65-6502-014	69
31-6704-054	146	31-8907-004	162	33-9200-301	78	35-0302-001	48	37-9220-011	72	68-5000-014	114
31-6704-064	142	31-8907-014	162	33-9200-501	74	35-0302-011	48	37-9230-001	70	68-5000-014	119
31-6704-074	142	31-8910-014	162	33-9200-511	74	35-0302-021	48	38-7200-001	68	68-5000-014	125
31-6704-084	142	31-8910-024	162	33-9200-521	77	35-0302-041	48	38-7207-001	68	68-5000-014	137
31-6704-094	142	31-8920-001	72	33-9200-531	77	35-5103-011	30	38-7600-001	80	68-5000-034	114
31-6704-104	142	31-8927-001	72	33-9200-701	77	35-5502-011	30	38-7600-701	81	68-5000-034	119
31-6704-114	142	31-9000-054	162	33-9200-711	77	36-1204-034	158	38-8000-031	87	68-5000-034	125
31-6704-124	142	31-9007-014	162	33-9207-051	74	36-1207-004	158	38-8000-051	87	68-5000-034	137
31-6704-204	142	31-9207-001	70	33-9207-061	77	36-3000-134	154	38-8000-061	87	68-5000-574	95
31-6707-004	146	31-9207-011	70	33-9207-071	78	36-3002-014	154	38-8007-131	87	68-5000-574	155
31-6707-044	146	31-9207-021	70	33-9207-081	74	36-3003-014	154	38-8007-141	87	68-5000-574	157
31-6707-054	142	31-9207-031	70	33-9207-091	77	36-3004-014	154	38-8007-151	87	68-5000-574	159
31-6800-014	143	31-9207-041	72	33-9280-001	74	36-3004-024	154	38-8107-061	83	68-5000-604	95
31-6804-014	146	31-9207-051	72	34-5703-001	64	36-3004-034	154	38-8200-001	168	68-5000-604	155
31-6804-064	143	31-9207-061	70	34-5703-011	64	36-3004-044	154	38-8204-011	172	68-5000-604	157
31-6804-074	143	31-9207-071	70	34-5705-001	64	36-3004-054	154	38-8207-001	168	68-5000-624	155
31-6804-084	143	31-9207-081	70	34-5802-001	64	36-3004-084	156	38-8207-011	168	68-5000-624	157
31-6804-094	143	31-9220-001	72	34-5802-011	64	36-3004-184	156	38-8220-001	172	68-5000-634	95
31-6807-014	143	31-9220-011	72	34-5806-001	64	36-3007-084	154	38-8220-011	172	68-5000-634	155
31-6807-024	146	31-9221-001	72	34-8503-001	62	36-3007-254	154	38-8220-021	172	68-5000-634	157
31-6900-014	113	31-9221-011	72	34-8505-001	62	36-3007-264	154	38-8221-001	170	68-5018-004	125
31-6904-014	113	31-9230-001	70	34-8605-001	62	36-3007-284	154	38-8221-101	170	68-5018-024	125
31-6904-034	113	31-9231-001	70	34-8702-001	62	36-3007-394	154	38-8226-001	172	75-0300-001	28
31-6904-054	113	31-9231-201	70	34-8706-001	62	36-3007-464	154	38-8226-101	172	75-0300-001	188
31-6904-124	113	31-9231-211	70	34-8806-001	62	36-3007-574	154	38-8226-111	172	75-0300-107	188
31-6904-164	113	32-7000-701	82	35-0201-001	58	36-3600-004	152	38-8227-001	170	75-0309-001	15
31-6907-034	113	32-7200-001	68	35-0201-011	58	36-3600-014	152	38-8227-021	172	75-0309-001	188
31-6964-004	113	32-7207-001	68	35-0201-021	58	36-3600-024	152	38-8227-101	170	75-0310-001	188
31-7100-004	138	32-7600-001	80	35-0201-031	58	36-3600-044	152	38-8407-001	83	75-0314-001	189
31-7100-014	138	32-7600-701	81	35-0201-041	58	36-3604-004	152	38-9000-001	166	75-0324-001	189
31-7100-034	138	33-7200-001	68	35-0202-001	58	36-3604-014	152	38-9007-011	166	76-5132-011	189
31-7100-054	138	33-7200-011	68	35-0202-011	58	36-3604-024	152	38-9010-001	166	76-9027-001	71
31-7100-064	138	33-7207-041	68	35-0202-021	58	36-3607-004	152	38-9100-001	166	76-9027-001	73
31-7100-114	138	33-7207-051	68	35-0202-031	58	36-3607-014	152	38-9100-081	166	76-9028-001	71
31-7104-004	138	33-8100-001	75	35-0202-041	58	36-3607-024	152	38-9107-011	166	76-9028-001	73
31-7104-014	138	33-8100-101	75	35-0203-001	56	36-3607-034	152	38-9207-001	70	87-1366-011	121
31-7104-024	138	33-8100-201	77	35-0203-011	56	36-3607-074	152	38-9207-011	72	87-1368-011	121
31-7104-034	138	33-8100-501	75	35-0203-021	56	36-3607-094	152	38-9207-021	70	87-3047-021	88
31-7104-054	138	33-8100-601	75	35-0203-031	56	36-3690-004	152	38-9220-001	72	87-3048-021	88
31-7107-014	138	33-8100-701	77	35-0203-041	56	36-3690-014	152	38-9220-011	72	87-3067-001	88
31-7110-004	138	33-8107-031	77	35-0203-051	56	36-3690-024	152	38-9230-001	70	87-3068-001	88
31-7204-014	138	33-8107-041	75	35-0203-061	56	36-3690-034	152	38-9231-001	70	87-3079-001	83
31-7204-024	138	33-8107-051	75	35-0203-071	56	36-3690-044	152	38-9237-001	70	87-3080-001	83
31-7204-044	138	33-8180-001	75	35-0203-081	56	36-3804-004	150	39-6400-011	176	87-3081-001	88
31-7207-014	138	33-8205-031	86	35-0203-091	56	36-3804-014	150	39-6400-031	176	87-3082-001	88
31-7210-004	138	33-8205-081	86	35-0203-101	56	36-3805-004	150	39-6400-041	176		
31-7400-004	143	33-8205-101	86	35-0203-111	56	36-3806-004	150	39-6407-001	176		
31-7400-014	143	33-8206-031	86	35-0203-121	56	36-3807-004	150	39-6407-011	176		
31-7600-001	80	33-8206-091	86	35-0203-131	56	36-3810-004	150	39-6800-011	174		
31-7600-701	81	33-8206-101	86	35-0203-141	56	36-3864-004	150	39-6801-001	174		

# PIKTOGRAMM ÜBERSICHT / PICTOGRAM OVERVIEW

PIKTOGRAMM ÜBERSICHT			
	Verpackungseinheit		Begrenzungslicht hinten
	x Stück pro Karton		Begrenzungslicht vorne
	links		rot, weiß, orange
	rechts		rot, weiß
	Leuchtmittel		rot
	Volt		weiß
	Umrissarm		Umrissleuchte
	Glühbirne		Rückstrahler rot
	LED		Rückstrahler gelb
	Blinklicht		Rückstrahler weiß
	Blinklicht rechts		Arbeitsscheinwerfer
	Blinklicht links		Kennzeichenlicht
	dynamischer Blinker rechts		Rückfahralarm
	dynamischer Blinker links		männlich
	SMCG (Steuerung blinkender Seitenmarkierungsleuchten)		weiblich
	mit integriertem Blink-LCG		Flood
	mit integriertem LCG2		Spot
	Rücklicht		horizontal Anbau
	Bremslicht		vertikal Anbau
	Nebelschlusslicht		360° Anbau möglich
	Rückfahrlicht		... Lumen
	Dreieckrückstrahler		... Watt
	ohne Dreieckrückstrahler		ADR Zone 2
	Positionslicht		IP xx Schutzklasse
	Seitenmarkierungslicht		
	ohne Seitenmarkierungslicht		
	Seitenmarkierungslicht + Reflektor		

PICTOGRAM OVERVIEW			
	Packaging unit		Rear position light
	x pieces per box		Front position light
	Left		red, white, amber
	Right		red, white
	Light source		red
	Volt		white
	End Outline marker		End outline marker
	Bulb		Reflector red
	LED		Reflector amber
	Direction indicator		Reflector white
	Direction indicator right		Working lamp
	Direction indicator left		Number plate light
	Progressive direction indicator right		Reverse alarm
	Progressive direction indicator left		Male
	SMCG (Side Marker Control Gear)		Female
	With integrated direction indicator LCG		Flood
	With integrated LCG2		Spot
	Tail light		Horizontal mounting
	Stop light		Vertical mounting
	Fog light		360° mounting possible
	Reverse light		... Lumen
	Triangle reflector		... Watt
	Without triangle reflector		ADR Zone2
	Position light		IP xx Rating
	Sidemarker light		
	Without sidemarker light		
	Sidemarker light + reflector		

# PIKTOGRAMM ÜBERSICHT / PICTOGRAM OVERVIEW

<b>LEGENDA</b>			
	Pezzi per confezione		Luce di posizione posteriore
	Pezzi per scatola		Luce di posizione anteriore
	Sinistro		Rosso, bianco, arancione
	Destro		Rosso, bianco
	Tipo di luce		Rosso
	Volt		Bianco
	Luce d'ingombro		Luce d'ingombro
	Lampadina		Catadiottro rosso
	LED		Catadiottro arancione
	Freccia		Catadiottro bianco
	Freccia destra		Faro da lavoro
	Freccia sinistra		Luce targa
	Freccia progressiva destra		Segnalatore acustico per retromarcia
	Freccia progressiva sinistra		Maschio
	Marcatori laterali di controllo		Femmina
	Con LCG per freccia		Flood
	Con LCG per tutte le funzioni		Spot
	Luce di posizione		Montaggio orizzontale
	Stop		Montaggio verticale
	Retronebbia		Montaggio a 360°
	Retromarcia		Lumen
	Catadiottro triangolare		Watt
	Senza catadiottro triangolare		ADR Zone 2
	Luce di posizione destra		IPXX
	Luce laterale		
	Senza luce laterale		
	Luce laterale + catadiottro		

<b>LÉGENDE DES PICTOGRAMMES</b>			
	Conditionnement		Feu de gabarit arrière
	X pièces par carton		Feu de gabarit avant
	Gauche		Rouge, blanc, orange
	Droit		Rouge, blanc
	Source lumineuse		Rouge
	Voltage		Blanc
	Feu sur antenne		Feu d'encombrement
	Ampoule		Catadioptr rouge
	LED		Catadioptr orange
	Clignotant		Catadioptr blanc
	Clignotant droit		Phare de travail
	Clignotant gauche		Eclaireur de plaque
	Clignotant à défilement droit		Alarme de recul
	Clignotant à défilement gauche		Mâle
	Équipement de contrôle des marqueurs latéraux		Femelle
	Avec LCG clignotant intégré		Large
	Avec LCG toutes fonctions intégré		Etroit
	Feu de position		Montage horizontal
	Feu de stop		Montage vertical
	Feu de brouillard		Montage à 360° possible
	Feu de recul		... Lumen
	Catadioptr triangulaire		... Watt
	Sans catadioptr triangulaire		ADR Zone 2
	Feu de gabarit		Classe IPxx
	Feu latéral orange		
	Sans feu latéral orange		
	Feu latéral orange+catadioptr		

## PIKTOGRAMM ÜBERSICHT / PICTOGRAM OVERVIEW

### DESCRIPCIÓN DE PICTOGRAMA

	Unidad de embalaje		Gálibo trasero
	x piezas por caja		Gálibo delantero
	Izquierdo		rojo, blanco, ambar
	derecho		rojo, blanco
	Tipo de luz		rojo
	Voltaje		blanco
	Cuerno final de linea		Cuerno final de linea
	Lámpara		Reflectante rojo
	LED		Reflectante ambar
	Indicador de dirección		Reflectante blanco
	Indicador de dirección-derecho		Faro de trabajo
	Indicador de dirección izquierdo		Luz de matrícula
	Indicador de dirección progresivo derecho		Retro-alarma
	Indicador de dirección progresivo izquierdo		Macho
	Equipo de control del marcador lateral		Hembra
	Con indicador de dirección integrado en LCG		Amplia
	Con LCG integrado (todas las funciones)		Larga
	Luz de gálibo		Montaje Horizontal
	Luz de Freno		Montaje Vertical
	Luz Antiniebla		Montaje 360°
	Luz Marcha atrás		Lumen
	Triángulo reflectante		Wattios
	Sin Triángulo reflectante		Zona 2 ADR
	Luz de posición		Tipo IPxx
	Luz lateral		
	Sin Luz lateral		
	Luz lateral + reflectante		

### LEGENDA

	Jednostka miary		Światło pozycyjne tylne
	x sztuk w kartonie		Światło pozycyjne przednie
	Lewa		Czerwone, Białe, Pomarańczowe
	Prawa		Czerwone, Białe
	Źródło światła		Czerwone
	Napięcie		Białe
	Obrys gumowy narożny		Obrys gumowy narożny
	Żarówka		Odblask czerwony
	LED		Odblask pomarańczowy
	Kierunkowskaz		Odblask biały
	Prawy kierunkowskaz		Lampa robocza
	Lewy kierunkowskaz		Oświetlenie tablicy rejestracyjnej
	Prawy kierunkowskaz progresywny		Dźwiękowy sygnalizator cofania
	Lewy kierunkowskaz progresywny		Męska
	Przekładnia kontrolująca markery boczne		Żeńska
	Ze zintegrowanym LCD dla kierunkowskazu		Światło rozproszone
	Ze zintegrowanym LCD dla wszystkich funkcji		Światło skupione
	Światło pozycyjne tylne		Montaż poziomy
	Stop		Montaż pionowy
	Światło przeciwmgłowe		Możliwość montażu 360°
	Wsteczny		Lumen
	Trójkąt z odblaskiem		Watt
	Trójkąt bez odblasku		Sterfa 2 ADR
	Światło pozycyjne		Klasa IPXX
	Światło obrysowe boczne		
	Bez światła obrysowego bocznego		
	Światło obrysowe boczne + odblask		

## PIKTOGRAMM ÜBERSICHT / PICTOGRAM OVERVIEW

PIKTOGRAM ÖZETİ			
	Paketleme Sayısı		Gabari Lamba - Kırmızı
	Her kutuda x adet		Pozisyon Lamba - Beyaz
	Sol		Kırmızı, Beyaz, Sarı
	Sağ		Kırmızı, Beyaz
	Lamba		Kırmızı
	Voltaj		Beyaz
	Boynuz Lamba		Boynuz Lamba
	Ampul		Kırmızı Reflektör
	LED		Sarı Reflektör
	Sinyal Lamba		Beyaz Reflektör
	Sinyal Lamba Sağ		Çalışma Lambası
	Sinyal Lamba Sol		Plaka Lambası
	Progresif Sinyal Lamba Sağ		Geri Vites İkaz Sireni
	Progresif Sinyal Lamba Sol		Erkek
	Yan İşaretleme Kontrol Dişlisi		Dişi
	LCG'li sinyal lamba		Geniş Açılı
	LCG'li (Bütün Fonksiyonlar)		Spot
	Park Lamba		Yatay Montaj
	Fren Lamba		Dikey Montaj
	Sis Lamba		360° Uygulanabilir
	Geri Vites Lamba		... Lumen
	Üçgen Reflektör		... Watt
	Üçgen Reflektörsüz		ADR Zone 2
	Pozisyon Lamba		IP Sınıfı
	Yan Park Lamba		
	Yan Park Lambasız		
	Yan Park Lamba+Reflektör		

KUVIEN SELITYS			
	Pakkauskoko		Takaäärivalo
	X per laatikko		Etuäärivalo
	Vasen		Punainen, valkoinen, keltainen
	Oikea		Punainen, valkoinen
	Valolähde		Punainen
	Voltia		Valkoinen
	Kumivarsivalo		Kumivarsivalo
	Polttimo		Heijastin punainen
	LED		Heijastin keltainen
	Vilku		Heijastin valkoinen
	Vilku oikea		Työvalo
	Vilku vasen		Rekisterikilven valo
	Progressiivinen vilku oikea		Peruutushälytін
	Progressiivinen vilku vasen		Uros
	Sivumerkinnän ohjauslaite		Naaras
	LCG:llä vilkkuu varten		Leveä valokuvio (flood)
	LCG:llä kaikkia toimintoja varten		Kapea valokuvio (spot)
	Parkkivalo		Vaaka-asennus
	Jarruvalo		Pystyasennus
	Sumuvalo		360° asennus mahdollinen
	Peruutusvalo		... Lumenia
	Heijastinkolmio		... Wattia
	Ilman heijastavaa kolmiota		ADR Zone 2
	Äärivalo		IP xx luokitus
	Sivuäärivalo		
	Ilman sivuäärivaloa		
	Sivuäärivalo + heijastin		

## PIKTOGRAMM ÜBERSICHT / PICTOGRAM OVERVIEW

ÖVERSIKT			
	Förpacknings-storlek		Bakre positionsljus
	x per kartong		Främre positionsljus
	Vänster		Röd, vit, gul
	Höger		Röd, vit
	Ljuskälla		Röd
	Volt		Vit
	Breddmarkering		Breddmarkering
	Glödlampa		Reflex röd
	LED		Reflex gul
	Blinkers		Reflex vit
	Blinkers Höger		Arbetsbelysning
	Blinkers Vänster		Nummerplåtsbelysning
	Progressiv blinkers höger		Backvarnare
	Progressiv blinkers vänster		Hane
	Sidmarkörskontroll		Hona
	Med integrerad LCG för blinkers		Bred ljusbild (flood)
	Med integrerad LCG för alla funktioner		Smal ljusbild (spot)
	Parkeringsljus		Horisontell montering
	Bromsljus		Vertikal montering
	Dimljus		360° montering möjlig
	Backljus		...Lumen
	Reflextriangel		...Watt
	Utan reflextriangel		ADR Zone 2
	Positionsljus		IP xx Klass
	Sidomarkeringsljus		
	Utan Sidomarkeringsljus		
	Sidomarkering + reflex		

PICTOGRAM OVERZICHT			
	Verpakkingseenheid		Positielicht achter
	x stuks per doos		Positielicht voor
	links		rood, wit, oranje
	rechts		rood, wit
	lichtbron		rood
	volt		wit
	Pendelarm		markeringslicht
	bollamp		Reflector rood
	LED		Reflector geel
	Knipperlicht		Reflector wit
	Knipperlicht rechts		Werklamp
	Knipperlicht links		Kentekenlamp
	dynamisch knipperlicht rechts		Achteruitrij alarm
	dynamisch knipperlicht links		mannelijk
	Zijmarkeringsbediening		vrouwelijk
	met geïntegreerde knipperlicht LCG		Flood
	met geïntegreerde LCG (alle functies)		Spot
	Achterlicht		horizontale montage
	Remlicht		verticale montage
	Mistlicht		360° montage mogelijk
	Achteruitrijlicht		Lumen
	Driehoek reflector		Watt
	zonder driehoek reflector		ADR Zone 2
	Positielicht		IPxx Klasse
	Zijmarkeringslicht		
	zonder zijmarkeringslicht		
	Zijmarkeringslicht + reflector		



# THE ART OF LIGHTS

## Aspöck Systems GmbH

Enzing 4 | 4722 Peuerbach | AUSTRIA  
Phone.: +43 72 76 / 26 70-0 | Fax: DW 1199  
E-Mail: office@aspoeck.com | www.aspoeck.com



10-0360-037  
ASP\_SPARE\_03\_DE | EN 072020  
Printing errors, technical changes  
as well as picture changes reserved.  
© Aspöck Systems GmbH

# www.aspoeck.com

## GROSSBRITANNIEN, IRLAND

**Aspöck UK Ltd.**  
Unit 19, Stansted Distribution Centre  
Great Hallingbury  
Bishops Stortford, Herts  
GB-CM22 7DG  
Tel.: +44 1279 655 220  
Fax: +44 1279 505 869  
E-Mail: sales@aspoeck.co.uk  
www.aspoeck.co.uk

## FRANKREICH, LUXEMBURG ALGERIEN, MAROKKO, TUNESIEN

**Aspöck France S.A.S.**  
ZAC Bel Air  
260 Rue des Vergers  
F-69480 Pommiers  
Tel.: +33 437 5508 65  
Fax: +33 437 5508 97  
E-Mail: office@aspoeck.fr

## SPANIEN, PORTUGAL

**Aspöck Iberica**  
Via Sergia, 32 Nave N° 2  
Poligono Industrial  
"Les Hortes del Cami Real"  
E-08302 Mataro (Barcelona)  
Tel.: +34 937 598 039  
Fax: +34 937 501 033  
E-Mail: aspock@aspock.com  
www.aspock.com

## SCHWEDEN, FINNLAND, NORWEGEN, DÄNEMARK, ESTLAND,

**Aspöck Norden AB**  
Honungsgatan 4  
SE-432 48 Varberg  
Tel.: +46 340 483 870  
Fax: +46 340 483 879  
E-Mail: info@aspoeck-norden.se

## ITALIEN

**PAGG Aspöck srl**  
Via Legnano, 8  
I-20835 Muggiò (MB)  
Tel.: +39 039 278 5255  
Fax: +39 039 278 9582  
E-Mail: info@aspoeck.it

## BRASILIEN

**Aspöck do Brasil Ltda.**  
Estrada RS 122 km 88,5 S/N  
Bairro São Gotardo  
Flores da Cunha-RS  
CEP 95270-000  
Tel.: +55 54 3039-5400  
E-Mail: contato@aspock.com.br

## POLEN, LITAUEN, LETTLAND, UKRAINE

**Aspöck Systems Polska Sp.z.o.o.**  
ul.Byczyńska 10  
46-320 Praszka  
Tel.: +48 34 3430 600  
Fax: +48 34 3430 609  
E-Mail: office.poland@aspoeck.com

## TÜRKEI, NAHER OSTEN

**Aspöck Aydınlatma Sistemleri Tic. Ltd.**  
Feneryolu Mah. Yıldırım Sok.  
No 20/B PK: 34724  
Kadıköy / İstanbul  
Türkei  
Tel.: +90 (0) 216 5105400-3 lines

## DEUTSCHLAND

**Suer GmbH & Co KG**  
Handelsstraße 5  
D-42929 Wermelskirchen  
Tel.: +49 2196 946 0  
Fax: +49 2196 946 100  
E-Mail: info@suer.de

## DEUTSCHLAND

**Hofmeister & Meincke**  
Carsten-Dressler-Straße 6  
D-28279 Bremen  
Tel.: +49 421 8405 296  
Fax: +49 421 8405 201  
E-Mail: bremen@hofmei.de

## ÖSTERREICH, UNGARN, KROATIEN, TSSCHECHIEN

**Ing. A. F. Baeder Ges.m.b.H.**  
Kolpingstraße 13  
A-1230 Wien  
Tel.: +43 1 865 16 40  
Fax: +43 1 869 22 12  
E-Mail: sales@baeder-automotive.com

## ÖSTERREICH (NUR 12V)

**Knott Handelsges.m.b.H.**  
Rennweg 79-81  
A-1030 Wien  
Tel.: +43 1 714 22 22  
Fax: +43 1 714 22 33  
E-Mail: info@knott.at

## SCHWEIZ

**AGL AG für Lastwagenzubehöre**  
Müslistrasse 43  
CH-8957 Spreitenbach  
Tel.: +41 41 348 04 80  
Fax: +41 41 340 31 79  
E-Mail: info@agl.ch

## NIEDERLANDE, BELGIEN

**Frits Dijk International**  
Collse Heide 64  
NL-5674 VN Nuenen  
Tel.: +31 40 2831815  
Fax: +31 40 2838717  
E-Mail: info@fritsdijk.nl

## SERBIEN, RUMÄNIEN, BULGARIEN, SLOWAKEI

**Ing. A. F. Baeder Ges.m.b.H.**  
Kolpingstraße 13  
A-1230 Wien  
Tel.: +43 1 865 16 40  
Fax: +43 1 869 22 12  
E-Mail: sales@baeder-automotive.com

## MONTENEGRO, SLOWENIEN, BOSNIEN UND HERZEGOWINA

**Ing. A. F. Baeder Ges.m.b.H.**  
Kolpingstraße 13  
A-1230 Wien  
Tel.: +43 1 865 16 40  
Fax: +43 1 869 22 12  
E-Mail: sales@baeder-automotive.com

## ISRAEL

**M.N. Systems**  
Pier St., Industrial Park Emek 10  
Hefer, IL-3877701  
P.O.B 12186  
Tel.: +97 24 6220 111  
Fax: +97 24 6220 808  
E-Mail: info@mnsys.co.il

## OST ASIEN

**JM Company**  
312-15, Jaedurumi-gil  
Paju-si, Gyeonggi-do  
10863, S. Korea  
Tel.: +82 31 944 7670  
Fax: +82 31 947 7671

## RUSSLAND, KIRGISISTAN, MONGOLEI, WEISSRUSSLAND, KASACHSTAN

**STAT Ltd**  
125464, Moscow region,  
Volokolamskoe Highway  
House 142  
Pom. I, Room 35, Office 535  
Tel.: +7 (495) 739-03-47  
email: info@stat-parts.ru  
www.stat-parts.ru

## SÜDAFRIKA, BOTSWANA, LESOTHO, NAMIBIA, SIMBABWE, SWASILAND

**Trail-Link South Africa**  
699 Seccull Avenue  
0084 Mayville, Pretoria  
P.O.B. 880  
Tel.: +27 12 335 7402  
E-Mail: sales@trail-link.co.za