

The logo features a stylized red 'A' composed of three vertical bars on the left, followed by the text 'ALCAN OTOMOTIV' in a bold, blue, sans-serif font.

CALIPER SYSTEMS



**MERITOR
SERIES**



**KNORR
SERIES**



**WABCO
SERIES**



**HALDEX
SERIES**



**Z-CAM
SERIES**

ALCAN OTOMOTIV

CALIPER SYSTEMS

Hakkımızda

ALCAN OTOMOTİV 1978 Yılında, İzmir'de kurulmuştur. Firmamızın kuruluşundan itibaren daima en iyi hizmet ve en yüksek kalite, geçmişten günümüze kadar olan değişmez politikasıdır.

Sürekli artan kapasitesi ile yeni modern fabrikasında, üretim teknolojisini geliştirerek ve kapasitesini artırarak hizmete devam etmektedir.

Alcan Otomotiv'in itibarı, dürüstlüğü güvenilirliği ve müşteri çıkarlarını kalben hissetmesiyle oluşmuştur ve bunun sonucunda da ALCAN OTOMOTİV, haklı liderlik konumuna gelmiştir.

Who We Are

ALCAN AUTOMOTIVE Company was established in IZMIR 1978. Best service & high quality of manufacturing is one of our important mission since from past to future.

ALCAN AUTOMOTIVE Company continue to improve its manufacturing capacity and updates its technology in the new constructed.

Alcan Automotive is leader in its sector with honesty & reliability, thinking benefit of customers.

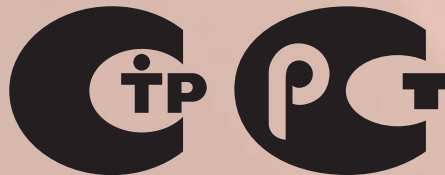

ALCAN OTOMOTIV

CALIPER SYSTEMS



ALCAN OTOMOTIV

CALIPER SYSTEMS



MERITOR

Page / Sayfa 3-28

DUCO

- B DUCO
- C DUCO
- D DUCO AXIAL
- D DUCO RADIAL
- LE DUCO

LISA

- C LISA
- D LISA

DX 195

D3

ELSA

- ELSA 1
- ELSA 2
- ELSA 1 RADIAL
- ELSA 2 RADIAL
- ELSA 195
- ELSA 225

KNORR

Page / Sayfa 29-45

SN5...

SB5...

SN5...

SB7...

SN6...

SN7...

SK7...

WABCO

Page / Sayfa 47-54

17,5"

19,5"

22,5"

HALDEX

Page / Sayfa 55-56

MARK II

MARK III

MARK IV DB 22

MODUL X

Z - CAM

Page / Sayfa 57-61

ALCAN OTOMOTIV CALIPER SYSTEMS

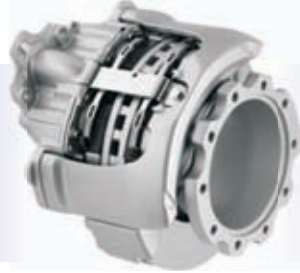

MERITOR



KNORR



WABCO



HALDEX



Z - CAM

ALCAN OTOMOTIV

CALIPER SYSTEMS



**MERITOR
SERIES**



ALCAN OTOMOTIV

CALIPER SYSTEMS

KALİPER AYAR MEKANİZMASI (ÖN) • CALIPER ADJUSTING MECHANISM (FRONT)



| | |
|--------------------|------------------------------------|
| ALCAN OTOMOTIV NO. | 2003 |
| OEM NO. | MCK1113, SJ4110, 3092267, 85102093 |
| MODEL | B Duco, C Duco, D Duco, LE Duco |

| Ref. No. | Parça Adı / Part Name | Ölçü (mm) Dimensions | Adet Pcs. |
|----------|---|----------------------|-----------|
| 1 | 1806 Kaliper Ayar Mekanizması / Caliper Adjusting Mechanism | Ön / Front | 1 |
| 2 | 1905 Conta / Seal | - | 1 |
| 3 | 1904 Conta / Seal | - | 1 |

KALİPER AYAR MEKANİZMASI (ARKA-SOL) • CALIPER ADJUSTING MECHANISM (REAR-LEFT)



| | |
|--------------------|------------------------------------|
| ALCAN OTOMOTIV NO. | 2004 |
| OEM NO. | MCK1111, SJ4102, 3092265, 85102095 |
| MODEL | B Duco, C Duco, D Duco, LE Duco |

| Ref. No. | Parça Adı / Part Name | Ölçü (mm) Dimensions | Adet Pcs. |
|----------|---|----------------------|-----------|
| 1 | 1807 Kaliper Ayar Mekanizması / Caliper Adjusting Mechanism | Arka - Sol Rear-Left | 1 |
| 2 | 1905 Conta / Seal | - | 1 |
| 3 | 1904 Conta / Seal | - | 1 |

KALİPER AYAR MEKANİZMASI (ARKA-SAĞ) • CALIPER ADJUSTING MECHANISM (REAR-RIGHT)



| | |
|--------------------|------------------------------------|
| ALCAN OTOMOTIV NO. | 2005 |
| OEM NO. | MCK1112, SJ4103, 3092266, 85102096 |
| MODEL | B Duco, C Duco, D Duco, LE Duco |

| Ref. No. | Parça Adı / Part Name | Ölçü (mm) Dimensions | Adet Pcs. |
|----------|---|-----------------------|-----------|
| 1 | 1808 Kaliper Ayar Mekanizması / Caliper Adjusting Mechanism | Arka - Sağ Rear-Right | 1 |
| 2 | 1905 Conta / Seal | - | 1 |
| 3 | 1904 Conta / Seal | - | 1 |

KALİPER DAYAMA TAMİR TAKIMI • CALIPER TAPPET HEAD REPAIR KIT



| | |
|--------------------|---------------------------------|
| ALCAN OTOMOTIV NO. | 2006 |
| OEM NO. | MCK1238, 3092264 |
| MODEL | B Duco, C Duco, D Duco, LE Duco |

| Ref. No. | Parça Adı / Part Name | Ölçü (mm) Dimensions | Adet Pcs. |
|----------|--|----------------------|-----------|
| 1 | 1308 Toz Lastiği / Tappet Boot | - | 2 |
| 2 | 1809 Kaliper İtenek / Brake Caliper Tappet | - | 2 |
| 3 | 1906 Segman / Clips | - | 2 |



ALCAN OTOMOTIV

CALIPER SYSTEMS

KALİPER PERNO VE KEÇE TAMİR TAKIMI (ÖN) • CALIPER GUIDE AND SEALS REPAIR KIT (FRONT)



| | |
|--------------------|--|
| ALCAN OTOMOTIV NO. | 2007 |
| OEM NO. | MCK1135, MCK1118, SJ4107, 3092256, 3096768, 85102092 |
| MODEL | D Duco |

| No. | Ref. No. | Parça Adı / Part Name | Ölçü (mm) Dimensions | Adet Pcs. |
|-----|----------|------------------------|----------------------|-----------|
| 1 | 1101 | Perno / Pin | Ø 35 / 102 | 2 |
| 2 | 1201 | Civata / Screw | M 20 X 2 / 125 | 2 |
| 3 | 1403 | Burç / Round Bush | Ø 35 x 40 / 77 mm | 1 |
| 4 | 1402 | Burç / Bush | Ø 35 X 39 / 30 mm | 2 |
| 5 | 1501 | Perno Kapağı / Pin Cap | Ø 40 / 18.5 | 2 |
| 6 | 1309 | Toz Körük / Pin Boot | - | 2 |
| 7 | 1401 | Perno Yüzük / Pin Ring | Ø 37 X 40 / 10 mm | 2 |

KALİPER PERNO VE KEÇE TAMİR TAKIMI (ARKA) • CALIPER GUIDE AND SEALS REPAIR KIT (REAR)



| | |
|--------------------|--|
| ALCAN OTOMOTIV NO. | 2008 |
| OEM NO. | MCK1134, MCK1116, SJ4094, 3092255, 3095627, 85102094 |
| MODEL | B Duco, C Duco, D Duco, LE Duco |

| No. | Ref. No. | Parça Adı / Part Name | Ölçü (mm) Dimensions | Adet Pcs. |
|-----|----------|------------------------|----------------------|-----------|
| 1 | 1101 | Perno / Pin | Ø 35 / 102 | 1 |
| 2 | 1102 | Perno / Pin | Ø 35 / 60 mm | 1 |
| 3 | 1201 | Civata / Screw | M 20 X 2 / 125 | 1 |
| 4 | 1202 | Civata / Screw | M20 x 2 / 80 mm | 1 |
| 5 | 1403 | Burç / Round Bush | Ø 35 x 40 / 77 mm | 1 |
| 6 | 1402 | Burç / Bush | Ø 35 X 39 / 30 mm | 1 |
| 7 | 1501 | Perno Kapağı / Pin Cap | Ø 40 / 18.5 | 2 |
| 8 | 1309 | Toz Körük / Pin Boot | - | 2 |
| 9 | 1401 | Perno Yüzük / Pin Ring | Ø 37 X 40 / 10 mm | 2 |

KALİPER AYAR MEKANİZMASI TAMİR TAKIMI (SOL) - YARIM TAKIM • CALIPER ADJUSTING TAPPET REPAIR KIT (LEFT) / HALF KIT



| | |
|--------------------|---------------------------------|
| ALCAN OTOMOTIV NO. | 2009 |
| OEM NO. | - |
| MODEL | B Duco, C Duco, D Duco, LE Duco |

| No. | Ref. No. | Parça Adı / Part Name | Ölçü (mm) Dimensions | Adet Pcs. |
|-----|----------|--|----------------------|-----------|
| 1 | 1810 | Ayar Mekanizması / Adjusting Mechanism | Left | 1 |
| 2 | 1308 | Toz Lastiği / Tappet Boot | - | 1 |
| 3 | 1404 | Plastik Burç / Bush | Ø 45 x 49 / 31 mm | 1 |
| 4 | 1809 | Kaliper İtenek / Brake Caliper Tappet | - | 1 |
| 5 | 1906 | Segman / Clips | - | 1 |
| 6 | 1907 | Mekanizma Keçesi / Mechanism Seal | - | 1 |



ALCAN OTOMOTIV

CALIPER SYSTEMS

KALİPER AYAR MEKANİZMASI TAMİR TAKIMI (SOL) • CALIPER ADJUSTING TAPPET REPAIR KIT (LEFT)



| | |
|--------------------|---------------------------------|
| ALCAN OTOMOTIV NO. | 2060 |
| OEM NO. | MCK1236, 3092262 |
| MODEL | B Duco, C Duco, D Duco, LE Duco |

| Ref. No. | Parça Adı / Part Name | Ölçü (mm) Dimensions | Adet Pcs. | |
|----------|-----------------------|--|-------------------|---|
| 1 | 1810 | Ayar Mekanizması / Caliper Adjusting Mechanism | Sol / Left | 2 |
| 2 | 1308 | Toz Lastiği / Tappet Boot | - | 2 |
| 3 | 1907 | Mekanizma Keçesi / Mechanism Seal | - | 2 |
| 4 | 1906 | Segman / Clips | - | 2 |
| 5 | 1809 | Kaliper İtenek / Brake Caliper Tappet | - | 2 |
| 6 | 1404 | Plastik Burç / Bush | Ø 45 x 49 / 31 mm | 2 |

KALİPER AYAR MEKANİZMASI TAMİR TAKIMI (SAĞ) / YARIM TAKIM • CALIPER ADJUSTING TAPPET REPAIR KIT (RIGHT) / HALF KIT



| | |
|--------------------|---------------------------------|
| ALCAN OTOMOTIV NO. | 2010 |
| OEM NO. | - |
| MODEL | B Duco, C Duco, D Duco, LE Duco |

| Ref. No. | Parça Adı / Part Name | Ölçü (mm) Dimensions | Adet Pcs. | |
|----------|-----------------------|--|-------------------|---|
| 1 | 1811 | Ayar Mekanizması / Caliper Adjusting Mechanism | Sağ / Right | 1 |
| 2 | 1308 | Toz Lastiği / Tappet Boot | - | 1 |
| 3 | 1404 | Plastik Burç / Bush | Ø 45 x 49 / 31 mm | 1 |
| 4 | 1809 | Kaliper İtenek / Brake Caliper Tappet | - | 1 |
| 5 | 1906 | Segman / Clips | - | 1 |
| 6 | 1907 | Mekanizma Keçesi / Mechanism Seal | - | 1 |

KALİPER AYAR MEKANİZMASI TAMİR TAKIMI (SAĞ) • CALIPER ADJUSTING TAPPET REPAIR KIT (RIGHT)



| | |
|--------------------|---------------------------------|
| ALCAN OTOMOTIV NO. | 2061 |
| OEM NO. | MCK1237, MCK1239, 3092263 |
| MODEL | B Duco, C Duco, D Duco, LE Duco |

| Ref. No. | Parça Adı / Part Name | Ölçü (mm) Dimensions | Adet Pcs. | |
|----------|-----------------------|--|-------------------|---|
| 1 | 1811 | Ayar Mekanizması / Caliper Adjusting Mechanism | Sağ / Right | 2 |
| 2 | 1308 | Toz Lastiği / Tappet Boot | - | 2 |
| 3 | 1907 | Mekanizma Keçesi / Mechanism Seal | - | 2 |
| 4 | 1906 | Segman / Clips | - | 2 |
| 5 | 1809 | Kaliper İtenek / Brake Caliper Tappet | - | 2 |
| 6 | 1404 | Plastik Burç / Bush | Ø 45 x 49 / 31 mm | 2 |



ALCAN OTOMOTIV

CALIPER SYSTEMS

KALİPER FREN PABUCU SEVİYE GÖSTERGE ÇUBUĞU • CALIPER VISUAL PAD WEAR ASSEMBLY

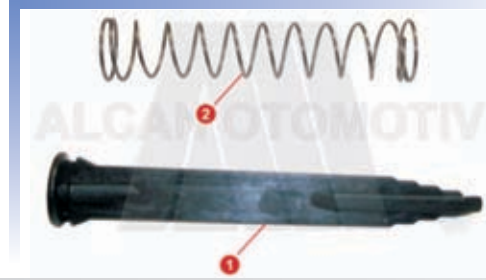

| | |
|--------------------|---------------------------------|
| ALCAN OTOMOTIV NO. | 2075 |
| OEM NO. | SJ4111 |
| MODEL | B Duco, C Duco, D Duco, LE Duco |

| No. | Ref. No. | Parça Adı / Part Name | Ölçü (mm) Dimensions | Adet Pcs. |
|-----|----------|---------------------------------|----------------------|-----------|
| 1 | 1936 | Gösterge Çubuğu / Indicator Bar | - | 1 |
| 2 | 1713 | Yay / Spring | - | 1 |

KALİPER TAMİR TAKIMI • CALIPER REPAIR KIT

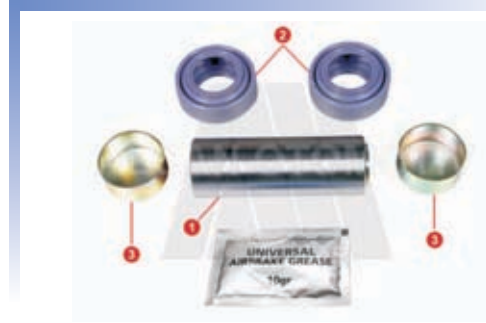

| | |
|--------------------|---------------------------------|
| ALCAN OTOMOTIV NO. | 2033 |
| OEM NO. | MCK1065, MCK1066 |
| MODEL | B Duco, C Duco, D Duco, LE Duco |

| No. | Ref. No. | Parça Adı / Part Name | Ölçü (mm) Dimensions | Adet Pcs. |
|-----|----------|------------------------|----------------------|-----------|
| 1 | 1101 | Perno / Pin | Ø 35 / 102 | 1 |
| 2 | 1309 | Toz Körük / Pin Boot | - | 2 |
| 3 | 1501 | Perno Kapağı / Pin Cap | Ø 40 / 18.5 | 2 |

KALİPER PERNO VE KÖRÜK TAMİR TAKIMI • CALIPER GUIDE AND DUST COVER REPAIR KIT



| | |
|--------------------|---------------------------------|
| ALCAN OTOMOTIV NO. | 2049 |
| OEM NO. | MCK1299, 3095628, 85107718 |
| MODEL | B Duco, C Duco, D Duco, LE Duco |

| No. | Ref. No. | Parça Adı / Part Name | Ölçü (mm) Dimensions | Adet Pcs. |
|-----|----------|------------------------|----------------------|-----------|
| 1 | 1101 | Perno / Pin | Ø 35 / 102 | 1 |
| 2 | 1202 | Civata / Screw | M20 x 2 / 80 mm | 1 |
| 3 | 1201 | Civata / Screw | M20 x 2 / 125 | 2 |
| 3 | 1309 | Toz Körük / Pin Boot | - | 2 |
| 3 | 1501 | Perno Kapağı / Pin Cap | Ø 40 / 18.5 | 2 |

KALİPER KAPAK CONTASI • CALIPER COVER PLATE GASKET

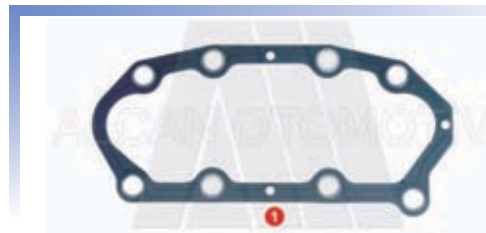

| | |
|--------------------|--------|
| ALCAN OTOMOTIV NO. | 2054 |
| OEM NO. | - |
| MODEL | D Duco |

| No. | Ref. No. | Parça Adı / Part Name | Ölçü (mm) Dimensions | Adet Pcs. |
|-----|----------|------------------------------------|----------------------|-----------|
| 1 | 2054 | Kapak Contası / Cover Plate Gasket | - | 1 |

KALİPER KAPAK CONTASI • CALIPER COVER PLATE GASKET



| | |
|--------------------|-----------------|
| ALCAN OTOMOTIV NO. | 2055 |
| OEM NO. | - |
| MODEL | C Duco, LE Duco |

| No. | Ref. No. | Parça Adı / Part Name | Ölçü (mm) Dimensions | Adet Pcs. |
|-----|----------|------------------------------------|----------------------|-----------|
| 1 | 2055 | Kapak Contası / Cover Plate Gasket | - | 1 |



ALCAN OTOMOTIV

CALIPER SYSTEMS

KALİPER KAPAK CONTASI • CALIPER COVER PLATE GASKET



ALCAN OTOMOTIV NO. 2056

OEM NO. -

MODEL D Duco

| | Ref. No. | Parça Adı / Part Name | Ölçü (mm) Dimensions | Adet Pcs. |
|---|----------|------------------------------------|----------------------|-----------|
| 1 | 2056 | Kapak Contası / Cover Plate Gasket | - | 1 |

KALİPER KAPAK CONTA TAKIMI • CALIPER COVER PLATE GASKET KIT



ALCAN OTOMOTIV NO. 2013

OEM NO. SJ4105

MODEL B Duco, C Duco, D Duco, LE Duco

| | Ref. No. | Parça Adı / Part Name | Ölçü (mm) Dimensions | Adet Pcs. |
|---|----------|-------------------------|----------------------|-----------|
| 1 | 2056 | Conta / Seal | - | 1 |
| 2 | 1909 | Keçe / Felt | - | 1 |
| 3 | 1905 | Conta / Seal | - | 1 |
| 4 | 2045 | Toz Tapası / Dust Cover | - | 1 |

KALİPER KAPAK CONTA TAKIMI • CALIPER COVER PLATE GASKET KIT



ALCAN OTOMOTIV NO. 2014

OEM NO. MCK1041, 3095669

MODEL B Duco, C Duco, D Duco, LE Duco

| | Ref. No. | Parça Adı / Part Name | Ölçü (mm) Dimensions | Adet Pcs. |
|---|----------|-------------------------|----------------------|-----------|
| 1 | 2055 | Conta / Seal | - | 1 |
| 2 | 1909 | Keçe / Felt | - | 1 |
| 3 | 1905 | Conta / Seal | - | 1 |
| 4 | 2045 | Toz Tapası / Dust Cover | - | 1 |

KALİPER KAPAK CONTA TAKIMI • CALIPER COVER PLATE GASKET KIT



ALCAN OTOMOTIV NO. 2015

OEM NO. SJ4109, 3092270

MODEL B Duco, C Duco, D Duco, LE Duco

| | Ref. No. | Parça Adı / Part Name | Ölçü (mm) Dimensions | Adet Pcs. |
|---|----------|-------------------------|----------------------|-----------|
| 1 | 2054 | Conta / Seal | - | 1 |
| 2 | 1909 | Keçe / Felt | - | 1 |
| 3 | 1905 | Conta / Seal | - | 1 |
| 4 | 2045 | Toz Tapası / Dust Cover | - | 1 |



ALCAN OTOMOTIV

CALIPER SYSTEMS

AKTARMA DIŐLİ SETİ • INTERMEDIATE GEAR & SPRING SET

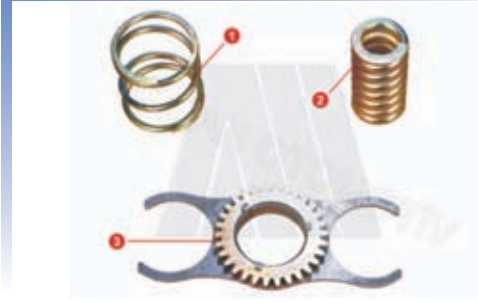

| ALCAN OTOMOTIV NO. | 2016 | | | |
|--------------------|---------------------------------|--|----------------------|-----------|
| OEM NO. | MCK1067, 3095626 | | | |
| MODEL | B Duco, C Duco, D Duco, LE Duco | | | |
| No. | Ref. No. | Parça Adı / Part Name | Ölçü (mm) Dimensions | Adet Pcs. |
| 1 | 1703 | Yay / Spring | - | 1 |
| 2 | 1704 | Yay / Spring | - | 1 |
| 3 | 1816 | Aktarma Diőli Sağı / Intermediate Gear | - | 1 |

KALİPER AYAR MEKANİZMASI (SOL) • CALIPER ADJUSTING MECHANISM (LEFT)

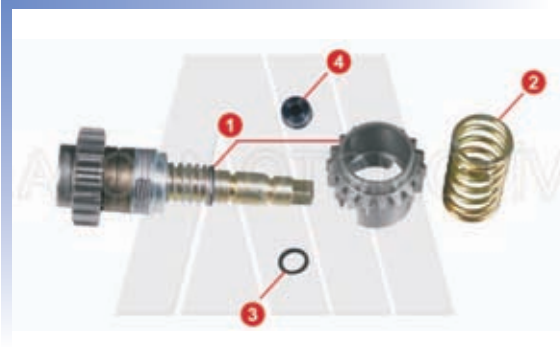

| ALCAN OTOMOTIV NO. | 2017 | | | |
|--------------------|-----------------|--|----------------------|-----------|
| OEM NO. | SJ4113, 3092763 | | | |
| MODEL | C Lisa, D Lisa | | | |
| No. | Ref. No. | Parça Adı / Part Name | Ölçü (mm) Dimensions | Adet Pcs. |
| 1 | 1817 | Ayar Mekanizması / Adjusting Mechanism | Sol / Left | 1 |
| 2 | 1705 | Yay / Spring | - | 1 |
| 3 | 1909 | Keçe / Felt | - | 1 |
| 4 | 1328 | Mekanizma Toz Lastiđi / Adjusting Boot | - | 1 |

KALİPER AYAR MEKANİZMASI (SAĐ) • CALIPER ADJUSTING MECHANISM (RIGHT)



| ALCAN OTOMOTIV NO. | 2018 | | | |
|--------------------|-----------------|--|----------------------|-----------|
| OEM NO. | SJ4114, 3092764 | | | |
| MODEL | C Lisa, D Lisa | | | |
| No. | Ref. No. | Parça Adı / Part Name | Ölçü (mm) Dimensions | Adet Pcs. |
| 1 | 1818 | Ayar Mekanizması / Adjusting Mechanism | Sađ / Right | 1 |
| 2 | 1705 | Yay / Spring | - | 1 |
| 3 | 1909 | Keçe / Felt | - | 1 |
| 4 | 1328 | Mekanizma Toz Lastiđi / Adjusting Boot | - | 1 |

KALİPER PERNO VE BURÇ TAMİR TAKIMI • CALIPER GUIDES AND BUSHES REPAIR KIT



| ALCAN OTOMOTIV NO. | 2029 | | | |
|--------------------|-----------------------------|---------------------------|----------------------|-----------|
| OEM NO. | SJ4076, 3098108, 5001837006 | | | |
| MODEL | C Lisa, D Lisa | | | |
| No. | Ref. No. | Parça Adı / Part Name | Ölçü (mm) Dimensions | Adet Pcs. |
| 1 | 1108 | Perno / Pin | Ø 35 / 79 mm | 1 |
| 2 | 1107 | Perno / Pin | Ø 35 / 132 mm | 1 |
| 3 | 1205 | Civata / Screw | M20 x 1.5 / 90 mm | 1 |
| 4 | 1206 | Civata / Screw | M20 x 1.5 / 150 mm | 1 |
| 5 | 1309 | Toz Lastiđi / Tappet Boot | - | 2 |
| 6 | 1413 | Yüzük / Pin Ring | Ø 37 x 47 / 12 mm | 2 |
| 7 | 1407 | Burç / Round Bush | Ø 35 x 39 / 30 mm | 2 |
| 8 | 1414 | Burç / Round Bush | Ø 35 x 41 / 30 mm | 2 |
| 9 | 1504 | Perno Kapađı / Pin Cap | Ø 45 / 14.5 mm | 2 |
| 10 | 1415 | Oval Burç / Oval Bush | Ø 35-36 x 39 / 47 mm | 1 |



ALCAN OTOMOTIV

CALIPER SYSTEMS

KALİPER TOZ LASTİK VE KEÇE TAKIMI • BRAKE CALIPER BOOT & SEAL SET



ALCAN OTOMOTIV NO. 2035

OEM NO. SJ4061

MODEL C Lisa, D Lisa

| Ref. No. | Parça Adı / Part Name | Ölçü (mm) Dimensions | Adet Pcs. |
|----------|---|----------------------|-----------|
| 1 | 1309 Toz Köruk / Pin Boot | - | 2 |
| 2 | 1313 Toz Lastiği / Tappet Boot | - | 1 |
| 3 | 1823 Muhafaza Sacı / Shield | Ø 42 x 56 / 6 mm | 1 |
| 4 | 1918 Conta / Seal | Ø 40 x 57 / 6 mm | 1 |
| 5 | 1917 Conta / Seal | Ø 39 x 52 / 5.5 mm | 1 |
| 6 | 1919 Mekanizma O-ring / Adjusting O-ring | - | 1 |
| 7 | 1328 Mekanizma Toz Lastiği / Adjusting Boot | - | 1 |
| 8 | 1920 Conta / Seal | - | 1 |

KALİPER AYAR DİŞLİ TAKIMI (SOL) • CALIPER ADJUSTING GEAR KIT (LEFT)



ALCAN OTOMOTIV NO. 2037

OEM NO. MCK1021, MCK1151

MODEL C Lisa, D Lisa

| Ref. No. | Parça Adı / Part Name | Ölçü (mm) Dimensions | Adet Pcs. |
|----------|------------------------------------|----------------------|-----------|
| 1 | 1824 Merkez Şaft / Operation Shaft | Sol / Left | 1 |
| 2 | 1825 Taban / Fixed Ramp | Sol / Left | 1 |
| 3 | 1826 Pim / Anti Rotation Pin | - | 1 |
| 4 | 1602 Top / Ball | - | 3 |

AYAR DİŞLİ TABANI (SOL) • ADJUSTING GEAR RAMP (LEFT)



ALCAN OTOMOTIV NO. 2062

OEM NO. -

MODEL C Lisa, D Lisa

| Ref. No. | Parça Adı / Part Name | Ölçü (mm) Dimensions | Adet Pcs. |
|----------|-------------------------|----------------------|-----------|
| 1 | 1825 Taban / Fixed Ramp | Sol / Left | 1 |

AYAR DİŞLİ ŞAFTI (SOL) • ADJUSTING GEAR SHAFT (LEFT)



ALCAN OTOMOTIV NO. 2063

OEM NO. -

MODEL C Lisa, D Lisa

| Ref. No. | Parça Adı / Part Name | Ölçü (mm) Dimensions | Adet Pcs. |
|----------|------------------------------------|----------------------|-----------|
| 1 | 1824 Merkez Şaft / Operation Shaft | Sol / Left | 1 |



ALCAN OTOMOTIV

CALIPER SYSTEMS

KALİPER AYAR DİŞLİ TAKIMI (SAĞ) • CALIPER ADJUSTING GEAR KIT (RIGHT)



| | |
|--------------------|------------------|
| ALCAN OTOMOTIV NO. | 2038 |
| OEM NO. | MCK1022, MCK1152 |
| MODEL | C Lisa, D Lisa |

| No. | Ref. No. | Parça Adı / Part Name | Ölçü (mm) Dimensions | Adet Pcs. |
|-----|----------|-------------------------------|----------------------|-----------|
| 1 | 1827 | Merkez Şaft / Operation Shaft | Sağ / Right | 1 |
| 2 | 1828 | Taban / Fixed Ramp | Sağ / Right | 1 |
| 3 | 1826 | Pim / Anti Rotation Pin | - | 1 |
| 4 | 1602 | Top / Ball | - | 3 |

AYAR DİŞLİ TABANI (SAĞ) • ADJUSTING GEAR RAMP (RIGHT)



| | |
|--------------------|----------------|
| ALCAN OTOMOTIV NO. | 2064 |
| OEM NO. | - |
| MODEL | C Lisa, D Lisa |

| No. | Ref. No. | Parça Adı / Part Name | Ölçü (mm) Dimensions | Adet Pcs. |
|-----|----------|-----------------------|----------------------|-----------|
| 1 | 1828 | Taban / Fixed Ramp | Sağ / Right | 1 |

AYAR DİŞLİ ŞAFTI (SAĞ) • ADJUSTING GEAR SHAFT (RIGHT)



| | |
|--------------------|----------------|
| ALCAN OTOMOTIV NO. | 2065 |
| OEM NO. | - |
| MODEL | C Lisa, D Lisa |

| No. | Ref. No. | Parça Adı / Part Name | Ölçü (mm) Dimensions | Adet Pcs. |
|-----|----------|-------------------------------|----------------------|-----------|
| 1 | 1827 | Merkez Şaft / Operation Shaft | Sağ / Right | 1 |

AYAR DİŞLİ TOPU • ADJUSTING GEAR BALL



| | |
|--------------------|----------------|
| ALCAN OTOMOTIV NO. | 2066 |
| OEM NO. | - |
| MODEL | C Lisa, D Lisa |

| No. | Ref. No. | Parça Adı / Part Name | Ölçü (mm) Dimensions | Adet Pcs. |
|-----|----------|-----------------------|----------------------|-----------|
| 1 | 1602 | Top / Ball | - | 3 |

KALİPER AYAR DİŞLİSİ (SOL) • CALIPER ADJUSTING GEAR (LEFT)



| | |
|--------------------|-----------------|
| ALCAN OTOMOTIV NO. | 2039 |
| OEM NO. | SJ4073, 3098110 |
| MODEL | C Lisa, D Lisa |

| No. | Ref. No. | Parça Adı / Part Name | Ölçü (mm) Dimensions | Adet Pcs. |
|-----|----------|---------------------------------------|----------------------|-----------|
| 1 | 2039 | Kaliper Ayar Dişlisi / Adjusting Gear | Sol / Left | 1 |



ALCAN OTOMOTIV

CALIPER SYSTEMS

KALİPER AYAR DIŞLİSİ (SAĞ) • CALIPER ADJUSTING GEAR (RIGHT)



ALCAN OTOMOTIV NO. 2040

OEM NO. SJ4074, 3098111

MODEL C Lisa, D Lisa

| No. | Ref. No. | Parça Adı / Part Name | Ölçü (mm) Dimensions | Adet Pcs. |
|-----|----------|---------------------------------------|----------------------|-----------|
| 1 | 2040 | Kaliper Ayar Dişlisi / Adjusting Gear | Sağ / Right | 1 |

RULMAN TAKIMI • NEEDLE & ROLLER BEARINGS



ALCAN OTOMOTIV NO. 2053

OEM NO. SJ4031

MODEL C Lisa, D Lisa

| No. | Ref. No. | Parça Adı / Part Name | Ölçü (mm) Dimensions | Adet Pcs. |
|-----|----------|-------------------------------------|----------------------|-----------|
| 1 | 1839 | Pul / Washer | Ø73 / Ø47 mm | 1 |
| 2 | 1605 | Şaft Rulmanı / Shaft Roller Bearing | Ø72,5 / Ø46 x 8,5 mm | 1 |
| 3 | 1420 | Burç / Bush | Ø44 x Ø40 x 15 mm | 1 |
| 4 | 1507 | Yüzük / Dust Excluder Retainer | Ø44 / Ø37,5 mm | 1 |
| 5 | 1606 | Şaft Rulmanı / Shaft Roller Bearing | Ø52 / Ø46 x 16 mm | 1 |

KALİPER AYAR DIŞLİSİ (SOL) • CALIPER ADJUSTING GEAR (LEFT)

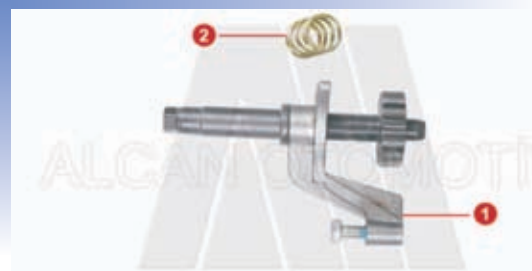

ALCAN OTOMOTIV NO. 2019

OEM NO. -

MODEL ELSA 2

| No. | Ref. No. | Parça Adı / Part Name | Ölçü (mm) Dimensions | Adet Pcs. |
|-----|----------|-------------------------------|----------------------|-----------|
| 1 | 1819 | Ayar Dişlisi / Adjusting Gear | Sol / Left | 1 |
| 2 | 1706 | Yay / Spring | - | 1 |

KALİPER AYAR DIŞLİSİ (SAĞ) • CALIPER ADJUSTING GEAR (RIGHT)

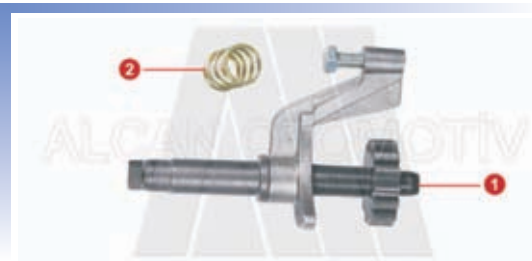

ALCAN OTOMOTIV NO. 2020

OEM NO. -

MODEL ELSA 2

| No. | Ref. No. | Parça Adı / Part Name | Ölçü (mm) Dimensions | Adet Pcs. |
|-----|----------|-------------------------------|----------------------|-----------|
| 1 | 1820 | Ayar Dişlisi / Adjusting Gear | Sağ / Right | 1 |
| 2 | 1706 | Yay / Spring | - | 1 |

KALİPER AYAR MEKANİZMASI TAMİR TAKIMI • CALIPER ADJUSTING MECHANISM SEALING KIT



ALCAN OTOMOTIV NO. 2021

OEM NO. -

MODEL Elsa 2, Elsa 195, Elsa 225

| No. | Ref. No. | Parça Adı / Part Name | Ölçü (mm) Dimensions | Adet Pcs. |
|-----|----------|-----------------------|----------------------|-----------|
| 1 | 1405 | Burç / Bush | - | 2 |
| 2 | 1912 | Keçe / Felt | - | 2 |
| 3 | 1406 | Yüzük / Ring | - | 2 |



ALCAN OTOMOTIV

CALIPER SYSTEMS

MEKANİZMA TAMİR TAKIMI • MECHANISM REPAIR KIT

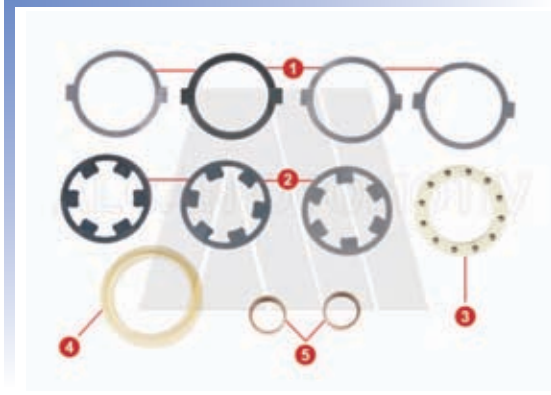

ALCAN OTOMOTIV NO. 2044

OEM NO. -

MODEL Elsa 2, Elsa 195, Elsa 225, EX 225

| No. | Ref. No. | Parça Adı / Part Name | Ölçü (mm) Dimensions | Adet Pcs. |
|-----|----------|------------------------------|----------------------|-----------|
| 1 | 1834 | Pul / Clutch Plate | - | 4 |
| 2 | 1836 | Pul / Clutch Plate | - | 3 |
| 3 | 1604 | Rulman / Bearing | - | 1 |
| 2 | 1417 | Plastik Yüzük / Plastik Ring | - | 1 |
| 3 | 1418 | Yüzük / Ring | - | 2 |

KALİPER AYAR MEKANİZMASI (ALUMINYUM) • CALIPER CALIBRATION MECHANISM (ALUMINIUM)



ALCAN OTOMOTIV NO. 2022

OEM NO. -

MODEL Elsa 2

| No. | Ref. No. | Parça Adı / Part Name | Ölçü (mm) Dimensions | Adet Pcs. |
|-----|----------|----------------------------------|----------------------|-----------|
| 1 | 1821 | Mekanizma Kapağı / Mechanism Cap | - | 1 |
| 2 | 2057 | Conta / Seal | - | 1 |
| 3 | 1405 | Burç / Bush | - | 2 |
| 4 | 1912 | Keçe / Felt | - | 1 |
| 5 | 1406 | Yüzük / Ring | - | 2 |
| 6 | 1203 | Civata Seti / Screw Set | - | 1 |

AYAR MEKANİZMASI KOMPLE • CALIBRATION MECHANISM COMPLETE



ALCAN OTOMOTIV NO. 2023

OEM NO. -

MODEL Elsa 2

| No. | Ref. No. | Parça Adı / Part Name | Ölçü (mm) Dimensions | Adet Pcs. |
|-----|----------|---|----------------------|-----------|
| 1 | 2024 | Kaliper Ayar Mekanizması / Caliper Adjuster Mechanism | - | 1 |
| 2 | 2025 | Kaliper Fren Ayar Dişlisi / Caliper Brake Lining Calibration Gear | - | 2 |
| 3 | 1821 | Mekanizma Kapağı / Mechanism Cap | - | 1 |
| 4 | 2021 | Tamir Takımı / Caliper Adjusting Mechanism Sealing Kit | - | 1 |
| 5 | 2057 | Conta / Seal | - | 1 |
| 6 | 1203 | Civata Seti / Screw Set | - | 1 |
| 7 | 1308 | Toz Lastiği / Tappet Boot | - | 2 |



ALCAN OTOMOTIV

CALIPER SYSTEMS

KALİPER AYAR MEKANİZMASI (ALUMİNYUM) • CALIPER CALIBRATION MECHANISM (ALUMINIUM)



| | |
|--------------------|----------------------------|
| ALCAN OTOMOTIV NO. | 2046 |
| OEM NO. | - |
| MODEL | Elsa 195, Elsa 225, EX 225 |

| No. | Ref. No. | Parça Adı / Part Name | Ölçü (mm) Dimensions | Adet Pcs. |
|-----|----------|----------------------------------|----------------------|-----------|
| 1 | 1837 | Mekanizma Kapağı / Mechanism Cap | - | 1 |
| 2 | 2058 | Conta / Seal | - | 1 |
| 3 | 1405 | Burç / Bush | - | 2 |
| 4 | 1912 | Keçe / Felt | - | 2 |
| 5 | 1406 | Yüzük / Ring | - | 2 |
| 6 | 1222 | Civata Seti / Screw Set | - | 1 |

AYAR MEKANİZMASI KOMPLE • CALIBRATION MECHANISM COMPLETE



| | |
|--------------------|----------------------------|
| ALCAN OTOMOTIV NO. | 2047 |
| OEM NO. | - |
| MODEL | Elsa 195, Elsa 225, EX 225 |

| No. | Ref. No. | Parça Adı / Part Name | Ölçü (mm) Dimensions | Adet Pcs. |
|-----|----------|---|----------------------|-----------|
| 1 | 2024 | Kaliper Ayar Mekanizması / Caliper Adjuster Mechanism | - | 1 |
| 2 | 2025 | Kaliper Fren Ayar Dişlisi / Caliper Brake Lining Calibration Gear | - | 2 |
| 3 | 1837 | Mekanizma Kapağı / Mechanism Cap | - | 1 |
| 4 | 2021 | Tamir Takımı / Caliper Adjusting Mechanism Sealing Kit | - | 1 |
| 5 | 2058 | Conta / Seal | - | 1 |
| 6 | 1222 | Civata Seti / Screw Set | - | 1 |
| 7 | 1308 | Toz Lastiği / Tappet Boot | - | 2 |

KALİPER AYAR MEKANİZMASI • CALIPER ADJUSTER MECHANISM



| | |
|--------------------|------------------------------------|
| ALCAN OTOMOTIV NO. | 2024 |
| OEM NO. | - |
| MODEL | Elsa 2, Elsa 195, Elsa 225, EX 225 |

| No. | Ref. No. | Parça Adı / Part Name | Ölçü (mm) Dimensions | Adet Pcs. |
|-----|----------|---------------------------------------|----------------------|-----------|
| 1 | 2024 | Ayar Mekanizması / Adjuster Mechanism | - | 1 |

KALİPER FREN AYAR DIŞLİSİ • CALIPER BRAKE LINING CALIBRATION GEAR



| | |
|--------------------|------------------------------------|
| ALCAN OTOMOTIV NO. | 2025 |
| OEM NO. | - |
| MODEL | Elsa 2, Elsa 195, Elsa 225, EX 225 |

| No. | Ref. No. | Parça Adı / Part Name | Ölçü (mm) Dimensions | Adet Pcs. |
|-----|----------|---|----------------------|-----------|
| 1 | 1847 | Fren Ayar Dişlisi / Brake Lining Calibration Gear | - | 2 |



ALCAN OTOMOTIV

CALIPER SYSTEMS

KALİPER AYAR DİŞLİSİ • CALIPER ADJUSTING GEAR



| ALCAN OTOMOTIV NO. | 2048 | | | |
|--------------------|----------------------------|-------------------------------|----------------------|-----------|
| OEM NO. | - | | | |
| MODEL | Elsa 195, Elsa 225, EX 225 | | | |
| No. | Ref. No. | Parça Adı / Part Name | Ölçü (mm) Dimensions | Adet Pcs. |
| 1 | 1838 | Ayar Dişlisi / Adjusting Gear | - | 1 |
| 2 | 1707 | Yay / Spring | - | 1 |

KALİPER KAPAK CONTASI • CALIPER COVER PLATE GASKET



| ALCAN OTOMOTIV NO. | 2057 | | | |
|--------------------|----------|------------------------------------|----------------------|-----------|
| OEM NO. | - | | | |
| MODEL | Elsa 2 | | | |
| No. | Ref. No. | Parça Adı / Part Name | Ölçü (mm) Dimensions | Adet Pcs. |
| 1 | 2057 | Kapak Contası / Cover Plate Gasket | - | 1 |

KALİPER KAPAK CONTASI • CALIPER COVER PLATE GASKET



| ALCAN OTOMOTIV NO. | 2058 | | | |
|--------------------|----------------------------|------------------------------------|----------------------|-----------|
| OEM NO. | - | | | |
| MODEL | Elsa 195, Elsa 225, EX 225 | | | |
| No. | Ref. No. | Parça Adı / Part Name | Ölçü (mm) Dimensions | Adet Pcs. |
| 1 | 2058 | Kapak Contası / Cover Plate Gasket | - | 1 |

KALİPER DAYAMA TAMİR TAKIMI • CALIPER TAPPET HEAD REPAIR KIT



| ALCAN OTOMOTIV NO. | 2026 | | | |
|--------------------|----------------------------|---------------------------------------|----------------------|-----------|
| OEM NO. | RVI5001866398 | | | |
| MODEL | Elsa 2, Elsa 195, Elsa 225 | | | |
| No. | Ref. No. | Parça Adı / Part Name | Ölçü (mm) Dimensions | Adet Pcs. |
| 1 | 1308 | Toz Lastiği / Tappet Boot | - | 2 |
| 2 | 1822 | Kaliper İtenek / Brake Caliper Tappet | - | 2 |
| 3 | 1913 | Segman / Clips | - | 2 |

KALİPER DAYAMA TAMİR TAKIMI • CALIPER TAPPET HEAD REPAIR KIT



| ALCAN OTOMOTIV NO. | 2076 | | | |
|--------------------|----------------------------|---------------------------------------|----------------------|-----------|
| OEM NO. | MCK1309 | | | |
| MODEL | Elsa 2, Elsa 195, Elsa 225 | | | |
| No. | Ref. No. | Parça Adı / Part Name | Ölçü (mm) Dimensions | Adet Pcs. |
| 1 | 1822 | Kaliper İtenek / Brake Caliper Tappet | - | 2 |
| 2 | 1913 | Segman / Clips | - | 2 |



ALCAN OTOMOTIV

CALIPER SYSTEMS

KALİPER TOZ LASTİĞİ TAKIMI • BRAKE CALIPER TAPPET BOOT SET

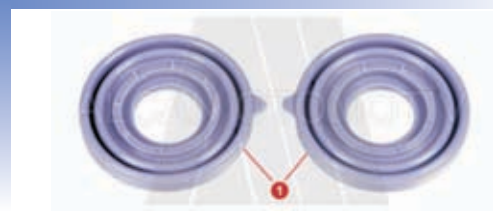

| | |
|--------------------|--------------------------------------|
| ALCAN OTOMOTIV NO. | 2002 |
| OEM NO. | MCK1139, 68324854PK10, 81.50802.6024 |
| MODEL | Elsa 2 |

| No. | Ref. No. | Parça Adı / Part Name | Ölçü (mm) Dimensions | Adet Pcs. |
|-----|----------|---------------------------|----------------------|-----------|
| 1 | 1308 | Toz Lastiği / Tappet Boot | - | 2 |

KALİPER PERNO VE BURÇ TAMİR TAKIMI • CALIPER GUIDES AND BUSHES REPAIR KIT



| | |
|--------------------|----------|
| ALCAN OTOMOTIV NO. | 2032 |
| OEM NO. | MCK1254 |
| MODEL | Elsa 195 |

| No. | Ref. No. | Parça Adı / Part Name | Ölçü (mm) Dimensions | Adet Pcs. |
|-----|----------|------------------------|----------------------|-----------|
| 1 | 1112 | Perno / Pin | Ø 31 / 78 mm | 1 |
| 2 | 1113 | Perno / Pin | Ø 35 / 117 mm | 1 |
| 3 | 1213 | Civata / Screw | M18 x 1.5 / 120 mm | 1 |
| 4 | 1208 | Civata / Screw | M18 x 1.5 / 82 mm | 1 |
| 5 | 1407 | Burç / Round Bush | Ø 35 x 39 / 30 mm | 2 |
| 6 | 1503 | Perno Kapağı / Pin Cap | Ø 44 / 22 mm | 2 |
| 7 | 1309 | Toz Körük / Pin Boot | - | 2 |
| 8 | 1401 | Perno Yüzük / Pin Ring | Ø 37 X 40 / 10 mm | 2 |
| 9 | 1412 | Burç / Round Bush | Ø 31-33 x 42 / 30 mm | 1 |

KALİPER TAMİR TAKIMI • CALIPER REPAIR KIT



| | |
|--------------------|-------------------------------|
| ALCAN OTOMOTIV NO. | 2077 |
| OEM NO. | MCK1298, 85109890, 5001866989 |
| MODEL | Elsa 225, Ex 225 |

| No. | Ref. No. | Parça Adı / Part Name | Ölçü (mm) Dimensions | Adet Pcs. |
|-----|----------|------------------------|----------------------|-----------|
| 1 | 1113 | Perno / Pin | Ø 35 / 117 mm | 1 |
| 2 | 1213 | Civata / Screw | M18 x 1.5 / 120 mm | 1 |
| 3 | 1112 | Perno / Pin | Ø 31 / 78 mm | 1 |
| 4 | 1208 | Civata / Screw | M18 x 1.5 / 82 mm | 1 |
| 5 | 1407 | Burç / Round Bush | Ø 35 x 39 / 30 mm | 2 |
| 6 | 1401 | Perno Yüzük / Pin Ring | Ø 37 X 40 / 10 mm | 2 |
| 7 | 1503 | Perno Kapağı / Pin Cap | Ø 44 / 22 mm | 2 |
| 8 | 1224 | Civata / Screw | M14 - 1.5 / 40 mm | 4 |
| 9 | 1204 | Civata / Screw | M16 - 1.5 / 40 mm | 4 |
| 10 | 1309 | Toz Körük / Pin Boot | - | 2 |
| 11 | 1412 | Burç / Round Bush | Ø 31-33 x 42 / 30 mm | 1 |



ALCAN OTOMOTIV

CALIPER SYSTEMS

KALİPER TAMİR TAKIMI • CALIPER REPAIR KIT



ALCAN OTOMOTIV NO. 2078

OEM NO. MCK1254

MODEL Elsa 195

| No. | Ref. No. | Parça Adı / Part Name | Ölçü (mm) Dimensions | Adet Pcs. |
|-----|----------|------------------------|----------------------|-----------|
| 1 | 1113 | Perno / Pin | Ø 35 / 117 mm | 1 |
| 2 | 1213 | Civata / Screw | M18 x 1.5 / 120 mm | 1 |
| 3 | 1112 | Perno / Pin | Ø 31 / 78 mm | 1 |
| 4 | 1208 | Civata / Screw | M18 x 1.5 / 82 mm | 1 |
| 5 | 1407 | Burç / Round Bush | Ø 35 x 39 / 30 mm | 2 |
| 6 | 1401 | Perno Yüzük / Pin Ring | Ø 37 X 40 / 10 mm | 2 |
| 7 | 1503 | Perno Kapağı / Pin Cap | Ø 44 / 22 mm | 2 |
| 8 | 1309 | Toz Köruk / Pin Boot | - | 2 |
| 9 | 1204 | Civata / Screw | M16 - 1.5 / 40 mm | 4 |
| 10 | 1412 | Burç / Round Bush | Ø 31-33 x 42 / 30 mm | 1 |

KALİPER TAMİR TAKIMI • CALIPER REPAIR KIT



ALCAN OTOMOTIV NO. 2079

OEM NO. MCK1253

MODEL Elsa 195, Elsa 225

| No. | Ref. No. | Parça Adı / Part Name | Ölçü (mm) Dimensions | Adet Pcs. |
|-----|----------|------------------------|----------------------|-----------|
| 1 | 1204 | Civata / Screw | M16 - 1.5 / 40 mm | 4 |
| 2 | 1309 | Toz Köruk / Pin Boot | - | 2 |
| 3 | 1503 | Perno Kapağı / Pin Cap | Ø 44 / 22 mm | 2 |

KALİPER TAMİR TAKIMI • CALIPER REPAIR KIT



ALCAN OTOMOTIV NO. 2080

OEM NO. MCK1310

MODEL Elsa 195, Elsa 225

| No. | Ref. No. | Parça Adı / Part Name | Ölçü (mm) Dimensions | Adet Pcs. |
|-----|----------|------------------------|----------------------|-----------|
| 1 | 1224 | Civata / Screw | M14 - 1.5 / 40 mm | 4 |
| 2 | 1204 | Civata / Screw | M16 - 1.5 / 40 mm | 4 |
| 3 | 1503 | Perno Kapağı / Pin Cap | Ø 44 / 22 mm | 2 |
| 2 | 1309 | Toz Köruk / Pin Boot | - | 2 |
| 3 | 1213 | Civata / Screw | M18 x 1.5 / 120 mm | 1 |



ALCAN OTOMOTIV

CALIPER SYSTEMS

KALİPER PERNO VE BURÇ TAMİR TAKIMI • CALIPER GUIDES AND BUSHES REPAIR KIT

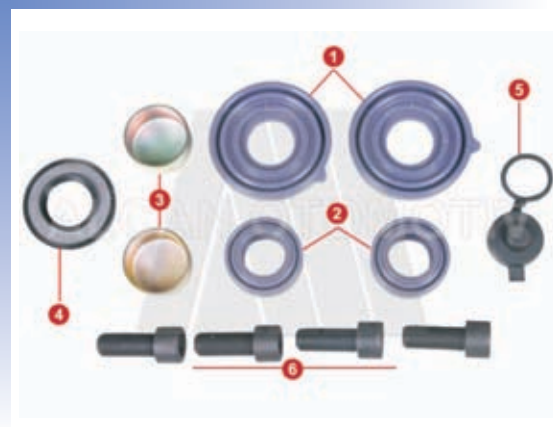

| ALCAN OTOMOTIV NO. | 2034 | | | |
|--------------------|---------------------------------|-----------------------------|----------------------|-----------|
| OEM NO. | MCK1244, 5001858718, 5001860792 | | | |
| MODEL | Elsa 2 | | | |
| No. | Ref. No. | Parça Adı / Part Name | Ölçü (mm) Dimensions | Adet Pcs. |
| 1 | 1308 | Toz Lastiği / Tappet Boot | - | 2 |
| 2 | 1309 | Toz Körük / Pin Boot | - | 2 |
| 3 | 1505 | Perno Kapağı / Pin Cap | Ø 45 / 28 mm | 2 |
| 4 | 1916 | Kaliper Keçe / Caliper Seal | - | 1 |
| 5 | 2045 | Toz Tapası / Dust Cover | - | 1 |
| 6 | 1204 | Civata / Screw | M16 - 1.5 / 40 mm | 4 |

KALİPER AYAR MEKANİZMASI TOZ LASTİĞİ • CALIPER ADJUSTER DUST BOOT



| ALCAN OTOMOTIV NO. | 2045 | | | |
|--------------------|---|----------------------------------|----------------------|-----------|
| OEM NO. | 68322655PK10 | | | |
| MODEL | B Duco, C Duco, D Duco, LE Duco, Elsa 2, Elsa 195, Elsa 225, Ex 225 | | | |
| No. | Ref. No. | Parça Adı / Part Name | Ölçü (mm) Dimensions | Adet Pcs. |
| 1 | 2045 | Toz Lastiği / Adjuster Dust Boot | - | 1 |

KALİPER TAMİR TAKIMI • CALIPER REPAIR KIT



| ALCAN OTOMOTIV NO. | 2050 | | | |
|--------------------|--------------------|------------------------|----------------------|-----------|
| OEM NO. | MCK1317, 85109889 | | | |
| MODEL | Elsa 195, Elsa 225 | | | |
| No. | Ref. No. | Parça Adı / Part Name | Ölçü (mm) Dimensions | Adet Pcs. |
| 1 | 1114 | Perno / Pin | Ø 31 / 117 mm | 1 |
| 2 | 1113 | Perno / Pin | Ø 35 / 117 mm | 1 |
| 3 | 1213 | Civata / Screw | M18 x 1.5 / 120 mm | 2 |
| 4 | 1503 | Perno Kapağı / Pin Cap | Ø 44 / 22 mm | 2 |
| 5 | 1412 | Burç / Round Bush | Ø 31-33 x 42 / 30 mm | 2 |
| 6 | 1309 | Toz Körük / Pin Boot | - | 2 |
| 7 | 1407 | Burç / Round Bush | Ø 35 x 39 / 30 mm | 2 |
| 8 | 1401 | Perno Yüzük / Pin Ring | Ø 37 X 40 / 10 mm | 2 |
| 9 | 1204 | Civata / Screw | M16 - 1.5 / 40mm | 4 |



ALCAN OTOMOTIV

CALIPER SYSTEMS

KALİPER FREN PABUCU SEVİYE GÖSTERGE ÇUBUĞU • CALIPER VISUAL PAD WEAR ASSEMBLY

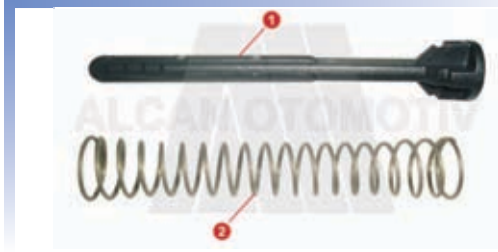

ALCAN OTOMOTIV NO. 2074

OEM NO. MCK1311

MODEL Ex 225

| No. | Ref. No. | Parça Adı / Part Name | Ölçü (mm) Dimensions | Adet Pcs. |
|-----|----------|---------------------------------|----------------------|-----------|
| 1 | 1942 | Gösterge Çubuğu / Indicator Bar | - | 1 |
| 2 | 1712 | Yay / Spring | - | 1 |

KALİPER İPAT TUTUCU TAMİR TAKIMI • CALIPER İPAT RETAINER REPAIR KIT



ALCAN OTOMOTIV NO. 2087

OEM NO. MCK1174

MODEL Elsa 2, Elsa 195, Elsa 225

| No. | Ref. No. | Parça Adı / Part Name | Ölçü (mm) Dimensions | Adet Pcs. |
|-----|----------|-----------------------------|----------------------|-----------|
| 1 | 1860 | İpat Tutucu / İpat Retainer | - | 1 |
| 2 | 1229 | Civata / Screw | M10 x 1.25 / 20 mm | 1 |

KALİPER PERNO VE BURÇ TAMİR TAKIMI • CALIPER GUIDES AND BUSHES REPAIR KIT



ALCAN OTOMOTIV NO. 2028

OEM NO. MCK1140, MCK1243, 81.50802.6025, 85107912, 5001 860 791

MODEL Elsa 2

| No. | Ref. No. | Parça Adı / Part Name | Ölçü (mm) Dimensions | Adet Pcs. |
|-----|----------|---------------------------|----------------------|-----------|
| 1 | 1105 | Perno / Pin | Ø 31 / 84 mm | 1 |
| 2 | 1106 | Perno / Pin | Ø 35 / 144 mm | 1 |
| 3 | 1230 | Civata / Screw | M18 x 1.5 / 90 mm | 1 |
| 4 | 1207 | Civata / Screw | M18 x 1.5 / 150 mm | 1 |
| 5 | 1309 | Toz Lastiği / Tappet Boot | - | 2 |
| 6 | 1503 | Perno Kapağı / Pin Cap | Ø 44 / 22 mm | 2 |
| 7 | 1407 | Burç / Round Bush | Ø 35 x 39 / 30 mm | 2 |
| 8 | 1411 | Yüzük / Pin Ring | Ø 37 x 42 / 14 mm | 2 |
| 9 | 1412 | Burç / Round Bush | Ø 31-33 x 42 / 30 mm | 1 |
| 10 | 1204 | Civata / Screw | M16 - 1.5 / 40 mm | 4 |



ALCAN OTOMOTIV

CALIPER SYSTEMS

KALİPER PERNO VE BURÇ TAMİR TAKIMI • CALIPER GUIDES AND BUSHES REPAIR KIT



| | |
|--------------------|---------------------|
| ALCAN OTOMOTIV NO. | 2030 |
| OEM NO. | MCK1086, 5001858717 |
| MODEL | Elsa 2 |

| No. | Ref. No. | Parça Adı / Part Name | Ölçü (mm) Dimensions | Adet Pcs. |
|-----|----------|---------------------------|----------------------|-----------|
| 1 | 1110 | Perno / Pin | Ø 35 / 126 mm | 1 |
| 2 | 1009 | Perno / Pin | Ø 33-35 / 66 mm | 1 |
| 3 | 1205 | Civata / Screw | M20 x 1.5 / 90 mm | 1 |
| 4 | 1206 | Civata / Screw | M20 x 1.5 / 150 mm | 1 |
| 5 | 1309 | Toz Lastiği / Tappet Boot | - | 2 |
| 6 | 1407 | Burç / Round Bush | Ø 35 x 39 / 30 mm | 1 |
| 7 | 1414 | Burç / Round Bush | Ø 35 x 41 / 30 mm | 2 |
| 8 | 1914 | Yüzük / Ring | Ø 35 x 43 / 2.5 mm | 2 |
| 9 | 1505 | Perno Kapağı / Pin Cap | Ø 45 / 28 mm | 2 |
| 10 | 1204 | Civata / Screw | M16 - 1.5 / 40 mm | 4 |
| 11 | 1207 | Civata / Screw | M10 x 1.25 / 20 mm | 1 |

KALİPER PERNO VE BURÇ TAMİR TAKIMI • CALIPER GUIDES AND BUSHES REPAIR KIT



| | |
|--------------------|--|
| ALCAN OTOMOTIV NO. | 2027 |
| OEM NO. | MCK1102, 81.50802.6017, 81.50802.6020, 81.50802.6021 |
| MODEL | Elsa 1 |

| No. | Ref. No. | Parça Adı / Part Name | Ölçü (mm) Dimensions | Adet Pcs. |
|-----|----------|------------------------------|----------------------|-----------|
| 1 | 1104 | Perno / Pin | Ø 35 / 73 mm | 1 |
| 2 | 1103 | Perno / Pin | Ø 35 / 135 mm | 1 |
| 3 | 1205 | Civata / Screw | M20 x 1.5 / 90 mm | 1 |
| 4 | 1206 | Civata / Screw | M20 x 1.5 / 150 mm | 1 |
| 5 | 1309 | Toz Lastiği / Tappet Boot | - | 2 |
| 6 | 1502 | Perno Kapağı / Pin Cap | Ø 45 / 28 mm | 2 |
| 7 | 1409 | Yüzük / Ring | Ø 37 x 39 / 15 mm | 2 |
| 8 | 1410 | Yüzük / Ring | Ø 37 x 40 / 15 mm | 2 |
| 9 | 1407 | Burç / Round Bush | Ø 35 x 39 / 30 mm | 2 |
| 10 | 1408 | Bronze Oval Burç / Oval Bush | Ø 35-37 x 40 / 33 mm | 1 |
| 11 | 1204 | Civata / Screw | M16 - 1.5 / 40mm | 4 |

TOZ KÖRÜĞÜ • PIN BOOT



| | |
|--------------------|---|
| ALCAN OTOMOTIV NO. | 2082 |
| OEM NO. | - |
| MODEL | B Duco, C Duco, D Duco, LE Duco, Elsa 1, Elsa 2, Elsa 195, Elsa 225, Ex 225 |

| No. | Ref. No. | Parça Adı / Part Name | Ölçü (mm) Dimensions | Adet Pcs. |
|-----|----------|-----------------------|----------------------|-----------|
| 1 | 1309 | Toz Köruk / Pin Boot | - | 2 |



ALCAN OTOMOTIV

CALIPER SYSTEMS

AYAR DIŞLİSİ TAKIMI (SAĞ) • ADJUSTING GEAR KIT (RIGHT)



ALCAN OTOMOTIV NO. 2042

OEM NO. -

MODEL Elsa 1

| No. | Ref. No. | Parça Adı / Part Name | Ölçü (mm) Dimensions | Adet Pcs. |
|-----|----------|---|----------------------|-----------|
| 1 | 1832 | Ayar Dişlisi (Sağ) / Tappet Gear Assembly (Right) | 35 mm | 2 |
| 2 | 1830 | Demir Tapa / Steel Cap | - | 2 |
| 3 | 1831 | Aktarma Dişli Saçı / Intermediate Gear | - | 1 |

AYAR DIŞLİSİ TAKIMI (SOL) • ADJUSTING GEAR KIT (LEFT)



ALCAN OTOMOTIV NO. 2041

OEM NO. -

MODEL Elsa 1

| No. | Ref. No. | Parça Adı / Part Name | Ölçü (mm) Dimensions | Adet Pcs. |
|-----|----------|--|----------------------|-----------|
| 1 | 1829 | Ayar Dişlisi (Sol) / Tappet Gear Assembly (Left) | 35 mm | 2 |
| 2 | 1830 | Demir Tapa / Steel Cap | - | 2 |
| 3 | 1831 | Aktarma Dişli Saçı / Intermediate Gear | - | 1 |

KALİPER AYAR MEKANİZMA YATAĞI (SOL) • ADJUSTING MECHANISM CLUTCH SYSTEM (LEFT)



ALCAN OTOMOTIV NO. 2083

OEM NO. -

MODEL Elsa 1

| No. | Ref. No. | Parça Adı / Part Name | Ölçü (mm) Dimensions | Adet Pcs. |
|-----|----------|-------------------------------------|----------------------|-----------|
| 1 | 1857 | Mekanizma Yatağı / Mechanism Clutch | Sol / Left | 1 |

KALİPER AYAR MEKANİZMA (SOL) • ADJUSTING MECHANISM CLUTCH SYSTEM (LEFT)



ALCAN OTOMOTIV NO. 2084

OEM NO. -

MODEL Elsa 1

| No. | Ref. No. | Parça Adı / Part Name | Ölçü (mm) Dimensions | Adet Pcs. |
|-----|----------|--|----------------------|-----------|
| 1 | 1857 | Mekanizma Yatağı / Mechanism Clutch | Sol / Left | 1 |
| 2 | 1858 | Kaliper Ayar Mekanizma Dişlisi / Brake Caliper Adjusting Mechanism | - | 1 |
| 3 | 1714 | Yay / Spring | - | 1 |



ALCAN OTOMOTIV

CALIPER SYSTEMS

KALİPER AYAR MEKANİZMA YATAĞI (SAĞ) • ADJUSTING MECHANISM CLUTCH SYSTEM (RIGHT)



| | |
|--------------------|--------|
| ALCAN OTOMOTIV NO. | 2085 |
| OEM NO. | - |
| MODEL | Elsa 1 |

| No. | Ref. No. | Parça Adı / Part Name | Ölçü (mm) Dimensions | Adet Pcs. |
|-----|----------|-------------------------------------|----------------------|-----------|
| 1 | 1859 | Mekanizma Yatağı / Mechanism Clutch | Sağ / Right | 1 |

KALİPER AYAR MEKANİZMA (SAĞ) • ADJUSTING MECHANISM CLUTCH SYSTEM (RIGHT)



| | |
|--------------------|--------|
| ALCAN OTOMOTIV NO. | 2086 |
| OEM NO. | - |
| MODEL | Elsa 1 |

| No. | Ref. No. | Parça Adı / Part Name | Ölçü (mm) Dimensions | Adet Pcs. |
|-----|----------|--|----------------------|-----------|
| 1 | 1859 | Mekanizma Yatağı / Mechanism Clutch | Sağ / Right | 1 |
| 2 | 1858 | Kaliper Ayar Mekanizma Dişlisi / Brake Caliper Adjusting Mechanism | - | 1 |
| 3 | 1714 | Yay / Spring | - | 1 |

KALİPER TOZ LASTİK TAKIMI • BRAKE CALIPER TAPPET BOOT SET

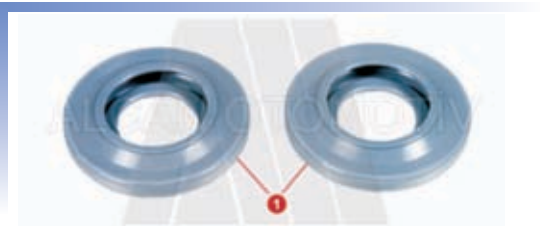

| | |
|--------------------|-----------------------|
| ALCAN OTOMOTIV NO. | 2001 |
| OEM NO. | ST1156, 81.50802.6016 |
| MODEL | Elsa 1 |

| No. | Ref. No. | Parça Adı / Part Name | Ölçü (mm) Dimensions | Adet Pcs. |
|-----|----------|---------------------------|----------------------|-----------|
| 1 | 1307 | Toz Lastiği / Tappet Boot | - | 1 |

KALİPER KİLİTLEME SACI • BRAKE CALIPER LOCKING SHIM



| | |
|--------------------|--------------|
| ALCAN OTOMOTIV NO. | 2095 |
| OEM NO. | 68321678PK10 |
| MODEL | Elsa 1 |

| No. | Ref. No. | Parça Adı / Part Name | Ölçü (mm) Dimensions | Adet Pcs. |
|-----|----------|-------------------------------|----------------------|-----------|
| 1 | 2095 | Kilitleme Sacı / Locking Shim | - | 1 |



ALCAN OTOMOTIV

CALIPER SYSTEMS

KALİPER PERNO VE BURÇ TAMİR TAKIMI • CALIPER GUIDES AND BUSHES REPAIR KIT



| ALCAN OTOMOTIV NO. | 2051 | | | |
|--------------------|----------|---------------------------|----------------------|-----------|
| OEM NO. | MCK1103 | | | |
| MODEL | Elsa 1 | | | |
| No. | Ref. No. | Parça Adı / Part Name | Ölçü (mm) Dimensions | Adet Pcs. |
| 1 | 1103 | Perno / Pin | Ø 35 / 135 mm | 1 |
| 2 | 1115 | Perno / Pin | Ø 28.5 / 110 mm | 1 |
| 3 | 1206 | Civata / Screw | M20 x 1.5 / 150 mm | 1 |
| 4 | 1309 | Toz Köruk / Pin Boot | - | 2 |
| 5 | 1502 | Perno Kapağı / Pin Cap | Ø 45 / 28 mm | 2 |
| 6 | 1419 | Yüzük / Ring | Ø 30 x 40 / 19 mm | 1 |
| 7 | 1409 | Yüzük / Ring | Ø 37 x 39 / 15 mm | 1 |
| 8 | 1204 | Civata / Screw | M16 - 1.5 / 40 mm | 4 |
| 9 | 1314 | Kauçuk Burç / Rubber Bush | Ø 28.5 x 40 / 27 mm | 1 |
| 10 | 1407 | Burç / Round Bush | Ø 35 x 39 / 30 mm | 2 |

BURÇ TAKIMI • ROUND BUSH

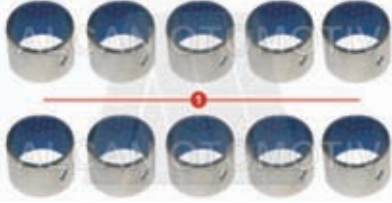

| ALCAN OTOMOTIV NO. | 2059 | | | |
|--------------------|--|-----------------------|----------------------|-----------|
| OEM NO. | - | | | |
| MODEL | Elsa 1, Elsa 2, D Lisa, Elsa 195, Elsa 225 | | | |
| No. | Ref. No. | Parça Adı / Part Name | Ölçü (mm) Dimensions | Adet Pcs. |
| 1 | 1407 | Burç / Round Bush | Ø 35 x 39 / 30 mm | 10 |

KALİPER RULMAN TAKIMI (ARKA) • CALIPER ROLLER BEARING KIT (REAR)



| ALCAN OTOMOTIV NO. | 2011 | | | |
|--------------------|-----------------|-----------------------------------|----------------------|-----------|
| OEM NO. | SJ4112, 3092329 | | | |
| MODEL | Elsa 1, Elsa 2 | | | |
| No. | Ref. No. | Parça Adı / Part Name | Ölçü (mm) Dimensions | Adet Pcs. |
| 1 | 1812 | Bilya Yatağı / Bearing berth | - | 2 |
| 2 | 1601 | Masurali Bilya / Half Bearing | - | 2 |
| 3 | 1814 | Tane Bilya / Roller Bearing | - | 2 |
| 4 | 1813 | Bilya Yatak Burcu / Lever Bearing | - | 2 |

KALİPER RULMAN TAKIMI (ÖN) • CALIPER ROLLER BEARING KIT (FRONT)



| ALCAN OTOMOTIV NO. | 2012 | | | |
|--------------------|----------------|-----------------------------------|----------------------|-----------|
| OEM NO. | 3092261 | | | |
| MODEL | Elsa 1, Elsa 2 | | | |
| No. | Ref. No. | Parça Adı / Part Name | Ölçü (mm) Dimensions | Adet Pcs. |
| 1 | 1812 | Bilya Yatağı / Bearing berth | - | 2 |
| 2 | 1601 | Masurali Bilya / Half Bearing | - | 2 |
| 3 | 1814 | Tane Bilya / Roller Bearing | - | 2 |
| 4 | 1815 | Bilya Yatak Burcu / Lever Bearing | - | 2 |



ALCAN OTOMOTIV

CALIPER SYSTEMS

KALİPER RULMAN YATAĞI • CALIPER BEARING CAPS



| | |
|--------------------|------------------------------------|
| ALCAN OTOMOTIV NO. | 2073 |
| OEM NO. | - |
| MODEL | Elsa 2, Elsa 195, Elsa 225, EX 225 |

| No. | Ref. No. | Parça Adı / Part Name | Ölçü (mm) Dimensions | Adet Pcs. |
|-----|----------|------------------------------|----------------------|-----------|
| 1 | 1856 | Rulman Yatağı / Bearing Caps | - | 2 |

KALİPER TOZ KEÇESİ • ACTUATOR SEAL



| | |
|--------------------|----------------------------|
| ALCAN OTOMOTIV NO. | 2093 |
| OEM NO. | 68323746PK10 |
| MODEL | Elsa 2, Elsa 195, Elsa 225 |

| No. | Ref. No. | Parça Adı / Part Name | Ölçü (mm) Dimensions | Adet Pcs. |
|-----|----------|-----------------------------|----------------------|-----------|
| 1 | 2093 | Kaliper Keçe / Caliper Seal | - | 1 |

KALİPER KRANK ŞAFTI • CALIPER ECCENTRIC SHAFT



| | |
|--------------------|--------|
| ALCAN OTOMOTIV NO. | 2043 |
| OEM NO. | - |
| MODEL | Dx 195 |

| No. | Ref. No. | Parça Adı / Part Name | Ölçü (mm) Dimensions | Adet Pcs. |
|-----|----------|------------------------------|----------------------|-----------|
| 1 | 1833 | Krank Şaft / Eccentric Shaft | - | 1 |
| 1 | 1921 | Şaft Contası / Shaft Seal | - | 1 |

KALİPER MASURALI BİLYA • CALIPER ROLLER BEARING



| | |
|--------------------|--------|
| ALCAN OTOMOTIV NO. | 2067 |
| OEM NO. | - |
| MODEL | Dx 195 |

| No. | Ref. No. | Parça Adı / Part Name | Ölçü (mm) Dimensions | Adet Pcs. |
|-----|----------|-------------------------|----------------------|-----------|
| 1 | 1609 | Masura Rulman / Bearing | - | 1 |

KALİPER MASURALI BİLYA • CALIPER ROLLER BEARING



| | |
|--------------------|--------|
| ALCAN OTOMOTIV NO. | 2068 |
| OEM NO. | - |
| MODEL | Dx 195 |

| No. | Ref. No. | Parça Adı / Part Name | Ölçü (mm) Dimensions | Adet Pcs. |
|-----|----------|-------------------------|----------------------|-----------|
| 1 | 1610 | Masura Rulman / Bearing | - | 1 |



ALCAN OTOMOTIV

CALIPER SYSTEMS

KALİPER MASURALI BİLYA (TAKIM) • CALIPER ROLLER BEARING (SET)



ALCAN OTOMOTIV NO. 2069

OEM NO. -

MODEL

Dx 195

| No. | Ref. No. | Parça Adı / Part Name | Ölçü (mm) Dimensions | Adet Pcs. |
|-----|----------|-------------------------|----------------------|-----------|
| 1 | 1610 | Masura Rulman / Bearing | - | 1 |
| 2 | 1609 | Masura Rulman / Bearing | - | 2 |

ŞAFT AYAR KOLU • SHAFT SETTING LEVER



ALCAN OTOMOTIV NO. 2070

OEM NO. -

MODEL

Dx 195

| No. | Ref. No. | Parça Adı / Part Name | Ölçü (mm) Dimensions | Adet Pcs. |
|-----|----------|---------------------------|----------------------|-----------|
| 1 | 1853 | Ayar Kolu / Setting lever | - | 1 |

KALİPER ŞAFT YATAĞI • CALIPER SHAFT BEARING



ALCAN OTOMOTIV NO. 2072

OEM NO. -

MODEL

Dx 195

| No. | Ref. No. | Parça Adı / Part Name | Ölçü (mm) Dimensions | Adet Pcs. |
|-----|----------|-----------------------------|----------------------|-----------|
| 1 | 1609 | Masura Rulman / Bearing | - | 1 |
| 2 | 1855 | Şaft yatağı / Shaft bearing | - | 1 |

KALİPER ŞAFT TAMİR TAKIMI • CALIPER SHAFT FITTINGS REPAIR KIT



ALCAN OTOMOTIV NO. 2081

OEM NO. MCK1294

MODEL

Dx 195

| No. | Ref. No. | Parça Adı / Part Name | Ölçü (mm) Dimensions | Adet Pcs. |
|-----|----------|--|----------------------|-----------|
| 1 | 1833 | Krank Şaft / Eccentric Shaft | - | 1 |
| 2 | 1921 | Şaft Contası / Shaft Seal | - | 1 |
| 3 | 1937 | Şaft Contası / Shaft Seal | - | 1 |
| 4 | 1938 | Şaft Contası / Shaft Seal | - | 1 |
| 5 | 1228 | Civata / Screw | M8 - 1,25 / 20mm | 2 |
| 6 | 1915 | Mekanizma Kapak Contası / Cover Plate Gasket | - | 1 |
| 7 | 1609 | Masura Rulman / Bearing | - | 1 |
| 8 | 1855 | Şaft yatağı / Shaft bearing | - | 1 |
| 9 | 1610 | Masura Rulman / Bearing | - | 1 |
| 10 | 1211 | Civatalı Tapa / Plug Bolt | - | 1 |
| 11 | 1931 | Conta / Seal | - | 1 |



ALCAN OTOMOTIV

CALIPER SYSTEMS

KALİPER BALATA TUTUCU • CALIPER PAD RETAINER



ALCAN OTOMOTIV NO. **2071**

OEM NO. -

MODEL Dx 195

| No. | Ref. No. | Parça Adı / Part Name | Ölçü (mm) Dimensions | Adet Pcs. |
|-----|----------|------------------------------|----------------------|-----------|
| 1 | 1854 | Balata Tutucu / Pad Retainer | - | 1 |

KALİPER PERNO VE BURÇ TAKIMI • CALIPER GUIDES AND BUSHES REPAIR KIT



ALCAN OTOMOTIV NO. **2031**

OEM NO. MCK1171

MODEL Dx 195, Elsa 195

| No. | Ref. No. | Parça Adı / Part Name | Ölçü (mm) Dimensions | Adet Pcs. |
|-----|----------|--|----------------------|-----------|
| 1 | 1111 | Perno / Pin | Ø 32 / 97 mm | 2 |
| 2 | 1209 | Civata / Screw | M16 x 1.5 / 55 mm | 1 |
| 3 | 1210 | Civata / Screw | M16 x 1.5 / 80 mm | 1 |
| 4 | 1416 | Burç / Round Bush | Ø 32 x 36 / 55 mm | 2 |
| 5 | 1506 | Perno Kapağı / Pin Cap | Ø 42 / 28 mm | 2 |
| 6 | 1311 | Toz Lastiği / Tappet Boot | - | 2 |
| 7 | 1312 | Toz Lastiği / Tappet Boot | - | 2 |
| 8 | 1310 | Toz Lastiği / Tappet Boot | - | 2 |
| 9 | 1212 | Civata Seti / Screw Set | - | 1 |
| 10 | 1211 | Civatalı Tapa / Screw Set | - | 1 |
| 11 | 1915 | Mekanizma Kapak Contası / Cover Plate Gasket | - | 1 |
| 12 | 1931 | Tapa Pulu / Washer | - | 1 |

KALİPER TAMİR TAKIMI • CALIPER REPAIR KIT



ALCAN OTOMOTIV NO. **2036**

OEM NO. MCK1192

MODEL Dx 195

| No. | Ref. No. | Parça Adı / Part Name | Ölçü (mm) Dimensions | Adet Pcs. |
|-----|----------|---------------------------|----------------------|-----------|
| 1 | 1310 | Toz Lastiği / Tappet Boot | - | 2 |
| 2 | 1311 | Toz Lastiği / Tappet Boot | - | 2 |
| 3 | 1312 | Toz Lastiği / Tappet Boot | - | 2 |
| 4 | 1506 | Perno Kapağı / Pin Cap | Ø 42 / 28 mm | 2 |
| 5 | 1212 | Civata Seti / Screw Set | - | 2 |



ALCAN OTOMOTIV

CALIPER SYSTEMS

KALİPER PİSTON & PİNYON TAMİR TAKIMI (SOL) • CALIPER PISTONS & PINIONS REPAIR KIT (LEFT)



ALCAN OTOMOTIV NO. 2088

OEM NO. -

MODEL

Dx 195

| No. | Ref. No. | Parça Adı / Part Name | Ölçü (mm) Dimensions | Adet Pcs. |
|-----|----------|-----------------------|----------------------|-----------|
| 1 | 1129 | Pinyon / Pinion | Sol / Left | 2 |
| 2 | 1225 | Civata / Screw | Sol / Left | 2 |
| 3 | 1939 | Pul / Washer | - | 2 |
| 4 | 1940 | Kelepçe / Clamp | - | 2 |

KALİPER PİSTON & PİNYON TAMİR TAKIMI (SAĞ) • CALIPER PISTONS & PINIONS REPAIR KIT (RIGHT)



ALCAN OTOMOTIV NO. 2089

OEM NO. -

MODEL

Dx 195

| No. | Ref. No. | Parça Adı / Part Name | Ölçü (mm) Dimensions | Adet Pcs. |
|-----|----------|-----------------------|----------------------|-----------|
| 1 | 1130 | Pinyon / Pinion | Sa / Right | 2 |
| 2 | 1226 | Civata / Screw | Sa / Right | 2 |
| 3 | 1939 | Pul / Washer | - | 2 |
| 4 | 1940 | Kelepçe / Clamp | - | 2 |

KALİPER AYAR MEKANİZMASI TAMİR TAKIMI (SOL) / YARIM TAKIM • CALIPER ADJUSTING TAPPET REPAIR KIT (LEFT) / HALF KIT



ALCAN OTOMOTIV NO. 2090

OEM NO. DSL5L

MODEL

Dx 195

| No. | Ref. No. | Parça Adı / Part Name | Ölçü (mm) Dimensions | Adet Pcs. |
|-----|----------|--|----------------------|-----------|
| 1 | 1861 | Ayar Mekanizması / Adjusting Mechanism | Sol / Left | 1 |
| 2 | 1862 | Ayar Civatası / Calibration Bolt | - | 1 |
| 3 | 1940 | Kelepçe / Clamp | - | 2 |
| 4 | 1939 | Pul / Washer | - | 2 |
| 5 | 1715 | Yay / Spring | - | 1 |
| 6 | 1941 | Yüzük / Ring | - | 2 |



ALCAN OTOMOTIV

CALIPER SYSTEMS

KALİPER AYAR MEKANİZMASI TAMİR TAKIMI (SAĞ) / YARIM TAKIM • CALIPER ADJUSTING TAPPET REPAIR KIT (RIGHT) / HALF KIT



ALCAN OTOMOTIV NO. 2091

OEM NO. DSL5R

MODEL Dx 195

| No. | Ref. No. | Parça Adı / Part Name | Ölçü (mm) Dimensions | Adet Pcs. |
|-----|----------|--|----------------------|-----------|
| 1 | 1863 | Ayar Mekanizması / Adjusting Mechanism | Sa / Right | 1 |
| 2 | 1862 | Ayar Civatası / Calibration Bolt | - | 1 |
| 3 | 1940 | Kelepçe / Clamp | - | 2 |
| 4 | 1939 | Pul / Washer | - | 2 |
| 5 | 1715 | Yay / Spring | - | 1 |
| 6 | 1941 | Yüzük / Ring | - | 2 |

KALİPER TAMİR TAKIMI • CALIPER REPAIR KIT



ALCAN OTOMOTIV NO. 2092

OEM NO. MCK1193

MODEL Dx 195

| No. | Ref. No. | Parça Adı / Part Name | Ölçü (mm) Dimensions | Adet Pcs. |
|-----|----------|---------------------------|----------------------|-----------|
| 1 | 1210 | Civata / Screw | M16 x 1.5 / 80 mm | 1 |
| 2 | 1209 | Civata / Screw | M16 x 1.5 / 55 mm | 1 |
| 3 | 1506 | Perno Kapağı / Pin Cap | Ø 42 / 28 mm | 2 |
| 4 | 1310 | Toz Lastiği / Tappet Boot | - | 2 |
| 5 | 1312 | Toz Lastiği / Tappet Boot | - | 2 |
| 6 | 1311 | Toz Lastiği / Tappet Boot | - | 2 |

MERKEZLEME ÇATALI VE DİŞLİSİ • CENTRAL FORK & PIGNON



ALCAN OTOMOTIV NO. 2094

OEM NO. -

MODEL Dx 195

| No. | Ref. No. | Parça Adı / Part Name | Ölçü (mm) Dimensions | Adet Pcs. |
|-----|----------|-----------------------|----------------------|-----------|
| 1 | 1865 | Çatal / Fork | - | 1 |
| 2 | 1866 | Dişli / Gear | - | 1 |

ALCAN OTOMOTIV

CALIPER SYSTEMS



KNORR
SERIES



ALCAN OTOMOTIV

CALIPER SYSTEMS

KALİPER TAMİR TAKIMI • CALIPER REPAIR KIT



| | |
|--------------------|--|
| ALCAN OTOMOTIV NO. | 3001 |
| OEM NO. | 11328090062, 11339680062, 11369100062, 0004201282, 81.50822.6009 |
| MODEL | SB5..., SB6..., SB7... |

| No. | Ref. No. | Parça Adı / Part Name | Ölçü (mm) Dimensions | Adet Pcs. |
|-----|----------|---|----------------------|-----------|
| 1 | 1116 | Perno / Pin | Ø 36 / 145 mm | 1 |
| 2 | 1214 | Civata / Screw | M16 x 1.5 / 150 mm | 1 |
| 3 | 1117 | Perno / Pin | Ø 34 / 80 mm | 1 |
| 4 | 1215 | Civata / Screw | M16 x 1.5 / 87 mm | 1 |
| 5 | 1421 | Burç / Round Bush | Ø 36 x 40 / 82 mm | 1 |
| 6 | 1922 | Körüklü Kapak Keleçesi / Bellow Cap Clamp | - | 1 |
| 7 | 1317 | Toz Lastığı / Tappet Boot | - | 1 |
| 8 | 1316 | Kauçuk Burç / Rubber Bush | Ø 34 x 40 / 50 mm | 1 |
| 9 | 1315 | Körüklü Kapak / Bellow Cap | - | 1 |
| 10 | 1422 | Perno Yüzüğü / Pin Boot Ring | - | 1 |

KALİPER TAMİR TAKIMI • CALIPER REPAIR KIT



| | |
|--------------------|-----------------------|
| ALCAN OTOMOTIV NO. | 3002 |
| OEM NO. | K000132, 000 420 2182 |
| MODEL | SB6..., SB7... |

| No. | Ref. No. | Parça Adı / Part Name | Ölçü (mm) Dimensions | Adet Pcs. |
|-----|----------|---|----------------------|-----------|
| 1 | 1118 | Perno / Pin | Ø 36 / 135 mm | 1 |
| 2 | 1216 | Civata / Screw | M16 x 1.5 / 140 mm | 1 |
| 3 | 1117 | Perno / Pin | Ø 34 / 80 mm | 1 |
| 4 | 1215 | Civata / Screw | M16 x 1.5 / 87 mm | 1 |
| 5 | 1421 | Burç / Round Bush | Ø 36 x 40 / 82 mm | 1 |
| 6 | 1922 | Körüklü Kapak Keleçesi / Bellow Cap Clamp | - | 1 |
| 7 | 1317 | Toz Lastığı / Tappet Boot | - | 1 |
| 8 | 1316 | Kauçuk Burç / Rubber Bush | Ø 34 x 40 / 50 mm | 1 |
| 9 | 1315 | Körüklü Kapak / Bellow Cap | - | 1 |
| 10 | 1422 | Perno Yüzüğü / Pin Boot Ring | - | 1 |



ALCAN OTOMOTIV

CALIPER SYSTEMS

KALİPER TAMİR TAKIMI • CALIPER REPAIR KIT



| | |
|--------------------|------------------------|
| ALCAN OTOMOTIV NO. | 3003 |
| OEM NO. | K000472, 81.50822.6019 |
| MODEL | SN6..., SN7... |

| No. | Ref. No. | Parça Adı / Part Name | Ölçü (mm) Dimensions | Adet Pcs. |
|-----|----------|---------------------------------|----------------------|-----------|
| 1 | 1119 | Perno / Pin | Ø 36 / 114 mm | 1 |
| 2 | 1215 | Civata / Screw | M16 x 1.5 / 87 mm | 1 |
| 3 | 1120 | Perno / Pin | Ø 32 / 80 mm | 1 |
| 4 | 1217 | Civata / Screw | M16 x 1.5 / 80 mm | 1 |
| 5 | 1421 | Burç / Bush | Ø 36 x 40 / 82 mm | 1 |
| 6 | 1509 | Perno Kapağı / Pin Cap | Ø 40 / 11 mm | 1 |
| 7 | 1317 | Toz Lastiği / Pin Boot | - | 1 |
| 8 | 1923 | Lastikli Burç / Pin Rubber Bush | Ø 39 mm | 1 |
| 9 | 1422 | Perno Yüzüğü / Pin Boot Ring | - | 1 |
| 10 | 1508 | Yüzük / Ring | - | 1 |

KALİPER TAMİR TAKIMI • CALIPER REPAIR KIT



| | |
|--------------------|------------------------------|
| ALCAN OTOMOTIV NO. | 3004 |
| OEM NO. | K004100, K010766, 0004205082 |
| MODEL | SN7..., SK7... |

| No. | Ref. No. | Parça Adı / Part Name | Ölçü (mm) Dimensions | Adet Pcs. |
|-----|----------|------------------------------|----------------------|-----------|
| 1 | 1119 | Perno / Pin | Ø 36 / 114 mm | 1 |
| 2 | 1215 | Civata / Screw | M16 x 1.5 / 87 mm | 1 |
| 3 | 1121 | Perno / Pin | Ø 36 / 64 mm | 1 |
| 4 | 1218 | Civata / Screw | M16 x 1.5 / 70 mm | 1 |
| 5 | 1421 | Burç / Bush | Ø 36 x 40 / 82 mm | 1 |
| 6 | 1422 | Perno Yüzüğü / Pin Boot Ring | - | 2 |
| 7 | 1509 | Perno Kapağı / Pin Cap | Ø 40 / 11 mm | 1 |
| 8 | 1317 | Toz Lastiği / Pin Boot | - | 2 |
| 9 | 1517 | Perno Kapağı / Pin Cap | Ø 40 / 24.5 mm | 1 |
| 10 | 1423 | Perno Burcu / Pin Bush | Ø 36 x 40 / 20 mm | 1 |



ALCAN OTOMOTIV

CALIPER SYSTEMS

KALİPER TAMİR TAKIMI • CALIPER REPAIR KIT



ALCAN OTOMOTIV NO. **3055**

OEM NO. -

MODEL SN7..., SK7...

| No. | Ref. No. | Parça Adı / Part Name | Ölçü (mm) Dimensions | Adet Pcs. |
|-----|----------|------------------------------|----------------------|-----------|
| 1 | 1218 | Civata / Screw | M16 x 1.5 / 70 mm | 1 |
| 2 | 1121 | Perno / Pin | Ø 36 / 64 mm | 1 |
| 3 | 1517 | Perno Kapağı / Pin Cap | Ø 40 / 24.5 mm | 1 |
| 4 | 1422 | Perno Yüzüğü / Pin Boot Ring | - | 1 |
| 5 | 1423 | Perno Burcu / Pin Bush | Ø 36 x 40 / 20 mm | 1 |
| 6 | 1317 | Toz Lastiği / Pin Boot | - | 1 |

KALİPER TAMİR TAKIMI • CALIPER REPAIR KIT



ALCAN OTOMOTIV NO. **3005**

OEM NO. K000375, 0004202982, 81.50822.6023

MODEL SB6..., SB7...

| No. | Ref. No. | Parça Adı / Part Name | Ölçü (mm) Dimensions | Adet Pcs. |
|-----|----------|---------------------------------|----------------------|-----------|
| 1 | 1119 | Perno / Pin | Ø 36 / 114 mm | 1 |
| 2 | 1125 | Civata / Screw | M16 x 1.5 / 87 mm | 1 |
| 3 | 1120 | Perno / Pin | Ø 32 / 80 mm | 1 |
| 4 | 1217 | Civata / Screw | M16 x 1.5 / 80 mm | 1 |
| 5 | 1421 | Burç / Bush | Ø 36 x 40 / 82 mm | 1 |
| 6 | 1510 | Saç Kapak / Steel Cap | - | 1 |
| 7 | 1317 | Toz Lastiği / Pin Boot | - | 1 |
| 8 | 1923 | Lastikli Burç / Pin Rubber Bush | Ø 39 mm | 1 |
| 9 | 1508 | Yüzük / Ring | - | 1 |
| 10 | 1924 | Kapak O-ringi / | - | 1 |
| 11 | 1422 | Perno Yüzüğü / Pin Boot Ring | - | 1 |



ALCAN OTOMOTIV

CALIPER SYSTEMS

KALİPER TAMİR TAKIMI • CALIPER REPAIR KIT



| | |
|--------------------|----------------------------|
| ALCAN OTOMOTIV NO. | 3006 |
| OEM NO. | - |
| MODEL | SB... series, SN... series |

| No. | Ref. No. | Parça Adı / Part Name | Ölçü (mm) Dimensions | Adet Pcs. |
|-----|----------|---------------------------------|----------------------|-----------|
| 1 | 1119 | Perno / Pin | Ø 36 / 114 mm | 1 |
| 2 | 1217 | Civata / Screw | M16 x 1.5 / 80 mm | 1 |
| 3 | 1117 | Perno / Pin | Ø 34 / 80 mm | 1 |
| 4 | 1215 | Civata / Screw | M16 x 1.5 / 87 mm | 1 |
| 5 | 1120 | Perno / Pin | Ø 32 / 80 mm | 1 |
| 6 | 1215 | Civata / Screw | M16 x 1.5 / 87 mm | 1 |
| 7 | 1421 | Burç / Bush | Ø 36 x 40 / 82 mm | 1 |
| 8 | 1509 | Perno Kapağı / Pin Cap | Ø 40 / 11 mm | 1 |
| 9 | 1317 | Toz Lastiği / Pin Boot | - | 1 |
| 10 | 1510 | Saç Kapak / Steel Cap | - | 1 |
| 11 | 1924 | Kapak O-ringi / Cap O-Ring | - | 1 |
| 12 | 1422 | Perno Yüzüğü / Pin Boot Ring | - | 1 |
| 13 | 1316 | Kauçuk Burç / Rubber Bush | Ø 34 x 40 / 50 mm | 1 |
| 14 | 1923 | Lastikli Burç / Pin Rubber Bush | Ø 39 mm | 1 |

KALİPER TAMİR TAKIMI • CALIPER REPAIR KIT



| | |
|--------------------|------------------|
| ALCAN OTOMOTIV NO. | 3007 |
| OEM NO. | K000687, 1603326 |
| MODEL | SB7... |

| No. | Ref. No. | Parça Adı / Part Name | Ölçü (mm) Dimensions | Adet Pcs. |
|-----|----------|--|----------------------|-----------|
| 1 | 1116 | Perno / Pin | Ø 36 / 145 mm | 1 |
| 2 | 1214 | Civata / Screw | M16 x 1.5 / 150 mm | 1 |
| 3 | 1120 | Perno / Pin | Ø 32 / 80 mm | 1 |
| 4 | 1217 | Civata / Screw | M16 x 1.5 / 80 mm | 1 |
| 5 | 1421 | Burç / Bush | Ø 36 x 40 / 82 mm | 1 |
| 6 | 1422 | Perno Yüzüğü / Pin Boot Ring | - | 1 |
| 7 | 1315 | Körüklü Kapak / Bellow Cap | - | 1 |
| 8 | 1925 | Lastikli Burç / Pin Rubber Bush | Ø 39 mm | 1 |
| 9 | 1317 | Toz Lastiği / Pin Boot | - | 1 |
| 10 | 1922 | Körüklü Kapak Kelepçesi / Bellow Cap Clamp | - | 1 |



ALCAN OTOMOTIV

CALIPER SYSTEMS

KALİPER TAMİR TAKIMI • CALIPER REPAIR KIT



| | |
|--------------------|-------------------------|
| ALCAN OTOMOTIV NO. | 3008 |
| OEM NO. | K001532, 09.801.06.31.0 |
| MODEL | SB6..., SB7... |

| No. | Ref. No. | Parça Adı / Part Name | Ölçü (mm) Dimensions | Adet Pcs. |
|-----|----------|---------------------------------|----------------------|-----------|
| 1 | 1119 | Perno / Pin | Ø 36 / 114 mm | 1 |
| 2 | 1215 | Civata / Screw | M16 x 1.5 / 87 mm | 1 |
| 3 | 1120 | Perno / Pin | Ø 32 / 80 mm | 1 |
| 4 | 1217 | Civata / Screw | M16 x 1.5 / 80 mm | 1 |
| 5 | 1421 | Burç / Bush | Ø 36 x 40 / 82 mm | 1 |
| 6 | 1509 | Perno Kapağı / Pin Cap | Ø 40 / 11 mm | 1 |
| 7 | 1422 | Perno Yüzüğü / Pin Boot Ring | - | 1 |
| 8 | 1508 | Yüzük / Ring | - | 1 |
| 9 | 1926 | Lastikli Burç / Pin Rubber Bush | Ø 35 mm | 1 |
| 10 | 1510 | Saç Kapak / Steel Cap | - | 1 |
| 11 | 1924 | Kapak O-ringi / Cap O-Ring | - | 1 |
| 12 | 1317 | Toz Lastiği / Pin Boot | - | 1 |

KALİPER TAMİR TAKIMI • CALIPER REPAIR KIT



| | |
|--------------------|--------------------------------|
| ALCAN OTOMOTIV NO. | 3009 |
| OEM NO. | K001915, K001925, 000 420 4382 |
| MODEL | SN6..., SN7... |

| No. | Ref. No. | Parça Adı / Part Name | Ölçü (mm) Dimensions | Adet Pcs. |
|-----|----------|---------------------------------|----------------------|-----------|
| 1 | 1119 | Perno / Pin | Ø 36 / 114 mm | 1 |
| 2 | 1215 | Civata / Screw | M16 x 1.5 / 87 mm | 1 |
| 3 | 1120 | Perno / Pin | Ø 32 / 80 mm | 1 |
| 4 | 1217 | Civata / Screw | M16 x 1.5 / 80 mm | 1 |
| 5 | 1421 | Burç / Bush | Ø 36 x 40 / 82 mm | 1 |
| 6 | 1422 | Perno Yüzüğü / Pin Boot Ring | - | 1 |
| 7 | 1509 | Perno Kapağı / Pin Cap | Ø 40 / 11 mm | 1 |
| 8 | 1925 | Lastikli Burç / Pin Rubber Bush | Ø 39 mm | 1 |
| 9 | 1317 | Toz Lastiği / Pin Boot | - | 1 |



ALCAN OTOMOTIV

CALIPER SYSTEMS

KALİPER TAMİR TAKIMI • CALIPER REPAIR KIT

| | |
|--------------------|------------------------|
| ALCAN OTOMOTIV NO. | 3010 |
| OEM NO. | II39769F0062, 42537451 |
| MODEL | SB7... |



| No. | Ref. No. | Parça Adı / Part Name | Ölçü (mm) Dimensions | Adet Pcs. |
|-----|----------|------------------------------|----------------------|-----------|
| 1 | 1119 | Perno / Pin | Ø 36 / 114 mm | 1 |
| 2 | 1215 | Civata / Screw | M16 x 1.5 / 87 mm | 1 |
| 3 | 1117 | Perno / Pin | Ø 34 / 80 mm | 1 |
| 4 | 1215 | Civata / Screw | M16 x 1.5 / 87 mm | 1 |
| 5 | 1421 | Burç / Bush | Ø 36 x 40 / 82 mm | 1 |
| 6 | 1317 | Toz Lastiği / Pin Boot | - | 1 |
| 7 | 1510 | Saç Kapak / Steel Cap | - | 1 |
| 8 | 1509 | Perno Kapağı / Pin Cap | Ø 40 / 11 mm | 1 |
| 9 | 1316 | Kauçuk Burç / Rubber Bush | Ø 34 x 40 / 50 mm | 1 |
| 10 | 1422 | Perno Yüzüğü / Pin Boot Ring | - | 1 |
| 11 | 1924 | Kapak O-ringi / Cap O-Ring | - | 1 |

KALİPER TAMİR TAKIMI • CALIPER REPAIR KIT

| | |
|--------------------|---|
| ALCAN OTOMOTIV NO. | 3011 |
| OEM NO. | K000365, 0004200782, 0004202282, 0004203482 |
| MODEL | SB6..., SB7... |



| No. | Ref. No. | Parça Adı / Part Name | Ölçü (mm) Dimensions | Adet Pcs. |
|-----|----------|---------------------------------|----------------------|-----------|
| 1 | 1119 | Perno / Pin | Ø 36 / 114 mm | 1 |
| 2 | 1117 | Perno / Pin | Ø 34 / 80 mm | 1 |
| 3 | 1120 | Perno / Pin | Ø 32 / 80 mm | 1 |
| 4 | 1215 | Civata / Screw | M16 x 1.5 / 87 mm | 1 |
| 5 | 1215 | Civata / Screw | M16 x 1.5 / 87 mm | 1 |
| 6 | 1217 | Civata / Screw | M16 x 1.5 / 80 mm | 1 |
| 7 | 1421 | Burç / Bush | Ø 36 x 40 / 82 mm | 1 |
| 8 | 1317 | Toz Lastiği / Pin Boot | - | 1 |
| 9 | 1510 | Saç Kapak / Steel Cap | - | 1 |
| 10 | 1509 | Perno Kapağı / Pin Cap | Ø 40 / 11 mm | 1 |
| 11 | 1924 | Kapak O-ringi / Cap O-Ring | - | 1 |
| 12 | 1925 | Lastikli Burç / Pin Rubber Bush | Ø 39 mm | 1 |
| 13 | 1422 | Perno Yüzüğü / Pin Boot Ring | - | 1 |
| 14 | 1316 | Kauçuk Burç / Rubber Bush | Ø 34 x 40 / 50 mm | 1 |



ALCAN OTOMOTIV

CALIPER SYSTEMS

KALİPER TAMİR TAKIMI • CALIPER REPAIR KIT



| ALCAN OTOMOTIV NO. | 3012 | | | |
|--------------------|------------------------|------------------------|----------------------|-----------|
| OEM NO. | K001928, 81.50822.6026 | | | |
| MODEL | SN5... | | | |
| No. | Ref. No. | Parça Adı / Part Name | Ölçü (mm) Dimensions | Adet Pcs. |
| 1 | 1122 | Perno / Pin | Ø 30 / 99 mm | 1 |
| 2 | 1219 | Civata / Screw | M16 x 1.5 / 105 mm | 1 |
| 3 | 1123 | Perno / Pin | Ø 30 / 72 mm | 1 |
| 4 | 1217 | Civata / Screw | M16 x 1.5 / 75 mm | 1 |
| 5 | 1424 | Perno Yüzük / Pin Ring | - | 2 |
| 6 | 1426 | Burç / Bush | Ø 30 x 34 / 65 mm | 1 |
| 7 | 1511 | Perno Kapağı / Pin Cap | Ø 34 / 14 mm | 2 |
| 8 | 1318 | Toz Lastiği / Pin Boot | - | 2 |
| 9 | 1425 | Burç / Bush | Ø 30 x 34 / 20 mm | 1 |

KALİPER TAMİR TAKIMI • CALIPER REPAIR KIT



| ALCAN OTOMOTIV NO. | 3013 | | | |
|--------------------|------------------------|--|----------------------|-----------|
| OEM NO. | K000935, 3.434.3802.00 | | | |
| MODEL | SB5..., SB6..., SB7... | | | |
| No. | Ref. No. | Parça Adı / Part Name | Ölçü (mm) Dimensions | Adet Pcs. |
| 1 | 1116 | Perno / Pin | Ø 36 / 145 mm | 1 |
| 2 | 1214 | Civata / Screw | M16 x 1.5 / 150 mm | 1 |
| 3 | 1315 | Körüklü Kapak / Bellow Cap | - | 1 |
| 4 | 1317 | Toz Lastiği / Pin Boot | - | 1 |
| 5 | 1421 | Burç / Bush | Ø 36 x 40 / 82 mm | 1 |
| 6 | 1422 | Perno Yüzüğü / Pin Boot Ring | - | 1 |
| 7 | 1922 | Körüklü Kapak Kelepçe / Bellow Cap Clamp | - | 1 |

KALİPER TAMİR TAKIMI • CALIPER REPAIR KIT



| ALCAN OTOMOTIV NO. | 3056 | | | |
|--------------------|----------------|------------------------------|----------------------|-----------|
| OEM NO. | K000696 | | | |
| MODEL | SB6..., SB7... | | | |
| No. | Ref. No. | Parça Adı / Part Name | Ölçü (mm) Dimensions | Adet Pcs. |
| 1 | 1119 | Perno / Pin | Ø 36 / 114 mm | 1 |
| 2 | 1215 | Civata / Screw | M16 x 1.5 / 90 mm | 1 |
| 3 | 1421 | Burç / Bush | Ø 36 x 40 / 82 mm | 1 |
| 4 | 1510 | Saç Kapak / Steel Cap | - | 1 |
| 5 | 1924 | Kapak O-ringi / Cap O-Ring | - | 1 |
| 6 | 1317 | Toz Lastiği / Pin Boot | - | 1 |
| 7 | 1422 | Perno Yüzüğü / Pin Boot Ring | - | 1 |



ALCAN OTOMOTIV

CALIPER SYSTEMS

KALİPER ÜÇLÜ BURÇ UZUN (Ø39MM) • CALIPER METAL-RUBBER BUSH LONG (Ø39MM)



| ALCAN OTOMOTIV NO. | 3014 | | | |
|--------------------|----------------|---------------------------------|----------------------|-----------|
| OEM NO. | - | | | |
| MODEL | SB6..., SB7... | | | |
| No. | Ref. No. | Parça Adı / Part Name | Ölçü (mm) Dimensions | Adet Pcs. |
| 1 | 1923 | Lastikli Burç / Pin Rubber Bush | Ø 39 mm | 1 |

KALİPER PERNO VE BURÇ • CALIPER GUIDE AND BUSH



| ALCAN OTOMOTIV NO. | 3015 | | | |
|--------------------|---------------|---------------------------------|----------------------|-----------|
| OEM NO. | K000697 | | | |
| MODEL | SB6... SB7... | | | |
| No. | Ref. No. | Parça Adı / Part Name | Ölçü (mm) Dimensions | Adet Pcs. |
| 1 | 1120 | Perno / Pin | Ø 32 / 80 mm | 1 |
| 2 | 1923 | Lastikli Burç / Pin Rubber Bush | Ø 39 mm | 1 |

KALİPER TAMİR TAKIMI • CALIPER REPAIR KIT

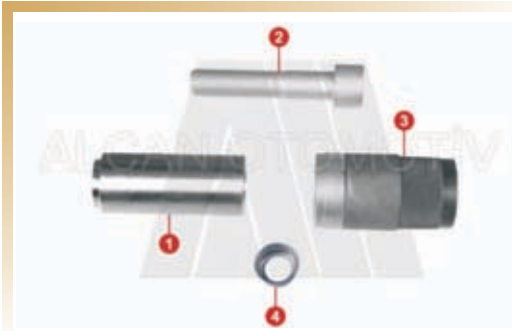

| ALCAN OTOMOTIV NO. | 3016 | | | |
|--------------------|----------------|---------------------------------|----------------------|-----------|
| OEM NO. | K000698 | | | |
| MODEL | SB6..., SB7... | | | |
| No. | Ref. No. | Parça Adı / Part Name | Ölçü (mm) Dimensions | Adet Pcs. |
| 1 | 1120 | Perno / Pin | Ø 32 / 80 mm | 1 |
| 2 | 1923 | Civata / Screw | M16 x 1.5 / 80 mm | 1 |
| 3 | 1120 | Lastikli Burç / Pin Rubber Bush | Ø 39 mm | 1 |
| 4 | 1923 | Yüzük / Ring | - | 1 |

KALİPER ÜÇLÜ BURÇ UZUN (Ø35MM) • CALIPER METAL-RUBBER BUSH (Ø35MM)



| ALCAN OTOMOTIV NO. | 3017 | | | |
|--------------------|----------------|---------------------------------|----------------------|-----------|
| OEM NO. | - | | | |
| MODEL | SB6..., SB7... | | | |
| No. | Ref. No. | Parça Adı / Part Name | Ölçü (mm) Dimensions | Adet Pcs. |
| 1 | 1926 | Lastikli Burç / Pin Rubber Bush | Ø 35 mm | 1 |

KALİPER PERNO VE BURÇ • CALIPER GUIDE AND BUSH



| ALCAN OTOMOTIV NO. | 3018 | | | |
|--------------------|----------------|---------------------------------|----------------------|-----------|
| OEM NO. | - | | | |
| MODEL | SB6..., SB7... | | | |
| No. | Ref. No. | Parça Adı / Part Name | Ölçü (mm) Dimensions | Adet Pcs. |
| 1 | 1120 | Perno / Pin | Ø 32 / 80 mm | 1 |
| 2 | 1926 | Lastikli Burç / Pin Rubber Bush | Ø 35 mm | 1 |



ALCAN OTOMOTIV

CALIPER SYSTEMS

KALİPER TAMİR TAKIMI • CALIPER REPAIR KIT



| ALCAN OTOMOTIV NO. | 3019 | | | |
|--------------------|----------------|---------------------------------|----------------------|-----------|
| OEM NO. | - | | | |
| MODEL | SB6..., SB7... | | | |
| No. | Ref. No. | Parça Adı / Part Name | Ölçü (mm) Dimensions | Adet Pcs. |
| 1 | 1120 | Perno / Pin | Ø 32 / 80 mm | 1 |
| 2 | 1217 | Civata / Screw | M16 x 1.5 / 80 mm | 1 |
| 3 | 1926 | Lastikli Burç / Pin Rubber Bush | Ø 35 mm | 1 |
| 4 | 1508 | Yüzük / Ring | - | 1 |

KALİPER ÜÇLÜ BURÇ KISA (Ø39MM) • CALIPER METAL-RUBBER BUSH SHORT (Ø39MM)



| ALCAN OTOMOTIV NO. | 3020 | | | |
|--------------------|----------|---------------------------------|----------------------|-----------|
| OEM NO. | - | | | |
| MODEL | SB7... | | | |
| No. | Ref. No. | Parça Adı / Part Name | Ölçü (mm) Dimensions | Adet Pcs. |
| 1 | 1925 | Lastikli Burç / Pin Rubber Bush | Ø 39 mm | 1 |

KALİPER PERNO VE BURÇ • CALIPER GUIDE AND BUSH



| ALCAN OTOMOTIV NO. | 3021 | | | |
|--------------------|----------|---------------------------------|----------------------|-----------|
| OEM NO. | - | | | |
| MODEL | SB7... | | | |
| No. | Ref. No. | Parça Adı / Part Name | Ölçü (mm) Dimensions | Adet Pcs. |
| 1 | 1120 | Perno / Pin | Ø 32 / 80 mm | 1 |
| 2 | 1925 | Lastikli Burç / Pin Rubber Bush | Ø 39 mm | 1 |

KALİPER TAMİR TAKIMI • CALIPER REPAIR KIT



| ALCAN OTOMOTIV NO. | 3022 | | | |
|--------------------|----------|---------------------------------|----------------------|-----------|
| OEM NO. | - | | | |
| MODEL | SB7... | | | |
| No. | Ref. No. | Parça Adı / Part Name | Ölçü (mm) Dimensions | Adet Pcs. |
| 1 | 1120 | Perno / Pin | Ø 32 / 80 mm | 1 |
| 2 | 1217 | Civata / Screw | M16 x 1.5 / 80 mm | 1 |
| 3 | 1925 | Lastikli Burç / Pin Rubber Bush | Ø 39 mm | 1 |



ALCAN OTOMOTIV

CALIPER SYSTEMS

KALİPER PERNO VE BURÇ • CALIPER GUIDE AND BUSH

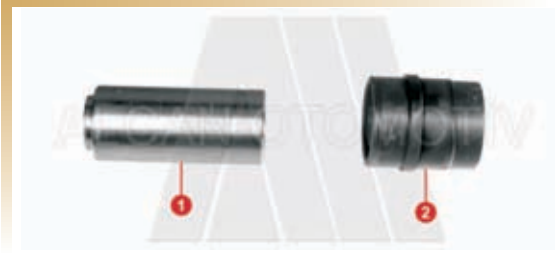

| ALCAN OTOMOTIV NO. | 3023 | | | |
|--------------------|------------------------|---------------------------|----------------------|-----------|
| OEM NO. | - | | | |
| MODEL | SB5..., SB6..., SB7... | | | |
| No. | Ref. No. | Parça Adı / Part Name | Ölçü (mm) Dimensions | Adet Pcs. |
| 1 | 1117 | Perno / Pin | Ø 34 / 80 mm | 1 |
| 2 | 1316 | Kauçuk Burç / Rubber Bush | Ø 34 x 40 / 50 mm | 1 |

KALİPER TAMİR TAKIMI • CALIPER REPAIR KIT

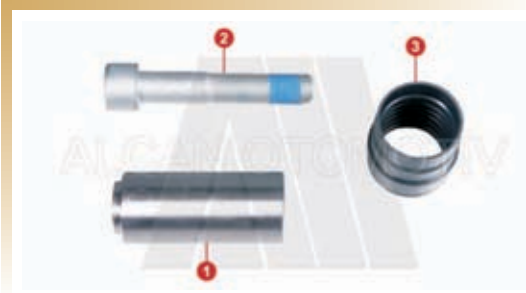

| ALCAN OTOMOTIV NO. | 3024 | | | |
|--------------------|----------------------------------|---------------------------|----------------------|-----------|
| OEM NO. | 11368470064, 1448910, 3434380100 | | | |
| MODEL | SB5..., SB6..., SB7... | | | |
| No. | Ref. No. | Parça Adı / Part Name | Ölçü (mm) Dimensions | Adet Pcs. |
| 1 | 1117 | Perno / Pin | Ø 34 / 80 mm | 1 |
| 2 | 1215 | Civata / Screw | M16 x 1.5 / 87 mm | 1 |
| 3 | 1316 | Kauçuk Burç / Rubber Bush | Ø 34 x 40 / 50 mm | 1 |

KALİPER BİLYALI MEKANİZMA • CALIPER ADJUSTING MECHANISM



| ALCAN OTOMOTIV NO. | 3025 | | | |
|--------------------|--|--|----------------------|-----------|
| OEM NO. | - | | | |
| MODEL | SN6..., SN7..., SK7..., SB5..., SB6..., SB7... | | | |
| No. | Ref. No. | Parça Adı / Part Name | Ölçü (mm) Dimensions | Adet Pcs. |
| 1 | 3025 | Ayar Mekanizması / Adjusting Mechanism | - | 1 |

KALİPER BİLYALI MEKANİZMA • CALIPER ADJUSTING MECHANISM

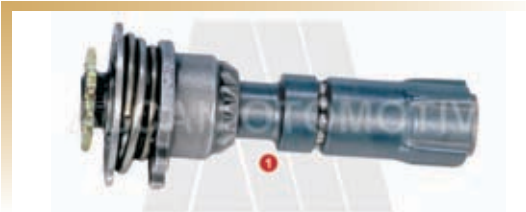

| ALCAN OTOMOTIV NO. | 3026 | | | |
|--------------------|-------------|--|----------------------|-----------|
| OEM NO. | - | | | |
| MODEL | SN5... | | | |
| No. | Ref. No. | Parça Adı / Part Name | Ölçü (mm) Dimensions | Adet Pcs. |
| 1 | 3026 | Ayar Mekanizması / Adjusting Mechanism | - | 1 |

KALİPER AYAR MEKANİZMASI • CALIPER ADJUSTING MECHANISM



| ALCAN OTOMOTIV NO. | 3027 | | | |
|--------------------|--|--|----------------------|-----------|
| OEM NO. | - | | | |
| MODEL | SN6..., SN7..., SK7..., SB5..., SB6..., SB7... | | | |
| No. | Ref. No. | Parça Adı / Part Name | Ölçü (mm) Dimensions | Adet Pcs. |
| 1 | 3027 | Ayar Mekanizması / Adjusting Mechanism | - | 1 |



ALCAN OTOMOTIV

CALIPER SYSTEMS

KALİPER MEKANİZMA DİŞLİSİ • BRAKE CALIPER MECHANISM GEAR



| ALCAN OTOMOTIV NO. | 3049 | | | |
|--------------------|--|-------------------------------|----------------------|-----------|
| OEM NO. | - | | | |
| MODEL | SB5..., SB6..., SB7..., SN6..., SN7..., SK7... | | | |
| No. | Ref. No. | Parça Adı / Part Name | Ölçü (mm) Dimensions | Adet Pcs. |
| 1 | 1850 | Ayar Dişlisi / Adjusting Gear | - | 10 |

KALİPER KÖRÜK VE KAPAK TAMİR TAKIMI • CALIPER BELLOW AND STEEL CAP REPAIR KIT



| ALCAN OTOMOTIV NO. | 3028 | | | |
|--------------------|------------------------|--|----------------------|-----------|
| OEM NO. | K001301, 81.50822.6025 | | | |
| MODEL | SB6..., SB7... | | | |
| No. | Ref. No. | Parça Adı / Part Name | Ölçü (mm) Dimensions | Adet Pcs. |
| 1 | 1315 | Körüklü Kapak / Bellow Cap | - | 6 |
| 2 | 1922 | Körüklü Kapak Kelepçesi / Bellow Cap Clamp | - | 6 |
| 3 | 1510 | Sac Kapak / Steel Cap | - | 6 |
| 4 | 1924 | Kapak O-ringi / Cap O-Ring | - | 6 |

KALİPER DAYAMA TAMİR TAKIMI (69MM) • CALIPER TAPPET REPAIR KIT (69MM)



| ALCAN OTOMOTIV NO. | 3029 | | | |
|--------------------|---------------------------|--|----------------------|-----------|
| OEM NO. | K001300, K010603, K000366 | | | |
| MODEL | SN6..., SN7..., SK7... | | | |
| No. | Ref. No. | Parça Adı / Part Name | Ölçü (mm) Dimensions | Adet Pcs. |
| 1 | 1839 | Kaliper Körüklü tenek / Thrust Part With Bellow | 69 mm | 2 |
| 2 | 1319 | Kaliper Dürbünü Toz Lasti i / Shaft Housing Boot | 69 mm | 2 |
| 3 | 1427 | Burç / Round Bush | Ø 16 x 18 / 10 mm | 2 |

KALİPER DAYAMA TAMİR TAKIMI (69MM) • CALIPER TAPPET REPAIR KIT (69MM)



| ALCAN OTOMOTIV NO. | 3030 | | | |
|--------------------|------------------------|--|----------------------|-----------|
| OEM NO. | - | | | |
| MODEL | SN6..., SN7..., SK7... | | | |
| No. | Ref. No. | Parça Adı / Part Name | Ölçü (mm) Dimensions | Adet Pcs. |
| 1 | 1839 | Kaliper Körüklü İtenek / Thrust Part With Bellow | 69 mm | 2 |
| 2 | 1427 | Burç / Round Bush | Ø 16 x 18 / 10 mm | 2 |



ALCAN OTOMOTIV

CALIPER SYSTEMS

KALİPER DAYAMA TAMİR TAKIMI (74MM) • CALIPER TAPPET REPAIR KIT (74MM)



| | |
|--------------------|------------------|
| ALCAN OTOMOTIV NO. | 3031 |
| OEM NO. | K000944, K010604 |
| MODEL | SB6..., SB7... |

| No. | Ref. No. | Parça Adı / Part Name | Ölçü (mm) Dimensions | Adet Pcs. |
|-----|----------|--|----------------------|-----------|
| 1 | 1840 | Kaliper Körüklü tenek / Thrust Part With Bellow | 74 mm | 2 |
| 2 | 1320 | Kaliper Dürbünü Toz Lasti i / Shaft Housing Boot | 74 mm | 2 |
| 3 | 1427 | Burç / Round Bush | Ø 16 x 18 / 10 mm | 2 |

KALİPER DAYAMA TAMİR TAKIMI (74MM) • CALIPER TAPPET REPAIR KIT (74MM)



| | |
|--------------------|----------------|
| ALCAN OTOMOTIV NO. | 3032 |
| OEM NO. | - |
| MODEL | SB6..., SB7... |

| No. | Ref. No. | Parça Adı / Part Name | Ölçü (mm) Dimensions | Adet Pcs. |
|-----|----------|---|----------------------|-----------|
| 1 | 1840 | Kaliper Körüklü tenek / Thrust Part With Bellow | 74 mm | 2 |
| 2 | 1427 | Burç / Round Bush | Ø 16 x 18 / 10 mm | 2 |

KALİPER DAYAMA TAMİR TAKIMI (69MM) • CALIPER TAPPET REPAIR KIT (69MM)



| | |
|--------------------|------------------------|
| ALCAN OTOMOTIV NO. | 3033 |
| OEM NO. | K001929, 81.50822.6027 |
| MODEL | SN5... |

| No. | Ref. No. | Parça Adı / Part Name | Ölçü (mm) Dimensions | Adet Pcs. |
|-----|----------|--|----------------------|-----------|
| 1 | 1841 | Kaliper Körüklü tenek / Thrust Part With Bellow | 69 mm | 2 |
| 2 | 1319 | Kaliper Dürbünü Toz Lasti i / Shaft Housing Boot | 69 mm | 2 |
| 3 | 1427 | Burç / Round Bush | Ø 16 x 18 / 10 mm | 2 |

TOZ KÖRÜĞÜ • CALIPER BOOTS



| | |
|--------------------|--|
| ALCAN OTOMOTIV NO. | 3034 |
| OEM NO. | - |
| MODEL | SB5..., SB6..., SB7..., SN6..., SN7..., SK7... |

| No. | Ref. No. | Parça Adı / Part Name | Ölçü (mm) Dimensions | Adet Pcs. |
|-----|----------|------------------------------|----------------------|-----------|
| 1 | 1422 | Perno Yüzüğü / Pin Boot Ring | - | 1 |
| 2 | 1317 | Toz Lastiği / Pin Boot | - | 1 |



ALCAN OTOMOTIV

CALIPER SYSTEMS

KÖRÜK TAKIMI • GUIDE SEALS & BOT



ALCAN OTOMOTIV NO. **3035**

OEM NO. -

MODEL SB6..., SB7...

| No. | Ref. No. | Parça Adı / Part Name | Ölçü (mm) Dimensions | Adet Pcs. |
|-----|----------|--|----------------------|-----------|
| 1 | 1317 | Toz Lastiği / Pin Boot | - | 1 |
| 2 | 1315 | Körüklü Kapak / Bellow Cap | - | 1 |
| 3 | 1422 | Perno Yüzüğü / Pin Boot Ring | - | 1 |
| 4 | 1922 | Körüklü Kapak Kelepçesi / Bellow Cap Clamp | - | 1 |

KÖRÜK TAKIMI • GUIDE SEALS & BOT



ALCAN OTOMOTIV NO. **3036**

OEM NO. I1328090061, 0014205283, 81.50822.6008

MODEL SB6..., SB7...

| No. | Ref. No. | Parça Adı / Part Name | Ölçü (mm) Dimensions | Adet Pcs. |
|-----|----------|------------------------------|----------------------|-----------|
| 1 | 1317 | Toz Lastiği / Pin Boot | - | 1 |
| 2 | 1510 | Sac Kapak / Steel Cap | - | 1 |
| 3 | 1422 | Perno Yüzüğü / Pin Boot Ring | - | 1 |
| 4 | 1924 | Kapak O-ringi / Cap O-Ring | - | 1 |

KALİPER AYAR CİVATASI • CALIPER CALIBRATION BOLT



ALCAN OTOMOTIV NO. **3040**

OEM NO. -

MODEL SB6..., SB7..., SN6..., SN7..., SK7...,

| No. | Ref. No. | Parça Adı / Part Name | Ölçü (mm) Dimensions | Adet Pcs. |
|-----|----------|----------------------------------|----------------------|-----------|
| 1 | 3040 | Ayar Cıvatası / Calibration Bolt | - | 1 |

KALİPER KÖPRÜ BAĞLANTISI • CALIPER SHAFT HOUSING



ALCAN OTOMOTIV NO. **3037**

OEM NO. -

MODEL SN6..., SN7...

| No. | Ref. No. | Parça Adı / Part Name | Ölçü (mm) Dimensions | Adet Pcs. |
|-----|----------|----------------------------------|----------------------|-----------|
| 1 | 3037 | Köprü Bağlantısı / Shaft Housing | - | 1 |



ALCAN OTOMOTIV

CALIPER SYSTEMS

KALİPER KÖPRÜ BAĞLANTISI (TAKIM) • CALIPER SHAFT HOUSING (FULL KIT)



| ALCAN OTOMOTIV NO. | 3046 | | | |
|--------------------|----------------|----------------------------------|----------------------|-----------|
| OEM NO. | - | | | |
| MODEL | SN6..., SN7... | | | |
| No. | Ref. No. | Parça Adı / Part Name | Ölçü (mm) Dimensions | Adet Pcs. |
| 1 | 3037 | Köprü Ba lantısı / Shaft Housing | - | 1 |
| 2 | 3040 | Ayar Civatası / Calibration Bolt | - | 2 |

KALİPER KÖPRÜ BAĞLANTISI • CALIPER SHAFT HOUSING



| ALCAN OTOMOTIV NO. | 3038 | | | |
|--------------------|-------------|----------------------------------|----------------------|-----------|
| OEM NO. | - | | | |
| MODEL | SK7... | | | |
| No. | Ref. No. | Parça Adı / Part Name | Ölçü (mm) Dimensions | Adet Pcs. |
| 1 | 3038 | Köprü Ba lantısı / Shaft Housing | - | 1 |

KALİPER KÖPRÜ BAĞLANTISI (TAKIM) • CALIPER SHAFT HOUSING (FULL KIT)



| ALCAN OTOMOTIV NO. | 3047 | | | |
|--------------------|-------------|----------------------------------|----------------------|-----------|
| OEM NO. | - | | | |
| MODEL | SK7... | | | |
| No. | Ref. No. | Parça Adı / Part Name | Ölçü (mm) Dimensions | Adet Pcs. |
| 1 | 3038 | Köprü Ba lantısı / Shaft Housing | - | 1 |
| 2 | 3040 | Ayar Civatası / Calibration Bolt | - | 2 |

KALİPER KÖPRÜ BAĞLANTISI • CALIPER SHAFT HOUSING



| ALCAN OTOMOTIV NO. | 3039 | | | |
|--------------------|----------------|----------------------------------|----------------------|-----------|
| OEM NO. | - | | | |
| MODEL | SB6..., SB7... | | | |
| No. | Ref. No. | Parça Adı / Part Name | Ölçü (mm) Dimensions | Adet Pcs. |
| 1 | 3039 | Köprü Ba lantısı / Shaft Housing | - | 1 |

KALİPER KÖPRÜ BAĞLANTISI • CALIPER SHAFT HOUSING



| ALCAN OTOMOTIV NO. | 3048 | | | |
|--------------------|----------------|----------------------------------|----------------------|-----------|
| OEM NO. | - | | | |
| MODEL | SB6..., SB7... | | | |
| No. | Ref. No. | Parça Adı / Part Name | Ölçü (mm) Dimensions | Adet Pcs. |
| 1 | 3039 | Köprü Ba lantısı / Shaft Housing | - | 1 |
| 1 | 3040 | Ayar Civatası / Calibration Bolt | - | 2 |



ALCAN OTOMOTIV

CALIPER SYSTEMS

KALİPER MASURA BİLYA TAKIMI • CALIPER ROLLER BEARINGS

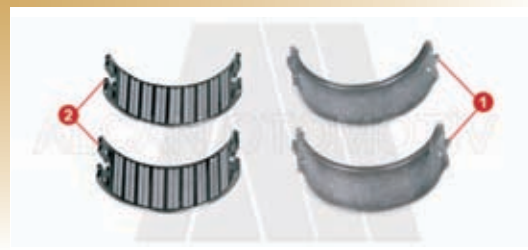

ALCAN OTOMOTIV NO. **3041**

OEM NO. -

MODEL SN6..., SN7..., SK7..., SB5...

| No. | Ref. No. | Parça Adı / Part Name | Ölçü (mm) Dimensions | Adet Pcs. |
|-----|----------|-----------------------------|----------------------|-----------|
| 1 | 1842 | Bilya Yatağı / Bearing Cage | - | 2 |
| 2 | 1607 | Masura Rulman / Bearing | - | 2 |

KALİPER MASURA BİLYA TAKIMI • CALIPER ROLLER BEARINGS

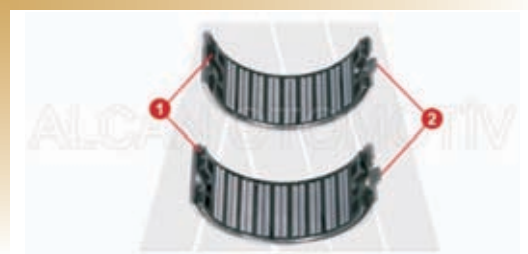

ALCAN OTOMOTIV NO. **3042**

OEM NO. -

MODEL SB5..., SB6..., SB7...

| No. | Ref. No. | Parça Adı / Part Name | Ölçü (mm) Dimensions | Adet Pcs. |
|-----|----------|-----------------------------|----------------------|-----------|
| 1 | 1843 | Bilya Yatağı / Bearing Cage | - | 2 |
| 2 | 1607 | Masura Rulman / Bearing | - | 2 |

KALİPER TAPASI • CALIPER CAPS

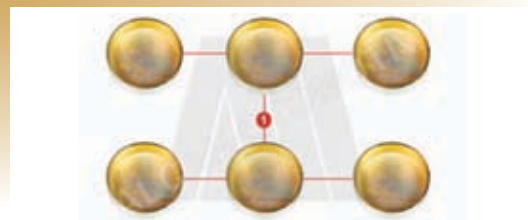

ALCAN OTOMOTIV NO. **3043**

OEM NO. -

MODEL SN6..., SN7...

| No. | Ref. No. | Parça Adı / Part Name | Ölçü (mm) Dimensions | Adet Pcs. |
|-----|----------|-----------------------|----------------------|-----------|
| 1 | 1509 | Tapa / Pin Cap | Ø 40 / 11 mm | 6 |

PLASTİK SENSOR KAPAĞI (ÇİPSİZ) • CALIPER PLASTIC COVER (WITHOUT CHIP)



ALCAN OTOMOTIV NO. **3044**

OEM NO. -

MODEL SB6..., SB7..., SN6..., SN7...

| No. | Ref. No. | Parça Adı / Part Name | Ölçü (mm) Dimensions | Adet Pcs. |
|-----|----------|-------------------------------|----------------------|-----------|
| 1 | 3044 | Sensor Kapağı / Plastic Cover | - | 1 |

KALİPER MEKANİZMA ZİNCİRİ (29 DİŞ) • CALIPER CALIBRATION SHAFT CHAIN (29 LINK)

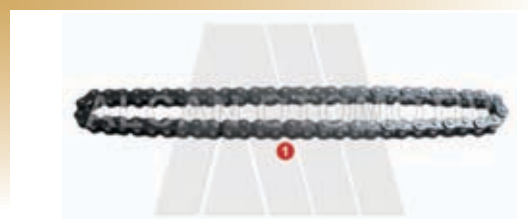

ALCAN OTOMOTIV NO. **3045**

OEM NO. -

MODEL SB6..., SB7..., SN6..., SN7..., SK7...

| No. | Ref. No. | Parça Adı / Part Name | Ölçü (mm) Dimensions | Adet Pcs. |
|-----|----------|-----------------------|----------------------|-----------|
| 1 | 3045 | Zincir / Chain | 29 diş / 29 link | 1 |



ALCAN OTOMOTIV

CALIPER SYSTEMS

KALİPER TUTUCU TAMİR TAKIMI • BRAKE PAD RETAINER REPAIR KIT



| | |
|--------------------|-----------------------|
| ALCAN OTOMOTIV NO. | 3050 |
| OEM NO. | 119712004, 1130679004 |
| MODEL | SB6..., SB7... |

| No. | Ref. No. | Parça Adı / Part Name | Ölçü (mm) Dimensions | Adet Pcs. |
|-----|----------|---------------------------|----------------------|-----------|
| 1 | 1851 | Tutucu Saç / Pad Retainer | - | 1 |
| 2 | 1852 | Pim / Anti Rotation Pin | - | 1 |
| 3 | 1935 | Tutucu Pim / Holder pin | - | 1 |
| 4 | 1934 | Pul / Washer | - | 1 |

AYAR MEKANİZMA KAPAK TAKIMI (38MM) • ADJUSTING MECHANISM CAP SET (38MM)

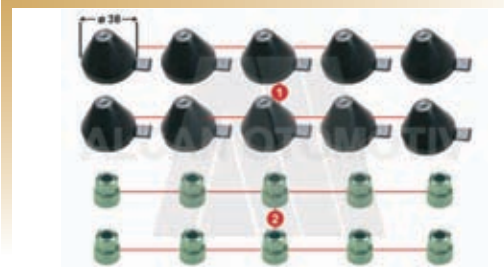

| | |
|--------------------|---------------------|
| ALCAN OTOMOTIV NO. | 3051 |
| OEM NO. | K000029, 0004234687 |
| MODEL | SN6..., SN7... |

| No. | Ref. No. | Parça Adı / Part Name | Ölçü (mm) Dimensions | Adet Pcs. |
|-----|----------|-------------------------------|----------------------|-----------|
| 1 | 1518 | Plastik Kapak / Plastic Cover | 38 mm | 10 |
| 2 | 1223 | Ayar Somunu / Adjusting Nut | - | 10 |

AYAR MEKANİZMA KAPAK TAKIMI • ADJUSTING MECHANISM CAP SET

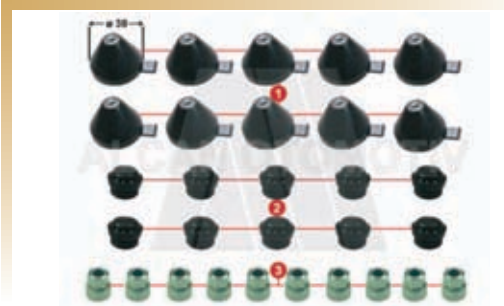

| | |
|--------------------|------------------------|
| ALCAN OTOMOTIV NO. | 3052 |
| OEM NO. | K000945, 81.50822.6024 |
| MODEL | SB6..., SB7... |

| No. | Ref. No. | Parça Adı / Part Name | Ölçü (mm) Dimensions | Adet Pcs. |
|-----|----------|-------------------------------|----------------------|-----------|
| 1 | 1518 | Plastik Kapak / Plastic Cover | 38 mm | 10 |
| 2 | 1519 | Kapak / Cover | - | 10 |
| 3 | 1223 | Ayar Somunu / Adjusting Nut | - | 10 |

AYAR MEKANİZMA KAPAK TAKIMI (35MM) • ADJUSTING MECHANISM CAP SET (35MM)

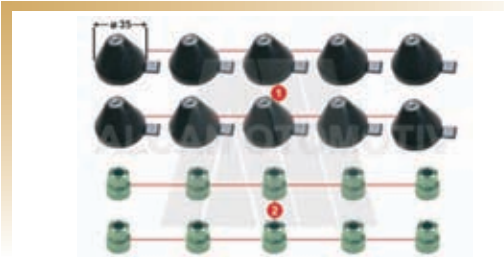

| | |
|--------------------|---------------|
| ALCAN OTOMOTIV NO. | 3053 |
| OEM NO. | K003902 |
| MODEL | Tüm SN serisi |

| No. | Ref. No. | Parça Adı / Part Name | Ölçü (mm) Dimensions | Adet Pcs. |
|-----|----------|-------------------------------|----------------------|-----------|
| 1 | 1520 | Plastik Kapak / Plastic Cover | 35 mm | 10 |
| 2 | 1223 | Ayar Somunu / Adjusting Nut | - | 10 |

AYAR MEKANİZMA ADAPTÖR SETİ • ADJUSTING MECHANISM ADAPTER SET

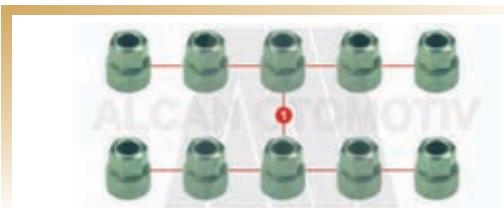

| | |
|--------------------|------------------------|
| ALCAN OTOMOTIV NO. | 3054 |
| OEM NO. | Z001548 |
| MODEL | SB5..., SB6..., SB7... |

| No. | Ref. No. | Parça Adı / Part Name | Ölçü (mm) Dimensions | Adet Pcs. |
|-----|----------|-----------------------------|----------------------|-----------|
| 1 | 1223 | Ayar Somunu / Adjusting Nut | - | 10 |

ALCAN OTOMOTIV

CALIPER SYSTEMS



WABCO
SERIES



ALCAN OTOMOTIV

CALIPER SYSTEMS

KALİPER TAMİR TAKIMI • CALIPER REPAIR KIT



| ALCAN OTOMOTIV NO. | 4001 | | | |
|--------------------|----------|--------------------------------------|----------------------|-----------|
| OEM NO. | 12999776 | | | |
| MODEL | Pan 19.5 | | | |
| No. | Ref. No. | Parça Adı / Part Name | Ölçü (mm) Dimensions | Adet Pcs. |
| 1 | 1127 | Perno / Pin | Ø 38 / 76 mm | 1 |
| 2 | 1128 | Perno / Pin | Ø 38 / 120 mm | 1 |
| 3 | 1217 | Civata / Screw | M16 x 1.5 / 80 mm | 1 |
| 4 | 1220 | Civata / Screw | M16 x 1.5 / 120 mm | 1 |
| 5 | 1322 | Perno Toz Lastiği / Caliper Pin Boot | - | 2 |
| 6 | 1321 | Perno Toz Lastiği / Caliper Pin Boot | - | 1 |
| 7 | 1428 | Perno Burcu / Pin Bush | Ø 38 x 42 / 30 mm | 3 |
| 8 | 1512 | Perno Kapağı / Pin Cap | Ø 42 / 17 mm | 1 |
| 9 | 1513 | Perno Kapağı / Pin Cap | Ø 42 / 28 mm | 1 |
| 10 | 1929 | Pul / Washer | - | 2 |

KALİPER TAMİR TAKIMI • CALIPER REPAIR KIT



| ALCAN OTOMOTIV NO. | 4016 | | | |
|--------------------|------------|--------------------------------------|----------------------|-----------|
| OEM NO. | 12999738VT | | | |
| MODEL | Pan 19.5 | | | |
| No. | Ref. No. | Parça Adı / Part Name | Ölçü (mm) Dimensions | Adet Pcs. |
| 1 | 1127 | Perno / Pin | Ø 38 / 76 mm | 1 |
| 2 | 1128 | Perno / Pin | Ø 38 / 120 mm | 1 |
| 3 | 1217 | Civata / Screw | M16 x 1.5 / 80 mm | 1 |
| 4 | 1220 | Civata / Screw | M16 x 1.5 / 120 mm | 1 |
| 5 | 1322 | Perno Toz Lastiği / Caliper Pin Boot | - | 2 |
| 6 | 1321 | Perno Toz Lastiği / Caliper Pin Boot | - | 1 |
| 7 | 1428 | Perno Burcu / Pin Bush | Ø 38 x 42 / 30 mm | 3 |
| 8 | 1512 | Perno Kapağı / Pin Cap | Ø 42 / 17 mm | 1 |
| 9 | 1513 | Perno Kapağı / Pin Cap | Ø 42 / 28 mm | 1 |
| 10 | 1929 | Pul / Washer | - | 2 |
| 11 | 1328 | Perno Toz Lastiği / Caliper Pin Boot | - | 2 |
| 12 | 1515 | Conta / Seal | - | 1 |



ALCAN OTOMOTIV

CALIPER SYSTEMS

KALİPER TAMİR TAKIMI • CALIPER REPAIR KIT



| ALCAN OTOMOTIV NO. | 4002 | | | |
|--------------------|------------|--------------------------------------|----------------------|-----------|
| OEM NO. | 12999729VT | | | |
| MODEL | Pan 17.5 | | | |
| No. | Ref. No. | Parça Adı / Part Name | Ölçü (mm) Dimensions | Adet Pcs. |
| 1 | 1124 | Perno / Pin | Ø 25 / 81 mm | 2 |
| 2 | 1123 | Perno / Pin | Ø 25 / 81 mm | 2 |
| 3 | 1227 | Civata / Screw | M12 x 1.5 / 90 mm | 4 |
| 4 | 1927 | Conta / Seal | - | 2 |
| 5 | 1943 | Conta / Seal | - | 2 |
| 6 | 1514 | Perno Kapağı / Pin Cap | - | 4 |
| 7 | 1323 | Perno Toz Lastiği / Caliper Pin Boot | - | 4 |
| 8 | 1429 | Perno Burcu / Pin Bush | - | 8 |
| 9 | 1324 | Perno Toz Lastiği / Caliper Pin Boot | - | 2 |
| 10 | 1221 | Civata / Screw | - | 2 |
| 11 | 1708 | Yay / Spring | - | 2 |
| 12 | 1928 | Conta / Seal | - | 2 |

KALİPER TAMİR TAKIMI • CALIPER REPAIR KIT



| ALCAN OTOMOTIV NO. | 4003 | | | |
|--------------------|--------------------|--------------------------------------|----------------------|-----------|
| OEM NO. | 12999699, 12999702 | | | |
| MODEL | Pan 17.5 | | | |
| No. | Ref. No. | Parça Adı / Part Name | Ölçü (mm) Dimensions | Adet Pcs. |
| 1 | 1126 | Perno / Pin | Ø 30 / 75 mm | 1 |
| 2 | 1125 | Perno / Pin | Ø 30 / 88 mm | 1 |
| 3 | 1218 | Civata / Screw | M16 x 1.5 / 70 mm | 1 |
| 4 | 1215 | Civata / Screw | M16 x 1.5 / 90 mm | 1 |
| 5 | 1516 | Perno Kapağı / Pin Cap | Ø 34 / 17 mm | 2 |
| 6 | 1430 | Burç / Bush | Ø 30 x 34 / 35 mm | 1 |
| 7 | 1321 | Perno Toz Lastiği / Caliper Pin Boot | - | 1 |
| 8 | 1325 | Perno Toz Lastiği / Caliper Pin Boot | - | 2 |
| 9 | 1425 | Burç / Bush | Ø 30 x 34 / 20 mm | 2 |
| 10 | 1515 | Conta / Seal | - | 1 |



ALCAN OTOMOTIV

CALIPER SYSTEMS

KALİPER TAMİR TAKIMI • CALIPER REPAIR KIT



ALCAN OTOMOTIV NO. 4015

OEM NO. 12999704VT

MODEL Pan 17.5

| No. | Ref. No. | Parça Adı / Part Name | Ölçü (mm) Dimensions | Adet Pcs. |
|-----|----------|--------------------------------------|----------------------|-----------|
| 1 | 1215 | Civata / Screw | M16 x 1.5 / 90 mm | 1 |
| 2 | 1218 | Civata / Screw | M16 x 1.5 / 70 mm | 1 |
| 3 | 1516 | Perno Kapağı / Pin Cap | Ø 34 / 17 mm | 2 |
| 4 | 1430 | Burç / Bush | Ø 30 x 34 / 35 mm | 1 |
| 5 | 1321 | Perno Toz Lastiği / Caliper Pin Boot | - | 1 |
| 6 | 1325 | Perno Toz Lastiği / Caliper Pin Boot | - | 2 |
| 7 | 1425 | Burç / Bush | Ø 30 x 34 / 20 mm | 2 |
| 8 | 1515 | Conta / Seal | - | 1 |

KALİPER MASURA BİLYA TAKIMI • CALIPER ROLLER BEARINGS



ALCAN OTOMOTIV NO. 4004

OEM NO. -

MODEL Pan 17.5, Pan 19.5

| No. | Ref. No. | Parça Adı / Part Name | Ölçü (mm) Dimensions | Adet Pcs. |
|-----|----------|-----------------------------|----------------------|-----------|
| 1 | 1844 | Bilya Yatağı / Bearing Cage | - | 2 |
| 2 | 1608 | Masura Rulman / Bearing | - | 2 |

TOZ KÖRÜĞÜ • CALIPER BOOTS



ALCAN OTOMOTIV NO. 4005

OEM NO. -

MODEL Pan 17.5

| No. | Ref. No. | Parça Adı / Part Name | Ölçü (mm) Dimensions | Adet Pcs. |
|-----|----------|--------------------------------------|----------------------|-----------|
| 1 | 1321 | Perno Toz Lastiği / Caliper Pin Boot | - | 1 |
| 2 | 1325 | Perno Toz Lastiği / Caliper Pin Boot | - | 2 |

TOZ KÖRÜĞÜ • CALIPER BOOTS



ALCAN OTOMOTIV NO. 4006

OEM NO. -

MODEL Pan 19.5

| No. | Ref. No. | Parça Adı / Part Name | Ölçü (mm) Dimensions | Adet Pcs. |
|-----|----------|--------------------------------------|----------------------|-----------|
| 1 | 1322 | Perno Toz Lastiği / Caliper Pin Boot | - | 2 |
| 2 | 1321 | Perno Toz Lastiği / Caliper Pin Boot | - | 1 |
| 3 | 1929 | Pul / Washer | - | 2 |



ALCAN OTOMOTIV

CALIPER SYSTEMS

KALİPER TAMİR TAKIMI • CALIPER REPAIR KIT



| ALCAN OTOMOTIV NO. | 4007 | | | |
|--------------------|----------|--------------------------------------|----------------------|-----------|
| OEM NO. | - | | | |
| MODEL | Pan 17.5 | | | |
| No. | Ref. No. | Parça Adı / Part Name | Ölçü (mm) Dimensions | Adet Pcs. |
| 1 | 1325 | Perno Toz Lastiği / Caliper Pin Boot | - | 2 |
| 2 | 1425 | Burç / Bush | Ø 30 x 34 / 20 mm | 2 |
| 3 | 1321 | Perno Toz Lastiği / Caliper Pin Boot | - | 1 |
| 4 | 1516 | Perno Kapağı / Pin Cap | Ø 34 / 17 mm | 2 |
| 5 | 1430 | Burç / Bush | Ø 30 x 34 / 35 mm | 1 |

KALİPER TAMİR TAKIMI • CALIPER REPAIR KIT



| ALCAN OTOMOTIV NO. | 4008 | | | |
|--------------------|----------|--------------------------------------|----------------------|-----------|
| OEM NO. | - | | | |
| MODEL | Pan 19.5 | | | |
| No. | Ref. No. | Parça Adı / Part Name | Ölçü (mm) Dimensions | Adet Pcs. |
| 1 | 1322 | Perno Toz Lastiği / Caliper Pin Boot | - | 3 |
| 2 | 1428 | Perno Burcu / Pin Bush | Ø 38 x 42 / 30 mm | 2 |
| 3 | 1321 | Perno Toz Lastiği / Caliper Pin Boot | - | 1 |
| 4 | 1512 | Perno Kapağı / Pin Cap | Ø 42 / 17 mm | 1 |
| 5 | 1513 | Perno Kapağı / Pin Cap | Ø 42 / 28 mm | 1 |

KALİPER AYAR MEKANİZMA 109MM • CALIPER ADJUSTING MECHANISM 109MM



| ALCAN OTOMOTIV NO. | 4009 | | | |
|--------------------|----------|-----------------------|----------------------|-----------|
| OEM NO. | - | | | |
| MODEL | Pan 17.5 | | | |
| No. | Ref. No. | Parça Adı / Part Name | Ölçü (mm) Dimensions | Adet Pcs. |
| 1 | 4009 | Mekanizma / Mechanism | 109 mm | 1 |

KALİPER AYAR MEKANİZMA 115MM • CALIPER ADJUSTING MECHANISM 115MM



| ALCAN OTOMOTIV NO. | 4010 | | | |
|--------------------|----------|------------------------------------|----------------------|-----------|
| OEM NO. | - | | | |
| MODEL | Pan 19.5 | | | |
| No. | Ref. No. | Parça Adı / Part Name | Ölçü (mm) Dimensions | Adet Pcs. |
| 1 | 4010 | Kaliper Ayar Mekanizma / Mechanism | 115 mm | 1 |



ALCAN OTOMOTIV

CALIPER SYSTEMS

KALİPER AYAR MEKANİZMA 109MM (MONTAJLI) • CALIPER ADJUSTING MECHANISM 109MM (ASSEMBLY)



| | |
|--------------------|----------|
| ALCAN OTOMOTIV NO. | 4011 |
| OEM NO. | - |
| MODEL | Pan 17.5 |

| No. | Ref. No. | Parça Adı / Part Name | Ölçü (mm) Dimensions | Adet Pcs. |
|-----|----------|---|----------------------|-----------|
| 1 | 4009 | Mekanizma / Mechanism | 109 mm | 1 |
| 2 | 1845 | Kaliper Dürbünü / Caliper Shaft Housing | - | 1 |
| 3 | 1709 | Yay / Spring | - | 2 |

KALİPER AYAR MEKANİZMA 115MM (MONTAJLI) • CALIPER ADJUSTING MECHANISM 115MM (ASSEMBLY)



| | |
|--------------------|----------|
| ALCAN OTOMOTIV NO. | 4012 |
| OEM NO. | - |
| MODEL | Pan 19.5 |

| No. | Ref. No. | Parça Adı / Part Name | Ölçü (mm) Dimensions | Adet Pcs. |
|-----|----------|---|----------------------|-----------|
| 1 | 4010 | Mekanizma / Mechanism | 115 mm | 1 |
| 2 | 1846 | Kaliper Dürbünü / Caliper Shaft Housing | - | 1 |
| 3 | 1709 | Yay / Spring | - | 2 |

KALİPER HAREKET KOLU • CALIPER LEVER



| | |
|--------------------|--------------------|
| ALCAN OTOMOTIV NO. | 4013 |
| OEM NO. | - |
| MODEL | Pan 17.5, Pan 19.5 |

| No. | Ref. No. | Parça Adı / Part Name | Ölçü (mm) Dimensions | Adet Pcs. |
|-----|----------|------------------------------|----------------------|-----------|
| 1 | 4013 | Kaliper Hareket Kolu / Lever | - | 1 |

AYAR MEKANİZMASI PUL VE YAY TAKIMI • ADJUSTING MECHANISM WASHER & SPRING SET

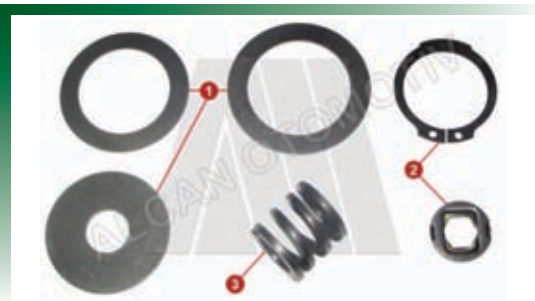

| | |
|--------------------|--------------------|
| ALCAN OTOMOTIV NO. | 4014 |
| OEM NO. | - |
| MODEL | Pan 17.5, Pan 19.5 |

| No. | Ref. No. | Parça Adı / Part Name | Ölçü (mm) Dimensions | Adet Pcs. |
|-----|----------|---------------------------|----------------------|-----------|
| 1 | 1845 | Pul Takımı / Clutch Plate | - | 3 |
| 2 | 1930 | Segman / Clips | - | 2 |
| 3 | 1710 | Yay / Spring | - | 1 |



ALCAN OTOMOTIV

CALIPER SYSTEMS

KALİPER KAPAK CONTA SETİ • CALIPER HEAD GASKET SET

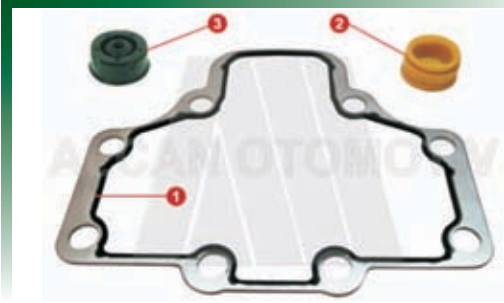

| ALCAN OTOMOTIV NO. | 4017 | | | |
|--------------------|--------------------|-----------------------------|----------------------|-----------|
| OEM NO. | - | | | |
| MODEL | Pan 17.5, Pan 19.5 | | | |
| No. | Ref. No. | Parça Adı / Part Name | Ölçü (mm) Dimensions | Adet Pcs. |
| 1 | 1932 | Kapak Contası / Head Gasket | - | 1 |
| 2 | 1515 | Conta / Seal | - | 1 |
| 3 | 1933 | Kapak Keçesi / Head Seal | - | 1 |

AYAR MEKANİZMA CİVATASI (87MM) • CALIPER CALIBRATION BOLT (87MM)



| ALCAN OTOMOTIV NO. | 4018 | | | |
|--------------------|----------|---------------------------------------|----------------------|-----------|
| OEM NO. | - | | | |
| MODEL | Pan 17.5 | | | |
| No. | Ref. No. | Parça Adı / Part Name | Ölçü (mm) Dimensions | Adet Pcs. |
| 1 | 1848 | Mekanizma Cıvatası / Calibration Bolt | 87 mm | 1 |

AYAR MEKANİZMA CİVATASI (91MM) • CALIPER CALIBRATION BOLT (91MM)



| ALCAN OTOMOTIV NO. | 4019 | | | |
|--------------------|----------|---------------------------------------|----------------------|-----------|
| OEM NO. | - | | | |
| MODEL | Pan 19.5 | | | |
| No. | Ref. No. | Parça Adı / Part Name | Ölçü (mm) Dimensions | Adet Pcs. |
| 1 | 1849 | Mekanizma Cıvatası / Calibration Bolt | 91 mm | 1 |

KALİPER İTENEK TAKIMI • BRAKE CALIPER TAPPET & BOOT SET



| ALCAN OTOMOTIV NO. | 4020 | | | |
|--------------------|--------------------|---|----------------------|-----------|
| OEM NO. | - | | | |
| MODEL | Pan 17.5, Pan 19.5 | | | |
| No. | Ref. No. | Parça Adı / Part Name | Ölçü (mm) Dimensions | Adet Pcs. |
| 1 | 1864 | Kaliper Körüklü tenek / Thrust Part With Bellow | - | 2 |

KALİPER TAMİR TAKIMI • CALIPER REPAIR KIT



| ALCAN OTOMOTIV NO. | 4021 | | | |
|--------------------|----------|---|----------------------|-----------|
| OEM NO. | - | | | |
| MODEL | Pan 19.5 | | | |
| No. | Ref. No. | Parça Adı / Part Name | Ölçü (mm) Dimensions | Adet Pcs. |
| 1 | 1864 | Kaliper Körüklü tenek / Thrust Part With Bellow | - | 2 |
| 2 | 1328 | Perno Toz Lasti i / Caliper Pin Boot | - | 2 |
| 3 | 1929 | Pul / Washer | - | 2 |



ALCAN OTOMOTIV

CALIPER SYSTEMS

KALİPER TAMİR TAKIMI • CALIPER REPAIR KIT



| | |
|--------------------|-------------------------------|
| ALCAN OTOMOTIV NO. | 4022 |
| OEM NO. | 12999746, 1440505, 5001858722 |
| MODEL | Pan 19.5 |

| No. | Ref. No. | Parça Adı / Part Name | Ölçü (mm) Dimensions | Adet Pcs. |
|-----|----------|---|-------------------------|--------------|
| 1 | 1128 | Perno / Pin | Ø 38 / 120 mm | 1 |
| 2 | 1127 | Perno / Pin | Ø 38 / 76 mm | 1 |
| 3 | 1217 | Civata / Screw | M16 x 1.5 / 80 mm | 1 |
| 4 | 1220 | Civata / Screw | M16 x 1.5 / 120 mm | 1 |
| 5 | 1864 | Kaliper Körüklü tenek / Thrust Part With Bellow | - | 2 |
| 6 | 1512 | Perno Kapağı / Pin Cap | Ø 42 / 17 mm | 1 |
| 7 | 1513 | Perno Kapağı / Pin Cap | Ø 42 / 28 mm | 1 |
| 8 | 1428 | Perno Burcu / Pin Bush | Ø 38 x 42 / 30 mm | 3 |
| 9 | 1328 | Perno Toz Lastiği / Caliper Pin Boot | - | 2 |
| 10 | 1929 | Pul / Washer | - | 2 |
| 11 | 1515 | Conta / Seal | - | 2 |

ALCAN OTOMOTIV

CALIPER SYSTEMS



**HALDEX
SERIES**



ALCAN OTOMOTIV

CALIPER SYSTEMS

KALİPER TAMİR TAKIMI • CALIPER REPAIR KIT



| ALCAN OTOMOTIV NO. | 5001 | | | |
|--------------------|--------------------------------------|--------------------------------------|----------------------|-----------|
| OEM NO. | 89794 | | | |
| MODEL | Mark II, Mark III, Mark IV, Module X | | | |
| No. | Ref. No. | Parça Adı / Part Name | Ölçü (mm) Dimensions | Adet Pcs. |
| 1 | 1711 | Yay / Spring | - | 2 |
| 2 | 1326 | Perno Toz Lasti i / Caliper Pin Boot | - | 2 |

KALİPER TAMİR TAKIMI • CALIPER REPAIR KIT



| ALCAN OTOMOTIV NO. | 5002 | | | |
|--------------------|-------------|--------------------------------------|----------------------|-----------|
| OEM NO. | 91013 | | | |
| MODEL | Module X | | | |
| No. | Ref. No. | Parça Adı / Part Name | Ölçü (mm) Dimensions | Adet Pcs. |
| 1 | 1327 | Perno Toz Lasti i / Caliper Pin Boot | - | 6 |

ALCAN OTOMOTIV

CALIPER SYSTEMS



Z-CAM
SERIES



ALCAN OTOMOTIV

CALIPER SYSTEMS

AYAR DIŞLİSİ TAMİR TAKIMI (SOL) • ADJUSTING GEAR REPAIR KIT (LEFT)



| | |
|--------------------|---|
| ALCAN OTOMOTIV NO. | D002 |
| OEM NO. | 272909, 3097099, 8550978 |
| MODEL | VOLVO (F12-FH12/16-FL7/10-NL10/12-B10/12) |

| No. | Ref. No. | Parça Adı / Part Name | Ölçü (mm) Dimensions | Adet Pcs. |
|-----|----------|---|----------------------|-----------|
| 1 | D002 | Ayar Dişlisi Tamir Takımı (Sol) / Adjusting Gear (Left) | - | 1 |

AYAR DIŞLİSİ TAMİR TAKIMI (SAĞ) • ADJUSTING GEAR REPAIR KIT (RIGHT)



| | |
|--------------------|---|
| ALCAN OTOMOTIV NO. | D001 |
| OEM NO. | 272908, 3097100, 8550977 |
| MODEL | VOLVO (F12-FH12/16-FL7/10-NL10/12-B10/12) |

| No. | Ref. No. | Parça Adı / Part Name | Ölçü (mm) Dimensions | Adet Pcs. |
|-----|----------|--|----------------------|-----------|
| 1 | D001 | Ayar Dişlisi Tamir Takımı (Sağ) / Adjusting Gear (Right) | - | 1 |

KİLİTLEME SACI TAMİR TAKIMI (SOL) • REVERSE LOCK REPAIR KIT (LEFT)



| | |
|--------------------|---|
| ALCAN OTOMOTIV NO. | D011 |
| OEM NO. | 276097 |
| MODEL | VOLVO (F12-FH12/16-FL7/10-NL10/12-B10/12) |

| No. | Ref. No. | Parça Adı / Part Name | Ölçü (mm) Dimensions | Adet Pcs. |
|-----|----------|---------------------------------|----------------------|-----------|
| 1 | 1801 | Kilitleme Sacı / Locking plate | - | 1 |
| 1 | 1701 | Kilitleme Yayı / Locking Spring | - | 1 |

KİLİTLEME SACI TAMİR TAKIMI (SAĞ) • REVERSE LOCK REPAIR KIT (RIGHT)



| | |
|--------------------|---|
| ALCAN OTOMOTIV NO. | D010 |
| OEM NO. | 276098 |
| MODEL | VOLVO (F12-FH12/16-FL7/10-NL10/12-B10/12) |

| No. | Ref. No. | Parça Adı / Part Name | Ölçü (mm) Dimensions | Adet Pcs. |
|-----|----------|---------------------------------|----------------------|-----------|
| 1 | 1802 | Kilitleme Sacı / Locking plate | - | 1 |
| 1 | 1702 | Kilitleme Yayı / Locking Spring | - | 1 |



ALCAN OTOMOTIV

CALIPER SYSTEMS

KİLİT KAPAK TAMİR TAKIMI (14 DİŞ) • LOCK CAP REPAIR KIT (14 TEETH)



| | |
|--------------------|---|
| ALCAN OTOMOTIV NO. | E029 |
| OEM NO. | 276099 |
| MODEL | VOLVO (F12-FH12/16-FL7/10-NL10/12-B10/12) |

| No. | Ref. No. | Parça Adı / Part Name | Ölçü (mm) Dimensions | Adet Pcs. |
|-----|----------|---|----------------------|-----------|
| 1 | 1804 | Ayar Dişi 14 Diş / Setting teeth 14 teeth | - | 1 |
| 2 | 1803 | Ayar Civatası / Setting Screw | - | 1 |
| 3 | 1301 | Soket Contası / Adjuster Seal | - | 1 |
| 4 | 1302 | Küçük Conta / Small Seal | - | 1 |
| 5 | 1303 | Büyük Conta / Big Seal | - | 1 |

KİLİT KAPAK TAMİR TAKIMI (23 DİŞ) • LOCK CAP REPAIR KIT (23 TEETH)



| | |
|--------------------|---|
| ALCAN OTOMOTIV NO. | E028 |
| OEM NO. | 276100, 3090964 |
| MODEL | VOLVO (F12-FH12/16-FL7/10-NL10/12-B10/12) |

| No. | Ref. No. | Parça Adı / Part Name | Ölçü (mm) Dimensions | Adet Pcs. |
|-----|----------|---|----------------------|-----------|
| 1 | 1805 | Ayar Dişi 23 Diş / Setting teeth 23 teeth | - | 1 |
| 2 | 1803 | Ayar Civatası / Setting Screw | - | 1 |
| 3 | 1301 | Soket Contası / Adjuster Seal | - | 1 |
| 4 | 1302 | Küçük Conta / Small Seal | - | 1 |
| 5 | 1303 | Büyük Conta / Big Seal | - | 1 |

CONTA TAKIMI • GASKET KIT



| | |
|--------------------|---|
| ALCAN OTOMOTIV NO. | E027 |
| OEM NO. | 272905 |
| MODEL | VOLVO (F12-FH12/16-FL7/10-NL10/12-B10/12) |

| No. | Ref. No. | Parça Adı / Part Name | Ölçü (mm) Dimensions | Adet Pcs. |
|-----|----------|-----------------------|----------------------|-----------|
| 1 | 1901 | Keçe / Felt | - | 1 |
| 2 | 1902 | Conta / Seal | - | 1 |
| 3 | 1903 | Conta / Seal | - | 1 |
| 4 | 1306 | Conta / Seal | - | 1 |
| 5 | 1304 | Conta / Seal | - | 2 |
| 6 | 1305 | Conta / Seal | - | 1 |



ALCAN OTOMOTIV

CALIPER SYSTEMS

ÇAPRAZ DİŞLİ • CROSS SHAFT

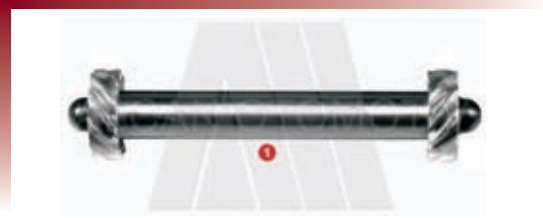

| | |
|--------------------|---|
| ALCAN OTOMOTIV NO. | D005 |
| OEM NO. | 272910 |
| MODEL | VOLVO (F12-FH12/16-FL7/10-NL10/12-B10/12) |

| No. | Ref. No. | Parça Adı / Part Name | Ölçü (mm) Dimensions | Adet Pcs. |
|-----|----------|----------------------------|----------------------|-----------|
| 1 | D005 | Çapraz Dişli / Cross Shaft | - | 1 |

AYAR PİNYONU (SOL) • ADJUSTING PINION (LEFT)



| | |
|--------------------|--------------------------------|
| ALCAN OTOMOTIV NO. | E024 |
| OEM NO. | 3090997, 1081819 |
| MODEL | VOLVO (NL10/12-B10/12-FH12/16) |

| No. | Ref. No. | Parça Adı / Part Name | Ölçü (mm) Dimensions | Adet Pcs. |
|-----|----------|--|----------------------|-----------|
| 1 | E024 | Ayar Pinyonu (Sol) / Adjusting Pinion (Left) | - | 1 |

AYAR PİNYONU (SAĞ) • ADJUSTING PINION (RIGHT)



| | |
|--------------------|--------------------------------|
| ALCAN OTOMOTIV NO. | E023 |
| OEM NO. | 3090998, 1081820 |
| MODEL | VOLVO (NL10/12-B10/12-FH12/16) |

| No. | Ref. No. | Parça Adı / Part Name | Ölçü (mm) Dimensions | Adet Pcs. |
|-----|----------|---|----------------------|-----------|
| 1 | E023 | Ayar Pinyonu (Sağ) / Adjusting Pinion (Right) | - | 1 |

PİNYON (SOL) • PINION (LEFT)



| | |
|--------------------|--------------------------------------|
| ALCAN OTOMOTIV NO. | D017 |
| OEM NO. | 1696924, 272906 |
| MODEL | VOLVO (F12-FH-FL7/10-NL10/12-B10/12) |

| No. | Ref. No. | Parça Adı / Part Name | Ölçü (mm) Dimensions | Adet Pcs. |
|-----|----------|------------------------------|----------------------|-----------|
| 1 | D017 | Pinyon (Sol) / Pinion (Left) | - | 1 |

PİNYON (SAĞ) • PINION (RIGHT)



| | |
|--------------------|--------------------------------------|
| ALCAN OTOMOTIV NO. | D016 |
| OEM NO. | 1696925, 272907 |
| MODEL | VOLVO (F12-FH-FL7/10-NL10/12-B10/12) |

| No. | Ref. No. | Parça Adı / Part Name | Ölçü (mm) Dimensions | Adet Pcs. |
|-----|----------|-------------------------------|----------------------|-----------|
| 1 | D016 | Pinyon (Sağ) / Pinion (Right) | - | 1 |



ALCAN OTOMOTIV

CALIPER SYSTEMS

İTİCİ PİM • THRUST PIN



| ALCAN OTOMOTIV NO. | D007 | | | |
|--------------------|--------------------------------------|------------------------|----------------------|-----------|
| OEM NO. | 1696446 | | | |
| MODEL | VOLVO (F12-FH-FL7/10-NL10/12-B10/12) | | | |
| No. | Ref. No. | Parça Adı / Part Name | Ölçü (mm) Dimensions | Adet Pcs. |
| 1 | D007 | İtici Pim / Thrust Pin | - | 1 |

GERİ DÖNÜŞ YAYI PİMİ • RETURN SPRING PIN

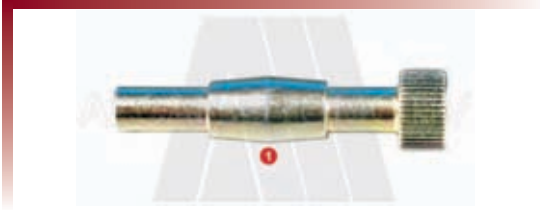

| ALCAN OTOMOTIV NO. | D009 | | | |
|--------------------|--------------------------------------|---|----------------------|-----------|
| OEM NO. | 3097299, 1698346 | | | |
| MODEL | VOLVO (F12-FH-FL7/10-NL10/12-B10/12) | | | |
| No. | Ref. No. | Parça Adı / Part Name | Ölçü (mm) Dimensions | Adet Pcs. |
| 1 | D009 | Geri Dönüş Yay Pimi / Return Spring Pin | - | 1 |

KAPAK • COVER



| ALCAN OTOMOTIV NO. | D012 | | | |
|--------------------|--------------------------------------|-----------------------|----------------------|-----------|
| OEM NO. | 1696449 | | | |
| MODEL | VOLVO (F12-FH-FL7/10-NL10/12-B10/12) | | | |
| No. | Ref. No. | Parça Adı / Part Name | Ölçü (mm) Dimensions | Adet Pcs. |
| 1 | D012 | Kapak / Cover | - | 1 |

INDEX

| MERITOR | | MERITOR | | MERITOR | | KNORR | | KNORR | |
|-------------------|---------------------|-------------------|---------------------|-------------------|---------------------|-------------------|---------------------|-------------------|---------------------|
| KOD NO CODE NO | SAYFA NO PAGE NO | KOD NO CODE NO | SAYFA NO PAGE NO | KOD NO CODE NO | SAYFA NO PAGE NO | KOD NO CODE NO | SAYFA NO PAGE NO | KOD NO CODE NO | SAYFA NO PAGE NO |
| 2001 | 22 | 2033 | 7 | 2066 | 11 | 3001 | 30 | 3033 | 41 |
| 2002 | 16 | 2034 | 18 | 2067 | 24 | 3002 | 30 | 3034 | 41 |
| 2003 | 4 | 2035 | 10 | 2068 | 24 | 3003 | 31 | 3035 | 42 |
| 2004 | 4 | 2036 | 26 | 2069 | 25 | 3004 | 31 | 3036 | 42 |
| 2005 | 4 | 2037 | 10 | 2070 | 25 | 3005 | 32 | 3037 | 42 |
| 2006 | 4 | 2038 | 11 | 2071 | 26 | 3006 | 33 | 3038 | 43 |
| 2007 | 5 | 2039 | 11 | 2072 | 25 | 3007 | 33 | 3039 | 43 |
| 2008 | 5 | 2040 | 12 | 2073 | 24 | 3008 | 34 | 3040 | 42 |
| 2009 | 5 | 2041 | 21 | 2074 | 19 | 3009 | 34 | 3041 | 44 |
| 2010 | 6 | 2042 | 21 | 2075 | 7 | 3010 | 35 | 3042 | 44 |
| 2011 | 23 | 2043 | 24 | 2076 | 15 | 3011 | 35 | 3043 | 44 |
| 2012 | 23 | 2044 | 13 | 2077 | 16 | 3012 | 36 | 3044 | 44 |
| 2013 | 8 | 2045 | 18 | 2078 | 17 | 3013 | 36 | 3045 | 45 |
| 2014 | 8 | 2046 | 14 | 2079 | 17 | 3014 | 37 | 3046 | 43 |
| 2015 | 8 | 2047 | 14 | 2080 | 17 | 3015 | 37 | 3047 | 43 |
| 2016 | 9 | 2048 | 15 | 2081 | 25 | 3016 | 37 | 3048 | 43 |
| 2017 | 9 | 2049 | 7 | 2082 | 20 | 3017 | 37 | 3049 | 40 |
| 2018 | 9 | 2050 | 18 | 2083 | 21 | 3018 | 37 | 3050 | 45 |
| 2019 | 12 | 2051 | 23 | 2084 | 21 | 3019 | 38 | 3051 | 45 |
| 2020 | 12 | 2053 | 12 | 2085 | 22 | 3020 | 38 | 3052 | 45 |
| 2021 | 12 | 2054 | 7 | 2086 | 22 | 3021 | 38 | 3053 | 45 |
| 2022 | 13 | 2055 | 7 | 2087 | 19 | 3022 | 38 | 3054 | 45 |
| 2023 | 13 | 2056 | 8 | 2088 | 27 | 3023 | 39 | 3055 | 32 |
| 2024 | 14 | 2057 | 15 | 2089 | 27 | 3024 | 39 | 3056 | 36 |
| 2025 | 14 | 2058 | 15 | 2090 | 27 | 3025 | 39 | | |
| 2026 | 15 | 2059 | 23 | 2091 | 28 | 3026 | 39 | | |
| 2027 | 20 | 2060 | 6 | 2092 | 28 | 3027 | 39 | | |
| 2028 | 19 | 2061 | 6 | 2093 | 24 | 3028 | 40 | | |
| 2029 | 9 | 2062 | 10 | 2094 | 28 | 3029 | 40 | | |
| 2030 | 20 | 2063 | 10 | 2095 | 22 | 3030 | 40 | | |
| 2031 | 26 | 2064 | 11 | | | 3031 | 41 | | |
| 2032 | 16 | 2065 | 11 | | | 3032 | 41 | | |



CALIPER SYSTEMS



www.alcanotomotiv.com



ALCAN OTOMOTIV

ALCAN OTOMOTIV SANAYİ VE TİCARET LTD. ŞTİ.

351 Sokak No: 34 Kazim Dirik Mah. 2. Sanayi Sitesi Bornova - İZMİR / TÜRKİYE
Telephone : 0090 232 486 66 89 • 0090 232 461 51 82 / Fax : 0090 232 486 08 95

Email: export@alcanotomotiv.com • oguz@alcanotomotiv.com

www.alcanotomotiv.com

BU TANITIM UNSURU KOSGEB DESTEĞİYLE HAZIRLANMIŞTIR.



KOSGEB

T.C.BİLİM, SANAYİ ve TEKNOLOJİ BAKANLIĞI
KÜÇÜK VE ORTA ÖLÇEKLİ İŞLETMELERİ
GELİŞTİRME VE DESTEKLEME İDARESİ BAŞKANLIĞI

www.kosgeb.gov.tr

BASIM YERİ

MET MATBAACILIK

1145/1 Sokak No:51 Yenisehir/İZMİR

Tel.:0.232.433 59 57 www.metambalaj.com

Basım Tarihi : MART 2012