

# CALIPER

MERITOR-ROR

KNORR

WABCO

HALDEX

OTHER TYPE CALIPERS

UNIVERSAL PARTS

we keep your business **on the move**

CALIPER  
MERITOR-ROR  
**KNORR**

WABCO

HALDEX









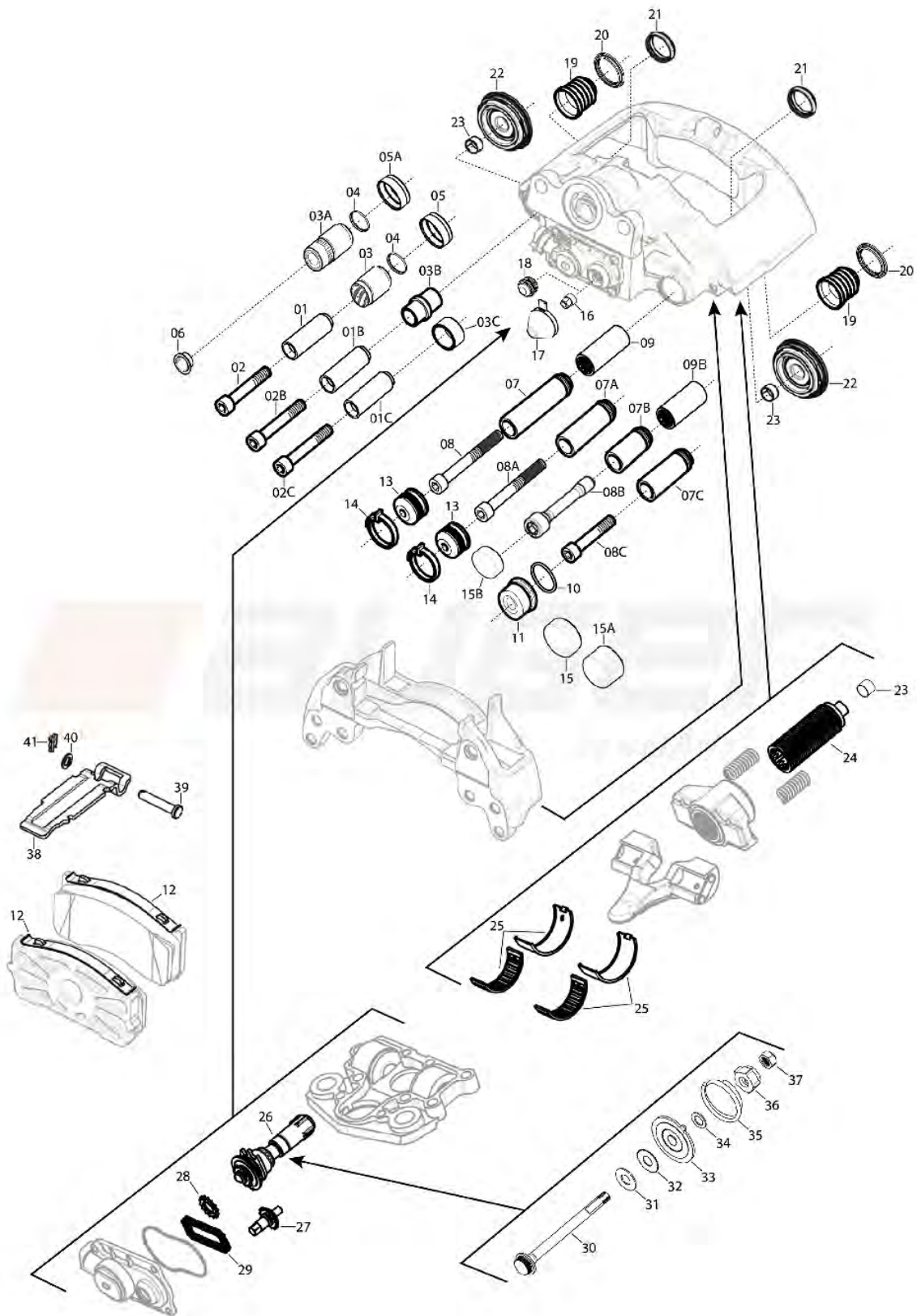









OTHER TYPE CALIPERS

UNIVERSAL PARTS

we keep your business **on the move**





















Spare Parts



| Sr. | Auger Nr. | O.E.M. Nr. | Description                                    | Picture   | Sr. | Auger Nr. | O.E.M. Nr. | Description                                    | Picture   |
|-----|-----------|------------|--|---|-----|-----------|------------|--|---|
| 01  | 60373     | -          | Pin<br>ø32x80                                  |    | 01  | 72762     | -          | Pin<br>ø32x84                                  |    |
| 01B | 72704     | -          | Pin<br>ø34x80                                  |    | 01C | 72717     | -          | Pin<br>ø29,7x71,5                              |    |
| 02  | 55299     | -          | Socket Head Bolt<br>(12.9 Grade)<br>M16x1.5/80 |    | 02  | 55307     | -          | Socket Head Bolt<br>(10.9 Grade)<br>M16x1.5/80 |    |
| 02  | 72779     | -          | Socket Head Bolt<br>(10.9 Grade)<br>M16x1.5/80 |    | 02B | 55306     | -          | Socket Head Bolt<br>M16x1.5/86,5               |    |
| 02C | 55311     | -          | Socket Head Bolt<br>M16x1.5/75                 |  | 03  | 55345     | -          | Rubber Bearing<br>ø32xø40x46                   |  |
| 03A | 55376     | -          | Rubber Bearing<br>ø25/ø32xø40x61,5             |  | 03B | 55344     | -          | Rubber Seal<br>ø33,5xø40x48,5                  |  |
| 03C | 55292     | -          | Bushing<br>ø30xø34x20                          |  | 04  | 72669     | -          | Plastic Bearing<br>ø32,5xø36,3x4               |  |
| 05  | 72805     | -          | Machined Washer<br>ø39/ø40x15                  |  | 05A | 72806     | -          | Machined Washer<br>ø35/ø40x14,5                |  |
| 06  | 60481     | -          | Cover<br>ø26,1x11                              |  | 07  | 72705     | -          | Pin<br>ø36x145                                 |  |
| 07  | 72707     | -          | Pin<br>ø36x134                                 |  | 07B | 72718     | -          | Pin<br>ø30x99                                  |  |







| Sr. | Auger Nr. | O.E.M. Nr. | Description                      | Picture | Sr. | Auger Nr. | O.E.M. Nr. | Description                     | Picture |
|-----|-----------|------------|----------------------------------|---------|-----|-----------|------------|---------------------------------|---------|
| 07C | 60372     | -          | Pin<br>ø36x114                   |         | 07C | 72708     | -          | Pin<br>ø36x102                  |         |
| 07C | 72764     | -          | Pin<br>ø36x103                   |         | 08  | 55308     | -          | Socket Head Bolt<br>M16x1.5/150 |         |
| 08A | 55310     | -          | Socket Head Bolt<br>M16x1.5/140  |         | 08B | 72788     | -          | Socket Head Bolt<br>M16x1.5/105 |         |
| 08C | 55306     | -          | Socket Head Bolt<br>M16x1.5/86,5 |         | 08C | 57607     | -          | Socket Head Bolt<br>M16x1.5/85  |         |
| 09  | 60533     | -          | Bushing<br>ø36xø40x82            |         | 09  | 72999     | -          | Bushing<br>ø36xø40x70,5         |         |
| 09  | 73000     | -          | Bushing<br>ø36xø40x70            |         | 09B | 73003     | -          | Bushing<br>ø30xø34x64,5         |         |
| 10  | 60115     | -          | O-Ring<br>ø2,65xø47,5            |         | 11  | 60480     | -          | Cover<br>ø52/ø48x28             |         |
| 12  | 68091     | -          | Spring Holder                    |         | 13  | 55380     | -          | Rubber Dust Cap<br>ø47          |         |
| 13  | 55381     | -          | Rubber Dust Cap<br>ø46,5/ø50,5   |         | 13  | 55378     | -          | Rubber Seal<br>ø46xø50          |         |
| 14  | 72847     | -          | Metal Clamp<br>ø53,5             |         | 15  | 72869     | -          | Cover<br>ø40x10,5               |         |

| Sr. | Auger Nr. | O.E.M. Nr. | Description                                | Picture   | Sr. | Auger Nr. | O.E.M. Nr. | Description                        | Picture   |
|-----|-----------|------------|--|---|-----|-----------|------------|------------------------------------|---|
| 15A | 60485     | -          | Cover<br>ø40x14,5                          |    | 15B | 72873     | -          | Cover<br>ø34,2x13,3                |    |
| 16  | 73062     | -          | Adjuster                                   |    | 17  | 73186     | -          | Rubber Dust Cap<br>ø35             |    |
| 17  | 73184     | -          | Rubber Dust Cap<br>ø38                     |    | 18  | 72686     | -          | Plug                               |    |
| 18  | 60565     | K001276    | Plug<br>ø14,5                              |    | 19  | 55331     | K019508    | Rubber Seal<br>ø30xø48,75          |    |
| 19  | 55336     | -          | Rubber Seal<br>ø29xø46,5                   |  | 19  | 55333     | -          | Rubber Seal<br>ø24xø40             |  |
| 20  | 60353     | -          | Plastic Washer<br>ø36,5xø48,75x5,5         |  | 21  | 72671     | -          | Plastic Washer<br>ø30,7xø36,6x5    |  |
| 22  | 55349     | -          | Seal Boot<br>ø69,3                         |  | 22  | 55347     | -          | Seal Boot<br>ø74,5                 |  |
| 23  | 72998     | -          | Bushing<br>ø16xø18x10                      |  | 24  | 56008     | -          | Adjuster Bolt<br>M36x6 P3 x 79/100 |  |
| 25  | 72856     | -          | Half Needle Roller Bearing<br>ø56,2xø65x28 |  | 26  | 57175     | -          | Adjusting Mechanism<br>ø44x111,5   |  |
| 27  | 57176     | -          | Adjusting Gear<br>ø29x43,5                 |  | 27  | 70826     | -          | Pinion Gear                        |  |

| Sr.   | Auger Nr. | O.E.M. Nr. | Description                 | Picture   | Sr.   | Auger Nr. | O.E.M. Nr. | Description                      | Picture   |
|-------|-----------|------------|-----------------------------|---|-------|-----------|------------|----------------------------------|---|
| 28    | 57177     | -          | Adjusting Gear<br>ø15xø29x3 |    | 29    | 56007     | -          | Roller Chain<br>DIN 8187/1-04-24 |    |
| 30    | 72696     | -          | Special Bolts<br>M8x112     |    | 31    | 72978     | -          | Gasket<br>ø9,5xø21x1             |    |
| 32    | 72823     | -          | Toothed Lock Washer         |    | 33    | 73192     | -          | Lock Plate<br>ø9xø44x7           |    |
| 34    | 72824     | -          | Washer<br>ø9xø15x1          |    | 35    | 73041     | -          | Spring                           |    |
| 36    | 73097     | -          | Lock Washer                 |  | 37    | 72800     | -          | Lock Nut<br>M8x1/8               |  |
| 38    | 72906     | -          | Retaining Plate             |  | 39    | 72748     | -          | Pin<br>ø10x52                    |  |
| 40    | 59752     | -          | Washer<br>ø10,5xø20x2       |  | 41    | 72797     | -          | Split pin                        |  |
| 60574 | 32793     | -          | Lubricant                   |   | 60585 | -         | Lubricant  |                                  |   |
| 60575 | 1114525   | -          | Lubricant                   |   | 73207 | -         | Lubricant  |                                  |   |

| Auger Nr.    | OEM Nr.                    | Description  | Model | Picture   |
|--------------|----------------------------|--|-------|---|
| <b>53878</b> | II304130065<br>II179320065 | Repair Kit, Brake Caliper<br>ø74,5                   |       |    |
| <b>54523</b> | K001929                    | Repair Kit, Brake Caliper<br>ø69,3                   |       |    |
| <b>56023</b> | II370760065                | Repair Kit, Brake Caliper<br>ø74,5                   |       |   |
| <b>56008</b> | -                          | Adjuster Bolt, Brake Caliper<br>M36x6 P3/ø25xø16x100 |       |  |
| <b>57175</b> | -                          | Adjusting Mechanism, Brake Caliper<br>ø44x111.5      |       |  |
| <b>56138</b> | -                          | Repair Kit, Brake Caliper                            |       |  |







| Auger Nr.    | OEM Nr.    | Description   | Model | Picture   |
|--------------|------------|---|-------|---|
| <b>57176</b> | -          | Adjusting Gear,<br>Brake Caliper<br><br>ø29x43.5    |       |    |
| <b>70826</b> | -          | Pinion Gear, Caliper                                |       |    |
| <b>57177</b> | -          | Adjusting Gear,<br>Brake Caliper<br><br>ø15xø29x3   |       |   |
| <b>56007</b> | -          | Roller Chain, Brake Caliper<br><br>DIN 8187/1-04-24 |       |  |
| <b>70359</b> | K000698    | Repair Kit, Brake Caliper                           |       |  |
| <b>71447</b> | K048389K50 | Repair Kit, Brake Caliper                           |       |  |

| Auger Nr.    | OEM Nr.    | Description               | Model | Picture   |
|--------------|------------|---------------------------|-------|---|
| <b>71448</b> | K048396K50 | Repair Kit, Brake Caliper |       |    |
| <b>70834</b> | K028451    | Repair Kit, Brake Caliper |       |    |
| <b>70835</b> | -          | Repair Kit, Brake Caliper |       |   |
| <b>56113</b> | -          | Repair Kit, Brake Caliper |       |  |
| <b>54071</b> | K001532    | Repair Kit, Brake Caliper |       |  |
| <b>53877</b> | K000687    | Repair Kit, Brake Caliper |       |  |

| Auger Nr.    | OEM Nr.                    | Description               | Model | Picture |
|--------------|----------------------------|---------------------------|-------|---------|
| <b>54685</b> | K000935                    | Repair Kit, Brake Caliper |       |         |
| <b>53884</b> | II197140062                | Repair Kit, Brake Caliper |       |         |
| <b>56057</b> | K000421                    | Repair Kit, Brake Caliper |       |         |
| <b>54686</b> | K000132<br>II350470062     | Repair Kit, Brake Caliper |       |         |
| <b>54524</b> | K001928                    | Repair Kit, Brake Caliper |       |         |
| <b>53886</b> | II197330062<br>II304130062 | Repair Kit, Brake Caliper |       |         |

| Auger Nr.    | OEM Nr.  | Description               | Model | Picture   |
|--------------|--|---------------------------|-------|---|
| <b>53887</b> | K001274  | Repair Kit, Brake Caliper |       |    |
| <b>53890</b> | II339680062<br>II328090062<br>II369100062<br>II328090061 | Repair Kit, Brake Caliper |       |    |
| <b>53875</b> | II368470064  | Repair Kit, Brake Caliper |       |   |
| <b>56065</b> | -  | Repair Kit, Brake Caliper |       |  |
| <b>54072</b> | K001301  | Repair Kit, Brake Caliper |       |  |
| <b>70830</b> | -  | Repair Kit, Brake Caliper |       |  |

| Auger Nr.    | OEM Nr. | Description               | Model | Picture   |
|--------------|---------|---------------------------|-------|---|
| <b>70831</b> | -       | Repair Kit, Brake Caliper |       |    |
| <b>70832</b> | -       | Repair Kit, Brake Caliper |       |    |
| <b>56084</b> | K000133 | Repair Kit, Brake Caliper |       |   |
| <b>70829</b> | -       | Repair Kit, Brake Caliper |       |  |
| <b>53880</b> | K000945 | Repair Kit, Brake Caliper |       |  |



06

# KNORR



## SB5 - SN5 TYPE CALIPER





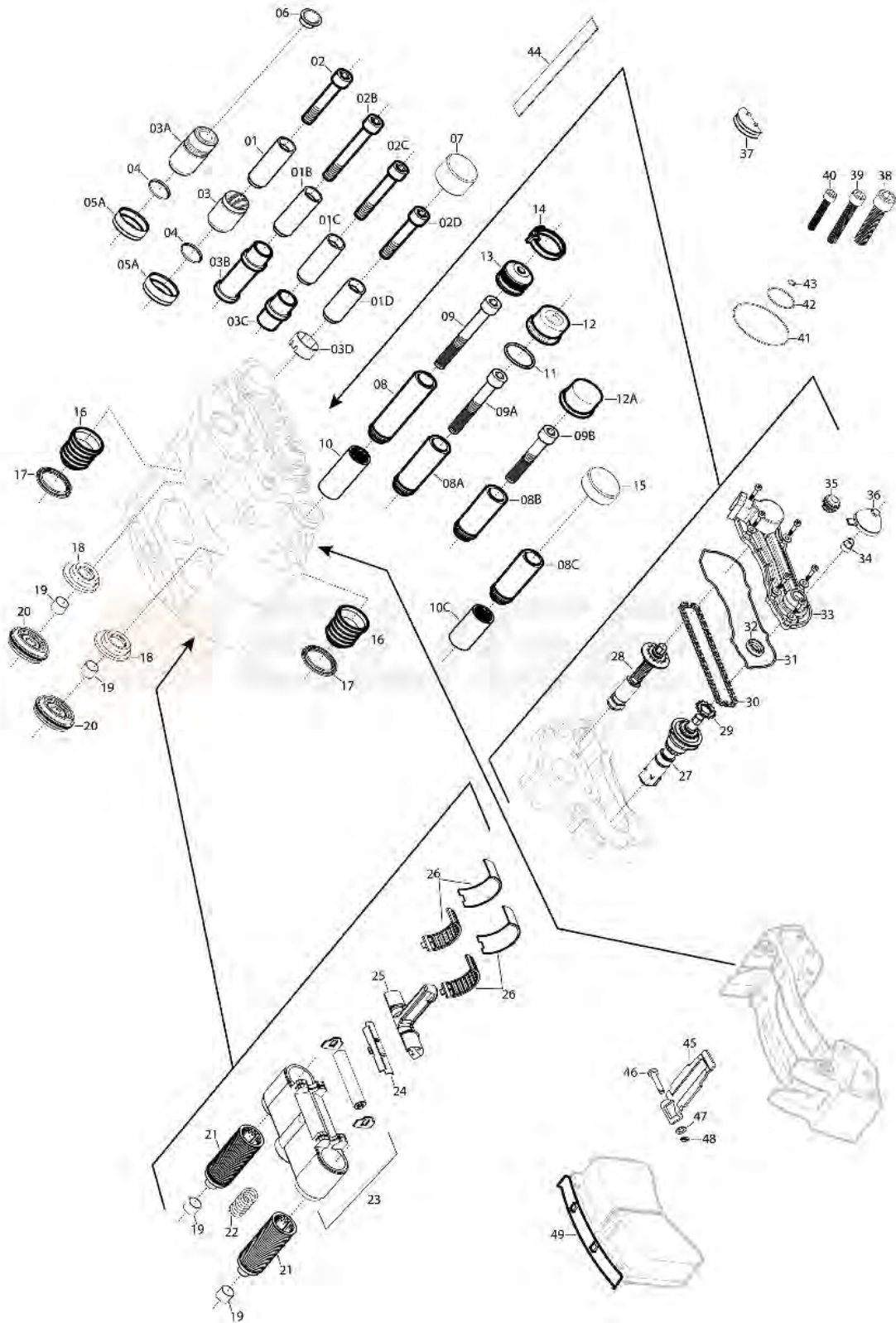

















| Auger Nr. | OEM Nr. | Description                               | Model | Picture |
|-----------|---------|---|-------|---------|
| 54068     | K000029 | Repair Kit, Brake Caliper                 |       |         |
| 54525     | K003902 | Repair Kit, Brake Caliper                 |       |         |
| 56112     | -       | Repair Kit, Brake Caliper                 |       |         |
| 56133     | -       | Repair Kit, Brake Caliper<br>ø56.2xø65x28 |       |         |

**Spare Parts**































| Sr. | Auger Nr. | O.E.M. Nr. | Description                                    | Picture   | Sr. | Auger Nr. | O.E.M. Nr. | Description                                    | Picture   |
|-----|-----------|------------|--|---|-----|-----------|------------|--|---|
| 01  | 60373     | -          | Pin<br>ø32x80                                  |    | 01  | 72762     | -          | Pin<br>ø32x84                                  |    |
| 01B | 72706     | -          | Pin<br>ø34x120                                 |    | 01C | 72704     | -          | Pin<br>ø34x80                                  |    |
| 01D | 72719     | -          | Pin<br>ø36x64                                  |    | 02  | 55299     | -          | Socket Head Bolt<br>(12.9 Grade)<br>M16x1.5/80 |    |
| 02  | 55307     | -          | Socket Head Bolt<br>(10.9 Grade)<br>M16x1.5/80 |    | 02  | 72779     | -          | Socket Head Bolt<br>(10.9 Grade)<br>M16x1.5/80 |    |
| 02B | 55309     | -          | Socket Head Bolt<br>M16x1.5/125                |  | 02C | 55306     | -          | Socket Head Bolt<br>M16x1.5/86,5               |  |
| 02D | 55312     | -          | Socket Head Bolt<br>M16x1.5/70                 |  | 03  | 55345     | -          | Rubber Bearing<br>ø32xø40x46                   |  |
| 03  | 73195     | -          | Rubber Bearing<br>ø32xø40x43,5                 |  | 03A | 55376     | -          | Rubber Bearing<br>ø25/ø32xø40x61,5             |  |
| 03B | 55377     | -          | Rubber Bearing<br>ø34,5                        |  | 03C | 55344     | -          | Rubber Seal<br>ø33,5xø40x48,5                  |  |
| 03D | 73004     | -          | Bushing<br>ø36xø40x20                          |  | 04  | 72669     | -          | Plastic Bearing<br>ø32,5xø36,3x4               |  |
| 05  | 72805     | -          | Machined Washer<br>ø39/ø40x15                  |  | 05  | 72833     | -          | Machined Washer<br>ø39/ø40x13,6                |  |



| Sr. | Auger Nr. | O.E.M. Nr. | Description                      | Picture   | Sr. | Auger Nr. | O.E.M. Nr. | Description                     | Picture   |
|-----|-----------|------------|----------------------------------|---|-----|-----------|------------|---------------------------------|---|
| 05A | 72806     | -          | Machined Washer<br>ø35/ø40x14,5  |    | 06  | 60481     | -          | Cover<br>ø26,1x11               |    |
| 07  | 72874     | -          | Cover<br>ø40x25                  |    | 08  | 72705     | -          | Pin<br>ø36x145                  |    |
| 08A | 72707     | -          | Pin<br>ø36x134                   |    | 08B | 60372     | -          | Pin<br>ø36x114                  |    |
| 08C | 72764     | -          | Pin<br>ø36x103                   |    | 09  | 55308     | -          | Socket Head Bolt<br>M16x1.5/150 |    |
| 09A | 55310     | -          | Socket Head Bolt<br>M16x1.5/140  |  | 09B | 57607     | -          | Socket Head Bolt<br>M16x1.5/85  |  |
| 09B | 55306     | -          | Socket Head Bolt<br>M16x1.5/86,5 |  | 10  | 60533     | -          | Bushing<br>ø36xø40x82           |  |
| 10C | 73000     | -          | Bushing<br>ø36xø40x70            |  | 11  | 60115     | -          | O-Ring<br>ø2,65xø47,5           |  |
| 12  | 60480     | -          | Cover<br>ø52/ø48x28              |  | 12A | 72937     | -          | Cover<br>ø41,5x36               |  |
| 13  | 55380     | -          | Rubber Dust Cap<br>ø47           |  | 13  | 55381     | -          | Rubber Dust Cap<br>ø46,5/ø50,5  |  |
| 13  | 55378     | -          | Rubber Seal<br>ø46xø50           |  | 14  | 72847     | -          | Metal Clamp<br>ø53,5            |  |

| Sr. | Auger Nr. | O.E.M. Nr. | Description                         | Picture   | Sr. | Auger Nr. | O.E.M. Nr. | Description                           | Picture   |
|-----|-----------|------------|-------------------------------------|---|-----|-----------|------------|---------------------------------------|---|
| 15  | 60485     | -          | Cover<br>ø40x14,5                   |    | 16  | 55331     | K019508    | Rubber Seal<br>ø30xø48,75             |    |
| 16  | 73194     | -          | Rubber Seal<br>ø26,5/ø32            |    | 16  | 55336     | -          | Rubber Seal<br>ø29xø46,5              |    |
| 17  | 60353     | -          | Plastic Washer<br>ø36,5xø48,75x5,5  |    | 17  | 72690     | -          | Plastic Washer<br>ø32,5xø48,75x5,5    |    |
| 18  | 55371     | K007198    | Rubber Seal<br>ø33/ø35xø64          |    | 18  | 55372     | -          | Rubber Seal<br>ø35xø64                |    |
| 19  | 72998     | -          | Bushing<br>ø16xø18x10               |  | 20  | 55347     | -          | Seal Boot<br>ø74,5                    |  |
| 20  | 57646     | -          | Seal Boot<br>ø74,3                  |  | 21  | 56008     | -          | Adjuster Bolt<br>M36x6 P3 x 79/100    |  |
| 22  | 73057     | -          | Spring<br>ø24x48                    |  | 23  | 57164     | -          | Bridge Assembly<br>M36x6 P3 x131x63,5 |  |
| 23  | 57165     | -          | Bridge Assembly<br>M36x6 P3 x131x80 |  | 23  | 57166     | -          | Bridge Assembly<br>M36x6 P3 x131x82   |  |
| 24  | 72934     | -          | Half Bearing<br>ø16,25xø19,25       |  | 25  | 57179     | -          | Lever                                 |  |
| 25  | 57181     | -          | Lever                               |  | 25  | 73160     | -          | Operating Shaft<br>Angle 12°          |  |



| Sr. | Auger Nr. | O.E.M. Nr. | Description                    | Picture   | Sr. | Auger Nr. | O.E.M. Nr. | Description                                | Picture   |
|-----|-----------|------------|--------------------------------|---|-----|-----------|------------|--|---|
| 25  | 73161     | -          | Operating Shaft<br>Angle 0°    |    | 26  | 72856     | -          | Half Needle Roller Bearing<br>ø56,2xø65x28 |    |
| 27  | 57163     | -          | Adjusting Mechanism            |    | 28  | 57162     | -          | Adjusting Mechanism                        |    |
| 29  | 57177     | -          | Adjusting Gear                 |    | 30  | 57182     | -          | Roller Chain                               |    |
| 31  | 72981     | -          | Rubber Gasket                  |    | 32  | 72955     | -          | Seal Ring<br>ø12xø25,5x5                   |    |
| 32  | 72956     | -          | Seal Ring<br>ø12xø25x5         |  | 31  | 57183     | -          | Cover                                      |  |
| 34  | 73062     | -          | Adjuster                       |  | 35  | 60565     | K001276    | Plug<br>ø14,5                              |  |
| 35  | 72686     | -          | Plug                           |  | 36  | 73184     | -          | Rubber Dust Cap<br>ø38                     |  |
| 37  | 73198     | -          | Rubber Buffer                  |  | 38  | 57611     | -          | Socket Head Bolt<br>M14x2/55               |  |
| 39  | 57610     | -          | Socket Head Bolt<br>M10x1.5/60 |  | 40  | 57609     | -          | Socket Head Bolt<br>M8x1.25/45             |  |
| 41  | 72992     | -          | O-Ring                         |  | 42  | 72991     | -          | O-Ring<br>ø2,65xø65                        |  |

| Sr. | Auger Nr. | O.E.M. Nr. | Description           | Picture   | Sr.   | Auger Nr. | O.E.M. Nr. | Description             | Picture   |
|-----|-----------|------------|-----------------------|---|-------|-----------|------------|-------------------------|---|
| 43  | 72987     | -          | O-Ring<br>ø2x15       |    | 44    | 72683     | -          | Webbing<br>18,5x195,5x2 |  |
| 45  | 72906     | -          | Retaining Plate       |    | 45    | 72925     | -          | Retaining Plate         |  |
| 45  | 72940     | -          | Retaining Plate       |    | 46    | 72748     | -          | Pin<br>ø10x52           |  |
| 47  | 59752     | -          | Washer<br>ø10,5xø20x2 |    | 48    | 72797     | -          | Split pin               |  |
| 49  | 68091     | -          | Spring Holder         |  | 60574 | 32793     | -          | Lubricant               |   |
|     |           |            |                       |   | 60575 | 1114525   | -          | Lubricant               |   |
|     |           |            |                       |   | 60585 | -         | -          | Lubricant               |   |
|     |           |            |                       |   | 73207 | -         | -          | Lubricant               |   |

| Auger Nr.    | OEM Nr. | Description                        | Model | Picture   |
|--------------|---------|------------------------------------|-------|---|
| <b>54168</b> | K010604 | Repair Kit, Brake Caliper<br>ø74,5 |       |  |
| <b>56055</b> | K010606 | Repair Kit, Brake Caliper<br>ø74,3 |       |  |

| Auger Nr.    | OEM Nr.                    | Description                        | Model | Picture   |
|--------------|----------------------------|------------------------------------|-------|---|
| <b>54178</b> | K000944                    | Repair Kit, Brake Caliper<br>ø74,5 |       |    |
| <b>53878</b> | 11304130065<br>11179320065 | Repair Kit, Brake Caliper<br>ø74,5 |       |    |
| <b>56023</b> | 11370760065                | Repair Kit, Brake Caliper<br>ø74,5 |       |   |
| <b>56008</b> | -                          | Adjuster Bolt<br>M36x6 P3 x 79/100 |       |  |
| <b>56151</b> | -                          | Repair Kit, Brake Caliper          |       |  |
| <b>56152</b> | -                          | Repair Kit, Brake Caliper          |       |  |







| Auger Nr.    | OEM Nr. | Description                           | Model | Picture   |
|--------------|---------|---------------------------------------|-------|---|
| <b>57579</b> | -       | Repair Kit, Brake Caliper             |       |    |
| <b>57164</b> | -       | Bridge Assembly<br>M36x6 P3 x131x63,5 |       |    |
| <b>56153</b> | -       | Repair Kit, Brake Caliper             |       |   |
| <b>56154</b> | -       | Repair Kit, Brake Caliper             |       |  |
| <b>57580</b> | -       | Repair Kit, Brake Caliper             |       |  |
| <b>57165</b> | -       | Bridge Assembly<br>M36x6 P3 x131x80   |       |  |

| Auger Nr.    | OEM Nr. | Description                         | Model | Picture   |
|--------------|---------|-------------------------------------|-------|---|
| <b>56155</b> | -       | Repair Kit, Brake Caliper           |       |    |
| <b>56156</b> | -       | Repair Kit, Brake Caliper           |       |    |
| <b>57601</b> | -       | Repair Kit, Brake Caliper           |       |   |
| <b>57166</b> | -       | Bridge Assembly<br>M36x6 P3 x131x82 |       |  |
| <b>57162</b> | -       | Adjusting Mechanism                 |       |  |
| <b>57163</b> | -       | Adjusting Mechanism                 |       |  |



| Auger Nr.    | OEM Nr. | Description                            | Model | Picture   |
|--------------|---------|--|-------|---|
| <b>57177</b> | -       | Adjusting Gear                         |       |    |
| <b>57182</b> | -       | Roller Chain<br>DIN 8187/1-04-58       |       |    |
| <b>57582</b> | -       | Repair Kit, Brake Caliper<br>Angle 12° |       |   |
| <b>57583</b> | -       | Repair Kit, Brake Caliper<br>Angle 0°  |       |  |
| <b>57179</b> | -       | Lever                                  |       |  |
| <b>57181</b> | -       | Lever                                  |       |  |

| Auger Nr.    | OEM Nr.    | Description               | Model | Picture |
|--------------|------------|---------------------------|-------|---------|
| <b>56133</b> | -          | Repair Kit, Brake Caliper |       |         |
| <b>71447</b> | K048389K50 | Repair Kit, Brake Caliper |       |         |
| <b>71448</b> | K048396K50 | Repair Kit, Brake Caliper |       |         |
| <b>70359</b> | K000698    | Repair Kit, Brake Caliper |       |         |
| <b>70834</b> | K028451    | Repair Kit, Brake Caliper |       |         |
| <b>70835</b> | -          | Repair Kit, Brake Caliper |       |         |







| Auger Nr.    | OEM Nr. | Description               | Model | Picture   |
|--------------|---------|---------------------------|-------|---|
| <b>68164</b> | K011117 | Repair Kit, Brake Caliper |       |    |
| <b>53877</b> | K000687 | Repair Kit, Brake Caliper |       |    |
| <b>54071</b> | K001532 | Repair Kit, Brake Caliper |       |   |
| <b>56057</b> | K000421 | Repair Kit, Brake Caliper |       |  |
| <b>56113</b> | -       | Repair Kit, Brake Caliper |       |  |
| <b>56063</b> | -       | Repair Kit, Brake Caliper |       |  |

| Auger Nr.    | OEM Nr.                           | Description               | Model | Picture |
|--------------|-----------------------------------|---------------------------|-------|---------|
| <b>56064</b> | -                                 | Repair Kit, Brake Caliper |       |         |
| <b>53876</b> | K004218<br>K000696<br>II310370066 | Repair Kit, Brake Caliper |       |         |
| <b>70836</b> | -                                 | Repair Kit, Brake Caliper |       |         |
| <b>70833</b> | K000697                           | Repair Kit, Brake Caliper |       |         |
| <b>53882</b> | II358510062                       | Repair Kit, Brake Caliper |       |         |
| <b>53884</b> | II197140062                       | Repair Kit, Brake Caliper |       |         |

| Auger Nr.    | OEM Nr.                    | Description               | Model | Picture   |
|--------------|----------------------------|---------------------------|-------|---|
| <b>53885</b> | II179320062                | Repair Kit, Brake Caliper |       |    |
| <b>53886</b> | II197330062<br>II304130062 | Repair Kit, Brake Caliper |       |    |
| <b>53888</b> | K000375                    | Repair Kit, Brake Caliper |       |   |
| <b>54522</b> | II39769F0062               | Repair Kit, Brake Caliper |       |  |
| <b>54685</b> | K000935                    | Repair Kit, Brake Caliper |       |  |
| <b>54686</b> | K000132<br>II350470062     | Repair Kit, Brake Caliper |       |  |

| Auger Nr.    | OEM Nr.  | Description               | Model | Picture   |
|--------------|--|---------------------------|-------|---|
| <b>56054</b> | K010813  | Repair Kit, Brake Caliper |       |    |
| <b>53890</b> | 11339680062<br>11328090062<br>11369100062<br>11328090061 | Repair Kit, Brake Caliper |       |    |
| <b>53875</b> | 11368470064  | Repair Kit, Brake Caliper |       |   |
| <b>56065</b> | -  | Repair Kit, Brake Caliper |       |  |
| <b>56066</b> | -  | Repair Kit, Brake Caliper |       |  |
| <b>56022</b> | 11339830064  | Repair Kit, Brake Caliper |       |  |



| Auger Nr.    | OEM Nr.      | Description               | Model | Picture   |
|--------------|--------------|---------------------------|-------|---|
| <b>53879</b> | II39769F0063 | Repair Kit, Brake Caliper |       |    |
| <b>54072</b> | K001301      | Repair Kit, Brake Caliper |       |    |
| <b>70831</b> | -            | Repair Kit, Brake Caliper |       |   |
| <b>70832</b> | -            | Repair Kit, Brake Caliper |       |  |
| <b>56084</b> | K000133      | Repair Kit, Brake Caliper |       |  |
| <b>70829</b> | -            | Repair Kit, Brake Caliper |       |  |

| Auger Nr.    | OEM Nr.                  | Description               | Model | Picture |
|--------------|--------------------------|---------------------------|-------|---------|
| <b>56146</b> | K000129                  | Repair Kit, Brake Caliper |       |         |
| <b>70837</b> | II30679004<br>II19712004 | Repair Kit, Brake Caliper |       |         |
| <b>56112</b> | -                        | Repair Kit, Brake Caliper |       |         |
| <b>53880</b> | K000945                  | Repair Kit, Brake Caliper |       |         |

**06****KNORR**  
**SB6 - SB7 TYPE CALIPER**

| Auger Nr. | OEM Nr. | Description | Model | Picture |
|-----------|---------|-------------|-------|---------|
|-----------|---------|-------------|-------|---------|

**54068**    K000029    Repair Kit, Brake Caliper



**57183**    -    Cover









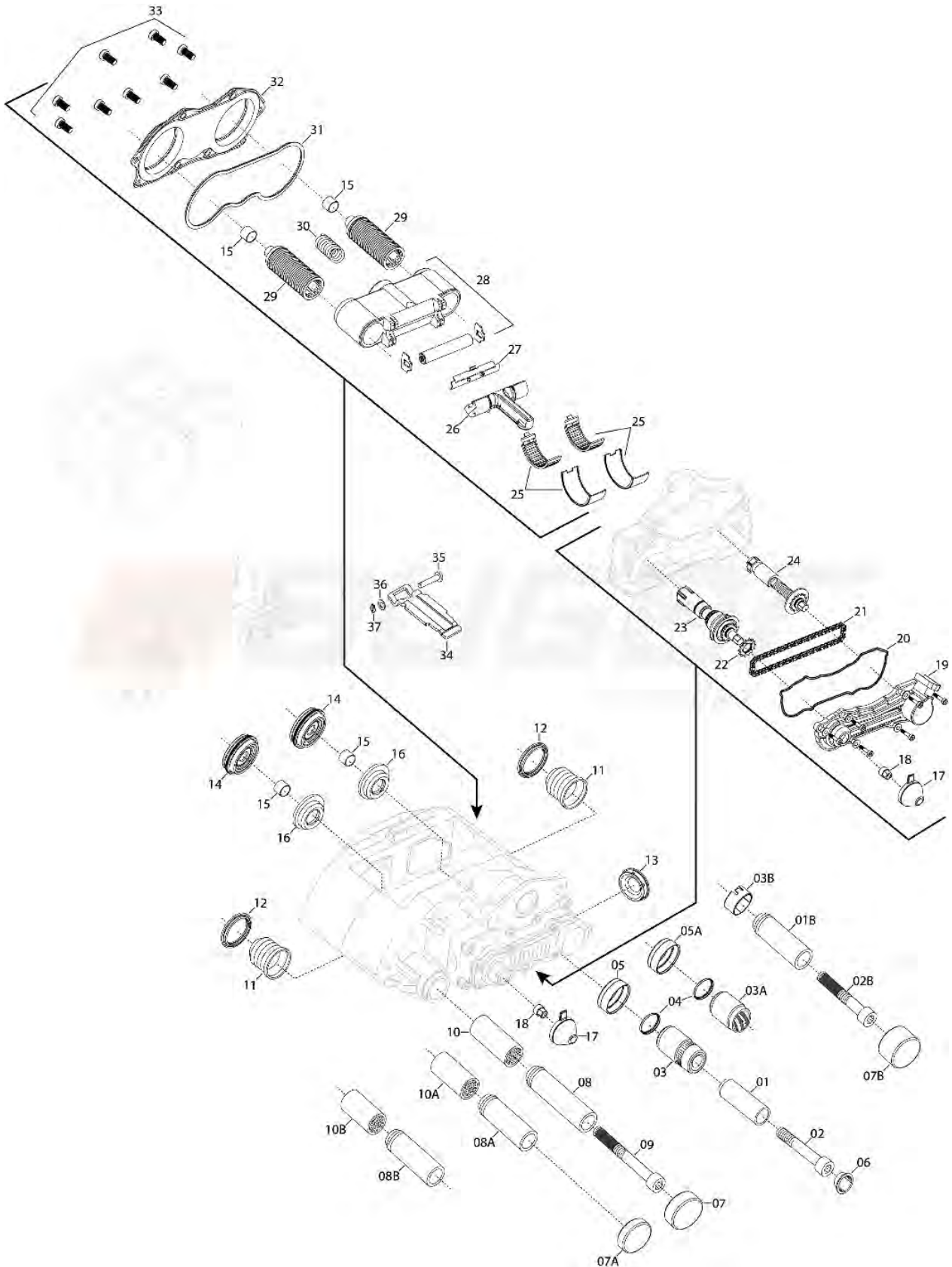



















**56135**    -    Repair Kit, Brake Caliper





















**Spare Parts**









| Sr. | Auger Nr. | O.E.M. Nr. | Description                                    | Picture   | Sr. | Auger Nr. | O.E.M. Nr. | Description                                    | Picture   |
|-----|-----------|------------|--|---|-----|-----------|------------|--|---|
| 01  | 60373     | -          | Pin<br>ø32x80                                  |    | 01B | 72719     | -          | Pin<br>ø36x64                                  |    |
| 02  | 55299     | -          | Socket Head Bolt<br>(12.9 Grade)<br>M16x1.5/80 |    | 02  | 55307     | -          | Socket Head Bolt<br>(10.9 Grade)<br>M16x1.5/80 |    |
| 02  | 72779     | -          | Socket Head Bolt<br>(10.9 Grade)<br>M16x1.5/80 |    | 02B | 55312     | -          | Socket Head Bolt<br>M16x1.5/70                 |    |
| 03  | 55376     | -          | Rubber Bearing<br>ø25/ø32xø40x61,5             |    | 03A | 55345     | -          | Rubber Bearing<br>ø32xø40x46                   |    |
| 03B | 73004     | -          | Bushing<br>ø36xø40x20                          |  | 04  | 72669     | -          | Plastic Bearing<br>ø32,5xø36,3x4               |  |
| 05  | 72806     | -          | Machined Washer<br>ø35/ø40x14,5                |  | 05A | 72805     | -          | Machined Washer<br>ø39/ø40x15                  |  |
| 06  | 60481     | -          | Cover<br>ø26,1x11                              |  | 07  | 60485     | -          | Cover<br>ø40x14,5                              |  |
| 07A | 72869     | -          | Cover<br>ø40x10,5                              |  | 07B | 72874     | -          | Cover<br>ø40x25                                |  |
| 08  | 60372     | -          | Pin<br>ø36x114                                 |  | 08A | 72708     | -          | Pin<br>ø36x102                                 |  |
| 08B | 72764     | -          | Pin<br>ø36x103                                 |  | 09  | 55306     | -          | Socket Head Bolt<br>M16x1.5/86,5               |  |

| Sr. | Auger Nr. | O.E.M. Nr. | Description                    | Picture   | Sr. | Auger Nr. | O.E.M. Nr. | Description                        | Picture   |
|-----|-----------|------------|--------------------------------|---|-----|-----------|------------|------------------------------------|---|
| 09  | 57607     | -          | Socket Head Bolt<br>M16x1.5/85 |    | 10  | 60533     | -          | Bushing<br>ø36xø40x82              |    |
| 10A | 73001     | -          | Bushing<br>ø36xø40x75          |    | 10B | 73000     | -          | Bushing<br>ø36xø40x70              |    |
| 11  | 55331     | K019508    | Rubber Seal<br>ø30xø48,75      |    | 12  | 60353     | -          | Plastic Washer<br>ø36,5xø48,75x5,5 |    |
| 13  | 57167     | -          | Cover                          |    | 14  | 55347     | -          | Seal Boot<br>ø74,5                 |    |
| 14  | 55348     | Z002585    | Seal Boot<br>ø69,3             |  | 15  | 72998     | -          | Bushing<br>ø16xø18x10              |  |
| 16  | 55370     | K007197    | Rubber Seal<br>ø33/ø35xø62     |  | 16  | 55371     | K007198    | Rubber Seal<br>ø33/ø35xø64         |  |
| 16  | 55372     | -          | Rubber Seal<br>ø35xø64         |  | 16  | 55373     | -          | Rubber Seal<br>ø35xø62             |  |
| 17  | 73184     | -          | Rubber Dust Cap<br>ø38         |  | 17  | 73186     | -          | Rubber Dust Cap<br>ø35             |  |
| 18  | 73062     | -          | Adjuster                       |  | 19  | 57183     | -          | Cover                              |  |
| 20  | 72981     | -          | Rubber Gasket                  |  | 21  | 57182     | -          | Roller Chain<br>DIN 8187/1-04-58   |  |



| Sr. | Auger Nr. | O.E.M. Nr. | Description                         | Picture   | Sr. | Auger Nr. | O.E.M. Nr. | Description                                  | Picture   |
|-----|-----------|------------|-------------------------------------|---|-----|-----------|------------|--|---|
| 22  | 57177     | -          | Adjusting Gear                      |    | 23  | 57163     | -          | Adjusting Mechanism                          |    |
| 24  | 57162     | -          | Adjusting Mechanism                 |    | 25  | 72857     | -          | Half Needle Roller Bearing<br>ø56,2xø65x27,5 |    |
| 26  | 57178     | -          | Lever                               |    | 26  | 57180     | -          | Lever  |    |
| 26  | 73162     | -          | Operating Shaft<br>Angle 12°        |    | 26  | 73163     | -          | Operating Shaft<br>Angle 0°                  |    |
| 27  | 72934     | -          | Half Bearing<br>ø16,25xø19,25       |  | 28  | 57164     | -          | Bridge Assembly<br>M36x6 P3x131x63,5         |  |
| 28  | 57165     | -          | Bridge Assembly<br>M36x6 P3 x131x80 |  | 28  | 57166     | -          | Bridge Assembly<br>M36x6 P3 x131x82          |  |
| 29  | 56008     | -          | Adjuster Bolt<br>M36x6 P3x79/100    |  | 30  | 73057     | -          | Spring<br>ø24x48                             |  |
| 31  | 72979     | -          | Gasket                              |  | 32  | 72919     | -          | Lock Plate<br>ø64x131                        |  |
| 33  | 55330     | -          | Socket Head Bolt<br>M8x1.25/16      |  | 34  | 72925     | -          | Retaining Plate                              |  |
| 34  | 72940     | -          | Retaining Plate                     |  | 35  | 72748     | -          | Pin<br>ø10x52                                |  |

| Sr.   | Auger Nr. | O.E.M. Nr. | Description           | Picture   | Sr.   | Auger Nr. | O.E.M. Nr. | Description | Picture   |
|-------|-----------|------------|-----------------------|---|-------|-----------|------------|-------------|---|
| 36    | 59752     | -          | Washer<br>ø10,5xø20x2 |  | 37    | 72797     | -          | Split pin   |  |
| 60575 | II14525   | -          | Lubricant             |   | 73207 | -         | -          | Lubricant   |   |

| Auger Nr.    | OEM Nr.            | Description                        | Model | Picture   |
|--------------|--------------------|------------------------------------|-------|---|
| <b>54167</b> | K010603<br>K000366 | Repair Kit, Brake Caliper<br>ø69,3 |       |    |
| <b>54168</b> | K010604            | Repair Kit, Brake Caliper<br>ø74,5 |       |  |
| <b>53881</b> | K001300            | Repair Kit, Brake Caliper<br>ø69,3 |       |  |
| <b>54178</b> | K000944            | Repair Kit, Brake Caliper<br>ø74,5 |       |  |

| Auger Nr.    | OEM Nr. | Description                           | Model | Picture   |
|--------------|---------|---------------------------------------|-------|---|
| <b>56008</b> | -       | Adjuster Bolt<br>M36x6 P3 x 79/100    |       |    |
| <b>56151</b> | -       | Repair Kit, Brake Caliper             |       |    |
| <b>56152</b> | -       | Repair Kit, Brake Caliper             |       |   |
| <b>57579</b> | -       | Repair Kit, Brake Caliper             |       |  |
| <b>57164</b> | -       | Bridge Assembly<br>M36x6 P3 x131x63,5 |       |  |
| <b>56153</b> | -       | Repair Kit, Brake Caliper             |       |  |

| Auger Nr.    | OEM Nr. | Description                         | Model | Picture   |
|--------------|---------|-------------------------------------|-------|---|
| <b>56154</b> | -       | Repair Kit, Brake Caliper           |       |    |
| <b>57580</b> | -       | Repair Kit, Brake Caliper           |       |    |
| <b>57165</b> | -       | Bridge Assembly<br>M36x6 P3 x131x80 |       |   |
| <b>56155</b> | -       | Repair Kit, Brake Caliper           |       |  |
| <b>56156</b> | -       | Repair Kit, Brake Caliper           |       |  |
| <b>57601</b> | -       | Repair Kit, Brake Caliper           |       |  |

| Auger Nr.    | OEM Nr. | Description                          | Model | Picture   |
|--------------|---------|--------------------------------------|-------|---|
| <b>57166</b> | -       | Bridge Assembly<br>M36x6 P3 x131x82  |       |    |
| <b>57162</b> | -       | Adjusting Mechanism                  |       |    |
| <b>57163</b> | -       | Adjusting Mechanism                  |       |   |
| <b>57177</b> | -       | Adjusting Gear                       |       |  |
| <b>57182</b> | -       | Roller Chain<br>DIN 8187/1-04-58     |       |  |
| <b>56130</b> | -       | Repair Kit, Brake Caliper<br>ø64x131 |       |  |

| Auger Nr.    | OEM Nr. | Description                            | Model | Picture   |
|--------------|---------|--|-------|---|
| <b>72981</b> | -       | Rubber Gasket                          |       |    |
| <b>57584</b> | -       | Repair Kit, Brake Caliper<br>Angle 12° |       |    |
| <b>57585</b> | -       | Repair Kit, Brake Caliper<br>Angle 0°  |       |   |
| <b>57178</b> | -       | Lever                                  |       |  |
| <b>57180</b> | -       | Lever                                  |       |  |
| <b>56134</b> | -       | Repair Kit, Brake Caliper              |       |  |



| Auger Nr.    | OEM Nr. | Description               | Model | Picture   |
|--------------|---------|---------------------------|-------|---|
| <b>54684</b> | K001915 | Repair Kit, Brake Caliper |       |    |
| <b>56021</b> | K010766 | Repair Kit, Brake Caliper |       |    |
| <b>56056</b> | K002716 | Repair Kit, Brake Caliper |       |   |
| <b>70834</b> | K028451 | Repair Kit, Brake Caliper |       |  |
| <b>56113</b> | -       | Repair Kit, Brake Caliper |       |  |
| <b>70833</b> | K000697 | Repair Kit, Brake Caliper |       |  |

| Auger Nr.    | OEM Nr. | Description               | Model | Picture   |
|--------------|---------|---------------------------|-------|---|
| <b>54069</b> | K000472 | Repair Kit, Brake Caliper |       |    |
| <b>54070</b> | K001925 | Repair Kit, Brake Caliper |       |    |
| <b>70835</b> | -       | Repair Kit, Brake Caliper |       |   |
| <b>54526</b> | K004100 | Repair Kit, Brake Caliper |       |  |
| <b>53889</b> | -       | Repair Kit, Brake Caliper |       |  |
| <b>56065</b> | -       | Repair Kit, Brake Caliper |       |  |

| Auger Nr.    | OEM Nr.                  | Description               | Model | Picture   |
|--------------|--------------------------|---------------------------|-------|---|
| <b>54068</b> | K000029                  | Repair Kit, Brake Caliper |       |    |
| <b>54525</b> | K003902                  | Repair Kit, Brake Caliper |       |    |
| <b>57183</b> | -                        | Cover                     |       |   |
| <b>57167</b> | -                        | Cover                     |       |  |
| <b>56146</b> | K000129                  | Repair Kit, Brake Caliper |       |  |
| <b>70837</b> | II30679004<br>II19712004 | Repair Kit, Brake Caliper |       |  |



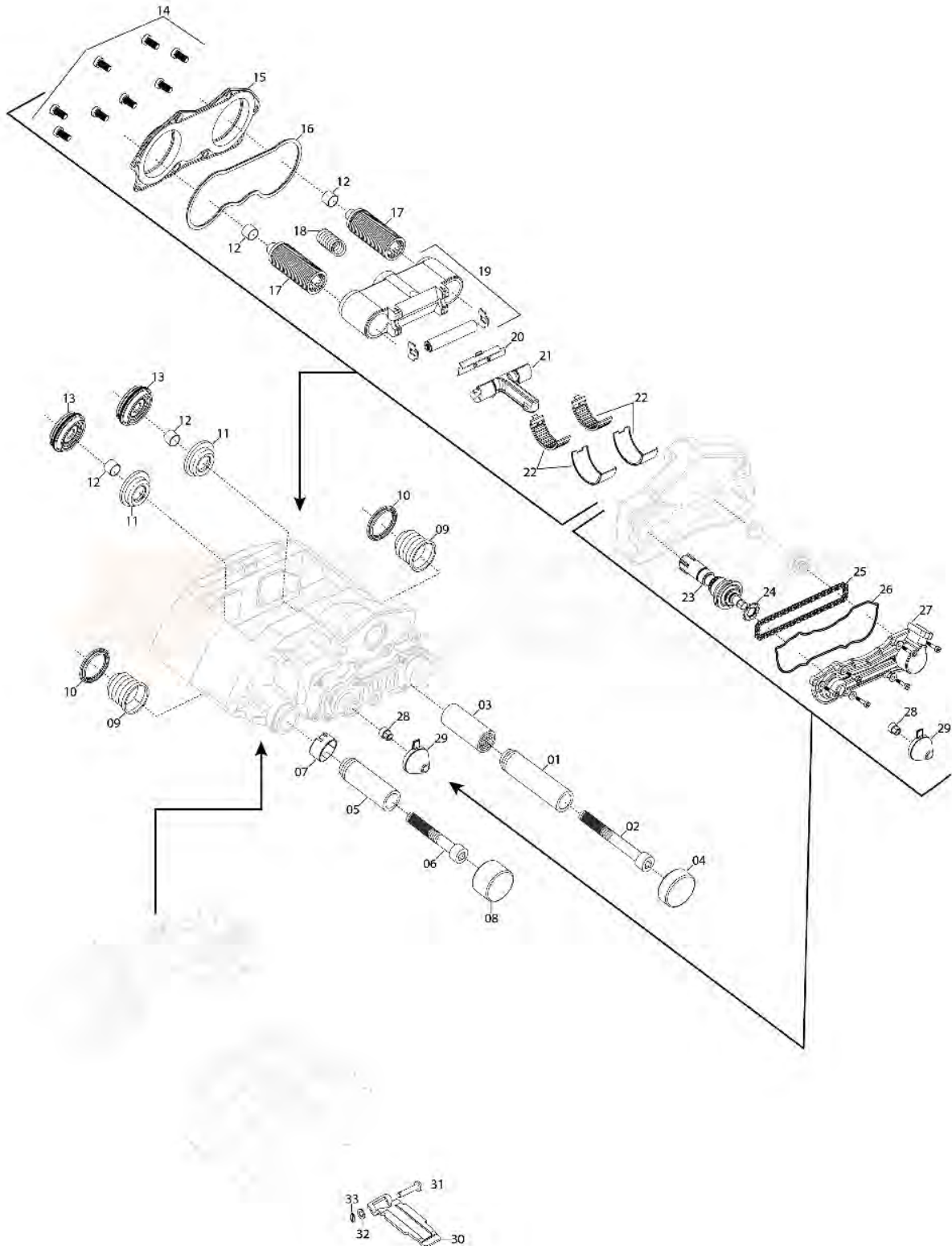



Spare Parts



| Sr. | Auger Nr. | O.E.M. Nr. | Description                    | Picture   | Sr. | Auger Nr. | O.E.M. Nr. | Description                          | Picture   |
|-----|-----------|------------|--------------------------------|---|-----|-----------|------------|--------------------------------------|---|
| 01  | 60372     | -          | Pin<br>ø36x114                 |    | 02  | 55306     | -          | Socket Head Bolt<br>M16x1.5/86,5     |    |
| 03  | 60533     | -          | Bushing<br>ø36xø40x82          |    | 04  | 60485     | -          | Cover<br>ø40x14,5                    |    |
| 05  | 72719     | -          | Pin<br>ø36x64                  |    | 06  | 55312     | -          | Socket Head Bolt<br>M16x1.5/70       |    |
| 07  | 73004     | -          | Bushing<br>ø36xø40x20          |    | 08  | 72874     | -          | Cover<br>ø40x25                      |    |
| 09  | 55331     | K019508    | Rubber Seal<br>ø30xø48,75      |  | 10  | 60353     | -          | Plastic Washer<br>ø36,5xø48,75x5,5   |  |
| 11  | 55370     | K007197    | Rubber Seal<br>ø33/ø35xø62     |  | 11  | 55373     | -          | Rubber Seal<br>ø35xø62               |  |
| 12  | 72998     | -          | Bushing<br>ø16xø18x10          |  | 13  | 55348     | Z002585    | Seal Boot<br>ø69,3                   |  |
| 14  | 55330     | -          | Socket Head Bolt<br>M8x1.25/16 |  | 15  | 72919     | -          | Lock Plate<br>ø64x131                |  |
| 16  | 72979     | -          | Gasket                         |  | 17  | 56008     | -          | Adjuster Bolt<br>M36x6 P3x79/100     |  |
| 18  | 73057     | -          | Spring<br>ø24x48               |  | 19  | 57164     | -          | Bridge Assembly<br>M36x6 P3x131x63,5 |  |

| Sr. | Auger Nr. | O.E.M. Nr. | Description                         | Picture | Sr.   | Auger Nr. | O.E.M. Nr. | Description                                  | Picture |
|-----|-----------|------------|-------------------------------------|---------|-------|-----------|------------|--|---------|
| 19  | 57165     | -          | Bridge Assembly<br>M36x6 P3 x131x80 |         | 19    | 57166     | -          | Bridge Assembly<br>M36x6 P3 x131x82          |         |
| 20  | 72934     | -          | Half Bearing<br>ø16,25xø19,25       |         | 21    | 57178     | -          | Lever  |         |
| 21  | 57180     | -          | Lever                               |         | 21    | 73162     | -          | Operating Shaft<br>Angle 12°                 |         |
| 21  | 73163     | -          | Operating Shaft<br>Angle 0°         |         | 22    | 72857     | -          | Half Needle Roller Bearing<br>ø56,2xø65x27,5 |         |
| 23  | 57163     | -          | Adjusting Mechanism                 |         | 24    | 57177     | -          | Adjusting Gear                               |         |
| 25  | 57182     | -          | Roller Chain<br>DIN 8187/1-04-58    |         | 26    | 72981     | -          | Rubber Gasket                                |         |
| 27  | 57183     | -          | Cover                               |         | 28    | 73062     | -          | Adjuster                                     |         |
| 29  | 73186     | -          | Rubber Dust Cap<br>ø35              |         | 30    | 72906     | -          | Retaining Plate                              |         |
| 31  | 72748     | -          | Pin<br>ø10x52                       |         | 32    | 59752     | -          | Washer<br>ø10,5xø20x2                        |         |
| 33  | 72797     | -          | Split pin                           |         | 60575 | 14525     | -          | Lubricant                                    |         |
|     |           |            |                                     |         | 73207 | -         | -          | Lubricant                                    |         |



| Auger Nr.    | OEM Nr.            | Description                        | Model | Picture   |
|--------------|--------------------|------------------------------------|-------|---|
| <b>54167</b> | K000366<br>K010603 | Repair Kit, Brake Caliper<br>ø69,3 |       |    |
| <b>53881</b> | K001300            | Repair Kit, Brake Caliper<br>ø69,3 |       |    |
| <b>56008</b> | -                  | Adjuster Bolt<br>M36x6 P3 x 79/100 |       |   |
| <b>56151</b> | -                  | Repair Kit, Brake Caliper          |       |  |
| <b>56152</b> | -                  | Repair Kit, Brake Caliper          |       |  |
| <b>57579</b> | -                  | Repair Kit, Brake Caliper          |       |  |

| Auger Nr.    | OEM Nr. | Description                           | Model | Picture   |
|--------------|---------|---------------------------------------|-------|---|
| <b>57164</b> | -       | Bridge Assembly<br>M36x6 P3 x131x63,5 |       |    |
| <b>56153</b> | -       | Repair Kit, Brake Caliper             |       |    |
| <b>56154</b> | -       | Repair Kit, Brake Caliper             |       |   |
| <b>57580</b> | -       | Repair Kit, Brake Caliper             |       |  |
| <b>57165</b> | -       | Bridge Assembly<br>M36x6 P3 x131x80   |       |  |
| <b>56155</b> | -       | Repair Kit, Brake Caliper             |       |  |

| Auger Nr.    | OEM Nr. | Description                         | Model | Picture   |
|--------------|---------|-------------------------------------|-------|---|
| <b>56156</b> | -       | Repair Kit, Brake Caliper           |       |    |
| <b>57601</b> | -       | Repair Kit, Brake Caliper           |       |    |
| <b>57166</b> | -       | Bridge Assembly<br>M36x6 P3 x131x82 |       |   |
| <b>54526</b> | K004100 | Repair Kit, Brake Caliper           |       |  |
| <b>56021</b> | K010766 | Repair Kit, Brake Caliper           |       |  |
| <b>56065</b> | -       | Repair Kit, Brake Caliper           |       |  |

| Auger Nr.    | OEM Nr. | Description                            | Model | Picture   |
|--------------|---------|--|-------|---|
| <b>54525</b> | K003902 | Repair Kit, Brake Caliper              |       |    |
| <b>57183</b> | -       | Cover                                  |       |    |
| <b>57584</b> | -       | Repair Kit, Brake Caliper<br>Angle 12° |       |   |
| <b>57585</b> | -       | Repair Kit, Brake Caliper<br>Angle 0°  |       |  |
| <b>57178</b> | -       | Lever                                  |       |  |
| <b>57180</b> | -       | Lever                                  |       |  |
| <b>56134</b> | -       | Repair Kit, Brake Caliper              |       |  |





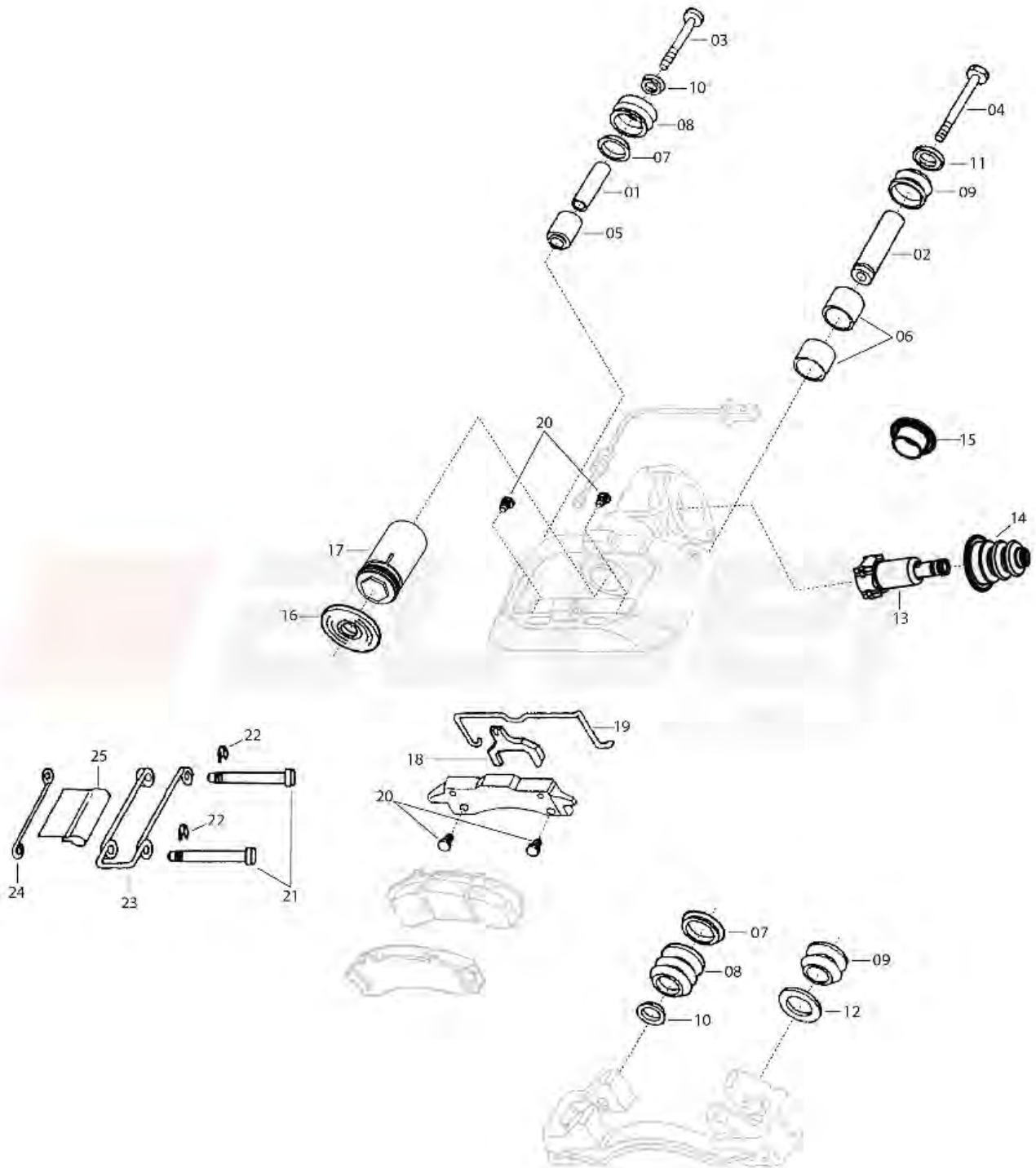







| Auger Nr.    | OEM Nr. | Description                          | Model | Picture   |
|--------------|---------|--------------------------------------|-------|---|
| <b>57163</b> | -       | Adjusting Mechanism                  |       |    |
| <b>57177</b> | -       | Adjusting Gear                       |       |    |
| <b>57182</b> | -       | Roller Chain<br>DIN 8157/1-04-58     |       |    |
| <b>56084</b> | K000133 | Repair Kit, Brake Caliper            |       |  |
| <b>70829</b> | -       | Repair Kit, Brake Caliper            |       |  |
| <b>56130</b> | -       | Repair Kit, Brake Caliper<br>ø64x131 |       |  |
| <b>72981</b> | -       | Rubber Gasket                        |       |  |

Spare Parts







| Sr. | Auger Nr. | O.E.M. Nr. | Description                       | Picture   | Sr. | Auger Nr. | O.E.M. Nr. | Description                       | Picture   |
|-----|-----------|------------|-----------------------------------|---|-----|-----------|------------|-----------------------------------|---|
| 01  | 72849     | -          | Spacertube<br>ø16,5xø23,6x92      |    | 02  | 72745     | -          | Pin<br>ø23,5xø45x151              |    |
| 03  | 72775     | -          | Hexagon Head Screw<br>M16x1.5/124 |    | 04  | 72776     | -          | Hexagon Head Screw<br>M22x1.5/176 |    |
| 05  | 73191     | -          | Rubber Bushing<br>ø29xø38x55      |    | 06  | 73017     | -          | Bushing<br>ø45xø50x40             |    |
| 07  | 72867     | -          | Cover<br>ø38                      |    | 08  | 55340     | -          | Rubber Seal<br>ø38/ø64,5          |    |
| 09  | 55339     | -          | Rubber Seal<br>ø20/ø34            |  | 10  | 72866     | -          | Cover<br>ø23,5                    |  |
| 11  | 72868     | -          | Cover<br>ø32,5xø47,5x3,5          |  | 12  | 72670     | -          | Plastic Washer<br>ø48,4xø77x1     |  |
| 13  | 73149     | -          | Wedge Assembly<br>ø46xø57x160,5   |  | 13  | 73156     | -          | Wedge Assembly<br>ø46xø57x172,5   |  |
| 14  | 57647     | -          | Rubber Seal                       |  | 15  | 72684     | -          | Plastic Bushing<br>ø50xø56x39     |  |
| 15  | 72685     | -          | Plastic Bushing<br>ø50xø56x48,5   |  | 16  | 55352     | -          | Rubber Seal<br>ø30,5xø85          |  |
| 17  | 73147     | -          | Adjuster<br>118                   |  | 17  | 73148     | -          | Adjuster<br>158                   |  |

| Sr.   | Auger Nr. | O.E.M. Nr. | Description | Picture   | Sr.   | Auger Nr. | O.E.M. Nr. | Description    | Picture   |
|-------|-----------|------------|-------------|---|-------|-----------|------------|----------------|---|
| 18    | 73099     | -          | Lock Jaw    |    | 18    | 73100     | -          | Fork           |    |
| 19    | 73051     | -          | Spring      |    | 19    | 73054     | -          | Spring         |    |
| 20    | 72765     | -          | Pin         |    | 21    | 72749     | -          | Pin<br>ø10xø69 |    |
| 22    | 73040     | -          | Spring Clip |    | 23    | 73053     | -          | Spring         |    |
| 23    | 73056     | -          | Spring      |  | 24    | 73052     | -          | Spring         |  |
| 24    | 73055     | -          | Spring      |  | 25    | 72924     | -          | Lock Plate     |  |
| 60576 | 423296    |            | Lubricant   |   | 60586 | 423243    |            | Lubricant      |   |

| Auger Nr.    | OEM Nr. | Description               | Model | Picture   |
|--------------|---------|---------------------------|-------|---|
| <b>56058</b> | 381391  | Repair Kit, Brake Caliper |       |    |
| <b>53883</b> | 381413  | Repair Kit, Brake Caliper |       |    |
| <b>56069</b> | 381427  | Repair Kit, Brake Caliper |       |   |
| <b>56106</b> | 381426  | Repair Kit, Brake Caliper |       |  |
| <b>56067</b> | 381428  | Repair Kit, Brake Caliper |       |  |
| <b>56068</b> | 381429  | Repair Kit, Brake Caliper |       |  |

| Auger Nr.    | OEM Nr. | Description               | Model | Picture   |
|--------------|---------|---------------------------|-------|---|
| <b>56085</b> | 1133692 | Repair Kit, Brake Caliper |       |  |
| <b>56144</b> | 381419  | Repair Kit, Brake Caliper |       |  |

| Auger Nr. | OEM Nr. | Description | Model | Picture |
|-----------|---------|-------------|-------|---------|
|-----------|---------|-------------|-------|---------|

|              |        |                           |  |  |
|--------------|--------|---------------------------|--|--|
| <b>56145</b> | 381422 | Repair Kit, Brake Caliper |  |  |
|--------------|--------|---------------------------|--|--|



|              |         |                           |  |  |
|--------------|---------|---------------------------|--|--|
| <b>71445</b> | 1133564 | Repair Kit, Brake Caliper |  |  |
|--------------|---------|---------------------------|--|--|



CALIPER  
**MERITOR-ROR**

KNORR

WABCO

HALDEX

OTHER TYPE CALIPERS

UNIVERSAL PARTS







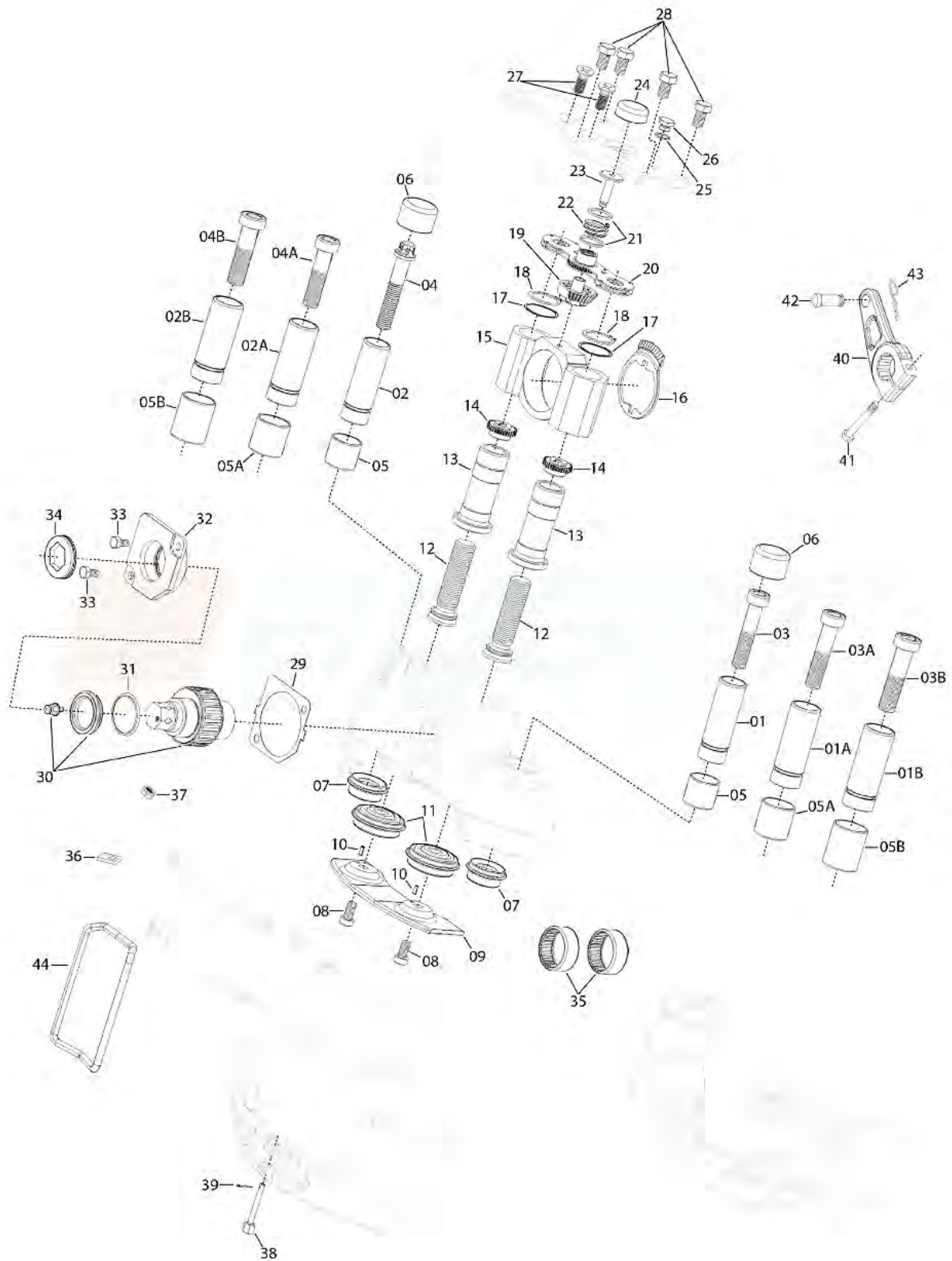











we keep your business on the move

















**Spare Parts**



| Sr. | Auger Nr. | O.E.M. Nr. | Description                                      | Picture   | Sr. | Auger Nr. | O.E.M. Nr. | Description                    | Picture   |
|-----|-----------|------------|--|---|-----|-----------|------------|--------------------------------|---|
| 01  | 72746     | -          | Pin<br>ø27,7/ø28x96                              |    | 01A | 72698     | -          | Pin<br>ø31,7/ø32x97            |    |
| 01B | 72742     | -          | Pin<br>ø34,7x98                                  |    | 02  | 72747     | -          | Pin<br>ø27,7/ø28x96            |    |
| 02A | 72697     | -          | Pin<br>ø32x97                                    |    | 02B | 72741     | -          | Pin<br>ø35x98                  |    |
| 03  | 57570     | -          | Hexagon Bolt With<br>Astral Flange<br>M14x1,5/90 |    | 03A | 55299     | -          | Socket Head Bolt<br>M16x1,5/80 |    |
| 03B | 57573     | -          | Socket Head Bolt<br>M18x2,5/90                   |  | 04  | 57575     | -          | Socket Head Bolt<br>M14x1,5/70 |  |
| 04A | 55318     | -          | Socket Head Bolt<br>M16x1,5/55                   |  | 04B | 57572     | -          | Socket Head Bolt<br>M18x2,5/55 |  |
| 05  | 73018     | -          | Bushing<br>ø28xø32x25                            |  | 05A | 72993     | -          | Bushing<br>ø32xø36x55          |  |
| 05A | 73013     | -          | Bushing<br>ø32xø36x30                            |  | 05A | 73014     | -          | Bushing<br>ø32xø36x20          |  |
| 05B | 73016     | -          | Bushing<br>ø35xø39x50                            |  | 06  | 72860     | -          | Cover<br>ø41,75x27,5           |  |
| 06  | 72898     | -          | Cover<br>ø37,3x24                                |  | 07  | 55375     | -          | Rubber Seal<br>ø21xø42         |  |

| Sr. | Auger Nr. | O.E.M. Nr. | Description                                    | Picture   | Sr. | Auger Nr. | O.E.M. Nr. | Description                                   | Picture   |
|-----|-----------|------------|--|---|-----|-----------|------------|---|---|
| 07  | 57641     | -          | Rubber Seal<br>ø25xø49                         |    | 07  | 57642     | -          | Rubber Seal<br>ø18,5                          |    |
| 08  | 57602     | -          | Socket Head Bolt<br>M8x1,25/20                 |    | 08  | 72780     | -          | Socket Head Bolt<br>M10x1,5/20                |    |
| 09  | 73129     | -          | Thrust Plate<br>ø11x112,5                      |    | 10  | 72864     | -          | Roll Pin<br>ø4x10                             |    |
| 11  | 55374     | -          | Rubber Seal<br>ø19/ø34,5xø58                   |    | 11  | 57648     | -          | Rubber Seal<br>ø17                            |    |
| 12  | 72694     | -          | Actuating Piston,<br>Right<br>M24x2 R / 88     |  | 12  | 72695     | -          | Actuating Piston,<br>Left<br>M24x2 L / 88     |  |
| 13  | 72743     | -          | Adjusting Sleeve,<br>Right<br>M24x2 R / ø47x98 |  | 13  | 72744     | -          | Adjusting Sleeve,<br>Left<br>M24x2 L / ø47x98 |  |
| 14  | 73075     | -          | Adjuster Sleeve<br>Gear<br>ø25,5x15,5          |  | 15  | 73128     | -          | Actuation Block<br>ø35x112,5/ø68              |  |
| 16  | 73073     | -          | Adjuster Gear<br>Segment<br>ø64xø73            |  | 17  | 72818     | -          | Shim<br>ø53,5xø86x2,2                         |  |
| 18  | 72838     | -          | Circlip<br>ø32,8x1,5                           |  | 19  | 73136     | -          | Bevel Gear<br>ø14/ø42x30                      |  |
| 20  | 73137     | -          | Adjustment Box,<br>Left<br>ø20x112,5/ø23       |  | 20  | 73152     | -          | Adjustment Box,<br>Right<br>ø20x112,5/ø23     |  |







| Sr. | Auger Nr. | O.E.M. Nr. | Description   | Picture   | Sr. | Auger Nr. | O.E.M. Nr. | Description                                 | Picture   |
|-----|-----------|------------|---|---|-----|-----------|------------|---|---|
| 21  | 57645     | -          | Seal Ring<br>ø23,5xø28,5x2                          |    | 22  | 73036     | -          | Spring<br>ø28,5x19                          |    |
| 23  | 72774     | -          | Adjuster Device<br>Screw<br>M8x0,80/37              |    | 24  | 72897     | -          | Cover<br>ø37x16                             |    |
| 25  | 72814     | -          | Washer<br>ø12,5xø15x1,4                             |    | 26  | 72781     | -          | Stopper Bolt<br>M12x1,25/8                  |    |
| 27  | 72773     | -          | Countersunk Socket<br>Head Cap Screw<br>M12x1,75/22 |    | 28  | 72772     | -          | Hexagon Head<br>Screw<br>M12x1,75/30        |    |
| 29  | 72976     | -          | Gasket<br>(New version)<br>ø76/ø9x92                |  | 29  | 72977     | -          | Gasket<br>ø64,5/ø9x79                       |  |
| 30  | 70701     | -          | Eccentric Shaft<br>ø45xø45/ø68x102,5                |  | 30  | 73153     | -          | Eccentric Shaft<br>ø45xø35/ø55x102,5        |  |
| 31  | 72901     | -          | Cover<br>ø45xø62x2,25                               |  | 32  | 73135     | -          | Eccentric Shaft<br>Housing<br>ø45xø75/ø9x92 |  |
| 32  | 73154     | -          | Eccentric Shaft<br>Housing<br>ø45xø64,5/ø9x79       |  | 33  | 72770     | -          | Hexagon Head<br>Screw<br>M8x1,25/20         |  |
| 33  | 72777     | -          | Hexagon Head<br>Screw<br>M8x1,25/16                 |  | 34  | 57644     | -          | Rubber Seal                                 |  |
| 35  | 56006     | -          | Needle Bearing<br>ø45xø52x20                        |  | 36  | 72834     | -          | Washer<br>ø8,5                              |  |

| Sr.   | Auger Nr. | O.E.M. Nr. | Description                     | Picture   | Sr.   | Auger Nr. | O.E.M. Nr. | Description                      | Picture   |
|-------|-----------|------------|---------------------------------|---|-------|-----------|------------|----------------------------------|---|
| 37    | 59310     | -          | Lock Nut<br>M8x1,25/8           |    | 38    | 72703     | -          | Pin<br>ø5,8x35/41                |    |
| 39    | 72794     | -          | Split pin<br>ø2,5x14            |    | 40    | 73074     | -          | Lever                            |    |
| 40    | 73078     | -          | Lever                           |    | 40    | 73079     | -          | Lever                            |    |
| 40    | 73080     | -          | Lever                           |    | 40    | 73081     | -          | Lever                            |    |
| 40    | 73102     | -          | Lever                           |  | 41    | 72771     | -          | Hexagon Head Screw<br>M8x1,25/60 |  |
| 42    | 72758     | -          | Pin<br>ø13,7x36                 |  | 43    | 72799     | -          | Split pin                        |  |
| 44    | 73072     | -          | Pad Retainer Bar<br>ø8x97x159   |  | 44    | 73076     | -          | Pad Retainer Bar<br>ø8x97,5x163  |  |
| 44    | 73077     | -          | Pad Retainer Bar<br>ø6x70x134,5 |  | 44    | 73109     | -          | Pad Retainer Bar<br>ø8x97x153    |  |
| 73204 | MBG1002   | -          | Lubricant                       |   | 73205 | MBG1004   | -          | Lubricant                        |   |
| 60577 | MBG1003   | -          | Lubricant                       |   |       |           |            |                                  |   |



# MERITOR / ROR

## DX175 - DX195 - DX225 TYPE CALIPER

| Auger Nr.    | OEM Nr. | Description               | Model | Picture   |
|--------------|---------|---------------------------|-------|---|
| <b>56070</b> | MCK1170 | Repair Kit, Brake Caliper |       |    |
| <b>70687</b> | MCK1173 | Repair Kit, Brake Caliper |       |    |
| <b>53872</b> | MCK1171 | Repair Kit, Brake Caliper |       |   |
| <b>53873</b> | MCK1192 | Repair Kit, Brake Caliper |       |  |
| <b>56035</b> | MCK1172 | Repair Kit, Brake Caliper |       |  |
| <b>56036</b> | MCK1191 | Repair Kit, Brake Caliper |       |  |



| Auger Nr.    | OEM Nr.   | Description               | Model | Picture   |
|--------------|-----------|---------------------------|-------|---|
| <b>56020</b> | DSB1      | Repair Kit, Brake Caliper |       |    |
| <b>56044</b> | MCK1193   | Repair Kit, Brake Caliper |       |    |
| <b>53866</b> | MCK1171/N | Repair Kit, Brake Caliper |       |    |
| <b>56031</b> | MCK1292   | Repair Kit, Brake Caliper |       |  |
| <b>56032</b> | MCK1293   | Repair Kit, Brake Caliper |       |  |
| <b>56110</b> | -         | Repair Kit, Brake Caliper |       |  |
| <b>56111</b> | -         | Repair Kit, Brake Caliper |       |  |

| Auger Nr.    | OEM Nr.                       | Description               | Model | Picture   |
|--------------|-------------------------------|---------------------------|-------|---|
| <b>56108</b> | -                             | Repair Kit, Brake Caliper |       |    |
| <b>56109</b> | -                             | Repair Kit, Brake Caliper |       |    |
| <b>56043</b> | MCK1290                       | Repair Kit, Brake Caliper |       |    |
| <b>56073</b> | MCK1291                       | Repair Kit, Brake Caliper |       |  |
| <b>56117</b> | -                             | Repair Kit, Brake Caliper |       |  |
| <b>56041</b> | MCK1294<br>MCK1168<br>MCK1169 | Repair Kit, Brake Caliper |       |  |
| <b>56076</b> | MCK1295<br>MCK1167            | Repair Kit, Brake Caliper |       |  |

| Auger Nr.    | OEM Nr.            | Description                              | Model | Picture   |
|--------------|--------------------|--|-------|---|
| <b>70701</b> | -                  | Eccentric Shaft<br><br>ø45xø45/ø68x102,5 |       |    |
| <b>56042</b> | MCK1154            | Repair Kit, Brake Caliper                |       |    |
| <b>56074</b> | MCK1155            | Repair Kit, Brake Caliper                |       |   |
| <b>56075</b> | MCK1153            | Repair Kit, Brake Caliper                |       |  |
| <b>70690</b> | MCK1159            | Repair Kit, Brake Caliper                |       |  |
| <b>56052</b> | MCK1161<br>MCK1175 | Repair Kit, Brake Caliper                |       |  |
| <b>56077</b> | MCK1158            | Repair Kit, Brake Caliper                |       |  |

| Auger Nr.    | OEM Nr. | Description                  | Model | Picture   |
|--------------|---------|------------------------------|-------|---|
| <b>56078</b> | MCK1156 | Repair Kit, Brake Caliper    |       |    |
| <b>56079</b> | MCK1160 | Repair Kit, Brake Caliper    |       |    |
| <b>56080</b> | MCK1165 | Repair Kit, Brake Caliper    |       |    |
| <b>57588</b> | MCK1164 | Repair Kit, Brake Caliper    |       |  |
| <b>56143</b> | -       | Repair Kit, Brake Caliper    |       |  |
| <b>56006</b> | -       | Needle Bearing<br>ø45xø52x20 |       |  |



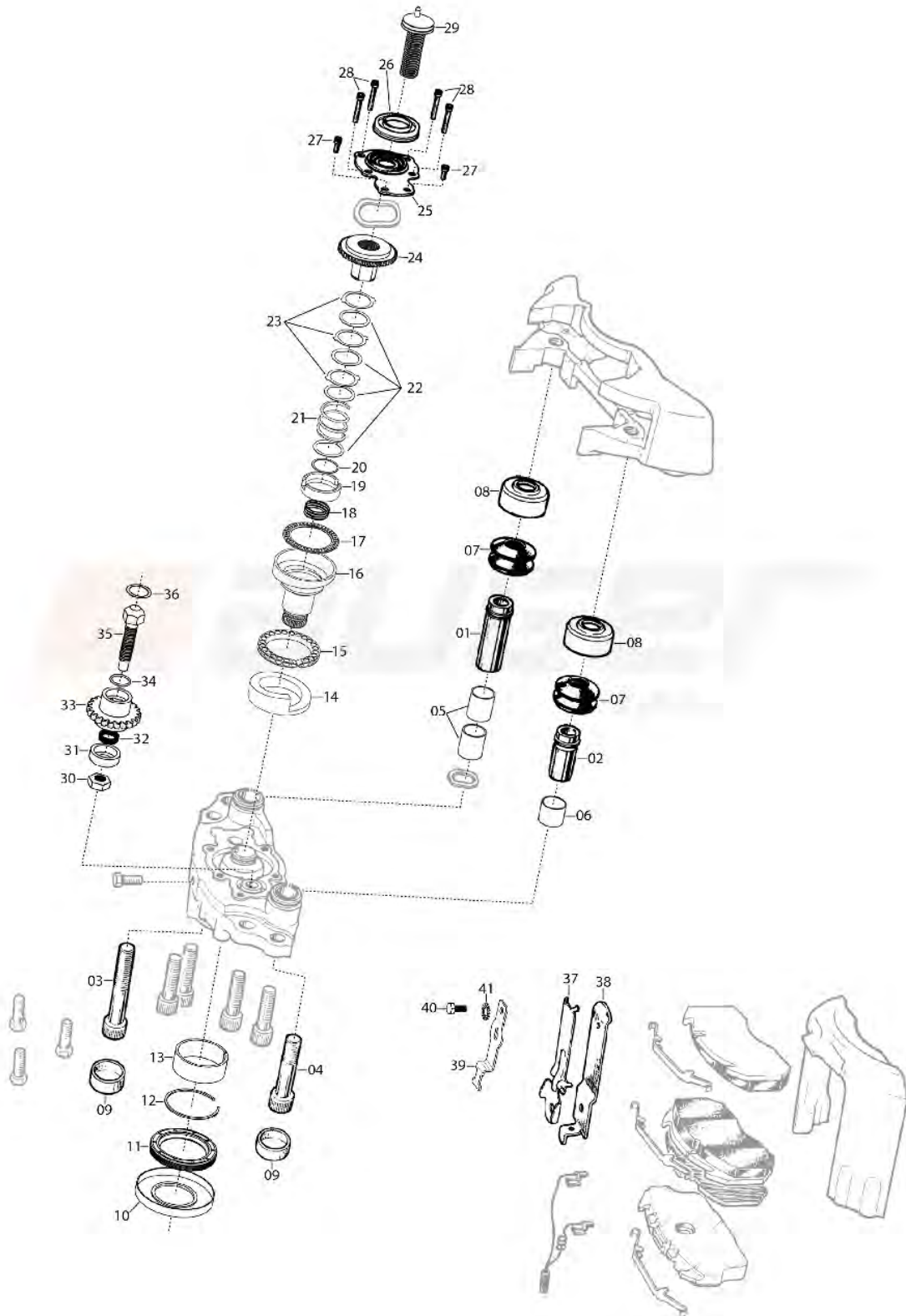





**Spare Parts**











| Sr. | Auger Nr. | O.E.M. Nr.   | Description                                   | Picture   | Sr. | Auger Nr. | O.E.M. Nr. | Description                                 | Picture   |
|-----|-----------|--------------|---|---|-----|-----------|------------|---|---|
| 01  | 72716     | -            | Pin<br>ø32x117                                |    | 01  | 72726     | -          | Pin<br>ø33x117                              |    |
| 02  | 72715     | -            | Pin<br>ø32x73                                 |    | 03  | 55298     | -          | Socket Head Bolt<br>M18x1,5/120             |    |
| 04  | 55297     | -            | Socket Head Bolt<br>M18x1,5/95                |    | 05  | 73009     | -          | Bushing<br>ø32xø36x40                       |    |
| 06  | 73008     | -            | Bushing<br>32/33xø36x30                       |    | 07  | 55368     | 68320499   | Rubber Seal<br>ø24/ø35                      |    |
| 08  | 72871     | -            | Cover<br>ø31xø59,5x17                         |  | 09  | 72872     | -          | Cover<br>ø37x10,5                           |  |
| 10  | 70697     | 68320507PK10 | Plastic Dust Cover<br>ø42,5                   |  | 11  | 72954     | -          | Seal Ring<br>ø50xø65x8                      |  |
| 12  | 72843     | -            | Retaining Ring                                |  | 13  | 73025     | -          | Bushing<br>ø50xø55x20                       |  |
| 14  | 73093     | -            | Support<br>ø80xø105x34,5 /<br>Left            |  | 14  | 73094     | -          | Support<br>ø80xø105x34,5 /<br>Right         |  |
| 15  | 56003     | -            | Ball Bearing<br>ø77xø105/ø12                  |  | 16  | 73088     | -          | Operating Shaft,<br>Left<br>48 Teeth / Left |  |
| 16  | 73089     | -            | Operating Shaft,<br>Right<br>48 Teeth / Right |  | 16  | 73090     | -          | Operating Shaft,<br>Left<br>26 Teeth / Left |  |











| Sr. | Auger Nr. | O.E.M. Nr. | Description                                    | Picture   | Sr. | Auger Nr. | O.E.M. Nr. | Description                                | Picture   |
|-----|-----------|------------|--|---|-----|-----------|------------|--|---|
| 16  | 73091     | -          | Operating Shaft, Right<br><br>26 Teeth / Right |    | 17  | 56004     | -          | Needle Bearing<br><br>ø70xø95/ø4           |    |
| 18  | 73045     | -          | Spring, Left<br><br>□2,5xø61x18 / Left         |    | 18  | 73046     | -          | Spring, Right<br><br>□2,5xø61x18 / Right   |    |
| 19  | 72850     | -          | Metal Bushing<br><br>ø54xø65,5x20,5            |    | 20  | 72846     | -          | Wire Ring<br><br>ø39,7xø45x1,2             |    |
| 21  | 73044     | -          | Spring<br><br>□4xø51x48                        |    | 22  | 72821     | -          | Shim                                       |    |
| 23  | 72822     | -          | Shim   |  | 24  | 73108     | -          | Adjuster Nut<br><br>M30x3,5 / 59,3         |  |
| 25  | 55346     | -          | Rubber Seal<br><br>ø8,5x90/ø42                 |  | 26  | 72677     | -          | Plastic Dust Cover<br><br>ø54              |  |
| 27  | 55330     | -          | Socket Head Bolt<br><br>M8x1,25/16             |  | 28  | 55329     | -          | Socket Head Bolt<br><br>M8x1,25/40         |  |
| 29  | 73166     | -          | Tappet<br><br>M30x3,5 / 120,5                  |  | 30  | 59314     | -          | Hexagon Nut<br><br>M10x1,5/8               |  |
| 31  | 72918     | -          | Special Washer<br><br>ø20x9,5                  |  | 32  | 73047     | -          | Spring, Left<br><br>□1,5xø21,5x11,5 / Left |  |
| 32  | 73048     | -          | Spring, Right<br><br>□1,5xø21,5x11,5 / Right   |  | 33  | 73092     | -          | Adjusting Sleeve<br><br>ø30x27,5           |  |



| Sr.   | Auger Nr. | O.E.M. Nr. | Description                       | Picture   | Sr.   | Auger Nr. | O.E.M. Nr. | Description                 | Picture   |
|-------|-----------|------------|-----------------------------------|---|-------|-----------|------------|-----------------------------|---|
| 34    | 72989     | -          | O-Ring<br>ø1,5xø7,5               |  | 35    | 72785     | -          | Special Bolts<br>M10x1,5/50 |  |
| 36    | 72845     | -          | Spring Washer<br>ø16,5xø21,5x0,25 |  | 37    | 72929     | -          | Retaining Plate             |  |
| 38    | 72930     | -          | Retaining Plate                   |  | 39    | 72931     | -          | Plate                       |  |
| 40    | 72786     | -          | Hexagon Head<br>Screw<br>M6x1/12  |  | 41    | 72828     | -          | Toothed Lock<br>Washer      |  |
| 60575 | -         | -          | Lubricant                         |   | 60279 | 68966036  | -          | Lubricant                   |   |
| 73206 | MBG1000   | -          | Lubricant                         |   | 73207 | -         | -          | Lubricant                   |   |

| Auger Nr. | OEM Nr.                     | Description               | Model | Picture   |
|-----------|-----------------------------|---------------------------|-------|---|
| 54175     | SJ4001                      | Repair Kit, Brake Caliper |       |  |
| 54546     | SJ1213                      | Repair Kit, Brake Caliper |       |  |
| 54549     | SJ4011<br>MCK1213<br>SJ1228 | Repair Kit, Brake Caliper |       |  |

| Auger Nr. | OEM Nr. | Description   | Model | Picture   |
|-----------|---------|---|-------|---|
| 56131     | -       | Repair Kit, Brake Caliper                           |       |    |
| 56132     | -       | Repair Kit, Brake Caliper                           |       |    |
| 56122     | -       | Repair Kit, Brake Caliper,<br>Left<br><br>48 Teeth  |       |   |
| 56123     | -       | Repair Kit, Brake Caliper,<br>Right<br><br>48 Teeth |       |  |
| 56124     | -       | Repair Kit, Brake Caliper,<br>Left<br><br>26 Teeth  |       |  |
| 56125     | -       | Repair Kit, Brake Caliper,<br>Right<br><br>26 Teeth |       |  |

| Auger Nr.    | OEM Nr. | Description                  | Model | Picture   |
|--------------|---------|------------------------------|-------|---|
| <b>71855</b> | -       | Repair Kit, Brake Caliper    |       |    |
| <b>56004</b> | -       | Needle Bearing<br>ø70xø95/ø4 |       |    |
| <b>57591</b> | -       | Repair Kit, Brake Caliper    |       |   |
| <b>56126</b> | -       | Repair Kit, Brake Caliper    |       |  |
| <b>56127</b> | -       | Repair Kit, Brake Caliper    |       |  |
| <b>56128</b> | -       | Repair Kit, Brake Caliper    |       |  |

| Auger Nr. | OEM Nr. | Description               | Model | Picture  |
|-----------|---------|---------------------------|-------|--|
| 56129     | -       | Repair Kit, Brake Caliper |       |   |
| 55176     | -       | Repair Kit, Brake Caliper |       |   |
| 56019     | SJ1212  | Repair Kit, Brake Caliper |       |  |



















| Auger Nr.    | OEM Nr.      | Description                 | Model | Picture  |
|--------------|--------------|-----------------------------|-------|--|
| <b>70692</b> | -            | Repair Kit, Brake Caliper   |       |   |
| <b>70697</b> | 68320507PK10 | Plastic Dust Cover<br>ø42,5 |       |   |
| <b>56148</b> | SJ4000       | Repair Kit, Brake Caliper   |       |  |









**Spare Parts**

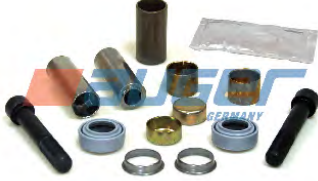

| Sr. | Auger Nr. | O.E.M. Nr. | Description                       | Picture   | Sr. | Auger Nr. | O.E.M. Nr. | Description                       | Picture   |
|-----|-----------|------------|-----------------------------------|---|-----|-----------|------------|-----------------------------------|---|
| 01  | 72724     | -          | Pin<br>ø35x102                    |    | 02  | 55316     | -          | Socket Head Bolt<br>M20x2/123,5   |    |
| 02A | 55315     | -          | Socket Head Bolt<br>M20x2/83      |    | 03  | 73006     | -          | Bushing<br>35/36xø39x30           |    |
| 04  | 72674     | -          | Plastic Bushing<br>ø35xø39,5x72,5 |    | 04A | 72672     | -          | Plastic Bushing<br>ø35,2xø39,2x38 |    |
| 05  | 72875     | -          | Cover<br>ø39,5x17,5               |    | 06  | 55369     | 68323751   | Rubber Seal<br>ø29                |    |
| 07  | 72813     | -          | Machined Washer<br>ø37xø39/ø40    |  | 08  | 72882     | -          | Cover<br>ø40x10,5                 |  |
| 09  | 55351     | -          | Rubber Seal<br>ø32xø43            |  | 10  | 72803     | -          | Machined Washer<br>ø43/ø48,5x12   |  |
| 11  | 72836     | -          | Circlip<br>ø31x1,2                |  | 12  | 72949     | -          | Seal Ring<br>ø42xø49/ø56          |  |
| 13  | 73120     | -          | Brake-Adjusting Mechanism         |  | 13  | 73122     | -          | Brake-Adjusting Mechanism         |  |
| 13  | 73139     | -          | Brake-Adjusting Mechanism         |  | 13  | 73140     | -          | Brake-Adjusting Mechanism         |  |
| 13  | 73175     | -          | Brake-Adjusting Mechanism         |  | 14  | 60330     | -          | Seal Ring<br>ø12xø22x7            |  |

| Sr.   | Auger Nr. | O.E.M. Nr. | Description                              | Picture   | Sr.   | Auger Nr. | O.E.M. Nr.   | Description                                | Picture   |
|-------|-----------|------------|--|---|-------|-----------|--------------|--|---|
| 15    | 72973     | -          | Gasket                                   |    | 16    | 72675     | -            | Plastic Bushing<br>ø45,2xø49x30            |    |
| 17    | 73030     | -          | Spring<br>ø49x60                         |    | 18    | 73123     | -            | Brake-Caliper Mechanism<br>ø45x110         |    |
| 19    | 73029     | -          | Spring<br>ø12,3x80                       |    | 20    | 60341     | 68322783     | Brake-Caliper Mechanism<br>M28x4,5 P3 LH   |    |
| 20    | 73119     | -          | Brake-Caliper Mechanism<br>M28x4,5 P3 RH |    | 21    | 57161     | 68322900PK10 | Lock Plate<br>58x120x5                     |    |
| 22    | 72736     | -          | Pin<br>ø16x38                            |  | 23    | 72893     | -            | Half Bearing<br>ø19,25xø16,25x8            |  |
| 24    | 73142     | -          | Operating Shaft                          |  | 25    | 72852     | -            | Half Needle Roller Bearing<br>ø49,7xø59x36 |  |
| 26    | 60343     | 68322297   | Rubber Seal<br>ø28xø63                   |  | 27    | 60566     | 68322655     | Rubber Dust Cap<br>ø28                     |  |
| 28    | 72680     | -          | Pad Pin                                  |  | 29    | 73039     | -            | Spring<br>ø14,5x80,5                       |  |
| 30    | 72905     | -          | Retaining Plate                          |  | 31    | 72769     | -            | Hexagon Head Screw<br>M10x1,25/20          |  |
| 73203 | MBG1001   | -          | Lubricant                                |   | 60579 | 68966091  | -            | Lubricant                                  |   |

| Auger Nr.    | OEM Nr. | Description               | Model | Picture   |
|--------------|---------|---------------------------|-------|---|
| <b>54553</b> | MCK1135 | Repair Kit, Brake Caliper |       |    |
| <b>54554</b> | MCK1299 | Repair Kit, Brake Caliper |       |    |
| <b>54556</b> | MCK1118 | Repair Kit, Brake Caliper |       |   |
| <b>53870</b> | MCK1139 | Repair Kit, Brake Caliper |       |  |
| <b>53871</b> | MCK1238 | Repair Kit, Brake Caliper |       |  |
| <b>55816</b> | MCK1236 | Repair Kit, Brake Caliper |       |  |

| Auger Nr.    | OEM Nr.      | Description               | Model | Picture |
|--------------|--------------|---------------------------|-------|---------|
| <b>55817</b> | MCK1237      | Repair Kit, Brake Caliper |       |         |
| <b>55820</b> | MCK1067      | Repair Kit, Brake Caliper |       |         |
| <b>57161</b> | 68322900PK10 | Lock Plate<br>58x120x5    |       |         |
| <b>55719</b> | MCK1113      | Repair Kit, Brake Caliper |       |         |
| <b>55721</b> | MCK1112      | Repair Kit, Brake Caliper |       |         |
| <b>56047</b> | SJ4102       | Repair Kit, Brake Caliper |       |         |
| <b>56048</b> | SJ4103       | Repair Kit, Brake Caliper |       |         |

| Auger Nr.    | OEM Nr. | Description               | Model | Picture   |
|--------------|---------|---------------------------|-------|---|
| <b>70696</b> | SJ4110  | Repair Kit, Brake Caliper |       |    |
| <b>56053</b> | SJ4108  | Repair Kit, Brake Caliper |       |    |
| <b>57581</b> | SJ4098  | Repair Kit, Brake Caliper |       |    |
| <b>55822</b> | SJ4109  | Repair Kit, Brake Caliper |       |  |
| <b>56049</b> | SJ4111  | Repair Kit, Brake Caliper |       |  |
| <b>56083</b> | MCK1264 | Repair Kit, Brake Caliper |       |  |





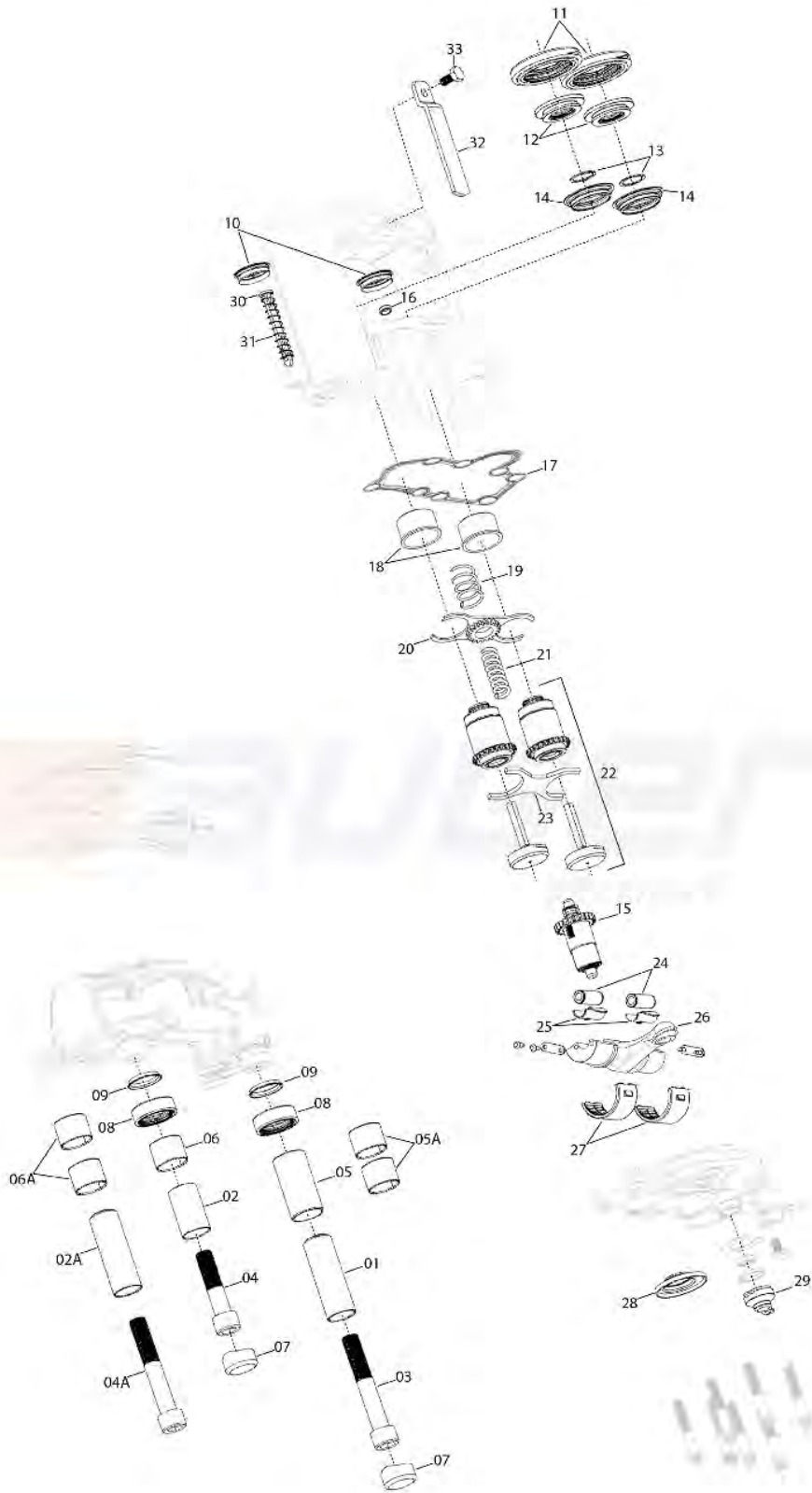



**Spare Parts**



| Sr. | Auger Nr. | O.E.M. Nr. | Description                       | Picture   | Sr. | Auger Nr. | O.E.M. Nr. | Description                       | Picture   |
|-----|-----------|------------|-----------------------------------|---|-----|-----------|------------|-----------------------------------|---|
| 01  | 72724     | -          | Pin<br>ø35x102                    |    | 02  | 72723     | -          | Pin<br>ø35x60                     |    |
| 02A | 72724     | -          | Pin<br>ø35x102                    |    | 03  | 55316     | -          | Socket Head Bolt<br>M20x2/123,5   |    |
| 04  | 55315     | -          | Socket Head Bolt<br>M20x2/83      |    | 04A | 55316     | -          | Socket Head Bolt<br>M20x2/123,5   |    |
| 05  | 72674     | -          | Plastic Bushing<br>ø35xø39,5x72,5 |    | 05A | 72672     | -          | Plastic Bushing<br>ø35,2xø39,2x38 |    |
| 06  | 73006     | -          | Bushing<br>35/36xø39x30           |  | 06A | 73006     | -          | Bushing<br>35/36xø39x30           |  |
| 07  | 72875     | -          | Cover<br>ø39,5x17,5               |  | 08  | 55369     | 68323751   | Rubber Seal<br>ø29                |  |
| 09  | 72813     | -          | Machined Washer<br>ø37xø39/ø40    |  | 10  | 72882     | -          | Cover<br>ø40x10,5                 |  |
| 11  | 55351     | -          | Rubber Seal<br>ø32xø43            |  | 12  | 72803     | -          | Machined Washer<br>ø43/ø48,5x12   |  |
| 13  | 72836     | -          | Circlip<br>ø31x1,2                |  | 14  | 72949     | -          | Seal Ring<br>ø42xø49/ø56          |  |
| 15  | 73120     | -          | Brake-Adjusting<br>Mechanism      |  | 15  | 73121     | -          | Brake-Adjusting<br>Mechanism      |  |

| Sr. | Auger Nr. | O.E.M. Nr.   | Description                              | Picture | Sr. | Auger Nr. | O.E.M. Nr.  | Description                                | Picture |
|-----|-----------|--------------|--|---------|-----|-----------|-------------|--|---------|
| 15  | 73122     | -            | Brake-Adjusting Mechanism                |         | 15  | 73139     | -           | Brake-Adjusting Mechanism                  |         |
| 15  | 73140     | -            | Brake-Adjusting Mechanism                |         | 15  | 73175     | -           | Brake-Adjusting Mechanism                  |         |
| 16  | 60330     | -            | Seal Ring<br>ø12xø22x7                   |         | 17  | 72974     | 68322774PK4 | Gasket                                     |         |
| 18  | 72675     | -            | Plastic Bushing<br>ø45,2xø49x30          |         | 19  | 73030     | -           | Spring<br>ø49x60                           |         |
| 20  | 73123     | -            | Brake-Caliper Mechanism<br>ø45x110       |         | 21  | 73029     | -           | Spring<br>ø12,3x80                         |         |
| 22  | 60341     | 68322783     | Brake-Caliper Mechanism<br>M28x4,5 P3 LH |         | 22  | 73119     | -           | Brake-Caliper Mechanism<br>M28x4,5 P3 RH   |         |
| 23  | 57161     | 68322900PK10 | Lock Plate<br>58x120x5                   |         | 24  | 72736     | -           | Pin<br>ø16x38                              |         |
| 25  | 72902     | -            | Half Bearing<br>ø19,25xø16,25x13         |         | 26  | 73150     | -           | Operating Shaft<br>153 / Left              |         |
| 26  | 73151     | -            | Operating Shaft<br>153 / Right           |         | 27  | 72852     | -           | Half Needle Roller Bearing<br>ø49,7xø59x36 |         |
| 28  | 60343     | 68322297     | Rubber Seal<br>ø28xø63                   |         | 29  | 60566     | 68322655    | Rubber Dust Cap<br>ø28                     |         |

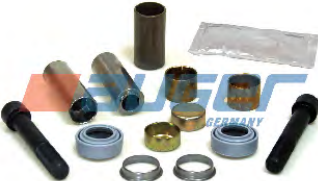

| Sr.   | Auger Nr. | O.E.M. Nr. | Description     | Picture   | Sr.   | Auger Nr. | O.E.M. Nr. | Description                          | Picture   |
|-------|-----------|------------|-----------------|---|-------|-----------|------------|--------------------------------------|---|
| 30    | 72680     | -          | Pad Pin         |  | 31    | 73039     | -          | Spring<br>ø14,5x80,5                 |  |
| 32    | 72905     | -          | Retaining Plate |  | 33    | 72769     | -          | Hexagon Head<br>Screw<br>M10x1,25/20 |  |
| 73203 | MBG1001   |            | Lubricant       |   | 60579 | 68966091  |            | Lubricant                            |   |

| Auger Nr.    | OEM Nr.            | Description               | Model | Picture   |
|--------------|--------------------|---------------------------|-------|---|
| <b>54530</b> | MCK1134<br>SJ4094  | Repair Kit, Brake Caliper |       |   |
| <b>54551</b> | MCK1116            | Repair Kit, Brake Caliper |       |  |
| <b>54554</b> | MCK1299<br>MCK1066 | Repair Kit, Brake Caliper |       |  |
| <b>54556</b> | MCK1118            | Repair Kit, Brake Caliper |       |  |



| Auger Nr.    | OEM Nr.      | Description               | Model | Picture   |
|--------------|--------------|---------------------------|-------|---|
| <b>53870</b> | MCK1139      | Repair Kit, Brake Caliper |       |    |
| <b>53871</b> | MCK1238      | Repair Kit, Brake Caliper |       |    |
| <b>55816</b> | MCK1236      | Repair Kit, Brake Caliper |       |   |
| <b>55817</b> | MCK1237      | Repair Kit, Brake Caliper |       |  |
| <b>55820</b> | MCK1067      | Repair Kit, Brake Caliper |       |  |
| <b>57161</b> | 68322900PK10 | Lock Plate<br>58x120x5    |       |  |

| Auger Nr.    | OEM Nr. | Description               | Model | Picture   |
|--------------|---------|---------------------------|-------|---|
| <b>55719</b> | MCK1113 | Repair Kit, Brake Caliper |       |    |
| <b>55720</b> | MCK1111 | Repair Kit, Brake Caliper |       |    |
| <b>55721</b> | MCK1112 | Repair Kit, Brake Caliper |       |   |
| <b>56047</b> | SJ4102  | Repair Kit, Brake Caliper |       |  |
| <b>56048</b> | SJ4103  | Repair Kit, Brake Caliper |       |  |
| <b>70696</b> | SJ4110  | Repair Kit, Brake Caliper |       |  |



| Auger Nr.    | OEM Nr. | Description               | Model | Picture  |
|--------------|---------|---------------------------|-------|--|
| <b>56071</b> | SJ4096  | Repair Kit, Brake Caliper |       |   |
| <b>56072</b> | SJ4097  | Repair Kit, Brake Caliper |       |   |
| <b>55819</b> | SJ4112  | Repair Kit, Brake Caliper |       |  |







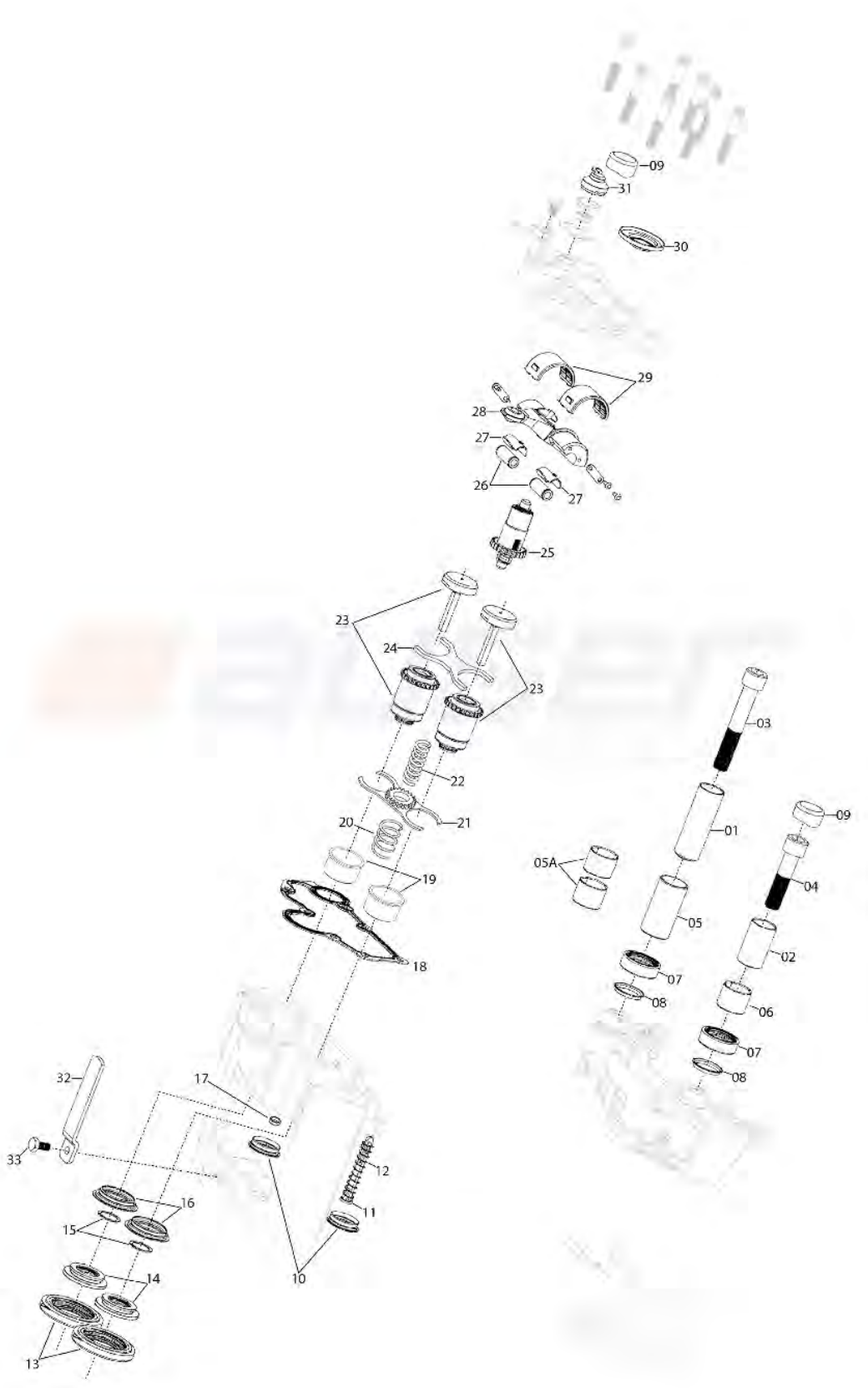













# MERITOR / ROR D DUCO AXIAL TYPE CALIPER

| Auger Nr.    | OEM Nr. | Description               | Model | Picture  |
|--------------|---------|---------------------------|-------|--|
| <b>55823</b> | SJ4105  | Repair Kit, Brake Caliper |       |   |
| <b>56049</b> | SJ4111  | Repair Kit, Brake Caliper |       |   |
| <b>56083</b> | MCK1264 | Repair Kit, Brake Caliper |       |  |

**Spare Parts**



| Sr. | Auger Nr. | O.E.M. Nr. | Description                     | Picture   | Sr. | Auger Nr. | O.E.M. Nr. | Description                     | Picture   |
|-----|-----------|------------|---------------------------------|---|-----|-----------|------------|---------------------------------|---|
| 01  | 72724     | -          | Pin<br>ø35x102                  |    | 02  | 72723     | -          | Pin<br>ø35x60                   |    |
| 03  | 55316     | -          | Socket Head Bolt<br>M20x2/123,5 |    | 04  | 55315     | -          | Socket Head Bolt<br>M20x2/83    |    |
| 05  | 72674     | -          | Bushing<br>ø35xø39,5x72,5       |    | 05A | 72672     | -          | Bushing<br>ø35,2xø39,2x38       |    |
| 06  | 73006     | -          | Bushing<br>35/36xø39x30         |    | 07  | 55369     | 68323751   | Rubber Seal<br>ø29              |    |
| 08  | 72813     | -          | Machined Washer<br>ø37xø39/ø40  |  | 09  | 72875     | -          | Cover<br>ø39,5x17,5             |  |
| 10  | 72882     | -          | Cover<br>ø40x10,5               |  | 11  | 72680     | -          | Pad Pin                         |  |
| 12  | 73039     | -          | Spring<br>ø14,5x80,5            |  | 13  | 55351     | -          | Rubber Seal<br>ø32xø43          |  |
| 14  | 72803     | -          | Machined Washer<br>ø43/ø48,5x12 |  | 15  | 72836     | -          | Circlip<br>ø31x1,2              |  |
| 16  | 72949     | -          | Seal Ring<br>ø42xø49/ø56        |  | 17  | 60330     | -          | Seal Ring<br>ø12xø22x7          |  |
| 18  | 60333     | -          | Gasket                          |  | 19  | 72675     | -          | Plastic Bushing<br>ø45,2xø49x30 |  |

| Sr. | Auger Nr. | O.E.M. Nr. | Description                              | Picture   | Sr. | Auger Nr. | O.E.M. Nr.   | Description                                | Picture   |
|-----|-----------|------------|--|---|-----|-----------|--------------|--|---|
| 20  | 73038     | -          | Spring<br>ø30,5x51                       |    | 21  | 73138     | -            | Brake-Caliper Mechanism<br>ø45x88          |    |
| 22  | 73037     | -          | Spring<br>ø21x71                         |    | 23  | 60341     | 68322783     | Brake-Caliper Mechanism<br>M28x4,5 P3 LH   |    |
| 23  | 73119     | -          | Brake-Caliper Mechanism<br>M28x4,5 P3 RH |    | 24  | 70698     | 68322485PK10 | Lock Plate<br>58x98x5                      |    |
| 25  | 73120     | -          | Brake-Adjusting Mechanism                |    | 25  | 73121     | -            | Brake-Adjusting Mechanism                  |    |
| 25  | 73139     | -          | Brake-Adjusting Mechanism                |  | 25  | 73140     | -            | Brake-Adjusting Mechanism                  |  |
| 25  | 73175     | -          | Brake-Adjusting Mechanism                |  | 26  | 72736     | -            | Pin<br>ø16x38                              |  |
| 27  | 72902     | -          | Half Bearing<br>ø19,25xø16,25x13         |  | 28  | 73157     | -            | Operating Shaft<br>131 / Right             |  |
| 28  | 73158     | -          | Operating Shaft<br>131 / Left            |  | 29  | 72852     | -            | Half Needle Roller Bearing<br>ø49,7xø59x36 |  |
| 30  | 60343     | 68322297   | Rubber Seal<br>ø28xø63                   |  | 31  | 60566     | 68322655     | Rubber Dust Cap<br>ø28                     |  |
| 32  | 72905     | -          | Retaining Plate                          |  | 33  | 72769     | -            | Hexagon Head Screw<br>M10x1,25/20          |  |

# MERITOR / ROR



## C DUCO - LE DUCO TYPE CALIPER



| Sr. | Auger Nr. | O.E.M. Nr. | Description | Picture | Sr. | Auger Nr. | O.E.M. Nr. | Description | Picture |
|-----|-----------|------------|-------------|---------|-----|-----------|------------|-------------|---------|
|     | 73203     | MBG1001    | Lubricant   |         |     | 60579     | 68966091   | Lubricant   |         |

| Auger Nr.    | OEM Nr.            | Description               | Model | Picture   |
|--------------|--------------------|---------------------------|-------|---|
| <b>54530</b> | MCK1134<br>SJ4094  | Repair Kit, Brake Caliper |       |    |
| <b>54551</b> | MCK1116            | Repair Kit, Brake Caliper |       |    |
| <b>54554</b> | MCK1299<br>MCK1066 | Repair Kit, Brake Caliper |       |   |
| <b>53870</b> | MCK1139            | Repair Kit, Brake Caliper |       |  |
| <b>53871</b> | MCK1238            | Repair Kit, Brake Caliper |       |  |
| <b>55816</b> | MCK1236            | Repair Kit, Brake Caliper |       |  |



| Auger Nr.    | OEM Nr.      | Description               | Model | Picture   |
|--------------|--------------|---------------------------|-------|---|
| <b>55817</b> | MCK1237      | Repair Kit, Brake Caliper |       |    |
| <b>56046</b> | MCK1129      | Repair Kit, Brake Caliper |       |    |
| <b>70698</b> | 68322485PK10 | Lock Plate<br>58x98x5     |       |    |
| <b>55719</b> | MCK1113      | Repair Kit, Brake Caliper |       |  |
| <b>55720</b> | MCK1111      | Repair Kit, Brake Caliper |       |  |
| <b>56047</b> | SJ4102       | Repair Kit, Brake Caliper |       |  |
| <b>56048</b> | SJ4103       | Repair Kit, Brake Caliper |       |  |

| Auger Nr.    | OEM Nr. | Description               | Model | Picture   |
|--------------|---------|---------------------------|-------|---|
| <b>70696</b> | SJ4110  | Repair Kit, Brake Caliper |       |    |
| <b>57343</b> | MCK1127 | Repair Kit, Brake Caliper |       |    |
| <b>57344</b> | MCK1128 | Repair Kit, Brake Caliper |       |    |
| <b>55819</b> | SJ4112  | Repair Kit, Brake Caliper |       |  |
| <b>55821</b> | MCK1041 | Repair Kit, Brake Caliper |       |  |
| <b>56049</b> | SJ4111  | Repair Kit, Brake Caliper |       |  |
| <b>56083</b> | MCK1264 | Repair Kit, Brake Caliper |       |  |

**Spare Parts**







| Sr. | Auger Nr. | O.E.M. Nr. | Description                       | Picture   | Sr. | Auger Nr. | O.E.M. Nr. | Description                              | Picture   |
|-----|-----------|------------|-----------------------------------|---|-----|-----------|------------|--|---|
| 01  | 72724     | -          | Pin<br>ø35x102                    |    | 02  | 72723     | -          | Pin<br>ø35x60                            |    |
| 03  | 55316     | -          | Socket Head Bolt<br>M20x2/123,5   |    | 04  | 55315     | -          | Socket Head Bolt<br>M20x2/83             |    |
| 05  | 72674     | -          | Plastic Bushing<br>ø35xø39,5x72,5 |    | 05A | 72672     | -          | Plastic Bushing<br>ø35,2xø39,2x38        |    |
| 06  | 73006     | -          | Bushing<br>35/36xø39x30           |    | 07  | 55369     | 68323751   | Rubber Seal<br>ø29                       |    |
| 08  | 72813     | -          | Machined Washer<br>ø37xø39/ø40    |  | 09  | 72875     | -          | Cover<br>ø39,5x17,5                      |  |
| 10  | 72882     | -          | Cover<br>ø40x10,5                 |  | 11  | 72680     | -          | Pad Pin                                  |  |
| 12  | 73039     | -          | Spring<br>ø14,5x80,5              |  | 13  | 55351     | -          | Rubber Seal<br>ø32xø43                   |  |
| 14  | 72803     | -          | Machined Washer<br>ø43/ø48,5x12   |  | 15  | 72836     | -          | Circlip<br>ø31x1,2                       |  |
| 16  | 72949     | -          | Seal Ring<br>ø42xø49/ø56          |  | 17  | 60330     | -          | Seal Ring<br>ø12xø22x7                   |  |
| 18  | 72682     | -          | Plastic Bushing<br>ø45,2xø49x25,3 |  | 19  | 73141     | -          | Brake-Caliper<br>Mechanism<br>M28x4,5 P3 |  |

| Sr. | Auger Nr. | O.E.M. Nr. | Description                                | Picture | Sr. | Auger Nr. | O.E.M. Nr. | Description                       | Picture |
|-----|-----------|------------|--|---------|-----|-----------|------------|-----------------------------------|---------|
| 20  | 73168     | -          | Brake-Adjusting Mechanism<br>ø20/ø32       |         | 21  | 72736     | -          | Pin<br>ø16x38                     |         |
| 22  | 72902     | -          | Half Bearing<br>ø19,25xø16,25x13           |         | 23  | 73159     | -          | Operating Shaft                   |         |
| 24  | 72852     | -          | Half Needle Roller Bearing<br>ø49,7xø59x36 |         | 25  | 72829     | -          | Washer                            |         |
| 26  | 72859     | -          | Bearing<br>ø20xø34,7x2                     |         | 27  | 73169     | -          | Bearing<br>ø20                    |         |
| 27  | 73170     | -          | Bearing<br>ø20                             |         | 28  | 60343     | 68322297   | Rubber Seal<br>ø28xø63            |         |
| 29  | 60566     | 68322655   | Rubber Dust Cap<br>ø28                     |         | 30  | 73177     | -          | Adjusting Device, Right           |         |
| 30  | 73178     | -          | Adjusting Device, Left                     |         | 31  | 73060     | -          | Spring<br>ø17x25,5                |         |
| 32  | 72790     | -          | Hexagon Head Screw<br>M6x1/16              |         | 33  | 73167     | -          | Adjuster Device                   |         |
| 34  | 73058     | -          | Spring<br>ø17x22                           |         | 35  | 72904     | -          | Retaining Plate                   |         |
| 35  | 72905     | -          | Retaining Plate                            |         | 36  | 72769     | -          | Hexagon Head Screw<br>M10x1,25/20 |         |





| Sr. | Auger Nr.    | O.E.M. Nr. | Description | Picture |
|-----|--------------|------------|-------------|---------|
|     | <b>73203</b> | MBG1001    | Lubricant   |         |

| Sr. | Auger Nr.    | O.E.M. Nr. | Description | Picture |
|-----|--------------|------------|-------------|---------|
|     | <b>60579</b> | 68966091   | Lubricant   |         |

| Auger Nr.    | OEM Nr.            | Description               | Model | Picture   |
|--------------|--------------------|---------------------------|-------|---|
| <b>54530</b> | MCK1134<br>SJ4094  | Repair Kit, Brake Caliper |       |    |
| <b>54551</b> | MCK1116            | Repair Kit, Brake Caliper |       |    |
| <b>54554</b> | MCK1299<br>MCK1066 | Repair Kit, Brake Caliper |       |  |
| <b>53870</b> | MCK1139            | Repair Kit, Brake Caliper |       |  |
| <b>53871</b> | MCK1238            | Repair Kit, Brake Caliper |       |  |









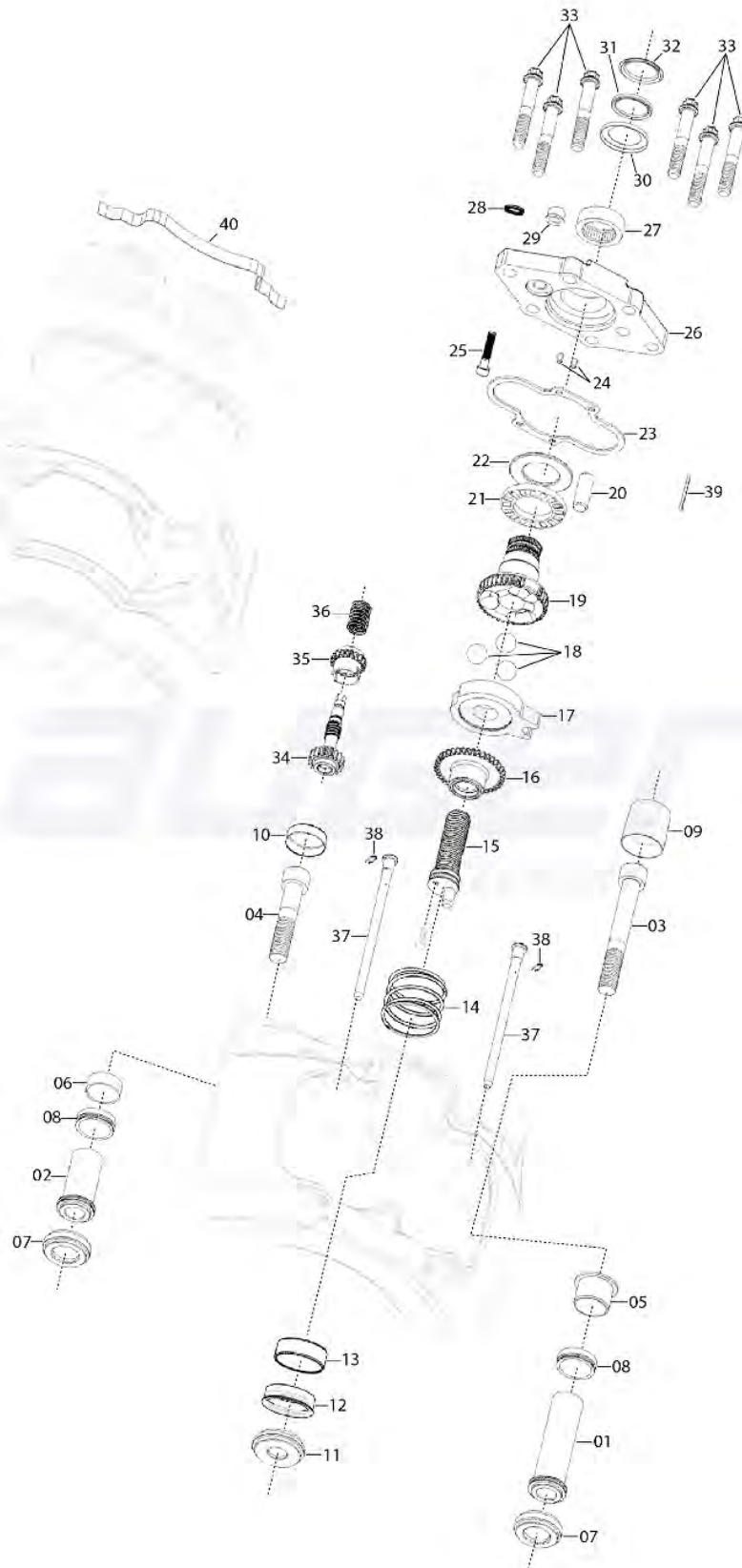























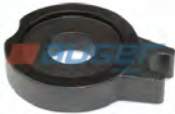
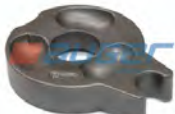







| Auger Nr.    | OEM Nr. | Description                      | Model | Picture   |
|--------------|---------|----------------------------------|-------|---|
| <b>56051</b> | MCK1239 | Repair Kit, Brake Caliper        |       |    |
| <b>57593</b> | MCK1050 | Repair Kit, Brake Caliper        |       |    |
| <b>57345</b> | MCK1048 | Repair Kit, Brake Caliper        |       |   |
| <b>55819</b> | SJ4112  | Repair Kit, Brake Caliper        |       |  |
| <b>70688</b> | -       | Repair Kit, Brake Caliper, Right |       |  |
| <b>70689</b> | -       | Repair Kit, Brake Caliper, Left  |       |  |









| Auger Nr.    | OEM Nr.  | Description               | Model | Picture   |
|--------------|----------|---------------------------|-------|---|
| <b>57592</b> | MCK1107  | Repair Kit, Brake Caliper |       |    |
| <b>56049</b> | SJ4111   | Repair Kit, Brake Caliper |       |    |
| <b>56082</b> | MCK1263  | Repair Kit, Brake Caliper |       |   |
| <b>56083</b> | MCK1264  | Repair Kit, Brake Caliper |       |  |
| <b>60566</b> | 68322655 | Rubber Dust Cap<br>ø28    |       |  |



**Spare Parts**







| Sr. | Auger Nr. | O.E.M. Nr. | Description                            | Picture   | Sr. | Auger Nr. | O.E.M. Nr. | Description                              | Picture   |
|-----|-----------|------------|--|---|-----|-----------|------------|--|---|
| 01  | 73116     | -          | Bush+Washer<br>Assembly<br><br>ø30x115 |    | 02  | 73115     | -          | Bush+Washer<br>Assembly<br><br>ø30x75    |    |
| 03  | 55317     | -          | Socket Head Bolt<br><br>M18x1,5/135    |    | 04  | 55297     | -          | Socket Head Bolt<br><br>M18x1,5/95       |    |
| 05  | 72673     | -          | Plastic Bushing<br><br>ø30xø34x26      |    | 06  | 73007     | -          | Bushing<br><br>30/31xø34x26              |    |
| 07  | 55366     | -          | Rubber Seal<br><br>ø27                 |    | 08  | 72812     | -          | Machined Washer<br><br>ø32xø39x12,2      |    |
| 09  | 72876     | -          | Cover<br><br>ø42x44                    |  | 10  | 72872     | -          | Cover<br><br>ø37x10,5                    |  |
| 11  | 55367     | 68321293   | Rubber Seal<br><br>ø22/ø32,5           |  | 12  | 72896     | -          | Cover<br><br>ø44x12,5                    |  |
| 13  | 73015     | -          | Bushing<br><br>ø40,5xø44,5x15          |  | 14  | 73034     | -          | Spring<br><br>ø66x44                     |  |
| 15  | 73130     | -          | Tappet, Left<br><br>110/M27x3 / Left   |  | 15  | 73131     | -          | Tappet, Right<br><br>110/M27x3 / Right   |  |
| 15  | 73181     | -          | Tappet, Left<br><br>110/M27x3 / Left   |  | 15  | 73182     | -          | Tappet, Right<br><br>110/M27x3 / Right   |  |
| 16  | 73069     | -          | Adjuster Nut, Left<br><br>M27x3 / Left |  | 16  | 73070     | -          | Adjuster Nut, Right<br><br>M27x3 / Right |  |

| Sr. | Auger Nr. | O.E.M. Nr. | Description                      | Picture   | Sr. | Auger Nr. | O.E.M. Nr. | Description                                   | Picture   |
|-----|-----------|------------|----------------------------------|---|-----|-----------|------------|---|---|
| 17  | 73067     | -          | Shaft Base                       |    | 17  | 73068     | -          | Shaft Base                                    |    |
| 18  | 73066     | -          | Ball<br>ø22,225                  |    | 19  | 73126     | -          | Operating Shaft, Left<br>ø45x83               |    |
| 19  | 73127     | -          | Operating Shaft, Right<br>ø45x83 |    | 20  | 72740     | -          | Pin<br>ø16x75,75                              |    |
| 21  | 72854     | -          | Bearing<br>ø44,5xø72,5x9         |    | 22  | 72817     | -          | Machined Washer<br>ø47xø73x3,5                |    |
| 23  | 72962     | -          | Gasket                           |  | 24  | 72890     | -          | Roll Pin<br>ø6x12                             |  |
| 25  | 57571     | -          | Socket Head Bolt<br>M10x1,5/50   |  | 26  | 73143     | -          | Plate Assembly                                |  |
| 26  | 73144     | -          | Plate Assembly                   |  | 27  | 72853     | -          | Needle Roller Bearing<br>ø45xø52x16           |  |
| 28  | 72963     | -          | Gasket<br>ø9,3xø13x1,8           |  | 29  | 55382     | 68321006   | Rubber Seal<br>ø11,7                          |  |
| 30  | 72881     | -          | Cover<br>ø42xø60x6               |  | 31  | 72944     | -          | Seal Ring<br>ø40xø52x5,5                      |  |
| 32  | 72945     | -          | Seal Ring<br>ø40xø57x4,5         |  | 33  | 57570     | -          | Hexagon Bolt With Astral Flange<br>M14x1,5/90 |  |



| Sr.   | Auger Nr. | O.E.M. Nr. | Description            | Picture   | Sr.   | Auger Nr. | O.E.M. Nr. | Description           | Picture   |
|-------|-----------|------------|------------------------|---|-------|-----------|------------|-----------------------|---|
| 34    | 73124     | -          | Adjuster Device, Right |  | 34    | 73125     | -          | Adjuster Device, Left |  |
| 35    | 73065     | -          | Adjusting Sleeve       |  | 36    | 73033     | -          | Spring<br>ø25x46,5    |  |
| 37    | 72750     | -          | Pin                    |  | 38    | 72798     | -          | Split pin             |  |
| 39    | 72468     | -          | Split pin              |  | 40    | 72907     | -          | Spring Clamp          |  |
| 73206 | MBG1000   | -          | Lubricant              |   | 73207 | -         | Lubricant  |                       |   |



| Auger Nr. | OEM Nr. | Description               | Model | Picture   |
|-----------|---------|---------------------------|-------|---|
| 54532     | SJ4052  | Repair Kit, Brake Caliper |       |  |
| 54555     | SJ4053  | Repair Kit, Brake Caliper |       |  |
| 56045     | SJ4061  | Repair Kit, Brake Caliper |       |  |



| Auger Nr.    | OEM Nr.            | Description                                       | Model | Picture   |
|--------------|--------------------|---|-------|---|
| <b>56059</b> | MCK1075            | Repair Kit, Brake Caliper                         |       |    |
| <b>56060</b> | MCK1076            | Repair Kit, Brake Caliper                         |       |    |
| <b>56029</b> | MCK1151<br>MCK1021 | Repair Kit, Brake Caliper,<br>Left                |       |   |
| <b>56030</b> | MCK1152<br>MCK1022 | Repair Kit, Brake Caliper,<br>Right               |       |  |
| <b>57586</b> | -                  | Repair Kit, Brake Caliper,<br>Left<br><br>ø45x83  |       |  |
| <b>57587</b> | -                  | Repair Kit, Brake Caliper,<br>Right<br><br>ø45x83 |       |  |



| Auger Nr.    | OEM Nr. | Description                                       | Model | Picture   |
|--------------|---------|---|-------|---|
| <b>56114</b> | -       | Repair Kit, Brake Caliper                         |       |    |
| <b>56115</b> | -       | Repair Kit, Brake Caliper                         |       |    |
| <b>56116</b> | -       | Repair Kit, Brake Caliper                         |       |   |
| <b>56033</b> | SJ4073  | Repair Kit, Brake Caliper,<br>Left                |       |  |
| <b>56034</b> | SJ4074  | Repair Kit, Brake Caliper,<br>Right               |       |  |
| <b>71657</b> | SJ4056  | Repair Kit, Brake Caliper,<br>Left<br><br>M27x3 L |       |  |

| Auger Nr.    | OEM Nr.           | Description  | Model | Picture  |
|--------------|-------------------|--|-------|--|
| <b>71658</b> | SJ4057            | Repair Kit, Brake Caliper,<br>Right<br><br>M27x3 R |       |   |
| <b>56040</b> | SJ4113<br>MCK4113 | Repair Kit, Brake Caliper,<br>Left                 |       |   |
| <b>56018</b> | SJ4114            | Repair Kit, Brake Caliper,<br>Right                |       |  |

| Auger Nr.    | OEM Nr. | Description               | Model | Picture   |
|--------------|---------|---------------------------|-------|---|
| <b>56028</b> | SJ4031  | Repair Kit, Brake Caliper |       |  |
| <b>56086</b> | SJ4051  | Repair Kit, Brake Caliper |       |  |

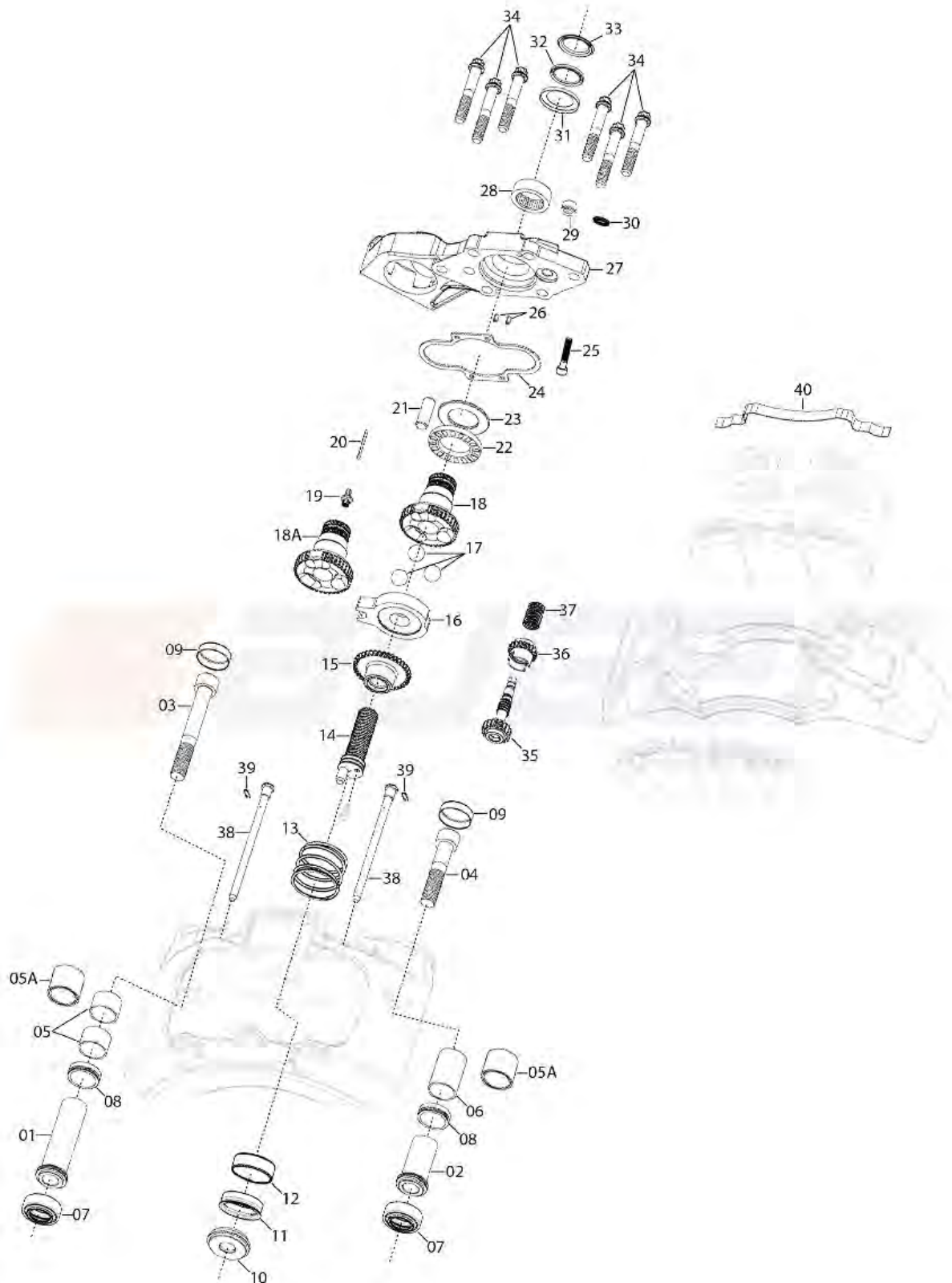

**Spare Parts**









| Sr. | Auger Nr. | O.E.M. Nr. | Description                        | Picture   | Sr. | Auger Nr. | O.E.M. Nr. | Description                          | Picture   |
|-----|-----------|------------|------------------------------------|---|-----|-----------|------------|--------------------------------------|---|
| 01  | 73114     | -          | Bush+Washer Assembly<br>ø35x131    |    | 02  | 73113     | -          | Bush+Washer Assembly<br>ø35x78,5     |    |
| 03  | 55301     | -          | Socket Head Bolt<br>M20x1,5/150    |    | 04  | 55305     | -          | Socket Head Bolt<br>M20x1,5/100      |    |
| 05  | 72995     | -          | Bushing<br>ø35xø39x30              |    | 05A | 73112     | -          | Composite Bushing<br>ø35xø41x30,5    |    |
| 06  | 72997     | -          | Bushing<br>35/36xø39x42,5          |    | 07  | 55364     | 68321294   | Rubber Seal<br>ø30                   |    |
| 07  | 55365     | -          | Rubber Seal<br>ø29                 |  | 07  | 55369     | 68323751   | Rubber Seal<br>ø29                   |  |
| 08  | 72804     | -          | Machined Washer<br>ø37/ø43x12      |  | 09  | 72865     | -          | Cover<br>ø45x12                      |  |
| 10  | 55367     | 68321293   | Rubber Seal<br>ø22/ø32,5           |  | 11  | 72896     | -          | Cover<br>ø44x12,5                    |  |
| 12  | 73015     | -          | Bushing<br>ø40,5xø44,5x15          |  | 13  | 73034     | -          | Spring<br>ø66x44                     |  |
| 14  | 73130     | -          | Tappet, Left<br>110/M27x3 / Left   |  | 14  | 73131     | -          | Tappet, Right<br>110/M27x3 / Right   |  |
| 15  | 73069     | -          | Adjuster Nut, Left<br>M27x3 / Left |  | 15  | 73070     | -          | Adjuster Nut, Right<br>M27x3 / Right |  |



| Sr. | Auger Nr. | O.E.M. Nr. | Description                       | Picture   | Sr. | Auger Nr. | O.E.M. Nr. | Description                         | Picture   |
|-----|-----------|------------|-----------------------------------|---|-----|-----------|------------|-------------------------------------|---|
| 16  | 73067     | -          | Shaft Base                        |    | 16  | 73068     | -          | Shaft Base                          |    |
| 17  | 73066     | -          | Ball<br>ø22,225                   |    | 18  | 73126     | -          | Operating Shaft, Left<br>ø45x83     |    |
| 18  | 73127     | -          | Operating Shaft, Right<br>ø45x83  |    | 18A | 73179     | -          | Operating Shaft, Left<br>ø45x126    |    |
| 18A | 73180     | -          | Operating Shaft, Right<br>ø45x126 |    | 19  | 59848     | -          | Grease Nipple                       |    |
| 20  | 72468     | -          | Split pin                         |  | 21  | 72740     | -          | Pin<br>ø16x75,75                    |  |
| 22  | 72854     | -          | Bearing<br>ø44,5xø72,5x9          |  | 23  | 72817     | -          | Machined Washer<br>ø47xø73x3,5      |  |
| 24  | 72962     | -          | Gasket                            |  | 25  | 57571     | -          | Socket Head Bolt<br>M10x1,5/50      |  |
| 26  | 72890     | -          | Roll Pin<br>ø6x12                 |  | 27  | 73143     | -          | Plate Assembly                      |  |
| 27  | 73144     | -          | Plate Assembly                    |  | 27  | 73145     | -          | Plate Assembly                      |  |
| 27  | 73146     | -          | Plate Assembly                    |  | 28  | 72853     | -          | Needle Roller Bearing<br>ø45xø52x16 |  |

| Sr. | Auger Nr. | O.E.M. Nr. | Description               | Picture   | Sr.   | Auger Nr. | O.E.M. Nr. | Description                                      | Picture   |
|-----|-----------|------------|---------------------------|---|-------|-----------|------------|--|---|
| 29  | 55382     | 68321006   | Rubber Seal<br>ø11,7      |    | 30    | 72963     | -          | Gasket<br>ø9,3xø13x1,8                           |    |
| 31  | 72881     | -          | Cover<br>ø42xø60x6        |    | 32    | 72944     | -          | Seal Ring<br>ø40xø52x5,5                         |    |
| 33  | 72945     | -          | Seal Ring<br>ø40xø57x4,5  |    | 34    | 57570     | -          | Hexagon Bolt With<br>Astral Flange<br>M14x1,5/90 |    |
| 35  | 73124     | -          | Adjuster Device,<br>Right |    | 35    | 73125     | -          | Adjuster Device,<br>Left                         |    |
| 36  | 73065     | -          | Adjusting Sleeve          |  | 37    | 73033     | -          | Spring<br>ø25x46,5                               |  |
| 38  | 72751     | -          | Pin<br>ø10x187,5          |  | 39    | 72798     | -          | Split pin  |  |
| 40  | 72908     | -          | Spring Clamp              |  | 73206 | MBG1000   | -          | Lubricant  |   |
|     |           |            |                           |   | 73207 | -         | -          | Lubricant  |   |

| Auger Nr.    | OEM Nr.           | Description               | Model | Picture |
|--------------|-------------------|---------------------------|-------|---------|
| <b>54548</b> | SJ4076<br>MCK1104 | Repair Kit, Brake Caliper |       |         |
| <b>53874</b> | -                 | Repair Kit, Brake Caliper |       |         |
| <b>54531</b> | SJ4077            | Repair Kit, Brake Caliper |       |         |
| <b>54547</b> | SJ4078            | Repair Kit, Brake Caliper |       |         |
| <b>56017</b> | SJ4032            | Repair Kit, Brake Caliper |       |         |
| <b>54552</b> | SJ4021            | Repair Kit, Brake Caliper |       |         |
| <b>56088</b> | -                 | Repair Kit, Brake Caliper |       |         |

| Auger Nr.    | OEM Nr.            | Description                      | Model | Picture   |
|--------------|--------------------|----------------------------------|-------|---|
| <b>56028</b> | SJ4031             | Repair Kit, Brake Caliper        |       |    |
| <b>56059</b> | MCK1075            | Repair Kit, Brake Caliper, Left  |       |    |
| <b>56060</b> | MCK1076            | Repair Kit, Brake Caliper, Right |       |    |
| <b>56061</b> | MCK1144            | Repair Kit, Brake Caliper, Left  |       |  |
| <b>56062</b> | MCK1145            | Repair Kit, Brake Caliper, Right |       |  |
| <b>56029</b> | MCK1151<br>MCK1021 | Repair Kit, Brake Caliper, Left  |       |  |
| <b>56030</b> | MCK1152<br>MCK1022 | Repair Kit, Brake Caliper, Right |       |  |

| Auger Nr.    | OEM Nr. | Description                                | Model | Picture   |
|--------------|---------|--|-------|---|
| <b>70691</b> | MCK1023 | Repair Kit, Brake Caliper, Left            |       |    |
| <b>71444</b> | MCK1024 | Repair Kit, Brake Caliper, Right           |       |    |
| <b>57586</b> | -       | Repair Kit, Brake Caliper, Left<br>ø45x83  |       |   |
| <b>57587</b> | -       | Repair Kit, Brake Caliper, Right<br>ø45x83 |       |  |
| <b>56114</b> | -       | Repair Kit, Brake Caliper                  |       |  |
| <b>56115</b> | -       | Repair Kit, Brake Caliper                  |       |  |
| <b>56116</b> | -       | Repair Kit, Brake Caliper                  |       |  |







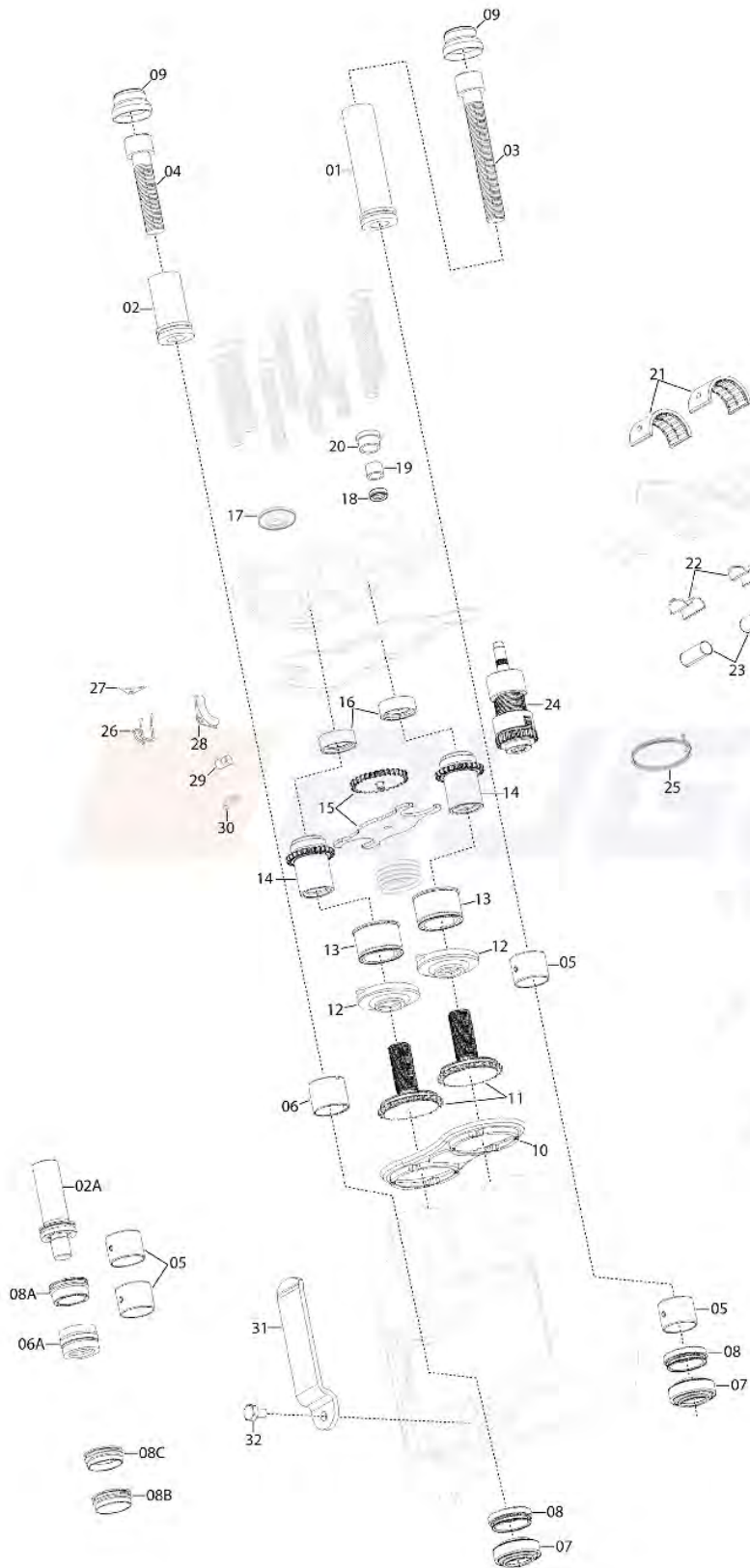







| Auger Nr.    | OEM Nr.           | Description                      | Model | Picture   |
|--------------|-------------------|----------------------------------|-------|---|
| <b>56033</b> | SJ4073            | Repair Kit, Brake Caliper, Left  |       |    |
| <b>56034</b> | SJ4074            | Repair Kit, Brake Caliper, Right |       |    |
| <b>56014</b> | -                 | Repair Kit, Brake Caliper, Left  |       |    |
| <b>56015</b> | -                 | Repair Kit, Brake Caliper, Right |       |  |
| <b>56040</b> | SJ4113<br>MCK4113 | Repair Kit, Brake Caliper, Left  |       |  |
| <b>56018</b> | SJ4114            | Repair Kit, Brake Caliper, Right |       |  |
| <b>56087</b> | SJ4022            | Repair Kit, Brake Caliper        |       |  |



**Spare Parts**



| Sr. | Auger Nr. | O.E.M. Nr.               | Description                     | Picture   | Sr. | Auger Nr. | O.E.M. Nr. | Description                            | Picture   |
|-----|-----------|--------------------------|---------------------------------|---|-----|-----------|------------|--|---|
| 01  | 72700     | -                        | Pin<br>ø35x135                  |    | 02  | 72699     | -          | Pin<br>ø35x72                          |    |
| 02A | 72722     | -                        | Pin<br>M20x1,5/ø28,2            |    | 03  | 55301     | -          | Socket Head Bolt<br>M20x1,5/150        |    |
| 04  | 55300     | -                        | Socket Head Bolt<br>M20x1,5/90  |    | 05  | 72995     | -          | Bushing<br>ø35xø39x30                  |    |
| 06  | 72994     | -                        | Bushing<br>35/37xø40x32,5       |    | 06A | 55343     | -          | Rubber Seal<br>ø29xø40,5x27            |    |
| 07  | 55369     | 68323751                 | Rubber Seal<br>ø29              |  | 08  | 72802     | -          | Machined Washer<br>ø37xø48x13,5        |  |
| 08A | 72811     | -                        | Machined Washer<br>ø30,2xø40x19 |  | 08B | 72810     | -          | Machined Washer<br>ø37xø39x15          |  |
| 08C | 72801     | -                        | Machined Washer<br>ø37xø40x15   |  | 09  | 72861     | -          | Cover<br>ø44x27,5                      |  |
| 10  | 56005     | 68321678PK10<br>68321678 | Lock Plate<br>ø67xø110x12,5     |  | 11  | 73104     | -          | Tappet, Right<br>M24x1,5 R             |  |
| 11  | 73105     | -                        | Tappet, Left<br>M24x1,5 L       |  | 12  | 57643     | -          | Rubber Seal<br>ø33,5/ø45               |  |
| 13  | 73165     | -                        | Roller<br>ø35xø50x32,8          |  | 14  | 73106     | -          | Adjuster Nut, Right<br>M24x1,5 R / ø35 |  |

| Sr. | Auger Nr. | O.E.M. Nr. | Description                              | Picture   | Sr. | Auger Nr. | O.E.M. Nr. | Description                                | Picture   |
|-----|-----------|------------|--|---|-----|-----------|------------|--|---|
| 14  | 73107     | -          | Adjuster Nut, Left<br>M24x1,5 L / ø35    |    | 15  | 73164     | -          | Brake-Caliper Mechanism<br>ø35x110         |    |
| 16  | 73103     | -          | Tappet<br>ø36xø40x14                     |    | 17  | 60343     | 68322297   | Rubber Seal<br>ø28xø63                     |    |
| 18  | 60330     | -          | Seal Ring<br>ø12xø22x7                   |    | 19  | 72851     | -          | Spacertube<br>ø15xø19,2x14                 |    |
| 20  | 73193     | -          | Plug                                     |    | 21  | 72852     | -          | Half Needle Roller Bearing<br>ø49,7xø59x36 |    |
| 22  | 72902     | -          | Half Bearing<br>ø19,25xø16,25x13         |  | 23  | 72736     | -          | Pin<br>ø16x38                              |  |
| 24  | 73173     | -          | Brake-Adjusting Mechanism<br>ø41/ø48x120 |  | 24  | 73174     | -          | Brake-Adjusting Mechanism<br>ø41/ø48x120   |  |
| 25  | 73049     | -          | Spring, Left<br>ø58x32 / Left            |  | 25  | 73050     | -          | Spring, Right<br>ø58x32 / Right            |  |
| 26  | 73059     | -          | Spring                                   |  | 27  | 72832     | -          | Washer                                     |  |
| 28  | 72922     | -          | Cover                                    |  | 29  | 73098     | -          | Pin<br>ø9,5x14                             |  |
| 30  | 72923     | -          | Holder                                   |  | 31  | 72903     | -          | Retaining Plate                            |  |

| Sr. | Auger Nr. | O.E.M. Nr. | Description                       | Picture   | Sr.   | Auger Nr. | O.E.M. Nr. | Description | Picture |
|-----|-----------|------------|-----------------------------------|---|-------|-----------|------------|-------------|---------|
| 32  | 72769     | -          | Hexagon Head Screw<br>M10x1,25/20 |  | 60579 | 68966091  | -          | Lubricant   |         |
|     |           |            |                                   |   | 73207 | -         | -          | Lubricant   |         |

| Auger Nr.    | OEM Nr.          | Description               | Model | Picture   |
|--------------|------------------|---------------------------|-------|---|
| <b>53867</b> | MCK1102/N        | Repair Kit, Brake Caliper |       |    |
| <b>54550</b> | MCK1102          | Repair Kit, Brake Caliper |       |   |
| <b>56009</b> | ST1157<br>ST1192 | Repair Kit, Brake Caliper |       |  |
| <b>54529</b> | MCK1103          | Repair Kit, Brake Caliper |       |  |
| <b>55857</b> | ST1156           | Repair Kit, Brake Caliper |       |  |









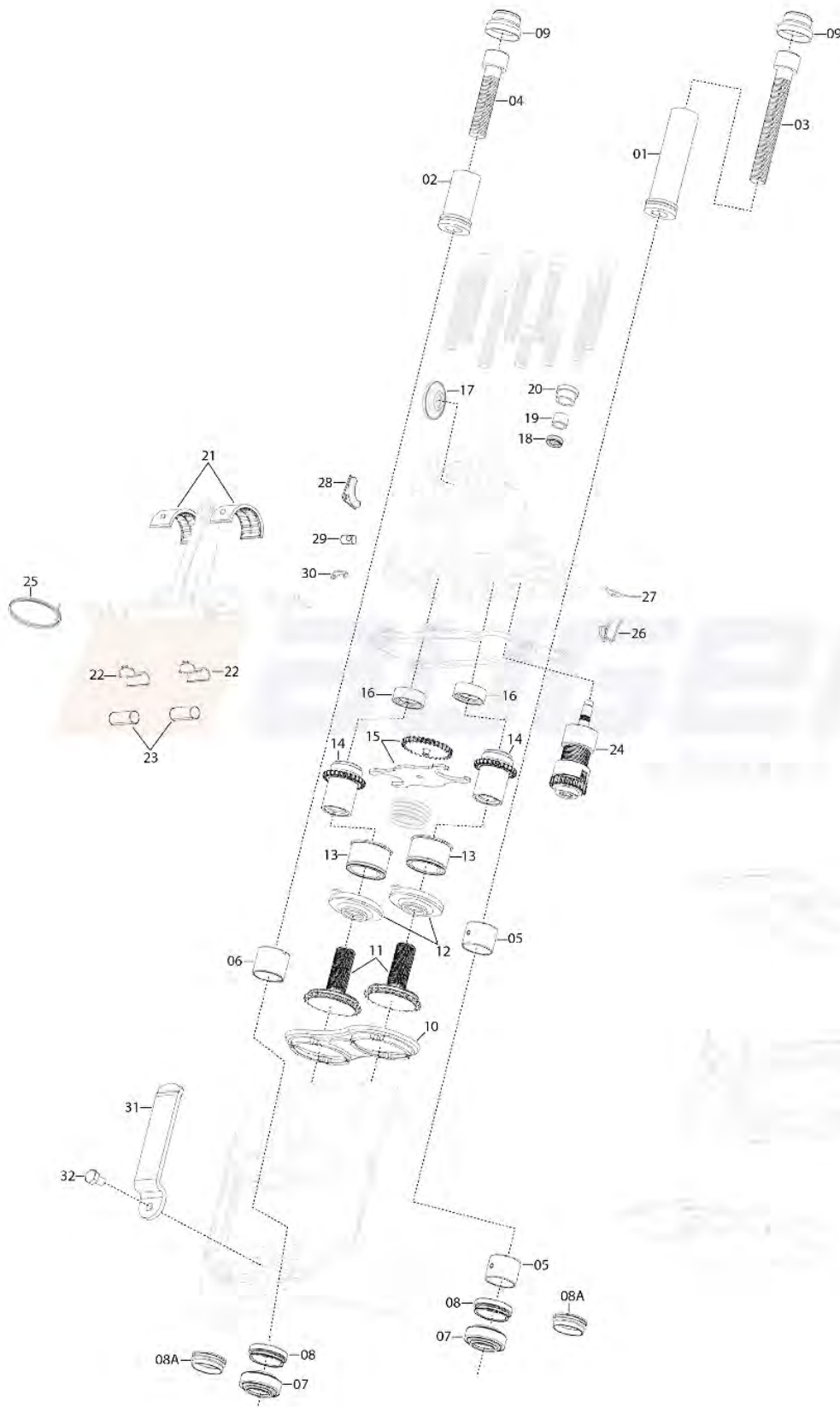









| Auger Nr. | OEM Nr. | Description                      | Model | Picture |
|-----------|---------|----------------------------------|-------|---------|
| 55819     | SJ4112  | Repair Kit, Brake Caliper        |       |         |
| 57589     | -       | Repair Kit, Brake Caliper, Right |       |         |
| 57590     | -       | Repair Kit, Brake Caliper, Left  |       |         |
| 57597     | -       | Repair Kit, Brake Caliper        |       |         |
| 57598     | -       | Repair Kit, Brake Caliper        |       |         |

















| Auger Nr.    | OEM Nr.                  | Description                         | Model | Picture   |
|--------------|--------------------------|-------------------------------------|-------|---|
| <b>56005</b> | 68321678PK10<br>68321678 | Lock Plate<br>ø67xø110x12,5         |       |    |
| <b>56139</b> | -                        | Repair Kit, Brake Caliper,<br>Left  |       |    |
| <b>56140</b> | -                        | Repair Kit, Brake Caliper,<br>Right |       |   |
| <b>56142</b> | -                        | Repair Kit, Brake Caliper           |       |  |
| <b>56081</b> | MCK1262                  | Repair Kit, Brake Caliper           |       |  |









**Spare Parts**





| Sr. | Auger Nr. | O.E.M. Nr.               | Description                           | Picture   | Sr. | Auger Nr. | O.E.M. Nr. | Description                            | Picture   |
|-----|-----------|--------------------------|---------------------------------------|---|-----|-----------|------------|--|---|
| 01  | 72700     | -                        | Pin<br>ø35x135                        |    | 02  | 72699     | -          | Pin<br>ø35x72                          |    |
| 03  | 55301     | -                        | Socket Head Bolt<br>M20x1,5/150       |    | 04  | 55300     | -          | Socket Head Bolt<br>M20x1,5/90         |    |
| 05  | 72995     | -                        | Bushing<br>ø35xø39x30                 |    | 06  | 72994     | -          | Bushing<br>35/37xø40x32,5              |    |
| 07  | 55369     | 68323751                 | Rubber Seal<br>ø29                    |    | 08  | 72802     | -          | Machined Washer<br>ø37xø48x13,5        |    |
| 08A | 72801     | -                        | Machined Washer<br>ø37xø40x15         |  | 09  | 72861     | -          | Cover<br>ø44x27,5                      |  |
| 10  | 56005     | 68321678PK10<br>68321678 | Lock Plate<br>ø67xø110x12,5           |  | 11  | 73104     | -          | Tappet, Right<br>M24x1,5 R             |  |
| 11  | 73105     | -                        | Tappet, Left<br>M24x1,5 L             |  | 12  | 57643     | -          | Rubber Seal<br>ø33,5/ø45               |  |
| 13  | 73165     | -                        | Roller<br>ø35xø50x32,8                |  | 14  | 73106     | -          | Adjuster Nut, Right<br>M24x1,5 R / ø35 |  |
| 14  | 73107     | -                        | Adjuster Nut, Left<br>M24x1,5 L / ø35 |  | 15  | 73164     | -          | Brake-Caliper<br>Mechanism<br>ø35x110  |  |
| 16  | 73103     | -                        | Tappet<br>ø36xø40x14                  |  | 17  | 60343     | 68322297   | Rubber Seal<br>ø28xø63                 |  |

| Sr. | Auger Nr. | O.E.M. Nr. | Description                              | Picture   | Sr.   | Auger Nr. | O.E.M. Nr. | Description                                | Picture   |
|-----|-----------|------------|--|---|-------|-----------|------------|--|---|
| 18  | 73193     | -          | Plug                                     |    | 19    | 72851     | -          | Spacertube<br>ø15xø19,2x14                 |    |
| 20  | 60330     | -          | Seal Ring<br>ø12xø22x7                   |    | 21    | 72852     | -          | Half Needle Roller Bearing<br>ø49,7xø59x36 |    |
| 22  | 72893     | -          | Half Bearing<br>ø19,25xø16,25x8          |    | 23    | 72736     | -          | Pin<br>ø16x38                              |    |
| 24  | 73173     | -          | Brake-Adjusting Mechanism<br>ø41/ø48x120 |    | 24    | 73174     | -          | Brake-Adjusting Mechanism<br>ø41/ø48x120   |    |
| 25  | 73049     | -          | Spring, Left<br>ø58x32 / Left            |  | 25    | 73050     | -          | Spring, Right<br>ø58x32 / Right            |  |
| 26  | 73059     | -          | Spring                                   |  | 27    | 72832     | -          | Washer                                     |  |
| 28  | 72922     | -          | Cover                                    |  | 29    | 73098     | -          | Pin<br>ø9,5x14                             |  |
| 30  | 72923     | -          | Holder                                   |  | 31    | 72903     | -          | Retaining Plate                            |  |
| 32  | 72769     | -          | Hexagon Head Screw<br>M10x1,25/20        |  | 60579 | 68966091  | -          | Lubricant                                  |   |
|     |           |            |  |   | 73207 | -         | -          | Lubricant                                  |   |

| Auger Nr.    | OEM Nr.   | Description                      | Model | Picture   |
|--------------|-----------|----------------------------------|-------|---|
| <b>53867</b> | MCK1102/N | Repair Kit, Brake Caliper        |       |    |
| <b>54550</b> | MCK1102   | Repair Kit, Brake Caliper        |       |    |
| <b>55857</b> | ST1156    | Repair Kit, Brake Caliper        |       |   |
| <b>57581</b> | SJ4098    | Repair Kit, Brake Caliper        |       |  |
| <b>57589</b> | -         | Repair Kit, Brake Caliper, Right |       |  |
| <b>57590</b> | -         | Repair Kit, Brake Caliper, Left  |       |  |

| Auger Nr. | OEM Nr. | Description                      | Model | Picture   |
|-----------|---------|----------------------------------|-------|---|
| 57597     | -       | Repair Kit, Brake Caliper        |       |    |
| 57598     | -       | Repair Kit, Brake Caliper        |       |    |
| 56140     | -       | Repair Kit, Brake Caliper, Right |       |   |
| 56139     | -       | Repair Kit, Brake Caliper, Left  |       |  |

| Auger Nr.    | OEM Nr.                  | Description                 | Model | Picture  |
|--------------|--------------------------|-----------------------------|-------|--|
| <b>56005</b> | 68321678PK10<br>68321678 | Lock Plate<br>ø67xø110x12,5 |       |   |
| <b>56142</b> | -                        | Repair Kit, Brake Caliper   |       |   |
| <b>56081</b> | MCK1262                  | Repair Kit, Brake Caliper   |       |  |





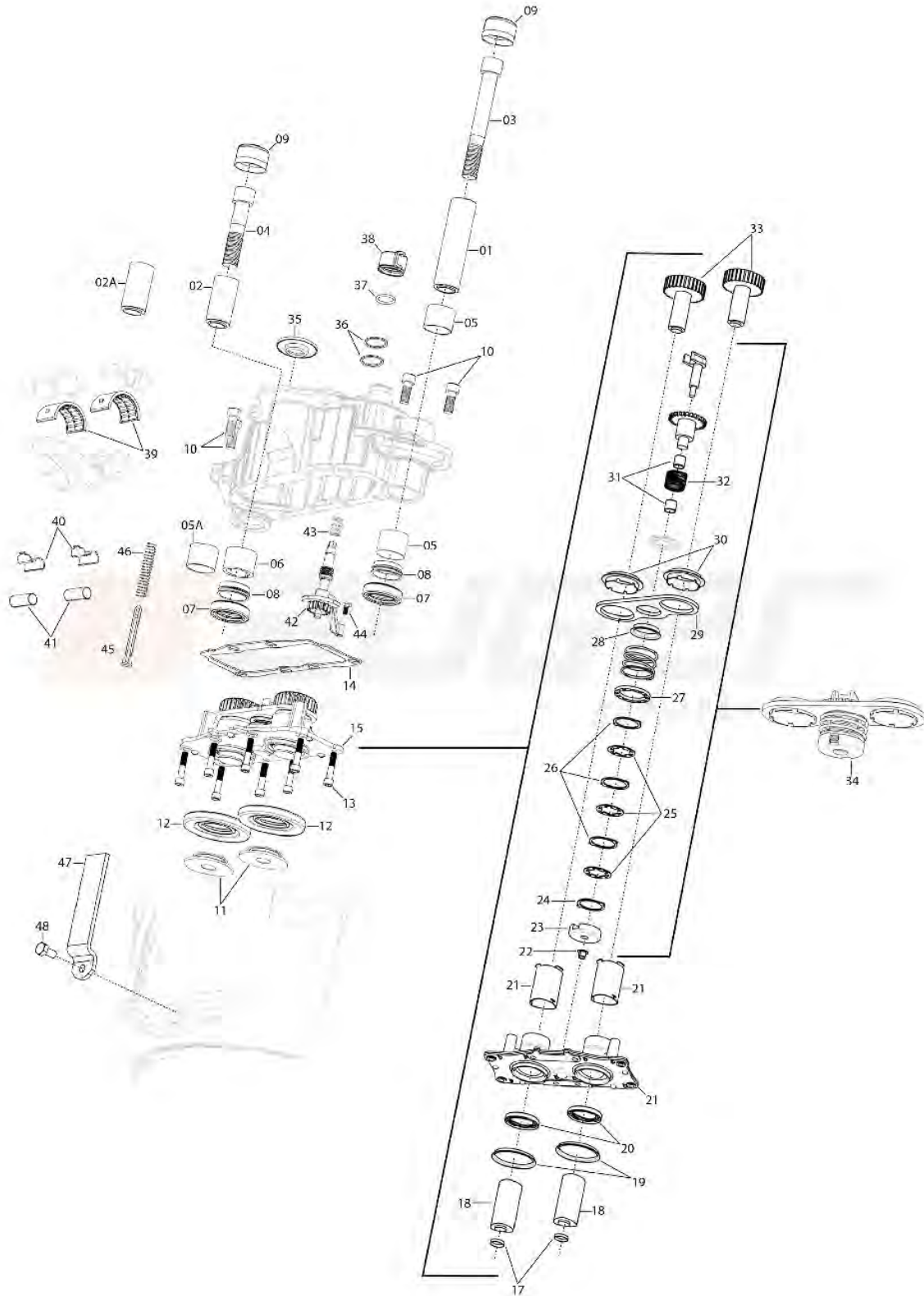













**Spare Parts**



| Sr. | Auger Nr. | O.E.M. Nr.           | Description                     | Picture   | Sr. | Auger Nr. | O.E.M. Nr. | Description                         | Picture   |
|-----|-----------|----------------------|---------------------------------|---|-----|-----------|------------|-------------------------------------|---|
| 01  | 72712     | -                    | Pin<br>ø35x128,5                |    | 01  | 72714     | -          | Pin<br>ø35x144                      |    |
| 02  | 72713     | -                    | Pin<br>ø31x84                   |    | 02A | 72711     | -          | Pin<br>ø35x66,5                     |    |
| 03  | 55296     | -                    | Socket Head Bolt<br>M18x1,5/150 |    | 03  | 55301     | -          | Socket Head Bolt<br>M20x1,5/150     |    |
| 04  | 55295     | -                    | Socket Head Bolt<br>M18x1,5/90  |    | 04  | 55300     | -          | Socket Head Bolt<br>M20x1,5/90      |    |
| 05  | 72995     | -                    | Bushing<br>ø35xø39x30           |  | 06  | 72996     | -          | Bushing<br>30/31xø42x30             |  |
| 07  | 55365     | -                    | Rubber Seal<br>ø29              |  | 07  | 55369     | 68323751   | Rubber Seal<br>ø29                  |  |
| 08  | 72808     | -                    | Machined Washer<br>ø37xø42x14   |  | 09  | 72870     | -          | Cover<br>ø44x27                     |  |
| 10  | 55384     | -                    | Socket Head Bolt<br>M16x1,5/40  |  | 11  | 72809     | -          | Machined Washer<br>ø34xø48x12,5     |  |
| 12  | 55351     | 68322651<br>68324854 | Rubber Seal<br>ø32xø43          |  | 13  | 72793     | -          | Socket Head Bolt<br>M8x1,25/45      |  |
| 14  | 72980     | -                    | Rubber Gasket                   |  | 15  | 57174     | -          | Piston Housing<br>Assembly<br>109,5 |  |

| Sr. | Auger Nr. | O.E.M. Nr. | Description                      | Picture | Sr. | Auger Nr. | O.E.M. Nr. | Description                   | Picture |
|-----|-----------|------------|----------------------------------|---------|-----|-----------|------------|-------------------------------|---------|
| 16  | 73111     | -          | Piston Housing Assembly<br>109,5 |         | 17  | 73002     | -          | Bushing<br>ø32xø34x6,5        |         |
| 18  | 73095     | -          | Tappet Assembly<br>M24x1,5/72    |         | 19  | 72921     | -          | Cover<br>ø58,4xø60,4x5,5      |         |
| 20  | 72953     | -          | Seal Ring<br>ø52x6,7             |         | 21  | 73021     | -          | Bushing                       |         |
| 22  | 70700     | -          | Bushing<br>ø10xø12/ø18x7         |         | 23  | 73110     | -          | Bushing<br>ø11xø47x11,5       |         |
| 24  | 72826     | -          | Shim                             |         | 25  | 72827     | -          | Shim                          |         |
| 26  | 72825     | -          | Shim                             |         | 27  | 72858     | -          | Bearing<br>ø29,5xø40,5x3      |         |
| 28  | 72688     | -          | Plastic Bushing<br>ø34           |         | 29  | 72920     | -          | Lock Plate<br>ø37/ø50x109,5   |         |
| 30  | 72687     | -          | Plastic Bearing<br>ø47/ø49       |         | 31  | 73022     | -          | Bushing<br>ø14xø16x15         |         |
| 32  | 73061     | -          | Spring<br>ø33x22                 |         | 33  | 73096     | -          | Adjuster Bolt<br>M24x1,5/80,5 |         |
| 34  | 70699     | -          | Adjusting Mechanism<br>109,5     |         | 35  | 73185     | 68323746   | Rubber Dust Cap<br>ø63        |         |



| Sr.   | Auger Nr. | O.E.M. Nr. | Description                      | Picture   | Sr. | Auger Nr. | O.E.M. Nr. | Description                                | Picture   |
|-------|-----------|------------|----------------------------------|---|-----|-----------|------------|--|---|
| 36    | 72807     | -          | Machined Washer<br>ø35xø42,5x2,5 |    | 37  | 72983     | -          | O-Ring<br>ø2,4xø18                         |    |
| 38    | 60566     | 68322655   | Rubber Dust Cap<br>ø28           |    | 39  | 72852     | -          | Half Needle Roller Bearing<br>ø49,7xø59x36 |    |
| 40    | 72902     | -          | Half Bearing<br>ø19,25xø16,25x13 |    | 41  | 72736     | -          | Pin<br>ø16x38                              |    |
| 42    | 73177     | -          | Adjusting Device,<br>Right       |    | 42  | 73178     | -          | Adjusting Device,<br>Left                  |    |
| 43    | 73060     | -          | Spring<br>ø17x25,5               |  | 44  | 72790     | -          | Hexagon Head Screw<br>M6x1/16              |  |
| 45    | 72681     | -          | Pad Pin                          |  | 46  | 73031     | -          | Spring<br>ø14,5x82                         |  |
| 47    | 72916     | -          | Retaining Plate                  |  | 48  | 72769     | -          | Hexagon Head Screw<br>M10x1,25/20          |  |
| 60579 | 68966091  | -          | Lubricant                        |   |     |           |            |  |   |
| 73207 | -         | -          | Lubricant                        |   |     |           |            |  |   |
| 73203 | MBG1001   | -          | Lubricant                        |   |     |           |            |  |   |

| Auger Nr.    | OEM Nr.            | Description               | Model | Picture   |
|--------------|--------------------|---------------------------|-------|---|
| <b>54170</b> | MCK1086            | Repair Kit, Brake Caliper |       |    |
| <b>54171</b> | MCK1243<br>MCK1140 | Repair Kit, Brake Caliper |       |    |
| <b>54173</b> | MCK1244            | Repair Kit, Brake Caliper |       |   |
| <b>54174</b> | MCK1309            | Repair Kit, Brake Caliper |       |  |
| <b>56016</b> | MCK1088            | Repair Kit, Brake Caliper |       |  |
| <b>53870</b> | MCK1139            | Repair Kit, Brake Caliper |       |  |

| Auger Nr.    | OEM Nr. | Description                        | Model | Picture   |
|--------------|---------|------------------------------------|-------|---|
| <b>71870</b> | -       | Repair Kit, Brake Caliper<br>109,5 |       |    |
| <b>70695</b> | -       | Repair Kit, Brake Caliper<br>109,5 |       |    |
| <b>57174</b> | -       | Piston Housing Assembly<br>109,5   |       |   |
| <b>70694</b> | -       | Repair Kit, Brake Caliper          |       |  |
| <b>56136</b> | -       | Repair Kit, Brake Caliper          |       |  |
| <b>56137</b> | -       | Repair Kit, Brake Caliper          |       |  |



| Auger Nr.    | OEM Nr. | Description                      | Model | Picture   |
|--------------|---------|----------------------------------|-------|---|
| <b>70699</b> | -       | Adjusting Mechanism<br><br>109,5 |       |    |
| <b>70700</b> | -       | Bushing<br><br>ø10xø12/ø18x7     |       |    |
| <b>56141</b> | -       | Repair Kit, Brake Caliper        |       |   |
| <b>70693</b> | -       | Repair Kit, Brake Caliper        |       |  |
| <b>55819</b> | SJ4112  | Repair Kit, Brake Caliper        |       |  |

| Auger Nr.    | OEM Nr. | Description                      | Model | Picture   |
|--------------|---------|----------------------------------|-------|---|
| <b>70688</b> | -       | Repair Kit, Brake Caliper, Right |       |    |
| <b>70689</b> | -       | Repair Kit, Brake Caliper, Left  |       |    |
| <b>56050</b> | MCK1240 | Repair Kit, Brake Caliper        |       |   |
| <b>56107</b> | MCK1174 | Repair Kit, Brake Caliper        |       |  |

**Spare Parts**

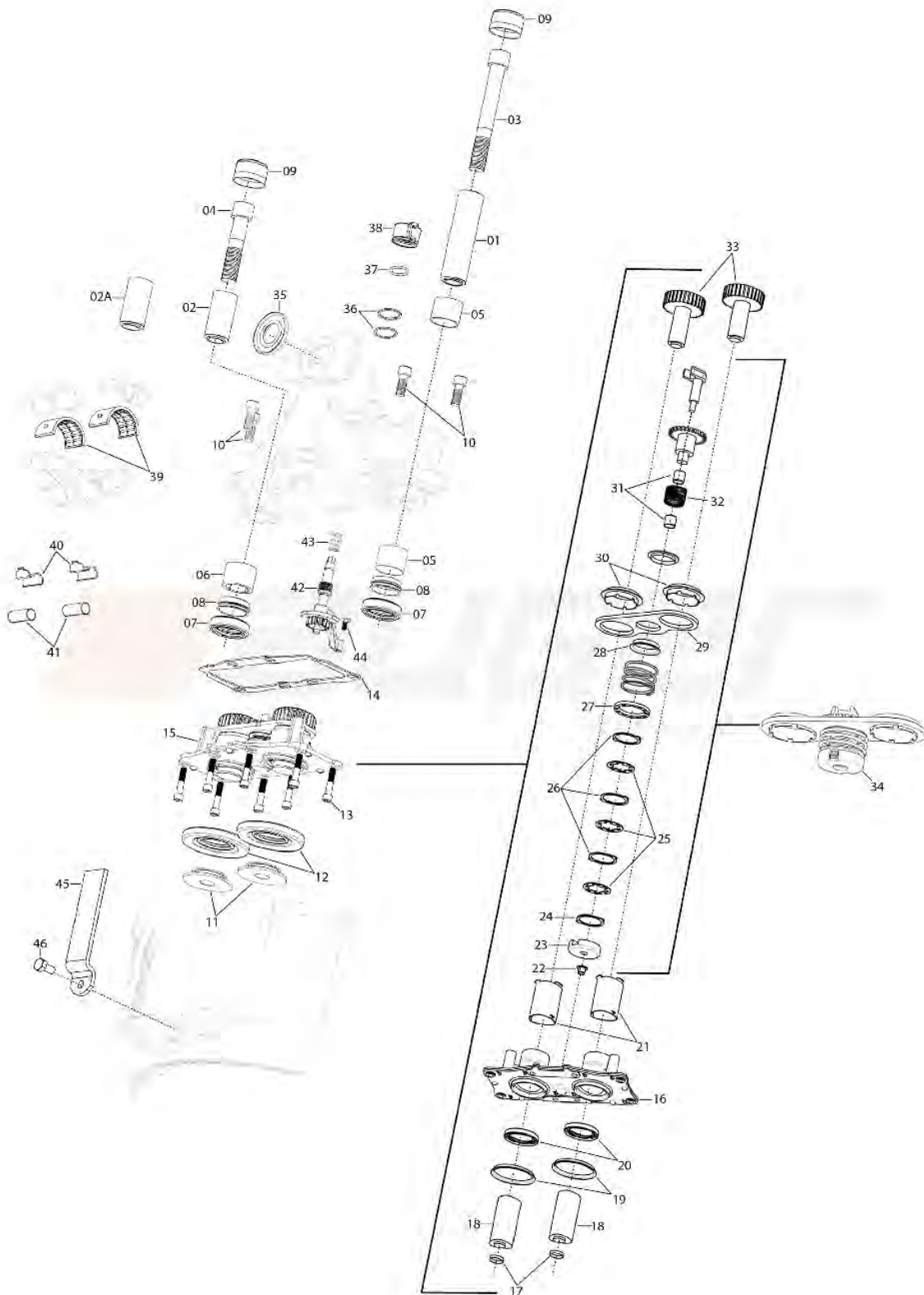













| Sr. | Auger Nr. | O.E.M. Nr.           | Description                     | Picture   | Sr. | Auger Nr. | O.E.M. Nr. | Description                         | Picture   |
|-----|-----------|----------------------|---------------------------------|---|-----|-----------|------------|-------------------------------------|---|
| 01  | 72712     | -                    | Pin<br>ø35x128,5                |    | 01  | 72714     | -          | Pin<br>ø35x144                      |    |
| 02  | 72713     | -                    | Pin<br>ø31x84                   |    | 02A | 72711     | -          | Pin<br>ø35x66,5                     |    |
| 03  | 55296     | -                    | Socket Head Bolt<br>M18x1,5/150 |    | 03  | 55301     | -          | Socket Head Bolt<br>M20x1,5/150     |    |
| 04  | 55295     | -                    | Socket Head Bolt<br>M18x1,5/90  |    | 04  | 55300     | -          | Socket Head Bolt<br>M20x1,5/90      |    |
| 05  | 72995     | -                    | Bushing<br>ø35xø39x30           |  | 06  | 72996     | -          | Bushing<br>30/31xø42x30             |  |
| 07  | 55365     | -                    | Rubber Seal<br>ø29              |  | 07  | 55369     | 68323751   | Rubber Seal<br>ø29                  |  |
| 08  | 72808     | -                    | Machined Washer<br>ø37xø42x14   |  | 09  | 72870     | -          | Cover<br>ø44x27                     |  |
| 10  | 55384     | -                    | Socket Head Bolt<br>M16x1,5/40  |  | 11  | 72809     | -          | Machined Washer<br>ø34xø48x12,5     |  |
| 12  | 55351     | 68322651<br>68324854 | Rubber Seal<br>ø32xø43          |  | 13  | 72793     | -          | Socket Head Bolt<br>M8x1,25/45      |  |
| 14  | 72980     | -                    | Rubber Gasket                   |  | 15  | 57174     | -          | Piston Housing<br>Assembly<br>109,5 |  |

| Sr. | Auger Nr. | O.E.M. Nr. | Description                      | Picture   | Sr. | Auger Nr. | O.E.M. Nr. | Description                   | Picture   |
|-----|-----------|------------|----------------------------------|---|-----|-----------|------------|-------------------------------|---|
| 16  | 73111     | -          | Piston Housing Assembly<br>109,5 |    | 17  | 73002     | -          | Bushing<br>ø32xø34x6,5        |    |
| 18  | 73095     | -          | Tappet Assembly<br>M24x1,5/72    |    | 19  | 72921     | -          | Cover<br>ø58,4xø60,4x5,5      |    |
| 20  | 72953     | -          | Seal Ring<br>ø52x6,7             |    | 21  | 73021     | -          | Bushing                       |    |
| 22  | 70700     | -          | Bushing<br>ø10xø12/ø18x7         |    | 23  | 73110     | -          | Bushing<br>ø11xø47x11,5       |    |
| 24  | 72826     | -          | Shim                             |  | 25  | 72827     | -          | Shim                          |  |
| 26  | 72825     | -          | Shim                             |  | 27  | 72858     | -          | Bearing<br>ø29,5xø40,5x3      |  |
| 28  | 72688     | -          | Plastic Bushing<br>ø34           |  | 29  | 72920     | -          | Lock Plate<br>ø37/ø50x109,5   |  |
| 30  | 72687     | -          | Plastic Bearing<br>ø47/ø49       |  | 31  | 73022     | -          | Bushing<br>ø14xø16x15         |  |
| 32  | 73061     | -          | Spring<br>ø33x22                 |  | 33  | 73096     | -          | Adjuster Bolt<br>M24x1,5/80,5 |  |
| 34  | 70699     | -          | Adjusting Mechanism<br>109,5     |  | 35  | 73185     | 68323746   | Rubber Dust Cap<br>ø63        |  |







# MERITOR / ROR



## ELSA 2 RADIAL TYPE CALIPER

| Sr.   | Auger Nr. | O.E.M. Nr. | Description                      | Picture   | Sr.   | Auger Nr. | O.E.M. Nr. | Description                                | Picture   |
|-------|-----------|------------|----------------------------------|---|-------|-----------|------------|--|---|
| 36    | 72807     | -          | Machined Washer<br>ø35xø42,5x2,5 |    | 37    | 72983     | -          | O-Ring<br>ø2,4xø18                         |    |
| 38    | 60566     | 68322655   | Rubber Dust Cap<br>ø28           |    | 39    | 72852     | -          | Half Needle Roller Bearing<br>ø49,7xø59x36 |    |
| 40    | 72893     | -          | Half Bearing<br>ø19,25xø16,25x8  |    | 41    | 72736     | -          | Pin<br>ø16x38                              |    |
| 42    | 73177     | -          | Adjusting Device, Right          |    | 42    | 73178     | -          | Adjusting Device, Left                     |    |
| 43    | 73060     | -          | Spring<br>ø17x25,5               |  | 44    | 72790     | -          | Hexagon Head Screw<br>M6x1/16              |  |
| 45    | 72916     | -          | Retaining Plate                  |  | 46    | 72769     | -          | Hexagon Head Screw<br>M10x1,25/20          |  |
| 73203 | MBG1001   | -          | Lubricant                        |   | 73207 | -         | Lubricant  |  |   |
| 60579 | 68966091  | -          | Lubricant                        |   |       |           |            |  |   |



| Auger Nr.    | OEM Nr.            | Description               | Model | Picture |
|--------------|--------------------|---------------------------|-------|---------|
| <b>54170</b> | MCK1086            | Repair Kit, Brake Caliper |       |         |
| <b>54171</b> | MCK1243<br>MCK1140 | Repair Kit, Brake Caliper |       |         |
| <b>54173</b> | MCK1244            | Repair Kit, Brake Caliper |       |         |
| <b>54174</b> | MCK1309            | Repair Kit, Brake Caliper |       |         |
| <b>56016</b> | MCK1088            | Repair Kit, Brake Caliper |       |         |
| <b>53870</b> | MCK1139            | Repair Kit, Brake Caliper |       |         |

| Auger Nr.    | OEM Nr. | Description                        | Model | Picture   |
|--------------|---------|------------------------------------|-------|---|
| <b>71870</b> | -       | Repair Kit, Brake Caliper<br>109,5 |       |    |
| <b>70695</b> | -       | Repair Kit, Brake Caliper<br>109,5 |       |    |
| <b>57174</b> | -       | Piston Housing Assembly<br>109,5   |       |   |
| <b>70694</b> | -       | Repair Kit, Brake Caliper          |       |  |
| <b>56136</b> | -       | Repair Kit, Brake Caliper          |       |  |
| <b>56137</b> | -       | Repair Kit, Brake Caliper          |       |  |

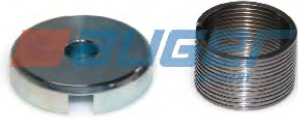
| Auger Nr.    | OEM Nr. | Description                  | Model | Picture   |
|--------------|---------|------------------------------|-------|---|
| <b>70699</b> | -       | Adjusting Mechanism<br>109,5 |       |    |
| <b>70700</b> | -       | Bushing<br>ø10xø12/ø18x7     |       |    |
| <b>56141</b> | -       | Repair Kit, Brake Caliper    |       |   |
| <b>70693</b> | -       | Repair Kit, Brake Caliper    |       |  |

# MERITOR / ROR









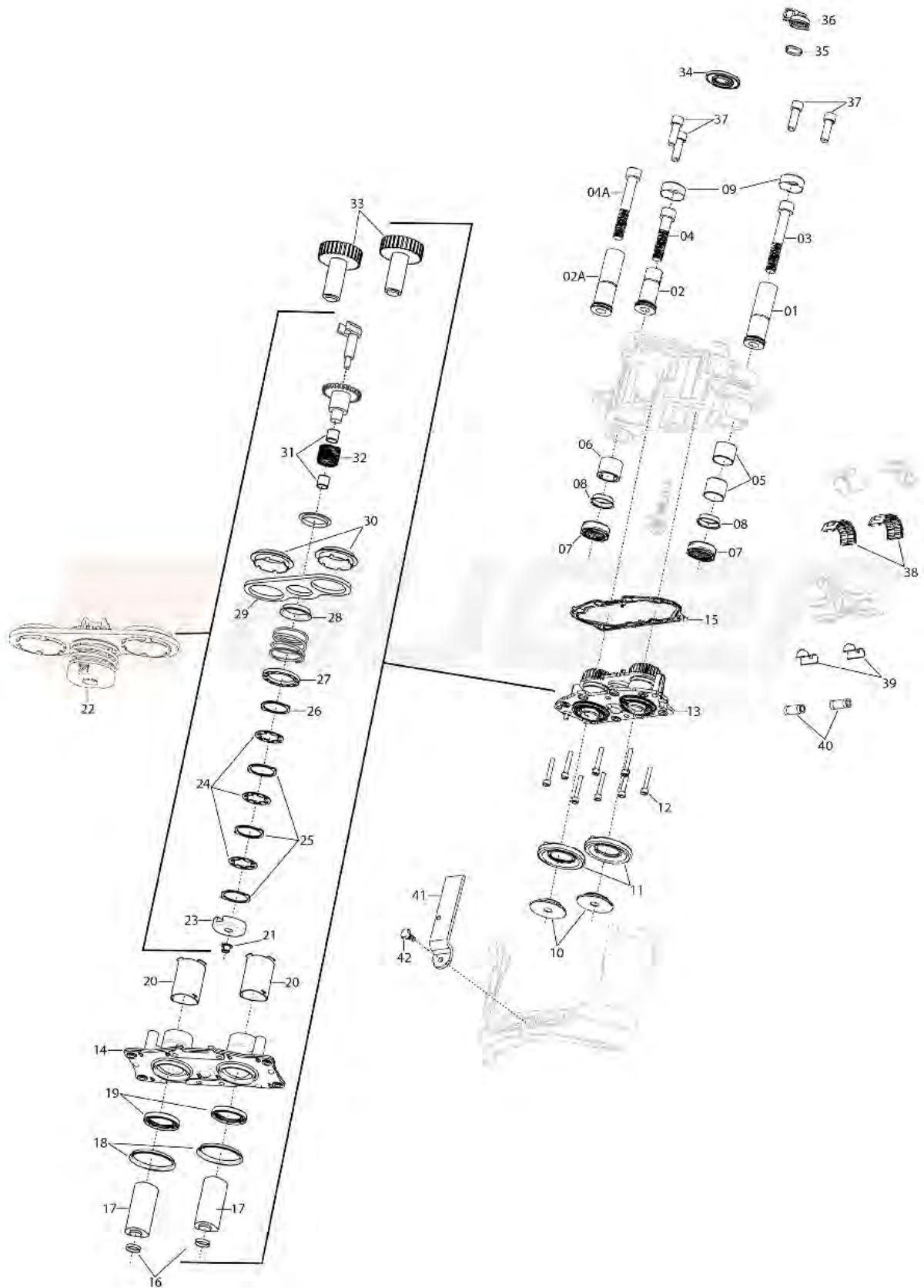

## ELSA 2 RADIAL TYPE CALIPER























| Auger Nr.    | OEM Nr. | Description                      | Model | Picture |
|--------------|---------|----------------------------------|-------|---------|
| <b>57581</b> | SJ4098  | Repair Kit, Brake Caliper        |       |         |
| <b>70688</b> | -       | Repair Kit, Brake Caliper, Right |       |         |
| <b>70689</b> | -       | Repair Kit, Brake Caliper, Left  |       |         |
| <b>56107</b> | MCK1174 | Repair Kit, Brake Caliper        |       |         |









**Spare Parts**













| Sr. | Auger Nr. | O.E.M. Nr. | Description                         | Picture   | Sr. | Auger Nr. | O.E.M. Nr. | Description                         | Picture   |
|-----|-----------|------------|-------------------------------------|---|-----|-----------|------------|-------------------------------------|---|
| 01  | 72702     | -          | Pin<br>ø35x117                      |    | 01  | 72710     | -          | Pin<br>ø35x117                      |    |
| 02  | 72701     | -          | Pin<br>ø31x78                       |    | 02A | 72737     | -          | Pin<br>ø31x117                      |    |
| 03  | 55304     | -          | Socket Head Bolt<br>M18x1,5/120     |    | 04  | 55303     | -          | Socket Head Bolt<br>M18x1,5/81,5    |    |
| 04A | 55304     | -          | Socket Head Bolt<br>M18x1,5/120     |    | 05  | 72995     | -          | Bushing<br>ø35xø39x30               |    |
| 06  | 72996     | -          | Bushing<br>30/31xø42x30             |  | 07  | 55365     | -          | Rubber Seal<br>ø29                  |  |
| 07  | 55369     | 68323751   | Rubber Seal<br>ø29                  |  | 08  | 72863     | -          | Cover<br>ø39x10                     |  |
| 09  | 72862     | -          | Cover<br>ø44x17,5                   |  | 10  | 72809     | -          | Machined Washer<br>ø34xø48x12,5     |  |
| 11  | 55351     | -          | Rubber Seal<br>ø32xø43              |  | 12  | 72793     | -          | Socket Head Bolt<br>M8x1,25/45      |  |
| 13  | 57174     | -          | Piston Housing<br>Assembly<br>109,5 |  | 14  | 73111     | -          | Piston Housing<br>Assembly<br>109,5 |  |
| 15  | 72980     | -          | Rubber Gasket                       |  | 16  | 73002     | -          | Bushing<br>ø32xø34x6,5              |  |









| Sr. | Auger Nr. | O.E.M. Nr. | Description                   | Picture   | Sr. | Auger Nr. | O.E.M. Nr. | Description                     | Picture   |
|-----|-----------|------------|-------------------------------|---|-----|-----------|------------|---------------------------------|---|
| 17  | 73095     | -          | Tappet Assembly<br>M24x1,5/72 |    | 18  | 72921     | -          | Cover<br>ø58,4xø60,4x5,5        |    |
| 19  | 72953     | -          | Seal Ring<br>ø52x6,7          |    | 20  | 73021     | -          | Bushing                         |    |
| 21  | 70700     | -          | Bushing<br>ø10xø12/ø18x7      |    | 22  | 70699     | -          | Adjusting<br>Mechanism<br>109,5 |    |
| 23  | 73110     | -          | Bushing<br>ø11xø47x11,5       |    | 24  | 72827     | -          | Shim                            |    |
| 25  | 72825     | -          | Shim                          |  | 26  | 72826     | -          | Shim                            |  |
| 27  | 72858     | -          | Bearing<br>ø29,5xø40,5x3      |  | 28  | 72688     | -          | Plastic Bushing<br>ø34          |  |
| 29  | 72920     | -          | Lock Plate<br>ø37/ø50x109,5   |  | 30  | 72687     | -          | Plastic Bearing<br>ø47/ø49      |  |
| 31  | 73022     | -          | Bushing<br>ø14xø16x15         |  | 32  | 73061     | -          | Spring<br>ø33x22                |  |
| 33  | 73096     | -          | Adjuster Bolt<br>M24x1,5/80,5 |  | 34  | 73185     | -          | Rubber Dust Cap<br>ø63          |  |
| 35  | 72983     | -          | O-Ring<br>ø2,4xø18            |  | 36  | 60566     | 68322655   | Rubber Dust Cap<br>ø28          |  |

| Sr.   | Auger Nr. | O.E.M. Nr. | Description                                   | Picture   | Sr.   | Auger Nr. | O.E.M. Nr. | Description                                   | Picture   |
|-------|-----------|------------|---|---|-------|-----------|------------|---|---|
| 37    | 55294     | -          | Hexagon Bolt With Astral Flange<br>M16x1,5/40 |  | 37    | 55302     | -          | Hexagon Bolt With Astral Flange<br>M14x1,5/40 |  |
| 37    | 55384     | -          | Socket Head Bolt<br>M16x1,5/40                |  | 38    | 72852     | -          | Half Needle Roller Bearing<br>ø49,7xø59x36    |  |
| 39    | 72902     | -          | Half Bearing<br>ø19,25xø16,25x13              |  | 40    | 72736     | -          | Pin<br>ø16x38                                 |  |
| 41    | 72916     | -          | Retaining Plate                               |  | 42    | 72769     | -          | Hexagon Head Screw<br>M10x1,25/20             |  |
| 73203 | MBG1001   | -          | Lubricant                                     |   | 73207 | -         | Lubricant  |   |   |
| 60579 | 68966091  | -          | Lubricant                                     |   |       |           |            |   |   |

| Auger Nr.    | OEM Nr. | Description               | Model | Picture   |
|--------------|---------|---------------------------|-------|---|
| <b>53869</b> | MCK1254 | Repair Kit, Brake Caliper |       |    |
| <b>56010</b> | MCK1317 | Repair Kit, Brake Caliper |       |    |
| <b>56016</b> | MCK1088 | Repair Kit, Brake Caliper |       |   |
| <b>53868</b> | MCK1253 | Repair Kit, Brake Caliper |       |  |
| <b>54174</b> | MCK1309 | Repair Kit, Brake Caliper |       |  |
| <b>53870</b> | MCK1139 | Repair Kit, Brake Caliper |       |  |

| Auger Nr.    | OEM Nr. | Description                        | Model | Picture   |
|--------------|---------|------------------------------------|-------|---|
| <b>71870</b> | -       | Repair Kit, Brake Caliper<br>109,5 |       |    |
| <b>70695</b> | -       | Repair Kit, Brake Caliper<br>109,5 |       |    |
| <b>57174</b> | -       | Piston Housing Assembly<br>109,5   |       |   |
| <b>56136</b> | -       | Repair Kit, Brake Caliper          |       |  |
| <b>70694</b> | -       | Repair Kit, Brake Caliper          |       |  |
| <b>56137</b> | -       | Repair Kit, Brake Caliper          |       |  |

| Auger Nr.    | OEM Nr. | Description                  | Model | Picture  |
|--------------|---------|------------------------------|-------|--|
| <b>70699</b> | -       | Adjusting Mechanism<br>109,5 |       |   |
| <b>56141</b> | -       | Repair Kit, Brake Caliper    |       |   |
| <b>70693</b> | -       | Repair Kit, Brake Caliper    |       |  |

| Auger Nr.    | OEM Nr. | Description                  | Model | Picture  |
|--------------|---------|------------------------------|-------|--|
| <b>70700</b> | -       | Bushing<br><br>ø10xø12/ø18x7 |       |   |
| <b>55819</b> | SJ4112  | Repair Kit, Brake Caliper    |       |   |
| <b>56107</b> | MCK1174 | Repair Kit, Brake Caliper    |       |  |





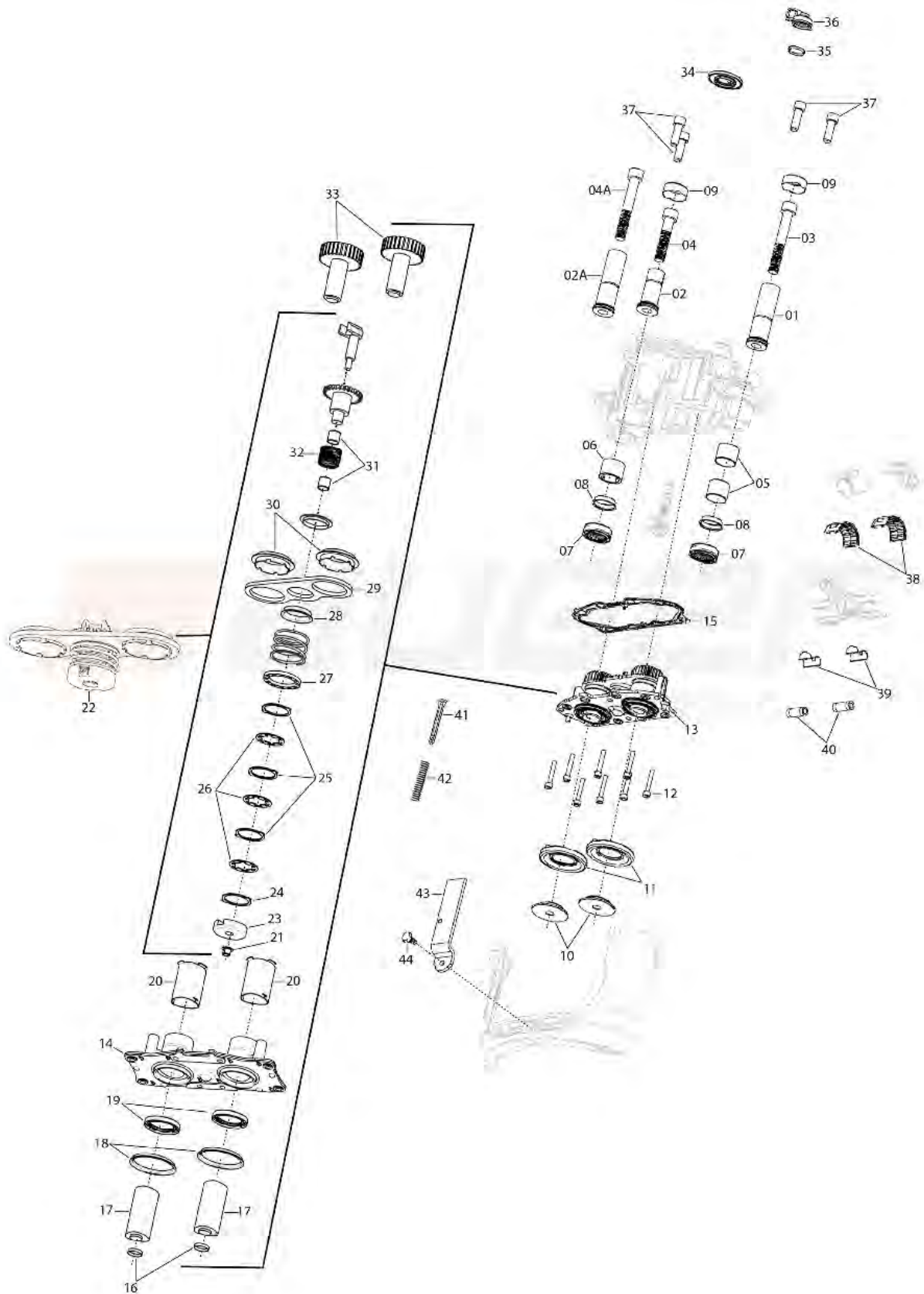











**Spare Parts**



| Sr. | Auger Nr. | O.E.M. Nr. | Description                         | Picture   | Sr. | Auger Nr. | O.E.M. Nr. | Description                         | Picture   |
|-----|-----------|------------|-------------------------------------|---|-----|-----------|------------|-------------------------------------|---|
| 01  | 72710     | -          | Pin<br>ø35x117                      |    | 02  | 72709     | -          | Pin<br>ø31x78                       |    |
| 02A | 72737     | -          | Pin<br>ø31x117                      |    | 03  | 55304     | -          | Socket Head Bolt<br>M18x1,5/120     |    |
| 04  | 55303     | -          | Socket Head Bolt<br>M18x1,5/81,5    |    | 04A | 55304     | -          | Socket Head Bolt<br>M18x1,5/120     |    |
| 05  | 72995     | -          | Bushing<br>ø35xø39x30               |    | 06  | 72996     | -          | Bushing<br>30/31xø42x30             |    |
| 07  | 55365     | -          | Rubber Seal<br>ø29                  |  | 07  | 55369     | 68323751   | Rubber Seal<br>ø29                  |  |
| 08  | 72863     | -          | Cover<br>ø39x10                     |  | 09  | 72862     | -          | Cover<br>ø44x17,5                   |  |
| 10  | 72809     | -          | Machined Washer<br>ø34xø48x12,5     |  | 11  | 55351     | -          | Rubber Seal<br>ø32xø43              |  |
| 12  | 72793     | -          | Socket Head Bolt<br>M8x1,25/45      |  | 13  | 57174     | -          | Piston Housing<br>Assembly<br>109,5 |  |
| 14  | 73111     | -          | Piston Housing<br>Assembly<br>109,5 |  | 15  | 72980     | -          | Rubber Gasket                       |  |
| 16  | 73002     | -          | Bushing<br>ø32xø34x6,5              |  | 17  | 73095     | -          | Tappet Assembly<br>M24x1,5/72       |  |





| Sr. | Auger Nr. | O.E.M. Nr. | Description                  | Picture | Sr. | Auger Nr. | O.E.M. Nr. | Description                                   | Picture |
|-----|-----------|------------|------------------------------|---------|-----|-----------|------------|---|---------|
| 18  | 72921     | -          | Cover<br>ø58,4xø60,4x5,5     |         | 19  | 72953     | -          | Seal Ring<br>ø52x6,7                          |         |
| 20  | 73021     | -          | Bushing                      |         | 21  | 70700     | -          | Bushing<br>ø10xø12/ø18x7                      |         |
| 22  | 70699     | -          | Adjusting Mechanism<br>109,5 |         | 23  | 73110     | -          | Bushing<br>ø11xø47x11,5                       |         |
| 24  | 72826     | -          | Shim                         |         | 25  | 72825     | -          | Shim  |         |
| 26  | 72827     | -          | Shim                         |         | 27  | 72858     | -          | Bearing<br>ø29,5xø40,5x3                      |         |
| 28  | 72688     | -          | Plastic Bushing<br>ø34       |         | 29  | 72920     | -          | Lock Plate<br>ø37/ø50x109,5                   |         |
| 30  | 72687     | -          | Plastic Bearing<br>ø47/ø49   |         | 31  | 73022     | -          | Bushing<br>ø14xø16x15                         |         |
| 32  | 73061     | -          | Spring<br>ø33x22             |         | 33  | 73096     | -          | Adjuster Bolt<br>M24x1,5/80,5                 |         |
| 34  | 73185     | -          | Rubber Dust Cap<br>ø63       |         | 35  | 72983     | -          | O-Ring<br>ø2,4xø18                            |         |
| 36  | 60566     | 68322655   | Rubber Dust Cap<br>ø28       |         | 37  | 55294     | -          | Hexagon Bolt With Astral Flange<br>M16x1,5/40 |         |

| Sr. | Auger Nr. | O.E.M. Nr. | Description                                   | Picture   | Sr.   | Auger Nr. | O.E.M. Nr. | Description                      | Picture   |
|-----|-----------|------------|---|---|-------|-----------|------------|----------------------------------|---|
| 37  | 55302     | -          | Hexagon Bolt With Astral Flange<br>M14x1,5/40 |    | 37    | 55384     | -          | Socket Head Bolt<br>M16x1,5/40   |  |
| 38  | 72852     | -          | Half Needle Roller Bearing<br>ø49,7xø59x36    |    | 39    | 72902     | -          | Half Bearing<br>ø19,25xø16,25x13 |  |
| 40  | 72736     | -          | Pin<br>ø16x38                                 |    | 41    | 72676     | -          | Pad Pin                          |  |
| 42  | 73031     | -          | Spring<br>ø14,5x82                            |    | 43    | 72916     | -          | Retaining Plate                  |  |
| 44  | 72769     | -          | Hexagon Head Screw<br>M10x1,25/20             |  | 73203 | MBG1001   | -          | Lubricant                        |   |
|     |           |            |   |   | 60579 | 68966091  | -          | Lubricant                        |   |
|     |           |            |   |   | 73207 | -         | -          | Lubricant                        |   |

| Auger Nr.    | OEM Nr. | Description               | Model | Picture   |
|--------------|---------|---------------------------|-------|---|
| <b>54169</b> | MCK1298 | Repair Kit, Brake Caliper |       |    |
| <b>56010</b> | MCK1317 | Repair Kit, Brake Caliper |       |    |
| <b>54172</b> | MCK1310 | Repair Kit, Brake Caliper |       |   |
| <b>56016</b> | MCK1088 | Repair Kit, Brake Caliper |       |  |
| <b>54174</b> | MCK1309 | Repair Kit, Brake Caliper |       |  |
| <b>53870</b> | MCK1139 | Repair Kit, Brake Caliper |       |  |

| Auger Nr.    | OEM Nr. | Description                        | Model | Picture   |
|--------------|---------|------------------------------------|-------|---|
| <b>71870</b> | -       | Repair Kit, Brake Caliper<br>109,5 |       |    |
| <b>70695</b> | -       | Repair Kit, Brake Caliper<br>109,5 |       |    |
| <b>57174</b> | -       | Piston Housing Assembly<br>109,5   |       |   |
| <b>56136</b> | -       | Repair Kit, Brake Caliper          |       |  |
| <b>70694</b> | -       | Repair Kit, Brake Caliper          |       |  |
| <b>56137</b> | -       | Repair Kit, Brake Caliper          |       |  |

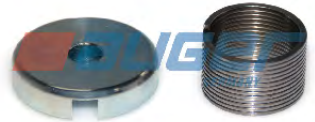

| Auger Nr.    | OEM Nr. | Description                  | Model | Picture   |
|--------------|---------|------------------------------|-------|---|
| <b>70699</b> | -       | Adjusting Mechanism<br>109,5 |       |    |
| <b>56141</b> | -       | Repair Kit, Brake Caliper    |       |    |
| <b>70693</b> | -       | Repair Kit, Brake Caliper    |       |   |
| <b>70700</b> | -       | Bushing<br>ø10xø12/ø18x7     |       |  |

06

# MERITOR / ROR ELSA 225 TYPE CALIPER



| Auger Nr. | OEM Nr. | Description | Model | Picture |
|-----------|---------|-------------|-------|---------|
|-----------|---------|-------------|-------|---------|

**55819** SJ4112 Repair Kit, Brake Caliper



**56011** MCK1296 Repair Kit, Brake Caliper



**56107** MCK1174 Repair Kit, Brake Caliper



**Spare Parts**

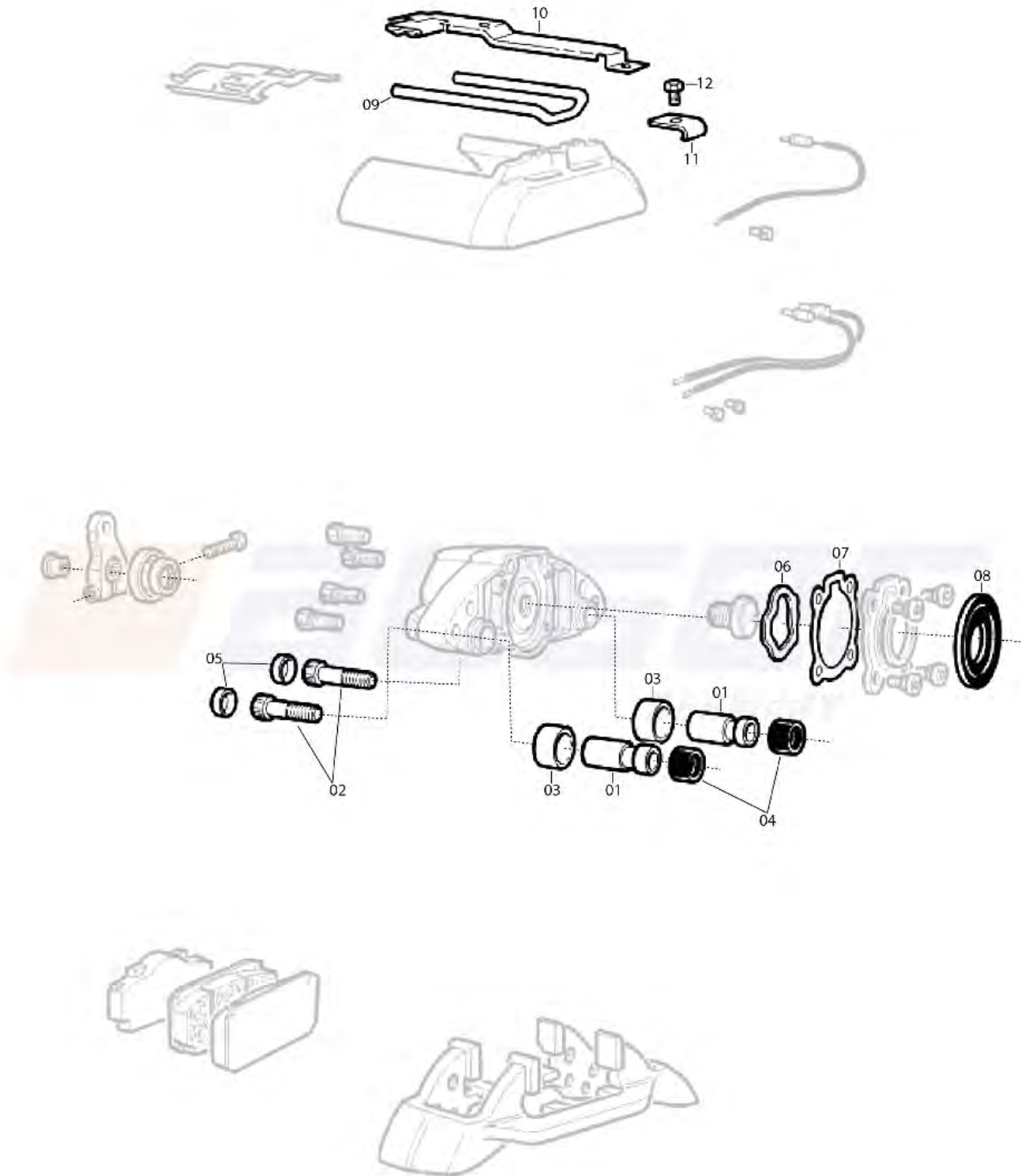

| Sr. | Auger Nr. | O.E.M. Nr. | Description                       | Picture   | Sr.   | Auger Nr. | O.E.M. Nr. | Description                    | Picture   |
|-----|-----------|------------|-----------------------------------|---|-------|-----------|------------|--------------------------------|---|
| 01  | 72727     | -          | Pin<br>ø31,9xø89,5                |    | 02    | 55297     | -          | Socket Head Bolt<br>M18x1,5/95 |    |
| 03  | 72848     | -          | Spacertube<br>ø46,75xø49x25       |    | 04    | 55383     | -          | Rubber Seal<br>ø21/ø35         |    |
| 05  | 72883     | -          | Cover<br>ø36x10                   |    | 06    | 72844     | -          | Spring Washer<br>ø82xø98       |    |
| 07  | 72968     | -          | Gasket                            |    | 08    | 59006     | 68320136   | Plastic Dust Cover<br>ø44/ø68  |    |
| 09  | 73101     | -          | Spring Clamp                      |  | 10    | 72926     | -          | Retaining Plate                |  |
| 10  | 72927     | -          | Retaining Plate                   |  | 11    | 72928     | -          | Plate                          |  |
| 12  | 72769     | -          | Hexagon Head Screw<br>M10x1,25/20 |  | 60279 | 68966036  | Lubricant  |                                |   |

| Auger Nr.    | OEM Nr. | Description               | Model | Picture   |
|--------------|---------|---------------------------|-------|---|
| <b>54557</b> | SP8999  | Repair Kit, Brake Caliper |       |  |

|              |        |                           |  |   |
|--------------|--------|---------------------------|--|---|
| <b>55180</b> | SJ1018 | Repair Kit, Brake Caliper |  |  |
|--------------|--------|---------------------------|--|---|

**06****MERITOR / ROR  
D2 TYPE CALIPER**









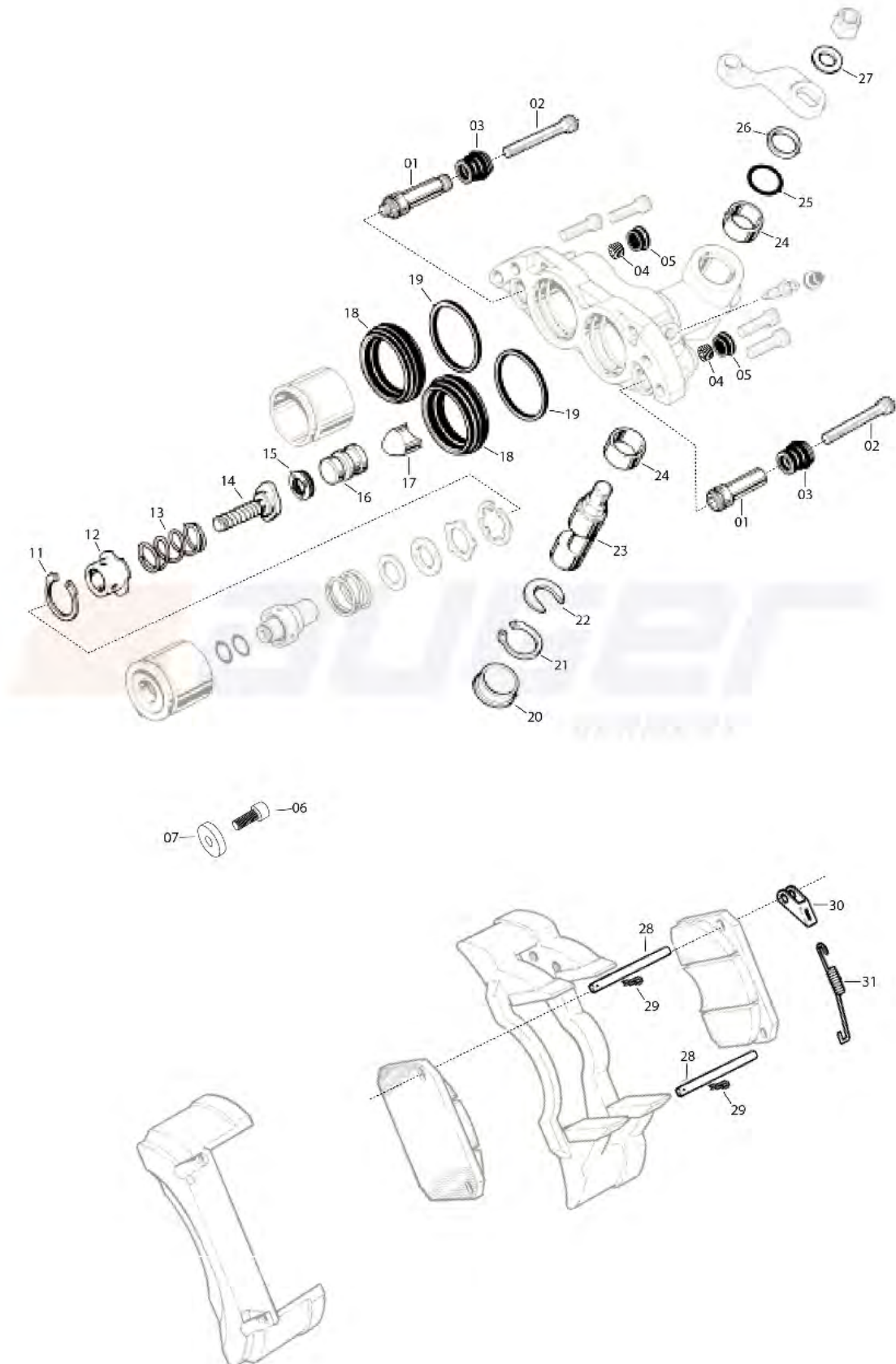











| Auger Nr.    | OEM Nr. | Description               | Model | Picture |
|--------------|---------|---------------------------|-------|---------|
| <b>56147</b> | ST1206  | Repair Kit, Brake Caliper |       |         |











**Spare Parts**









| Sr. | Auger Nr. | O.E.M. Nr. | Description                       | Picture   | Sr. | Auger Nr. | O.E.M. Nr. | Description                       | Picture   |
|-----|-----------|------------|-----------------------------------|---|-----|-----------|------------|-----------------------------------|---|
| 01  | 72725     | -          | Pin<br>ø20x71                     |    | 01  | 73117     | -          | Bush+Washer<br>Assembly<br>ø20x71 |    |
| 01  | 73118     | -          | Bush+Washer<br>Assembly<br>ø20x80 |    | 02  | 55319     | -          | Socket Head Bolt<br>M12x1,25/85   |    |
| 02  | 55320     | -          | Socket Head Bolt<br>M12x1,25/85   |    | 02  | 55321     | -          | Socket Head Bolt<br>M12x1,25/95   |    |
| 03  | 55342     | 68320057   | Rubber Seal<br>ø17,5/ø19,7        |    | 04  | 72783     | -          | Screw<br>M14x1,5 keg              |    |
| 05  | 72878     | -          | Cover<br>ø22x12,5                 |  | 05  | 72879     | -          | Cover<br>ø22x7                    |  |
| 05  | 72880     | -          | Cover<br>ø24x12,8                 |  | 06  | 57612     | -          | Socket Head Bolt<br>M10x1,5/25    |  |
| 07  | 72830     | -          | Washer                            |  | 08  | 73132     | -          | Tappet Assembly<br>ø58x72         |  |
| 08  | 73133     | -          | Tappet Assembly<br>ø68x72         |  | 08  | 73134     | -          | Tappet Assembly<br>ø60x72         |  |
| 08  | 73172     | -          | Tappet Assembly<br>ø68x72         |  | 09  | 72985     | -          | O-Ring<br>ø2,65xø23,6             |  |
| 10  | 72835     | -          | Circlip<br>DIN 983-38x1,75        |  | 11  | 72837     | -          | Circlip<br>ø51,5x1,75             |  |

| Sr. | Auger Nr. | O.E.M. Nr. | Description              | Picture   | Sr. | Auger Nr. | O.E.M. Nr. | Description              | Picture   |
|-----|-----------|------------|--------------------------|---|-----|-----------|------------|--------------------------|---|
| 12  | 72899     | -          | Cover<br>ø26,6xø37x24    |    | 12  | 72900     | -          | Cover<br>ø26,6xø37x19    |    |
| 13  | 73035     | -          | Spring<br>ø33x63         |    | 14  | 73071     | -          | Adjuster Bolt            |    |
| 15  | 55361     | 68320093   | Rubber Seal<br>ø19/ø20   |    | 16  | 72761     | -          | Tappet<br>ø31,5x42       |    |
| 17  | 73171     | -          | Rod                      |    | 18  | 55359     | 68320072   | Rubber Seal<br>ø47/ø57,5 |    |
| 18  | 55360     | 68320023   | Rubber Seal<br>ø57/ø67,5 |  | 18  | 55362     | 31320168   | Rubber Seal<br>ø49/ø60,2 |  |
| 19  | 72958     | -          | Gasket<br>ø60xø66x3      |  | 19  | 72959     | -          | Gasket<br>ø68xø74x3      |  |
| 19  | 72961     | -          | Gasket<br>ø58xø64x3      |  | 20  | 72935     | -          | Cover<br>ø45,3x8,5       |  |
| 20  | 72936     | -          | Cover<br>ø45,3x6,75      |  | 21  | 72840     | -          | Circlip                  |  |
| 22  | 72831     | -          | C Washer                 |  | 23  | 72760     | -          | Camshaft<br>ø35x107      |  |
| 24  | 73012     | -          | Bushing<br>ø35xø39x20    |  | 25  | 72986     | -          | O-Ring<br>ø3xø34,5       |  |





| Sr.   | Auger Nr. | O.E.M. Nr. | Description             | Picture   | Sr.   | Auger Nr. | O.E.M. Nr. | Description             | Picture   |
|-------|-----------|------------|-------------------------|---|-------|-----------|------------|-------------------------|---|
| 26    | 59050     | 68320185   | Plastic Washer<br>ø34,5 |  | 27    | 72960     | -          | Gasket<br>ø23xø28,2x2,6 |  |
| 28    | 72738     | -          | Pin<br>ø8x113,5         |  | 29    | 72796     | -          | Split pin               |  |
| 30    | 72894     | -          | Holder                  |  | 31    | 73032     | -          | Spring                  |  |
| 60277 | 68966041  | -          | Lubricant               |   | 60278 | 32932966  | -          | Lubricant               |   |

| Auger Nr. | OEM Nr.          | Description               | Model | Picture   |
|-----------|------------------|---------------------------|-------|---|
| 54538     | SJ1034           | Repair Kit, Brake Caliper |       |  |
| 54540     | SP8565           | Repair Kit, Brake Caliper |       |  |
| 54543     | SJ1035<br>ST1153 | Repair Kit, Brake Caliper |       |  |

| Auger Nr.    | OEM Nr. | Description               | Model | Picture   |
|--------------|---------|---------------------------|-------|---|
| <b>54544</b> | SP8902  | Repair Kit, Brake Caliper |       |    |
| <b>54541</b> | SJ1022  | Repair Kit, Brake Caliper |       |    |
| <b>54534</b> | SP9670  | Repair Kit, Brake Caliper |       |   |
| <b>54539</b> | SJ1030  | Repair Kit, Brake Caliper |       |  |
| <b>54536</b> | SP9669  | Repair Kit, Brake Caliper |       |  |
| <b>55179</b> | SJ1033  | Repair Kit, Brake Caliper |       |  |

| Auger Nr.    | OEM Nr. | Description               | Model | Picture   |
|--------------|---------|---------------------------|-------|---|
| <b>54535</b> | SP8567  | Repair Kit, Brake Caliper |       |    |
| <b>54537</b> | SP8564  | Repair Kit, Brake Caliper |       |    |
| <b>54542</b> | SP8566  | Repair Kit, Brake Caliper |       |   |
| <b>54533</b> | SP8597  | Repair Kit, Brake Caliper |       |  |
| <b>54545</b> | SJ1037  | Repair Kit, Brake Caliper |       |  |
| <b>55813</b> | ST1154  | Repair Kit, Brake Caliper |       |  |



| Auger Nr.    | OEM Nr. | Description               | Model | Picture   |
|--------------|---------|---------------------------|-------|---|
| <b>56037</b> | SJ1091  | Repair Kit, Brake Caliper |       |    |
| <b>56038</b> | SJ1092  | Repair Kit, Brake Caliper |       |    |
| <b>56039</b> | SJ1215  | Repair Kit, Brake Caliper |       |   |
| <b>57596</b> | SJ1214  | Repair Kit, Brake Caliper |       |  |

06

## MERITOR / ROR

## 58B58 - 60B60 - 68B68 TYPE CALIPER



| Auger Nr.    | OEM Nr. | Description               | Model | Picture |
|--------------|---------|---------------------------|-------|---------|
| <b>57594</b> | SP8570  | Repair Kit, Brake Caliper |       |         |
| <b>57595</b> | SJ1032  | Repair Kit, Brake Caliper |       |         |
| <b>56012</b> | SP8563  | Repair Kit, Brake Caliper |       |         |
| <b>56013</b> | -       | Repair Kit, Brake Caliper |       |         |

CALIPER  
MERITOR-ROR  
KNORR

**WABCO**



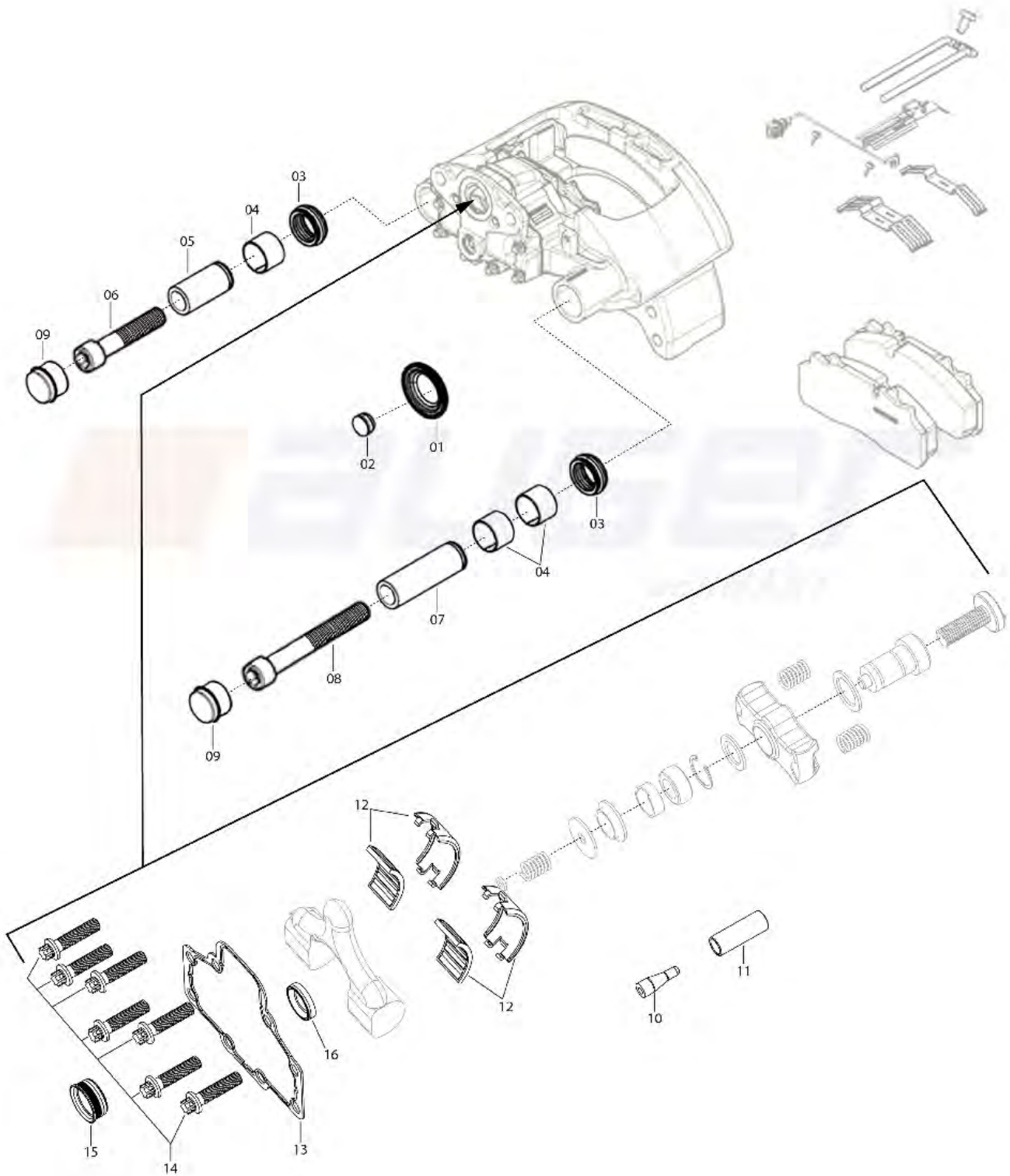

HALDEX  
OTHER TYPE CALIPERS  
UNIVERSAL PARTS

we keep your business **on the move**



Spare Parts



| Sr. | Auger Nr. | O.E.M. Nr. | Description                     | Picture   | Sr.   | Auger Nr. | O.E.M. Nr. | Description                                    | Picture   |
|-----|-----------|------------|---------------------------------|---|-------|-----------|------------|--|---|
| 01  | 55354     | -          | Rubber Seal<br>ø31xø72,5        |    | 02    | 73188     | -          | Plug<br>ø26                                    |    |
| 03  | 55335     | -          | Rubber Seal<br>ø23,5/ø30        |    | 04    | 69738     | -          | Bushing<br>ø30xø34x25                          |    |
| 05  | 72730     | -          | Pin<br>ø29,7x77                 |    | 06    | 55325     | -          | Socket Head Bolt<br>M16x1.5/70                 |    |
| 07  | 72731     | -          | Pin<br>ø30x91                   |    | 08    | 55326     | -          | Socket Head Bolt<br>M16x1.5/90                 |    |
| 09  | 72888     | -          | Cover<br>ø34x16,5               |  | 10    | 72678     | -          | Plug   |  |
| 11  | 72679     | -          | Plastic Bushing<br>ø12,5xø16x44 |  | 12    | 57600     | -          | Needle Bearing<br>ø44xø54x29,8                 |  |
| 13  | 72966     | -          | Gasket                          |  | 14    | 55327     | -          | Hexagon Bolt With<br>Astral Flange<br>M10x1/40 |  |
| 14  | 57608     | -          | Socket Head Bolt<br>M10x1/40    |  | 15    | 72948     | -          | Seal Ring<br>ø7xø30,2x13,7                     |  |
| 16  | 72947     | -          | Seal Ring<br>ø7xø29,3x8,5       |  | 60581 | -         | Lubricant  |  |   |
|     |           |            |                                 |   | 60583 | -         | Lubricant  |  |   |
|     |           |            |                                 |   | 73207 | -         | Lubricant  |  |   |









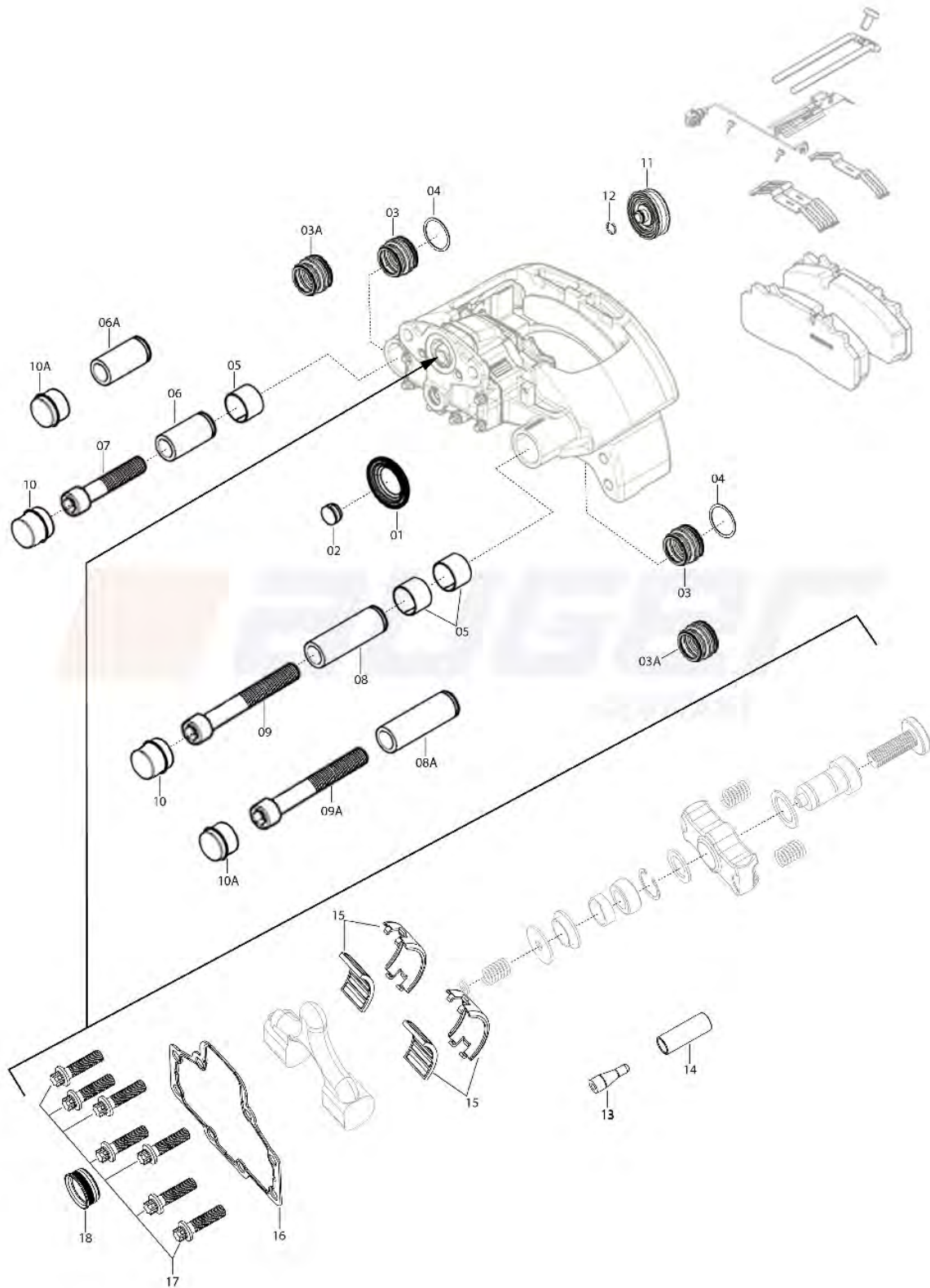





| Auger Nr.    | OEM Nr.                    | Description               | Model | Picture   |
|--------------|----------------------------|---------------------------|-------|---|
| <b>54566</b> | 12 999 699VT<br>12 999 702 | Repair Kit, Brake Caliper |       |    |
| <b>54561</b> | 12 999 704VT               | Repair Kit, Brake Caliper |       |    |
| <b>54565</b> | 12 999 580VT               | Repair Kit, Brake Caliper |       |   |
| <b>56118</b> | -                          | Repair Kit, Brake Caliper |       |  |













| Auger Nr.    | OEM Nr.       | Description                                       | Model | Picture  |
|--------------|---------------|---|-------|--|
| <b>56026</b> | 640 175 920.2 | Repair Kit, Brake Caliper                         |       |   |
| <b>57600</b> | -             | Needle Bearing, Brake Caliper<br><br>ø44xø54x29,8 |       |   |
| <b>56119</b> | -             | Repair Kit, Brake Caliper                         |       |  |

**Spare Parts**



| Sr. | Auger Nr. | O.E.M. Nr. | Description                    | Picture   | Sr. | Auger Nr. | O.E.M. Nr. | Description                     | Picture   |
|-----|-----------|------------|--------------------------------|---|-----|-----------|------------|---------------------------------|---|
| 01  | 55354     | -          | Rubber Seal<br>ø31xø72,5       |    | 02  | 73188     | -          | Plug<br>ø26                     |    |
| 03  | 55337     | -          | Rubber Seal<br>ø35/ø37,5       |    | 03  | 57653     | -          | Rubber Seal<br>ø30/ø35,5        |    |
| 03A | 55334     | -          | Rubber Seal<br>ø35xø50,5       |    | 04  | 72815     | -          | Washer<br>ø38xø44,5x1           |    |
| 04  | 72816     | -          | Washer<br>ø38xø44,5x1          |    | 05  | 73010     | -          | Bushing<br>ø38xø42x30           |    |
| 05  | 73020     | -          | Bushing<br>ø36xø40x30          |  | 06  | 72728     | -          | Pin<br>ø37,7x76                 |  |
| 06A | 72756     | -          | Pin<br>ø35,7x81                |  | 07  | 55299     | -          | Socket Head Bolt<br>M16x1.5/80  |  |
| 07  | 72782     | -          | Socket Head Bolt<br>M16x1.5/80 |  | 08  | 72729     | -          | Pin<br>ø38x118                  |  |
| 08A | 72757     | -          | Pin<br>ø36x105                 |  | 09  | 55323     | -          | Socket Head Bolt<br>M16x1.5/120 |  |
| 09A | 55326     | -          | Socket Head Bolt<br>M16x1.5/90 |  | 10  | 72886     | -          | Cover<br>ø42x29                 |  |
| 10A | 72884     | -          | Cover<br>ø42x17                |  | 10A | 72917     | -          | Cover<br>ø40x15                 |  |

| Sr.   | Auger Nr. | O.E.M. Nr. | Description                    | Picture   | Sr.   | Auger Nr. | O.E.M. Nr. | Description                     | Picture   |
|-------|-----------|------------|--------------------------------|---|-------|-----------|------------|---------------------------------|---|
| 11    | 55350     | -          | Seal Boot<br>ø18xø70,5         |  | 12    | 72841     | -          | Retaining Ring<br>ø18,9x1,2     |  |
| 13    | 72678     | -          | Plug                           |  | 14    | 72679     | -          | Plastic Bushing<br>ø12,5xø16x44 |  |
| 15    | 57600     | -          | Needle Bearing<br>ø44xø54x29,8 |  | 16    | 72966     | -          | Gasket                          |  |
| 17    | 57608     | -          | Socket Head Bolt<br>M10x1/40   |  | 18    | 72948     | -          | Seal Ring<br>ø7xø30,2x13,7      |  |
| 60581 | -         | -          | Lubricant                      |   | 60583 | -         | -          | Lubricant                       |   |
| 60582 | -         | -          | Lubricant                      |   | 73207 | -         | -          | Lubricant                       |   |

| Auger Nr. | OEM Nr.       | Description               | Model | Picture   |
|-----------|---------------|---------------------------|-------|---|
| 56120     | -             | Repair Kit, Brake Caliper |       |  |
| 56026     | 640 175 920.2 | Repair Kit, Brake Caliper |       |  |
| 54559     | 12 999 738VT  | Repair Kit, Brake Caliper |       |  |

06

# WABCO

## 19,5" TYPE CALIPER







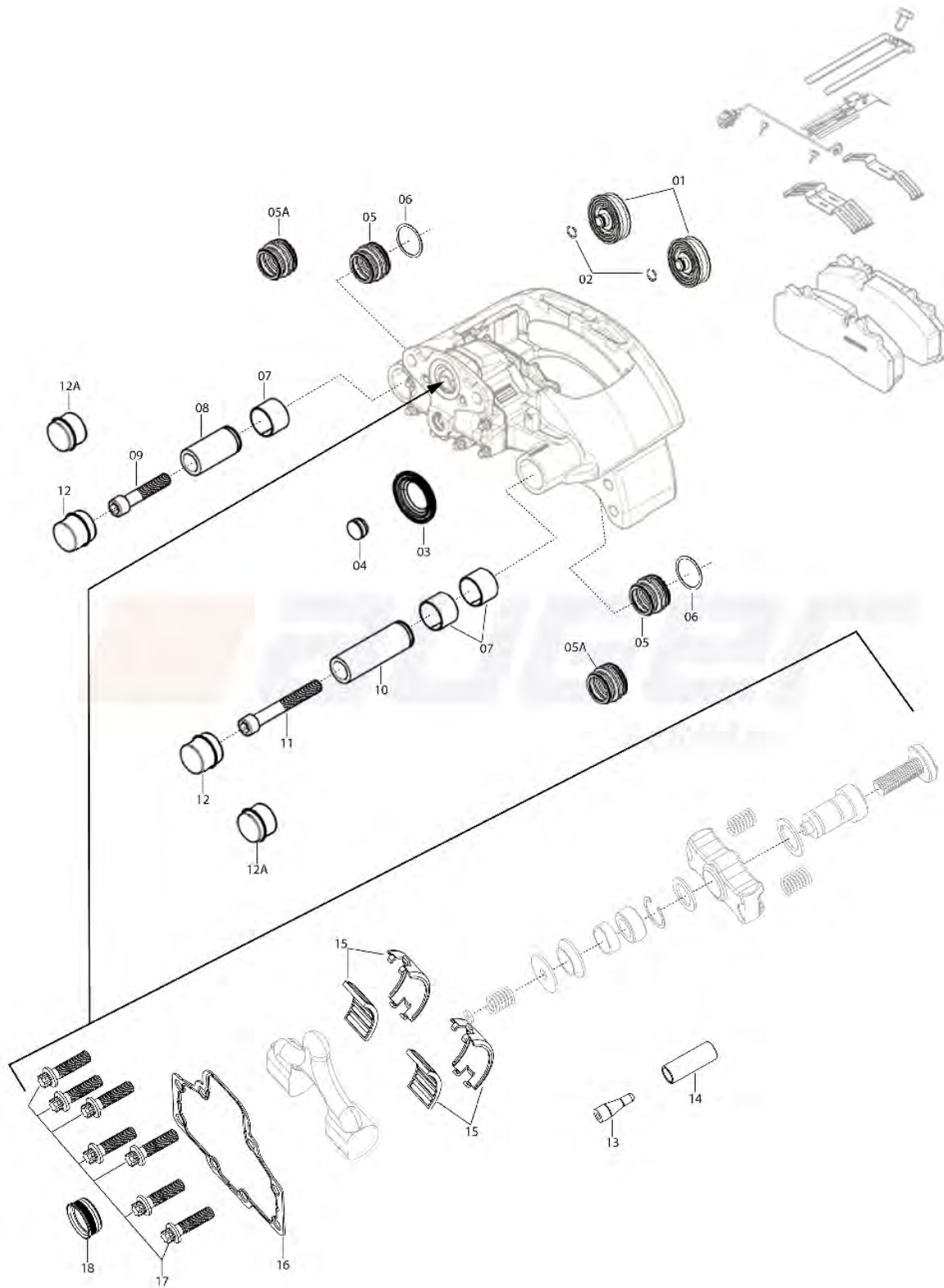















| Auger Nr.    | OEM Nr.      | Description                   | Model | Picture |
|--------------|--------------|-------------------------------|-------|---------|
| <b>54562</b> | 12 999 746VT | Repair Kit, Brake Caliper     |       |         |
| <b>70838</b> | 12 999 776   | Repair Kit, Brake Caliper     |       |         |
| <b>56121</b> | -            | Repair Kit, Brake Caliper     |       |         |
| <b>72966</b> | -            | Gasket, Brake Caliper         |       |         |
| <b>57600</b> | -            | Needle Bearing, Brake Caliper |       |         |



**Spare Parts**





| Sr. | Auger Nr. | O.E.M. Nr. | Description                    | Picture   | Sr. | Auger Nr. | O.E.M. Nr. | Description                     | Picture   |
|-----|-----------|------------|--------------------------------|---|-----|-----------|------------|---------------------------------|---|
| 01  | 55350     | -          | Seal Boot<br>ø18xø70,5         |    | 02  | 72841     | -          | Retaining Ring<br>ø18,9x1,2     |    |
| 03  | 55354     | -          | Rubber Seal<br>ø31xø72,5       |    | 04  | 73188     | -          | Plug<br>ø26                     |    |
| 05  | 55337     | -          | Rubber Seal<br>ø35/ø37,5       |    | 05A | 55334     | -          | Rubber Seal<br>ø35xø50,5        |    |
| 06  | 72815     | -          | Washer<br>ø38xø44,5x1          |    | 06  | 72816     | -          | Washer<br>ø38xø44,5x1           |    |
| 07  | 73010     | -          | Bushing<br>ø38xø42x30          |  | 08  | 72728     | -          | Pin<br>ø37,7x76                 |  |
| 09  | 55299     | -          | Socket Head Bolt<br>M16x1.5/80 |  | 09  | 72782     | -          | Socket Head Bolt<br>M16x1.5/80  |  |
| 10  | 72729     | -          | Pin<br>ø38x118                 |  | 11  | 55323     | -          | Socket Head Bolt<br>M16x1.5/120 |  |
| 12  | 72886     | -          | Cover<br>ø42x29                |  | 12A | 72884     | -          | Cover<br>ø42x17                 |  |
| 13  | 72678     | -          | Plug                           |  | 14  | 72679     | -          | Plastic Bushing<br>ø12,5xø16x44 |  |
| 15  | 57600     | -          | Needle Bearing<br>ø44xø54x29,8 |  | 16  | 72966     | -          | Gasket                          |  |

| Sr.   | Auger Nr. | O.E.M. Nr. | Description                                     | Picture   | Sr.   | Auger Nr. | O.E.M. Nr. | Description                    | Picture   |
|-------|-----------|------------|---|---|-------|-----------|------------|--------------------------------|---|
| 17    | 55327     | -          | Hexagon Bolt With Astral Flange<br><br>M10x1/40 |  | 18    | 72948     | -          | Seal Ring<br><br>ø7xø30,2x13,7 |  |
| 60582 | -         | -          | Lubricant                                       |   | 60583 | -         | -          | Lubricant                      |   |
| 60581 | -         | -          | Lubricant                                       |   |       |           |            |                                |   |

| Auger Nr.    | OEM Nr.      | Description               | Model | Picture   |
|--------------|--------------|---------------------------|-------|---|
| <b>54562</b> | 12 999 746VT | Repair Kit, Brake Caliper |       |    |
| <b>54559</b> | 12 999 738VT | Repair Kit, Brake Caliper |       |  |
| <b>70838</b> | 12 999 776   | Repair Kit, Brake Caliper |       |  |

06

# WABCO

## 22,5" TYPE CALIPER (Single Piston)







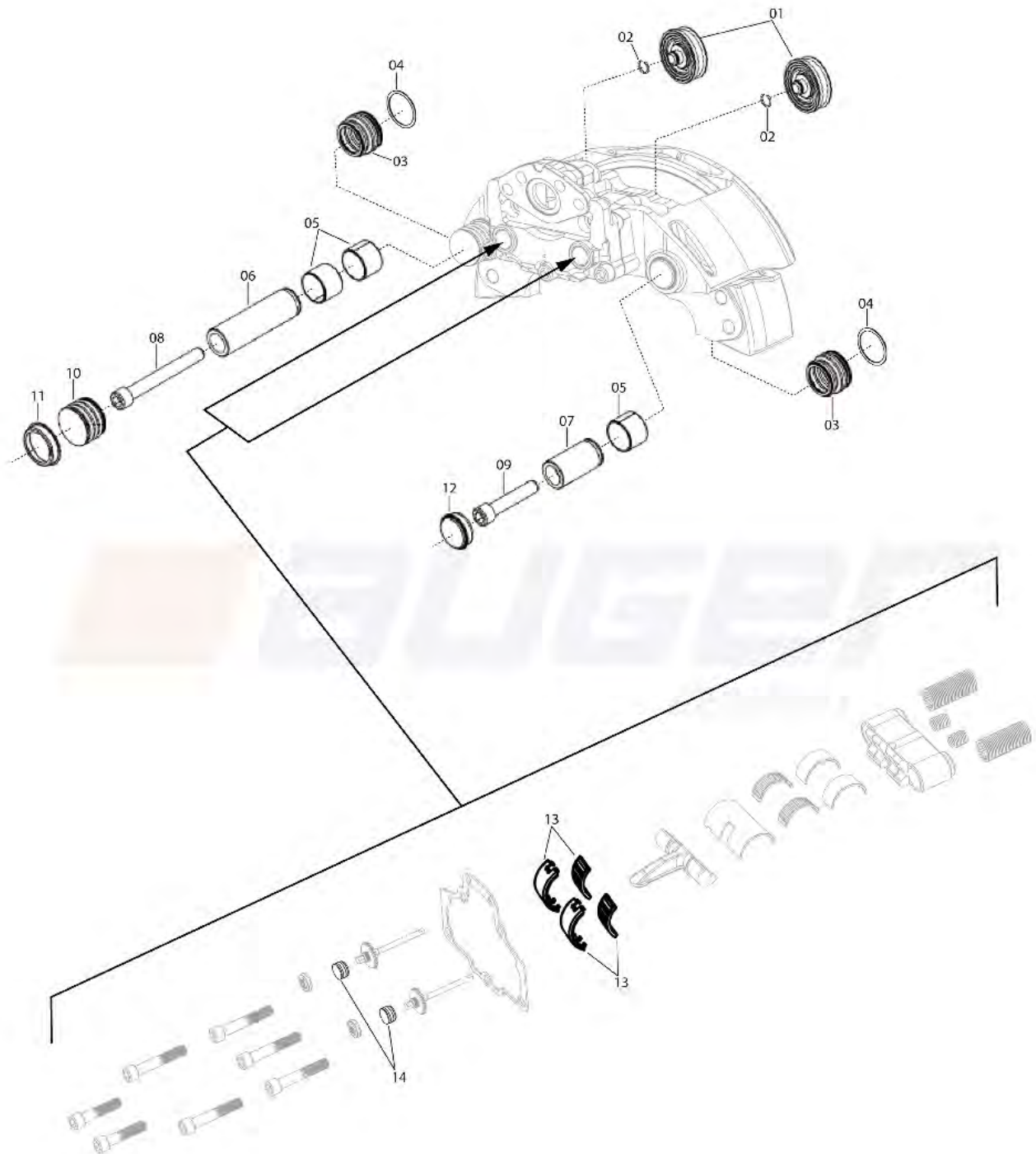







| Auger Nr.    | OEM Nr.       | Description                     | Model | Picture |
|--------------|---------------|---------------------------------|-------|---------|
| <b>56026</b> | 640 175 920.2 | Repair Kit, Brake Caliper       |       |         |
| <b>55327</b> | -             | Hexagon Bolt With Astral Flange |       |         |
| <b>72966</b> | -             | Gasket                          |       |         |
| <b>57600</b> | -             | Needle Bearing, Brake Caliper   |       |         |



**Spare Parts**



# WABCO

## 22,5" TYPE CALIPER (Double Piston)

| Sr.   | Auger Nr. | O.E.M. Nr. | Description                    | Picture   | Sr. | Auger Nr. | O.E.M. Nr. | Description                     | Picture   |
|-------|-----------|------------|--------------------------------|---|-----|-----------|------------|---------------------------------|---|
| 01    | 55350     | -          | Seal Boot<br>ø18xø70,5         |    | 02  | 72841     | -          | Retaining Ring<br>ø18,9x1,2     |    |
| 03    | 55334     | -          | Rubber Seal<br>ø35xø50,5       |    | 04  | 72815     | -          | Washer<br>ø38xø44,5x1           |    |
| 05    | 73010     | -          | Bushing<br>ø38xø42x30          |    | 06  | 72735     | -          | Pin<br>ø38x129                  |    |
| 07    | 72734     | -          | Pin<br>ø37,7x71                |    | 08  | 55322     | -          | Socket Head Bolt<br>M16x1.5/130 |    |
| 09    | 55299     | -          | Socket Head Bolt<br>M16x1.5/80 |  | 10  | 55379     | -          | Rubber Seal<br>ø37,5            |  |
| 11    | 72885     | -          | Cover<br>ø42,5xø51,5x11,5      |  | 12  | 72884     | -          | Cover<br>ø42x17                 |  |
| 13    | 57600     | -          | Needle Bearing<br>ø44xø54x29,8 |  | 14  | 73188     | -          | Plug<br>ø26                     |  |
| 60581 | -         | -          | Lubricant                      |   |     |           |            |                                 |   |

| Auger Nr.    | OEM Nr.      | Description                                       | Model | Picture  |
|--------------|--------------|---|-------|--|
| <b>57600</b> | -            | Needle Bearing, Brake Caliper<br><br>ø44xø54x29,8 |       |   |
| <b>54558</b> | 12 999 677VT | Repair Kit, Brake Caliper                         |       |   |
| <b>54569</b> | 12 999 678VT | Repair Kit, Brake Caliper                         |       |  |



**06****WABCO  
10.0" TYPE CALIPER**

| Auger Nr.    | OEM Nr.      | Description              | Model | Picture   |
|--------------|--------------|--------------------------|-------|---|
| <b>54528</b> | 12 999 729VT | Repair Kit,Brake Caliper |       |  |

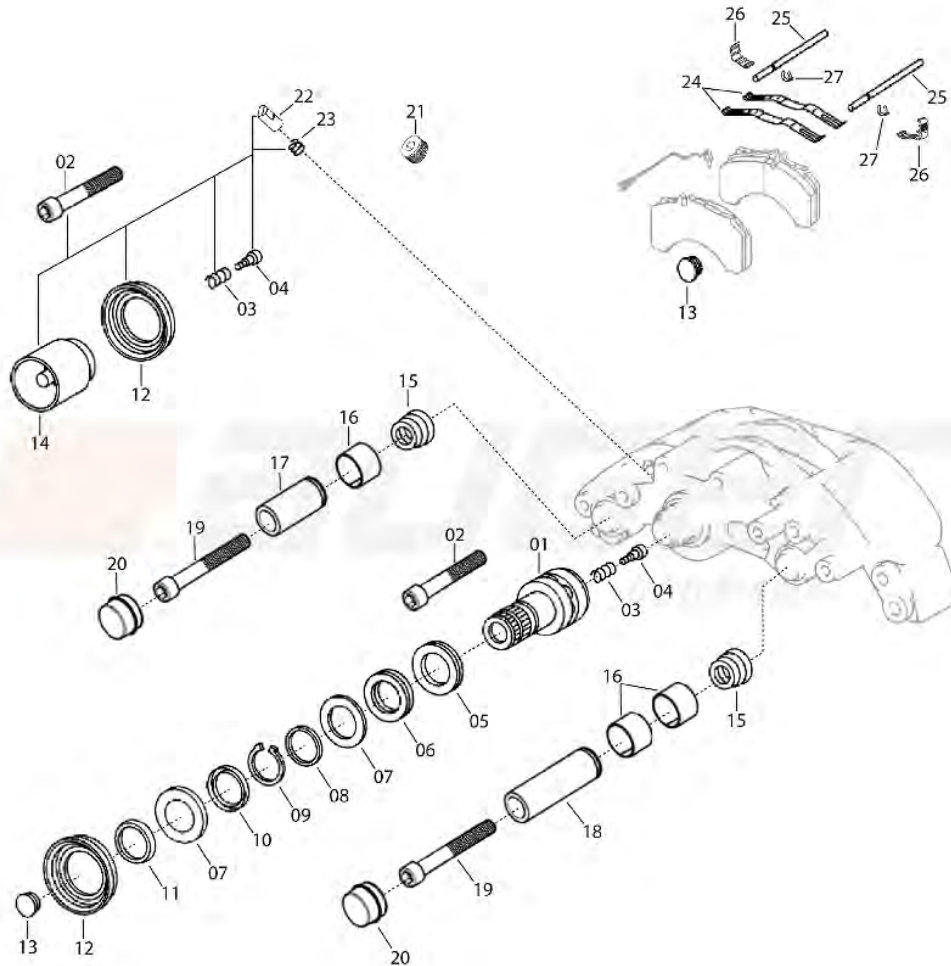

### Spare Parts









| Sr. | Auger Nr. | O.E.M. Nr. | Description                | Picture |
|-----|-----------|------------|----------------------------|---------|
| 01  | 73155     | -          | Operating Shaft<br>144 mm  |         |
| 03  | 73027     | -          | Spring<br>ø12,5x17,5       |         |
| 05  | 72952     | -          | Seal Ring<br>ø49,8xø70x6,5 |         |

| Sr. | Auger Nr. | O.E.M. Nr. | Description                    | Picture |
|-----|-----------|------------|--------------------------------|---------|
| 02  | 55299     | -          | Socket Head Bolt<br>M16x1.5/80 |         |
| 04  | 55324     | -          | Socket Head Bolt<br>M8x1.25/22 |         |
| 06  | 72819     | -          | Washer                         |         |

| Sr. | Auger Nr. | O.E.M. Nr. | Description                | Picture   | Sr. | Auger Nr. | O.E.M. Nr. | Description                     | Picture   |
|-----|-----------|------------|----------------------------|---|-----|-----------|------------|---------------------------------|---|
| 07  | 72820     | -          | Machined Washer            |    | 08  | 72855     | -          | Bearing<br>ø50,2xø69,7x3        |    |
| 09  | 59738     | -          | Circlip<br>DIN 471-50x2    |    | 10  | 72946     | -          | Seal Ring<br>ø50xø65x8          |    |
| 11  | 72887     | -          | Cover<br>ø52xø74,5x5,9     |    | 12  | 55355     | -          | Rubber Seal<br>ø56xø95,5        |    |
| 13  | 73189     | -          | Plug<br>ø23,8              |    | 14  | 73084     | -          | Piston<br>M24x3 R/ø84,8x92      |    |
| 14  | 73085     | -          | Piston<br>M24x3 L/ø84,8x92 |  | 15  | 55338     | -          | Rubber Seal<br>ø23/ø34          |  |
| 16  | 73011     | -          | Bushing<br>ø35xø39x20      |  | 17  | 72732     | -          | Pin<br>ø34,8x98,5               |  |
| 18  | 72733     | -          | Pin<br>ø35x110             |  | 19  | 55328     | -          | Socket Head Bolt<br>M16x1.5/110 |  |
| 20  | 72889     | -          | Cover<br>ø39x16,5          |  | 21  | 72784     | -          | Screw                           |  |
| 22  | 72755     | -          | Pin                        |  | 23  | 73043     | -          | Spring<br>ø9xø14,5              |  |
| 24  | 72932     | -          | Spring Holder              |  | 25  | 72759     | -          | Pin<br>ø6/ø8x192                |  |





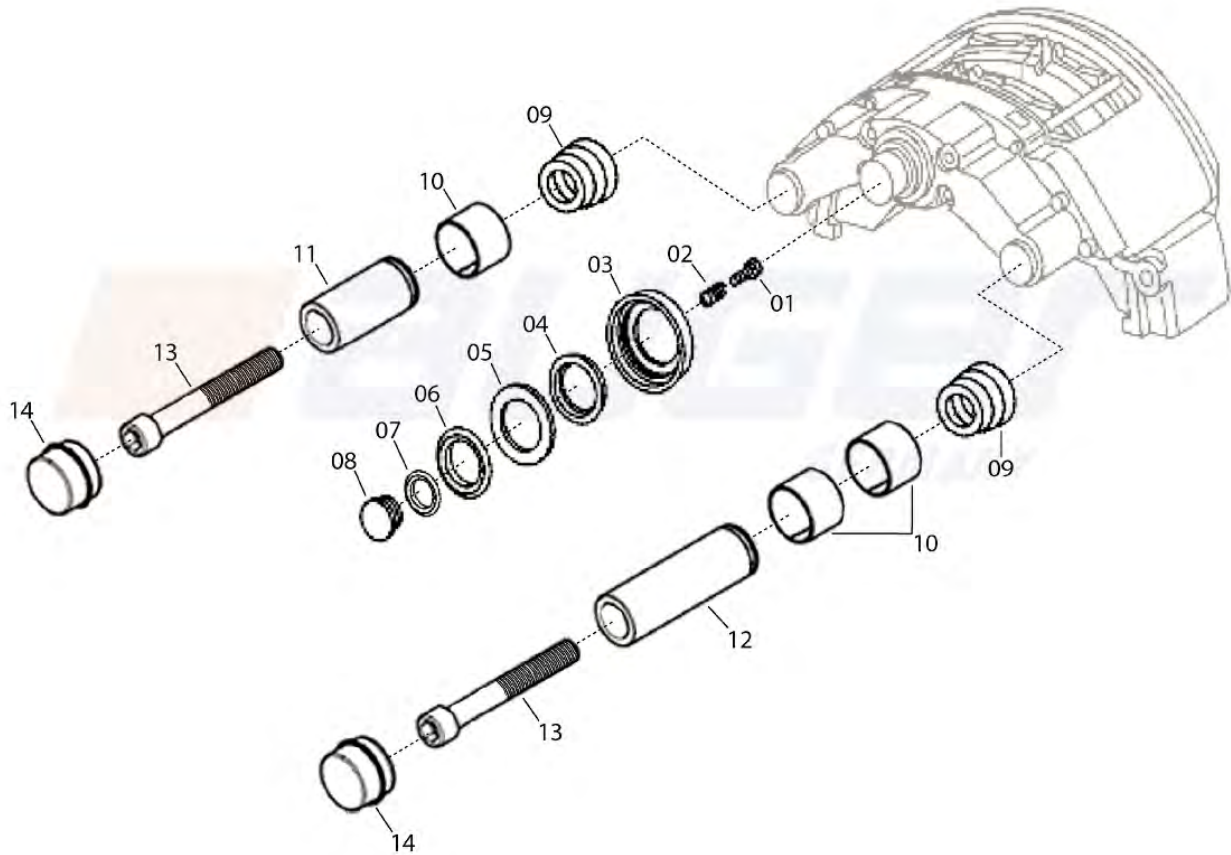

| Sr.   | Auger Nr. | O.E.M. Nr. | Description   | Picture   | Sr.   | Auger Nr. | O.E.M. Nr. | Description | Picture   |
|-------|-----------|------------|---------------|---|-------|-----------|------------|-------------|---|
| 26    | 72689     | -          | Plastic Clamp |  | 27    | 72839     | -          | Circlip     |  |
| 60581 | -         | -          | Lubricant     |   | 60583 | -         | -          | Lubricant   |   |

| Auger Nr.    | OEM Nr.      | Description               | Model | Picture   |
|--------------|--------------|---------------------------|-------|---|
| <b>56102</b> | 12 999 550VT | Repair Kit, Brake Caliper |       |    |
| <b>56103</b> | 12 999 549VT | Repair Kit, Brake Caliper |       |   |
| <b>56104</b> | 12 999 547VT | Repair Kit, Brake Caliper |       |  |









| Auger Nr.    | OEM Nr.      | Description               | Model | Picture  |
|--------------|--------------|---------------------------|-------|--|
| <b>54560</b> | 12 999 552VT | Repair Kit, Brake Caliper |       |   |
| <b>54568</b> | 12 999 551VT | Repair Kit, Brake Caliper |       |   |
| <b>56149</b> | 12 999 553VT | Repair Kit, Brake Caliper |       |  |



### Spare Parts









| Sr. | Auger Nr. | O.E.M. Nr. | Description                 | Picture   | Sr. | Auger Nr. | O.E.M. Nr. | Description              | Picture   |
|-----|-----------|------------|-----------------------------|---|-----|-----------|------------|--------------------------|---|
| 01  | 55314     | -          | Socket Head Bolt<br>M6x1/20 |  | 02  | 73026     | -          | Spring                   |  |
| 03  | 55353     | -          | Rubber Seal<br>ø46,5xø81,5  |  | 04  | 72945     | -          | Seal Ring<br>ø40xø47x4,5 |  |
| 05  | 72895     | -          | Cover<br>ø42xø65,5x5        |  | 06  | 72950     | -          | Seal Ring<br>ø40xø55x7   |  |

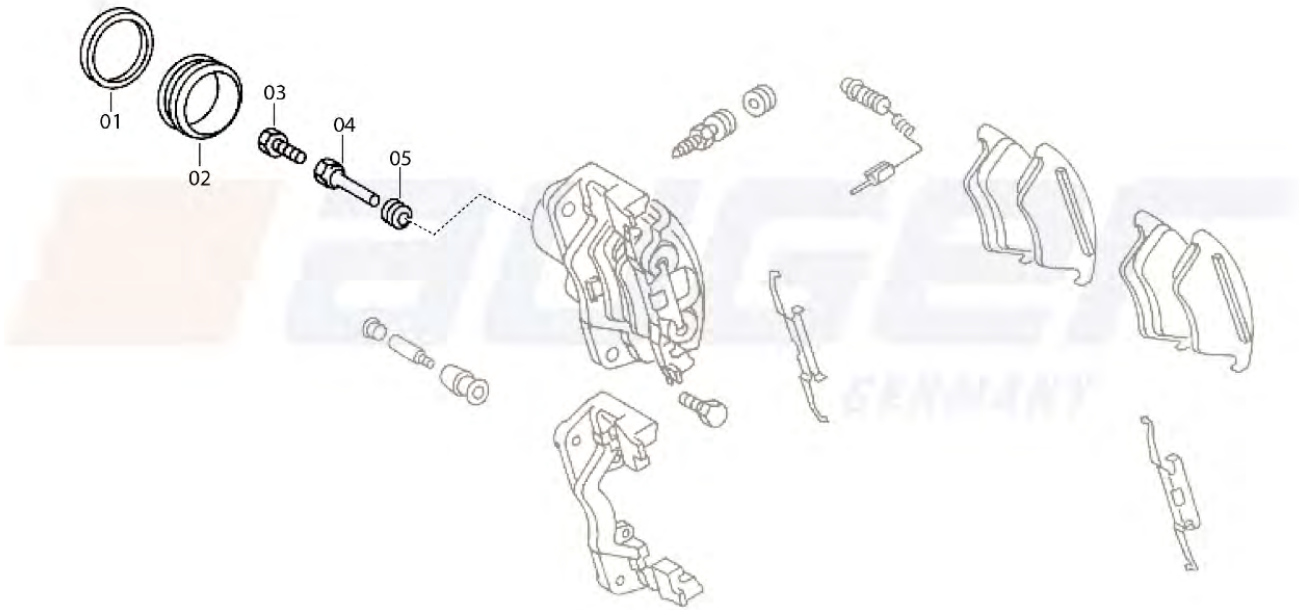

| Sr.   | Auger Nr. | O.E.M. Nr. | Description                     | Picture   | Sr. | Auger Nr. | O.E.M. Nr. | Description           | Picture   |
|-------|-----------|------------|---------------------------------|---|-----|-----------|------------|-----------------------|---|
| 07    | 72947     | -          | Seal Ring<br>ø7xø29,3x8,5       |  | 08  | 73190     | -          | Plug<br>ø33           |  |
| 09    | 55338     | -          | Rubber Seal<br>ø23/ø34          |  | 10  | 73011     | -          | Bushing<br>ø35xø39x20 |  |
| 11    | 72739     | -          | Pin<br>ø34,8x85                 |  | 12  | 72733     | -          | Pin<br>ø35x110        |  |
| 13    | 55328     | -          | Socket Head Bolt<br>M16x1.5/110 |  | 14  | 72884     | -          | Cover<br>ø42x17       |  |
| 60583 | -         | -          | Lubricant                       |   |     |           |            |                       |   |

| Auger Nr. | OEM Nr.      | Description               | Model | Picture   |
|-----------|--------------|---------------------------|-------|---|
| 56024     | 12 999 734VT | Repair Kit, Brake Caliper |       |  |
| 56025     | 12 999 733VT | Repair Kit, Brake Caliper |       |  |

**Spare Parts**

| Sr. | Auger Nr. | O.E.M. Nr. | Description                      | Picture   | Sr. | Auger Nr. | O.E.M. Nr. | Description          | Picture   |
|-----|-----------|------------|----------------------------------|---|-----|-----------|------------|----------------------|---|
| 01  | 72972     | -          | Gasket<br>ø61,5xø67x3            |  | 02  | 57638     | -          | Seal Ring<br>ø49/ø59 |  |
| 03  | 72770     | -          | Hexagon Head Screw<br>M8x1.25/20 |  | 04  | 73063     | -          | Pin                  |  |
| 05  | 55341     | -          | Rubber Seal<br>ø12,5/ø16         |  |     |           |            |                      |   |

**06****WABCO  
CALIPER DISC BRAKE 244 V-Ö**

| Auger Nr.    | OEM Nr. | Description               | Model | Picture |
|--------------|---------|---------------------------|-------|---------|
| <b>55814</b> | -       | Repair Kit, Brake Caliper |       |         |





|              |              |                           |  |  |
|--------------|--------------|---------------------------|--|--|
| <b>54567</b> | 12 999 543VT | Repair Kit, Brake Caliper |  |  |
|--------------|--------------|---------------------------|--|--|

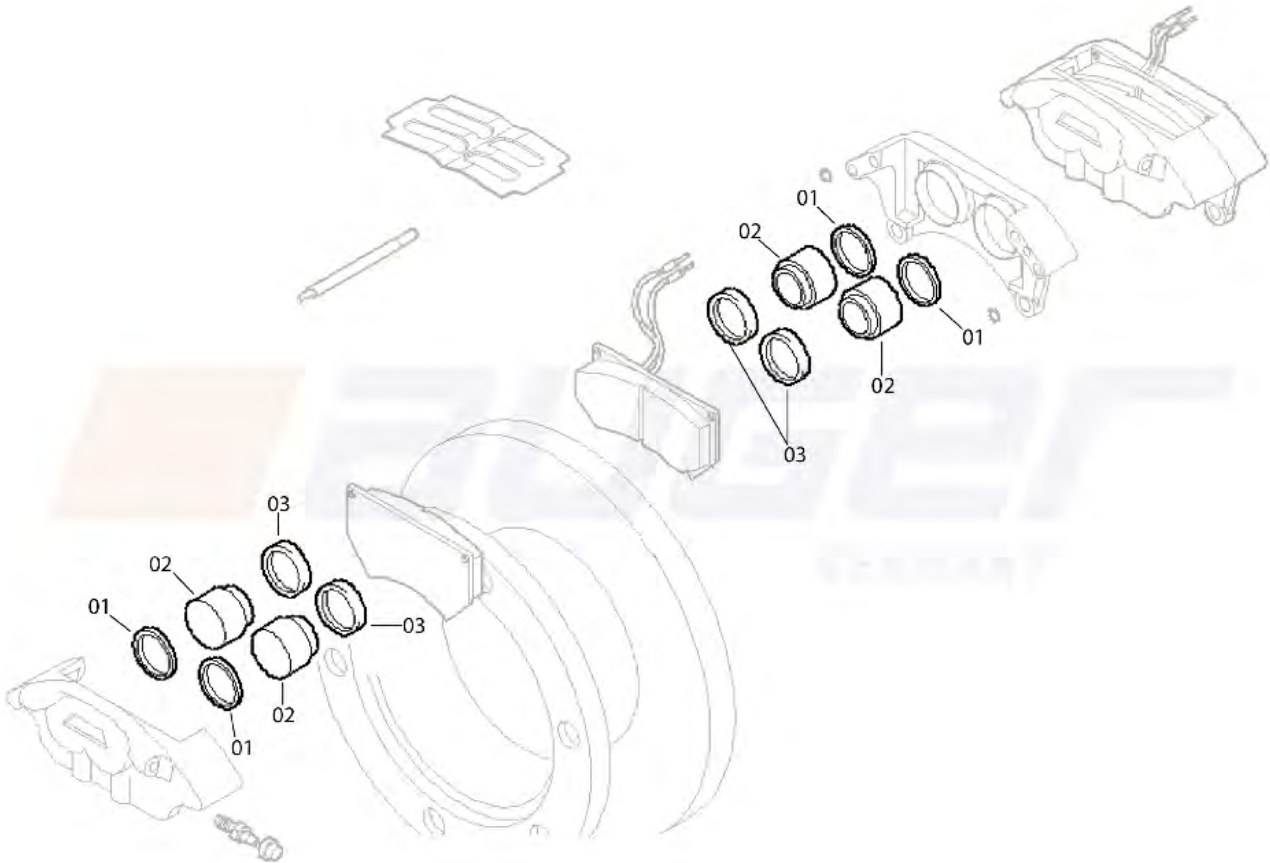

**Spare Parts**



| Sr. | Auger Nr. | O.E.M. Nr. | Description             | Picture | Sr. | Auger Nr. | O.E.M. Nr.   | Description          | Picture |
|-----|-----------|------------|-------------------------|---------|-----|-----------|--------------|----------------------|---------|
| 01  | 72965     | -          | Gasket<br>ø43,5xø49,5x3 |         | 02  | 57173     | 12 999 179VT | Piston<br>ø44x35     |         |
| 02  | 57171     | 12 999 097 | Piston<br>ø44x35        |         | 03  | 55363     | -            | Rubber Seal<br>ø32,5 |         |

# WABCO CALIPER DISC BRAKE 444 F-Ö

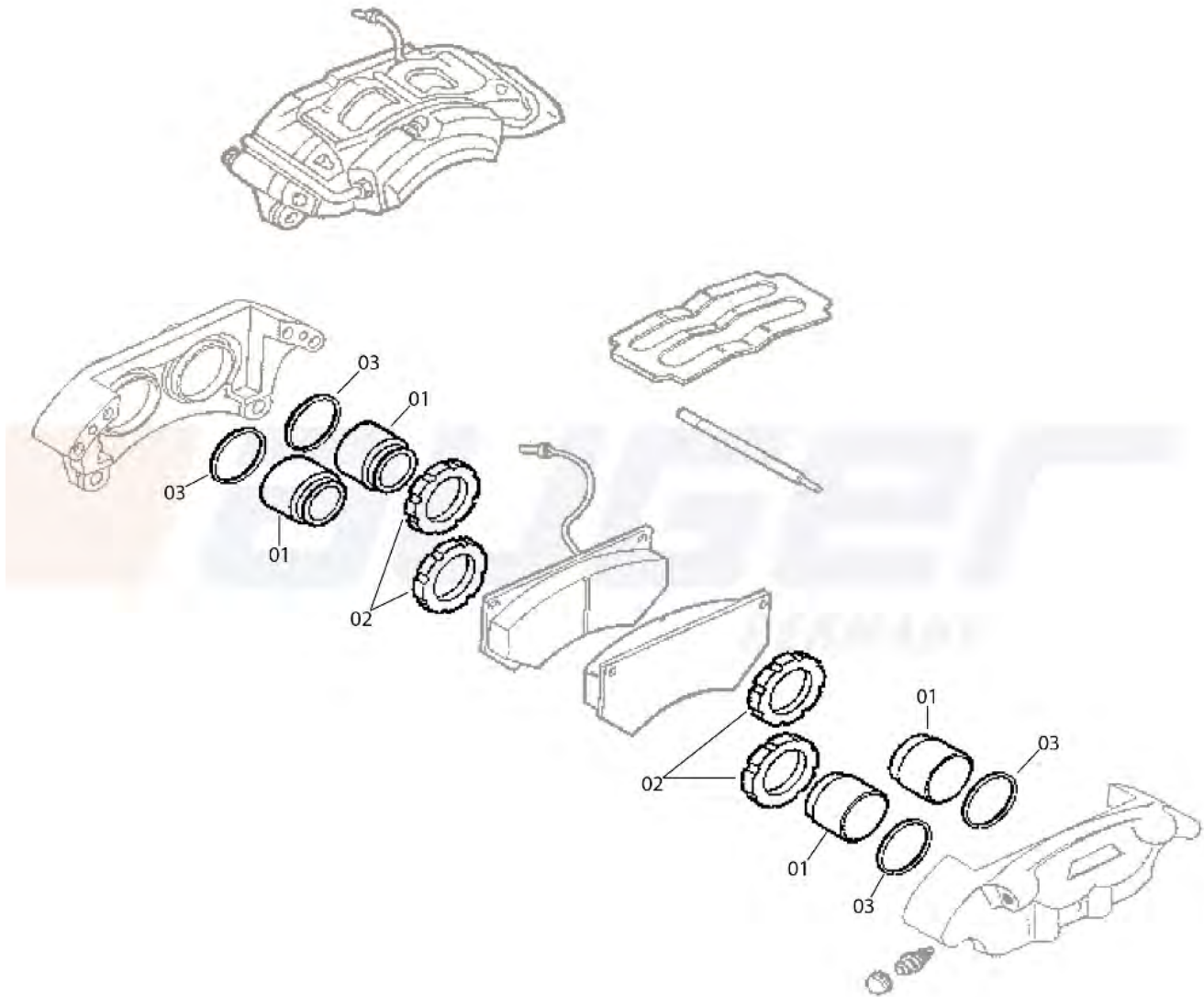
| Auger Nr.    | OEM Nr.      | Description                     | Model | Picture  |
|--------------|--------------|---------------------------------|-------|--|
| <b>57171</b> | 12 999 097   | Piston, Brake Caliper<br>ø44x35 |       |   |
| <b>57173</b> | 12 999 179VT | Piston, Brake Caliper<br>ø44x35 |       |   |
| <b>54564</b> | 12 999 197VT | Repair Kit, Brake Caliper       |       |  |



**Spare Parts**

| Sr. | Auger Nr. | O.E.M. Nr.   | Description           | Picture   |
|-----|-----------|--------------|-----------------------|---|
| 01  | 57168     | 12 999 324VT | Piston<br>ø50x38      |  |
| 03  | 72957     | -            | Gasket<br>ø49xø56x3,5 |  |

| Sr. | Auger Nr. | O.E.M. Nr. | Description                | Picture   |
|-----|-----------|------------|----------------------------|---|
| 02  | 55356     | -          | Seal Ring<br>ø34,5xø70x7,5 |  |

# WABCO CALIPER DISC BRAKE 450 F-Ö









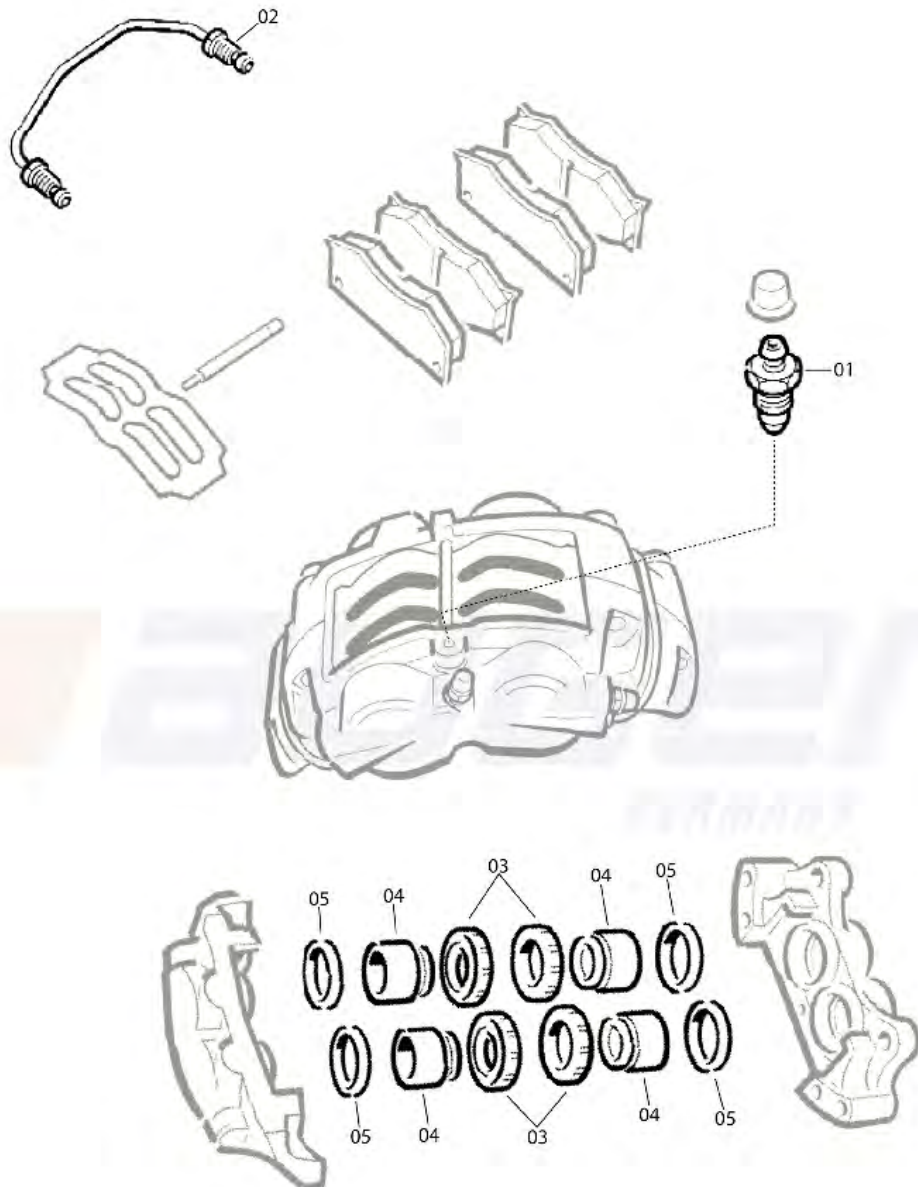





| Auger Nr.    | OEM Nr.      | Description                     | Model | Picture   |
|--------------|--------------|---------------------------------|-------|---|
| <b>57168</b> | 12 999 324VT | Piston, Brake Caliper<br>ø50x38 |       |  |
| <b>54527</b> | 12 999 199VT | Repair Kit, Brake Caliper       |       |  |

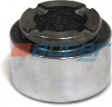

Spare Parts





| Sr. | Auger Nr. | O.E.M. Nr.   | Description           | Picture   | Sr. | Auger Nr. | O.E.M. Nr.   | Description          | Picture   |
|-----|-----------|--------------|-----------------------|---|-----|-----------|--------------|----------------------|---|
| 01  | 71468     | -            | Valve                 |    | 02  | 55998     | -            | Pipe<br>M10x1/177    |    |
| 02  | 55999     | -            | Pipe<br>M10x1/177     |    | 02  | 73086     | -            | Pipe<br>M10x1/152    |    |
| 02  | 73087     | -            | Pipe<br>M10x1/152     |    | 03  | 55358     | -            | Rubber Seal<br>ø41,5 |    |
| 03  | 57640     | -            | Rubber Seal<br>ø34    |    | 04  | 57169     | 12 999 212VT | Piston<br>ø65x43     |    |
| 04  | 57172     | 12 999 117VT | Piston<br>ø56x36      |  | 05  | 72967     | -            | Gasket<br>ø65xø73x4  |  |
| 05  | 72975     | -            | Gasket<br>ø55xø62x3,5 |  |     |           |              |                      |   |

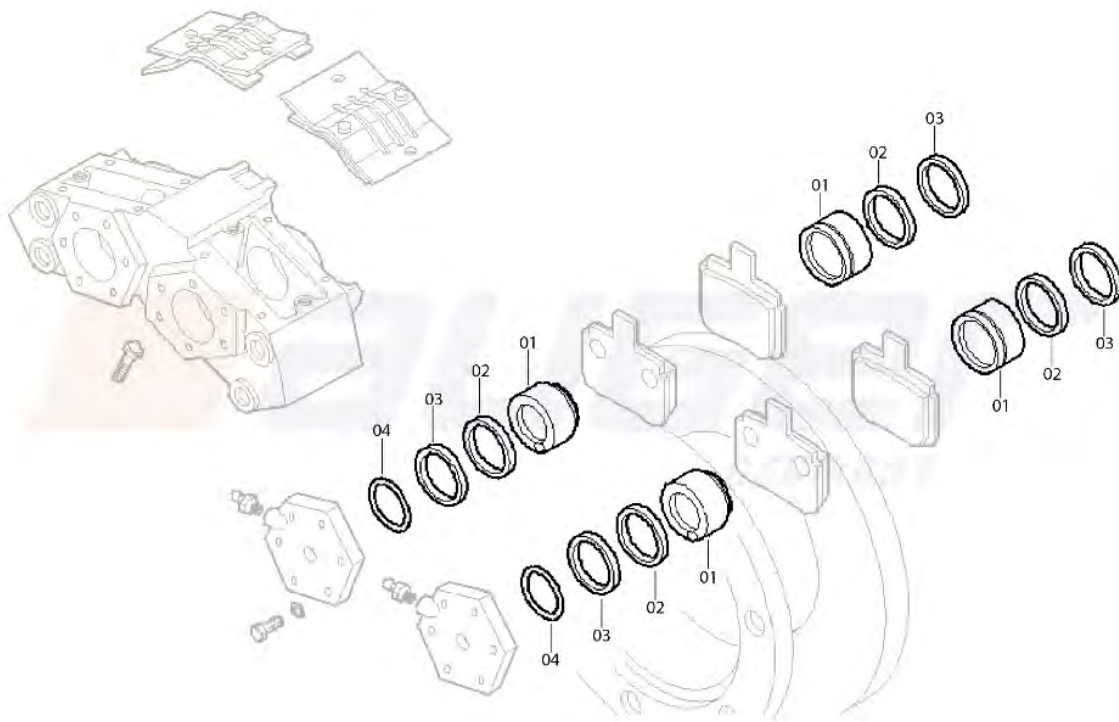

| Auger Nr.    | OEM Nr.      | Description               | Model | Picture   |
|--------------|--------------|---------------------------|-------|---|
| <b>54570</b> | 12 999 141VT | Repair Kit, Brake Caliper |       |  |
| <b>56027</b> | 12 999 116VT | Repair Kit, Brake Caliper |       |  |

| Auger Nr.    | OEM Nr.      | Description                      | Model | Picture   |
|--------------|--------------|----------------------------------|-------|---|
| <b>56105</b> | 12 999 195VT | Repair Kit, Brake Caliper        |       |    |
| <b>57169</b> | 12 999 212VT | Piston, Brake Caliper<br>ø65x43  |       |    |
| <b>57172</b> | 12 999 117VT | Piston, Brake Caliper<br>ø56x36  |       |   |
| <b>71468</b> | 16 200 083   | Valve, Brake Caliper             |       |  |
| <b>55998</b> | 12 627 054   | Pipe, Brake Caliper<br>M10x1/177 |       |  |
| <b>55999</b> | 12 627 055   | Pipe, Brake Caliper<br>M10x1/177 |       |  |

### Spare Parts

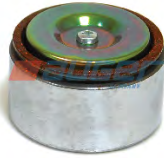

| Sr. | Auger Nr. | O.E.M. Nr.   | Description           | Picture   | Sr. | Auger Nr. | O.E.M. Nr. | Description            | Picture   |
|-----|-----------|--------------|-----------------------|---|-----|-----------|------------|------------------------|---|
| 01  | 57170     | 12 999 162VT | Piston<br>ø85x52      |  | 02  | 55357     | -          | Rubber Seal<br>ø68xø98 |  |
| 03  | 72964     | -            | Gasket<br>ø85xø95x5,5 |  | 04  | 60132     | -          | O-Ring<br>ø3xø90       |  |

| Auger Nr.    | OEM Nr.      | Description                     | Model | Picture   |
|--------------|--------------|---------------------------------|-------|---|
| <b>57170</b> | 12 999 162VT | Piston, Brake Caliper<br>ø85x52 |       |  |
| <b>54563</b> | 12 999 076VT | Repair Kit, Brake Caliper       |       |  |

CALIPER  
MERITOR-ROR  
KNORR  
WABCO

**HALDEX**









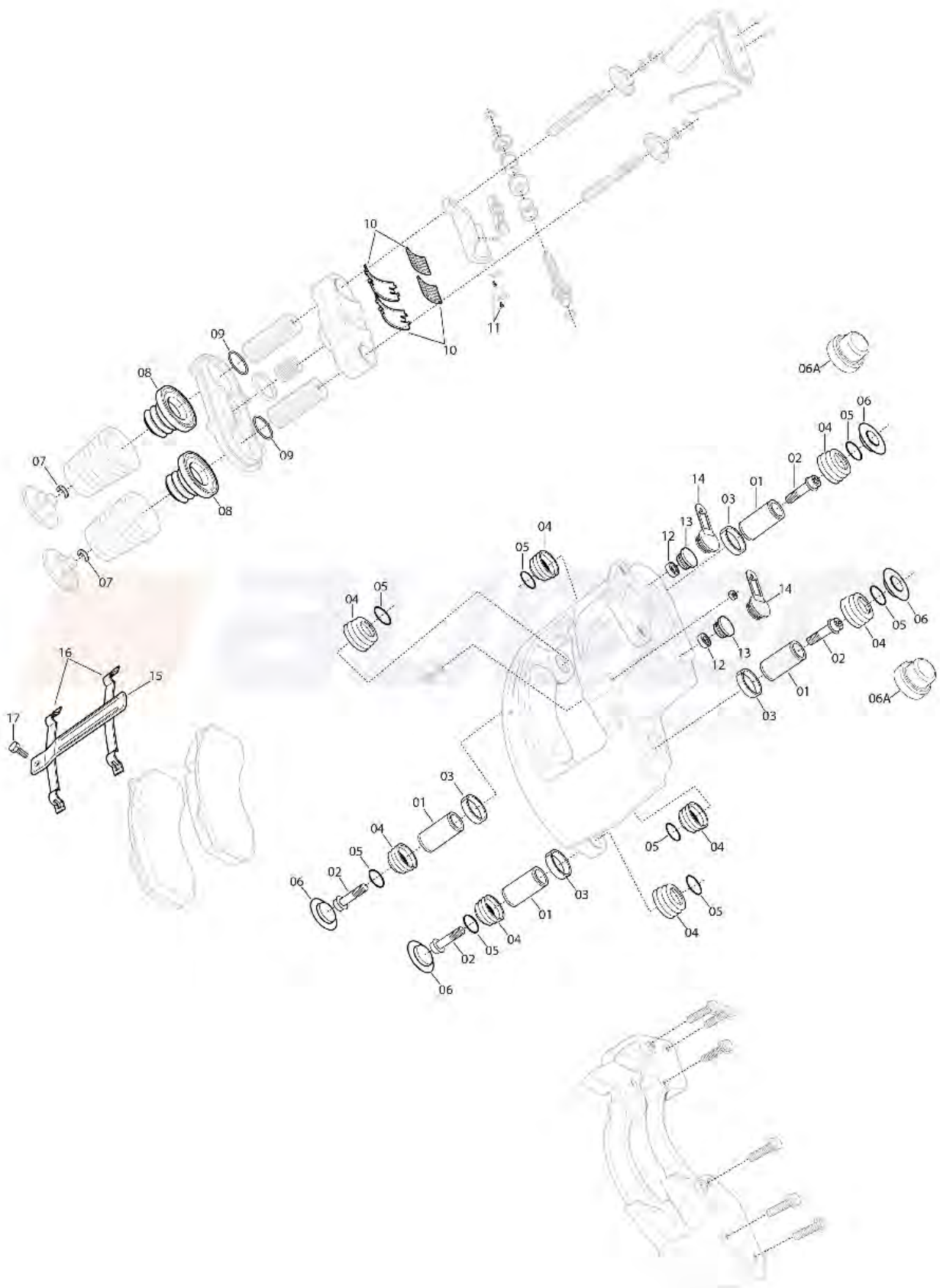

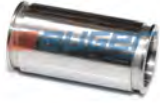







OTHER TYPE CALIPERS  
UNIVERSAL PARTS

we keep your business **on the move**



Spare Parts



| Sr. | Auger Nr. | O.E.M. Nr. | Description                                 | Picture   | Sr. | Auger Nr. | O.E.M. Nr. | Description                                 | Picture   |
|-----|-----------|------------|---|---|-----|-----------|------------|---|---|
| 01  | 72752     | -          | Pin<br>ø15xø35x70                           |    | 01  | 72753     | -          | Pin<br>ø15xø35x69                           |    |
| 02  | 57603     | -          | Hexagon Bolt With Astral Flange<br>M14x2/53 |    | 02  | 57604     | -          | Hexagon Bolt With Astral Flange<br>M14x2/60 |    |
| 03  | 72693     | -          | Plastic Bushing<br>ø31xø39x15               |    | 04  | 57652     | 81938      | Rubber Seal<br>ø31/ø38                      |    |
| 05  | 72913     | -          | Cover<br>ø35,8xø39                          |    | 06  | 72911     | -          | Cover<br>ø21xø28/ø56                        |    |
| 06  | 72912     | -          | Cover<br>ø26xø28/ø56                        |  | 06A | 60506     | 89927      | Cover<br>ø57x40                             |  |
| 07  | 73082     | -          | Clips                                       |  | 08  | 57650     | 81936      | Rubber Seal<br>ø40                          |  |
| 09  | 72988     | -          | O-Ring<br>ø3xø26                            |  | 10  | 57599     | -          | Needle Bearing<br>ø64xø77x32                |  |
| 11  | 72778     | -          | Hexagon Bolt With Flange<br>M6x1/10         |  | 12  | 72951     | -          | Seal Ring<br>ø8xø16x9                       |  |
| 13  | 60571     | 87871      | Plug<br>ø30                                 |  | 14  | 60364     | 81788      | Plug<br>ø24                                 |  |
| 15  | 72933     | -          | Retaining Plate                             |  | 16  | 60487     | 91818      | Spring Holder                               |  |



| Sr. | Auger Nr. | O.E.M. Nr. | Description                                | Picture   |
|-----|-----------|------------|--|---|
| 17  | 72787     | -          | Hexagon Bolt With Flange<br><br>M10x1.5/25 |  |

| Sr. | Auger Nr. | O.E.M. Nr. | Description | Picture |
|-----|-----------|------------|-------------|---------|
|     | 60588     | 89652      | Lubricant   |         |

| Auger Nr. | OEM Nr. | Description | Model | Picture |
|-----------|---------|-------------|-------|---------|
|-----------|---------|-------------|-------|---------|

**56097**      89541      Repair Kit, Brake Caliper







**56100**      87406      Repair Kit, Brake Caliper











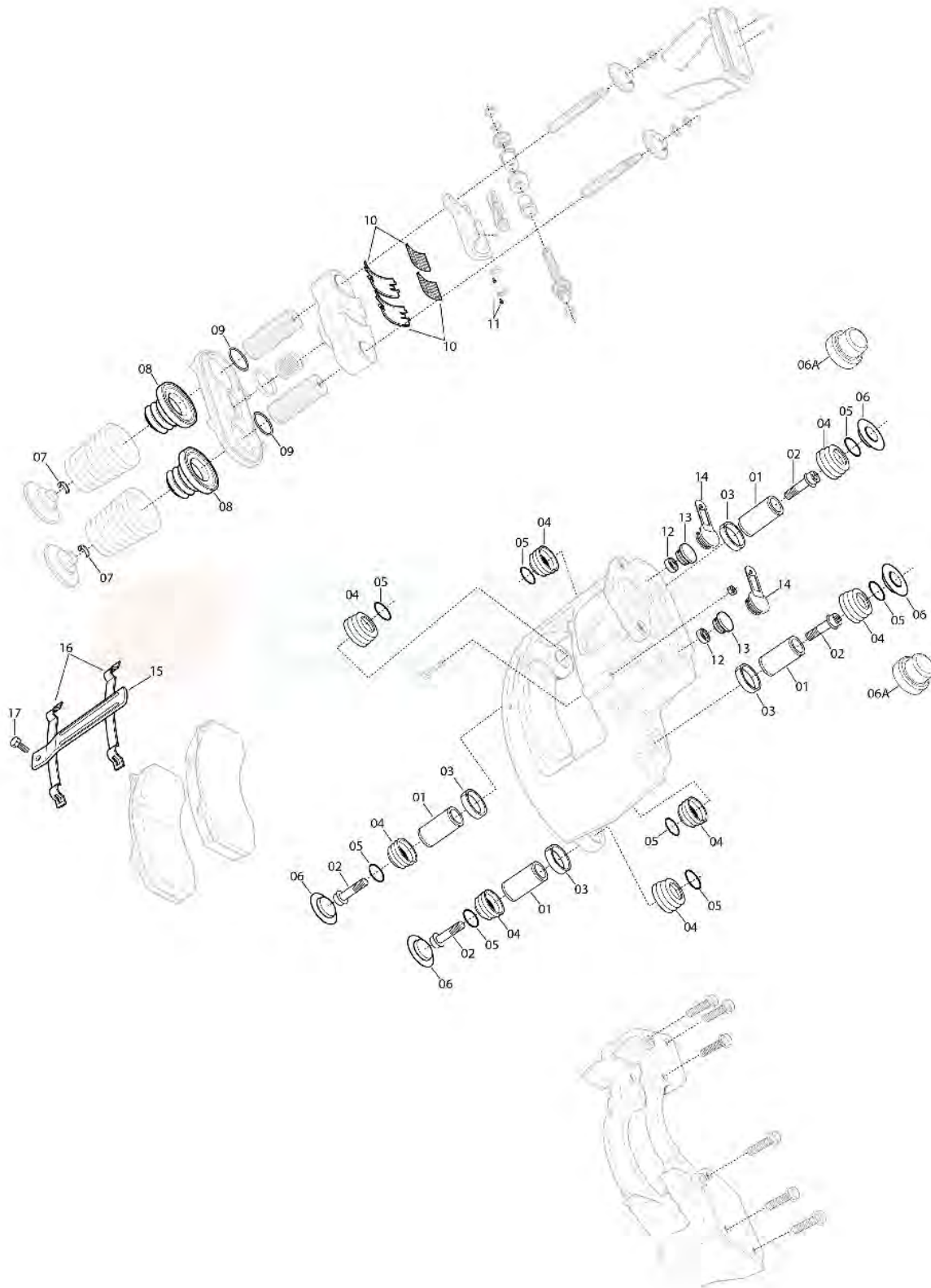











**56095**      94661      Repair Kit, Brake Caliper



| Auger Nr.    | OEM Nr.        | Description                  | Model | Picture   |
|--------------|----------------|------------------------------|-------|---|
| <b>56090</b> | 94663<br>87405 | Repair Kit, Brake Caliper    |       |    |
| <b>56093</b> | 89925          | Repair Kit, Brake Caliper    |       |    |
| <b>57599</b> | -              | Needle Bearing<br>ø64xø77x32 |       |   |
| <b>56150</b> | 94659          | Repair Kit, Brake Caliper    |       |  |

Spare Parts



| Sr. | Auger Nr. | O.E.M. Nr. | Description                                 | Picture   | Sr. | Auger Nr. | O.E.M. Nr. | Description                                 | Picture   |
|-----|-----------|------------|---|---|-----|-----------|------------|---|---|
| 01  | 72752     | -          | Pin<br>ø15xø35x70                           |    | 01  | 72753     | -          | Pin<br>ø15xø35x69                           |    |
| 02  | 57603     | -          | Hexagon Bolt With Astral Flange<br>M14x2/53 |    | 02  | 57604     | -          | Hexagon Bolt With Astral Flange<br>M14x2/60 |    |
| 03  | 72693     | -          | Plastic Bushing<br>ø31xø39x15               |    | 04  | 57652     | 81938      | Rubber Seal<br>ø31/ø38                      |    |
| 05  | 72913     | -          | Cover<br>ø35,8xø39                          |    | 06  | 72911     | -          | Cover<br>ø21xø28/ø56                        |    |
| 06  | 72912     | -          | Cover<br>ø26xø28/ø56                        |  | 06A | 60506     | 89927      | Cover<br>ø57x40                             |  |
| 07  | 73082     | -          | Clips                                       |  | 08  | 57650     | 81936      | Rubber Seal<br>ø40                          |  |
| 09  | 72988     | -          | O-Ring<br>ø3xø26                            |  | 10  | 57599     | -          | Needle Bearing<br>ø64xø77x32                |  |
| 11  | 72778     | -          | Hexagon Bolt With Flange<br>M6x1/10         |  | 12  | 72951     | -          | Seal Ring<br>ø8xø16x9                       |  |
| 13  | 60571     | 87871      | Plug<br>ø30                                 |  | 14  | 60364     | 81788      | Plug<br>ø24                                 |  |
| 15  | 72933     | -          | Retaining Plate                             |  | 16  | 60487     | 91818      | Spring Holder                               |  |

| Sr. | Auger Nr. | O.E.M. Nr. | Description                                | Picture   |
|-----|-----------|------------|--|---|
| 17  | 72787     | -          | Hexagon Bolt With Flange<br><br>M10x1.5/25 |  |

| Sr. | Auger Nr. | O.E.M. Nr. | Description | Picture |
|-----|-----------|------------|-------------|---------|
|     | 60588     | 89652      | Lubricant   |         |

| Auger Nr. | OEM Nr. | Description | Model | Picture |
|-----------|---------|-------------|-------|---------|
|-----------|---------|-------------|-------|---------|

**56097**      89541      Repair Kit, Brake Caliper







**56100**      87406      Repair Kit, Brake Caliper



**56095**      94661      Repair Kit, Brake Caliper







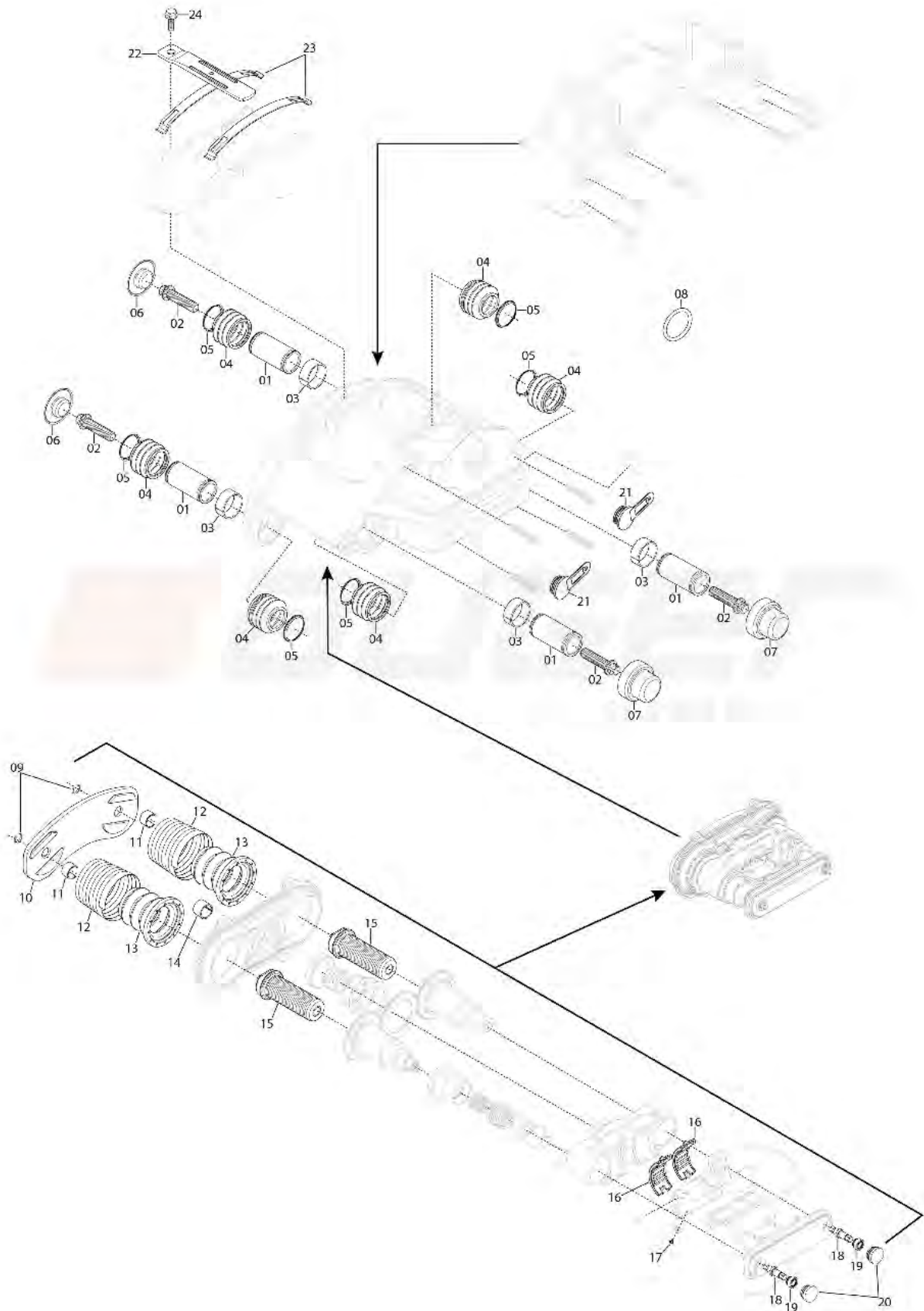























| Auger Nr.    | OEM Nr.        | Description                  | Model | Picture   |
|--------------|----------------|------------------------------|-------|---|
| <b>56090</b> | 94663<br>87405 | Repair Kit, Brake Caliper    |       |    |
| <b>56093</b> | 89925          | Repair Kit, Brake Caliper    |       |    |
| <b>57599</b> | -              | Needle Bearing<br>ø64xø77x32 |       |   |
| <b>56150</b> | 94659          | Repair Kit, Brake Caliper    |       |  |







**Spare Parts**







| Sr. | Auger Nr. | O.E.M. Nr. | Description                                    | Picture   | Sr. | Auger Nr. | O.E.M. Nr. | Description                                    | Picture   |
|-----|-----------|------------|--|---|-----|-----------|------------|--|---|
| 01  | 72752     | -          | Pin<br>ø15xø35x70                              |    | 01  | 72753     | -          | Pin<br>ø15xø35x69                              |    |
| 02  | 57603     | -          | Hexagon Bolt With<br>Astral Flange<br>M14x2/53 |    | 02  | 57604     | -          | Hexagon Bolt With<br>Astral Flange<br>M14x2/60 |    |
| 03  | 72693     | -          | Plastic Bushing<br>ø31xø39x15                  |    | 04  | 57652     | 81938      | Rubber Seal<br>ø31/ø38                         |    |
| 05  | 72913     | -          | Cover<br>ø35,8xø39                             |    | 06  | 72911     | -          | Cover<br>ø21xø28/ø56                           |    |
| 06  | 72912     | -          | Cover<br>ø26xø28/ø56                           |  | 07  | 60506     | 89927      | Cover<br>ø57x40                                |  |
| 08  | 72988     | -          | O-Ring<br>ø3xø26                               |  | 09  | 72842     | -          | Retaining Ring                                 |  |
| 10  | 72914     | -          | Thrust Plate<br>ø12x130/6                      |  | 10  | 72915     | -          | Thrust Plate<br>ø12x130/10                     |  |
| 11  | 72910     | -          | Clips<br>ø11,5xø13/8                           |  | 12  | 73042     | -          | Protection Spring                              |  |
| 13  | 57651     | 89619      | Rubber Seal<br>ø36                             |  | 14  | 73019     | -          | Bushing<br>ø12xø14x10                          |  |
| 15  | 72768     | -          | Adjuster Bolt<br>M30x2/98                      |  | 16  | 57599     | -          | Needle Bearing<br>ø64xø77x32                   |  |

| Sr.   | Auger Nr. | O.E.M. Nr. | Description                         | Picture   | Sr. | Auger Nr. | O.E.M. Nr. | Description                            | Picture   |
|-------|-----------|------------|-------------------------------------|---|-----|-----------|------------|--|---|
| 17    | 72778     | -          | Hexagon Bolt With Flange<br>M6x1/10 |  | 18  | 73083     | -          | Adjusting Shaft<br>ø13x41              |  |
| 19    | 72951     | -          | Seal Ring<br>ø8xø16x9               |  | 20  | 60571     | 87871      | Plug<br>ø30                            |  |
| 21    | 60364     | 81788      | Plug<br>ø24                         |  | 22  | 72933     | -          | Retaining Plate                        |  |
| 23    | 60487     | 91818      | Spring Holder                       |  | 24  | 72787     | -          | Hexagon Bolt With Flange<br>M10x1.5/25 |  |
| 60588 | 89652     |            | Lubricant                           |   |     |           |            |  |   |

| Auger Nr.    | OEM Nr.        | Description               | Model | Picture   |
|--------------|----------------|---------------------------|-------|---|
| <b>56100</b> | 87406          | Repair Kit, Brake Caliper |       |    |
| <b>56097</b> | 89541          | Repair Kit, Brake Caliper |       |    |
| <b>56095</b> | 94661          | Repair Kit, Brake Caliper |       |   |
| <b>56091</b> | 94662          | Repair Kit, Brake Caliper |       |  |
| <b>70839</b> | 94664<br>93285 | Repair Kit, Brake Caliper |       |  |
| <b>56094</b> | 89794          | Repair Kit, Brake Caliper |       |  |

| Auger Nr.    | OEM Nr. | Description                  | Model | Picture  |
|--------------|---------|------------------------------|-------|--|
| <b>56098</b> | 92731   | Repair Kit, Brake Caliper    |       |   |
| <b>56099</b> | 91236   | Repair Kit, Brake Caliper    |       |   |
| <b>57599</b> | -       | Needle Bearing<br>ø64xø77x32 |       |  |

**06**

# HALDEX MARK IV TYPE CALIPER



| Auger Nr. | OEM Nr. | Description | Model | Picture |
|-----------|---------|-------------|-------|---------|
|-----------|---------|-------------|-------|---------|

**56092**      90693      Repair Kit, Brake Caliper



**56093**      89925      Repair Kit, Brake Caliper









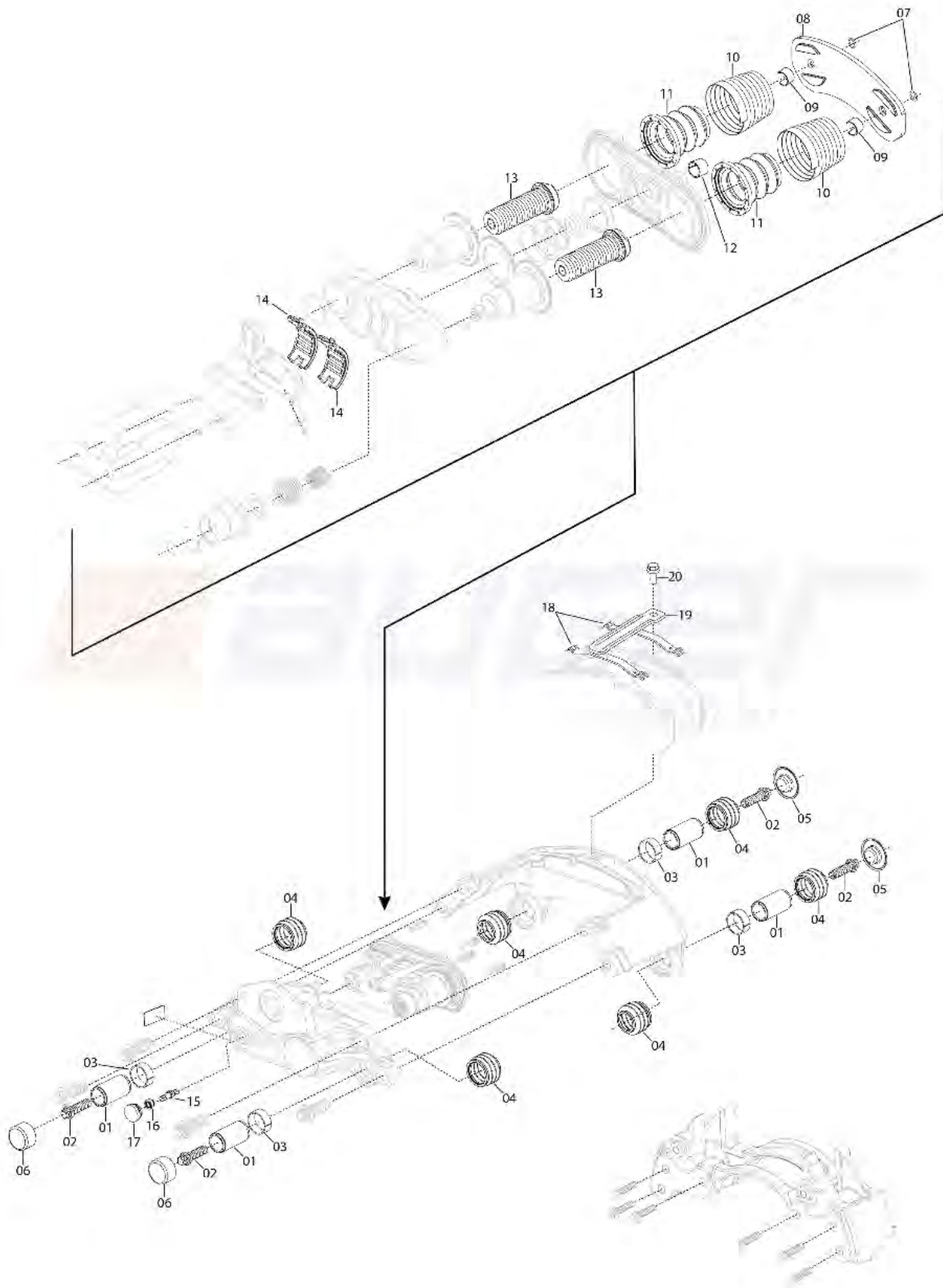













**56150**      94659      Repair Kit, Brake Caliper









Spare Parts



| Sr. | Auger Nr. | O.E.M. Nr. | Description                                 | Picture   | Sr. | Auger Nr. | O.E.M. Nr. | Description                                 | Picture   |
|-----|-----------|------------|---|---|-----|-----------|------------|---|---|
| 01  | 72754     | -          | Pin<br>ø15xø35x64                           |    | 02  | 57605     | -          | Hexagon Bolt With Astral Flange<br>M14x2/42 |    |
| 02  | 57606     | -          | Hexagon Bolt With Astral Flange<br>M14x2/47 |    | 03  | 72693     | -          | Plastic Bushing<br>ø31xø39x15               |    |
| 04  | 57652     | 81938      | Rubber Seal<br>ø31/ø38                      |    | 05  | 72912     | -          | Cover<br>ø26xø28/ø56                        |    |
| 06  | 60507     | 91019      | Cover<br>ø42x23                             |    | 07  | 72842     | -          | Retaining Ring                              |    |
| 08  | 72914     | -          | Thrust Plate<br>ø12x130/6                   |  | 08  | 72915     | -          | Thrust Plate<br>ø12x130/10                  |  |
| 09  | 72910     | -          | Clips<br>ø11,5xø13/8                        |  | 10  | 73042     | -          | Protection Spring                           |  |
| 11  | 57651     | 89619      | Rubber Seal<br>ø36                          |  | 12  | 73019     | -          | Bushing<br>ø12xø14x10                       |  |
| 13  | 72768     | -          | Adjuster Bolt<br>M30x2/98                   |  | 14  | 57599     | -          | Needle Bearing<br>ø64xø77x32                |  |
| 15  | 73083     | -          | Adjusting Shaft<br>ø13x41                   |  | 16  | 72951     | -          | Seal Ring<br>ø8xø16x9                       |  |
| 17  | 60571     | 87871      | Plug<br>ø30                                 |  | 18  | 72933     | -          | Retaining Plate                             |  |



| Sr.   | Auger Nr. | O.E.M. Nr. | Description   | Picture   | Sr. | Auger Nr. | O.E.M. Nr. | Description                            | Picture   |
|-------|-----------|------------|---------------|---|-----|-----------|------------|--|---|
| 19    | 60487     | 91818      | Spring Holder |  | 20  | 72787     | -          | Hexagon Bolt With Flange<br>M10x1.5/25 |  |
| 60588 | 89652     | Lubricant  |               |   |     |           |            |  |   |

| Auger Nr.    | OEM Nr.        | Description               | Model | Picture   |
|--------------|----------------|---------------------------|-------|---|
| <b>56101</b> | 91012          | Repair Kit, Brake Caliper |       |   |
| <b>71446</b> | 93299          | Repair Kit, Brake Caliper |       |  |
| <b>56096</b> | 94660          | Repair Kit, Brake Caliper |       |  |
| <b>56091</b> | 94662          | Repair Kit, Brake Caliper |       |  |
| <b>70839</b> | 94664<br>93285 | Repair Kit, Brake Caliper |       |  |

| Auger Nr.    | OEM Nr. | Description                  | Model | Picture   |
|--------------|---------|------------------------------|-------|---|
| <b>56094</b> | 89794   | Repair Kit, Brake Caliper    |       |    |
| <b>56098</b> | 92731   | Repair Kit, Brake Caliper    |       |    |
| <b>56099</b> | 91236   | Repair Kit, Brake Caliper    |       |    |
| <b>57599</b> | -       | Needle Bearing<br>ø64xø77x32 |       |  |
| <b>56092</b> | 90693   | Repair Kit, Brake Caliper    |       |  |
| <b>56093</b> | 89925   | Repair Kit, Brake Caliper    |       |  |
| <b>56150</b> | 94659   | Repair Kit, Brake Caliper    |       |  |

CALIPER  
MERITOR-ROR

KNORR

WABCO

HALDEX

**OTHER TYPE  
CALIPERS**

UNIVERSAL PARTS

**Spare Parts**

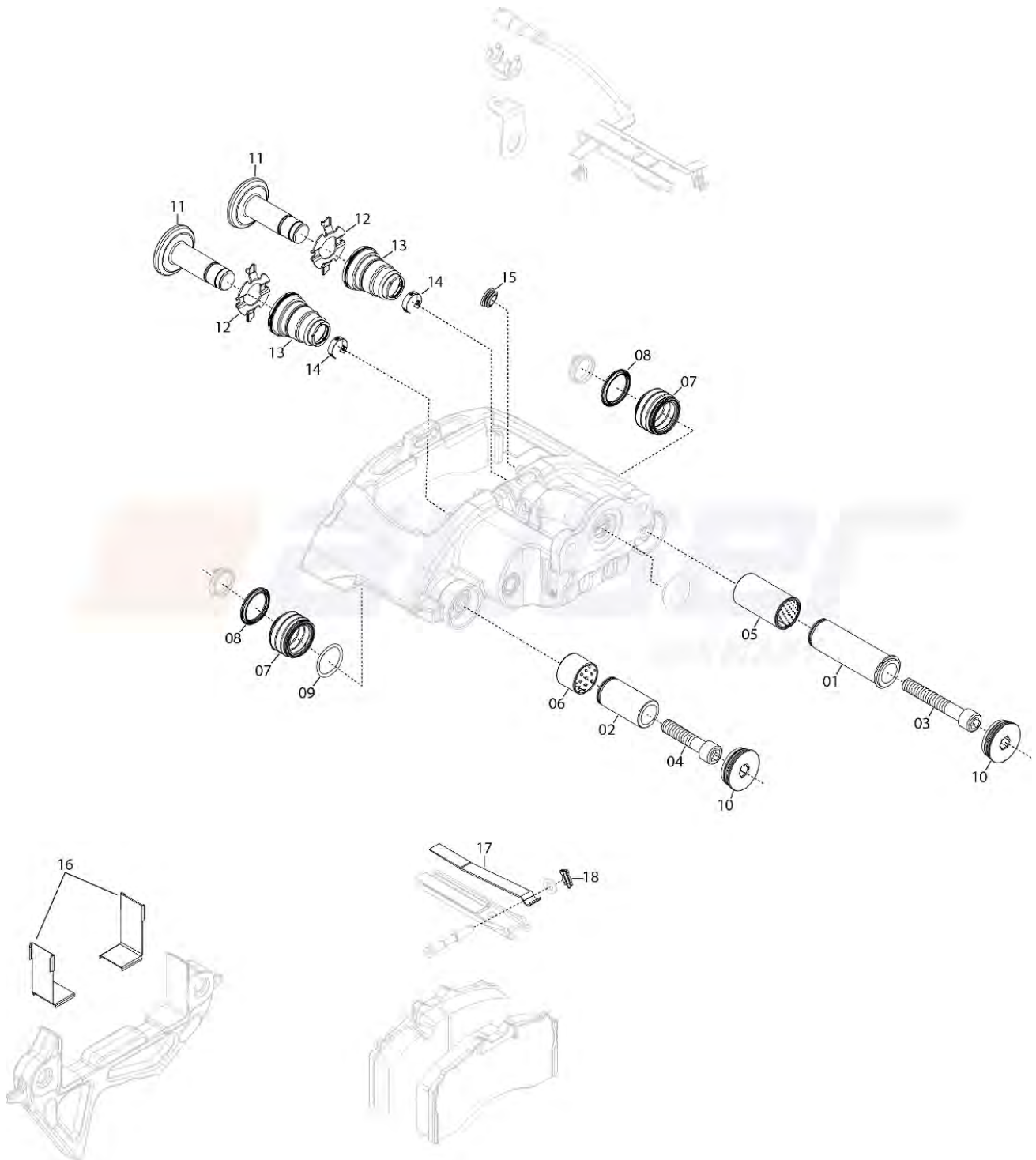

| Sr.   | Auger Nr.     | O.E.M. Nr.     | Description                     | Picture   | Sr. | Auger Nr. | O.E.M. Nr.     | Description                    | Picture   |
|-------|---------------|----------------|---------------------------------|---|-----|-----------|----------------|--------------------------------|---|
| 01    | 73176         | 05.001.00.41.0 | Pin+Circlip Assembly<br>ø37x123 |    | 02  | 72763     | 03.001.00.35.0 | Pin<br>ø36,3x70                |    |
| 03    | 72789         | 02.5016.70.16  | Socket Head Bolt<br>M16x1,5/100 |    | 04  | 55312     | 02.5015.78.16  | Socket Head Bolt<br>M16x1,5/70 |    |
| 05    | 73023         | 03.112.33.13.0 | Bushing<br>ø37xø41x73           |    | 06  | 73024     | 03.112.33.14.0 | Bushing<br>ø37xø41x30          |    |
| 07    | 73196         | 05.130.08.27.0 | Rubber Seal<br>ø31xø48,5        |    | 08  | 72691     | 03.310.11.19.0 | Ring<br>ø37xø48x5,4            |    |
| 09    | 72990         | 02.5679.98.40  | O-Ring<br>ø3,55xø36             |  | 10  | 72692     | 05.001.00.45.0 | Plastic Plug<br>M49x1,5/16     |  |
| 11    | 73183         | 03.127.18.02.0 | Tappet<br>ø27xø65x100           |  | 12  | 72941     | 03.121.30.15.0 | Lock Washer                    |  |
| 13    | 73201         | 05.130.07.07.0 | Rubber Seal<br>ø26xø55          |  | 14  | 72942     | 03.001.57.01.0 | Clips                          |  |
| 15    | 73197         | 02.3704.69.00  | Plug<br>ø21,8                   |  | 16  | 72938     | -              | Spring Clamp                   |  |
| 17    | 72939         | -              | Bracket                         |  | 18  | 72797     | -              | Split pin                      |  |
| 60586 | 02.1040.60.00 |                | Lubricant                       |   |     |           |                |                                |   |

| Auger Nr.    | OEM Nr.        | Description               | Model | Picture |
|--------------|----------------|---------------------------|-------|---------|
| <b>70657</b> | 09.801.07.61.0 | Repair Kit, Brake Caliper |       |         |
| <b>70656</b> | 09.801.07.62.0 | Repair Kit, Brake Caliper |       |         |
| <b>70658</b> | 09.801.07.63.0 | Repair Kit, Brake Caliper |       |         |
| <b>70659</b> | 05.006.03.45.1 | Repair Kit, Brake Caliper |       |         |



## Spare Parts

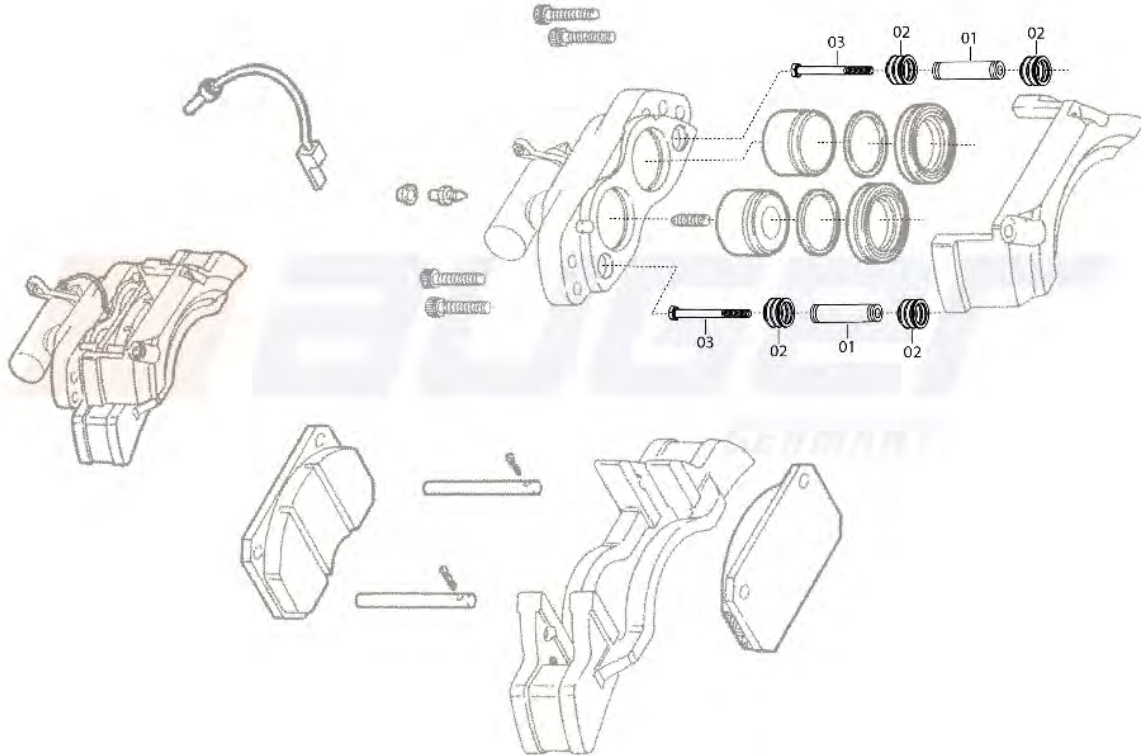

| Sr. | Auger Nr. | O.E.M. Nr. | Description                          | Picture   | Sr.   | Auger Nr. | O.E.M. Nr. | Description                | Picture   |
|-----|-----------|------------|--------------------------------------|---|-------|-----------|------------|----------------------------|---|
| 01  | 72767     | -          | Pin<br>ø12,5xø22x90                  |  | 02    | 73200     | -          | Rubber Seal<br>ø14,5/ø21,5 |  |
| 03  | 72792     | -          | Hexagon Head Screw<br>M12x1,75 / 110 |  | 60574 | -         | Lubricant  |                            |   |

| Auger Nr.    | OEM Nr.  | Description               | Model | Picture |
|--------------|----------|---------------------------|-------|---------|
| <b>71480</b> | 93161759 | Repair Kit, Brake Caliper |       |         |





Spare Parts

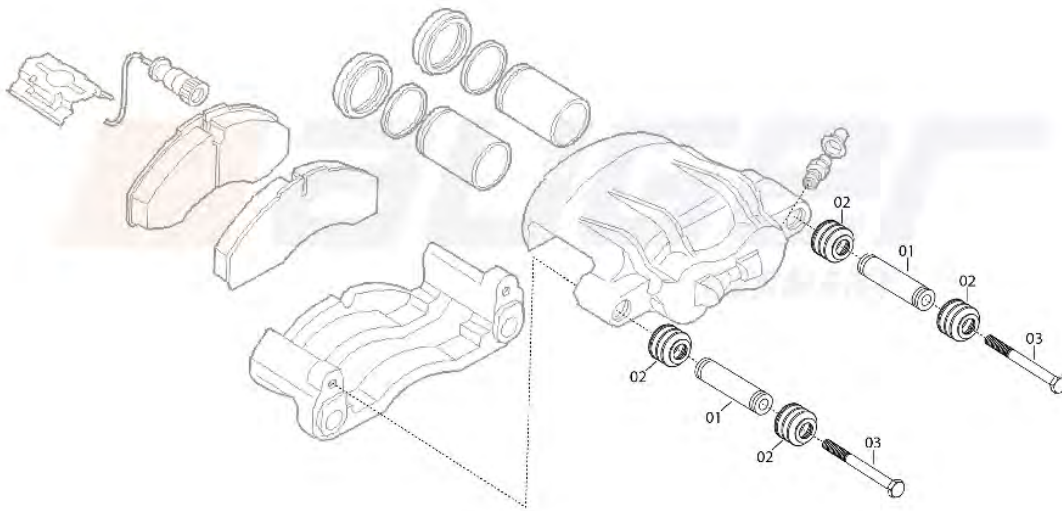

| Sr. | Auger Nr. | O.E.M. Nr. | Description                        | Picture |
|-----|-----------|------------|------------------------------------|---------|
| 01  | 72766     | -          | Pin<br>ø10,5/ø17,5                 |         |
| 03  | 72791     | -          | Hexagon Head Screw<br>M8x1,25 / 90 |         |

| Sr. | Auger Nr. | O.E.M. Nr. | Description                | Picture |
|-----|-----------|------------|----------------------------|---------|
| 02  | 73199     | -          | Rubber Seal<br>ø14,5/ø21,5 |         |
|     | 60574     | -          | Lubricant                  |         |

| Auger Nr.    | OEM Nr.  | Description               | Model | Picture |
|--------------|----------|---------------------------|-------|---------|
| <b>71479</b> | 93161849 | Repair Kit, Brake Caliper |       |         |



## Spare Parts

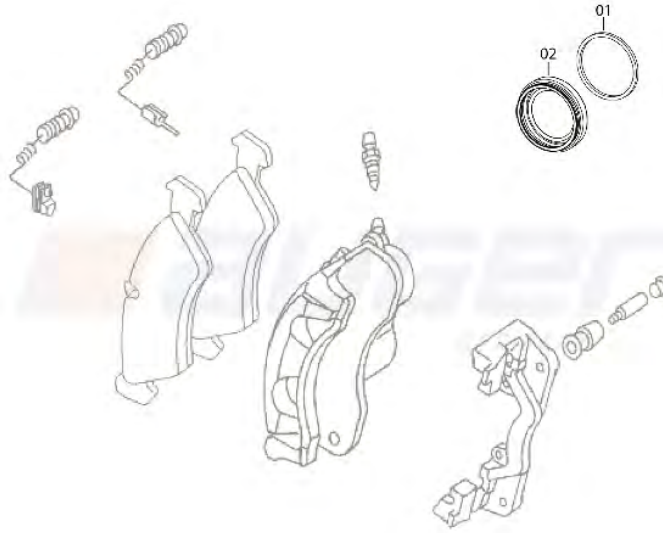

| Sr. | Auger Nr. | O.E.M. Nr. | Description            | Picture   |
|-----|-----------|------------|------------------------|---|
| 01  | 73202     | -          | Rubber Seal<br>ø37/ø47 |  |







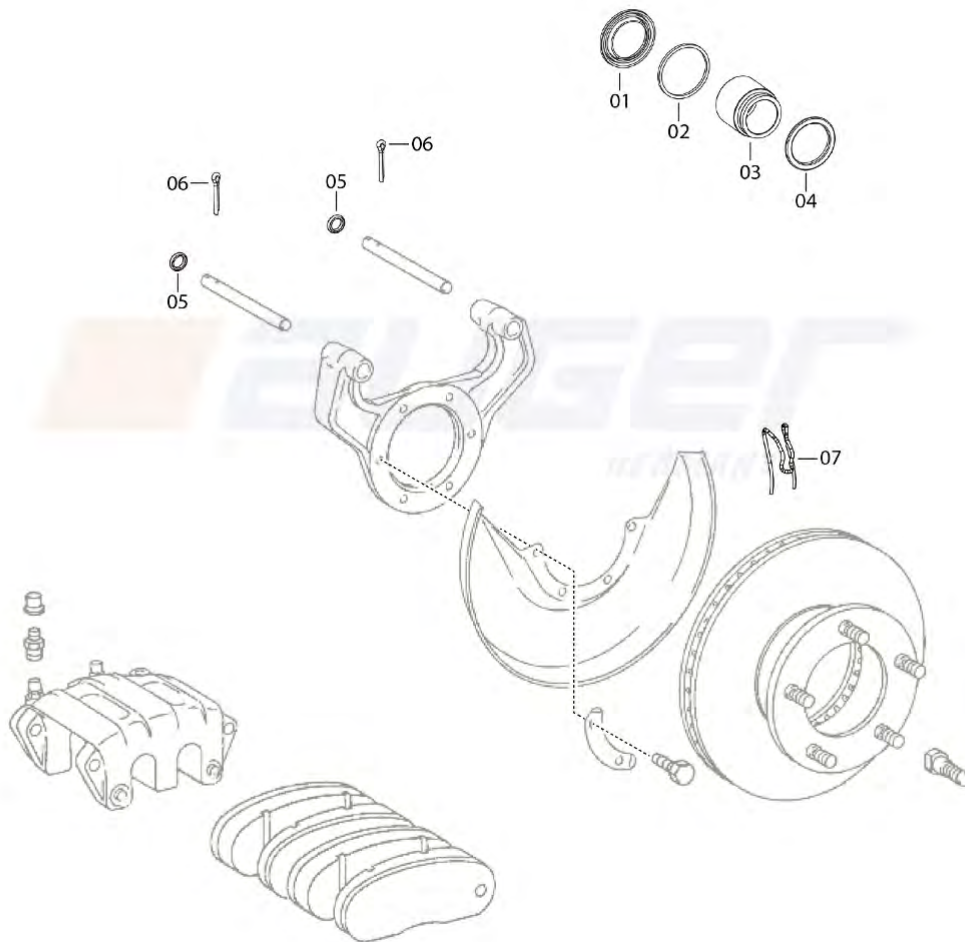

| Sr. | Auger Nr. | O.E.M. Nr. | Description         | Picture   |
|-----|-----------|------------|---------------------|---|
| 02  | 72982     | -          | Gasket<br>ø48xø54x3 |  |



| Auger Nr.    | OEM Nr.  | Description               | Model | Picture |
|--------------|----------|---------------------------|-------|---------|
| <b>72137</b> | 42555883 | Repair Kit, Brake Caliper |       |         |



## Spare Parts



| Sr. | Auger Nr. | O.E.M. Nr. | Description                   | Picture   | Sr. | Auger Nr. | O.E.M. Nr. | Description               | Picture   |
|-----|-----------|------------|-------------------------------|---|-----|-----------|------------|---------------------------|---|
| 01  | 57637     | -          | Rubber Seal<br>ø40            |  | 02  | 72970     | -          | Gasket<br>ø52,5xø58,5xø3  |  |
| 03  | 73064     | -          | Piston<br>ø36,6xø52x50        |  | 04  | 72891     | -          | Cover<br>ø44xø57x4,25     |  |
| 04  | 72892     | -          | Cover<br>ø46xø57x4,25         |  | 05  | 72971     | -          | Gasket<br>ø9,5xø13,8xø2,8 |  |
| 06  | 72795     | -          | Split pin<br>EN ISO 1234-5x32 |  | 07  | 73028     | -          | Split pin                 |  |

| Auger Nr.    | OEM Nr.       | Description               | Model | Picture   |
|--------------|---------------|---------------------------|-------|---|
| <b>55811</b> | 631 420 00 44 | Repair Kit, Brake Caliper |       |  |
| <b>55812</b> | 631 420 00 51 | Repair Kit, Brake Caliper |       |  |

Spare Parts

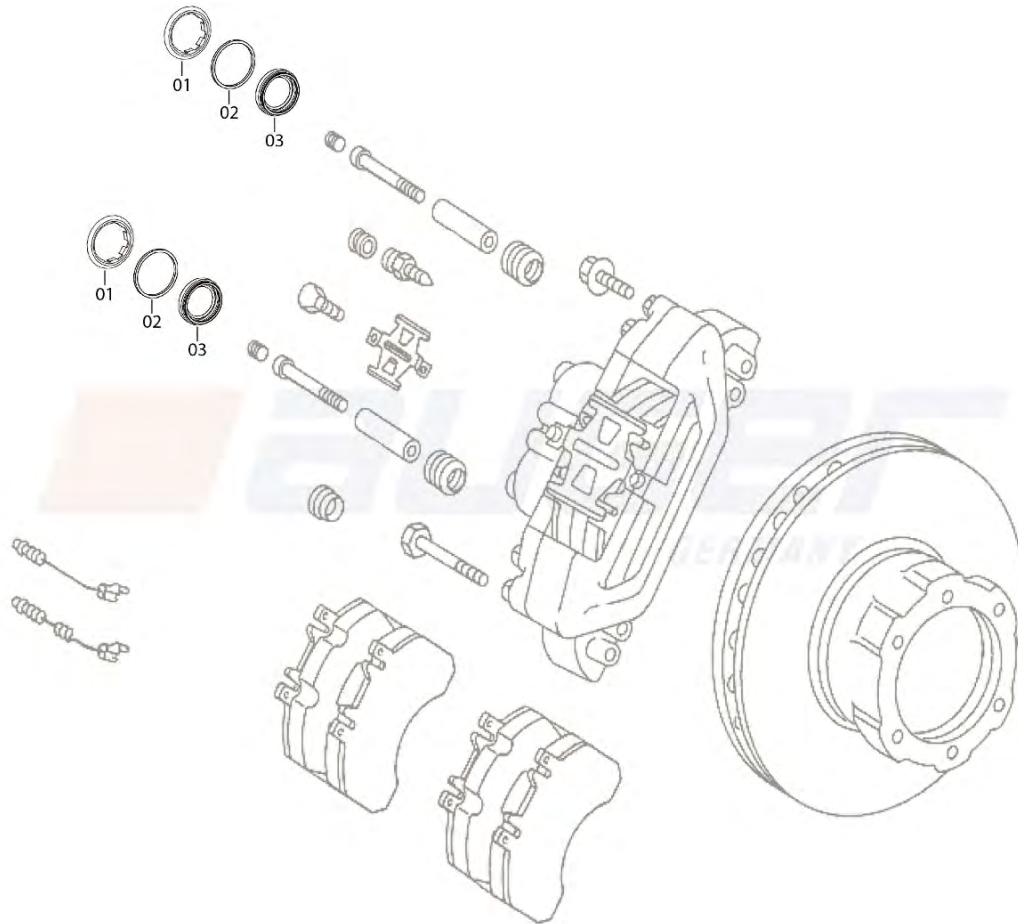

| Sr. | Auger Nr. | O.E.M. Nr. | Description             | Picture | Sr. | Auger Nr. | O.E.M. Nr. | Description           | Picture |
|-----|-----------|------------|-------------------------|---------|-----|-----------|------------|-----------------------|---------|
| 01  | 57649     | -          | Seal Ring<br>ø50/ø63,5  |         | 02  | 72972     | -          | Gasket<br>ø61,5xø67x3 |         |
| 03  | 72909     | -          | Cover<br>ø54,5xø76,5x11 |         |     |           |            |                       |         |

| Auger Nr.    | OEM Nr.       | Description               | Model | Picture |
|--------------|---------------|---------------------------|-------|---------|
| <b>56089</b> | 000 420 14 44 | Repair Kit, Brake Caliper |       |         |



### Spare Parts

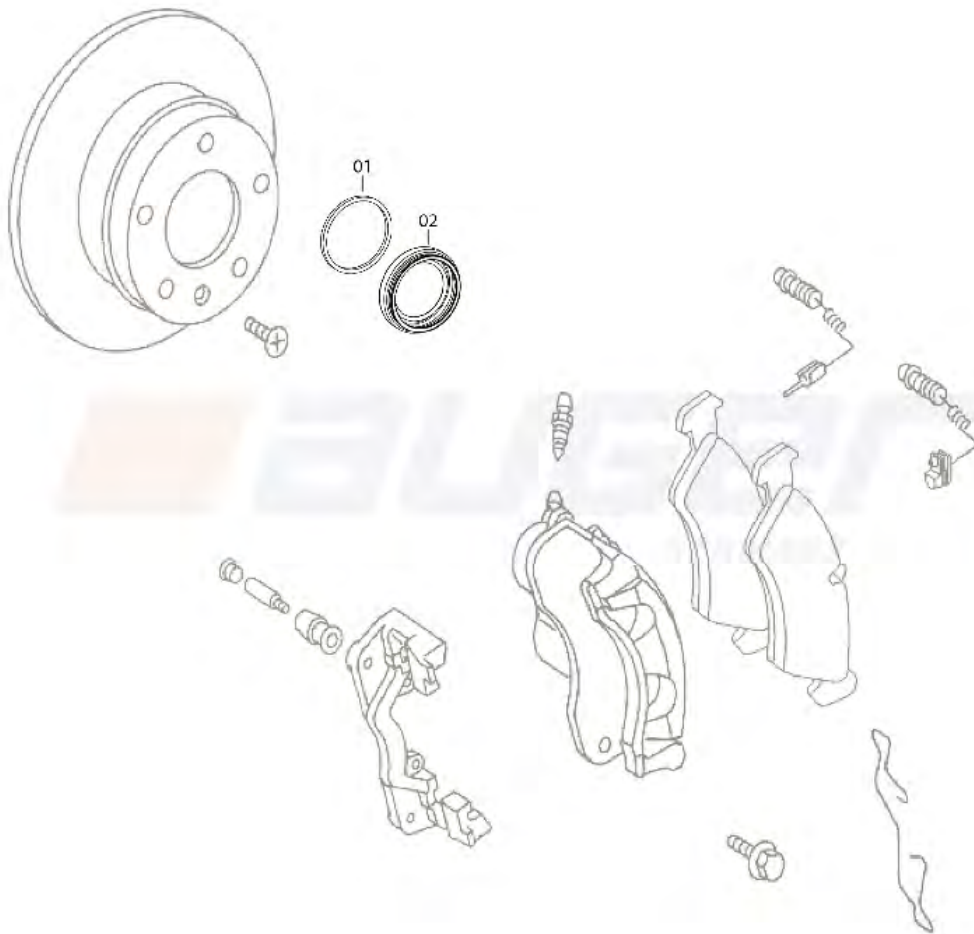

| Sr. | Auger Nr. | O.E.M. Nr. | Description         | Picture | Sr. | Auger Nr. | O.E.M. Nr. | Description              | Picture |
|-----|-----------|------------|---------------------|---------|-----|-----------|------------|--------------------------|---------|
| 01  | 72969     | -          | Gasket<br>ø46xø52x3 |         | 02  | 57639     | -          | Seal Ring<br>ø34,5/ø44,5 |         |

| Auger Nr.    | OEM Nr.       | Description               | Model | Picture |
|--------------|---------------|---------------------------|-------|---------|
| <b>55815</b> | 001 420 24 83 | Repair Kit, Brake Caliper |       |         |



Spare Parts

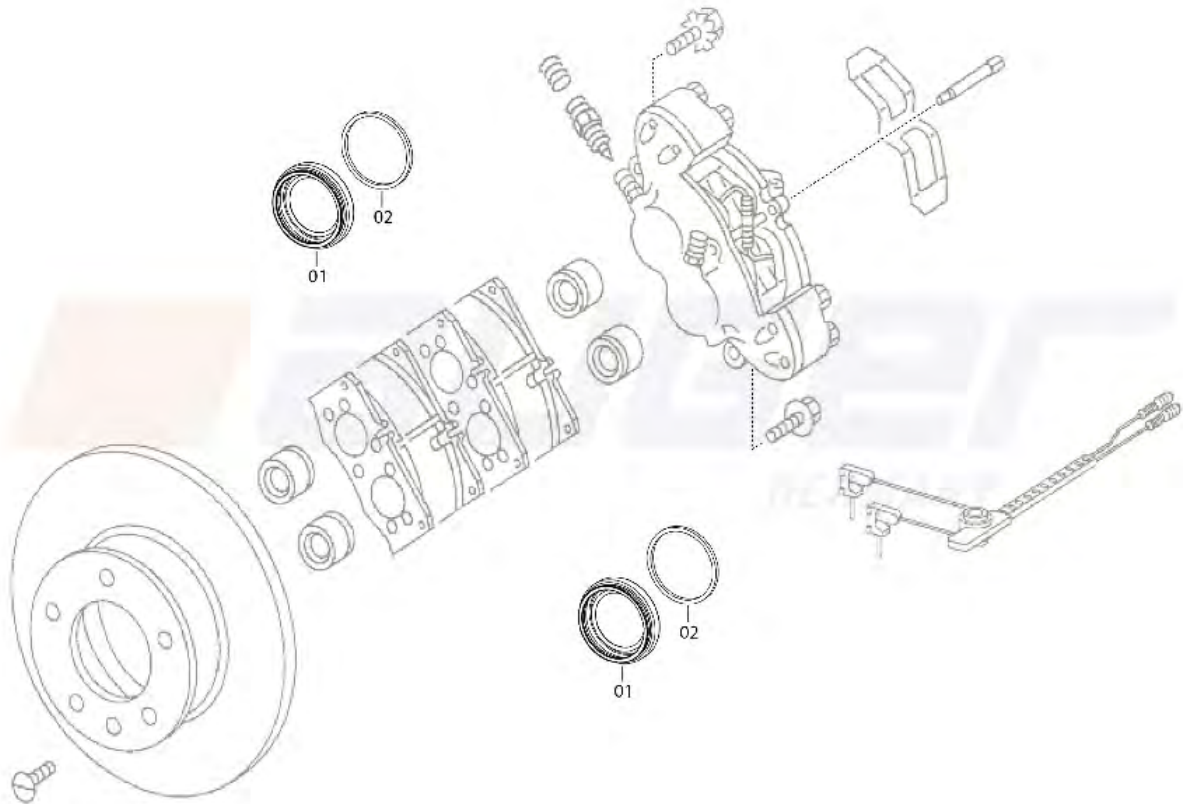

| Sr. | Auger Nr. | O.E.M. Nr. | Description          | Picture |
|-----|-----------|------------|----------------------|---------|
| 01  | 57635     | -          | Seal Ring<br>ø35xø58 |         |

| Sr. | Auger Nr. | O.E.M. Nr. | Description         | Picture |
|-----|-----------|------------|---------------------|---------|
| 02  | 72969     | -          | Gasket<br>ø46xø52x3 |         |

| Auger Nr.    | OEM Nr.       | Description               | Model | Picture |
|--------------|---------------|---------------------------|-------|---------|
| <b>55809</b> | 002 586 53 42 | Repair Kit, Brake Caliper |       |         |





### Spare Parts

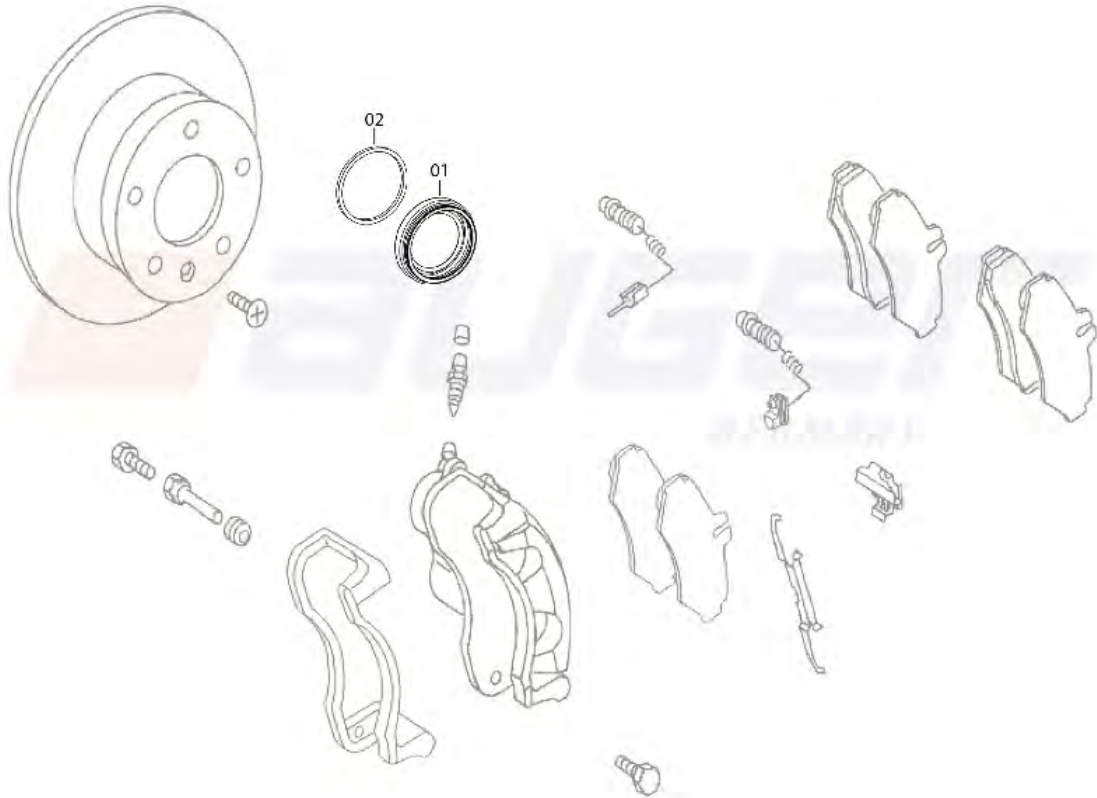

| Sr. | Auger Nr. | O.E.M. Nr. | Description          | Picture |
|-----|-----------|------------|----------------------|---------|
| 01  | 57636     | -          | Seal Ring<br>ø41/ø52 |         |

| Sr. | Auger Nr. | O.E.M. Nr. | Description              | Picture |
|-----|-----------|------------|--------------------------|---------|
| 02  | 72970     | -          | Gasket<br>ø52,5xø58,5xø3 |         |

| Auger Nr.    | OEM Nr.       | Description               | Model | Picture |
|--------------|---------------|---------------------------|-------|---------|
| <b>55810</b> | 001 420 25 83 | Repair Kit, Brake Caliper |       |         |



CALIPER  
MERITOR-ROR  
KNORR  
WABCO  
HALDEX  
OTHER TYPE CALIPERS

# UNIVERSAL PARTS

we keep your business on the move

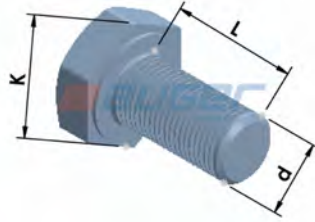
**Screws**

| Type | Auger No. | d        | L   | K  |
|------|-----------|----------|-----|----|
| 1    | 72769     | M10x1,25 | 20  | 17 |
| 1    | 72772     | M12x1,75 | 30  | 19 |
| 1    | 72792     | M12x1,75 | 110 | 19 |
| 1    | 72775     | M16x1,5  | 124 | 24 |
| 1    | 72776     | M22x1,5  | 176 | 32 |
| 1    | 72786     | M6x1     | 12  | 10 |
| 1    | 72790     | M6x1     | 16  | 10 |
| 1    | 72777     | M8x1,25  | 16  | 13 |
| 1    | 72770     | M8x1,25  | 20  | 13 |
| 1    | 72771     | M8x1,25  | 60  | 13 |
| 1    | 72791     | M8x1,25  | 90  | 13 |



| Type | Auger No. | d       | L  | K     |
|------|-----------|---------|----|-------|
| 2    | 55327     | M10x1   | 40 | 10.95 |
| 2    | 55302     | M14x1,5 | 40 | 16.4  |
| 2    | 57570     | M14x1,5 | 90 | 16.4  |
| 2    | 57605     | M14x2   | 42 | 16.4  |
| 2    | 57606     | M14x2   | 47 | 16.4  |
| 2    | 57603     | M14x2   | 53 | 16.4  |
| 2    | 57604     | M14x2   | 60 | 16.4  |
| 2    | 55294     | M16x1,5 | 40 | 18.15 |

## Screws



| Type | Auger No. | d        | L    | K  |
|------|-----------|----------|------|----|
| 3    | 57608     | M10x1    | 40   | 8  |
| 3    | 72780     | M10x1,5  | 20   | 8  |
| 3    | 57612     | M10x1,5  | 25   | 8  |
| 3    | 57571     | M10x1,5  | 50   | 8  |
| 3    | 57610     | M10x1,5  | 60   | 8  |
| 3    | 55319     | M12x1,25 | 85   | 10 |
| 3    | 55320     | M12x1,25 | 85   | 10 |
| 3    | 55321     | M12x1,25 | 95   | 10 |
| 3    | 55313     | M12x1,5  | 90   | 10 |
| 3    | 57575     | M14x1,5  | 70   | 12 |
| 3    | 57611     | M14x2    | 55   | 12 |
| 3    | 55384     | M16x1,5  | 40   | 14 |
| 3    | 55318     | M16x1,5  | 55   | 14 |
| 3    | 55312     | M16x1,5  | 70   | 14 |
| 3    | 55325     | M16x1,5  | 70   | 14 |
| 3    | 55311     | M16x1,5  | 75   | 14 |
| 3    | 55299     | M16x1,5  | 80   | 14 |
| 3    | 72779     | M16x1,5  | 80   | 14 |
| 3    | 55307     | M16x1,5  | 80   | 14 |
| 3    | 72782     | M16x1,5  | 80   | 14 |
| 3    | 57607     | M16x1,5  | 85   | 14 |
| 3    | 55306     | M16x1,5  | 86.5 | 14 |
| 3    | 55326     | M16x1,5  | 90   | 14 |
| 3    | 72789     | M16x1,5  | 100  | 14 |
| 3    | 72788     | M16x1,5  | 105  | 14 |
| 3    | 55328     | M16x1,5  | 110  | 14 |
| 3    | 55323     | M16x1,5  | 120  | 14 |
| 3    | 55309     | M16x1,5  | 125  | 14 |
| 3    | 55322     | M16x1,5  | 130  | 14 |
| 3    | 55310     | M16x1,5  | 140  | 14 |

**Screws**

| Type | Auger No. | d       | L     | K    |
|------|-----------|---------|-------|------|
| 3    | 55308     | M16x1,5 | 150   | 14   |
| 3    | 55303     | M18x1,5 | 81.5  | 17.8 |
| 3    | 55295     | M18x1,5 | 90    | 14   |
| 3    | 55297     | M18x1,5 | 95    | 14   |
| 3    | 55298     | M18x1,5 | 120   | 14   |
| 3    | 55304     | M18x1,5 | 120   | 17.8 |
| 3    | 55317     | M18x1,5 | 135   | 14   |
| 3    | 55296     | M18x1,5 | 150   | 14   |
| 3    | 57572     | M18x2,5 | 55    | 14   |
| 3    | 57573     | M18x2,5 | 90    | 14   |
| 3    | 55300     | M20x1,5 | 90    | 17   |
| 3    | 55305     | M20x1,5 | 100   | 17   |
| 3    | 55301     | M20x1,5 | 150   | 17   |
| 3    | 55315     | M20x2   | 83    | 17   |
| 3    | 55316     | M20x2   | 123.5 | 17   |
| 3    | 55314     | M6x1    | 20    | 5    |
| 3    | 55330     | M8x1,25 | 16    | 5    |
| 3    | 57602     | M8x1,25 | 20    | 6    |
| 3    | 55329     | M8x1,25 | 40    | 5    |
| 3    | 57609     | M8x1,25 | 45    | 6    |
| 3    | 72793     | M8x1,25 | 45    | 6    |

### Pins

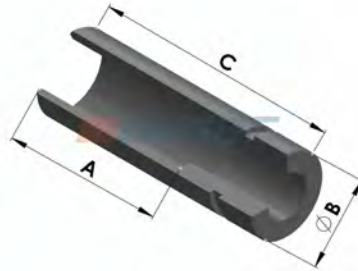

| Type | Auger No. | A       | $\varnothing B$    | C   |
|------|-----------|---------|--------------------|-----|
| 1    | 72721     | 12 mm   | $\varnothing 24,5$ | 81  |
| 1    | 72746     | 24 mm   | $\varnothing 28$   | 96  |
| 1    | 72747     | 44 mm   | $\varnothing 28$   | 96  |
| 1    | 72715     | -       | $\varnothing 32$   | 73  |
| 1    | 72727     | 17,5 mm | $\varnothing 32$   | 90  |
| 1    | 72697     | 62 mm   | $\varnothing 32$   | 97  |
| 1    | 72698     | 37 mm   | $\varnothing 32$   | 97  |
| 1    | 72716     | 18,5 mm | $\varnothing 32$   | 117 |
| 1    | 72726     | 18,5 mm | $\varnothing 33$   | 117 |
| 1    | 72742     | 35 mm   | $\varnothing 34,7$ | 98  |
| 1    | 72741     | 68 mm   | $\varnothing 35$   | 98  |
| 1    | 72745     | -       | $\varnothing 45$   | 151 |



| Type | Auger No. | A       | $\varnothing B$    | C    |
|------|-----------|---------|--------------------|------|
| 2    | 72720     | 12 mm   | $\varnothing 25$   | 81   |
| 2    | 72739     | -       | $\varnothing 34,8$ | 85   |
| 2    | 72732     | 13,5 mm | $\varnothing 34,8$ | 98,5 |
| 2    | 72733     | 25 mm   | $\varnothing 35$   | 110  |
| 2    | 72734     | 15,5 mm | $\varnothing 37,7$ | 71   |
| 2    | 72728     | 20,5 mm | $\varnothing 37,7$ | 76   |
| 2    | 72729     | 23 mm   | $\varnothing 38$   | 118  |
| 2    | 72735     | 23 mm   | $\varnothing 38$   | 129  |

**Pins**

| Type | Auger No. | A       | ØB  | C     |
|------|-----------|---------|-----|-------|
| 3    | 60373     | 22,5 mm | Ø32 | 80    |
| 3    | 72704     | 16 mm   | Ø34 | 80    |
| 3    | 72706     | 15 mm   | Ø34 | 120   |
| 3    | 72723     | 20,5 mm | Ø35 | 60    |
| 3    | 72711     | 20,5 mm | Ø35 | 66,5  |
| 3    | 72724     | 20,5 mm | Ø35 | 102   |
| 3    | 72712     | 20,5 mm | Ø35 | 128,5 |

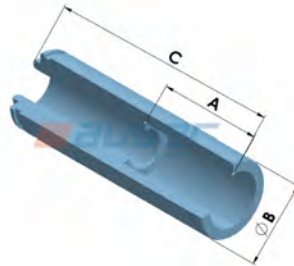

| Type | Auger No. | A       | ØB    | C    |
|------|-----------|---------|-------|------|
| 4    | 72717     | 18,5 mm | Ø29,7 | 71,5 |
| 4    | 72730     | 27,5 mm | Ø29,7 | 77   |
| 4    | 72731     | 21 mm   | Ø30   | 91   |
| 4    | 72718     | 16 mm   | Ø30   | 99   |
| 4    | 72762     | -       | Ø32   | 84   |
| 4    | 72756     | 26 mm   | Ø35,7 | 81   |
| 4    | 72719     | 17 mm   | Ø36   | 64   |
| 4    | 72708     | 38 mm   | Ø36   | 102  |
| 4    | 72764     | 39,5 mm | Ø36   | 103  |
| 4    | 72757     | 38 mm   | Ø36   | 105  |
| 4    | 60372     | 50mm    | Ø36   | 114  |
| 4    | 72707     | 16 mm   | Ø36   | 134  |
| 4    | 72705     | 18 mm   | Ø36   | 145  |
| 4    | 72763     | 26 mm   | Ø36,3 | 70   |



### Pins



| Type | Auger No. | A | ØB  | C   |
|------|-----------|---|-----|-----|
| 5    | 73176     | - | Ø37 | 123 |

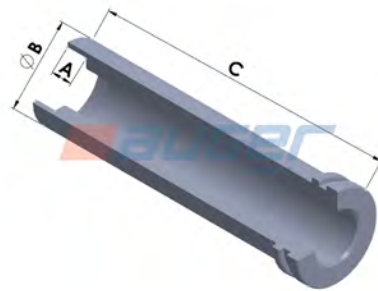

| Type | Auger No. | A     | ØB  | C   |
|------|-----------|-------|-----|-----|
| 6    | 72713     | 20 mm | Ø31 | 84  |
| 6    | 72699     | 7 mm  | Ø35 | 72  |
| 6    | 72700     | 9 mm  | Ø35 | 135 |
| 6    | 72714     | 21 mm | Ø35 | 144 |

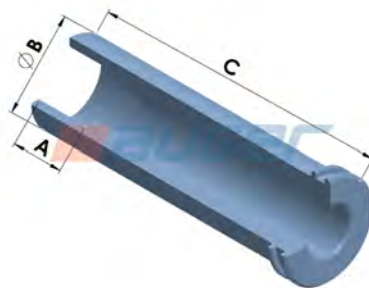

| Type | Auger No. | A     | ØB  | C   |
|------|-----------|-------|-----|-----|
| 7    | 72701     | 20 mm | Ø31 | 78  |
| 7    | 72702     | 21 mm | Ø35 | 117 |

### Pins

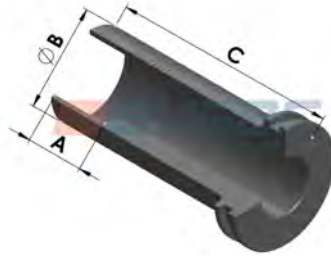

| Type | Auger No. | A     | ØB  | C   |
|------|-----------|-------|-----|-----|
| 8    | 72709     | 20 mm | Ø31 | 78  |
| 8    | 72737     | 21 mm | Ø32 | 117 |
| 8    | 72710     | 21 mm | Ø35 | 117 |

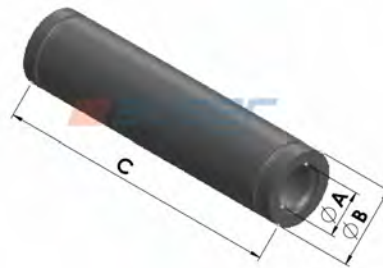

| Type | Auger No. | ØA    | ØB  | C  |
|------|-----------|-------|-----|----|
| 9    | 72767     | Ø8,5  | Ø18 | 77 |
| 9    | 72766     | Ø12,3 | Ø22 | 90 |



| Type | Auger No. | ØA  | ØB  | C  |
|------|-----------|-----|-----|----|
| 10   | 72754     | Ø15 | Ø35 | 64 |
| 10   | 72753     | Ø15 | Ø35 | 69 |
| 10   | 72752     | Ø15 | Ø35 | 70 |

### Pins

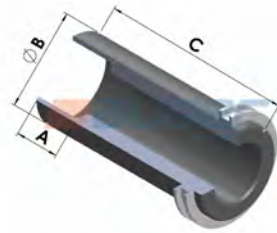

| Type | Auger No. | A       | ØB  | C    |
|------|-----------|---------|-----|------|
| 11   | 73115     | -       | Ø30 | 75   |
| 11   | 73116     | -       | Ø30 | 115  |
| 11   | 73113     | 18 mm   | Ø35 | 78,5 |
| 11   | 73114     | 20,5 mm | Ø35 | 131  |



| Type | Auger No. | A | ØB  | C  |
|------|-----------|---|-----|----|
| 12   | 73117     | - | Ø20 | 71 |
| 12   | 73118     | - | Ø20 | 80 |

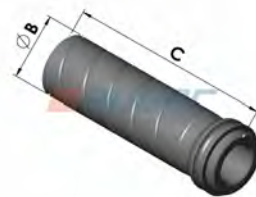

| Type | Auger No. | A | ØB  | C  |
|------|-----------|---|-----|----|
| 13   | 72725     | - | Ø20 | 71 |



| Type | Auger No. | A       | ØB    | C   |
|------|-----------|---------|-------|-----|
| 14   | 72722     | M20x1,5 | Ø28,2 | 110 |

Bushings

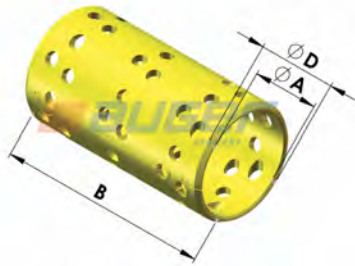

| Type | Auger No. | ØA  | ØD  | B    |
|------|-----------|-----|-----|------|
| 1    | 73003     | ø30 | ø34 | 64,5 |

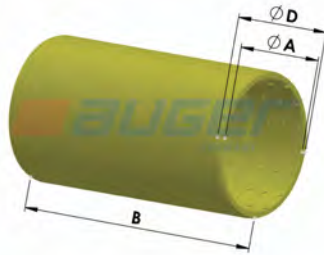

| Type | Auger No. | ØA  | ØD  | B    |
|------|-----------|-----|-----|------|
| 2    | 72999     | ø36 | ø40 | 70,5 |
| 2    | 60533     | ø36 | ø40 | 82   |
| 2    | 73023     | ø37 | ø41 | 73   |
| 2    | 73024     | ø37 | ø41 | 30   |



| Type | Auger No. | ØA  | ØD  | B  |
|------|-----------|-----|-----|----|
| 3    | 73000     | ø36 | ø40 | 70 |
| 3    | 73001     | ø36 | ø40 | 75 |

### Bushings

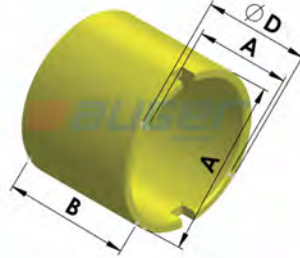

| Type | Auger No. | A     | ØD  | B    |
|------|-----------|-------|-----|------|
| 4    | 72994     | 35/37 | ø40 | 32,5 |
| 4    | 73006     | 35/36 | ø39 | 30   |
| 4    | 73007     | 30/31 | ø34 | 26   |
| 4    | 73008     | 32/33 | ø36 | 30   |
| 4    | 72997     | 35/36 | ø39 | 42,5 |

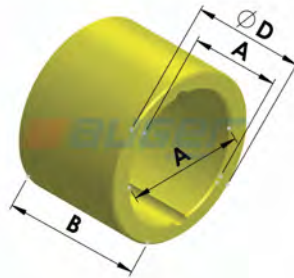

| Type | Auger No. | A     | ØD  | B  |
|------|-----------|-------|-----|----|
| 5    | 72996     | 30/31 | ø42 | 30 |

**Bushings**

| Type | Auger No. | ØA  | ØD  | B  |
|------|-----------|-----|-----|----|
| 6    | 72993     | ø32 | ø36 | 55 |
| 6    | 73016     | ø35 | ø39 | 50 |
| 6    | 73019     | ø12 | ø14 | 10 |
| 6    | 73022     | ø14 | ø16 | 15 |
| 6    | 72998     | ø16 | ø18 | 10 |
| 6    | 73018     | ø28 | ø32 | 25 |
| 6    | 73011     | ø35 | ø39 | 20 |
| 6    | 73010     | ø38 | ø42 | 30 |
| 6    | 73017     | ø45 | ø50 | 40 |
| 6    | 73025     | ø50 | ø55 | 20 |
| 6    | 73005     | ø25 | ø28 | 15 |
| 6    | 73020     | ø36 | ø40 | 30 |



| Type | Auger No. | ØA    | ØD    | B  |
|------|-----------|-------|-------|----|
| 7    | 73015     | ø40,5 | ø44,5 | 15 |
| 7    | 55292     | ø30   | ø34   | 20 |
| 7    | 73009     | ø32   | ø36   | 40 |
| 7    | 73013     | ø32   | ø36   | 30 |
| 7    | 73014     | ø32   | ø36   | 20 |
| 7    | 72995     | ø35   | ø39   | 30 |

### Bushings

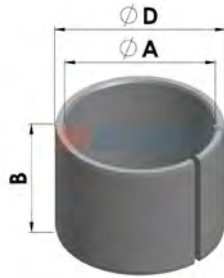

| Type | Auger No. | ØA  | ØD  | B  |
|------|-----------|-----|-----|----|
| 8    | 73012     | ø35 | ø39 | 20 |
| 8    | 69738     | ø30 | ø34 | 25 |

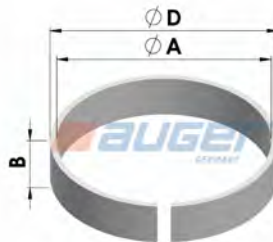

| Type | Auger No. | ØA  | ØD  | B   |
|------|-----------|-----|-----|-----|
| 9    | 73002     | ø32 | ø34 | 6,5 |

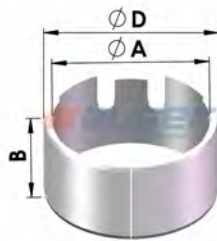

| Type | Auger No. | ØA  | ØD  | B  |
|------|-----------|-----|-----|----|
| 10   | 73004     | ø36 | ø40 | 20 |



| Type | Auger No. | ØA | ØD | B     |
|------|-----------|----|----|-------|
| 11   | 73021     | -  | -  | 53,75 |

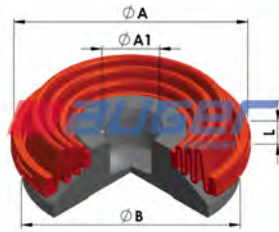

**Seal Boot**

| Type | Auger No. | ØA    | ØA1 | L | ØB  |
|------|-----------|-------|-----|---|-----|
| 1    | 55347     | ø74,5 | ø18 | 7 | ø68 |

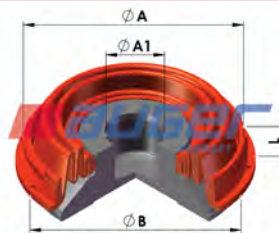

| Type | Auger No. | ØA    | ØA1 | L   | ØB  |
|------|-----------|-------|-----|-----|-----|
| 2    | 55348     | ø69,3 | ø18 | 8,5 | ø65 |

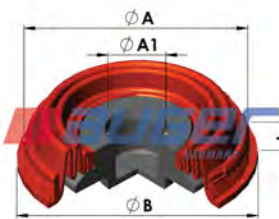

| Type | Auger No. | ØA    | ØA1 | L   | ØB  |
|------|-----------|-------|-----|-----|-----|
| 3    | 55349     | ø69,3 | ø18 | 8,5 | ø52 |

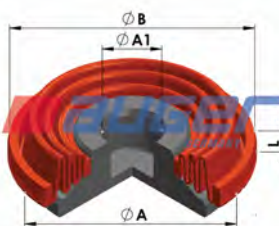

| Type | Auger No. | ØA    | ØA1 | L | ØB    |
|------|-----------|-------|-----|---|-------|
| 4    | 57646     | ø74,3 | ø18 | 7 | ø62,3 |

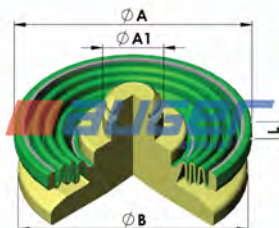

| Type | Auger No. | ØA    | ØA1 | L | ØB  |
|------|-----------|-------|-----|---|-----|
| 5    | 55350     | ø70,5 | ø18 | 6 | ø68 |

### Machined washer

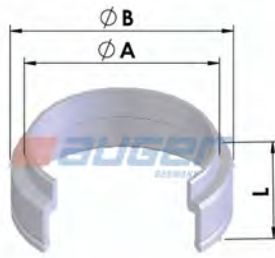

| Type | Auger No. | ØA  | ØB  | L    |
|------|-----------|-----|-----|------|
| 1    | 72805     | ø39 | ø40 | 15   |
| 1    | 72806     | ø35 | ø40 | 14.5 |
| 1    | 72833     | ø39 | ø40 | 13.5 |

### Rubber Seals



| Type | Auger No. | ØA / ØA1    | ØB    | L    |
|------|-----------|-------------|-------|------|
| 1    | 73199     | ø14,5/ø21,5 | ø30   | 21,5 |
| 1    | 73200     | ø10,5/ø17,5 | ø26   | 21   |
| 1    | 55336     | ø29/ø46,5   | ø51,5 | 37   |
| 1    | 55339     | ø20/ø34     | ø45   | 33   |
| 1    | 73194     | ø26,5/ø32   | ø51,5 | 36,5 |

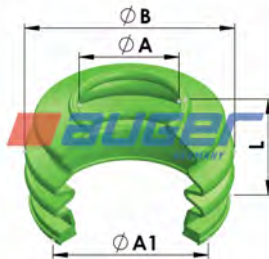

| Type | Auger No. | ØA / ØA1    | ØB  | L  |
|------|-----------|-------------|-----|----|
| 2    | 55332     | ø16/ø26     | ø37 | 25 |
| 2    | 55335     | ø23,5/ø29,5 | ø42 | 25 |
| 2    | 55338     | ø23/ø34     | ø48 | 29 |
| 2    | 57653     | ø30/ø35,5   | ø48 | 31 |

**Rubber Seals**

| Type | Auger No. | ØA / ØA1  | ØB    | L    |
|------|-----------|-----------|-------|------|
| 3    | 55331     | ø30/ø35,5 | ø51,5 | 36,5 |
| 3    | 55333     | ø24/ø29,5 | ø40   | 41   |
| 3    | 57652     | ø31/ø38   | ø52   | 33   |
| 3    | 73196     | ø31/ø36,5 | ø48,5 | 33   |

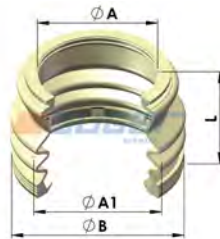

| Type | Auger No. | ØA / ØA1  | ØB    | L    |
|------|-----------|-----------|-------|------|
| 4    | 55334     | ø35/ø37,5 | ø50,5 | 33,5 |



| Type | Auger No. | ØA / ØA1  | ØB  | L  |
|------|-----------|-----------|-----|----|
| 5    | 55341     | ø12,5/ø16 | ø22 | 22 |



| Type | Auger No. | ØA  | ØB  | L  |
|------|-----------|-----|-----|----|
| 6    | 55378     | ø46 | ø50 | 40 |

### Rubber Seals



| Type | Auger No. | $\varnothing A$  | $\varnothing B$    | L  |
|------|-----------|------------------|--------------------|----|
| 7    | 55343     | $\varnothing 29$ | $\varnothing 40,5$ | 27 |

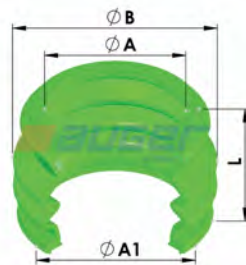

| Type | Auger No. | $\varnothing A / \varnothing A1$    | $\varnothing B$    | L  |
|------|-----------|-------------------------------------|--------------------|----|
| 8    | 55337     | $\varnothing 35 / \varnothing 37,5$ | $\varnothing 51,5$ | 33 |

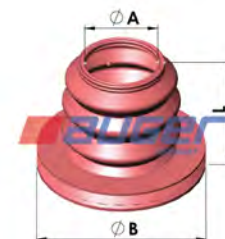

| Type | Auger No. | $\varnothing A$  | $\varnothing B$  | L  |
|------|-----------|------------------|------------------|----|
| 9    | 57650     | $\varnothing 40$ | $\varnothing 78$ | 53 |
| 9    | 57651     | $\varnothing 36$ | $\varnothing 67$ | 48 |



| Type | Auger No. | $\varnothing A / \varnothing A1$    | $\varnothing B$                     | L    |
|------|-----------|-------------------------------------|-------------------------------------|------|
| 10   | 55340     | $\varnothing 38 / \varnothing 64,5$ | $\varnothing 68 / \varnothing 72,5$ | 30,5 |

**Rubber Seals**



| Type | Auger No. | ØA / ØA1    | ØB    | L  |
|------|-----------|-------------|-------|----|
| 11   | 55342     | ø17,5/ø19,7 | ø33,5 | 31 |



| Type | Auger No. | ØA / ØA1     | ØB  | L    |
|------|-----------|--------------|-----|------|
| 12   | 55344     | ø33,5/ ø34,5 | ø40 | 48,5 |

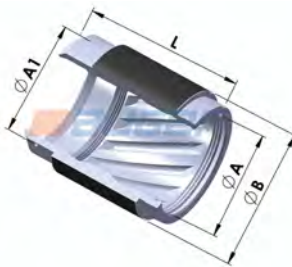

| Type | Auger No. | ØA    | ØB  | L  |
|------|-----------|-------|-----|----|
| 13   | 55377     | ø34,5 | ø40 | 96 |



| Type | Auger No. | ØA / ØA1 | ØB  | L    |
|------|-----------|----------|-----|------|
| 14   | 55345     | ø31/ø32  | ø40 | 46   |
| 14   | 73195     | ø31/ø32  | ø40 | 43,5 |

## Rubber Seals



| Type | Auger No. | ØA / ØA1 | ØB  | L    |
|------|-----------|----------|-----|------|
| 15   | 55376     | ø25/ø32  | ø40 | 61,5 |



| Type | Auger No. | ØA / ØA1    | ØB  | L    |
|------|-----------|-------------|-----|------|
| 16   | 55359     | ø47/ø57,5   | ø75 | 15   |
| 16   | 55360     | ø57/ø67,5   | ø85 | 15   |
| 16   | 55362     | ø49/ø60,2   | ø74 | 13   |
| 16   | 57636     | ø41/ø52     | ø63 | 14   |
| 16   | 57638     | ø49/ø59     | ø71 | 14   |
| 16   | 57639     | ø34,5/ø44,5 | ø56 | 13,5 |
| 16   | 57649     | ø50/ø63,5   | ø76 | 13,5 |

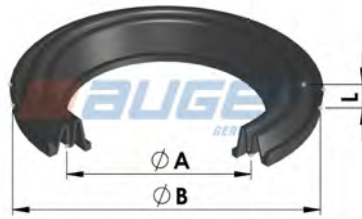

| Type | Auger No. | ØA    | ØB  | L   |
|------|-----------|-------|-----|-----|
| 17   | 55363     | ø32,5 | ø59 | 7,5 |

**Rubber Seals**

| Type | Auger No. | ØA  | ØB  | L   |
|------|-----------|-----|-----|-----|
| 18   | 57635     | ø35 | ø58 | 7   |
| 18   | 57637     | ø40 | ø63 | 8,5 |

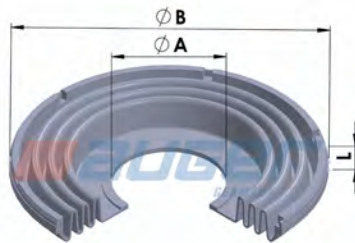

| Type | Auger No. | ØA    | ØB  | L   |
|------|-----------|-------|-----|-----|
| 19   | 55352     | ø30,5 | ø85 | 9,5 |

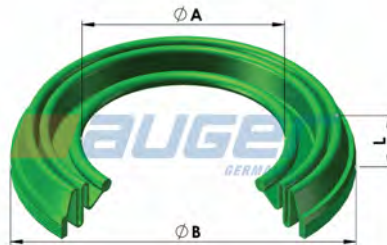

| Type | Auger No. | ØA    | ØB    | L    |
|------|-----------|-------|-------|------|
| 20   | 55353     | ø46,5 | ø82   | 16,5 |
| 20   | 55355     | ø56   | ø95,5 | 14,5 |



| Type | Auger No. | ØA  | ØB  | L   |
|------|-----------|-----|-----|-----|
| 21   | 55357     | ø68 | ø98 | 9,5 |



### Rubber Seals

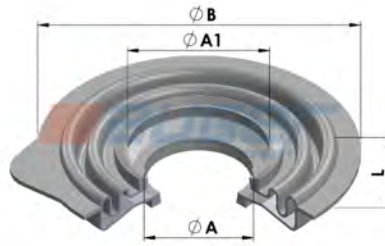

| Type | Auger No. | ØA / ØA1 | ØB  | L  |
|------|-----------|----------|-----|----|
| 22   | 55351     | ø32/ø43  | ø84 | 14 |

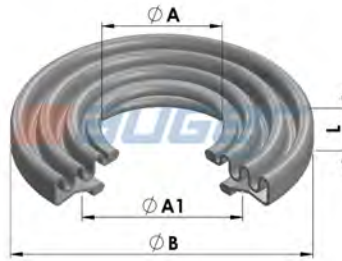

| Type | Auger No. | ØA / ØA1  | ØB  | L  |
|------|-----------|-----------|-----|----|
| 23   | 57643     | ø33,5/ø45 | ø84 | 13 |

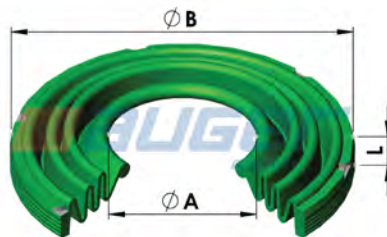

| Type | Auger No. | ØA  | ØB    | L  |
|------|-----------|-----|-------|----|
| 24   | 55354     | ø31 | ø72,5 | 11 |

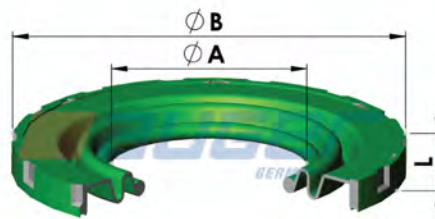

| Type | Auger No. | ØA    | ØB  | L   |
|------|-----------|-------|-----|-----|
| 25   | 57640     | ø34   | ø75 | 7.5 |
| 25   | 55358     | ø41,5 | ø84 | 7   |

### Rubber Seals

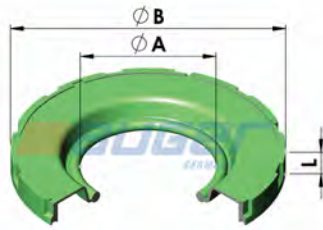

| Type | Auger No. | ØA    | ØB  | L   |
|------|-----------|-------|-----|-----|
| 26   | 55356     | ø34,5 | ø70 | 7,5 |



| Type | Auger No. | ØA / ØA1 | ØB    | L   |
|------|-----------|----------|-------|-----|
| 27   | 55361     | ø19/ø20  | ø32,5 | 6,5 |



| Type | Auger No. | ØA  | ØB  | L  |
|------|-----------|-----|-----|----|
| 28   | 73201     | ø26 | ø55 | 17 |

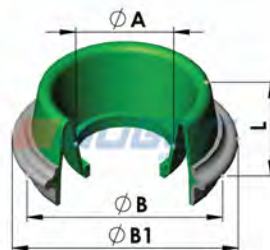

| Type | Auger No. | ØA    | ØB/ØB1    | L    |
|------|-----------|-------|-----------|------|
| 29   | 55375     | ø21   | ø42/ø48,5 | 20,5 |
| 29   | 57642     | ø18,5 | ø37,5/ø44 | 19   |

### Rubber Seals

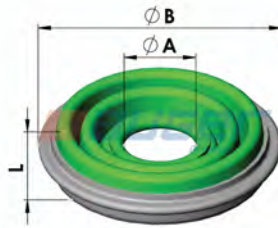

| Type | Auger No. | $\varnothing A$  | $\varnothing B$    | L    |
|------|-----------|------------------|--------------------|------|
| 30   | 57641     | $\varnothing 25$ | $\varnothing 55,5$ | 17,5 |
| 30   | 57648     | $\varnothing 17$ | $\varnothing 59,5$ | 19   |

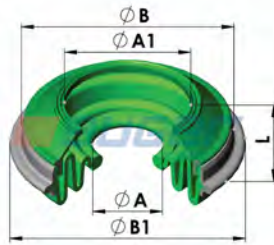

| Type | Auger No. | $\varnothing A / \varnothing A1$    | $\varnothing B / \varnothing B1$    | L     |
|------|-----------|-------------------------------------|-------------------------------------|-------|
| 31   | 55374     | $\varnothing 19 / \varnothing 34,5$ | $\varnothing 58 / \varnothing 64,5$ | 21,75 |

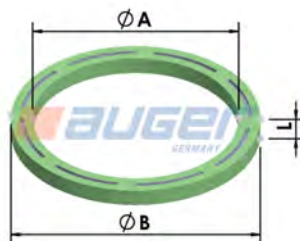

| Type | Auger No. | $\varnothing A / \varnothing A1$ | $\varnothing B$    | L |
|------|-----------|----------------------------------|--------------------|---|
| 32   | 57645     | $\varnothing 23,5$               | $\varnothing 28,5$ | 2 |



| Type | Auger No. | $\varnothing A$  | $\varnothing B$  | L1/L |
|------|-----------|------------------|------------------|------|
| 33   | 60343     | $\varnothing 28$ | $\varnothing 63$ | 5/14 |

**Rubber Seals**

| Type | Auger No. | SW | ØB  | L |
|------|-----------|----|-----|---|
| 34   | 57644     | 27 | ø52 | 5 |



| Type | Auger No. | ØA / ØA1 | ØB  | L  |
|------|-----------|----------|-----|----|
| 35   | 55383     | ø21/ø35  | ø40 | 18 |



| Type | Auger No. | ØA / ØA1 | ØB/ØB1  | L    |
|------|-----------|----------|---------|------|
| 36   | 55370     | ø33/ø35  | ø62/ø69 | 15.5 |
| 36   | 55371     | ø33/ø35  | ø64/ø73 | 15.5 |



| Type | Auger No. | ØA  | ØB/ØB1  | L    |
|------|-----------|-----|---------|------|
| 37   | 55373     | ø35 | ø62/ø70 | 14   |
| 37   | 55372     | ø35 | ø64/ø73 | 14.5 |

### Rubber Seals

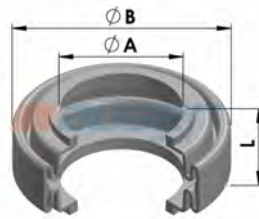

| Type | Auger No. | ØA / ØA1 | ØB    | L  |
|------|-----------|----------|-------|----|
| 38   | 55369     | ø29      | ø51,5 | 24 |
| 38   | 55365     | ø29      | ø51,5 | 22 |



| Type | Auger No. | ØA  | ØB    | L  |
|------|-----------|-----|-------|----|
| 39   | 55364     | ø30 | ø51,5 | 22 |
| 39   | 55366     | ø27 | ø48   | 20 |

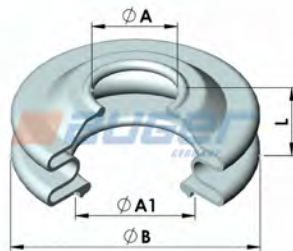

| Type | Auger No. | ØA / ØA1 | ØB  | L  |
|------|-----------|----------|-----|----|
| 40   | 55367     | 22/ø32,5 | ø65 | 26 |

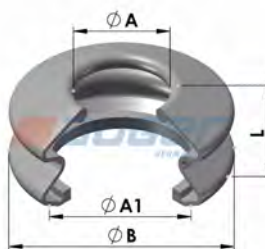

| Type | Auger No. | ØA / ØA1 | ØB  | L    |
|------|-----------|----------|-----|------|
| 41   | 55368     | ø24/ø35  | ø56 | 25,5 |

### Rubber Seals



| Type | Auger No. | ØA  | ØB    | L  |
|------|-----------|-----|-------|----|
| 42   | 55380     | ø47 | ø53,5 | 46 |



| Type | Auger No. | ØA    | ØB    | L  |
|------|-----------|-------|-------|----|
| 43   | 55379     | ø37,5 | ø53,5 | 37 |
| 43   | 55381     | ø46,5 | ø50,5 | 26 |



| Type | Auger No. | ØA  | ØB  | L    |
|------|-----------|-----|-----|------|
| 44   | 73184     | ø28 | ø38 | 25   |
| 44   | 73186     | ø25 | ø35 | 27,5 |



| Type | Auger No. | ØA / ØA1 | ØB    | L    |
|------|-----------|----------|-------|------|
| 45   | 55382     | ø8/ø11,7 | ø19,5 | 13.5 |

### Rubber Seals



| Type | Auger No. | ØA  | ØB  | L  |
|------|-----------|-----|-----|----|
| 46   | 57647     | ø23 | ø95 | 92 |



| Type | Auger No. | ØA | ØB  | L1/L |
|------|-----------|----|-----|------|
| 47   | 73185     | -  | ø63 | 5/12 |



| Type | Auger No. | ØA  | ØB | L  |
|------|-----------|-----|----|----|
| 48   | 55346     | ø42 | -  | 14 |



| Type | Auger No. | ØA / ØA1 | ØB | L |
|------|-----------|----------|----|---|
| 49   | 60566     | ø28      | -  | - |

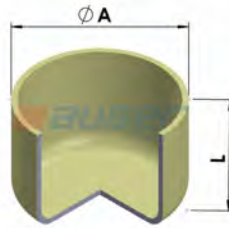

**Covers**

| Type | Auger No. | $\varnothing A$     | $\varnothing A1$ | L    |
|------|-----------|---------------------|------------------|------|
| 1    | 72873     | $\varnothing 34,2$  | -                | 13,3 |
| 1    | 72883     | $\varnothing 36$    | -                | 10   |
| 1    | 72872     | $\varnothing 37$    | -                | 10,5 |
| 1    | 72897     | $\varnothing 37$    | -                | 16   |
| 1    | 72898     | $\varnothing 37,3$  | -                | 24   |
| 1    | 72875     | $\varnothing 39,5$  | -                | 17,5 |
| 1    | 72869     | $\varnothing 40$    | -                | 10,5 |
| 1    | 60485     | $\varnothing 40$    | -                | 14,5 |
| 1    | 72874     | $\varnothing 40$    | -                | 25   |
| 1    | 72860     | $\varnothing 41,75$ | -                | 27,5 |
| 1    | 60507     | $\varnothing 42$    | -                | 23   |
| 1    | 72876     | $\varnothing 42$    | -                | 44   |
| 1    | 72862     | $\varnothing 44$    | -                | 17,5 |
| 1    | 72870     | $\varnothing 44$    | -                | 27   |
| 1    | 72865     | $\varnothing 45$    | -                | 12   |



| Type | Auger No. | $\varnothing A$    | $\varnothing A1$ | L  |
|------|-----------|--------------------|------------------|----|
| 2    | 72937     | $\varnothing 41,5$ | -                | 36 |



| Type | Auger No. | $\varnothing A$ | $\varnothing A1$ | L  |
|------|-----------|-----------------|------------------|----|
| 3    | 60480     | -               | $\varnothing 52$ | 28 |

### Covers

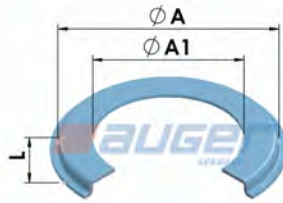

| Type | Auger No. | ØA    | ØA1   | L    |
|------|-----------|-------|-------|------|
| 4    | 60481     | ø26,1 | ø18   | 11   |
| 4    | 72868     | ø47,5 | ø32,5 | 3,5  |
| 4    | 72885     | ø51,5 | ø42,5 | 11,5 |

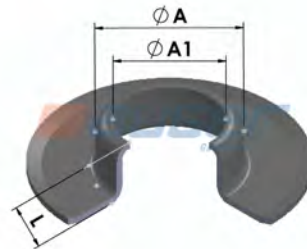

| Type | Auger No. | ØA  | ØA1 | L    |
|------|-----------|-----|-----|------|
| 5    | 72911     | ø28 | ø21 | 12,5 |

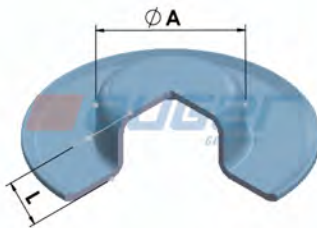

| Type | Auger No. | ØA  | ØA1 | L    |
|------|-----------|-----|-----|------|
| 6    | 72912     | ø28 | -   | 12,5 |

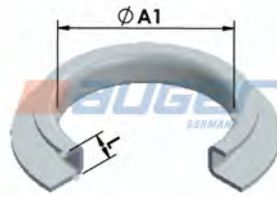

| Type | Auger No. | ØA    | ØA1   | L  |
|------|-----------|-------|-------|----|
| 7    | 72909     | ø76,5 | ø54,5 | 11 |

**Covers**

| Type | Auger No. | ØA | ØA1   | L |
|------|-----------|----|-------|---|
| 8    | 72866     | -  | ø23,5 | 5 |
| 8    | 72867     | -  | ø38   | 5 |

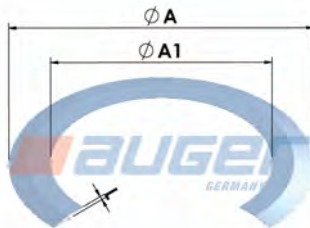

| Type | Auger No. | ØA  | ØA1 | L    |
|------|-----------|-----|-----|------|
| 9    | 72901     | ø62 | ø45 | 2,25 |



| Type | Auger No. | ØA  | ØA1 | L    |
|------|-----------|-----|-----|------|
| 10   | 72861     | ø44 | -   | 27.5 |
| 10   | 60506     | ø57 | -   | 40   |

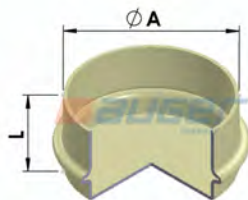

| Type | Auger No. | ØA    | ØA1 | L    |
|------|-----------|-------|-----|------|
| 11   | 72888     | ø34,2 | -   | 16,5 |
| 11   | 72917     | ø40   | -   | 15   |
| 11   | 72884     | ø42   | -   | 17   |
| 11   | 72886     | ø42   | -   | 29   |

### Covers

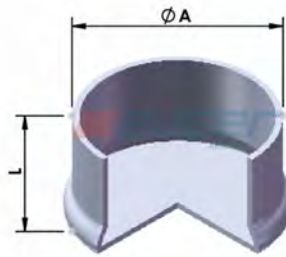

| Type | Auger No. | $\varnothing A$  | $\varnothing A1$ | L    |
|------|-----------|------------------|------------------|------|
| 12   | 72879     | $\varnothing 22$ | -                | 7    |
| 12   | 72878     | $\varnothing 22$ | -                | 12,5 |
| 12   | 72880     | $\varnothing 24$ | -                | 12,8 |
| 12   | 72877     | $\varnothing 28$ | -                | 16   |
| 12   | 72889     | $\varnothing 39$ | -                | 16,5 |

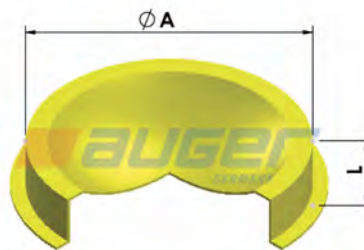

| Type | Auger No. | $\varnothing A$    | $\varnothing A1$ | L    |
|------|-----------|--------------------|------------------|------|
| 13   | 72936     | $\varnothing 45,3$ | -                | 6,75 |
| 13   | 72935     | $\varnothing 45,3$ | -                | 8,5  |

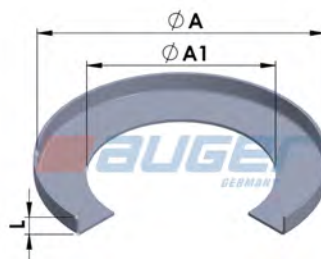

| Type | Auger No. | $\varnothing A$  | $\varnothing A1$ | L   |
|------|-----------|------------------|------------------|-----|
| 14   | 72881     | $\varnothing 60$ | $\varnothing 42$ | 6   |
| 14   | 72895     | $\varnothing 64$ | $\varnothing 42$ | 5   |
| 14   | 72887     | $\varnothing 73$ | $\varnothing 52$ | 5,9 |

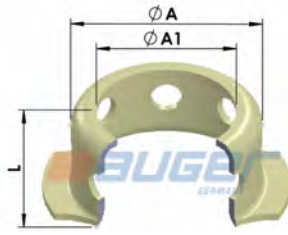
**Covers**

| Type | Auger No. | ØA  | ØA1   | L  |
|------|-----------|-----|-------|----|
| 15   | 72900     | ø34 | ø26,6 | 19 |
| 15   | 72899     | ø34 | ø26,6 | 24 |



| Type | Auger No. | ØA    | ØA1   | L    |
|------|-----------|-------|-------|------|
| 16   | 72913     | ø39   | ø35,8 | 4    |
| 16   | 72863     | ø39   | ø37   | 10   |
| 16   | 72882     | ø40   | ø37   | 10,5 |
| 16   | 72896     | ø44   | ø37   | 12,5 |
| 16   | 72921     | ø60,4 | ø58,4 | 5,5  |

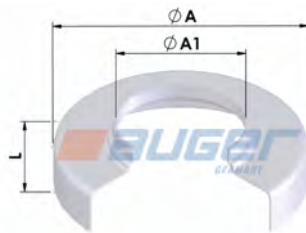

| Type | Auger No. | ØA    | ØA1 | L  |
|------|-----------|-------|-----|----|
| 17   | 72871     | ø59,5 | ø31 | 17 |

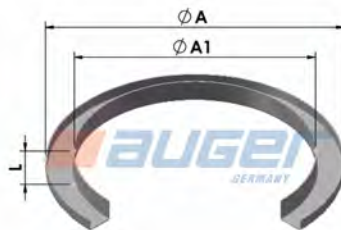

| Type | Auger No. | ØA  | ØA1 | L    |
|------|-----------|-----|-----|------|
| 18   | 72891     | ø57 | ø44 | 4,25 |
| 18   | 72892     | ø57 | ø46 | 4,25 |